

Omega 4K/UHD Two-Input Switcher for HDMI and USB with USB Hub

AT-OME-MH21

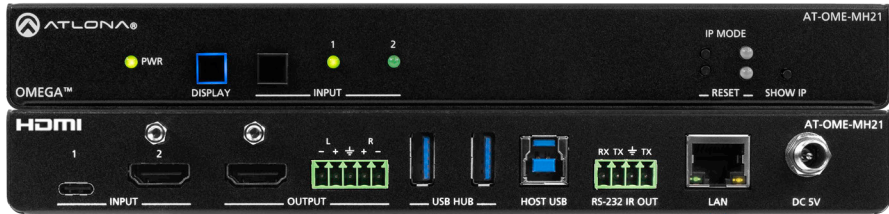

The Atlona **AT-OME-MH21** is a compact, versatile switcher with HDMI and USB-C inputs. It is equipped with features for complete AV integration in huddle rooms and small meeting spaces, including automatic switching and display control, audio de-embedding, and a USB 3.0 hub for video conferencing peripherals or touch displays. Part of the Omega™ Series of integration products for modern AV communications and collaboration, the OME-MH21 is HDCP 2.2 compliant and supports 4K HDR and 4K/60 4:4:4 at HDMI data rates up to 18 Gbps. Additionally, 4K downscaling to 1080p @ 60, 30, or 24 Hz is available when connected to an HD display. The OME-MH21 includes USB 3.0 and USB-C interfaces for two host PCs, plus two peripheral devices such as a camera, microphone, speakerphone, touch-enabled display, or keyboard and mouse.

Package Contents

- 1 x AT-OME-MH21
- 1 x USB-C cable
- 1 x IR emitter cable
- 1 x 5-pin captive screw connector
- 1 x 4-pin captive screw connector
- 2 x Mounting brackets
- 4 x Mounting screws
- 4 x Rubber feet
- 1 x 5V 4A power supply
- 1 x IEC power cord
- 1 x Installation guide



IMPORTANT: Visit <http://www.atlona.com/product/AT-OME-MH21> for the latest firmware updates and documentation.

Panel Descriptions

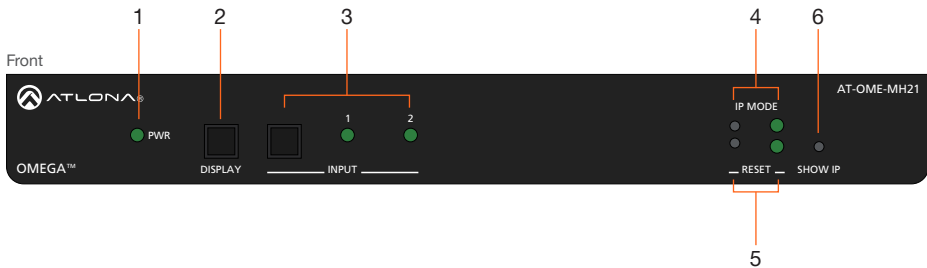

- 1 PWR**
 This LED indicator glows solid green when the unit is powered.
- 2 DISPLAY**
 Press and release this button to toggle power on the connected display.
- 3 INPUT**
 Press and release this button to toggle between the HDMI and USB-C input. A solid green LED indicator will display the currently active input. Each LED indicator corresponds to the input on the rear panel of the unit.
- 4 IP MODE**
 Press and release this button, next to the green LED indicator, to switch the IP mode between DHCP and factory static IP modes. The LED indicator will provide the current IP mode. Refer to [IP Configuration \(page 8\)](#) for more information.
- 5 RESET**
 Press and release this button to reset the unit to factory-default settings. Refer to [Resetting to Factory-Defaults \(page 9\)](#) for more information.
- 6 SHOW IP**
 Press and release this button to display the IP address of the AT-OME-MH21 on the connected display.

Panel Descriptions

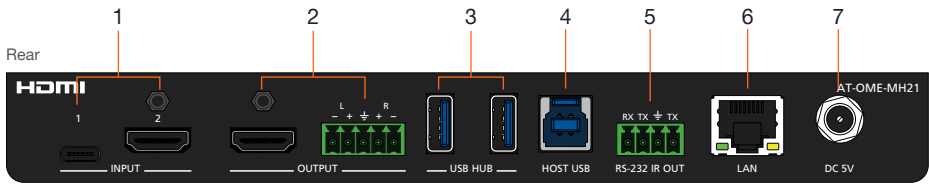

1 INPUT

Connect a USB-C source to the USB-C port. Connect an HDMI cable from the HDMI port to a UHD/HD source.

2 OUTPUT

Connect an HDMI cable from the HDMI output to a display or other sink device. Connect an audio output device to this port using the included 5-pin captive screw block. Refer to [Audio Output Connector \(page 4\)](#) for wiring information.

3 USB HUB

Connect a USB device to each of these ports.

4 HOST USB

Connect to a computer using a USB-B to USB-A cable.

5 RS-232 / IR OUT

Connect the included 4-pin captive screw block to this receptacle. The RS-232 port provides RS-232 control for the AT-OME-MH21 and the connected display. Refer to [RS-232 and IR \(page 5\)](#) for more information.

6 LAN

Connect an Ethernet cable to this port to control the unit and/or to pass Ethernet to a local device.

7 DC 5V

Connect the included locking 5 V DC power supply to this power receptacle.

Audio Output Connector

The AT-OME-MH21 provides two-channel LPCM audio de-embedding of the source device, using a dedicated audio output port.

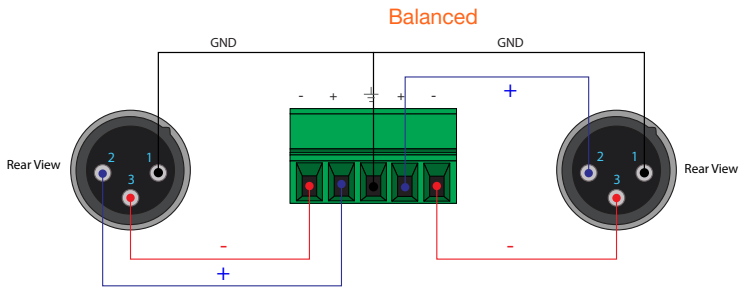
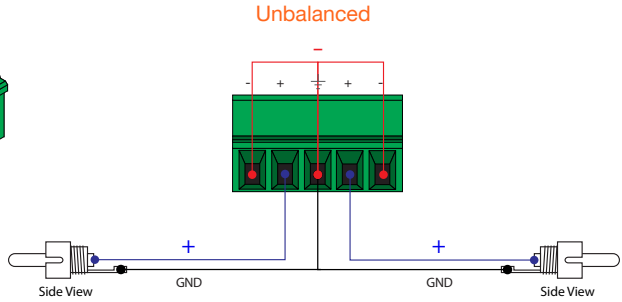
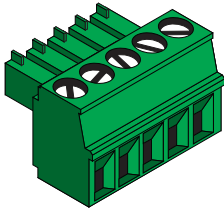

1. Use wire strippers to remove a portion of the cable jacket.
2. Remove at least 3/16" (5 mm) of insulation from each of the wires.
3. Insert the wires into the correct terminals using the included 5-pin captive screw connector.
4. Attach the 5-pin connector block to the **OUTPUT** audio port on the AT-OME-MH21.

RS-232 and IR

The AT-OME-MH21 provides control using RS-232 and/or IR. This step is optional.

1. Use wire strippers to remove a portion of the cable jacket.
2. Remove at least 3/16" (5 mm) from the insulation of the RX, TX, and GND wires for the RS-232 connection.
3. Insert the TX, RX, and GND wires into correct terminal using one of the included 4-pin captive screw connectors.
4. Repeat step 2 for the S and GND wires for the IR connection.
5. Insert the S (signal) wire in to the TX terminal and the ground wire to the GND terminal.
6. Tighten the captive screws to secure the wires in place. Do not over-tighten or use high-torque devices to prevent damage to the connector block.



NOTE: Typical DB9 connectors use pin 2 for TX, pin 3 for RX, and pin 5 for ground. On some devices functions of pins 2 and 3 are reversed. Note that the signal (S) pin for the IR is labeled as "TX" on the port.

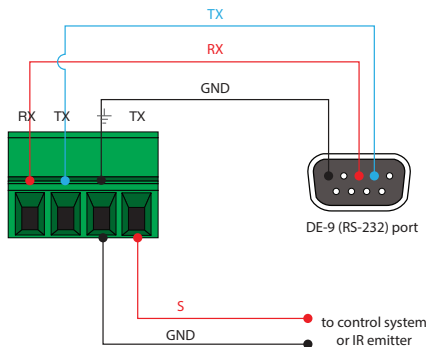
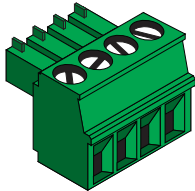

Installation

1. Connect a USB-C device to the **INPUT 1** port.
2. Connect an HDMI cable from the **INPUT 2** port to a UHD/HD source device.
3. Connect an HDMI cable from the HDMI **OUTPUT** port to a display device.
4. OPTIONAL: Connect an audio output device to this port using the included captive screw block. Refer to [Audio Output Connector \(page 4\)](#) for wiring information.
5. Connect up to two USB devices to the **USB HUB** ports.
6. Connect a computer to the **HOST USB** port, using a USB-A to USB-B cable.
7. OPTIONAL: Connect a serial cable from **RS-232** port to a display device. Refer to [RS-232 and IR \(page 5\)](#) for wiring information. Connect an IR emitter to the **IR OUT** port.
8. Connect an Ethernet cable to the **LAN** port to control the AT-OME-MH21.
9. Connect the included 5 V DC power supply from this receptacle to an available AC outlet.

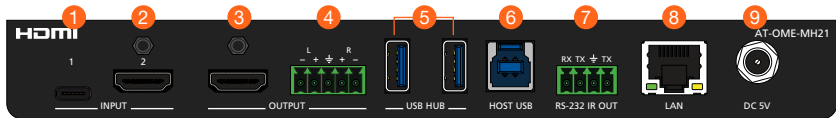

Mounting Instructions

The AT-OME-MH21 includes two mounting brackets, which can be used to attach the unit to any flat surface. Use the two enclosure screws, on the sides of the unit to attach the mounting brackets.



IMPORTANT: When mounting the AT-OME-MH21, ensure the mounting height does not exceed 2 meters (6.56 feet).

1. Using a small Phillips screwdriver, remove the two screws from the left side of the enclosure.
2. Position one of the mounting brackets, as shown below, aligning the holes on the side of the enclosure with one set of holes on the mounting bracket.
3. Use the screws from Step 1 to attach the mounting bracket.

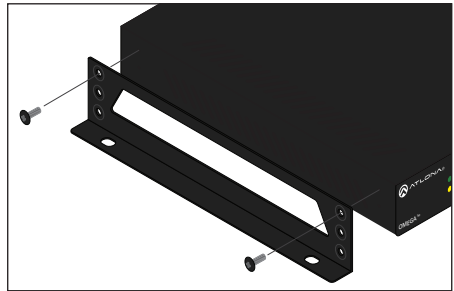
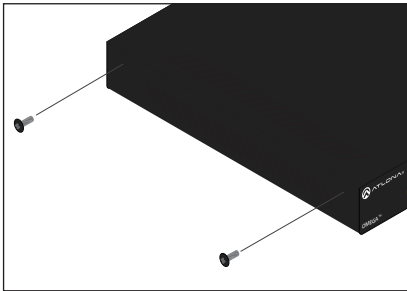

4. Repeat steps 1 and 2 to attach the second mounting bracket to the opposite side of the unit.
5. Mount the unit to a flat surface using the oval-shaped holes, on each mounting bracket. If using a drywall surface, a #6 drywall screw is recommended.



NOTE: Mounting brackets can also be inverted to mount the unit under a table or other flat surface.

IP Configuration

The AT-OME-MH21 is shipped with DHCP enabled. Once connected to a network, the DHCP server (if available), will automatically assign an IP address to the unit. If the AT-OME-MH21 is unable to detect a DHCP server within 15 seconds, then the unit will use a self-assigned IP address within the range of **169.254.xxx.xxx**.

Use an IP scanner, along with the MAC address on the bottom of the unit, to identify the unit on the network. If a static IP address is desired, the unit can be switched to factory static IP mode. The default static IP address is **192.168.1.254**.

Switching the IP mode

1. Make sure the AT-OME-MH21 is powered
2. Press and hold the **IP MODE** button, on the rear of the unit, for approximately five seconds.

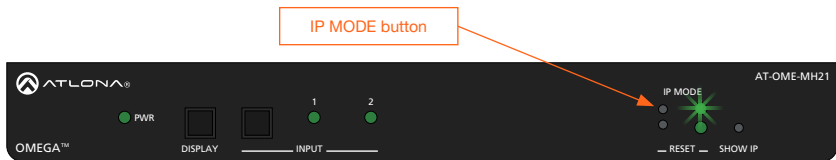

3. Release the button once the LED indicator, next to the **IP MODE** button, begins to flash green. The number of flashes will indicate the currently selected IP mode. If set to static IP mode, then the IP address will be set to 192.168.1.254, by default.

IP MODE LED flashes	Description
Two	DHCP mode
Three	Factory static IP mode

Displaying the IP Address

To display the IP address of the AT-OME-MH21, on the connected display, press and release the **SHOW IP** button on the front panel.

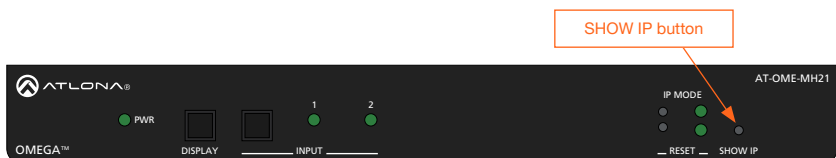

Resetting to Factory-Defaults

To reset the AT-OME-MH21 to factory-default settings, press and hold the **RESET** button for approximately 5 seconds. Release the button when the **RESET** LED indicator begins to flash. The LED indicator will flash three times to indicate that the reset procedure has completed.

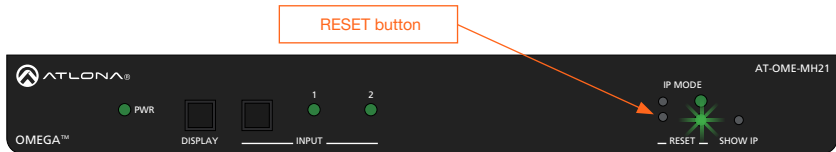

Velocity™ with Integrated AMS

For easy configuration of Atlona devices, Velocity with Integrated AMS is available from <https://atlona.com/AMS> for free. Once AMS has been setup, following the instructions below.

1. Open a browser on the same network as Velocity with Integrated AMS and go to the IP address of Velocity with Integrated AMS. View the Velocity with Integrated AMS installation instructions on how to find the IP of the software, if necessary.
2. Enter the login information on the Velocity with Integrated AMS web page, then click the Login button.
3. View the AT-OME-MH21 manual for routing and configuration information.



Web Server



The AT-OME-MH21 includes a built-in web server, which allows easy management and control of all features. Follow the instructions below to access the web server.



1. Set the IP mode of the AT-OME-MH21. Refer to [IP Configuration \(page 8\)](#) for more information.
2. Connect an Ethernet cable from the **LAN** port on the AT-OME-MH21 to the Local Area Network (LAN).
3. Connect an HDMI cable from the AT-OME-MH21 to a display, then press the **SHOW IP** button on the front panel to display the IP address.
4. Launch a web browser and enter the IP address of the unit.
5. The AT-OME-MH21 Registration page will be displayed.
6. Enter the username, password, and confirm the password on the registration page to register the device. The password must contain a minimum of 8 characters, including 1 uppercase, 1 lowercase, and 1 numeric character.
7. Click on **Register** button.
8. The AT-OME-MH21 Login page will be displayed.
9. Enter the username and password login credentials that were entered during the registration process.
10. Click the **Login** button

Front Panel LED Indicators

The LED indicators on both the front and rear of the unit provide basic information on the current status of the unit.

PWR		Description
Solid green		Unit is receiving power using the optional 24 V DC power supply.
Off		Unit is not powered.

1, 2		Description
Solid green		The input is the currently selected input.
Off		The input is not selected.

IP MODE		Description
Flashes green (2x)		Flashes two times to indicate that the unit is being set to DHCP mode. Refer to IP Configuration (page 8) for more information.
Flashes green (3x)		Flashes three times to indicate that the unit is being set to factory static IP mode. The IP address will be set to 192.168.1.254, by default. Refer to IP Configuration (page 8) for more information.
Off		Normal operating mode.

Notes

Warranty

To view the product warranty, use the following link or QR code:

<https://atlona.com/warranty/>.



English Declaration of Conformity

The English version can be found under the resources tab at:

<https://atlona.com/product/at-ome-mh21/>.



Chinese Declaration of Conformity 中国RoHS合格声明

由SKU列出於:

<https://atlona.com/about-us/china-rohs/>.



The terms HDMI, HDMI High-Definition Multimedia Interface, and the HDMI Logo are trademarks or registered trademarks of HDMI licensing Administrator, Inc.