

Omega™ 4K/UHD Wallplate Transmitter for USB-C with HDBaseT Output and USB

AT-OME-EX-TX-WPC



The Atlona **AT-OME-EX-TX-WPC** is an HDBaseT transmitter with USB-C input. It sends video up to 4K/60 4:2:0, plus embedded audio, control, and USB over distances up to 330 feet (100 meters). It features a US one-gang, Decora-style wallplate form factor, and includes interchangeable black and white wallplates and faceplates. Part of the Omega™ Series of integration products for modern AV communications and collaboration, the OME-EX-TX-WPC is HDCP 2.2 compliant and extends RS-232 control signals. The USB-C input is ideal for AV interfacing with newer Mac®, Chromebook™, and Windows® PCs, as well as smartphones and tablets. With a matching HDBaseT receiver, the integrated USB extension addresses the challenge of connecting between USB devices at remote locations, and is ideal for software video conferencing and touch or interactive displays. The OME-EX-TX-WPC includes a PC host interface over USB-C, plus a USB 2.0 interface for a peripheral device such as a speakerphone, microphone, or keyboard and mouse*. This transmitter is ideal for use with Omega Series receivers as well as switchers with HDBaseT inputs.

Package Contents

1 x AT-OME-EX-TX-WPC	1 x Black Decora® wallplate
1 x White faceplate	4 x Mounting screws
1 x White Decora® wallplate	1 x USB-C to USB-C cable, 2 meters
1 x Black faceplate	1 x Installation Guide



IMPORTANT: Visit <http://www.atlona.com/product/AT-OME-EX-TX-WPC> for the latest firmware updates and User Manual.

* The AT-OME-EX-TX-WPC is not compatible with the AT-UHD-HDVS-300 system for extending USB.

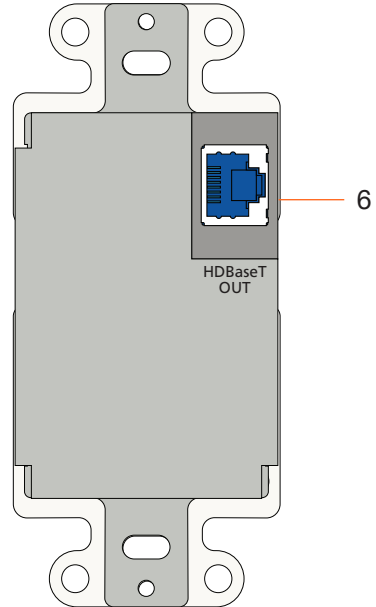
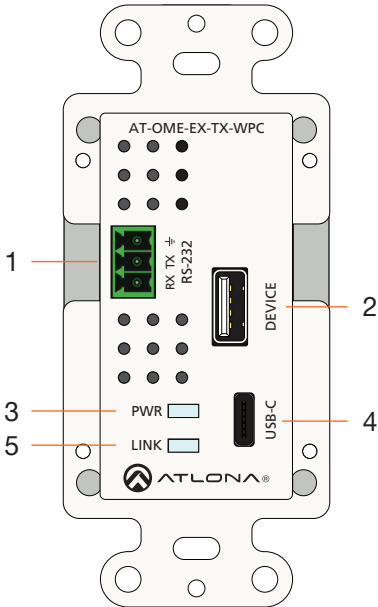

- 1 RS-232**
 Connect an RS-232 control system to this port. Connect the included 3-pin captive screw block to this receptacle. Refer to [RS-232 \(page 3\)](#) for more information. Note that this port is covered by a plate and must be removed to expose the RS-232 port.
- 2 DEVICE**
 Connect a USB device, such as a speakerphone, to this port. This port provides 5 W of power.
- 3 PWR**
 This LED indicator glows solid green when the unit is powered. Refer to [LED Indicators \(page 6\)](#) for more information.
- 4 USB-C**
 Connect a USB-C cable from this port to a UHD/HD source.
- 5 LINK**
 This LED indicator glows solid amber to indicate that the HDBaseT signal integrity is good. Refer to [LED Indicators \(page 6\)](#) for more information.
- 6 HDBaseT OUT**
 Connect a category cable from this port to the **HDBaseT IN** port of the AT-OME-EX-RX or other PoE-compatible receiver.

RS-232

The AT-OME-EX-TX-WPC provides an **RS-232** port which allows communication between a control system and an RS-232 device. This step is optional.

1. Gently remove the RS-232 cover from the faceplate using the tip of a small regular screwdriver.

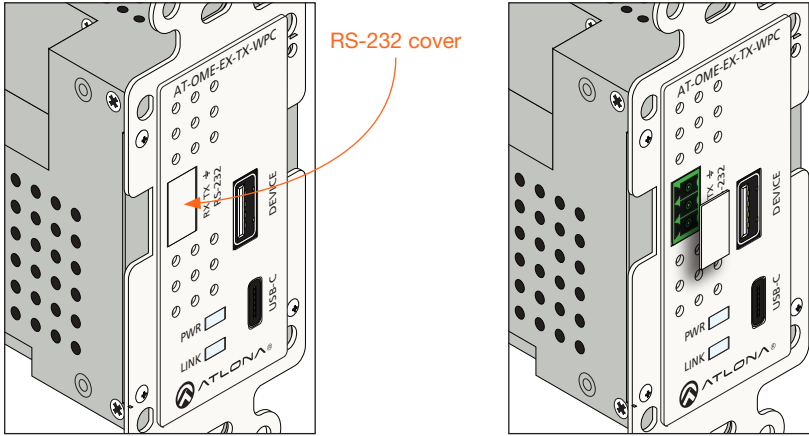

2. Use wire strippers to remove a portion of the RS-232 cable jacket.
3. Remove at least 3/16" (5 mm) from the insulation of the RX, TX, and GND wires.
4. Insert the TX, RX, and GND wires into correct terminal using the included 3-pin captive screw connector.
5. Connect the opposite end of the cable to the control system.

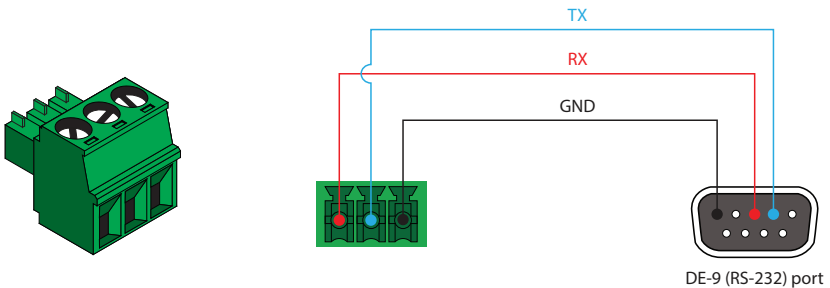

NOTE: Typical DE-9 connectors use pin 2 for TX, pin 3 for RX, and pin 5 for ground. On some devices functions of pins 2 and 3 are reversed.

Faceplate Removal and Assembly

Removal of the faceplate requires that the AT-OME-EX-TX-WPC be disassembled from the electrical box or mud ring. A small Phillips-head screwdriver is required to remove the faceplate.

1. Unscrew the four Phillips-head screws from the sides of the faceplate, as shown:

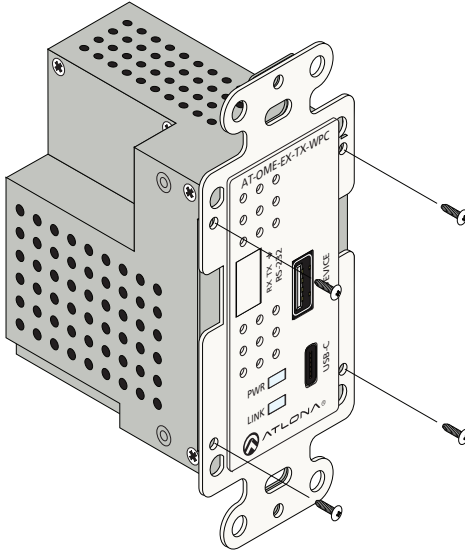







2. Gently remove the faceplate by pulling it toward you.
3. Attach the new faceplate, then secure it using the four Phillips-head screws. Do not over-tighten or apply high-torque devices to the screws. Doing so may damage the faceplate and/or the screws.
4. Install the AT-OME-EX-TX-WPC into the electrical box or mud ring.
5. Reattach the wallplate.

Installation

1. Connect a USB-C cable from the source to the **USB-C** port.
2. OPTIONAL: Connect a USB device, such as a speakerphone to the **DEVICE** port. This port provide 5 W of power.
3. Connect a category cable, from the **HDBaseT OUT** port on the rear of the transmitter, to the **HDBaseT IN** port on the receiver.
4. OPTIONAL: Connect an RS-232 cable between a control system and the **RS-232** port on the transmitter. Refer to [RS-232 \(page 3\)](#) for more information.

Cable Recommendation Guidelines

Refer to the tables below for recommended cabling when using Altona products with HDBaseT. The green bars indicate the signal quality when using each type of cable. Higher-quality signals are represented by more bars.

Core	Shielding	CAT5e	CAT6	CAT6a	CAT7
Solid	UTP (unshielded)				N/A
	STP (shielded)				





IMPORTANT: Stranded or patch cables are not recommended due to performance issues.



Cable*	Max. Distance @ 4K	Max. Distance @ 1080p
CAT5e	295 feet (90 meters)	330 feet (100 meters)
CAT6 / CAT6a / CAT7	330 feet (100 meters)	330 feet (100 meters)

*Altona recommends TIA/EIA 568-B termination for optimal performance.

LED Indicators

The **PWR** and **LINK** LED indicator on both the transmitter and receiver unit provides basic information on the current status of the AT-OME-EX-TX-WPC.

PWR		Description
Solid green		Unit is powered. Normal operating mode.
Blinking green		Unit is in firmware update mode. Refer to Updating the Firmware (page 7) for more information.
Off		Unit is not powered. <ul style="list-style-type: none"> • Make sure that the category cable between the HDBaseT IN port on the transmitter and the HDBaseT OUT port on the receiver is secure. • Make sure that the power supply, at the receiver, is connected to an active AC outlet.

LINK		Description
Solid amber		The link integrity between the transmitter and the receiver is good.
Blinking amber		Poor signal integrity between the transmitter and the receiver. <ul style="list-style-type: none"> • Make sure that the category cable between the HDBaseT IN port on the transmitter and the HDBaseT OUT port on the receiver is secure. • The category cable may be compromised. Try using a different category cable. Make sure that the cable is solid core. Stranded or patch cables are not recommended.
Off		The link integrity between the transmitter and the receiver is compromised. <ul style="list-style-type: none"> • Check the category cable between the HDBaseT IN port on the transmitter and the HDBaseT OUT port on the receiver.

Updating the Firmware

Requirements:

- AT-OME-EX-TX-WPC
- Firmware file
- Computer running Windows
- USB-A to micro-USB cable
- USB Firmware Update Tool



IMPORTANT: Do not disconnect power from the unit while performing the firmware update procedure.

1. Disconnect power from the AT-OME-EX-TX-WPC, which can be done by disconnecting the category cable from the HDBaseT port on the receiver.
2. Remove the faceplate to access the hidden “firmware update” button, located above the **PWR** LED indicator.

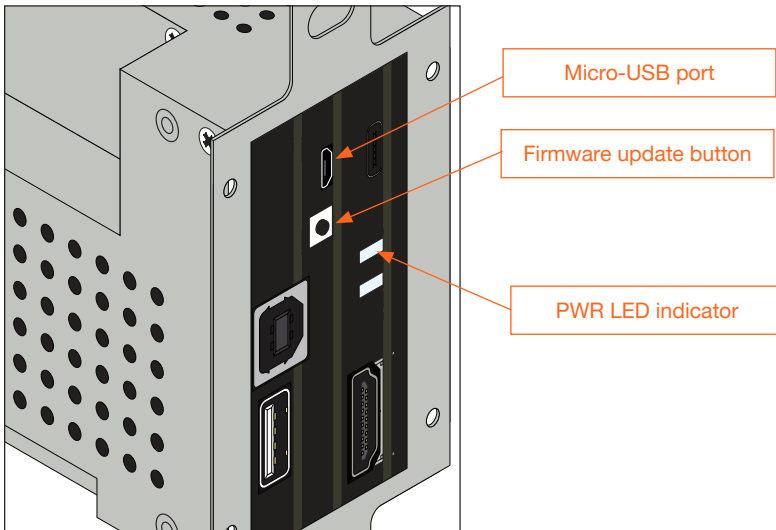

3. Connect a USB-A to micro-USB cable to the micro-USB port on the AT-OME-EX-TX-WPC to a PC.
4. Simultaneously press and hold the firmware update button, while reconnecting the power. The **PWR** LED indicator will be blinking green.
5. If a USB UPDATE folder is opened automatically, notate the drive letter and close the folder.

6. Launch the USB Update Tool.
7. The drive letter of the mounted drive for the unit will be displayed in the **Disk Drive** field. If it is not, click the **Refresh** button.

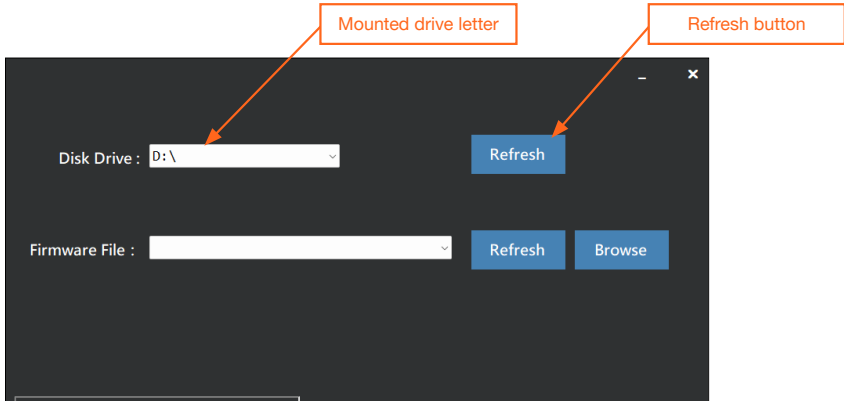

8. Click the **Browse** button and select the firmware file. Once the firmware file is selected, it will appear in the **Firmware File** field. If the firmware file is not displayed in this field, click the **Refresh** button.
9. Click the **Update Firmware** button.

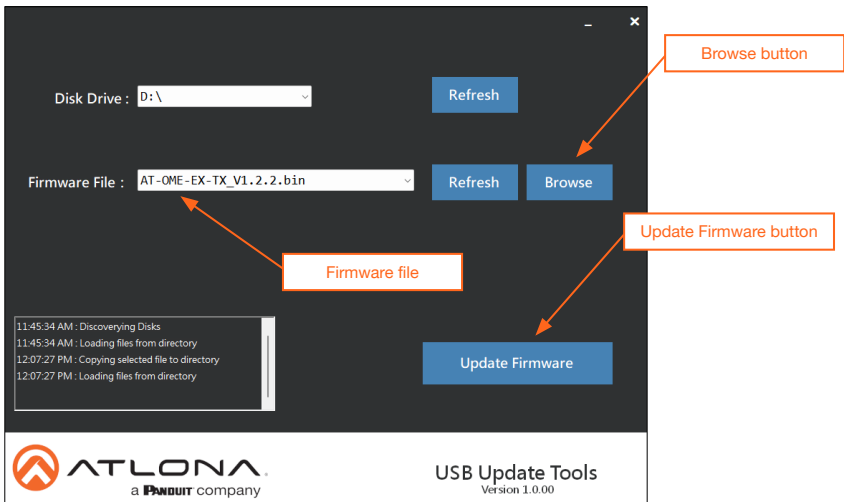

10. The firmware update process will begin and will be monitored by a progress bar.

 **IMPORTANT:** Do not disconnect power from the unit while performing the firmware update procedure.

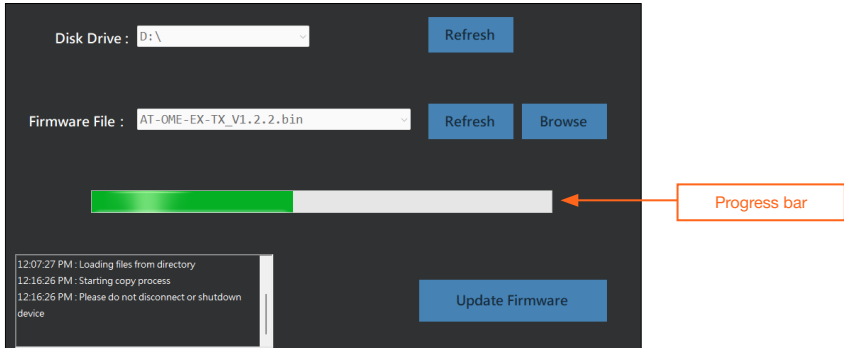

11. After the update process has completed, the Copy process completed message will be displayed in the message window.

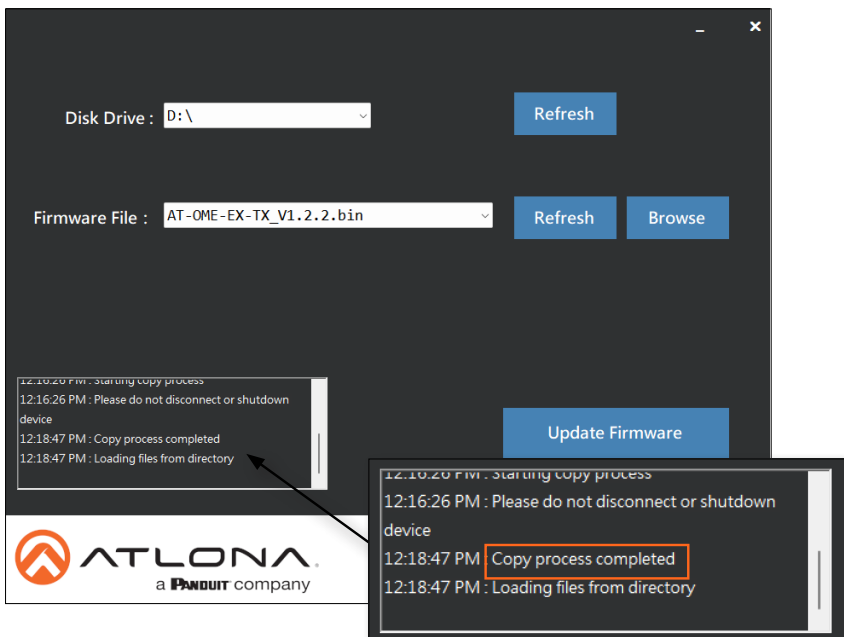

The **PWR** LED indicator, on the front panel, will flash green while the unit is being updated. Do not disconnect the USB cable during the update process. When the **PWR** LED stops flashing and is solid green, the update process will be complete.

12. Repeat the above steps for each unit.

Notes

Warranty

To view the product warranty, use the following link or QR code:

<https://atlona.com/warranty/>.



English Declaration of Conformity

The English version can be found under the resources tab at:

<https://atlona.com/product/at-ome-ex-tx-wpc/>.



Chinese Declaration of Conformity 中国RoHS合格声明

由SKU列出於:

<https://atlona.com/about-us/china-rohs/>.



HIGH-DEFINITION MULTIMEDIA INTERFACE

The terms HDMI, HDMI High-Definition Multimedia Interface, HDMI trade dress and the HDMI Logos are trademarks or registered trademarks of HDMI Licensing Administrator, Inc.