

# FIBER CATALOG

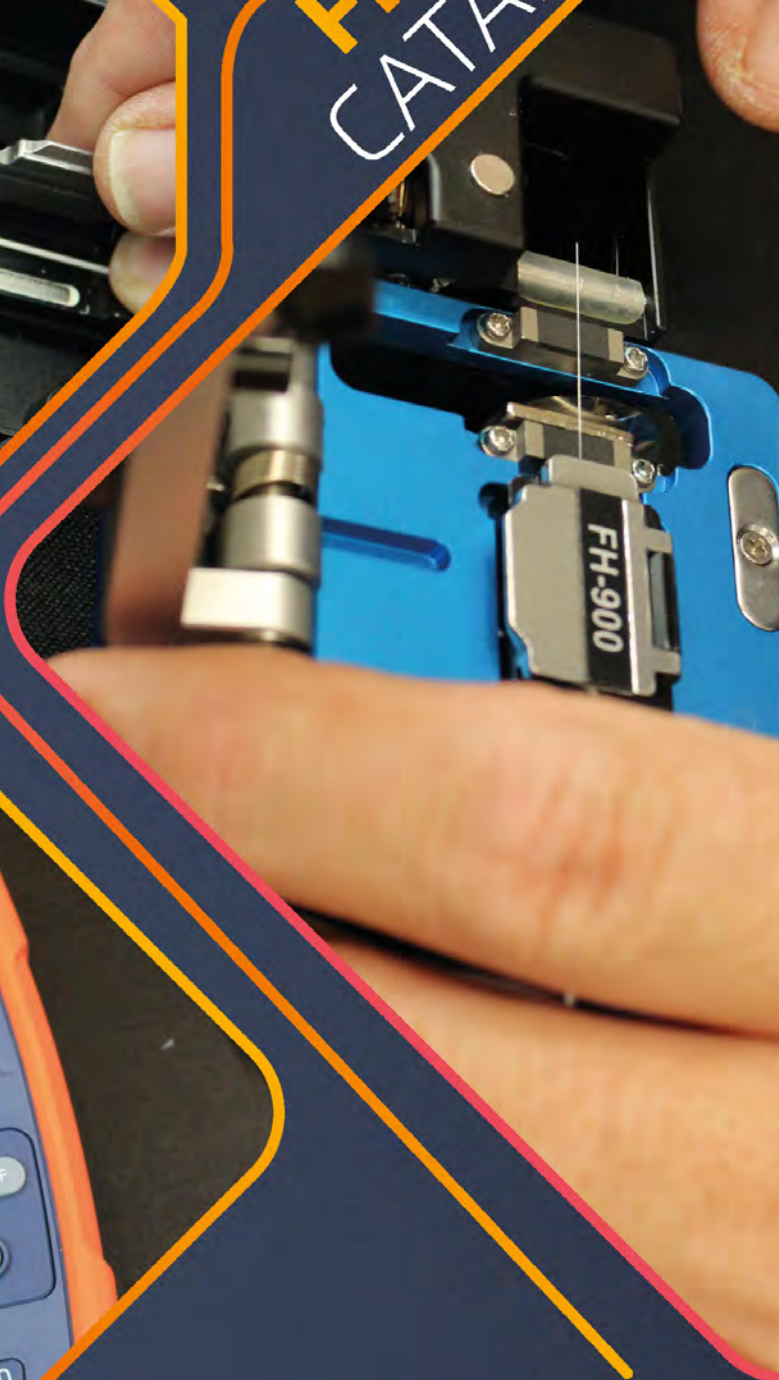

# TEMPO<sup>®</sup>

COMMUNICATIONS

FAST. ACCURATE. RELIABLE.

COMMUNICATIONS | CABLE TV | FIBER TESTING

# WELCOME TO TEMPO COMMUNICATIONS.

With over 20 years of supply to the Fiber Optic industry, Tempo Communications' fiber test products and tools have been tried and trusted by the following industrial segments: Telecoms (BT, Comcast), Avionics (Airbus, Boeing, Lockheed Martin), Petrochemical, Military (US Navy, NATO), Research and Development, Academia.

With a rich fiber heritage dating back to Rifocs and Opto-Electronics, Tempo Communications has grown into a worldwide supplier of fiber products offering a wide portfolio of tools and test equipment for the installation, maintenance and testing of fiber optic cabling systems.

Our Fiber test products and tools are selected and manufactured to Tempo Communications' rigorous design and performance criteria. Products are produced in house at our manufacturing facility in California or sub-contract manufactured by Tempo approved and vetted quality manufacturers. Our fiber test products pass through a Tempo final check before despatch to ensure that the highest quality standard is maintained and delivered to you.

After sales support is provided out of Vista, California and by Tempo Europe Limited at Tempo's Calibration & Repair Service Centre in Cwmbran, South Wales.

## PRODUCT RANGE

---

Our portfolio covers a range of instruments and solutions for:

- Installation
- Loss Measurement
- Fault Finding

The range of fiber Test Instruments provided by Tempo Communications covers easy to operate and economically priced:

- |                                    |                        |
|------------------------------------|------------------------|
| Fusion Splicers & Cleavers         | Light Sources          |
| Optical Time Domain Reflectometers | Live Fiber Identifiers |
| Optical Power Meters               | Visual Fault Locators  |

As can be seen from above our focus is on the Physical Layer, Outside Plant products as opposed to service testing. Our philosophy being "A fully tested physical layer is the foundation for a functional service"!

This is why it is important to us to manufacture products that are easy to use and cost effective.

Included alongside these test sets are fiber stripping and preparation tools and a range of accessory items to enable you to outfit technicians performing fiber optic installation and maintenance on multi-mode and single-mode networks.

These products complete the Tempo promise of delivering quality, professional tools and test products.

# NEW FIBER PRODUCTS AT TEMPO



# CONTENTS

OPTICAL FUSION SPLICERS.....	5
OPTICAL FIBER CLEAVERS.....	10
FIBER FAULT LOCATORS - OTDRS.....	13
LAUNCH CABLES.....	19
VISUAL FAULT LOCATOR.....	21
LIVE FIBER IDENTIFIER.....	22
OPTICAL POWER METERS & LIGHT SOURCES.....	24
OPTICAL POWER METERS.....	25
STABILIZED LIGHT SOURCES.....	29
SPECIAL LAUNCH CONDITION POWER METERS & SOURCES .....	33
XL fiberTOOLS ADAPTERS.....	38
ACCESSORIES.....	40
FIBER HAND TOOLS.....	42
FIBER TOOL KITS.....	48
OPTICAL WAVELENGTH SPLITTERS.....	51
DROP FIBER REPAIR KIT.....	52
EML100 ELECTRONIC MARKER LOCATOR.....	54
SACRIFICIAL CONNECTORS.....	55
MAINTENANCE OF FUSIONS SPLICERS AND CLEAVERS.....	56
CALIBRATION GLOSSARY.....	57

# OPTICAL FUSION SPLICERS

Tempo Communications fusion splicers utilize two different splicing technologies in our product offering. The FSP200 is a Core Alignment based splicer and the 915FS is an Active Clad splicer.

The FSP200 Core Alignment splicer incorporates six motor technology and is the most capable splicer when splicing legacy or dissimilar fibers. This is because two motors are used to adjust the objective lenses so that the cameras are able to precisely locate the center of the core of the fiber optic cable. This is especially important with older fibers that have geometry variability such as ovality and concentricity of the core with respect to the fiber cladding. The core alignment technology is also more tolerant of contamination and will yield the lowest splice losses in adverse conditions.

The 915FS fusion splicer is an Active Clad fusion splicer and has four motors to align the fibers. No objective lens focusing is provided which is sufficient when splicing two fibers of the similar geometry. Since singlemode fibers produced in the last two decades are of remarkably consistent geometries, even between cable manufacturers, the splice loss is virtually the same as the Core Alignment splicer.

Both the Active Clad and Core Alignment fusion splicers far surpass the performance of the V-Groove technology splicers that employ only two adjustment motors.

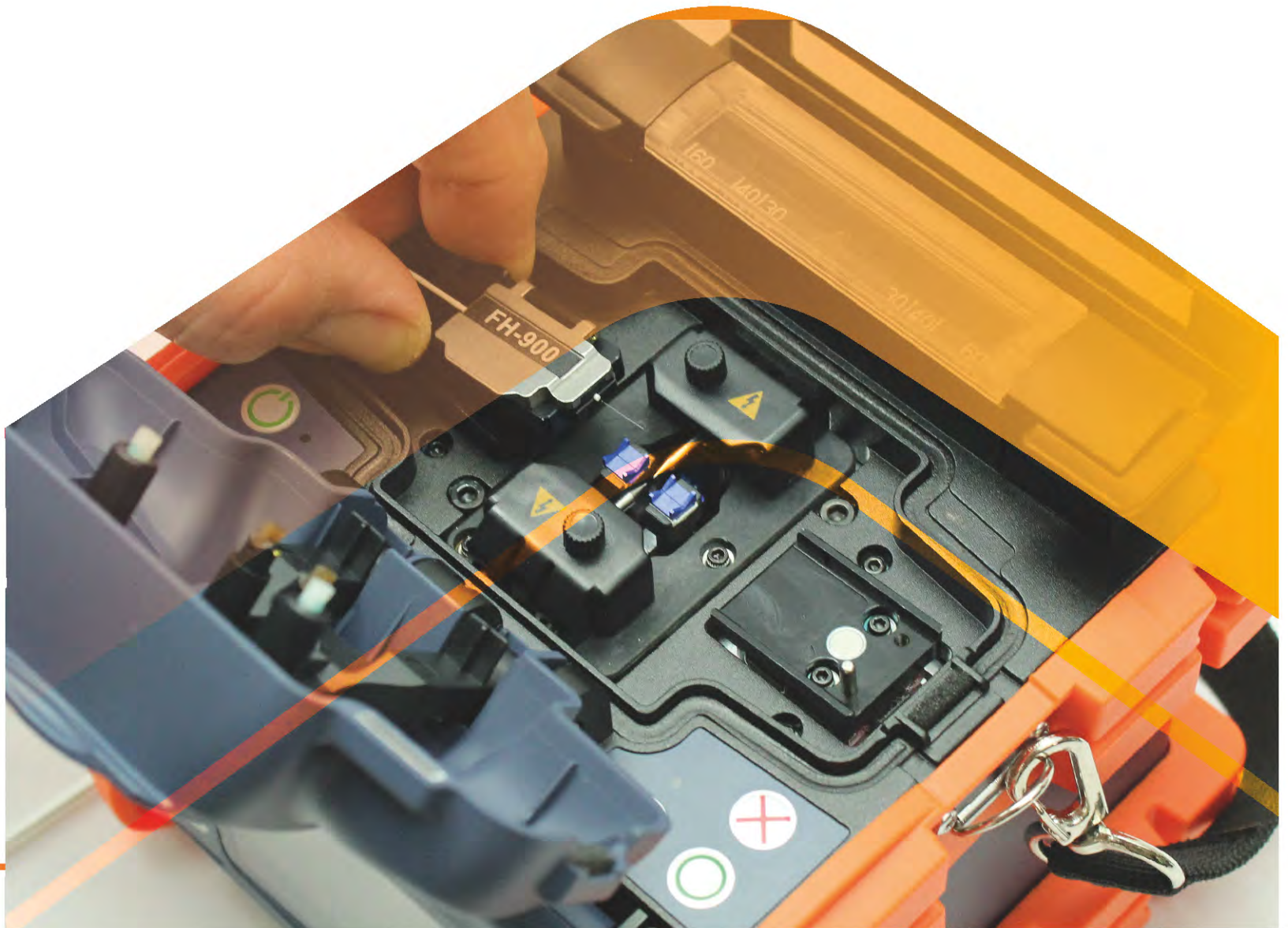

## FSP200 CORE ALIGNMENT OPTICAL FUSION SPLICER

The Tempo Communications FSP200 Optical Fiber Fusion Splicer is intended to fuse two fiber optic cables, resulting in low splice loss and long-term stable splices. The FSP200 is a Core Alignment splicer that utilizes six precision motor transports.

The FSP200 fusion splicer uses a CDS (Core Detection System), which is also widely known as PAS (Profile Alignment System). The two focus cameras determine the center of the core of the two fibers, then adjusts each in the X, Y, and Z dimensions to automatically and precisely align the two fiber cores. A fusing arc is applied, which then provides the lowest loss fusion splice.

The FSP200 with PAS technology is designed for splicing singlemode and multimode fibers including DSF, NZDS and BIF.

Splices are completed in as little time as seven seconds while providing low splice losses typically of 0.01dB. The high capacity battery is capable of splicing over 200 fusion splices on one battery charge.

The intuitive user interface and IP52 rating insures that the technician able to quickly become proficient splicing in the most demanding conditions.



### FEATURES

- True Core Alignment for Low Loss Splices
- IP52 provides resistance to dust and water ingress
- Small and lightweight for the most demanding jobs
- Loose tube fiber compatible
- Auto-Calculation of Estimated Splice Loss
- Adapters for 200/250, 900µm and 3mm fiber

# FIBER CATALOG

## SPECIFICATIONS:

Applicable Fibers	5M (G.652); MM (G.651); DS (G.653); NZDS (G.655); BIF (G.657); EDF
Fiber Cleaved Length	10mm
Cladding Diameter	80 to 150µm
Coating Diameter	100 to 1000µm
Fiber Count:	Single
Fiber Aligning Method	Core Alignment
Splice Loss (Typical)	0.02 dB (5M); 0.01 dB (MM); 0.04 dB (DS); 0.04 dB (NZDS & BIF)
Splicing Mode	60 Preset / User Definable Modes
Splice Time (Typical)	7 seconds (1)
Boot Time	5 seconds
Number of Splices Per Battery Charge	200 (including 60mm heat shrink cycle) (2)
Splice-On-Connector	SC, LC, FC, ST
Arc Calibration Mode	Automatic and Manual
Protection Sleeve Length	60mm, 40mm, Micro Sleeves
Ingress Protection(3)	IP5X (Dust); IPX2 (Water)
Storage of Splice Results	5,000 Results, 100 screenshots
Drop Test	76cm on five axis

Tension Test	2N
Fiber Display Magnification	200X
Tube Heating Mode	20 Preset / User Definable Modes Adjustable 0-240 seconds
Tube Heating Time (Typical)	18 seconds (4)
Attenuator Mode	0.1 to 15 dB
Electrode Life	5,000 Splices
Display:	3.5" Color, Turn-Over LCD
Connectivity	USB
Operating Conditions	Pressure: 0 to 16,404 feet (0 to 5,000 meters) above Sea Level Wind Velocity up to 15m/s Humidity: 0 to 95% Temperature: -4 to +131F (-20 to +55C)
Storage Conditions	Temperature: -40 to +158F (-40 to +70C)
Power Supply	100 to 240V AC Adapter; Li-ion Battery (4400 mAh)
Weight	3.74lbs (1.7kg) with battery
Dimensions (HxWxD)	4.9" x 4.9" x 5.3" (125 x 125 x 135mm)
Vibration Resistance	10Hz - 500Hz with a spectral density of 0.03g <sup>2</sup> /Hz
Password Protection	Yes

(1) Fast mode. (2) 90s/cycle splice time and power save functions activated. Number of cycles may vary depending on battery status and ambient operating conditions. (3) Dust resistance and rain resistance test do not guarantee that the product will not be damaged under these conditions. (4) Dependent on splice protector used and ambient conditions. Time quoted is with power mode enabled and assuming that the oven is not cold.

\*Specifications subject to change without notice.

## ORDERING INFORMATION:

PART NO.	CAT. NO.	DESCRIPTION
55500052	FSP200	Optical Fusion Splicer
55500053	FSP200-KIT1	FSP200 Fusion Splicer & Cleaver Kit
55500054	FSP200-KIT2	Contractor Fusion Splicer Kit
52063415	06811	915FS FSP200 Batt
52080896	07096	Power Supply, 915FS FSP200
52064141	01325	Splice-On-Connector Adapter (SC & LC)
52066481	02401	Splice-On-Connector Adapter (ST & FC)

PART NO.	CAT. NO.	DESCRIPTION
52063414	01329	Replacement Electrodes
52064143	01332	200/250µm Adapter (Pair)
52064142	01333	900µm Adapter (Pair)
52076996	05801	Loose Tube Adapter (Pair)
52081862	07388	Universal Adapter (Pair)
52067851	03245	3mm Adapter (Pair)
55500059	NA LC	North American Line cord
52066954	02571	European Line Cord
52066952	02570	UK Line Cord
52066930	02568	12 V DC Car Adapter

## 915FS ACTIVE CLADDING OPTICAL FUSION SPLICER

The Tempo Communications 915FS Optical Fiber Fusion Splicer is intended to fuse two fiber optic cables, resulting in low splice loss and long-term stable splices. The 915FS is an Active Clad fusion splicer that utilizes four precision motor transports.

The 915FS fusion splicer capably aligns the two fibers in the X, Y, and Z dimensions to automatically and precisely align the two fibers. A fusing arc is applied, which then provides the lowest loss fusion splice.

The 915FS is designed for splicing singlemode and multimode fibers including DSF, NZDS and BIF.

Splices are completed in as little time as seven seconds while providing low splice losses typically of 0.01dB. The high capacity battery is capable of splicing over 200 fusion splices on one battery charge.

The intuitive user interface and IP52 rating insures that the technician able to quickly



### FEATURES

- Active clad technology for today's fibers
- IP52 provides resistance to dust and water ingress
- Small and lightweight for the most demanding jobs
- Loose tube fiber compatible
- Auto-Calculation of Estimated Splice Loss
- Adapters for 200/250, 900µm and 3mm fiber



# FIBER CATALOG

## SPECIFICATIONS:

Applicable Fibers	5M (G.652); MM (G.651); D5 (G.653); NZDS (G.655); BIF (G.657); EDF
Fiber Cleaved Length	10mm
Cladding Diameter	80 to 150µm
Coating Diameter	100 to 1000µm
Fiber Count	Single
Fiber Aligning Method	Active Clad Alignment
Splice Loss (Typical)	0.02 dB (5M); 0.01 dB (MM); 0.04 dB (D5); 0.04 dB (NZDS & BIF)
Splicing Mode	60 Preset / User Definable Modes
Splice Time (Typical)	7 seconds (1)
Boot Time	5 seconds
Number of Splices Per Battery Charge	200 (including 60mm heat shrink cycle) (2)
Splice-On-Connector	SC, LC, FC, ST
Arc Calibration Mode	Automatic and Manual
Protection Sleeve Length	60mm, 40mm, Micro Sleeves
Ingress Protection	IP5X (Dust); IPX2 (Water) (3)
Storage Of Splice Results	5,000 Results, 100 screenshots
Drop Test	76cm on five axis

Vibration Resistance	10Hz to 500Hz with a spectral density of 0.03g <sup>2</sup> /Hz
Tension Test	2N
Fiber Display Magnification	200X
Tube Heating Mode	20 Preset / User Definable Modes Adjustable 0-240 seconds
Tube Heating Time (Typical)	18 seconds (4)
Attenuator Mode	0.1 to 15 dB
Electrode Life	5,000 Splices
Display	3.5" Color, Turn-Over LCD
Connectivity	USB
Operating Conditions	Pressure: 0 to 16,404 feet (0 to 5,000 meters) above Sea Level Wind Velocity up to 15m/s Humidity: 0 to 95% Temperature: -13 to 122°F (-25 to 50°C)
Storage Conditions	Temperature: -40 to 140°F (-40 to 60°C)
Power Supply	100 to 240V AC Adapter; Li-ion Battery (4400 mAh)
Weight	3.3lbs (1.5kg) with battery 2.6lbs (1.2kg) no battery
Dimensions (HxWxD)	4.9" x 4.9" x 5.3" (125 x 125 x 135mm)

(1) Fast mode. (2) 90s/cycle splice time and power save functions activated. Number of cycles may vary depending on battery status and ambient operating conditions. (3) Dust resistance and rain resistance test do not guarantee that the product will not be damaged under these conditions.

(4) Dependent on splice protector used and ambient conditions. Time quoted is with power mode enabled and assuming that the oven is not cold.

\* Specifications subject to change without notice.

## ORDERING INFORMATION:

PART NO.	CAT. NO.	DESCRIPTION
52079876	915FS	915FS Optical Fusion Splicer
52079879	915FS-KIT1	915FS Fusion Splicer & Cleaver Kit
52079878	915FS-KIT2	915FS Contractor Fusion Splicer Kit
52063415	06811	915FS FSP200 Batt
52080896	07096	Power Supply, 915FS FSP200
52064141	01325	Splice-On-Connector Adapter (SC & LC)
52066481	02401	Splice-On-Connector Adapter (ST & FC)

PART NO.	CAT. NO.	DESCRIPTION
52063414	01329	Replacement Electrodes
52064143	01332	200/250µm Adapter (Pair)
52064142	01333	900µm Adapter (Pair)
52076996	05801	Loose Tube Adapter (Pair)
52081862	07388	Universal Adapter (Pair)
52067851	03245	3mm Adapter (Pair)
55500059	NA LC	North American Line cord
52066954	02571	European Line Cord
52066952	02570	UK Line Cord
52066930	02568	12 V DC Car Adapter

# OPTICAL FIBER CLEAVERS

Tempo Communications has a full suite of fiber optic cleavers including the FCL200, FCL100, 915CL and the 920CL. The FCL200 is the most capable cleaver in that it employs auto fiber end cut and auto blade return features. The 915CL has auto blade return with the 920CL providing the most economical alternative in the traditional cleaving footprint. The FCL100 is a low cost cleaver that is typically used in emergency situations or when cleaving field fibers when used in conjunction with mechanical connectors.

## FCL200 OPTICAL FIBER CLEAVER

### FEATURES

- Accurate Cleaves. Cleave multi-mode and single-mode fiber optic cables.
- Long Life. Blades rotate for longer life - over 48,000 cleaves.
- Adaptable. Supports 200um, 250um, 900um fibers, ribbon and loose tube fibers.
- Fast. For use with the 910FS, 915FS or FSP200 Optical Fusion Splicers for maximum speed and efficiency with auto return mechanism.
- Dust bin. Safely and automatically collects end cuts during the cleaving process.
- Fixed Clamp. Allows the technician to use the FCL200 as a standalone cleaver.



### SPECIFICATION:

Applicable Fibers	SM (G.652); MM (G.651); D5 (G.653); NZDS (G.655); BIF (G.657)
Fiber Cleaved Length	5mm to 25mm
Cladding Diameter	125µm
Coating Diameter	0.20mm, 0.25mm and 0.9mm
Fiber Count	Single and Ribbon (12)

Cleaving Angle	< 1.5°
Blade Rotation Positions	16
Blade Life	48,000 Cleaves
Weight	0.77lbs (350g)
Dimensions	2.55 x 3.85 x 2.55" (65 x 98 x 65mm)

## 915CL OPTICAL FIBER CLEAVER

### FEATURES

- 48,000 cleaves
- Auto return of blade mechanism for fast and easy cleaves
- Cleaves singlemode and multimode fibers
- Integrated dust bin
- Prepares fibers for use in the 910FS, FSP200 and 915FS fusion splicers
- Supports 200um, 250um, 900um fibers, and loose tube fibers.
- Fixed Clamp. Allows the technician to use the 915CL as a standalone cleaver.



### SPECIFICATION:

Applicable Fibers	SM (G.652); MM (G.651); DS (G.653); NZDS (G.655); BIF (G.657)	Cleaving Angle	< 1.5°
Fiber Cleaved Length	10mm	Blade Life	48,000 Cleaves
Cladding Diameter	125µm	Weight	0.56lbs (255g)
Coating Diameter	0.25mm and 0.9mm	Dimensions (HXWXD)	2.29 x 2.17 x 1.89" (58 x 55 x 48mm)
Fiber Count	Single		

## 920CL OPTICAL FIBER CLEAVER

### FEATURES

- 48,000 cleaves
- Cleaves single-mode and multi-mode fibers
- Integrated dust bin
- Prepares fibers for use in the 910FS, FSP200 and 915FS fusion splicers
- Supports 200um, 250um, 900um fibers, and loose tube fibers.
- Fixed Clamp. Allows the technician to use the 920CL as a standalone cleaver.



### SPECIFICATION:

Fiber Type	SM (G.652); MM (G.651); DS (G.653); NZDS (G.655); BIF (G.657)	Cleaving Angle	< 0.5°
Fiber Cleave Length	5mm to 25mm	Blade Life	48,000 Cleaves
Cladding Diameter	125µm	Weight	0.68lbs (310g)
Coating Diameter	0.20mm, 0.25mm and 0.9mm	Dimensions	2.13 x 2.28 x 2.28" (54 x 58 x 58 mm)
Fiber Count	Single		

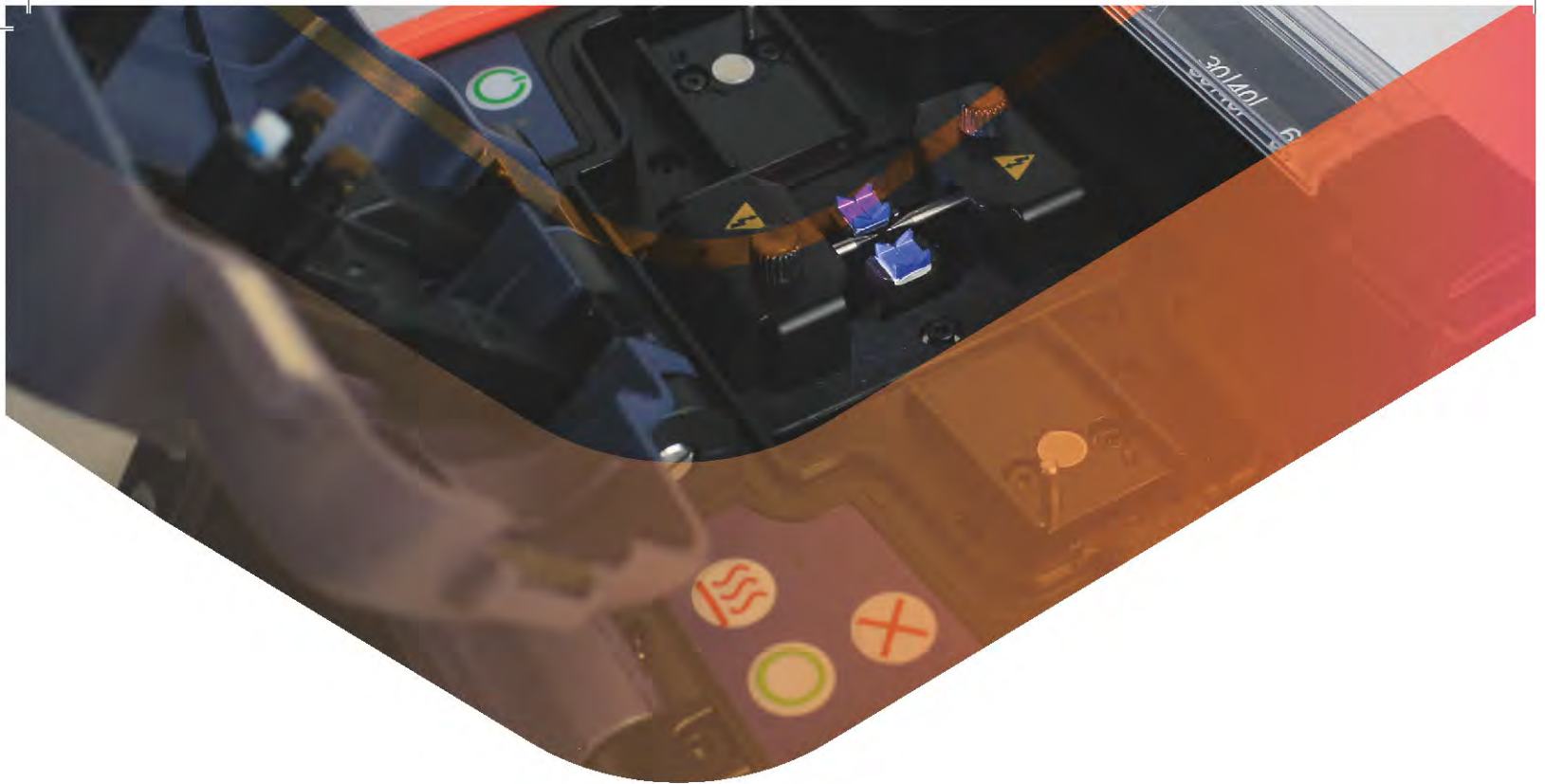

## FCL100 OPTICAL FIBER CLEAVER

### FEATURES

- 200, 250 & 900 micron fibers
- Cleaves single-mode and multi-mode fibers
- Prepares fibers for use with mechanical connector, fusion splicers and bare fiber adapters

### SPECIFICATION:

Applicable Fibers:	125 Micron Fiber (200/250/900)
Fiber Cleaved Length:	2.0mm to 20.0mm
Dimensions:	4.88" x 0.79" x 1.57" (124mm x 20mm x 40mm)
Weight:	0.13lbs (60g)
Operating:	Spring Activated



### ORDERING INFORMATION:

PART NO.	CAT. NO.	DESCRIPTION
55500055	FCL200	FCL200 Optical Fiber Cleaver
52078354	915CL	915CL Optical Fiber Cleaver
52082727	920CL	Fiber Optic Cleaver
52087221	FCL100	Field Cleaver
52064143	01332	200/250µm Adapter (PAIR)
52064142	01333	Adapter, 900µm (PAIR)
52076996	05801	Adapter, Loose Tube (PAIR)

PART NO.	CAT. NO.	DESCRIPTION
52078357	07111	Fixed Clamp with Screw
52086838	04268	Replacement Screw for Fixed Clamp
52064145	01640	Cleaving Wheel
55500194	BLD-01	FCL100 Blade
55500196	SPR-01	FCL100 Spring

# FIBER FAULT LOCATORS - OTDR's

The 930XC OTDR's utilize an easy to learn intuitive user that allows the technician to quickly locate fiber faults in FTT(x) and Point to Point networks. Both singlemode and multimode versions are available which span all of the common wavelengths used in telco and LAN installations. The 930XC-20C OTDR is the basic version that effectively measure and characterize singlemode fiber links at 1310nm and 1550nm. The 930XC-30F measures at 1310nm, 1550nm and 1625nm where the 1625nm wavelength can be used to measure live fibers without interrupting network traffic. The 930XC-30P measures at 1310nm, 1490nm and 1550nm and is used to characterize fiber networks used in GPON applications. The 930XC-20M is a multimode OTDR that measures at 850nm and 1300nm which are commonly used in LAN.

The free Trace Viewer program imports SOR files which provides the tools required to complete a comprehensive report on the the fiber measurements.

All 930XC OTDR's are GR196 compliant which validates all specifications at an independent lab at temperature extremes, along with drop testing and dust chamber validation.

## 930XC HANDHELD MULTIMODE OTDR

### FEATURES

- 850/1300nm wavelength
- Up to 24dB dynamic range
- Optical Power Meter
- Stabilised Light Source
- Visual Fault Locator
- Fiber analysis software for report generation
- Large backlight LCD colour display
- RS-232/USB interface
- NiMH batteries for 8 hours continuous use
- Software compatible to Win. XP, 7, 8, 8.1,10
- Multiple languages
- Pass/Fail thresholds
- Event table
- Insertion loss
- Return loss

### ORDERING INFORMATION:

PART NO.	CAT. NO.	DESCRIPTION
52067080	02607	930XC-20M-FC Multimode OTDR W/FC Bulkhead
52067079	02606	930XC-20M-SC Multimode OTDR W/SC Bulkhead
52067081	02608	930XC-20M-ST Multimode OTDR W/ST Bulkhead



## 930XC HANDHELD SINGLEMODE OTDR

### FEATURES

- 2 & 3 wavelength options available: 1310/1550nm; 1310/1490/1550nm; 1310/1550/1625nm
- Up to 35dB SWDR on the two wavelength model Up to 38dB SWDR on the three wavelength model
- Optical Power Meter
- Stabilised Light Source
- Visual Fault Locator
- Fiber analysis software for report generation
- Large backlight LCD colour display
- Measure length and defects of coiled fiber
- 1625nm operation for live fiber testing (30F)
- RS-232/USB interface
- NiMH batteries for 8 hours continuous use
- LinkViewer Software analysis
- Macrobend analysis



### ORDERING INFORMATION:

PART NO.	CAT. NO.	DESCRIPTION
<b>DUAL WAVELENGTH SINGLEMODE OTDR</b>		
52067083	02610	930XC-20C Singlemode OTDR, 1310/1550nm FC/UPC
52067082	02609	930XC-20C Singlemode OTDR, 1310/1550nm SC/UPC
52067084	02611	930XC-20C Singlemode OTDR, 1310/1550nm ST/UPC
52067086	02613	930XC-20C Singlemode OTDR, 1310/1550nm FC/APC
52067085	02612	930XC-20C Singlemode OTDR, 1310/1550nm SC/APC

PART NO.	CAT. NO.	DESCRIPTION
<b>TRIPLE WAVELENGTH SINGLEMODE PON OTDR</b>		
52067088	02615	930XC-30P Singlemode OTDR, 1310/1490/1550nm FC/UPC
52067087	02614	930XC-30P Singlemode OTDR, 1310/1490/1550nm ST/UPC
52067089	02616	930XC-30P Singlemode OTDR, 1310/1490/1550nm SC/UPC
52067091	02618	930XC-30P Singlemode OTDR, 1310/1490/1550nm FC/APC
52067090	02617	930XC-30P Singlemode OTDR, 1310/1490/1550nm SC/APC

## ORDERING INFORMATION:

PART NO.	CAT. NO.	DESCRIPTION
<b>TRIPLE WAVELENGTH SINGLEMODE FILTERED OTDR</b>		
52067093	02620	930XC-30F Singlemode OTDR, 1310/1550/1625nm FC/UPC
52067092	02619	930XC-30F Singlemode OTDR, 1310/1550/1625nm SC/UPC
52067094	02621	930XC-30F Singlemode OTDR, 1310/1550/1625nm ST/UPC
52067095	02623	930XC-30F Singlemode OTDR, 1310/1550/1625nm SC/APC
52067096	02626	930XC-30F Singlemode OTDR, 1310/1550/1625nm FC/APC

<b>930XC OTDR ACCESSORIES</b>		
PART NO.	CAT. NO.	DESCRIPTION
52047065	AC-ADPT-20-UNI	Universal Power Supply
52034549	AC-CONN-FC-L2	FC Connector (For UPC & APC)
52034550	AC-CONN-ST-L2	ST Connector (For UPC)
52078401	AC-CONN-SC-UPC-L2	SC Connector (For UPC & APC)
52067854	ADAPTER, OPM SC (930XC)	OPM SC Adapter
52067855	ADAPTER, OPM FC (930XC)	OPM FC Adapter
52067856	ADAPTER, OPM ST (930XC)	OPM ST Adapter
52039299	AC-ADPT-V30	Vehicle Adapter (6FT, 5.5 OD, 2.1M)
52034541	20988	Soft Carry Case
52034542	20989	USB Cable
52034543	20990	R5-232 Cable
52034552	20999	NIMH Battery (9.6V)



## SINGLEMODE & MULTIMODE OTDR KIT

### FEATURES

- Combines 930XC SM and MM OTDRs in 1 kit
- 850/1300nm & 1310/1550nm
- FC, ST and SC Adapters available
- Compact handheld design
- Easy to use
- Fast automated testing
- LinkViewer Software analysis
- Microbend detection
- Up to 24dB dynamic range on MM and up to 35dB range on SM
- Large backlight LCD display
- Measure length and defects on SM & MM fiber
- Fiber analysis software for data management & report generation
- RS-232/USB interface
- NiMH batteries for 8 hours continuous use
- Supplied with SC adapters



### ORDERING INFORMATION:

PART NO.	CAT. NO.	DESCRIPTION
52067457	26307	930XC-SM (APC) + MM (UPC) Kit - (SM & MM OTDR Kit)





- DC Charger Port**
- Optical Power Meter**
- USB Port**
- Visual Fault Locator**
- OTDR Port**
- OTDR 1625nm live out of band testing port**

## SPECIFICATIONS:

	930XC-20C	930XC-30F	930XC-30P	930XC-20M
Wavelength ( $\pm 20\text{nm}$ )	1310/1550	1310/1550/1625	1310/1490/1550	850/1300
Dynamic Range (dB)	35	38/37/37	38/37/37	21/24
Event Deadzone (m)	1.0	1.0	1.0	$\leq 2.5$
Attenuation Deadzone (m)	4.5	4.5	4.5	$\leq 12$
Pulsewidth (ns)	5, 10, 30, 100, 300, 1 $\mu\text{s}$ , 2.5 $\mu\text{s}$ , 10 $\mu\text{s}$ , 20 $\mu\text{s}$			12, 30, 100, 275, 1 $\mu\text{s}$ , 2 $\mu\text{s}$
Selectable Ranges (km)	0.3, 1.3, 2.5, 5, 10, 20, 40, 80, 120, 160, 240		0.1, 0.3, 0.5, 1.3, 2.5, 5, 10	0.1, 0.3, 0.5, 1.3, 2.5, 5, 10, 20, 40, 80
Sampling Points	16,000 (Maximum)		16,000 (Maximum)	
Average Time	15s/30s/1 min/2 min/3 min			
Distance Measurement Accuracy	$\pm(1\text{m} + 5 \times 10^{-5} \times \text{distance} + \text{sampling space})$			
Connector Type	PC or APC (interchangeable FC, SC, ST)			
Reflection Detect Accuracy	$\pm 4\text{ dB}$			
Attenuation Detect Accuracy	$\pm 0.05\text{ dB/dB}$			
Measurement Data Storage	1,000 test curves			
Data Transmission	RS-232/USB port			
Visual Fault Locator (VFL)	3mW; 650nm			
Optical Power Meter (OPM)	InGaAs			
OPM Wavelengths	850, 1300, 1310, 1490, 1550, 1625nm			
OPM Range	+6 to -70dBm (+6 to -60dBm @ 850nm)			
OPM Display resolution	0.01dB			
OPM MOD Identification	1kHz, 2kHz			
Stabilized laser Source (SLS)	Wavelength same as selected in OTDR mode $\leq -7\text{dBm}$			
Power Supply	NiMH chargeable battery/AC adapter			
Battery Life	Support over 8 hours operating on one charge or over 20 hours standby			
Operating Temperature	$-10^{\circ}\text{C}$ to $50^{\circ}\text{C}$			
Storage Temperature	$-20^{\circ}\text{C}$ to $60^{\circ}\text{C}$			
Relative Humidity	0 to 95% (non-condensing)			
Weight	1.9lbs. (0.87kg)			
Dimensions	7.7" H x 3.9" W x 2.4" L (196mm x 100mm x 64mm)			
Compliance	BelCore GR196, CE, FCC, UL, RoHS, WEEE			

## TRACE VIEWER SOFTWARE

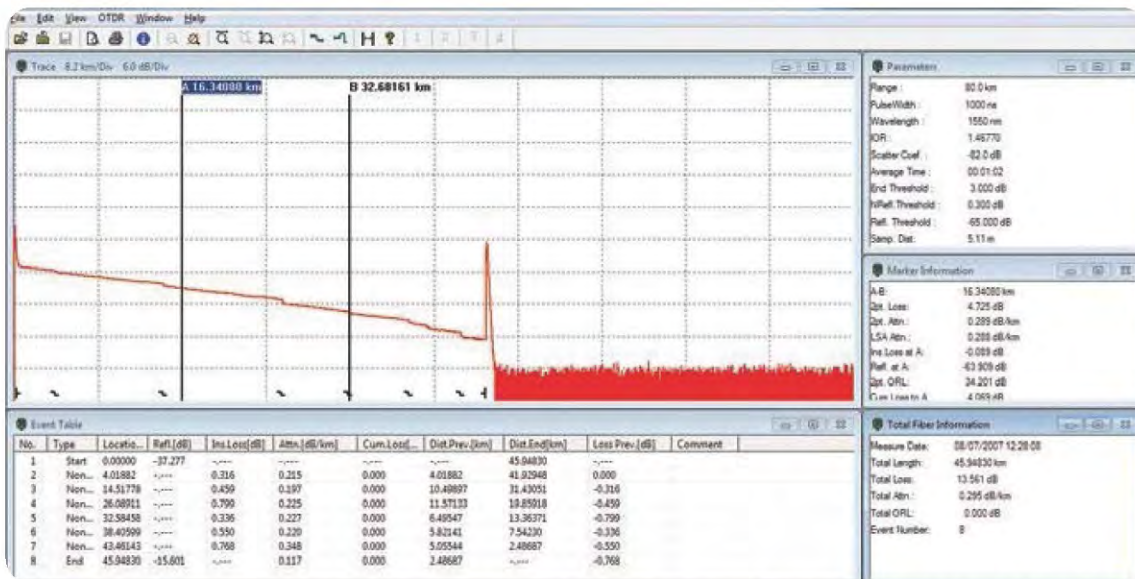

TraceViewer Software showing trace, event table, Parameters, Marker Information & Total Fiber Information.

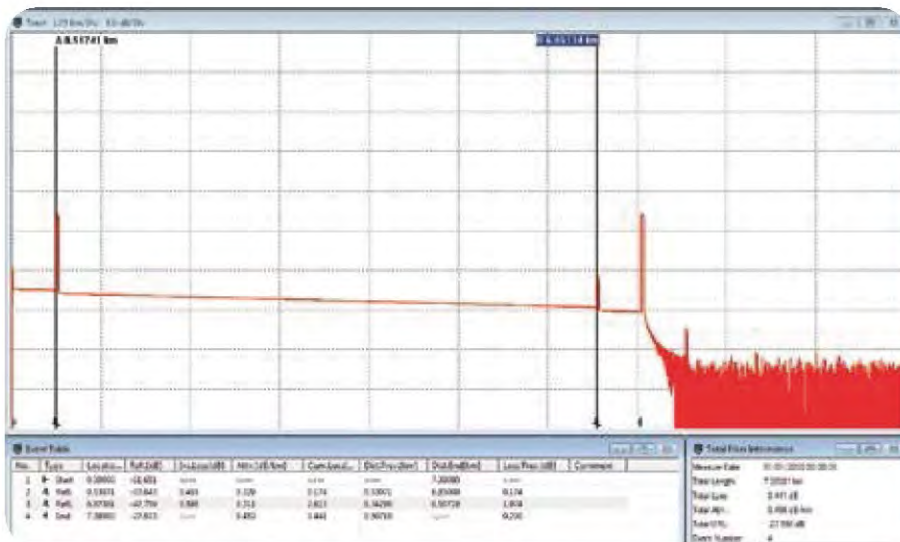

TraceViewer with expanded trace view highlighting the benefit of Launch Cables to examine Near & Far end connectors.

## LINK VIEWER SOFTWARE

LinkViewer Software showing optical events that exceed the threshold of the Fiber Under Test.

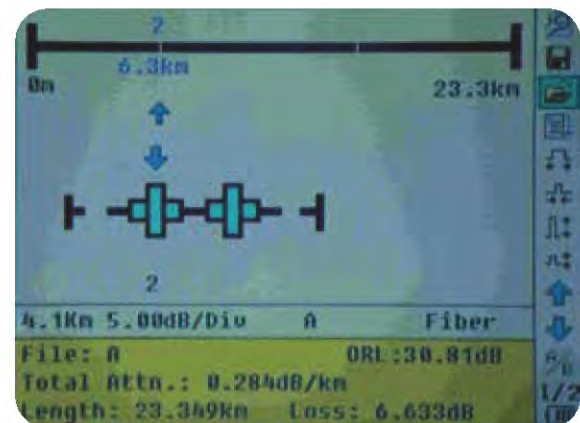

# LAUNCH CABLES

Launch cables are used to reduce the effect deadzones caused by mechanical connection of the OTDR to the Fiber under Test. Constructing a backscatter trace before the Near end connector enables the technician to evaluate the connector for Insertion Loss & return Loss. Also known as a Pulse Suppressor.

## FEATURES

- Universal compact design
- Rugged construction

## BENEFITS

- Troubleshoot the input connector and the initial fiber span that may be masked by the deadzone of an OTDR
- Characterise input and output connectors and the entire fiber link
- Minimise Dead zones
- Eliminate multiple patch cables



**ORDERING INFORMATION:**

PART NO.	CAT. NO.	DESCRIPTION
52076057	LC-500	500M Launch Cable with Patch Panel Matrix
52081881	LC500SCAPCSM	500M Launch Cable SC APC Singlemode
52081882	LC500SCUPCSM	500M Launch Cable SC UPC Singlemode
52081883	LC1000SCAPCSM	1000M Launch Cable SC APC Singlemode
52081884	LC1000SCUPCSM	1000M Launch Cable SC UPC Singlemode
52081885	LC2000SCAPCSM	2000M Launch Cable SC APC Singlemode
52081886	LC2000SCUPCSM	2000M Launch Cable SC UPC Singlemode
52081887	LC150SCPCMM	150M Launch Cable SC PC 50/125 Multimode
52081888	SCLC Adapter	SC TO LC Adapter (Use the SC to LC Adapter to convert the Launch Cable to LC connectors)

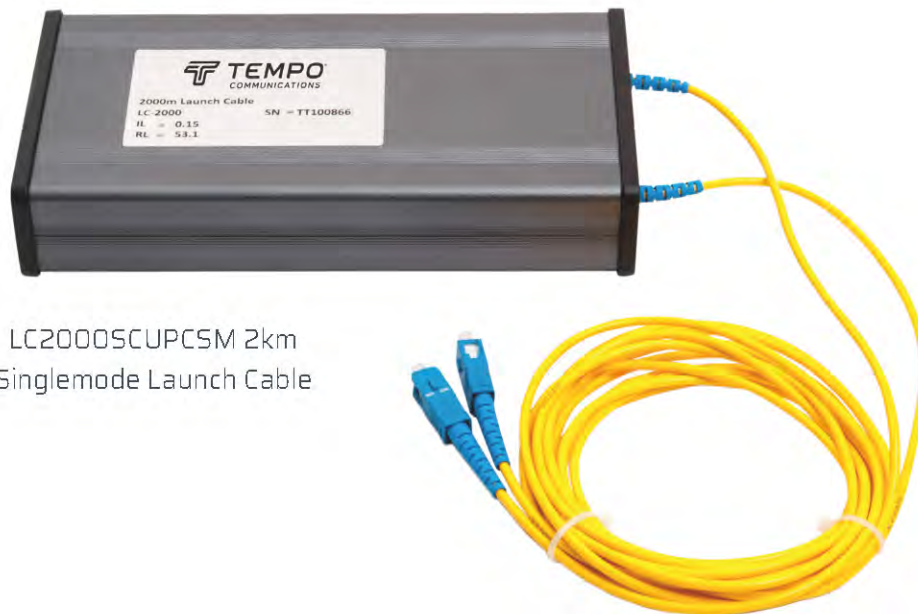

LC2000SCUPCSM 2km Singlemode Launch Cable

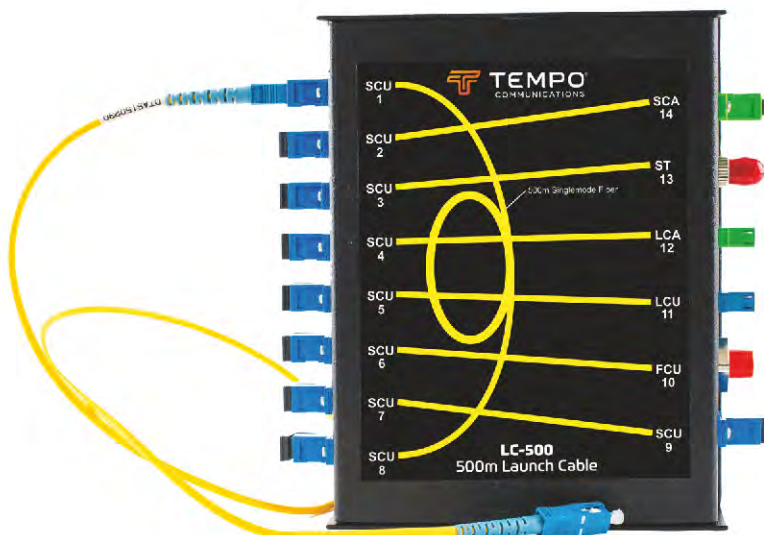

LC-500 Patch Panel Matrix with 1m SC/PC-SC/PC patch cable

## 180XL VISUAL FAULT LOCATOR

### LOCATING BREAKS AND BENDING LOSSES:

The 180XL visual fault finder is an indispensable tool for quickly identifying bending losses and breaks in optical fibers. If a fiber is bent too tightly, red laser light will be seen escaping through the jacket. Likewise, if a fiber is broken, escaping light will be visible where the break is located.

### IDENTIFYING BAD CERAMIC CONNECTORS:

Ceramic connectors are easily tested using the 180XL visual fault finder. A fiber broken inside, or past, the ferrule will cause it to glow, as shown below at left. If the whole connector glows, it is definitely defective. If the end face polish of the connector is bad, light will be reflected internally, as shown below right. This will also make the ferrule glow when the 180XL is used.



Fiber broken in ferrule

Poor end face polish

### FEATURES

- Continuous wave output mode for steady fault illumination
- Blinking output mode increases viewing contrast
- Easy to use "Quick Connect" interface fits all 2.5mm fiber optic connectors
- Ergonomic switch permits easy one-handed operation
- Simple, versatile, and user-friendly design
- Rugged, compact, and splash proof aluminium housing
- High output 1.0mW (0dBm) 650nm red laser
- Up to 7km range
- Two AA-size alkaline batteries provide 80 hours of continuous operation
- Nylon belt holster included

### ORDERING INFORMATION:

PART NO.	CAT. NO.	DESCRIPTION
52068671	180XL	Visual Fault Locator Kit (2.5mm UCI)
52068673	125mm ADAPTER	1.25mm adapter

### SPECIFICATIONS:

Wavelength	650nm +/-10nm	Connector Interface	2.5mm Universal, Optional 1.25mm adapter
Emitter Type	Fabry Perot	Battery	AA (2)
Output Power	0dBm	Battery Life	80 Hours with 3.9Wh batteries
Spectral Width (CPR)	<2nm	Weight	0.15lbs, (70g) (not including batteries)
Laser Classification	2	Dimensions	7.08" x 0.91" Dia (180mm x 23mm Dia)
Range	7km	Operating Temperature	-10 to +45C
Modes of Operation	CW and 2Hz Modulation	Storage Temperature	-40 to +70C
Method of Display Operation	Red/Green LED	Certifications	CE, WEEE, CDRH Reach RoHS
Fiber Type	Singlemode, Multimode		

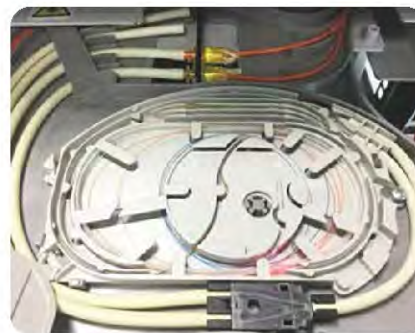

Macrobend easily visible in splice tray using 180XL



1.25mm Adapter

## FI-100 LIVE FIBER IDENTIFIER

The Tempo Communications FI-100 fiber identifier is used to measure the approximate core power in FTT(x) and P2P networks without the need to disconnect the fiber under test. The low induced insertion loss when used with the precision adapters insures that the network equipment to go into an alarm condition due to excessive bending of the fiber. The high sensitivity detectors measure the direction of signal transport and are capable of detecting injected tones from laser sources at 270Hz, 330Hz, 1kHz and 2kHz. The FI-100 is also capable of sensing the core power in bend insensitive fiber that is being more commonly used in drop fibers in FTTH installations.

- Low insertion loss
- Easy operation
- Versatile
- Quickly identify fibers
- Tone Detect
- Signal direction indicator



FI-100 KIT contains instruction manual, sun shade, all available mandrels and carrying case.

## SPECIFICATIONS:

Identified Wavelength Range	800-1700nm	
Identified Signal Type	270Hz ±5%, 330Hz ±5%, 1kHz ±5%, 2kHz ±5%	
Detector Type	1mm InGaAs	
Adapter Types	Ø0.25 (Applicable for Bare Fiber and ribbon cable) Ø0.9 (Applicable for Ø0.9 Cable) Ø2.0 (Applicable for Ø2.0 Cable) Ø3.0 (Applicable for Ø3.0 Cable)	
Signal Indication	Left & Right LED	
Signal Direction Test Range (CW/0.9mm fiber)	-46 to 10dBm (1310nm) -50 to 10dBm (1550nm)	
Signal Power Test Range (CW/0.9mm fiber)	-50 to +10dBm	
Tone Detect Test Range (Average)	Ø0.9, Ø2.0, Ø3.0	-30 to 0dBm (270Hz, 1kHz)
		-25 to 0dBm (2kHz)
	Ø0.25	-25 to 0dBm (1kHz, 2kHz)
		-20 to 0dBm (2kHz)
Insertion Loss (Typical/ Maximum)	0.3 / 0.8dB at 1310nm 1.5 / 2.5dB at 1550nm	
Battery	AAA Alkaline (2)	
Operating Temperature	-10 to +60°C	
Storage Temperature	-25 to +70°C	
Dimension	196 X 30.5 X 27mm	
Weight	195g	
Certifications	CE, FCC, RoHS, EAC	
Number of Activations	3600	

## ORDERING INFORMATION:

PART NO.	CAT. NO.	DESCRIPTION
52068188	FI-100 KIT	Fiber Identifier Kit
52068108	FI-250µm/RIB	250µm Adapter
52068109	FI-100-900µm	900µm Adapter
52068110	FI-100-2mm	2mm Adapter
52068111	FI-100-3mm	3mm Adapter
52068113	FI-100-Case	Soft Carry Case
52068114	FI-100-Sunshade	Sun Shade



# OPTICAL POWER METERS & LIGHT SOURCES

The OPM2XX, OPM5XX and SL55XX provide the technician with a ruggedized tool set to accurately and quickly measure the insertion loss of singlemode and multimode fiber links.

The OPM2XX and OPM5XX measure the absolute fiber power to validate the optical loss budget in FTTX and P2P networks. All common wavelengths are supported and work in harmony with the dual and triple wavelength sources to facilitate insertion loss measurements. Tone injection is supported so that individual fibers can be identified when used with the OPM2XX, OPM5XX or FI-100.

The OPM2XX also incorporates an integrated visual fault locator for safe and quick visual identification of cut or damaged fiber, Macrobends and contaminated or damaged connectors.

The IP54 rating along with industry leading vibration and shock specifications assure the technician will complete their assigned task in even the most demanding environment.







## OPM210 / OPM220 MICRO OPTICAL POWER METER

### FEATURES

- Wide measurement range (+10 to -70dBm)
- High power CATV range (+26 to -50dBm)
- VFL for safe and effective fault locating
- Singlemode and multimode compatible
- Calibrated wavelengths of 850/1300/1310/1490/1550/1625nm
- 270Hz, 1kHz and 2kHz tone detect
- Auto power off

### CONTENTS:

- Micro OPM with VFL
- Lanyard
- Instruction sheet
- Certificate of Conformance



## SPECIFICATIONS:

PARAMETER	SPECIFICATIONS	
	OPM210	OPM220
Model:		
Measurement Range:	-70 to +10dBm (1310/1490/1550/1625)	-50 to +26dBm (1310/1490/1550/1625)
	-60 to +10dBm (850/1300)	-40 to +26dBm (850/1300)
Calibrated Wavelengths:	850, 1300, 1310, 1490, 1550, 1625nm	
Display Resolution:	0.01dB	
Accuracy*:	±0.25dB	
Linearity*:	+/-0.5dB (+10 to -3dBm)	+/-0.5dB +26 to -3dBm
	+/-0.1dB (-3 to -50dBm)	+/-0.1dB -3 to -50dBm
	+/-0.5dB (-50 to -70dBm)	
Connector:	Universal 2.5mm	
Wavelength Response:	700 - 1700nm	
Detector:	InGaAs	
Power Supply:	AAA x 2 Alkaline	
Battery Lifetime:	>60 Hours (OPM mode)	
Operating Temperature:	-10 to +50°C (<90% Relative Humidity)	
Storage Temperature:	-20 to +60°C (<90% Relative Humidity)	
VFL Wavelength:	650nm +/-20nm	
VFL Output:	≤1mW/ 2Hz	
VFL Range:	4km	
Size:	106 x 58 x 28mm (4.17 x 2.28 x 1.10")	
Weight:	106g (0.23lbs)	
Auto Power Off:	10 minutes of no activity	
Certifications:	CE, RoHS, CDRH, WEEE	

## ORDERING INFORMATION:

PART NO.	CAT. NO.	DESCRIPTION
55500025	OPM210	Standard Power OPM with VFL
55500026	OPM220	High Power OPM with VFL
52068673	125mm ADAPTER	1.25mm Adapter
52084662	08325	Micro OPM Carry Case

## OPM510 / OPM520 OPTICAL POWER METER

### FEATURES

- Wide measurement range (+6 to -70dBm)
- High power CATV range (+26 to -50dBm)
- Singlemode and multimode compatible
- Calibrated wavelengths of 850/1300/1310/1490/1550/1625nm
- 270Hz, 1kHz and 2kHz tone detect
- Auto power off

### CONTENTS:

- Optical Power Meter
- SC Adapter
- Soft Carry Case
- Certificate of Conformance



## SPECIFICATIONS:

PARAMETERS	SPECIFICATIONS	
	OPM510	OPM520
MODEL	OPM510	OPM520
Cal. Wavelength (nm)	850, 1300, 1310, 1490, 1550, 1625	
Measure range (dBm)	-65 ~ +10 <sup>(1)</sup>	-50 ~ +27
Detector type	InGaAs	
Accuracy (dB)	±5% ±0.01nW (±0.5dB@850nm)	±5% ±1nW (±0.5dB@850nm)
Linearity	+/-0.5dB (+10 to -3dBm) +/-0.1dB (-3 to -50dBm) +/-0.5dB (-50 to -65dBm)	+/-0.5dB +27 to -3dBm +/-0.1dB -3 to -50dBm
Resolution (dB)	0.01dB	
Functions	W/mW/μW/dBm/dB(REF)/ MOD TONE DETECT 270Hz, 1kHz, 2kHz	
Connector Type	SC (Interchangeable LC, ST, SC)	
Fiber Type	Singlemode & Multimode	
Battery Life	> 100 Hours	
Power Supply	9V Alkaline or 1000mAh Lithium Battery/ 9V AC adapter	
Operating Temperature	-10°C - 50°C	
Storage Temperature	-20°C -70°C	
Relative Humidity	0 TO 95% (NON-CONDENSING)	
Weight	0.68lbs (300g)	
Dimensions (H x W x T)	6.1 x 3.5 x 1.3" (155 x 88 x 33mm)	
IP Rating	IP54	
Vibration	5Hz to 150Hz, Amplitude+0.15mm	
Shock	Peak acceleration 25g at a pulse duration of 6ms	
Compliance	CE, FCC	

## ORDERING INFORMATION:

PART NO.	CAT. NO.	DESCRIPTION
55500023	OPM510	InGaAs OPM +10 to -65dBm
55500024	OPM520	InGaAs OPM +27 to -50dBm

## SLS520 STABILIZED LIGHT SOURCE

### FEATURES

- Dual and Triple Wavelength Laser Sources at 1310, 1490, 1550, 1625 & 1650nm
- Dual Wavelength LED Source at 850nm & 1300nm
- Accurate Insertion Loss Measurements
- Tone and Probe Fiber Networks at 270Hz, 1kHz and 2kHz
- SC, LC, FC and ST Interchangeable Bulkheads
- Ruggedized Package, IP54 compliant
- Compatible with Singlemode and Multimode Networks
- Auto Off or Continuous On Operation
- Battery or 120/240VAC Operation

### CONTENTS:

- Laser or LED
- SC Adapter
- Soft Carry Case
- Certificate of Conformance



## SPECIFICATIONS:

MODEL	SLS520	SLS525	SLS530	SLS535	SLS536
Wavelength (±20nm)	1310/1550	850/1300	1310/1490/1550	1310/1550/1625	1310/1550/1650
Range of Use	Singlemode	Multimode (62.5/125)		Singlemode	
Emitter Type	FP	LED		FP	
Spectrum Width	≤ 5nm	+/-40nm		≤ 5nm	
Output Power	≤ 0dBm/-1dBm	-20dBm/-21dBm		≤ 0dBm/-1dBm	
Output Power Stability	±0.05 dB/15min; ±0.10dB/8hr	±0.05 dB/15min ±0.15dB/8hr		±0.05 dB/15min; ±0.10dB/8hr	
MOD Frequency	270, 1kHz, 2kHz				
Display	LCD				
Battery Life	60 Hours				
Connector Type	SC/PC (Interchangeable LC, ST, FC)				
Power Supply	9V Alkaline or 1000mAh Lithium Battery/ 9V AC adapter				
Operating Temp.	-10°C to 50°C				
Storage Temp.	-20°C to 70°C				
Relative Humidity	0 to 95% (non-condensing)				
Weight	0.71 lbs (300g)				
Dimension (H×W×T)	6.1 × 3.5 × 1.3" (155 × 89 × 33mm)				
IP Rating	IP54				
Vibration	5Hz to 150Hz, Amplitude = 0.15mm				
Shock	Peak acceleration 25g at a pulse duration of 6ms				
Compliance	CE, FCC, 21 CFR 1040.10 (Laser)				

## ORDERING INFORMATION:

PART NO.	CAT. NO.	DESCRIPTION
55500018	SLS520	1310/1550nm Dual Laser
55500019	SLS525	850/1300nm Dual LED
55500020	SLS530	1310/1490/1550nm Triple Laser
55500021	SLS535	1310/1550/1625nm Triple Laser
55500022	SLS536	1310/1550/1650nm Triple Laser

## OPTICAL POWER METER & STABILIZED LIGHT SOURCE KITS

### ORDERING INFORMATION:

PART NO.	CAT. NO.	DESCRIPTION
55500027	SM DUAL KIT	OPM510 & SL5520
55500028	SM DUAL KIT HP	OPM520 & SL5520
55500029	MM DUAL KIT	OPM510 & SL5525
55500030	SM T PON KIT	OPM510 & SL5530
55500031	SMT 1625 KIT	SL5535 & OPM510
55500032	SMT 1650 KIT	SL5536 & OPM510
55500033	SMT PON KIT HP	SL5530 & OPM520
55500034	SMT 1625 KIT HP	SL5535 & OPM520
55500035	SMT 1650 KIT HP	SL5536 & OPM520
55500050	SMMMKIT-T	SL5520, SL5525 & OPM510
55500051	SMMMKIT-M	SL5520, SL5525 & OPM520



**SMMM KIT-M**

**OPM AND SLS ACCESSORIES:**

PART NO.	CAT. NO.	DESCRIPTION
55500048	PS-100	EXTERNAL POWER SUPPLY
55500036	CC-1	CARRY CASE, SOURCE/OPM
55500049	CC-2-3	CARRY CASE, DUAL, TRIPLE, SOURCE/OPM





# SPECIAL LAUNCH CONDITION OPTICAL POWER METERS & SOURCES

## INSTRUMENTS DESIGNED FOR POF & FIBER OPTIC CABLE TESTING:

The Special Launch Condition Sources and Optical Power Meter XL fiberTOOLS™ are designed for the professional to perform installation and maintenance measurements on both Plastic & Glass fiber optic networks.

The instrument family consists of standard instruments for routine cable testing, through to Stabilised Light Sources with stringent Launch Conditions for the Avionics and Defence Industries and Research Laboratories.

Tempo's LED Light Sources have been manufactured with specific launch conditions to overcome the inconsistent measurements caused by standard Light Sources.

The Multimode products that have specific launch conditions are designed for greater accuracy and repeatable results.

Tempo also manufacture instruments to test POF links. POF links are being used in a number of industries particularly on short links where optical budgets aren't too tight. The automotive industry is a good example of this.

The XL fiberTOOLS™ are fully featured, general purpose fiber optic instruments and easy to operate to outfit all technicians performing fiber optic installation and maintenance.

Tempo also manufacture a range of Optical Light Sources and Power Meters with enhanced EMI performance, manufactured to Military standards, these offer the ultimate in accuracy.

Tempo's range of Optical Light Sources and Power Meters were designed specifically for: avionics, automotive, defence and research.



## 567XL SILICON FIBER OPTIC POWER METER (FORMERLY 557B)

### FEATURES

- Absolute (dBm) & Referenced (dB) measurements
- Long battery life
- User selectable auto shut-off
- SOC interface adapts to all commonly used connectors
- Rugged and splash-proof



### OPTICAL SPECIFICATIONS

Detector Type	3 x 3.5mm Silicon	
Calibration Wavelengths	650nm, 780nm, and 850nm	
Power Range	+3dBm to -60dBm	
Accuracy	±0.25dB	
Linearity at	+3dBm to -3dBm	±0.5db
	-3dBm to -50dBm	±0.1db
	-50dBm to -60dBm	±0.5db
Resolution	0.01dB	
Power Requirements	Two AA 1.5V batteries (approx. 100 hours continuous operation)	
Connector Interface	SOC	
Operating Temperature	-15° C to +55° C	
Storage Temperature	-35° C to +70° C	
Humidity	0 to 95% non-condensing	
Dimensions	72 x 14.2 x 3.5 cm (2.8 x 5.6 x 1.4 in.)	
Weight	241g (8.5 oz)	
CE	EN61010; EN50081-1:1992; EN55011, Group 1, Class A EN50082-1: 1992 IEC 801-2, -3, -4	
Typical Power Output (µm)		
200/230 SI Fiber	-15dBm ±0.5dB	
Modulation Frequencies	270Hz, 1kHz and 2kHz	
Power Requirements	Two AA 1.5V batteries (approx. 24 hours continuous operation)	

## 573XL & 573XL-UNIV 650NM LED SOURCE FOR LARGE CORE PLASTIC AND GLASS FIBER (FORMERLY 253B-POF)

### FEATURES

- Stable Calibrated output Storage
- Continuous wave and modulated output
- Easy to use
- Long battery life
- User selectable auto shut-off
- 650nm wavelength
- Rugged and splash-proof
- Fixed ST and SOC Adapter options are available



## **577XL M90** 850nm LED SOURCE WITH M90 LAUNCH CONDITIONS (62.5/125 $\mu$ m FIBER) (FORMERLY 253B-POF)

### FEATURES

- Stable calibrated output
- Easy to use
- Continuous wave and modulated output
- Long battery life - approx. 24 hours
- User selectable auto shut-off
- Rugged and splash-proof
- Economically priced
- UCI Adapter options are available
- 850nm wavelength



## **577XL AS100** 850NM LED SOURCE WITH AS-100 LAUNCH CONDITION (100/140 $\mu$ m FIBER) (FORMERLY 257A-AS100)

### FEATURES

- Stable calibrated output
- Easy to use
- Continuous wave and modulated output
- Long battery life - approx. 24 hours
- User selectable auto shut-off
- Rugged and splash-proof
- Economically priced
- UCI Adapter options are available
- 850nm wavelength



## 578XL M90 1300NM LED SOURCE WITH M90 LAUNCH CONDITION (62.5/125µM FIBER)

### FEATURES

- Stable Calibrated output Storage
- Continuous wave and modulated output
- Easy to use
- Long battery life
- User selectable auto shut-off
- 1300nm wavelength
- Rugged and splash-proof
- UCI Adapter options available (options are available)



## XL SERIES LED SOURCES

	573XL	577XL	578XL
Nominal	650nm	850nm	1300nm
Range (nm)	630 - 670	840 - 880	1270 - 1345
Max. spectral width (FWHM)	40nm	55nm	150nm
Stability, 1 hour	±0.05dB	±0.05dB	±0.05dB
<b>POWER OUTPUT</b>			
200/230µm SI MM fiber	-15dBm ***		-
100/140µm GI MM fiber	-	-20dBm**(AS-100)	-20dBm
62.5/125µm GI MM fiber**	-	-20dBm** (M90)	-20dBm** (M90)
50/125µm GI MM fiber	-		-21dBm
9/125µm SM fiber	-	-	-38dBm
Power output uncertainty	±0.5dB	±0.5dB	±0.5dB
Connector interface	50C or 5T	Universal connector interface	
Functions	MOD: Modulated output mode (270Hz, 1kHz, 2kHz) CW: Continuous Wave output mode Freq: selectable modulation frequency		
Modulation frequencies	270Hz, 1kHz, and 2kHz (±0.5%) using switch inside battery compartment		
Power requirements	Two AA-size alkaline batteries		
Battery life	> 24 hours		
<b>ENVIRONMENT</b>			
Operating Temperature	-15°C to 55°C		
Storage Temperature	-35°C to 70°C		
Humidity, Non-Condensing	0% to 95%		
Dimensions	7.2 x 14.2 x 3.5cm (2.8 x 5.6 x 1.4in)		
Weight			
Single	215g (7.6oz)		

\* Within specified operating environment of 20°C to 25°C

\*\* Calibrated launch level, equilibrium modal distribution

\*\*\* Calibrated launch level

## 560XL-EMI FIBER OPTIC POWER METER WITH ENHANCED EMI PERFORMANCE

### FEATURES

- 0.01dB measurement resolution
- Multi-Wavelength Storage
- SOC interface adapts to all commonly used connectors\*
- Long battery life
- Absolute (dBm) & Referenced (dB) Power measurements
- User selectable auto shut-off
- Rugged and splash-proof
- Economically priced
- Enhanced EMI performance: MIL-STD-461E, Method RS103, tested to 190 V/m
- Engineered for use in areas with high electrical interference

### OPTICAL SPECIFICATIONS

Detector Type	1mm InGaAs
Calibration Wavelengths (nm)	850, 1300, 1310, 1550
Power Range	+3dBm to -60dBm
Accuracy	±0.25dB
Resolution	0.01dB
Power Requirements	Two AA 1.5V batteries (approx. 100 hours continuous operation)
Connector Interface	SOC



## 570XL-AS100-EMI 850/1300NM LED SOURCE WITH ENHANCED EMI PERFORMANCE

### FEATURES

- Stable calibrated output
- 850nm / 1300nm wavelength LED Source
- Long battery life - approx. 80 hours
- Continuous wave and modulated output
- User selectable auto shut-off
- Supports a wide range of UCI connectors, including FC, SC, and ST
- Economically priced
- Enhanced EMI performance: MIL-STD-461E, Method RS103 tested to 200 V/m
- Easy to use
- Configured to meet AS100 launch conditions
- Rugged and splash-proof

### OPTICAL SPECIFICATIONS

Detector Type	1mm InGaAs
Calibration Wavelengths (nm)	850nm, 1300nm
Power Range	820nm to 880nm; 1270nm to 1345nm
Accuracy	±0.25dB
Resolution	0.01dB
Power Requirements	Two AA size 1.5V batteries (approx. 40 hours continuous operation)
Connector Interface	UCI



## 580XL-EMI 1310/1550NM LASER SOURCE WITH ENHANCED EMI PERFORMANCE

### FEATURES

- Stable calibrated output
- 1310nm / 1550nm wavelength Laser Source
- Long battery life - approx. 80 hours
- Continuous wave and modulated output
- User selectable auto shut-off
- Easy to Use
- Enhanced EMI performance: MIL-STD-461E, Method RS103 tested to 200 V/m
- Supports a wide range of UCI connectors, including FC, SC, and ST
- Rugged and splash-proof
- Economically priced

### OPTICAL SPECIFICATIONS

	1310nm	1550nm
Centre Wavelength	1310nm	1550nm
Range (Typical)	1280nm to 1340nm	1520nm to 1580nm
Max. Spectral Width (FWHM)	<5nm	<5nm
Stability (1 hour)	±0.05dB	±0.05dB
Typical Power Output (9/125µm)		
Minimum	-8dBm	-8dBm
Typical	-7dBm	-7dBm
Modulation Frequencies	270Hz, 1kHz and 2kHz	270Hz, 1kHz and 2kHz
Power Requirements	Two AA 1.5V batteries (approx. 80 hours continuous operation)	
Connector Interface	UCI	



### ORDERING INFORMATION- XL *fiberTOOLS*™ SERIES:

PART NO.	CAT. NO.	DESCRIPTION
52058723	00025	567XL Silicon Fiber Optical Power Meter
52058784	00023	573XL 650nm LED Source with Fixed ST Connector
52061770	00598	573XL 650nm LED Source with SOC Adapter Interface
52058727	00029	577XL-AS100, 850nm LED Source with 100/400µm Launch Condition
52058726	00027	577XL-M90, 850nm LED Source with 62.5/125µm Launch Condition
52061054	00753	578XL-M90, 1300nm LED Source with 62.5/125µm Launch Condition
52060994	00244	560XL-EMI HH OPM, INGAAS, EMI SHIELDING
52060995	00245	570XL-AS100-EMI HH DUAL LED SOURCE, EMI SHIELDING
52060996	00246	580XL-EMI HH LASER SOURCE, EMI SHIELDING

### **SNAP ON CONNECTOR (SOC) FOR XL SERIES INSTRUMENTS**

Snap On Connectors (SOC) are used on the XL Fiber Optic Power Meters and 573XL LED light source. The Snap On Connectors configure the instruments for various optical connectors. Contact Tempo Communications for other available adapters.

FC



T1020

ST



T1030

SC



T1062

### **UNIVERSAL CONNECTOR INTERFACE (UCI) FOR XL SERIES INSTRUMENTS**

Users will need to purchase a Universal Connector Interface (UCI) adapter for use with specific light sources. Please specify the desired connector adapter type when ordering.

FC



APC-108

SC



ASC-108/C

ST



ATS-108

## FEATURES

- Our SOC and UCI adapters provide direct connectivity for Tempo Communications fiberTOOLS® to a wide range of industry-standard fiber optic connectors
- Adapter design ensures maximum accuracy and repeatability when performing critical measurements on fiber optic systems
- Easy to clean and use
- Single-mode and multimode compatible
- SOC adapters are compatible with both PC and APC interfaces
- UCI adapters feature durable phosphor bronze alignment sleeve

CONNECTOR	SOC Adapter				
	DESCRIPTION	PART NO.	CAT. NO.	PART NO.	CAT. NO.
1.25 mm Quick-Connect Universal Adapter (LC, MU, etc.)		50605881	T1026	USE HYBRID CABLE	
FC		50605768	T1020	50605720	APC-108
LC		50606000	T10LC	USE HYBRID CABLE	
MIL-T-29504/4 & /5 Termini		50605898	T1038	USE HYBRID CABLE	
SC		50605751	T1062	52039964	ASC-108/C
ST		50605775	T1030	50605737	ATS-108
Versatile Link - V/Z PIN		50606048	T10ZP	USE HYBRID CABLE	
SMA 905/906		50605966	T1087-POF	N/A	
ST		52040191	T1030-POF	N/A	

## TIA-568B & FOTP-171A CERTIFIED REFERENCE CABLES

### SPECIFICATIONS:

Ferrule OD	2.4990 ±0.0005mm
Fiber to Ferrule Eccentricity	<0.25µm (SM) and <3µm (MM)
Insertion Loss	<0.15dB (SM, 1310/1550nm) and <0.25dB (MM, 850/1300nm)
Return Loss	>55dB (SM, 1310/1550nm) and >40dB (MM, 850/1300nm)
Beam Exit Angle	<0.25° (SM) and <0.5° (MM)
Standard Length	3m



### HOW TO ORDER CABLE ASSEMBLY:

USE FOR SPECIFYING A PATCH CORD, PIGTAIL OR A CUSTOMER-SUPPLIED DEVICE.

Order Length ≤5 meters, Final Length -0% / +5% Order Length ≥5 meters, Final Length -0% / +10%  
 Minimum Order Length: 1 foot. For shorter lengths, please call the factory!

ENTER ORDER CODES FROM PRICE LIST:

□□□□-□□□R□□□□-□□□□

CONNECTOR #1

CONNECTOR #2

ADDITIONAL OPTIONS:

00 = NO CONNECTOR

02 = CUSTOMER COMPONENT PIGTAIL

CABLE CODE LENGTH

IF FRACTIONAL LENGTHS:

"R" IS SUBSTITUTED FOR DECIMAL POINT

= METERS

F = FEET, N = INCHES

CUSTOM OPTIC CODE

OPTIONAL



# ACCESSORIES

## **fiberTOOLS™** HARD CARRY CASE

### FEATURES

- Designed to hold Tempo handheld instruments and a full range of test accessories.
- Top tray holds up to 3 handheld instruments and a 180XL Visual Fault Finder
- Bottom compartment of both models stores additional instruments and test accessories
- Compact, waterproof and lockable
- Moulded from black structural foam resin

### ORDERING INFORMATION:

PART NO.	CAT. NO.	DESCRIPTION
50606840	900B	Carry Case Ruggedised 3 Unit

### SPECIFICATIONS:

Weight: 500g
Dimensions: 380 x 185 x 180mm



## **fiberTOOLS™** SOFT CARRY CASE

### FEATURES

- Designed to hold a variety of Tempo OTDRs, Fiber Testers, Tools and accessories.
- 930C Soft Carry Case
- Suitable for multiple instrument storage
- Can hold up to 2 OTDRs and accessories
- Pockets for accessory and cleaning material storage
- Compact and lightweight
- Shoulder strap

### ORDERING INFORMATION:

PART NO.	CAT. NO.	DESCRIPTION
52034541	20988	Soft Carry Case

### SPECIFICATIONS:

Weight: 500g
Dimensions: 380 x 185 x 180mm



# FIBER HAND TOOLS

## PROGRIP 5-IN-1 FIBER OPTIC STRIPPER

### FEATURES

- Precision ground stripping cavities for:
  - 2.0 - 2.4mm outer jacket
  - 2.0 - 3.0mm loose tube
  - 2.8 - 3.0mm outer jacket
  - 900µm buffer insulation
  - 900/125µm and 250/125µm buffer/acrylate
- Factory calibrated
- Dual-durometer ProGrips for improved comfort and control

### ORDERING INFORMATION:

PART NO.	CAT. NO.	DESCRIPTION
52055935	PA1171	Pro-Grip Stripper, 5-in-1 Fiber Optic

### SPECIFICATIONS:

Weight: 140g
Dimensions: 173mm



## PROGRIP 3-IN-1 FIBER OPTIC STRIPPER

### FEATURES

- Precision ground stripping cavities for:
  - 2.0mm outer jacket
  - 900µm buffer insulation
  - 250/125µm buffer/acrylate
- Factory calibrated
- Dual-durometer ProGrips for improved comfort and control

### ORDERING INFORMATION:

PART NO.	CAT. NO.	DESCRIPTION
52055938	PA1177	Pro-Grip Stripper, 3-in-1 Fiber Optic

### SPECIFICATIONS:

Weight: 130g
Dimensions: 160mm



## MIDSPAN SLITTER

### FEATURES

- The Mid Span Slitter is an efficient and indispensable tool for fiber optic cable termination.
- The sharp blade is made of super-alloy, suitable for longitudinal stripping of outdoor optical loose tube cable.
- The stripping opens the tube on upper and lower sides for easy access of the fiber.
- The Mid Span Slitter comes with 4 groove diameters. Select the proper groove, put in the loose tube, press the blade into the tube coating, close and clamp the two half grooves, and move the blade along the tube to strip.



### BENEFITS

- Small, light weight design for maximum portability
- Simple operation without any adjustments
- Provides easy access to fiber
- Super-alloy blade ensures precision and continued sharpness after multiple uses
- Four groove diameter options:  
( $\varnothing$  1.5- $\varnothing$  1.9mm) / ( $\varnothing$  2.0- $\varnothing$  2.4mm) / ( $\varnothing$  2.5- $\varnothing$  2.9mm) / ( $\varnothing$  3.0- $\varnothing$  3.3mm)

### ORDERING INFORMATION:

PART NO.	CAT. NO.	DESCRIPTION
52076413	05712	Sheath Slitter

### SPECIFICATIONS:

Weight: 30g
Dimensions: 50 x 40 x 25mm

## ECONOMY KEVLAR® CUTTER

### FEATURES

- Cut protective Kevlar® strands in fiber optic cable
- Hard-chromed serrated edges to easily cut through Kevlar®
- Comfortable handles with large finger openings

### ORDERING INFORMATION:

PART NO.	CAT. NO.	DESCRIPTION
52051283	PA1511	Kevlar® Cutter

### SPECIFICATIONS:

Weight: 60g
Dimensions: 197mm



## ECONOMY FIBER OPTIC STRIPPER

### FEATURES

- Pre-calibrated and factory set to ensure precision
- Rubber dipped handles
- Lock closure for safety and transport
- Strips 2.0 to 3.0mm fiber jacket, 900µm buffer and 125µm acrylate
- Spring loaded closure with distance stops

### ORDERING INFORMATION:

PART NO.	CAT. NO.	DESCRIPTION
52050605	PA1162	Stripper Fiber Optic 3-Level

### SPECIFICATIONS:

Weight: 86g
Length: 127mm



## UNIVERSAL SLITTER

### FEATURES

- Strips and slits 4.5-25mm diameter Round Cables
- Precision stripping and slitting of rubber, PVC, nylon and most insulation materials
- Adjustable depth of cut
- Circumferential, longitudinal and spiral cuts
- Cable is supported during use
- Cable support arm edge is used to pry off thick insulation
- Laser-trimmed, stainless-steel blade for long use
- A perfect tool for mid-point taps
- Spare blade included

### ORDERING INFORMATION:

PART NO.	CAT. NO.	DESCRIPTION
52050604	PA1822	Cable Slitter 4.5-25mm Inch Clamshell
52050563	PA2109	Replacement Blade (Qty 2)

### SPECIFICATIONS:

Weight 7 oz. (200g)
Length 5.7" (145mm)



## ROUND CABLE CUTTERS

### FEATURES

- To cut fiber outer cable jacket
- Cuts solid or stranded cable up to AWG 6
- Precise and effortless cuts
- Round cutting form minimises cable deformation
- Both are ideal for UTP and Coax, RG58, RG59 and RG6/6Q; Use PA1175 for RG7 and RG11

### ORDERING INFORMATION:

PART NO.	CAT. NO.	DESCRIPTION
52055936	PA1175	Pro-Grip Cutter, Contour Cable Cutter
52055940	PA1179	Pro-Grip Cutter, Dual Contour Cable Cutter



## POCKET PROBE PICK

### FEATURES

Probe pick for pulling wire, slicing, stripping cable and cleaning debris off terminal panels. Small and lightweight. Pen-sized with clip for carrying in pocket.

- Spudger tip
- Wire hook
- Wire stripper and slitting tooth
- Non-conductive scraping tip

### ORDERING INFORMATION:

PART NO.	CAT. NO.	DESCRIPTION
52049188	PA1915	Pocket Probe Pick/Blister

### SPECIFICATIONS:

Weight: 3oz. (86g)  
Dimensions: 6.5" (166mm)



## RING AND SLIT STRIPPER

### FEATURES

- Ring and Slit stripping for 1.2mm – 6.4mm fiber optic cables
- Easy fast adjustment for various cables diameters
- Ring Blade Kit TCCPS-RING-2 contains one blade, knob and pin
- Slit Blade Kit TCCPS-SLIT-2 contains one blade, lever and screw

### ORDERING INFORMATION:

PART NO.	CAT. NO.	DESCRIPTION
52085475	TCCPS	Cable Slit and Ring Stripper

### SPECIFICATIONS:

Weight: 0.05lbs (22g)  
Dimensions: 2.87" (72.9mm)



## DROP CABLE STRIPPER

### FEATURES

- Strips 8.1mm drop cables
- Provides midspan slit operation for 8.1mm drop cables
- Easy secure operation for quick stripping
- Replacement Blade Kit TCDCS-2 contains six individual blades



### ORDERING INFORMATION:

PART NO.	CAT. NO.	DESCRIPTION
52086521	TCDCS	Drop Cable Stripper

### SPECIFICATIONS:

Weight: 0.15lb (68g)
Dimensions: 3.26" (82.8mm)

## MULTI BIT DRIVER

### FEATURES

- Versatile multi-bit screwdriver, 6 tools in one
- Precision machined, hardened steel bits
- High-grade, rust resistant, chrome-plated finish
- Soft, cushioned grip for extra comfort and torque
- Lifetime limited warranty

\*\*Note: This is not an insulated tool



### ORDERING INFORMATION:

PART NO.	CAT. NO.	DESCRIPTION
52024842	SD-6-1	Multi Bit 6-in1 Driver

### SPECIFICATIONS:

Weight: 0.188 kg
Dimensions: Nutdriver 1/4" and 5/16"

## PA1180 NEEDLE NOSE PLIERS

### FEATURES

- Needle-nose with knurled surface for gripping, wrapping and looping
- Side cutter for AWG 19-26 copper
- Non-slip grips for precision control
- Stripping cavity for AWG 22 wire
- Crimp capacity:
  - UR: AWG 19-26
  - UY: AWG 22-26
  - UG: AWG 19-26



### ORDERING INFORMATION:

PART NO.	CAT. NO.	DESCRIPTION
52055941	PA1180	NEEDLE NOSE PLIERS

### SPECIFICATIONS:

Weight: 0.15lb (68g)
Dimensions: 3.26" (82.8mm)

## BARE FIBER ADAPTER

### FEATURES

- Popular SC type connector with PC ferrule
- Easy to clean
- Smooth fiber feed
- Temporarily connect to fiber under test
- 900 micron buffer compatible

### SPECIFICATIONS:

Ferrule diameter	2.5mm
Capillary diameter	Nominal -0 / +10um
Buffer diameter	250-900um
Fiber strip length	40mm



### ORDERING INFORMATION:

PART NO.	CAT. NO.	DESCRIPTION
52080175	BFA-1	Bare fiber Adapter Kit

## FIBER OPTIC SCRIBE

### FEATURES

- Pen-type scribe with screw-in non-reversible carbide tip
- Wedge shaped tip
- Pocket-clip
- Stainless steel barrel

### SPECIFICATIONS:

Weight	2oz (57g)
Length	5.25" (197mm)

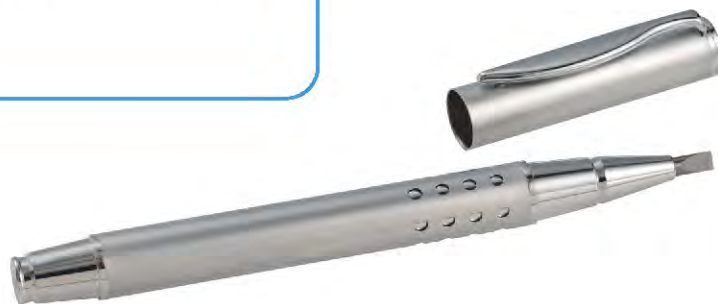

### ORDERING INFORMATION:

PART NO.	CAT. NO.	DESCRIPTION
52050965	PA1922-1	Fiber Optic Carbide Scribe

# FIBER TOOL KITS

The Tempo Communications Fiber Optic Tool Kits provides four kit options to satisfy varying tasks that the fiber optic technician may encounter. The tool kits contain all the common tools required to effectively and safely complete the job in an efficient manner.

Each tool kit is supplied in a rugged carry case to safely keep all tools organized for easy storage and retrieval for use. Extra pockets are incorporated to hold accessories and other tools. The FTK-B, Basic tool kit provides a variety of cutters, strippers and common handtools that the typical technician would use in their day to day activities. The FTK-P, Pro tool kit adds the 180XL visual fault locator for safe and quick visual identification of cut or damaged fiber, Macrobends and contaminated or damaged connectors.

The FTK-PP, Pro Plus tool kit adds the OPM210 optical power meter/visual fault locator to the FTK-B. This enables the technician to visually locate fiber and connector faults and to measure the absolute power in fiber networks.

The FTK-T, Termination kit provides all of the tools needed to quickly and effectively terminate fiber optic cables. The 915CL and 180XL are the key components along with a fiber stripper, side cutter and Kevlar shear.

## FTK-B BASIC TOOLS KITS

A basic tool kit allows the technician cut, strip and prepare fiber optic cables for termination.

### INCLUDES

- Kevlar Cutter
- 3-in-1 Fiber Optic Stripper
- Universal Slitter
- 6-in-1 Multi Tool
- Long Nose Pliers
- Fiber Optic Tool Case
- Side cutters
- Drop Cable Stripper
- Mid Span Slitter
- Ring and Slit Stripper



## FTK-P PRO TOOLS KIT

Same tools as the FTK-B but with a 180XL Visual Fault Locator (VFL) to visually locate faults and two fiber cleaning pens.

### INCLUDES

- Kevlar Cutter
- 3-in-1 Fiber Optic Stripper
- Universal Slitter
- 6-in-1 Multi Tool
- Visual Fault Locator
- Long Nose Pliers
- Fiber Optic Tool Case
- Side cutters
- Drop Cable Stripper
- Mid Span Slitter
- Ring and Slit Stripper
- 2.5mm Fiber Cleaning Pen
- 1.25mm Fiber Cleaning Pen





## FTK-PP PRO PLUS TOOLS KIT

Same tools as the FTK-P but with a Micro OPM which has an Optical Power Meter (OPM) and Visual Fault Locator (VFL). The OPM can be used to measure optical power, perform loss testing and to sense tones present on the fiber. The VFL can be used to visually locate faults and to test mechanical connectors.

### INCLUDES

- Kevlar Cutter
- 3-in-1 Fiber Optic Stripper
- Universal Slitter
- 6-in-1 Multi Tool
- Micro OPM
- Long Nose Pliers
- Fiber Optic Tool Case
- Side cutters
- Drop Cable Stripper
- Mid Span Slitter
- Ring and Slit Stripper
- 2.5mm Fiber Cleaning Pen
- 1.25mm Fiber Cleaning Pen



## FTK-T TERMINATION TOOLS KIT

Contains all of the tools needed to terminate fiber optic cables with a mechanical connector

### INCLUDES

- Kevlar Cutter
- 3-in-1 Fiber Optic Stripper
- 915CL Cleaver
- Fiber Optic Tool Case
- Visual Fault Locator
- Side Cutter





## ORDERING INFORMATION:

PART NO.	CAT. NO.	DESCRIPTION
52086508	FTK-B	Basic Fiber Tool Kit
52086509	FTK-P	Pro Fiber Tool Kit
52086510	FTK-PP	Pro Plus Fiber Tool Kit
52086866	FTK-T	Termination Fiber Tool Kit

## INDIVIDUAL TOOL FROM KITS:

PART NO.	CAT. NO.	DESCRIPTION
52051283	PA1511	Kevlar Cutter
52055938	PA1177	3-in-1 Fiber Optic Stripper
52050604	PA1822	Universal Slitter
52024842	TCBMD	6-in1 Multi Tool
55500025	OPM210	Standard Power OPM with VFL
52055941	PA1180	Long Nose Pliers
52085476	FIBKIT CASE	Fiber Optic Tool Case
52055936	PA1175	Side cutters
52086521	TCDCS	Drop Cable Stripper
52076413	MSS100	Mid Span Slitter
52085475	TCCPS	Ring and Slit Stripper
52068671	180XL	Visual Fault Locator

## OTHER TOOLS AVAILABLE:

PART NO.	CAT. NO.	DESCRIPTION
52087221	FCL100	Field Fiber Optic Cleaver
52082727	920CL	920CL Optical Fiber Cleaver
52080175	BFA-1	Bare Fiber Adapter
52050560	PA1820	AM25 Slitter (0.18" - 1.0")
52050561	PA1821	AM35 Slitter (1.0" - 1.4")
52050605	PA1162	Economy Stripper
52049188	PA1915	Pocket Probe / Pick
52050965	PA1922-1	Fiber Optic Carbide Scribe

## REPLACEMENT BLADES FOR STRIPPING TOOLS:

PART NO.	CAT. NO.	DESCRIPTION
52086502	TCDCS-2	DROP CABLE STRIPPER BLADE KIT (six blades)
52086503	TCCPS-RING-2	CPS RING BLADE KIT (one replacement blade with hardware)
52086504	TCCPS-SLIT-2	CPS SLIT BLADE KIT (one replacement blade with hardware)

# OPTICAL WAVELENGTH SPLITTER

Wavelength division multiplexing (WDM) is a technology or technique modulating numerous data streams, i.e. optical carrier signals of varying wavelengths (colours) of laser light, onto a single optical fiber.

Our Optical Wavelength Splitter (OWS200) allows any technician, who has a standard OPM (Optical Power Meter) to be able to measure signal levels in WDM networks.

The OWS200 “splits” multiplexed wavelengths, found in NGPON2 networks allowing specific wavelengths to be measured with a conventional optical power meter such as the OPM510.

## FEATURES

- High accuracy to measure specific channel wavelengths
- Eliminates the need for expensive DWDM power meters
- Wavelength configurable for specific customer equipment
- Configurable for 2, 4 and 8 wavelengths
- Low loss
- SC/APC connections
- Low return loss will not disrupt network
- Compact design
- Convenient lanyard to securely hold

## ORDERING INFORMATION:

PART NO.	CAT. NO.	DESCRIPTION
55500164	OWS201	OWS 1490 & 1570nm
55500166	OWS202	OWS 1490 & 1577nm



# DROP FIBER REPAIR KIT

The Drop Fiber Repair Kit is used to facilitate repairs of fiber optic cables. Common fiber sizes of 8.1mm, 5.4mm and 5.1mm rectangular cables and 5.1mm round cables are accommodated with the supplies sealing gaskets. Both fusion splices (total of 12) and mechanical splices are securely positioned within the IP67 rated enclosure. The enclosure can be permanently buried, mounted on to the side of a building or can be mounted onto a pole utilizing the integrated pole mounting brackets.

## FEATURES

- Allows technician to repair drop cables in FT Tx applications
- Direct bury, wall mount or pole mount
- Fusion splice or mechanical splice
- Up to fourteen fiber capacity
- Two are required due to no slack and damage to cable
- IP67 rated
- Integrated tabs to position and hold fibers in place
- Common fiber sizes of 8.1mm, 5.4mm and 5.1mm rectangular cables and 5.1mm round cables
- Kit contents:
  - Enclosure
  - Two mechanical splices
  - Two gaskets for each of the fiber sizes



## INDIVIDUAL GASKET FOR EACH CABLE SIZE:



8.1mm Rectangular



5.1mm & 5.4mm Rectangular



5.1mm Round

## COMPONENT PARTS:

PART	QTY
Case Top	1
Case Bottom	1
8.1mm Rectangular Cable Gasket	2
5.1mm & 5.4mm Rectangular Cable Gasket	2
5.1mm Round Cable Gasket	2
Mechanical Splice	2

## STRUCTURE:

### EXAMPLE OF FIBER OPTIC SPLICE

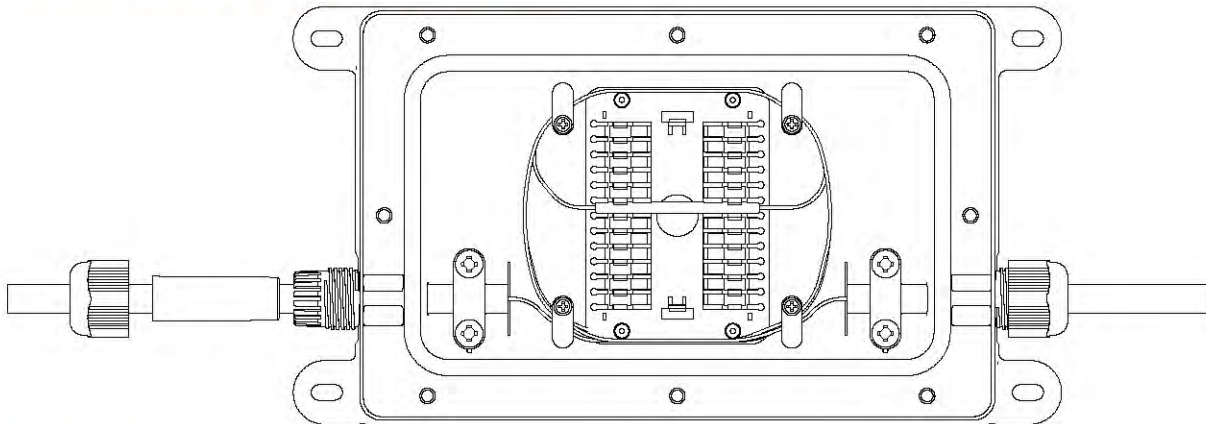

## SPECIFICATIONS:

Size	160.0 x 95.0 x 32.5mm
Material	ABS with Polycarbonate (UV resistant)
Cable Size	5.1mm, 5.4mm & 8.1mm rectangular & 5.1mm round
Mechanical Splice Locations	Two
Fusion Splice Locations	Twelve (3 x 60mm)
IP Rating	IP67
Weight	0.115kg
Color	Black
Operating Temperature	-40 to +80C
Storage Temperature	-40 to +80C

## ORDERING INFORMATION:

PART NO.	CAT. NO.	DESCRIPTION
55500211	DFR100	Drop Fiber Repair Kit

# EML100 ELECTRONIC MARKER LOCATOR

Tempo have introduced the 92 kHz markers, targeted at marking fiber optic cable installations, in response to requests from telecom companies who wish to differentiate their ducts carrying copper communication cables from those carrying fiber optic communication cables. It has also been found in practice that installing metallic tracer wires or tapes alongside or in fiber optic ducts is unreliable; they rarely have proper continuity for the whole duct length, often found corroded or not connected at joints.

Tempo Communications' Marker-Mate electronic marker locator along with, OmniMarker and Spike Marker buried electronic markers form a complete solution for marking and locating buried utilities and other devices to depths of at least 1.5m. Ideally suited to marking fiber optic ducts that, without metallic elements, are otherwise difficult to pinpoint.

## FEATURES

- Detects up to nine different marker types
- Rapid switching between scan and single modes
- Digital signal processor accuracy
- Bar graph, numeric & audible signal strength indicators
- Headphone jack
- Low battery warning
- Weather resistant
- Scan mode provides simultaneous detection of all marker types
- User-adjustable Detection Threshold
- Large-character display
- Adjustable speaker volume
- Battery level indicator
- Adjustable time out feature
- Rugged construction

## ORDERING INFORMATION:

PART NO.	CAT. NO.	DESCRIPTION
50607984	EML100	Electronic Marker Locator
52085007	OM-02	OmniMarker II, CATV
52085016	OM-04	OmniMarker II, Fiber Optic
52085015	OM-07	OmniMarker II, Europower
55500096	SM-02	SPIKE MARKER ORANGE-BLACK 77 KHZ CATV (50 PACK)
55500097	SM-03	SPIKE MARKER YELLOW 83 KHZ GAS (50 PACK)
55500101	SM-08	SPIKE MARKER BLUE 145 KHZ WATER (50 PACK)

GENERAL	
Housing Material	High density welded polyethylene
Identification	Solid moulded colour and moulded text
Detection Range	1.5m typical for all models (using Tempo EML-100 or RDB000MRX)
Detection Offset	15cm maximum at 1.5m
ELECTRICAL	
Detection Field	Vertical Dipole (OmniMarker II model)
Frequency Tolerance	± 0.35 %
MECHANICAL	
Overall Diameter	100mm max
Anchoring	Two "tie down" loops along flange.
Length	128mm



# SACRIFICIAL CONNECTORS

The sacrificial connector is used to protect the optical port of fiber optic test equipment and instruments. The sacrificial connector ensures that repeated mating's have no detrimental effect on the optical port (bulkhead) which can lead to reflectivity and insertion loss issues.

A damaged bulkhead is expensive to repair and will take the instrument out of commission. A sacrificial connector, on the other hand, can be replaced when worn or damaged and a new sacrificial connector installed. With near 0dB loss through this connector, there is no impact on the test results.

## FEATURES

- Prevents damage to instrument and equipment bulkheads
- Low insertion loss
- Low reflectance
- GR326 / IEC61300-2 compliant
- GR910/ UV94-VO compliant
- RoHS compliant

## ORDERING INFORMATION:

PART NO.	CAT. NO.	DESCRIPTION
55500159	ZDBSCA	Zero dB SC/APC
55500160	ZDBSCU	Zero dB SC/UPC
55500161	ZDBSCAU	Zero dB SC/APC (M) -SC/UPC (F)
55500163	ZDBSCUA	Zero dB SC/APC (F) -SC/UPC (M)

## SPECIFICATIONS:

Fiber Type:	Single Mode	
Operating Wavelength:	1310nm & 1550nm	
Ferrule Type:	PC	APC
Maximum Insertion Loss:	0.5dB	
Return Loss:	≥40dB	≥55dB
Maximum Optical Power:	≤500mW	
Operating Temperature:	-40 - +70°C	
Storage Temperature:	-40 - +70°C	

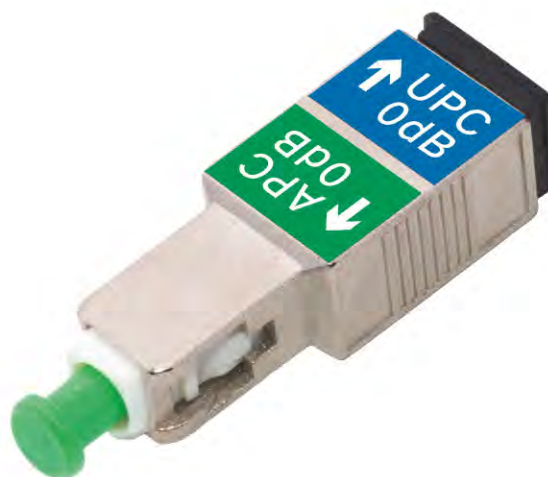

# MAINTENANCE

## OF FSP200, 915FS, FCL200, 915CL AND 920CL

- Turn off splicer.
- Use lint free swabs.
- Do not touch the electrodes.
- Never use compressed air.
- Use the cleaning brush only to clean debris from general working area, never on the lenses, V-grooves or mirrors.

### V-GROOVES (RECOMMENDED DAILY). SEE FIGURE 1.

Clean the bottom of the V-groove using 99% pure isopropyl alcohol and a lint free swab.

#### Fiber Clamps (Recommended Daily)

If contaminants are present on the clamps, proper clamping may not occur resulting in poor quality splices. The fiber clamps should be frequently inspected and periodically cleaned during normal operation. To clean the fiber clamps do the following:

- Clean the surface of the clamps with 99% pure isopropyl alcohol and a lint free swab.

### WIND PROTECTOR MIRRORS (RECOMMENDED DAILY ON 910FS). SEE FIGURE 2.

If the wind protector mirrors become dirty, the fiber core position may be incorrect due to decreased optical path clarity, resulting in higher splice loss. To clean the mirror's, do the following:

- i. Clean the mirror surface using 99% pure isopropyl alcohol and a lint free swab.
- ii. Mirror should look clean with no streaks or smudges.

### OBJECTIVE LENSES (RECOMMENDED WEEKLY). SEE FIGURE 3.

If the objective lens' surface becomes dirty, normal observation of the core position may be incorrect, resulting in higher splice loss or poor splicer operation. Therefore, clean both of them at regular intervals. Otherwise, dirt may accumulate and become impossible to remove.

To clean the objective lenses do the following:

- i. Before cleaning the objective lenses, always turn off the splicer.
- ii. Gently clean the lenses' (X-axis and Y-axis) surface with a dry lint free swab. Using the swab, start at the centre of the lens and move the swab in a circular motion until you spiral out to the edge of the lens surface.
- iii. The lens surface should be clean and free of streaks or smudges.
- iv. Turn on the power and make sure no smudges or streaks are visible on the monitor screen. Press X/Y key to change the screen and check the state of the lens surface on both the X- and Y-screens.

#### NOTE:

Do not touch the electrodes when cleaning.

It is recommended to clean the objective lenses when replacing the electrodes.

#### General Fusion Splicer Cleaning (Recommended Daily)

Use the cleaning brush only to clean debris from general working area, never on the lenses, V-grooves or mirrors.

Periodically clean the fiber adapters with 99% isopropyl alcohol and a lint free swab. Never touch the fiber clamping area of the fiber adapters.

### GENERAL FUSION SPLICER CLEANING (RECOMMENDED DAILY)

Use the cleaning brush only to clean debris from general working area, never on the lenses, V-grooves or mirrors. Periodically clean the fiber adapters with 99% isopropyl alcohol and a lint free swab.

Never touch the fiber clamping area of the fiber adapters.

### CLEANING FIBER CLEAVER (RECOMMENDED DAILY)

If the circular blade or clamp pads of the fiber cleaver become contaminated, the cleaving quality could degrade. This may lead to fiber surface or end-face contamination, resulting in higher splice loss. Clean the edge of the circular cleaving blade and clamp pads with a lint free swab using 99% pure isopropyl alcohol.

FIGURE 1



Clean V-Groove daily

FIGURE 2



Mirror cleaning in lid

FIGURE 3



Objective Lens

\*The above procedures are also recommended for the 910FS and 910CL



# OPTICAL POWER METER CALIBRATION GLOSSARY

## **ABSOLUTE POWER STANDARDS:**

The reference photodetectors maintained by the National Institute of Standards and Technology (N.I.S.T.) in Boulder, Colorado. These reference photodetectors are used to transfer optical power calibration to two sets of Secondary Standards maintained by Tempo Communications Ltd.

## **ACTIVE SET OF SECONDARY STANDARDS/ACTIVE SECONDARY STANDARD:**

The most recently calibrated set of Secondary Standards, which are used to calibrate Working Standards used on the production floor. An Active Secondary Standard is one of the photodetectors in the Active Set of Secondary Standards.

## **ADAPTER:**

A mechanical device enabling the coupling and uncoupling of a connector. A bulkhead adapter is used to couple two terminated cable ends. An interface adapter is used to connect a cable to a light source, photodetector, or other device.

## **AGING OF STANDARDS:**

A gradual deviation from specifications due to wear and the deterioration of associated electronic components.

## **ANSI CERTIFICATE OF CALIBRATION:**

A Certificate of Calibration (see below) that includes additional information specified by American National Standards Institute document ANSI/NCSL Z540. In addition to manufacturer, performance, and traceability information, an ANSI Certificate of Calibration must include the name and address of the customer and a detailed description of the methods and Working Standards used to perform the calibration. The calibration status of the Working Standards used must also be documented. Furthermore, an ANSI Certificate of Calibration must include a statement that the certificate or report may not be reproduced, except in full, without written permission from the calibration laboratory.

## **BACKUP SET OF SECONDARY STANDARDS/BACKUP SECONDARY STANDARD:**

The set of Secondary Standards with calibration older than one year, but not exceeding two years. The calibration points of the Backup Set of Secondary Standards are compared to the Active Set at monthly intervals to verify the accuracy of the latter. A Backup Secondary Standard is one of the photodetectors in the Backup Set of Secondary Standards.

## **CALIBRATION CONDITIONS:**

The specific conditions under which a calibration factor is associated with a calibration wavelength. The calibration conditions typically include the centre wavelength and acceptable spectral deviation of the laser source in use; the output power of the laser source; the reference cable type and length; the type of connectors used to terminate the reference cable, including the manufacturer; the interface adapter used; and the ambient temperature and humidity conditions.

## **CALIBRATION FACTOR:**

A number used to correlate the response of a photodetector in a manufactured instrument with the photodetector response of a Secondary Standard or Working Standard. In instruments manufactured by Tempo calibration factors are stored in non-volatile memory, and defined for each calibration wavelength.

## **CALIBRATION WAVELENGTH:**

A specifically defined wavelength used during the point calibration of a manufactured instrument. The absolute accuracy of measurements performed at other than the calibration wavelength may vary, depending on the response linearity of the photodetector incorporated in the instrument at that wavelength. Calibration wavelengths are listed below:

### **CERTIFICATE OF CALIBRATION:**

A document certifying that a manufactured instrument has been calibrated or re-calibrated to conform to published specifications, and that the calibration is traceable to an established standards bureau, i.e., the N.I.S.T. A Certificate of Calibration includes the following: the name and address of the manufacturer; the model number and description of the instrument; the instrument serial number; the condition in which the instrument was received and returned, i.e., within tolerance, out of tolerance, or non-operational; the calibration date, interval, and due date for re-calibration; the conditions under which the instrument was calibrated; the procedures used to perform the calibration; the identity of the calibration technician; and a signature of an authorized representative of the manufacturer.

### **CONNECTOR:**

A mechanical device that allows an optical fiber or cable to be repeatedly coupled or uncoupled from an interface or another cable. An optical fiber fitted with connectors is said to be connectorised or terminated.

### **CONNECTOR REPEATABILITY:**

The ability of a connector to be mated and unmated repeatedly without affecting its attenuation, return loss and other performance specifications. A lack of repeatability is usually attributable to the inability of a connector to maintain accurate and consistent alignment of the cores of the optical fibers.

### **FIBER OPTIC CABLE:**

An optical fiber, multiple fibers, or fiber bundles, which may include a jacket and strength members (kevlar, steel, or other materials), fabricated to meet optical, mechanical, and environmental specifications.

### **LINEARITY:**

The ability of a photodetector to generate electrical current in amounts proportional to the incident wavelength and intensity of light.

### **PHOTODETECTOR:**

A semiconductor device that converts light energy into an electrical current. The conversion of light energy into electrical current is, in principle, proportional and linear with the incident power, which is expressed in Watts. The conversion ratio of a photodetector is dependent on the wavelength of the light received, therefore, this wavelength must be precisely defined for a point calibration (see below) to be valid.

### **POINT CALIBRATION:**

The correlation of electrical current produced by a photodetector, quantified in Amps, with an incident power of light energy, expressed in Watts, at a single defined wavelength. This photodetector response is expressed in Amps-per-Watt (A/W)

### **SECONDARY STANDARDS:**

The reference photodetectors maintained by Tempo Secondary Standards are calibrated at regular intervals by the N.I.S.T. using the Absolute Power Standards maintained by the Institute. Tempo maintains two sets of Secondary Standards, each set containing one reference photodetector of Si and InGaAs composition. Each set of Secondary Standards alternates as Active and Backup at one-year intervals.

### **SPECTRAL DEVIATION:**

The difference between the actual output wavelength of a light source and its specified wavelength. Spectral deviation is usually attributable to manufacturing tolerances.

### **UNCERTAINTY:**

The margin of error for a calibration or measurement attributable to external causes, such as connector repeatability, ambient temperature, back-reflections, or spectral deviation from a defined calibration wavelength. Uncertainty will cause slight variations in optical power measurements unless the conditions and equipment used are identical to those employed during the calibration of the instrument. Uncertainty is typically expressed in percent (%).

### **WORKING STANDARDS:**

A set of reference optical power meters incorporating photodetectors of Si or InGaAs composition that are calibrated using an Active Secondary Standard. These reference optical power meters are used to perform a point calibration of manufactured instruments at specified wavelengths.

# INSERTION LOSS MEASUREMENT

## WHAT IS INSERTION LOSS?

An insertion loss (IL) measurement characterizes the light loss through a component or connection.

There are two accepted methods for measuring insertion loss, both of which may be found in reference document FOTP-171, published by the Electronic Industry Association (EIA).

Insertion loss measurements require a light source, an optical power meter, and a patch cable manufactured to precise tolerances, known as a reference cable.

In general, an insertion loss measurement is a two step process:

- 1) Establish a baseline power level measurement for the light source and reference cable in use. This is referred to as "referencing" or "calibration."
- 2) Connect the device under test and measure the difference between the measured power and the Reference power.

## INSERTION LOSS MEASUREMENTS

To measure the insertion loss of a connector/cable, do the following:

**STEP 1:** Connect an appropriate Tempo LED or laser source to the optical power meter using a suitable reference cable. The reference cable should be 2 to 3 meters in length. See the illustration.

**STEP 2:** Make sure the source is in continuous wave (CW) output mode. Set the optical power meter to the output wavelength of the source using the [λ] key and to dBm units using the [dBm] key. Note that the dBm output from the reference cable should be within acceptable limits.

**STEP 3:** Store the reference power level by pressing the [Rel] key for a few seconds. The main numerical display should read 00.00 dB.

**STEP 4:** Disconnect the reference cable from the optical power meter and insert the cable to be tested using an appropriate bulkhead adapter.

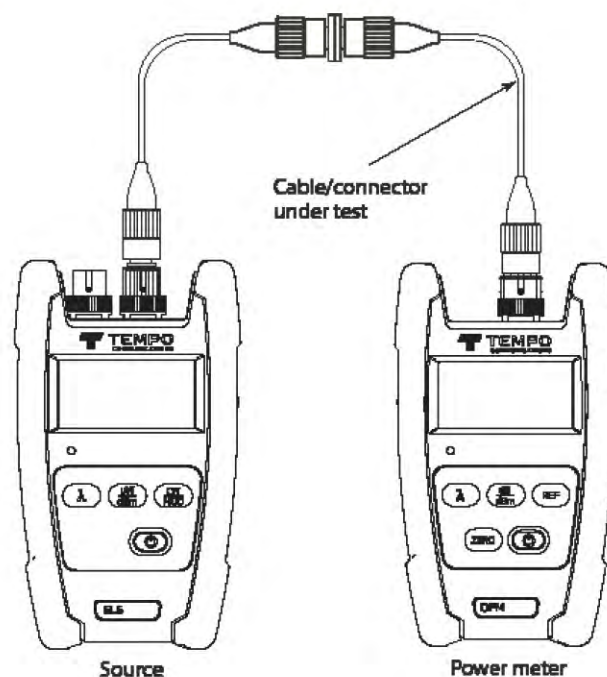

## ABOUT dB, dBm, and WATTS

Fiber optic measurements are performed using decibel (dB) units.

The decibel is a logarithmic, relative, dimensionless unit it gives no indication of the absolute power level. Loss is always indicated using a minus (-) sign, and a gain is indicated by a plus (+) sign. Because dB units are relative and dimensionless, a correlation with an absolute unit of measure must be established to be useful. To indicate absolute power, logarithmic decibel units are referenced to linear Watt units: 0dBm = 1 milliwatt (mW).

To convert Watt units to dBm, the following formula is used:  $P = 10 \log \left( \frac{P_x}{1mW} \right) dBm$

The table on the right illustrates the relationship between absolute logarithmic dBm units and absolute linear Watt units: Absolute logarithmic dBm [P] Absolute linear Watts [Px]

dBm (P)	WATTS (Px)
+10dBm	10mW
+3dBm	2mW
0dBm	1mW
-3dBm	0.5mW
-10dBm	100µW
-20dBm	10µW
-30dBm	1µW
-40dBm	100nW
-50dBm	10nW
-60dBm	1nW
-70dBm	100pW
-80dBm	10pW
-90dBm	1pW

# RETURN LOSS

## MEASUREMENT METHODS

### WHAT IS RETURN LOSS?

A return loss measurement characterises the strength of a reflection produced by variations in the refractive index along a fiber optic link, known as a back-reflection or Fresnel reflection. Quantified in decibel (dB) units, return loss is the logarithmic expression of the ratio of the reflected power over the incident power, that is, the intensity of light reflected back to the return loss meter over the intensity of the light injected into the fiber, expressed as a positive number.

If not controlled, back-reflections can degrade the performance of a fiber optic system by interfering with the operation of the laser transmitter, or by generating noise at the receiver.

A common source of back-reflections is the junction where two fiber optic connectors are mated. Because of this, a connector with high return loss, which sends very weak reflections back to the transmitter, is superior to a connector with low return loss that sends back strong reflections. When measuring connectors, extremely low return loss values usually indicate a defect, such as core misalignment, poor fiber end-face contact, scratches, breaks, or end-face contamination.

### RETURN LOSS MEASUREMENT METHODS

#### OPTICAL TIME DOMAIN REFLECTOMETER (OTDR) METHOD

An Optical Time Domain Reflectometer (OTDR) launches a train of light pulses into the device under test and collects backscatter information as well as superimposed Fresnel reflections. The OTDR is optimised to accurately measure loss-per-distance based on the received backscatter level. An OTDR also gives an estimation of the strength of a reflection at a given distance based on its peak height.

#### RETURN LOSS DEFINED

Reflections—or more specifically Fresnel reflections—occur at the boundary between two media with different refractive indices. The percentage of the light reflected can be calculated if the refractive indices of both media are known.

The most commonly known percentage of reflected power, the 4% reflection, is caused by a glass-to-air boundary. Reflectance in general is the ratio of reflected power to incident power. When knowledge of a reflection at a discrete point is important, the term reflectance is preferred. Reflectance is expressed in negative decibels (dB). Optical return loss (ORL), often referred to as return loss, describes the ratio of reflected power over the incident power of a system as a whole. Similar in concept to reflectance, return loss is also expressed in decibels.







**North America**

1.800.642.2155

**Latin America**

1.760.510.0558

**EMEA**

+44 (0) 1633.927.050

FOR PRODUCT VIDEOS,  
DEMONSTRATIONS & MORE, VISIT:

**TEMPOCOM.COM**

1390 Aspen Way Vista, CA • 92081

©2020 Tempo Communications Inc. • An ISO 9001 Company

**EMEA Address: Tempo Europe Limited**

Brecon House • William Brown Close • Cwmbran • NP44 3AB • UK

**01.07.2021 REV 10**