



QUICK LINKS

[Table of Contents](#)

[Premises Cable](#)

[OSP Cable](#)

[FTTP](#)

[Wireless](#)

[Technical Info](#)

[Part Number Index](#)

Edition 13

UPDATED: September 21, 2015



COMMUNICATIONS PRODUCTS
PREMISES | OSP | FTTP | WIRELESS

SuperiorEssex.com





About Superior Essex

Superior Essex International LP is a global leader in the design, manufacture, and supply of communications and energy cable products for indoor and outdoor applications. We offer a broad communications portfolio including premises optical fiber and copper cables, Outside Plant (OSP) cables, Fiber-to-the-Premises (FTTP) closures and enclosures, Fire Alarm and Security (FAS) cables, and Wireless cables and accessories. With over eighty years serving the communications and energy markets, we have cultivated a solid reputation as the preferred supplier of high-performance cabling for major communications service providers, leading enterprises, universities, hospitals, military facilities and businesses that rely on our innovative solutions to meet the demands of their evolving networks.



OUR COMMITMENTS TO TRANSPARENCY AND SUSTAINABILITY

Superior Essex is firmly committed to environmental responsibility and transparency, and we constantly strive to lead innovation and design toward sustainable product solutions.



We are the first wire and telecommunications cable manufacturer to conduct an independent full Life Cycle Assessment examining the environmental impact of our high performance copper and optical fiber data cabling products, including our raw materials, manufacturing, transportation, installation, and end of life practices.



We are also the first in our industry to contribute toward LEED certification by offering Environmental Product Declarations (EPD) and Health Product Declarations™ (HPD™) for our premises copper and optical fiber cable products. Additionally, we offer Multi-Attribute Certifications for our premises copper products, which provide transparency into our manufacturing processes and help government procurement agents meet their sustainability goals by simplifying the sustainable supplier selection process.



As the first and only sustainable and transparent cable manufacturer, we are the preferred choice for all enterprises relying on sustainable cabling solutions.

UL and the related logo are registered trademarks of UL LLC. Health Product Declaration, HPD and the related logo are trademarks of Health Product Declaration Collaborative. GreenCircle Certified logo is a registered trademark of GreenCircle Certified, LLC. USGBC and the related logo are registered trademarks of U.S. Green Building Council.



PROVIDING QUALITY, EXPERIENCE AND EXPERTISE

Superior Essex has TL 9000 and ISO 9001:2001 certification in every communications production facility, assuring a level of quality and consistency in both products and customer service. We also manufacture custom products with special requirements, so our Product Management team can quote and deliver unique designs that are tailored for your applications. Beyond our quality assurance, value, and flexibility, we guarantee on-time delivery of the products you request.



PREMISES CABLE

Superior Essex Premises cables offer better performance, higher quality, and the best overall value, saving you both time and money. From our 10Gain® XP CAT 6A to our CAT 3 voice and data cables, to our Coaxial cables and our multimode and single mode optical fiber cables, we offer a broad portfolio of products that are essential for high-bandwidth applications.

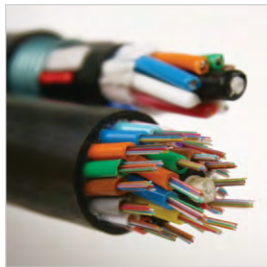

OUTSIDE PLANT WIRE AND CABLE

Superior Essex is one of the world's leading producers of OSP copper wire and optical fiber communications cables. With more than 4,000 different designs available, including Broadband, Composite, Fiber, and Copper Wire. This extensive line of products serves virtually every application for direct burial, aerial, and high risk installations.



FIBER-TO-THE-PREMISES (FTTP) HARDWARE

Our FTTP Hardware product line is based upon the widely-deployed LS product line. We have modified our FTTP Hardware for U.S. and Canadian markets, providing our customers with a portfolio designed and engineered to exceed durability and ruggedness of competitor products. Expedite your installations with products that are easy to order, easy to install, and easy to maintain.

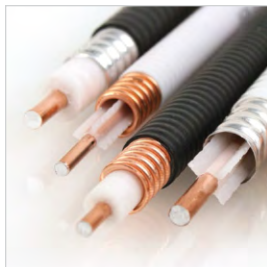

WIRELESS

Wireless technology is becoming the primary communication method, so it is crucial to choose products that have exceptional quality and performance, allowing for better coverage and capacity. All of our Radio Frequency (RF) transmission and Distributed Antenna Systems (DAS) products provide an all-encompassing selection for the growing demands of wireless expansion for commercial wireless cell tower and in-building infrastructures.

Table of Contents

PREMISES FIBER CABLE

Simplex, Duplex and Quad Interconnect OFNR/OFNP	A-2
Microarray Data Center Interconnect OFNR/OFNP	A-4
2 mm Microarray Breakout OFNP	A-6
Interlock Armored, 2mm Microarray Breakout OFCP	A-7
3 mm Microarray Breakout OFNR/OFNP	A-8
Interlock Armored, 3 mm Microarray Breakout OFCR/OFCP	A-10
Indoor/Outdoor, Loose Tube OFNR/OFNP	A-12
Breakout OFNR	A-14
Single Unit Distribution OFNR/OFNP	A-16
Multi-Unit Distribution OFNR/OFNP	A-18
Ribbon Distribution OFNR/OFNP	A-20
Compact and Rugged Indoor MDU OFNR	A-22
Rugged Indoor/Outdoor MDU OFNR	A-23
Indoor/Outdoor Sunlight Resistant OFNP	A-24
Dry Block, Sunlight Resistant, Indoor/Outdoor, Tight Buffer OFNR	A-26
Dry Block, Sunlight Resistant, Indoor/Outdoor OFNP	A-28
Hybrid Premises Fiber OFNR/OFNP	A-30
Interlock Armored, Tight Buffer OFCR/OFCP	A-32
Indoor/Outdoor, Interlock Armored, Tight Buffer OFCR/OFCP	A-34

PREMISES COMPOSITE CABLE

Bundled Composite Category 6 CMR	A-36
Bundled Composite Category 5e CMR	A-37
Residential Broadband Riser	
Coax RG-6 Quad Shield, Category 6 and Optical Fiber	A-38
Residential Broadband Riser	
Coax RG-6 Quad Shield, Category 5e and Optical Fiber	A-39

PREMISES COPPER CABLE

10Gain® XP Category 6A CMR/CMP	A-40
10Gain® Category 6A CMR/CMP	A-42
Category 6A U/FTP (STP) CMR/CMP	A-44
Category 6A U/FTP (STP) with FEP Jacket CMP	A-46
Category 6A F/UTP (ScTP) CMR/CMP	A-48
NextGain® Category 6eX CMR/CMP	A-50
DataGain® Category 6+ CMR/CMP	A-52
Category 6+ LSHF CMR	A-54
Category 6+ F/UTP (ScTP) CMR/CMP	A-56
Category 6 CMR/CMP	A-58
Category 6 CM	A-60
Category 6 with FEP Jacket CMP	A-62
Category 6 CMR/CMX Outdoor Sunlight Resistant	A-64
Category 6 CMR/CMX Outdoor	A-66
Cobra Category 5e+ CMR/CMP	A-68
Category 5e+ F/UTP (ScTP) CMR/CMP	A-70
PowerWise™ Category 5e+ CMR/CMP	A-72
Marathon LAN® Category 5e CMR/CMP	A-74
Category 5e LSZH CM	A-76
Category 5e CM	A-77
Category 5e CMR/CMX Outdoor Sunlight Resistant	A-78
Category 5e CMR/CMX Outdoor	A-80
Category 5e F/UTP (ScTP) CMR/CMX Outdoor Sunlight Resistant	A-82
Category 5e F/UTP (ScTP) CMR/CMX Outdoor	A-84
6-Pair Category 5e CMR	A-86
25-Pair Power Sum Category 5e CMR/CMP	A-87
25-Pair Category 5e Indoor/Outdoor	A-88
Interlock Armored Premises Copper CMR	A-89
Bundled Category 6	A-90
Bundled Category 5e	A-91
OSP Broadband BBD	A-92
OSP Broadband BBDN	A-93
OSP Broadband BBDG	A-94
OSP Broadband Indoor/Outdoor Halogen-Free CM/CMX	A-95
OSP Broadband Duplex	A-96

PREMISES COPPER CABLE CONTINUED...

MEGAPIC® OSP Broadband Backbone Category 5	A-97
Category 3 CMR/CMP 2-Pair - 400-Pair	A-98
Category 3 Station Wire CMR/CMX Outdoor	A-100
ARMM Series CMR	A-102
Coax RG-6, Quad Shield	
CM/CATV, CMR/CATVR, CMP/CL2P, Interlock Armored CMR	A-104
Coax RG-6, 80% Shield CMP/CL2P	A-106
Coax RG-6, Tri-Shield 70% CM/CMR	A-107
Coax RG-6, 60% Shield CM	A-108
Coax RG-59, 95% Shield CMR/CL2R, CMP/CL2P	A-110
Coax RG-59, 95% Shield + 18/2 CMP/CL2P	A-111
Fire Alarm, Non-Shielded Power Limited, Riser/Plenum	A-112
Fire Alarm, Shielded Power Limited, Riser/Plenum	A-114
Interlock Armored Fire Alarm Riser	A-116
Security Control, Non-Shielded Power Limited, Riser/Plenum	A-118
Security Control, Shielded Power Limited, Riser/Plenum	A-120
Access Control Composite Riser/Plenum	A-122

CENTRAL OFFICE COPPER CABLE

ABAM (600B) and ABMM Series	A-124
1249C Series	A-125
1161A Series Category 3	A-126
600C Series	A-127
25-Pair Category 5e Shielded CMR	A-128
Switchboard 100 Ohm	A-130
Switchboard 100 Ohm 200A/800A Series (Canadian Color Code)	A-132
T100 Series	A-133
Switchboard 85 and Shielded Switchboard 85	A-134
Distribution Frame Wire DFW	A-135
Heavy Duty Distribution Frame Wire HD-DFW	A-136
Tight Twist Distribution Frame Wire DFW	A-137

OSP FIBER CABLE

Dri-Lite® Loose Tube Single Jacket All Dielectric Series 11D	B-2
Dri-Lite® Loose Tube Double Jacket Non-Armor Series 1GD	B-3
Dri-Lite® Loose Tube Single Jacket Single Armor Series 12D	B-4
Dri-Lite® Loose Tube Double Jacket Single Armor Series 1AD	B-5
Dri-Lite® Loose Tube Double Jacket Double Armor Series 1DD	B-6
Dri-Lite® Loose Tube Triple Jacket Double Armor Series 1CD	B-7
Loose Tube Single Jacket All Dielectric Series 11	B-8
Loose Tube Double Jacket Non-Armor Series 1G	B-9
Loose Tube Single Jacket Single Armor Series 12	B-10
Loose Tube Double Jacket Single Armor Series 1A	B-11
Loose Tube Double Jacket Double Armor Series 1D	B-12
Loose Tube Triple Jacket Double Armor Series 1C	B-13
Dri-Lite® Loose Tube Single Jacket Self Support Series 11DM	B-14
Dri-Lite® Loose Tube Double Jacket Self Support Series 1GDM	B-15
Dri-Lite® Loose Tube Single Jacket Single Armor Self Support Series 12DM	B-16
Dri-Lite® Loose Tube Double Jacket Single Armor Self Support Series 1ADM	B-17
Loose Tube Single Jacket Self Support Series 11M	B-18
Loose Tube Double Jacket Self Support Series 1GM	B-19
Loose Tube Single Jacket Single Armor Self Support Series 12M	B-20
Loose Tube Double Jacket Single Armor Self Support Series 1AM	B-21
Dri-Lite® Loose Tube Single Jacket Long-Span Self Support Series 11MLS	B-22
ADSS 100 Series 1F100	B-23
ADSS 200 Series 1F200	B-24
ADSS 400 Series 1F400	B-25
Single Loose Tube All Dielectric Series 51	B-26
Single Loose Tube Single Armor Series 52	B-27
Single Flex Tube All Dielectric Series F1	B-28
Single Flex Tube Single Armor Series F2	B-29
Flex Tube Locate Series FM	B-30
Ribbon Locate Series RM	B-31
Loose Tube Single Jacket All Dielectric Nylon Series 1NY	B-32
Dri-Lite® Loose Tube Indoor/Outdoor OFNR Series 13D	B-33
Loose Tube Indoor/Outdoor OFNR Series 13	B-34
Interlock Armored OSP Fiber OFCR Series 13I	B-35
Loose Tube Single Jacket All Dielectric Indoor/Outdoor LSZH Series HZD	B-36
Loose Tube Single Jacket Single Armor Indoor/Outdoor LSZH Series HZA	B-37
Single Loose Tube Indoor/Outdoor OFNR Series 53	B-38
Heavy Duty Loose Tube OFNR Series 1H	B-39
Loose Tube 12 AWG Composite Series 1N	B-40
UG FTTP Series 513	B-41
Buried FTTP, Steel Armor Series 52S	B-42
Buried FTTP, Steel Armor Series 52U	B-43
Figure 8 FTTP Series 573Q	B-44
Buried FTTP, Aluminum Armor Series 523	B-45
Buried Drop Composite, Aluminum Armor Series 72	B-46
Buried Drop Composite, Steel Armor Series 72S	B-47
Universal Drop FTTP Series 6U	B-48
Toneable Drop FTTP Series 6T	B-49
Universal Flex FTTP Series 6S	B-50
Toneable Flex FTTP Series 6R	B-51
Universal FTTP Tight Buffered Indoor/Outdoor Drop Series W7U	B-52
Toneable FTTP Tight Buffered Indoor/Outdoor Drop Series W7T	B-53
Dri-Lite® Ribbon Series R1D	B-54
Dri-Lite® Ribbon Single Armor Series R2D	B-55
Stranded Tube Ribbon Single Armor Series S2	B-57
Single Tube Ribbon Series R1	B-58
Single Tube Ribbon Single Armor Series R2	B-59

OSP COMPOSITE CABLE

Composite Right of Way Series MR	B-60
Composite Category 5e Drop Series 5F	B-61
Composite Drop Web Series 5W	B-62
Composite Drop Overjacket Series 71 OJ	B-63
Composite OSP Web Series 5V	B-64
Composite OSP Overjacket Series 70 OJ	B-65
Composite Round CF Series L	B-66

RDUP/RUS OSP COPPER CABLE

SEALPIC®	B-68
SEALPIC®-84	B-70
SEALPIC®-FSF-84	B-72
SEALPIC®-FSF RDUP PE-89	B-74
CASPIC®-FSF RDUP PE-89	B-76
SEALPIC®-F RDUP PE-39	B-78
CUPIC-F® RDUP PE-39	B-80
GOPIC®-F RDUP PE-39	B-82

BELL OSP COPPER CABLE

ALPETH BHBA, BHAA, BKMA and BKTA	B-84
PASP BHBH, BHAB, BKMH and BKTH	B-86
Self-Support BHAS and BKMS	B-88
Reinforced Self-Support BHAP, BKMP and BKTP	B-89
Bonded STALPETH DCAZ, DCMZ and DCTZ	B-90
STEAMPETH DKTN	B-92
Power Station High Potential Filled ASP CMAW	B-93
Filled ALPETH ANBA, ANAA, ANMA and ANTA	B-94
Filled ASP ANBV, ANAW, ANMW and ANTW	B-96
T-SCREEN® Filled ASP KNAW and KNMW	B-99

CANADIAN OSP COPPER CABLE

CELLFIB BJBB, BJAB, BJMB and BJTB	B-100
Canadian ALPETH BHBB, BHAB, BKMB and BKTB	B-102
SEALPAP BHHF, BHAF, BKMF and BKTF	B-104
Canadian Bonded STALPETH DCAZ, DCMZ and DCTZ	B-106
Canadian Integrated Messenger Wire IM/F, IM/H and IM/G	B-108
Canadian ADP NMS with QuickCount® in Meters	B-109
Aerial Drop Wire ADW	B-110
Buried Distribution Wire BCBD	B-111

OSP COPPER WIRE

C-Rural Wire	B-112
IMRDW	B-113
IMRDWS	B-114
ADP NMS	B-115
ADP NMS Compact Design 6 x 24	B-116
ADP S	B-117
Integrated Messenger Wire IM/F, IM/H and IM/G	B-118
BDW A	B-119
BDW G	B-120
BW GDJ	B-121
BW AF	B-123
Non-Jacketed Tight Twist Cable Core	B-124
Air Pipe	B-124
Bridle Wire	B-125
Temporary Drop Wire TDW	B-125
E-Block Wire	B-126
Ground Wire Bare or Jacketed	B-127
Cross-Connect Category 5 Wire XCW	B-128
Indoor/Outdoor Cross-Connect Wire XCW	B-129

Table of Contents

FTTP CLOSURES

Slack Storage Module (SSM)	C-2
Fiber In-Line Splice Closure (FIC)	C-4
Fiber Dome Splice Closure (FDC)	C-6
FDH-288 Series Fiber Distribution Hub (FDH)	C-8

FTTP ACCESSORIES

FIC Tray Kits/Splitters	C-10
FIC End Grommet Kits	C-11
FIC Hanger Kits	C-11
FDC Tray Kits/Splitters	C-12
FDC Pole Mount Kits	C-12
FDC Compression Grommet Kits	C-13
FDC Compression Connector Wrench	C-13

RF FEEDER CABLE AND JUMPERS

LHF Series Low Loss High Flexible Foam Dielectric Feeder	D-2
LHF Series (Ultimate High Performance)	
Ultimate Low Loss High Flexible Foam Dielectric Feeder	D-4
HFSC Series Super Flexible Foam Dielectric Feeder	D-5
Fiber-to-the-Antenna (FTTA)	D-6
RF Jumper Cable	D-7

RF CONNECTORS

DIN Series for LHF	D-8
DIN Series for HFSC	D-9
N Series for LHF	D-10
N Series for HFSC	D-11

IN-BUILDING WIRELESS CABLE AND JUMPERS

DAS Hybrid Fiber + Copper	D-12
DAS Hybrid, Interlock Armored Fiber + Copper	D-13
LHF Riser Low Loss High Flexible Foam Dielectric Feeder	D-14
LHF Plenum Low Loss High Flexible Air Dielectric Feeder	D-15
HFSC Riser Super Flexible Foam Dielectric Feeder	D-16
HFSC Plenum Super Flexible Air Dielectric Feeder	D-17
HFAC Riser Low Loss High Flexible Foam Dielectric Feeder	D-18
HFAC Plenum Low Loss High Flexible Air Dielectric Feeder	D-19
DAS Riser Jumper Cable	D-20
DAS Plenum Jumper Cable	D-21

IN-BUILDING WIRELESS CONNECTORS

DIN Series for LHF	D-22
DIN Series for HFSC	D-23
DIN Series for HFAC	D-24
N Series for LHF	D-25
N Series for HFSC	D-26
N Series for HFAC	D-27

WIRELESS ACCESSORIES

Cable Preparation Tools	D-28
Cushion and Boot Assembly Kit	D-29
Universal Weatherproofing Kit	D-30
Hoisting Grip Lace-Up and Pre-Laced	D-31
Clip-On Grounding Kit	D-32
Universal Snap-in Hanger Kit	D-33
Stackable Snap-in Hanger Kit	D-34
Standard Hanger Kit	D-35
$\lambda/4$ Wave Surge Arrestor	D-36
Gas Tube Surge Arrestor	D-37
Round Adapter Kit	D-38
Stand-Off Adapter Kit	D-39
Three-Way Stand-Off Adapter Kit	D-40
Angle Adapter Kit	D-40
Ground Bus Bar Kit	D-41
Weather Proofing Shell	D-42
Anti-Theft Hardware Kit	D-43

TECHNICAL INFORMATION

Metric Conversions	X-2
American Wire Gauge Sizes	X-2
Optical Fiber Types	X-3
Optical Fiber Specifications	X-4
Optical Fiber Cable	X-6
Canadian Central Office Cable	X-6
OSP Copper Cable	X-7
Mechanical Protection (+M) for Extreme Risk Environments	X-8
Copper Wire and Cable	X-9
Fire Alarm/Security Control Cable	X-10
Premises Cable Conduit Fill Quick Reference	X-11
Packaging	X-12
Terms and Conditions of Sale	X-18
Part Number Index	X-19





SUSTAINABILITY FAST FACTS

Superior Essex is firmly committed to sustainable practices and transparency, and we strive to lead innovation and design toward sustainable product solutions. As the first and only telecommunications wire and cable manufacturer to offer Environmental Product Declarations (EPD), Health Product Declarations™ (HPD™), and Multi-Attribute Certifications, we are the preferred choice for all enterprises relying on sustainable, high-performance cabling solutions.

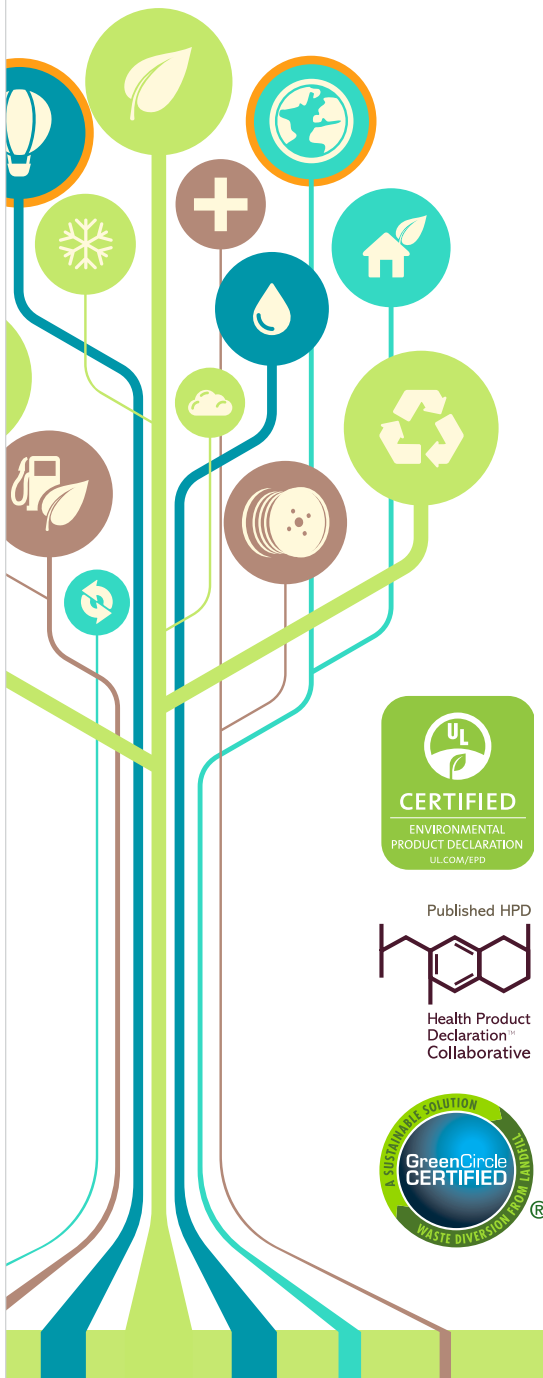

What is an Environmental Product Declaration (EPD)?

- An Environmental Product Declaration is a source of transparent, scientifically-based information that discloses the potential environmental impact of a product or product family.
- Superior Essex Environmental Product Declarations are verified by UL® Environment, a division of the safety science company Underwriters Laboratories.
 - » Superior Essex provides premises copper and optical fiber cabling products with EPDs.

What is a Health Product Declaration (HPD)?

- A Health Product Declaration is a report that describes product contents and each ingredient's relationship to human and ecological health.
- Superior Essex Health Product Declarations are published according to the Health Product Declaration Collaborative Standard.
 - » Superior Essex provides premises copper and optical fiber cabling products with HPDs.

What is a Multi-Attribute Certification?

- A Multi-Attribute Certification provides a complete overview of the sustainability of a product, its packaging and manufacturing operations.
- Superior Essex Multi-Attribute Certifications are published through GreenCircle Certified LLC, in accordance with internationally recognized standards and the Federal Trade Commission's Green Guides.
 - » Superior Essex provides premises copper cabling products with Multi-Attribute Labels.

Superior Essex Contributing to LEED certification

- Superior Essex cable products with EPDs can contribute toward one (1) building product disclosure and optimization LEED credit in the Materials and Resources credit category.
- Similarly, Superior Essex cable products with HPDs can contribute toward one (1) building product disclosure and optimization LEED credit in the Materials and Resources credit category.
- Products that have both EPDs and HPDs can contribute toward two (2) separate credits in the Materials and Resources credit category.

The Importance of Transparency and Sustainable Solutions

- As the demand for green buildings continues to grow, many architects, contractors and engineers are seeking out products that are manufactured sustainably from organizations that are transparent about their products and operations.
- The International Green Construction Code (IgCC) 2015 states that EPDs are one of several Materials and Resources Compliance pathways, and this code has been adopted in whole or in part by several municipalities and states as mandatory or voluntary.

Where can I find Superior Essex sustainability information?

- » ce.SuperiorEssex.com/enviro
- » GreenWizard.com



Published HPD



UL and the related logo are registered trademarks of UL LLC. Health Product Declaration, HPD and the related logo are trademarks of Health Product Declaration Collaborative. GreenCircle Certified logo is a registered trademark of GreenCircle Certified, LLC.



800.551.8948
SuperiorEssex.com

All information, content, data, specifications, packaging and part numbers detailed herein are subject to change. For the most up-to-date information, please visit SuperiorEssex.com. Purchase of this product is subject exclusively to the then current **Superior Essex International LP Terms and Conditions of Sale for Communications and Energy Cable, Wire and Connectivity Products**, which can be found on our website, SuperiorEssex.com, or provided to you upon request.

PREMISES FIBER CABLE

Simplex, Duplex and Quad Interconnect OFNR/OFNP	A-2
Microarray Data Center Interconnect OFNR/OFNP	A-4
2 mm Microarray Breakout OFNP	A-6
Interlock Armored, 2mm Microarray Breakout OFCP	A-7
3 mm Microarray Breakout OFNR/OFNP	A-8
Interlock Armored, 3 mm Microarray Breakout OFCR/OFCP	A-10
Indoor/Outdoor, Loose Tube OFNR/OFNP	A-12
Breakout OFNR	A-14
Single Unit Distribution OFNR/OFNP	A-16
Multi-Unit Distribution OFNR/OFNP	A-18
Ribbon Distribution OFNR/OFNP	A-20
Compact and Rugged Indoor MDU OFNR	A-22
Rugged Indoor/Outdoor MDU OFNR	A-23
Indoor/Outdoor Sunlight Resistant OFNP	A-24
Dry Block, Sunlight Resistant, Indoor/Outdoor, Tight Buffer OFNR	A-26
Dry Block, Sunlight Resistant, Indoor/Outdoor OFNP	A-28
Hybrid Premises Fiber OFNR/OFNP	A-30
Interlock Armored, Tight Buffer OFCR/OFCP	A-32
Indoor/Outdoor, Interlock Armored, Tight Buffer OFCR/OFCP	A-34

PREMISES COMPOSITE CABLE

Bundled Composite Category 6 CMR	A-36
Bundled Composite Category 5e CMR	A-37
Residential Broadband Riser	
Coax RG-6 Quad Shield, Category 6 and Optical Fiber	A-38
Residential Broadband Riser	
Coax RG-6 Quad Shield, Category 5e and Optical Fiber	A-39

PREMISES COPPER CABLE

10Gain® XP Category 6A CMR/CMP	A-40
10Gain® Category 6A CMR/CMP	A-42
Category 6A U/FTP (STP) CMR/CMP	A-44
Category 6A U/FTP (STP) with FEP Jacket CMP	A-46
Category 6A F/UTP (ScTP) CMR/CMP	A-48
NextGain® Category 6eX CMR/CMP	A-50
DataGain® Category 6+ CMR/CMP	A-52
Category 6+ LSHF CMR	A-54
Category 6+ F/UTP (ScTP) CMR/CMP	A-56
Category 6 CMR/CMP	A-58
Category 6 CM	A-60
Category 6 with FEP Jacket CMP	A-62
Category 6 CMR/CMX Outdoor Sunlight Resistant	A-64
Category 6 CMR/CMX Outdoor	A-66
Cobra Category 5e+ CMR/CMP	A-68
Category 5e+ F/UTP (ScTP) CMR/CMP	A-70
PowerWise™ Category 5e+ CMR/CMP	A-72
Marathon LAN® Category 5e CMR/CMP	A-74
Category 5e LSZH CM	A-76
Category 5e CM	A-77
Category 5e CMR/CMX Outdoor Sunlight Resistant	A-78
Category 5e CMR/CMX Outdoor	A-80
Category 5e F/UTP (ScTP) CMR/CMX Outdoor Sunlight Resistant	A-82
Category 5e F/UTP (ScTP) CMR/CMX Outdoor	A-84
6-Pair Category 5e CMR	A-86
25-Pair Power Sum Category 5e CMR/CMP	A-87
25-Pair Category 5e Indoor/Outdoor	A-88
Interlock Armored Premises Copper CMR	A-89
Bundled Category 6	A-90
Bundled Category 5e	A-91
OSP Broadband BBD	A-92
OSP Broadband BBDN	A-93
OSP Broadband BBDG	A-94
OSP Broadband Indoor/Outdoor Halogen-Free CM/CMX	A-95
OSP Broadband Duplex	A-96

PREMISES COPPER CABLE CONTINUED...

MEGAPIC® OSP Broadband Backbone Category 5	A-97
Category 3 CMR/CMP 2-Pair - 400-Pair	A-98
Category 3 Station Wire CMR/CMX Outdoor	A-100
ARMM Series CMR	A-102
Coax RG-6, Quad Shield	
CM/CATV, CMR/CATVR, CMP/CL2P, Interlock Armored CMR	A-104
Coax RG-6, 80% Shield CMP/CL2P	A-106
Coax RG-6, Tri-Shield 70% CM/CMR	A-107
Coax RG-6, 60% Shield CM	A-108
Coax RG-59, 95% Shield CMR/CL2R, CMP/CL2P	A-110
Coax RG-59, 95% Shield + 18/2 CMP/CL2P	A-111
Fire Alarm, Non-Shielded Power Limited, Riser/Plenum	A-112
Fire Alarm, Shielded Power Limited, Riser/Plenum	A-114
Interlock Armored Fire Alarm Riser	A-116
Security Control, Non-Shielded Power Limited, Riser/Plenum	A-118
Security Control, Shielded Power Limited, Riser/Plenum	A-120
Access Control Composite Riser/Plenum	A-122

CENTRAL OFFICE COPPER CABLE

ABAM (600B) and ABMM Series	A-124
1249C Series	A-125
1161A Series Category 3	A-126
600C Series	A-127
25-Pair Category 5e Shielded CMR	A-128
Switchboard 100 Ohm	A-130
Switchboard 100 Ohm 200A/800A Series (Canadian Color Code)	A-132
T100 Series	A-133
Switchboard 85 and Shielded Switchboard 85	A-134
Distribution Frame Wire DFW	A-135
Heavy Duty Distribution Frame Wire HD-DFW	A-136
Tight Twist Distribution Frame Wire DFW	A-137

Simplex, Duplex and Quad Interconnect

OFNR/OFNP



Zip Cord Configuration

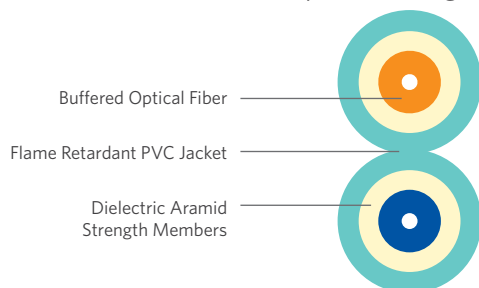

Buffered Optical Fiber

Flame Retardant PVC Jacket

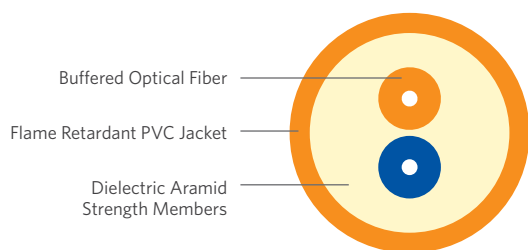
Dielectric Aramid
Strength Members

Buffered Optical Fiber

Flame Retardant PVC Jacket

Dielectric Aramid
Strength Members

Round Configuration

SPECIFICATIONS

Configuration	Flexible tight buffered optical fibers surrounded by aramid yarns and covered by a flame retardant jacket
Strength Elements	Dielectric aramid yarns
Jacket	OFNR: Flame retardant (FR) PVC OFNP: FR, low smoke PVC
Performance Compliance	UL 1651 CSA C22.2 No. 232 UL 1666 NFPA 262 Telcordia® GR-409-CORE, Issue 2 ANSI/ICEA S-83-596 ANSI/TIA-568-C.3
NRTL Programs	UL, c(UL) Listed OFNR UL, c(UL) Listed OFNP
Sustainability	UL Certified EPD HPD USGBC® Member RoHS-compliant/RoHS 2-compliant REACH-compliant

ENVIRONMENTAL SPECIFICATIONS

	Riser	Plenum
Operation	-40°C to +75°C	0°C to +75°C
Storage/Shipping	-40°C to +75°C	-40°C to +75°C
Installation	-20°C to +65°C	0°C to +65°C

PRODUCT DESCRIPTION



FIRST MANUFACTURER IN THE INDUSTRY
to offer products that contribute toward LEED!

Simplex, Duplex and Quad Optical Fiber Interconnect Cables are typically used for patch cords and intrabuilding installations. Superior Essex designed these cables for environments where small size, flexible construction and flame resistance are required. These cables are available in both riser and plenum versions. Higher performance optical fibers are offered, including bend insensitive G.657.A1 single mode and 10G/300 OM3 and 10G/550 OM4 laser optimized 50 µm multimode.

The design consists of flexible tight buffer material extruded over the fiber to a diameter of 900 µm for use with standard connectors. Dielectric yarns are applied for additional strength and a flame retardant PVC jacket covers the strength members. Appropriate materials are used to achieve an OFNR (riser) or OFNP (plenum) rating. Standard 2.9 mm and small form factor 2 mm diameters are available for simplex and duplex designs.

APPLICATIONS

- Cross-connects and patch applications
- Communication closets to wall outlets
- Drop ceiling and plenum air space applications

FEATURES

- UL® Certified Environmental Product Declaration (EPD)
- Health Product Declaration™ (HPD™)
- Simplex and duplex zip cord designs in 2 mm and 2.9 mm diameters
- Round, duplex and quad designs
- Marked in feet and meters
- BrakeBox® payout control system

BENEFITS

- Contributes toward 1 LEED point under the Material and Resources credit (MRc)
- Contributes toward 1 LEED point under the MRC
- Meets all the requirements for both standard and small form factor connectors for “in-front-of-the-shelf” applications
- Perfect for in-wall and “behind-the-shelf” applications
- Meets commercial, government and international requirements for length markings
- Adjustable tension control on reel prevents over spin and entangling of cable

SUSTAINABILITY LEADERSHIP



UL and the related logo are registered trademarks of UL LLC. Health Product Declaration, HPD and the related logo are trademarks of Health Product Declaration Collaborative. Telcordia is a registered trademark of Ericsson Inc. USGBC and the related logo are registered trademarks of U.S. Green Building Council.

PART NUMBERS AND PHYSICAL CHARACTERISTICS

Listing	Part Number ¹	Configuration	Fiber Type	Fiber Count	Nominal Diameter in (mm)	Nominal Weight lbs/kft (kg/km)	Maximum Tensile Loading		Minimum Bend Radius		Package
							Install lbs (N)	Long Term lbs (N)	Install in (mm)	Long Term in (mm)	
OFNR	33001x101	Round	Single Mode	1	0.11 (2.9)	6 (8)	50 (220)	15 (70)	1.7 (44)	1.1 (29)	Plywood reel
OFNR	A3001x101	Round	Single Mode	1	0.08 (2.0)	3 (4)	50 (220)	15 (70)	1.2 (30)	0.8 (20)	Plywood reel
OFNR	B3002x101	Zip	Single Mode	2	0.11 x 0.24 (2.9 x 6.2)	8 (12)	100 (440)	30 (130)	1.7 (44)	1.1 (29)	Plywood reel
OFNR	C3002x101	Zip	Single Mode	2	0.08 x 0.17 (2.0 x 4.2)	6 (9)	50 (220)	15 (70)	1.2 (30)	0.8 (20)	Plywood reel
OFNR	33002x1zz	Round	Single Mode	2	0.20 (5.0)	14 (21)	100 (440)	30 (130)	3.0 (75)	2.0 (50)	use key
OFNR	33004x1zz	Round	Single Mode	4	0.20 (5.0)	15 (23)	100 (440)	30 (130)	3.0 (75)	2.0 (50)	use key
OFNP	34001x101	Round	Single Mode	1	0.11 (2.9)	6 (9)	50 (220)	15 (70)	1.7 (44)	1.1 (29)	Plywood reel
OFNP	A4001x101	Round	Single Mode	1	0.08 (2.0)	3 (4)	50 (220)	15 (70)	1.2 (30)	0.8 (20)	Plywood reel
OFNP	B4002x101	Zip	Single Mode	2	0.11 x 0.24 (2.9 x 6.2)	8 (11)	100 (440)	30 (130)	1.7 (44)	1.1 (29)	Plywood reel
OFNP	C4002x101	Zip	Single Mode	2	0.08 x 0.17 (2.0 x 4.2)	6 (9)	50 (220)	15 (70)	1.2 (30)	0.8 (20)	Plywood reel
OFNP	34002x1zz	Round	Single Mode	2	0.17 (4.2)	12 (18)	100 (440)	30 (130)	2.5 (63)	1.7 (42)	use key
OFNP	34004x1zz	Round	Single Mode	4	0.17 (4.2)	13 (20)	100 (440)	30 (130)	2.5 (63)	1.7 (42)	use key
OFNR	33001yG01	Round	Multimode	1	0.11 (2.9)	6 (8)	50 (220)	15 (70)	1.7 (44)	1.1 (29)	Plywood reel
OFNR	A3001yG01	Round	Multimode	1	0.08 (2.0)	3 (4)	50 (220)	15 (70)	1.2 (30)	0.8 (20)	Plywood reel
OFNR	B3002yG01	Zip	Multimode	2	0.11 x 0.24 (2.9 x 6.2)	8 (12)	100 (440)	30 (130)	1.7 (44)	1.1 (29)	Plywood reel
OFNR	C3002yG01	Zip	Multimode	2	0.08 x 0.17 (2.0 x 4.2)	6 (9)	50 (220)	15 (70)	1.2 (30)	0.8 (20)	Plywood reel
OFNR	33002yGzz	Round	Multimode	2	0.20 (5.0)	14 (21)	100 (440)	30 (130)	3.0 (75)	2.0 (50)	use key
OFNR	33004yGzz	Round	Multimode	4	0.20 (5.0)	15 (23)	100 (440)	30 (130)	3.0 (75)	2.0 (50)	use key
OFNP	34001yG01	Round	Multimode	1	0.11 (2.9)	6 (9)	50 (220)	15 (70)	1.7 (44)	1.1 (29)	Plywood reel
OFNP	A4001yG01	Round	Multimode	1	0.08 (2.0)	3 (4)	50 (220)	15 (70)	1.2 (30)	0.8 (20)	Plywood reel
OFNP	B4002yG01	Zip	Multimode	2	0.11 x 0.24 (2.9 x 6.2)	8 (11)	100 (440)	30 (130)	1.7 (44)	1.1 (29)	Plywood reel
OFNP	C4002yG01	Zip	Multimode	2	0.08 x 0.17 (2.0 x 4.2)	6 (9)	50 (220)	15 (70)	1.2 (30)	0.8 (20)	Plywood reel
OFNP	34002yGzz	Round	Multimode	2	0.17 (4.2)	12 (18)	100 (440)	30 (130)	2.5 (63)	1.7 (42)	use key
OFNP	34004yGzz	Round	Multimode	4	0.17 (4.2)	13 (20)	100 (440)	30 (130)	2.5 (63)	1.7 (42)	use key

SINGLE MODE OPTICAL FIBER TYPES

	Reduced Water Peak	TeraFlex® Bend Resistant		
		G.657.A1	G.657.A2	G.657.B3
¹ Replace "x" with:	3	K	J	L
Standard Jacket Colors*		Yellow		

MULTIMODE OPTICAL FIBER TYPES

	TeraGain®	TeraGain Laser Optimized 50/125			TeraFlex Bend Resistant Laser Optimized 50/125		
	62.5/125	10G/150	10G/300	10G/550	10G/150	10G/300	10G/550
¹ Replace "y" with:	6	A	B	F	M	N	P
Standard Jacket Colors*	Orange	Aqua					

*Other jacket colors available upon request.
See "Optical Fiber Specifications" in the "Technical Information" section for detailed fiber type specifications.

PACKAGING

	Cut to Length Plywood Reel	1,000 ft BrakeBox	1,500 ft BrakeBox	2,000 ft BrakeBox
¹ Replace "zz" with:	01	BB	BD	BC

Microarray Data Center Interconnect

OFNR/OFNP

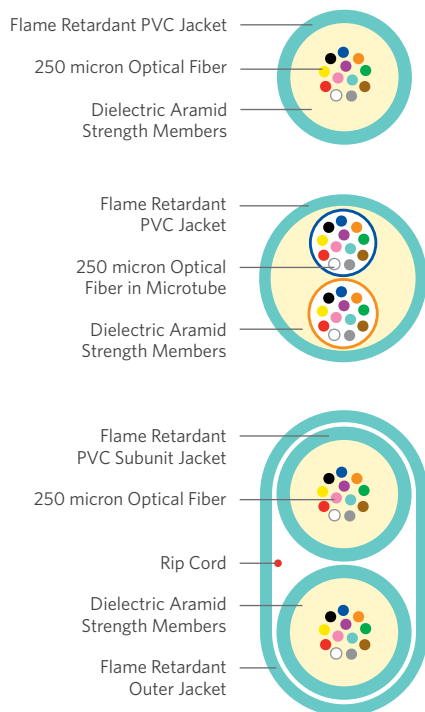
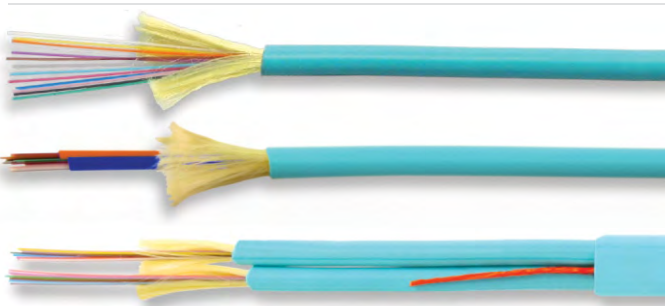

SPECIFICATIONS

≤12-Fiber Configuration	250 micron optical fibers surrounded by dielectric aramid yarns in a 2 mm loose tube or a 3 mm loose tube
24-Fiber Configuration	Two microtubes containing twelve 250 micron optical fibers; the microtubes are surrounded by dielectric aramid yarns and enclosed in a single 3.8 mm loose tube
24-Fiber Duplex Configuration	Two 3 mm loose tubes containing twelve 250 micron optical fibers and dielectric aramid yarns; both tubes are enclosed in an overjacket
Jacket	OFNR: Flame retardant (FR) PVC OFNP: FR, low smoke PVC
Performance Compliance	UL 1651 CSA C22.2 No. 232 UL 1666 NFPA 262 Telcordia® GR-409-CORE, Issue 2 ANSI/ICEA S-83-596 ANSI/TIA-568-C.3
NRTL Programs	UL, c(UL) Listed OFNR UL, c(UL) Listed OFNP
Sustainability	UL Certified EPD HPD USGBC® Member RoHS-compliant/RoHS 2-compliant REACH-compliant

PRODUCT DESCRIPTION



FIRST MANUFACTURER IN THE INDUSTRY
to offer products that contribute toward LEED!

The Microarray Data Center Interconnect Cables from Superior Essex are designed for high performance in a small package. The 2-fiber through 12-fiber premises loose tube interconnect has an outside diameter of only 2 mm or 3 mm. The 24-fiber single unit employs two, 12-fiber microtubes that are ideal for 24-fiber MTP®/MPO array connectors. The 24-fiber duplex contains two, 12-fiber 3 mm interconnect cables with an overjacket. The fibers can be fusion spliced, connectorized to high density MTP/MPO mechanical array connectors or attached to standard single ferrule mechanical connectors (LC, SC, ST, etc.) via a furcation kit. The loose fibers are surrounded by aramid yarns and a low smoke PVC (LSPVC) plenum or riser-rated jacket. Its small size allows for denser fiber routing than traditional tight buffered cables; its loose-tube construction gives it superior performance and installation ease compared to ribbon interconnect cable.

APPLICATIONS

- 10 Gb, 40 Gb, 100 Gb Ethernet and legacy speeds
- Data centers
- High density installations
- MTP/MPO array connectors

FEATURES

- UL® Certified Environmental Product Declaration (EPD)
- Health Product Declaration™ (HPD™)
- 2 mm loose tube or 3 mm loose tube interconnect with two through twelve 250 micron fibers
- 3.8 mm loose tube interconnect with two, 12-fiber microtubes
- Meets or exceeds ANSI/ICEA S-83-596 and GR-409-CORE requirements for interconnect cable
- Plenum (OFNP) and riser (OFNR) rated designs
- Available with TeraFlex single mode, and laser-optimized 50/125 micron multimode fiber types
- Marked in feet and meters
- Designed for MTP/MPO connectors

BENEFITS

- Contributes toward 1 LEED point under the Material and Resources credit (MRc)
- Contributes toward 1 LEED point under the MRc
- Allows for direct connection to MTP/MPO array connectors
- Allows for direct connection to 24-fiber MTP/MPO array connectors
- Worry-free installation and performance
- Fire-listed cables allow placement in plenum and riser spaces
- Build your network with the fiber type that you need now or for the future
- Meets commercial and government requirements for length markings
- Economical plug and play solution

ENVIRONMENTAL SPECIFICATIONS

	Riser	Plenum
Operation	-20°C to +70°C	0°C to +70°C
Storage/Shipping	-40°C to +75°C	-40°C to +75°C
Installation	10°C to +60°C	10°C to +60°C

PART NUMBERS AND PHYSICAL CHARACTERISTICS

Listing	Part Number ¹	Fiber Count	Nominal Diameter in (mm)	Nominal Weight lbs/kft (kg/km)	Maximum Tensile Loading		Minimum Bend Radius		Package
					Install lbs (N)	Long Term lbs (N)	Install in (mm)	Long Term in (mm)	
OFNR	P3002xx01	2	0.12 (3.0)	5 (8)	80 (370)	25 (110)	1.8 (47)	1.2 (30)	Plywood reel
OFNR	P3004xx01	4	0.12 (3.0)	5 (8)	80 (370)	25 (110)	1.8 (47)	1.2 (30)	Plywood reel
OFNR	P3006xx01	6	0.12 (3.0)	5 (8)	80 (370)	25 (110)	1.8 (47)	1.2 (30)	Plywood reel
OFNR	P3008xx01	8	0.12 (3.0)	5 (8)	80 (370)	25 (110)	1.8 (47)	1.2 (30)	Plywood reel
OFNR	P3012xx01	12	0.12 (3.0)	5 (8)	80 (370)	25 (110)	1.8 (47)	1.2 (30)	Plywood reel
OFNR	P3024xxA1	24	0.17 x 0.29 (4.4 x 7.5)	22 (33)	150 (668)	25 (110)	6.0 (152)	3.0 (76)	Plywood reel
OFNP	V4002xx01	2	0.08 (2.0)		50 (220)	15 (70)	1.2 (30)	0.8 (20)	Plywood reel
OFNP	P4002xx01	2	0.12 (3.0)	6 (9)	80 (370)	25 (110)	1.8 (47)	1.2 (30)	Plywood reel
OFNP	V4004xx01	4	0.08 (2.0)		50 (220)	15 (70)	1.2 (30)	0.8 (20)	Plywood reel
OFNP	P4004xx01	4	0.12 (3.0)	6 (9)	80 (370)	25 (110)	1.8 (47)	1.2 (30)	Plywood reel
OFNP	V4006xx01	6	0.08 (2.0)		50 (220)	15 (70)	1.2 (30)	0.8 (20)	Plywood reel
OFNP	P4006xx01	6	0.12 (3.0)	6 (9)	80 (370)	25 (110)	1.8 (47)	1.2 (30)	Plywood reel
OFNP	V4008xx01	8	0.08 (2.0)		50 (220)	15 (70)	1.2 (30)	0.8 (20)	Plywood reel
OFNP	P4008xx01	8	0.12 (3.0)	6 (9)	80 (370)	25 (110)	1.8 (47)	1.2 (30)	Plywood reel
OFNP	V4012xx01	12	0.08 (2.0)		50 (220)	15 (70)	1.2 (30)	0.8 (20)	Plywood reel
OFNP	P4012xx01	12	0.12 (3.0)	6 (9)	80 (370)	25 (110)	1.8 (47)	1.2 (30)	Plywood reel
OFNP	P4024xxC1	24	0.15 (3.8)	8 (12)	80 (370)	25 (110)	3.0 (76)	1.5 (38)	Plywood reel
OFNP	P4024xxA1	24	0.17 x 0.29 (4.4 x 7.5)	25 (37)	150 (668)	25 (110)	6.0 (152)	3.0 (76)	Plywood reel

SINGLE MODE OPTICAL FIBER TYPES

	TeraFlex® Bend Resistant		
	G.657.A1	G.657.A2	G.657.B3
¹ Replace "xx" with:	K1	J1	L1
Standard Jacket Colors*	Yellow		

MULTIMODE OPTICAL FIBER TYPES

	TeraGain® Laser Optimized 50/125			TeraFlex Bend Resistant Laser Optimized 50/125		
	10G/150	10G/300	10G/550	10G/150	10G/300	10G/550
¹ Replace "xx" with:	AG	BG	FG	MG	NG	PG
Standard Jacket Colors*	Aqua					

*Other jacket colors available upon request. See "Optical Fiber Specifications" in the "Technical Information" section for detailed fiber type specifications.

SUSTAINABILITY LEADERSHIP



UL and the related logo are registered trademarks of UL LLC. Health Product Declaration, HPD and the related logo are trademarks of Health Product Declaration Collaborative. Telcordia is a registered trademark of Ericsson Inc. USGBC and the related logo are registered trademarks of U.S. Green Building Council.

2 mm Microarray Breakout

OFNP

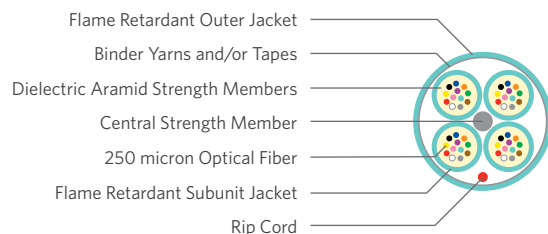

PRODUCT DESCRIPTION



FIRST MANUFACTURER IN THE INDUSTRY
to offer products that contribute toward LEED!

The 2 mm Microarray Breakout cable from Superior Essex is designed for high performance in a small package. The premises loose tube design consists of 12-fiber 2 mm microarray interconnect cable subunits, each of which contain twelve 250 micron fibers. The aramid yarns inside the subunit allow the subunit to be crimped directly onto an MTP®/MPO connector. The 2 mm subunits are stranded around a central strength element that is both flexible and robust enough to pass backbone installation requirements. The stranded subunits are held to the strength element core by binder yarns and/or tapes ensuring excellent temperature performance. Finally, a RoHS-compliant flexible jacket protects the core from the rigors of installation while providing plenum fire protection. The cable is available with TeraFlex® single mode, and TeraFlex laser-optimized 50/125 micron 10G/150 (OM2+), 10G/300 (OM3) and 10G/550 (OM4) multimode fiber types.

SPECIFICATIONS

Subunit Configuration	2 mm Simplex loose tube cable with twelve 250 micron optical fibers surrounded by dielectric aramid strength members
Cable Configuration	2 mm loose tube subunits around a central strength member and surrounded by polyester yarns and an outer jacket
Subunit Marking	Unit 1, Unit 2, Unit 3, Unit 4...
Central Strength Element	Glass Reinforced Plastic (GRP)
Subunit/Outer Jacket	Flame retardant, low smoke PVC
Performance Compliance	UL 1651 CSA C22.2 No. 232 NFPA 262 Telcordia® GR-409-CORE, Issue 2 ANSI/ICEA S-83-596 ANSI/TIA-568-C.3
NRTL Programs	UL, c(UL) Listed OFNP
Sustainability	UL Certified EPD HPD USGBC® Member RoHS-compliant/RoHS 2-compliant REACH-compliant

ENVIRONMENTAL SPECIFICATIONS

Operation	0°C to +70°C
Storage/Shipping	-40°C to +75°C
Installation	10°C to +60°C

PART NUMBERS AND PHYSICAL CHARACTERISTICS

Part Number ¹	Fiber Count	Nominal Diameter in (mm)	Nominal Weight lbs/kft (kg/km)	Maximum Tensile Loading		Minimum Bend Radius		Package
				Install lbs (N)	Long Term lbs (N)	Install in (mm)	Long Term in (mm)	
V4024xxB1	24	0.26 (6.5)	29 (43)	150 (660)	45 (200)	3.8 (98)	2.6 (65)	Plywood reel
V4036xxB1	36	0.26 (6.5)	29 (43)	150 (660)	45 (200)	3.8 (98)	2.6 (65)	Plywood reel
V4048xx01	48	0.26 (6.5)	29 (43)	150 (660)	45 (200)	3.8 (98)	2.6 (65)	Plywood reel
V4072xx01	72	0.31 (7.9)	32 (47)	300 (1,334)	90 (400)	4.7 (119)	3.1 (79)	Plywood reel
V4096xx01	96	0.36 (9.2)	44 (66)	300 (1,334)	90 (400)	5.4 (138)	3.6 (92)	Plywood reel
V4144xx01	144	0.47 (12.0)	101 (152)	300 (1,334)	90 (400)	7.0 (180)	4.7 (120)	Plywood reel

SINGLE MODE OPTICAL FIBER TYPES

	TeraFlex® Bend Resistant		
	G.657.A1	G.657.A2	G.657.B3
¹ Replace "xx" with:	K1	J1	L1
Standard Jacket Colors*	Yellow		

MULTIMODE OPTICAL FIBER TYPES

	TeraFlex Bend Resistant Laser Optimized 50/125		
	10G/150	10G/300	10G/550
¹ Replace "xx" with:	MG	NG	PG
Standard Jacket Colors*	Aqua		

*Other jacket colors available upon request. See "Optical Fiber Specifications" in the "Technical Information" section for detailed fiber type specifications.

MTP is a registered trademark of US Conec Ltd. UL is a registered trademark of UL LLC. Health Product Declaration and HPD are trademarks of Health Product Declaration Collaborative. Telcordia is a registered trademark of Ericsson Inc. USGBC is a registered trademark of U.S. Green Building Council.

Interlock Armored, 2mm Microarray Breakout

OFCP

PRODUCT DESCRIPTION



FIRST MANUFACTURER IN THE INDUSTRY
to offer products that contribute toward LEED!

The Interlock Armored Microarray Breakout cable from Superior Essex is designed for high performance with robust mechanical protection. The premises loose tube design consists of 12-fiber 2 mm microarray interconnect cable subunits, each of which contain twelve 250 micron fibers. The aramid yarns inside the subunit allow the subunit to be crimped directly onto an MTP®/MPO connector. The 2 mm subunits are stranded around a central strength element that is both flexible and robust enough to pass backbone installation requirements. The stranded subunits are held to the strength element core by binder yarns and/or tapes ensuring excellent temperature performance. A RoHS-compliant flexible jacket protects the core while providing fire protection. Finally, the cable is interlock armored with either aluminum (standard) or steel and jacketed.

APPLICATIONS

- 10 Gb, 40 Gb, 100 Gb Ethernet and legacy speeds
- Data centers and other high density installations
- Trunk applications
- MTP/MPO array connectors
- Outside plant (OSP) to premises transitions

FEATURES

- UL® Certified Environmental Product Declaration (EPD)
- Health Product Declaration™ (HPD™)
- 12-fiber 2 mm loose tube interconnect subunits
- Meets or exceeds ICEA 83-596-2001 and GR-409-CORE requirements for interconnect subunits and trunk cable
- Interlock armor
- Plenum (OFCP) rated design

BENEFITS

- Contributes toward 1 LEED point under the Material and Resources credit (MRc)
- Contributes toward 1 LEED point under the MRc
- Connects directly to MTP/MPO 12-fiber array connectors
- Worry-free installation and performance
- Provides exceptional mechanical protection and crush resistance
- Meets NEC requirements

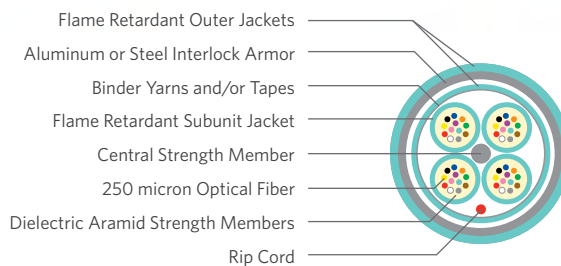

SPECIFICATIONS

Subunit Configuration	2 mm simplex loose tube cable with twelve 250 micron optical fibers surrounded by dielectric aramid strength members
Cable Configuration	2 mm loose tube subunits around a central strength member and surrounded by polyester yarns and an outer jacket
Subunit Marking	Unit 1, Unit 2, Unit 3, Unit 4
Central Strength Element	Glass Reinforced Plastic (GRP) covered with a PVC jacket
Subunit/Cable/Outer Jacket	Flame retardant (FR), LSPVC
Armor	Flexible, heavy duty interlocking aluminum (standard) or steel tape helically applied over the inner cable core; further protection is provided by a FR outer jacket
Performance Compliance	UL 1651 CSA C22.2 No. 232 UL 910 NFPA 262 Telcordia® GR-409-CORE, Issue 2 ANSI/ICEA S-83-596 ANSI/TIA-568-C.3
NRTL Programs	UL, c(UL) Listed OFCP
Sustainability	UL Certified EPD HPD USGBC® Member RoHS-compliant/RoHS 2-compliant REACH-compliant

ENVIRONMENTAL SPECIFICATIONS

Operation	0°C to +70°C
Storage/Shipping	-40°C to +70°C
Installation	10°C to +60°C

PART NUMBERS AND PHYSICAL CHARACTERISTICS

Part Number ¹	Fiber Count	Nominal Diameter in (mm)	Nominal Weight lbs/kft (kg/km)	Maximum Tensile Loading		Minimum Bend Radius		Package
				Install lbs (N)	Long Term lbs (N)	Install in (mm)	Long Term in (mm)	
L4024xVB1	24	0.56 (14.2)	117 (174)	150 (660)	45 (200)	8.4 (212)	5.6 (142)	Reel
L4036xVB1	36	0.56 (14.2)	117 (174)	150 (660)	45 (200)	8.4 (212)	5.6 (142)	Reel
L4048xV01	48	0.56 (14.2)	117 (174)	150 (660)	45 (200)	8.4 (212)	5.6 (142)	Reel
L4072xV01	72	0.60 (15.3)	147 (220)	300 (1,320)	90 (400)	9.0 (230)	6.0 (153)	Reel
L4096xV01	96	0.69 (17.4)	178 (266)	300 (1,320)	90 (400)	10.3 (261)	6.9 (174)	Reel
L4144xV01	144	0.78 (19.7)	245 (365)	300 (1,320)	90 (400)	11.6 (294)	7.8 (197)	Reel

SINGLE MODE OPTICAL FIBER TYPES

	TeraFlex® Bend Resistant		
	G.657.A1	G.657.A2	G.657.B3
¹ Replace "x" with:	K	J	L
Standard Jacket Colors*	Yellow		

MULTIMODE OPTICAL FIBER TYPES

	TeraFlex Bend Resistant Laser Optimized 50/125		
	10G/150	10G/300	10G/550
¹ Replace "x" with:	M	N	P
Standard Jacket Colors*	Aqua		

¹Other jacket colors available upon request. See "Optical Fiber Specifications" in the "Technical Information" section for detailed fiber type specifications. MTP is a registered trademark of US Conec Ltd. UL is a registered trademark of UL LLC. Health Product Declaration and HPD are trademarks of Health Product Declaration Collaborative. Telcordia is a registered trademark of Ericsson Inc. USGBC is a registered trademark of U.S. Green Building Council.

3 mm Microarray Breakout

OFNR/OFNP

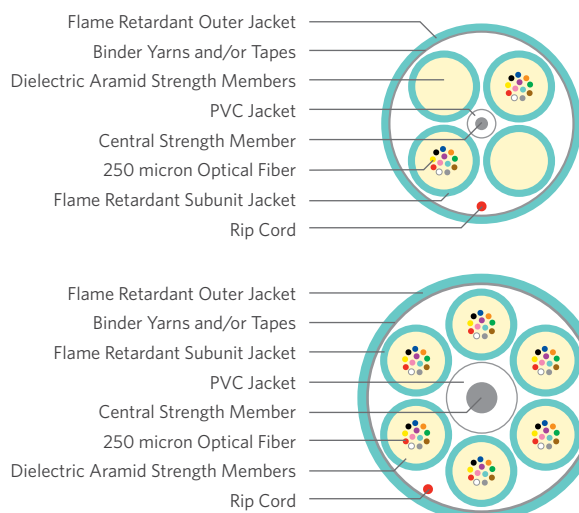
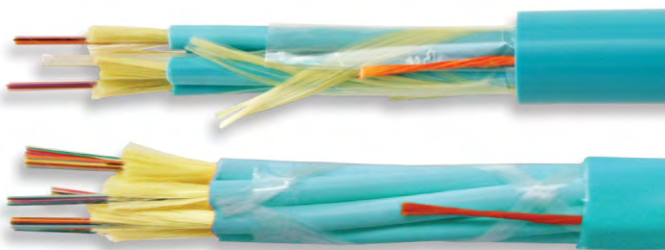

SPECIFICATIONS

Subunit Configuration	3 mm Simplex loose tube cable with twelve 250 micron optical fibers surrounded by dielectric aramid strength members
Cable Configuration	3 mm loose tube subunits around a central strength member and surrounded by polyester yarns and an outer jacket
Subunit Marking	Unit 1, Unit 2, Unit 3, Unit 4...
Central Strength Element	Glass Reinforced Plastic (GRP) covered with a PVC jacket
Subunit/Outer Jacket	OFNR: Flame retardant (FR) PVC OFNP: FR, low smoke PVC
Performance Compliance	UL 1651 CSA C22.2 No. 232 UL 1666 NFPA 262 Telcordia® GR-409-CORE, Issue 2 ANSI/ICEA S-83-596 ANSI/TIA-568-C.3
NRTL Programs	UL, c(UL) Listed OFNR UL, c(UL) Listed OFNP
Sustainability	UL Certified EPD HPD USGBC® Member RoHS-compliant/RoHS 2-compliant REACH-compliant

ENVIRONMENTAL SPECIFICATIONS

	Riser	Plenum
Operation	-20°C to +70°C	0°C to +70°C
Storage/Shipping	-40°C to +75°C	-40°C to +75°C
Installation	10°C to +60°C	10°C to +60°C

PRODUCT DESCRIPTION



FIRST MANUFACTURER IN THE INDUSTRY
to offer products that contribute toward LEED!

The 3 mm Microarray Breakout cable from Superior Essex is designed for high performance in a small package. The premises loose tube design consists of 12-fiber 3 mm microarray interconnect cable subunits, each of which contain twelve 250 micron fibers. The aramid yarns inside the subunit allow the subunit to be crimped directly onto an MTP®/MPO connector. The 3 mm subunits are stranded around a central strength element that is both flexible and robust enough to pass backbone installation requirements. The stranded subunits are held to the strength element core by binder yarns and/or tapes ensuring excellent temperature performance. Finally, a RoHS-compliant flexible jacket protects the core from the rigors of installation while providing riser or plenum fire protection. The cable is available with TeraFlex® single mode, and laser-optimized 50/125 micron 10G/150 (OM2+), 10G/300 (OM3) and 10G/550 (OM4) multimode fiber types.

APPLICATIONS

- 10 Gb, 40 Gb, 100 Gb Ethernet and legacy speeds
- Data centers
- Trunk applications
- High density installations
- MTP/MPO array connectors
- Outside plant (OSP) to premises transitions

FEATURES

- UL® Certified Environmental Product Declaration (EPD)
- Health Product Declaration™ (HPD™)
- 12-fiber 3 mm loose tube interconnect subunits
- Meets or exceeds ICEA 83-596-2001 and GR-409-CORE requirements for interconnect subunits and trunk cable
- Plenum (OFNP) and riser (OFNR) rated designs
- Available with TeraFlex single mode, and laser-optimized 50/125 micron multimode fiber types

BENEFITS

- Contributes toward 1 LEED point under the Material and Resources credit (MRc)
- Contributes toward 1 LEED point under the MRC
- Connects directly to MTP/MPO 12-fiber array connectors
- Worry-free installation and performance
- UL listed cables meet NEC requirements
- Build your network with the fiber type that you need now or for the future

SUSTAINABILITY LEADERSHIP



UL and the related logo are registered trademarks of UL LLC. Health Product Declaration, HPD and the related logo are trademarks of Health Product Declaration Collaborative. Telcordia is a registered trademark of Ericsson Inc. USGBC and the related logo are registered trademarks of U.S. Green Building Council.

PART NUMBERS AND PHYSICAL CHARACTERISTICS

Listing	Part Number ¹	Fiber Count	Nominal Diameter in (mm)	Nominal Weight lbs/kft (kg/km)	Maximum Tensile Loading		Minimum Bend Radius		Package
					Install lbs (N)	Long Term lbs (N)	Install in (mm)	Long Term in (mm)	
OFNR	P3024xxB1	24	0.42 (10.8)	60 (90)	150 (710)	45 (198)	7.0 (180)	3.5 (90)	Plywood reel
OFNR	P3036xxB1	36	0.42 (10.8)	60 (90)	150 (710)	45 (198)	7.0 (180)	3.5 (90)	Plywood reel
OFNR	P3048xx01	48	0.42 (10.8)	61 (91)	150 (710)	45 (198)	8.2 (210)	4.1 (105)	Plywood reel
OFNR	P3072xx01	72	0.50 (12.6)	89 (133)	150 (710)	45 (198)	10.0 (252)	5.0 (126)	Plywood reel
OFNR	P3096xx01	96	0.57 (14.5)	121 (180)	300 (1,420)	90 (396)	11.4 (290)	6.0 (152)	Plywood reel
OFNR	P3144xx01	144	0.69 (17.6)	198 (295)	300 (1,420)	90 (396)	13.8 (350)	6.9 (175)	Plywood reel
OFNP	P4024xxB1	24	0.35 (8.8)	54 (81)	150 (710)	45 (198)	5.2 (132)	3.5 (88)	Plywood reel
OFNP	P4036xxB1	36	0.35 (8.8)	54 (81)	150 (710)	45 (198)	5.2 (132)	3.5 (88)	Plywood reel
OFNP	P4048xx01	48	0.35 (8.8)	55 (82)	150 (710)	45 (198)	5.2 (132)	3.5 (88)	Plywood reel
OFNP	P4072xx01	72	0.43 (10.9)	81 (120)	150 (710)	45 (198)	6.5 (164)	4.3 (109)	Plywood reel
OFNP	P4096xx01	96	0.51 (13.0)	121 (180)	300 (1,420)	90 (396)	11.4 (290)	6.0 (152)	Plywood reel
OFNP	P4144xx01	144	0.69 (17.6)	227 (336)	300 (1,420)	90 (396)	13.8 (350)	6.9 (175)	Plywood reel

SINGLE MODE OPTICAL FIBER TYPES

	TeraFlex® Bend Resistant		
	G.657.A1	G.657.A2	G.657.B3
¹ Replace "xx" with:	K1	J1	L1
Standard Jacket Colors*	Yellow		

MULTIMODE OPTICAL FIBER TYPES

	TeraFlex Bend Resistant Laser Optimized 50/125		
	10G/150	10G/300	10G/550
¹ Replace "xx" with:	MG	NG	PG
Standard Jacket Colors*	Aqua		

*Other jacket colors available upon request.
See "Optical Fiber Specifications" in the "Technical Information" section for detailed fiber type specifications.

Interlock Armored, 3 mm Microarray Breakout

OFCR/OFCP

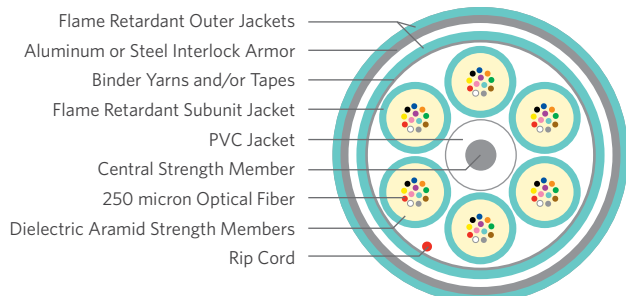

SPECIFICATIONS

Subunit Configuration	3 mm simplex loose tube cable with twelve 250 micron optical fibers surrounded by dielectric aramid strength members
Cable Configuration	3 mm loose tube subunits around a central strength member and surrounded by polyester yarns and an outer jacket
Subunit Marking	Unit 1, Unit 2, Unit 3, Unit 4...
Central Strength Element	Glass Reinforced Plastic (GRP) covered with a PVC jacket
Subunit/Cable/Outer Jacket	OFCR: Flame retardant (FR), PVC OFCP: FR, LSPVC
Armor	Flexible, heavy duty interlocking aluminum (standard) or steel tape helically applied over the inner cable core; further protection is provided by a flame retardant outer jacket
Performance Compliance	UL 1651 CSA C22.2 No. 232 UL 1666 UL 910 NFPA 262 Telcordia® GR-409-CORE, Issue 2 ANSI/ICEA S-83-596 ANSI/TIA-568-C.3
NRTL Programs	UL, c(UL) Listed OFCR UL, c(UL) Listed OFCP
Sustainability	UL Certified EPD HPD USGBC® Member RoHS-compliant/RoHS 2-compliant REACH-compliant

ENVIRONMENTAL SPECIFICATIONS

	Riser	Plenum
Operation	-20°C to +70°C	0°C to +70°C
Storage/Shipping	-40°C to +75°C	-40°C to +70°C
Installation	10°C to +60°C	10°C to +60°C

PRODUCT DESCRIPTION

FIRST MANUFACTURER IN THE INDUSTRY
to offer products that contribute toward LEED!

The Interlock Armored Microarray Breakout cable from Superior Essex is designed for high performance with robust mechanical protection. The premises loose tube design consists of 12-fiber 3 mm microarray interconnect cable subunits, each of which contain twelve 250 micron fibers. The aramid yarns inside the subunit allow the subunit to be crimped directly onto an MTP®/MPO connector. The 3 mm subunits are stranded around a central strength element that is both flexible and robust enough to pass backbone installation requirements. The stranded subunits are held to the strength element core by binder yarns and/or tapes ensuring excellent temperature performance. A RoHS-compliant flexible jacket protects the core while providing fire protection. Finally, the cable is interlock armored with either aluminum (standard) or steel and jacketed. The cable is available with TeraFlex® single mode or laser-optimized 50/125 micron 10G/150 (OM2+), 10G/300 (OM3) or 10G/550 (OM4) multimode fiber types.

APPLICATIONS

- 10 Gb, 40 Gb, 100 Gb Ethernet and legacy speeds
- Data centers
- Trunk applications
- High density installations
- MTP/MPO array connectors
- Outside plant (OSP) to premises transitions

FEATURES

- UL® Certified Environmental Product Declaration (EPD)
- Health Product Declaration™ (HPD™)
- 12-fiber 3 mm loose tube interconnect subunits
- Meets or exceeds ICEA 83-596-2001 and GR-409-CORE requirements for interconnect subunits and trunk cable
- Interlock armor
- Riser (OFCR) and plenum (OFCP) rated designs
- Available with TeraFlex single mode and TeraFlex laser-optimized 50/125 micron multimode bend-insensitive fiber types

BENEFITS

- Contributes toward 1 LEED point under the Material and Resources credit (MRC)
- Contributes toward 1 LEED point under the MRC
- Connects directly to MTP/MPO 12-fiber array connectors
- Worry-free installation and performance
- Provides exceptional mechanical protection and crush resistance
- UL listed cables meet NEC requirements
- Build your network with the fiber type that you need now or for the future

SUSTAINABILITY LEADERSHIP



UL and the related logo are registered trademarks of UL LLC. Health Product Declaration, HPD and the related logo are trademarks of Health Product Declaration Collaborative. Telcordia is a registered trademark of Ericsson Inc. USGBC and the related logo are registered trademarks of U.S. Green Building Council.

PART NUMBERS AND PHYSICAL CHARACTERISTICS

Listing	Part Number ¹	Fiber Count	Nominal Diameter in (mm)	Nominal Weight lbs/kft (kg/km)	Maximum Tensile Loading		Minimum Bend Radius		Package
					Install lbs (N)	Long Term lbs (N)	Install in (mm)	Long Term in (mm)	
OFCR	L3024xPB1	24	0.77 (19.6)	195 (291)	150 (670)	50 (200)	11.6 (294)	7.7 (196)	Reel
OFCR	L3036xPB1	36	0.77 (19.6)	195 (291)	150 (670)	50 (200)	11.6 (294)	7.7 (196)	Reel
OFCR	L3048xP01	48	0.77 (19.6)	196 (293)	150 (670)	50 (200)	11.6 (294)	7.7 (196)	Reel
OFCR	L3072xP01	72	0.87 (22.0)	248 (370)	150 (670)	50 (200)	13.0 (330)	8.7 (220)	Reel
OFCR	L3096xP01	96	0.95 (24.2)	290 (432)	300 (1,340)	90 (400)	14.3 (363)	9.5 (242)	Reel
OFCR	L3144xP01	144	1.08 (27.4)	424 (632)	300 (1,340)	90 (400)	16.2 (411)	10.8 (274)	Reel
OFCP	L4024xPB1	24	0.77 (19.6)	195 (291)	150 (670)	50 (200)	11.6 (294)	7.7 (196)	Reel
OFCP	L4036xPB1	36	0.77 (19.6)	195 (291)	150 (670)	50 (200)	11.6 (294)	7.7 (196)	Reel
OFCP	L4048xP01	48	0.77 (19.6)	196 (293)	150 (670)	50 (200)	11.6 (294)	7.7 (196)	Reel
OFCP	L4072xP01	72	0.87 (22.0)	248 (370)	150 (670)	50 (200)	13.0 (330)	8.7 (220)	Reel
OFCP	L4096xP01	96	0.95 (24.2)	290 (432)	300 (1,340)	90 (400)	14.3 (363)	9.5 (242)	Reel
OFCP	L4144xP01	144	1.08 (27.4)	424 (632)	300 (1,340)	90 (400)	16.2 (411)	10.8 (274)	Reel

SINGLE MODE OPTICAL FIBER TYPES

	TeraFlex® Bend Resistant		
	G.657.A1	G.657.A2	G.657.B3
¹ Replace "x" with:	K	J	L
Standard Jacket Colors*	Yellow		

MULTIMODE OPTICAL FIBER TYPES

	TeraFlex Bend Resistant Laser Optimized 50/125		
	10G/150	10G/300	10G/550
¹ Replace "x" with:	M	N	P
Standard Jacket Colors*	Aqua		

*Other jacket colors available upon request.
See "Optical Fiber Specifications" in the "Technical Information" section for detailed fiber type specifications.

Indoor/Outdoor, Loose Tube

OFNR/OFNP

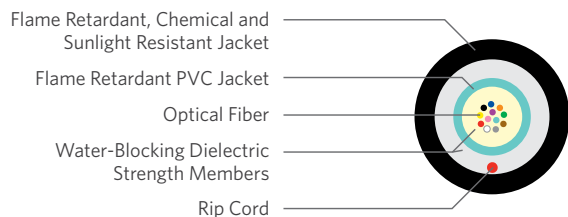

SPECIFICATIONS

2 - 12 Fiber Single Unit Configuration	3 mm central tube containing 2 to 12, 250 μm fibers and water-blocking aramid yarns surrounded by a flame retardant PVC jacket; the central tube is surrounded by additional water-blocking glass yarns and an outer jacket
Subunit Strength Elements	Water-blocking aramid yarns
Subunit Jacket	Flame retardant (FR) PVC
Strength Elements	Water-blocking glass yarns
Outer Jacket	Riser: Black, FR, chemical and sunlight resistant PVC Plenum: Black, FR, chemical and sunlight resistant fluoropolymer
Performance Compliance	UL 1651 CSA C22.2 No. 232 UL 1666 NFPA 262 ANSI/ICEA S-83-596 ANSI/ICEA S-104-696 ANSI/TIA-568-C.3 RoHS-compliant
NRTL Programs	UL, c(UL) Listed OFNR/OFNP UL, c(UL) Listed Sunlight Resistant

ENVIRONMENTAL SPECIFICATIONS

Operation	-40°C to +75°C
Storage/Shipping	-40°C to +75°C
Installation	0°C to +65°C

PRODUCT DESCRIPTION

The Dry Block, Sunlight Resistant Indoor/Outdoor Loose Tube riser and plenum rated cable lines offer the system designer the smallest form factor in a premises indoor/outdoor optical fiber cable. The cables can be installed in open spaces, trays, conduits, inner-ducts, trenches, steam tunnels and building riser or plenum locations. The cables incorporate the latest in dry water-blocking technology which eliminates the need to clean off the traditional gel-based water-blocking compounds. In the single unit design, a 3 mm central tube contains 2 to 12, 250 μm fibers and water-blocking aramid yarns. The tube is surrounded by additional water-blocking glass strength elements and an outer jacket, comprised of a rugged UL Listed, sunlight resistant, black polymer that allows for the cable to be exposed to long-term direct sunlight without the concern of material degradation. All fiber types are available, including 50/125 μm , 62.5/125 μm and single mode.

APPLICATIONS

- Intra/inter-building backbones, such as conduit pathways or tunnels
- Conduit/duct/tray pathways
- Dry or wet locations

FEATURES

- Exceeds ANSI/TIA-568-C.3 optical performance
- Dry-block design meets Telcordia ANSI/ICEA S-104-696 water-block requirements
- 3 mm subunit
- UL/NEC Listed OFNR/OFNP
- All dielectric
- Jacket rip cord
- Black, UL Listed sunlight resistant outer jacket
- BrakeBox[®] payout control system
- Tube color indicates fiber type

BENEFITS

- Future-proof fiber performance for current and future multi-gigabit applications
- Cable integrity maintained even if damage occurs to protective layers
- Attaches directly to MTP[®] or MPO mechanical connectors
- Eliminates the need to purchase separate cables for OSP and indoor/riser or plenum applications
- No additional grounding materials need to be purchased
- Saves time in cable preparation
- Long periods of direct sunlight exposure will not damage cable
- Adjustable tension control on reel prevents over spin and entangling of cable
- Quickly identifies the fiber type without searching for the jacket print

PART NUMBER KEY

F	3 or 4	6	0	-	-	-	-	U	x	x	-	E	y	y	1
1	2	3	4	5	6	7	8	9	10	11	12	13	14	15	16
Fiber cable	Listing	Cable type			-	Fiber count (002-012)			Fiber type			-	Jacket color	Package	Jacket print

Contact Customer Service for availability of non-standard offerings.

PART NUMBERS AND PHYSICAL CHARACTERISTICS

Listing	Part Number ¹	Fiber Count	Nominal Diameter in (mm)	Nominal Weight lbs/kft (kg/km)	Maximum Tensile Loading		Minimum Bend Radius		Package ¹
					Install lbs (N)	Long Term lbs (N)	Install in (mm)	Long Term in (mm)	
OFNR	F360-002Uxx-Eyy1	2	0.24 (6.1)	22 (32)	300 (1,340)	90 (400)	3.6 (88)	2.4 (60)	use key
OFNR	F360-004Uxx-Eyy1	4	0.24 (6.1)	23 (34)	300 (1,340)	90 (400)	3.6 (88)	2.4 (60)	use key
OFNR	F360-006Uxx-Eyy1	6	0.24 (6.1)	23 (34)	300 (1,340)	90 (400)	3.6 (88)	2.4 (60)	use key
OFNR	F360-008Uxx-Eyy1	8	0.24 (6.1)	23 (34)	300 (1,340)	90 (400)	3.6 (88)	2.4 (60)	use key
OFNR	F360-012Uxx-Eyy1	12	0.24 (6.1)	23 (34)	300 (1,340)	90 (400)	3.6 (88)	2.4 (60)	use key
OFNP	F460-002Uxx-Eyy1	2	0.23 (5.8)	27 (41)	300 (1,340)	90 (400)	3.5 (87)	2.3 (58)	use key
OFNP	F460-004Uxx-Eyy1	4	0.23 (5.8)	28 (42)	300 (1,340)	90 (400)	3.5 (87)	2.3 (58)	use key
OFNP	F460-006Uxx-Eyy1	6	0.23 (5.8)	28 (42)	300 (1,340)	90 (400)	3.5 (87)	2.3 (58)	use key
OFNP	F460-008Uxx-Eyy1	8	0.23 (5.8)	28 (42)	300 (1,340)	90 (400)	3.5 (87)	2.3 (58)	use key
OFNP	F460-012Uxx-Eyy1	12	0.23 (5.8)	28 (42)	300 (1,340)	90 (400)	3.5 (87)	2.3 (58)	use key

FIBER TYPES / JACKET COLOR:	SINGLE MODE				MULTIMODE			
	Reduced Water Peak	TeraFlex® Bend Resistant			TeraGain®	TeraFlex Bend Resistant Laser Optimized 50/125		
		G.657.A1	G.657.A2	G.657.B3	62.5/125	10G/150	10G/300	10G/550
¹ Replace "xx" with: Indoor/Outdoor Jacket Color	10	13	14	15	23	28	30	32
	Black				Black			

See "Optical Fiber Specifications" in the "Technical Information" section for detailed fiber type specifications.

PACKAGING:		
	Cut to Length Plywood Reel	1,000 ft BrakeBox
¹ Replace "yy" with:	99	A5

Breakout

OFNR

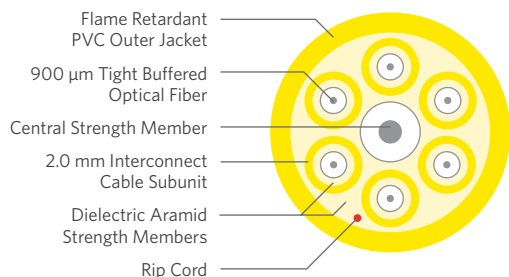

SPECIFICATIONS

Configuration	2.0 mm subunits surrounding a central strength element with overall jacket
Subunit Configuration	2.0 mm simplex with 900 micron tight buffered fiber and aramid yarns
Subunit Marking	Unit 1, Unit 2, etc.
Strength Elements	Glass Reinforced Plastic (GRP) central strength element with PVC jacket
Jacket	Yellow, flame retardant (FR) PVC
Performance Compliance	UL 1651 CSA C22.2 No. 232 UL 1666 Telcordia® GR-409-CORE, Issue 2 ANSI/ICEA S-83-596 ANSI/TIA-568-C.3
NRTL Programs	UL, c(UL) Listed OFNR
Sustainability	UL Certified EPD HPD USGBC® Member RoHS-compliant/RoHS 2-compliant REACH-compliant

PRODUCT DESCRIPTION

FIRST MANUFACTURER IN THE INDUSTRY
to offer products that contribute toward LEED!

The optical fiber Breakout Cable from Superior Essex is designed with Central Office (CO) connectivity in mind. The cable consists of 2 mm interconnect cable subunits surrounding a central strength element. The subunits are surrounded by aramid yarns and a flame retardant PVC riser-rated jacket, and each is ideally suited to be attached to small form factor connectors. The cable is available in 6, 12 and 24-fiber count configurations.

APPLICATIONS

- Central Office (CO)

FEATURES

- UL® Certified Environmental Product Declaration (EPD)
- Health Product Declaration™ (HPD™)
- 2.0 mm simplex interconnect subunits
- Meets or exceeds ICEA S-83-596 and GR-409-CORE requirements for interconnect subunits and cable
- Riser (OFNR) rated designs

BENEFITS

- Contributes toward 1 LEED point under the Material and Resources credit (MRc)
- Contributes toward 1 LEED point under the MRC
- Connects directly to small form factor connectors, like the LC
- Worry-free installation and performance
- Fire-listed cables allow placement in riser spaces

ENVIRONMENTAL SPECIFICATIONS

Operation	-20°C to +70°C
Storage/Shipping	-40°C to +75°C
Installation	10°C to +60°C

PART NUMBERS AND PHYSICAL CHARACTERISTICS

Listing	Part Number	Fiber Count	Nominal Diameter in (mm)	Nominal Weight lbs/kft (kg/km)	Maximum Tensile Loading		Minimum Bend Radius		Package
					Install lbs (N)	Long Term lbs (N)	Install in (mm)	Long Term in (mm)	
OFNR	T30063201	6	0.34 (8.8)	45 (66)	150 (660)	45 (200)	5.2 (132)	3.4 (88)	Plywood reel
OFNR	T30123201	12	0.43 (11.0)	64 (95)	150 (660)	45 (200)	6.5 (165)	4.3 (110)	Plywood reel
OFNR	T30243201	24	0.58 (14.8)	122 (181)	300 (1,320)	90 (400)	8.7 (222)	5.8 (148)	Plywood reel

SUSTAINABILITY LEADERSHIP



UL and the related logo are registered trademarks of UL LLC. Health Product Declaration, HPD and the related logo are trademarks of Health Product Declaration Collaborative. Telcordia is a registered trademark of Ericsson Inc. USGBC and the related logo are registered trademarks of U.S. Green Building Council.

nCompass™

a suite of high performance
cabling systems brought to you by
Legrand® and **Superior Essex®**



complete efficiency.

complete flexibility.

complete reliability.

complete support.

connect. completely.

www.nCompass-systems.com

All information, content, data, specifications, packaging and part numbers detailed herein are subject to change. For the most up-to-date information, please visit SuperiorEssex.com. Purchase of this product is subject exclusively to the then current Superior Essex International LP Terms and Conditions of Sale for Communications and Energy Cable, Wire and Connectivity Products, which can be found on our website, SuperiorEssex.com, or provided to you upon request.

800.551.8948
SuperiorEssex.com



Single Unit Distribution

OFNR/OFNP

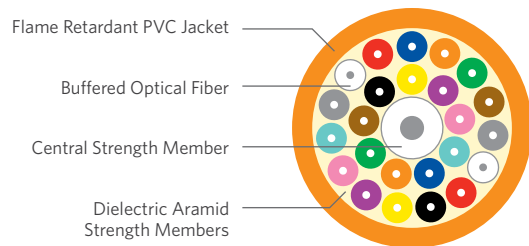

PRODUCT DESCRIPTION



FIRST MANUFACTURER IN THE INDUSTRY
to offer products that contribute toward LEED!

These Superior Essex premises distribution optical fiber cables are constructed using a single unit, single jacket RoHS-compliant design with fiber counts from 6 through 24. The design consists of flexible 900 µm tight buffered industry standard 250 µm fibers (900/250/125 µm) and is suitable for use with standard connectors, like the SC, ST, and FC, and small-form-factor connectors like the LC. Dielectric aramid yarns are applied for strength while maintaining flexibility. The 18 and 24-fiber cable designs have a flexible glass reinforced central strength element for added durability and performance. A durable, flame resistant outer jacket is applied over the cable core using appropriate OFNR or OFNP rated materials.

APPLICATIONS

- Intrabuilding backbones
- Conduit pathways
- Service entrance to communication closets
- "Behind-the-shelf" connections

FEATURES

- UL® Certified Environmental Product Declaration (EPD)
- Health Product Declaration™ (HPD™)
- Marked in feet and meters
- BrakeBox® payout control system

BENEFITS

- Contributes toward 1 LEED point under the Material and Resources credit (MRc)
- Contributes toward 1 LEED point under the MRC
- Meets commercial, government and international requirements for length markings
- Adjustable tension control on reel prevents over spin and entangling of cable

SPECIFICATIONS

6-12 Fiber Configuration	Flexible 900 µm tight buffered fibers, dielectric aramid yarns and overall jacket
18-24 Fiber Configuration	Band marked flexible 900 µm tight buffered fibers, dielectric aramid yarns, overall jacket and central strength element
Jacket	OFNR: Flame retardant (FR) PVC OFNP: FR, low smoke PVC
Performance Compliance	UL 1651 CSA C22.2 No. 232 UL 1666 NFPA 262 Telcordia® GR-409, Issue 1 Telcordia GR-409, Issue 2 ANSI/ICEA S-83-596 ANSI/TIA-568-C.3
NRTL Programs	UL, c(UL) Listed OFNR UL, c(UL) Listed OFNP
Sustainability	UL Certified EPD HPD USGBC® Member RoHS-compliant/RoHS 2-compliant REACH-compliant

ENVIRONMENTAL SPECIFICATIONS

	Riser	Plenum
Operation	-20°C to +75°C	0°C to +75°C
Storage/Shipping	-40°C to +75°C	-40°C to +75°C
Installation	-20°C to +65°C	0°C to +65°C

SUSTAINABILITY LEADERSHIP



UL and the related logo are registered trademarks of UL LLC. Health Product Declaration, HPD and the related logo are trademarks of Health Product Declaration Collaborative. Telcordia is a registered trademark of Ericsson Inc. USGBC and the related logo are registered trademarks of U.S. Green Building Council.

PART NUMBERS AND PHYSICAL CHARACTERISTICS

Listing	Part Number ¹	Fiber Type	Fiber Count	Nominal Diameter in (mm)	Nominal Weight lbs/kft (kg/km)	Maximum Tensile Loading		Minimum Bend Radius		Package
						Install lbs (N)	Long Term lbs (N)	Install in (mm)	Long Term in (mm)	
OFNR	43006x1zz	Single mode	6	0.20 (5.0)	17 (25)	150 (660)	45 (200)	3.0 (75)	2.0 (50)	use key
OFNR	43008x1zz	Single mode	8	0.24 (6.0)	20 (30)	150 (660)	45 (200)	3.5 (90)	2.4 (60)	use key
OFNR	43012x1zz	Single mode	12	0.26 (6.5)	25 (37)	150 (660)	45 (200)	3.8 (98)	2.6 (65)	use key
OFNR	43018xK01*	Single mode	18	0.30 (7.5)	35 (51)	300 (1,320)	90 (400)	4.4 (113)	3.0 (75)	Plywood reel
OFNR	43024xK01*	Single mode	24	0.33 (8.5)	44 (66)	300 (1,320)	90 (400)	5.0 (128)	3.3 (85)	Plywood reel
OFNP	44006x1zz	Single mode	6	0.20 (5.0)	17 (25)	100 (440)	30 (130)	3.0 (75)	2.0 (50)	use key
OFNP	44008x1zz	Single mode	8	0.21 (5.4)	19 (28)	100 (440)	30 (130)	3.2 (81)	2.1 (54)	use key
OFNP	44012x1zz	Single mode	12	0.24 (6.2)	24 (35)	100 (440)	30 (130)	3.7 (93)	2.4 (62)	use key
OFNP	44018xK01*	Single mode	18	0.28 (7.0)	33 (49)	150 (660)	45 (200)	4.1 (105)	2.8 (70)	Plywood reel
OFNP	44024xK01	Single mode	24	0.31 (7.8)	42 (62)	150 (660)	45 (200)	4.6 (117)	3.1 (78)	Plywood reel
OFNR	43006yGzz	Multimode	6	0.20 (5.0)	17 (25)	150 (660)	45 (200)	3.0 (75)	2.0 (50)	use key
OFNR	43008yGzz	Multimode	8	0.24 (6.0)	20 (30)	150 (660)	45 (200)	3.5 (90)	2.4 (60)	use key
OFNR	43012yGzz	Multimode	12	0.26 (6.5)	25 (37)	150 (660)	45 (200)	3.8 (98)	2.6 (65)	use key
OFNR	43018yK01	Multimode	18	0.30 (7.5)	35 (51)	300 (1,320)	90 (400)	4.4 (113)	3.0 (75)	Plywood reel
OFNR	43024yK01	Multimode	24	0.33 (8.5)	44 (66)	300 (1,320)	90 (400)	5.0 (128)	3.3 (85)	Plywood reel
OFNP	44006yGzz	Multimode	6	0.20 (5.0)	17 (25)	100 (440)	30 (130)	3.0 (75)	2.0 (50)	use key
OFNP	44008yGzz	Multimode	8	0.21 (5.4)	19 (28)	100 (440)	30 (130)	3.2 (81)	2.1 (54)	use key
OFNP	44012yGzz	Multimode	12	0.24 (6.2)	24 (35)	100 (440)	30 (130)	3.7 (93)	2.4 (62)	use key
OFNP	44018yK01	Multimode	18	0.28 (7.0)	33 (49)	150 (660)	45 (200)	4.1 (105)	2.8 (70)	Plywood reel
OFNP	44024yK01	Multimode	24	0.31 (7.8)	42 (62)	150 (660)	45 (200)	4.6 (117)	3.1 (78)	Plywood reel

*Only available with TeraFlex® Bend Resistant single mode optical fiber types.

SINGLE MODE OPTICAL FIBER TYPES

	Reduced Water Peak	TeraFlex® Bend Resistant		
		G.657.A1	G.657.A2	G.657.B3
¹ Replace "x" with:	3	K	J	L
Standard Jacket Colors*		Yellow		

MULTIMODE OPTICAL FIBER TYPES

	TeraGain® 62.5/125	TeraGain Laser Optimized 50/125			TeraFlex Bend Resistant Laser Optimized 50/125		
		10G/150	10G/300	10G/550	10G/150	10G/300	10G/550
¹ Replace "y" with:	6	A	B	F	M	N	P
Standard Jacket Colors*	Orange	Aqua					

*Other jacket colors available upon request.

See "Optical Fiber Specifications" in the "Technical Information" section for detailed fiber type specifications.

PACKAGING

	Cut to Length Plywood Reel	1,000 ft BrakeBox	1,500 ft BrakeBox	2,000 ft BrakeBox
¹ Replace "zz" with:	01	BB	BD	BC

Multi-Unit Distribution

OFNR/OFNP

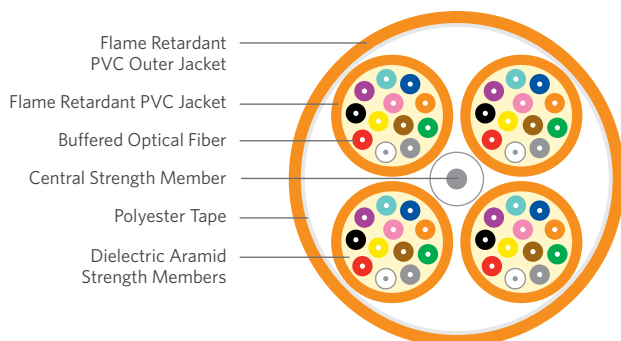

SPECIFICATIONS

18-36 Fiber Configuration 6-fiber subunits, reverse oscillating lay (ROL) stranded around flexible high-strength glass reinforced rod

36-144 Fiber Configuration 12-fiber subunits, ROL stranded around flexible high-strength glass reinforced rod

Subunit Jacket OFNR: Flame retardant (FR) PVC
OFNP: FR, low smoke (LS) PVC

Outer Jacket OFNR: FR PVC
OFNP: FR PVDF or LS PVC

Performance Compliance UL 1651
CSA C22.2 No. 232
UL 1666
NFPA 262
Telcordia® GR-409-CORE, Issue 2
ANSI/ICEA S-83-596
ANSI/TIA-568-C.3

NRTL Programs UL, c(UL) Listed OFNR
UL, c(UL) Listed OFNP

Sustainability UL Certified EPD
HPD
USGBC® Member
RoHS-compliant/RoHS 2-compliant
REACH-compliant

ENVIRONMENTAL SPECIFICATIONS

	Riser	Plenum
Operation	-20°C to +75°C	0°C to +75°C
Storage/Shipping	-40°C to +75°C	-40°C to +75°C
Installation	0°C to +65°C	0°C to +65°C

SUSTAINABILITY LEADERSHIP



UL and the related logo are registered trademarks of UL LLC. Health Product Declaration, HPD and the related logo are trademarks of Health Product Declaration Collaborative. Telcordia is a registered trademark of Ericsson Inc. USGBC and the related logo are registered trademarks of U.S. Green Building Council.

PRODUCT DESCRIPTION

FIRST MANUFACTURER IN THE INDUSTRY
to offer products that contribute toward LEED!

Premises Multi-unit Distribution Optical Fiber Cables are constructed using 6 or 12-fiber subunits stranded around a central strength member in a RoHS-compliant design for fiber counts from 18 through 144. Standard fibers for these cables include Reduced Water Peak (RWP) single mode, TeraGain® 220/600 62.5 μm multimode and TeraFlex® 10G/150 - laser optimized 50 μm multimode fiber. All fibers exceed industry requirements.

The design consists of flexible 900 μm tight buffered industry standard 250 μm fibers (900/250/125 μm) and is suitable for use with standard connectors, like the SC, ST, and FC, and small-form-factor connectors like the LC. Subunits are constructed using dielectric aramid yarns for strength while maintaining flexibility and are jacketed using the color appropriate to the type of fiber in the cable. The subunits are then stranded around a flexible high-strength glass reinforced rod which provides exceptional resistance to dimensional changes due to temperature. A durable, flame resistant outer jacket is applied over the cable core using appropriate OFNR or OFNP rated materials.

APPLICATIONS

- Intrabuilding backbones
- Conduit pathways
- Service entrance to communication closets
- "Behind-the-shelf" connections

FEATURES

- UL® Certified Environmental Product Declaration (EPD)
- Health Product Declaration™ (HPD™)
- Subunits are color coded according to fiber type
- Numbered subunits
- Marked in feet and meters

BENEFITS

- Contributes toward 1 LEED point under the Material and Resources credit (MRc)
- Contributes toward 1 LEED point under the MRc
- Easily identify fiber type
- Easily identifies correct subunit on each end
- Length marking for both commercial and military/government

PART NUMBERS AND PHYSICAL CHARACTERISTICS

Listing	Part Number ¹	Fiber Type	Fiber Count	Fibers Per Subunit	Nominal Diameter in (mm)	Nominal Weight lbs/kft (kg/km)	Maximum Tensile Loading		Minimum Bend Radius		Package
							Install lbs (N)	Long Term lbs (N)	Install in (mm)	Long Term in (mm)	
OFNR	43018x101	Single mode	18	6	0.55 (13.9)	96 (143)	600 (2,640)	180 (800)	8.1 (206)	5.4 (137)	Reel
OFNR	43024x101	Single mode	24	6	0.58 (14.8)	117 (174)	600 (2,640)	180 (800)	8.6 (218)	5.7 (146)	Reel
OFNR	43030x101	Single mode	30	6	0.63 (16.0)	140 (210)	600 (2,640)	180 (800)	9.3 (236)	6.2 (158)	Reel
OFNR	43036x101	Single mode	36	6	0.69 (17.5)	171 (255)	600 (2,640)	180 (800)	10.2 (260)	6.8 (174)	Reel
OFNR	43036xE01	Single mode	36	12	0.69 (17.5)	150 (224)	600 (2,640)	180 (800)	10.3 (262)	6.9 (175)	Reel
OFNR	43048x101	Single mode	48	12	0.69 (17.5)	150 (224)	600 (2,640)	180 (800)	10.3 (262)	6.9 (175)	Reel
OFNR	43060x101	Single mode	60	12	0.77 (19.5)	195 (291)	600 (2,640)	180 (800)	11.5 (292)	7.7 (195)	Reel
OFNR	43072x101	Single mode	72	12	0.82 (21.0)	233 (348)	600 (2,640)	180 (800)	12.4 (314)	8.2 (210)	Reel
OFNR	43084x101	Single mode	84	12	0.92 (23.3)	289 (431)	600 (2,640)	180 (800)	13.7 (349)	9.2 (233)	Reel
OFNR	43096x101	Single mode	96	12	0.97 (24.7)	337 (503)	600 (2,640)	180 (800)	14.6 (370)	9.7 (247)	Reel
OFNR	43144x101	Single mode	144	12	1.11 (28.3)	362 (540)	600 (2,640)	180 (800)	16.7 (425)	11.1 (283)	Reel
OFNP	44018x101	Single mode	18	6	0.55 (13.9)	117 (175)	600 (2,640)	180 (800)	8.1 (206)	5.4 (138)	Reel
OFNP	44024x101	Single mode	24	6	0.58 (14.8)	141 (211)	600 (2,640)	180 (800)	8.6 (219)	5.7 (146)	Reel
OFNP	44030x101	Single mode	30	6	0.63 (16.0)	176 (262)	600 (2,640)	180 (800)	9.3 (237)	6.2 (158)	Reel
OFNP	44036x101	Single mode	36	6	0.69 (17.5)	206 (307)	600 (2,640)	180 (800)	10.3 (261)	6.9 (174)	Reel
OFNP	44036xE01	Single mode	36	12	0.67 (17.1)	189 (282)	600 (2,640)	180 (800)	10.1 (257)	6.7 (171)	Reel
OFNP	44048x101	Single mode	48	12	0.67 (17.1)	189 (282)	600 (2,640)	180 (800)	10.1 (257)	6.7 (171)	Reel
OFNP	44060x101	Single mode	60	12	0.74 (18.9)	229 (341)	600 (2,640)	180 (800)	11.2 (284)	7.4 (189)	Reel
OFNP	44072x101	Single mode	72	12	0.81 (20.6)	276 (412)	600 (2,640)	180 (800)	12.2 (309)	8.1 (206)	Reel
OFNP	44096x101	Single mode	96	12	0.87 (22.0)	313 (467)	600 (2,640)	180 (800)	13.0 (330)	8.7 (220)	Reel
OFNP	44144x101	Single mode	144	12	0.92 (23.4)	318 (474)	600 (2,640)	180 (800)	13.8 (351)	9.2 (234)	Reel
OFNR	43018yG01	Multimode	18	6	0.55 (13.9)	96 (143)	600 (2,640)	180 (800)	8.1 (206)	5.4 (137)	Reel
OFNR	43024yG01	Multimode	24	6	0.58 (14.8)	117 (174)	600 (2,640)	180 (800)	8.6 (218)	5.7 (146)	Reel
OFNR	43030yG01	Multimode	30	6	0.63 (16.0)	140 (210)	600 (2,640)	180 (800)	9.3 (236)	6.2 (158)	Reel
OFNR	43036yG01	Multimode	36	6	0.69 (17.5)	171 (255)	600 (2,640)	180 (800)	10.2 (260)	6.8 (174)	Reel
OFNR	43036yE01	Multimode	36	12	0.69 (17.5)	155 (232)	600 (2,640)	180 (800)	10.3 (262)	6.9 (175)	Reel
OFNR	43048yG01	Multimode	48	12	0.69 (17.5)	155 (232)	600 (2,640)	180 (800)	10.3 (262)	6.9 (175)	Reel
OFNR	43060yG01	Multimode	60	12	0.77 (19.5)	195 (291)	600 (2,640)	180 (800)	11.5 (292)	7.7 (195)	Reel
OFNR	43072yG01	Multimode	72	12	0.82 (21.0)	233 (348)	600 (2,640)	180 (800)	12.4 (314)	8.2 (210)	Reel
OFNR	43084yG01	Multimode	84	12	0.92 (23.3)	289 (431)	600 (2,640)	180 (800)	13.7 (349)	9.2 (233)	Reel
OFNR	43096yG01	Multimode	96	12	0.97 (24.7)	337 (503)	600 (2,640)	180 (800)	14.6 (370)	9.7 (247)	Reel
OFNR	43144yG01	Multimode	144	12	1.11 (28.3)	362 (540)	600 (2,640)	180 (800)	16.7 (425)	11.1 (283)	Reel
OFNP	44018yG01	Multimode	18	6	0.55 (13.9)	117 (175)	600 (2,640)	180 (800)	8.1 (206)	5.4 (138)	Reel
OFNP	44024yG01	Multimode	24	6	0.58 (14.8)	141 (211)	600 (2,640)	180 (800)	8.6 (219)	5.7 (146)	Reel
OFNP	44030yG01	Multimode	30	6	0.63 (16.0)	176 (262)	600 (2,640)	180 (800)	9.3 (237)	6.2 (158)	Reel
OFNP	44036yG01	Multimode	36	6	0.69 (17.5)	206 (307)	600 (2,640)	180 (800)	10.3 (261)	6.9 (174)	Reel
OFNP	44036yE01	Multimode	36	12	0.67 (17.1)	189 (282)	600 (2,640)	180 (800)	10.1 (257)	6.7 (171)	Reel
OFNP	44048yG01	Multimode	48	12	0.67 (17.1)	189 (282)	600 (2,640)	180 (800)	10.1 (257)	6.7 (171)	Reel
OFNP	44060yG01	Multimode	60	12	0.74 (18.9)	229 (341)	600 (2,640)	180 (800)	11.2 (284)	7.4 (189)	Reel
OFNP	44072yG01	Multimode	72	12	0.81 (20.6)	276 (412)	600 (2,640)	180 (800)	12.2 (309)	8.1 (206)	Reel
OFNP	44096yG01	Multimode	96	12	0.87 (22.0)	313 (467)	600 (2,640)	180 (800)	13.0 (330)	8.7 (220)	Reel
OFNP	44144yG01	Multimode	144	12	0.92 (23.4)	318 (474)	600 (2,640)	180 (800)	13.8 (351)	9.2 (234)	Reel

SINGLE MODE OPTICAL FIBER TYPES

	Reduced Water Peak	TeraFlex® Bend Resistant		
		G.657.A1	G.657.A2	G.657.B3
¹ Replace "x" with:	3	K	J	L
Standard Jacket Colors*		Yellow		

MULTIMODE OPTICAL FIBER TYPES

	TeraGain® 62.5/125	TeraGain Laser Optimized 50/125			TeraFlex Bend Resistant Laser Optimized 50/125		
		10G/150	10G/300	10G/550	10G/150	10G/300	10G/550
¹ Replace "y" with:	6	A	B	F	M	N	P
Standard Jacket Colors*		Orange			Aqua		

*Other jacket colors available upon request.
See "Optical Fiber Specifications" in the "Technical Information" section for detailed fiber type specifications.

Ribbon Distribution

OFNR/OFNP

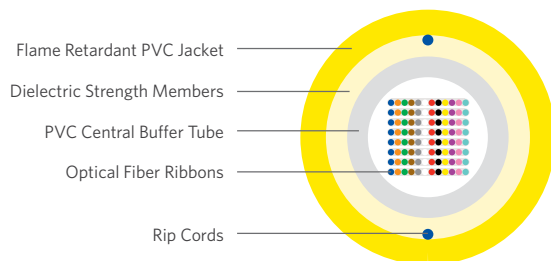
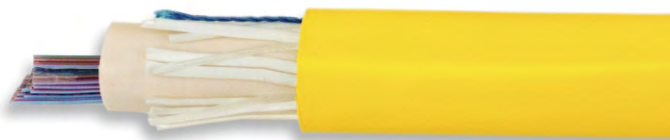

Flame Retardant PVC Jacket

Dielectric Strength Members

PVC Central Buffer Tube

Optical Fiber Ribbons

Rip Cords

SPECIFICATIONS

≤ 216-Fiber Configuration	Standards compliant 12-fiber ribbon subunits
> 216-Fiber Configuration	Two standards compliant 12-fiber ribbon subunits conjoined to form a 24-fiber ribbon subunit
Jacket	OFNR: Flame retardant (FR) PVC OFNP: FR, low smoke PVC
Performance Compliance	UL 1651 CSA C22.2 No. 232 UL 1666 Telcordia® GR-409, Issue 2 ANSI/ICEA S-83-596 ANSI/TIA-568-C.3 RoHS-compliant/RoHS 2-compliant
NRTL Programs	UL c(UL) Listed OFNR; FT4 UL c(UL) Listing OFNP

ENVIRONMENTAL SPECIFICATIONS

	Riser	Plenum
Operation	-20°C to +75°C	0°C to +75°C
Storage/Shipping	-40°C to +75°C	-40°C to +75°C
Installation	0°C to +75°C	+20°C to +75°C

PRODUCT DESCRIPTION

Superior Essex's Premises Ribbon Distribution cables contain 12 to 288 optical fibers. The fibers are grouped in the form of 12-fiber flat ribbons. For fiber counts greater than 216, two 12-fiber ribbons are conjoined to form a 24-fiber ribbon subunit that's easily separable into two 12-fiber ribbons. The optical fiber ribbons are stacked within a single, flame-retardant, PVC central buffer tube. Dual layers of stranded dielectric strength elements are wrapped around the central tube for tensile and compression strength. A riser or plenum rated PVC sheath covers the strength elements and the cables have highly visible ripcords underneath the jacket for rapid sheath entry.

The ribbon cables are available with an OFNR listing passing the UL® 1666 riser burn test or OFNP listing passing NFPA 262 plenum test. The cables are ideal for high density requirements where conduit space is limited. This cable also meets or exceeds the distribution cable requirements of ANSI/ICEA-596 and Telcordia® GR-409-CORE, Issue 2.

APPLICATIONS

- Intra-building backbones
- Conduit, duct or tray pathways
- Premises locations

FEATURES

- Exceeds ANSI/TIA-568-C.3
- Small, compact design
- 12-fiber ribbon subunits
- Two conjoined 12-fiber ribbons for counts greater than 216
- OFNR and OFNP listings
- Jacket ripcords

BENEFITS

- Future-proof fiber performance for current and future multi-gigabit applications
- Ideal for high density installation like data centers
- Easily mass fusion spliced or attached to MPT®/MPOs
- Keeps the form factor consistent for higher fiber counts
- Allows installation in any premises space
- Save time in cable preparation

PART NUMBER KEY

F	3 or 4	5	6	-	-	-	-	U	x	x	-	y	9	9	1
1	2	3	4	5	6	7	8	9	10	11	12	13	14	15	16
Fiber cable	Listing	Cable type		-	Fiber count (012-288)			Fiber type			-	Jacket color	Package		Jacket print

Contact Customer Service for availability of non-standard offerings.

PART NUMBERS AND PHYSICAL CHARACTERISTICS

Listing	Part Number ¹	Fiber Count	Nominal Diameter in (mm)	Nominal Weight lbs/kft (kg/km)	Maximum Tensile Loading		Minimum Bend Radius	
					Install lbs (N)	Long Term lbs (N)	Install in (mm)	Long Term in (mm)
OFNR	F356-012Uxx-y991	12	0.56 (14.2)	126 (188)	300 (1,334)	100 (445)	10.4 (264)	5.2 (132)
OFNR	F356-024Uxx-y991	24	0.56 (14.2)	127 (189)	300 (1,334)	100 (445)	10.4 (264)	5.2 (132)
OFNR	F356-048Uxx-y991	48	0.56 (14.2)	128 (191)	300 (1,334)	100 (445)	10.4 (264)	5.2 (132)
OFNR	F356-060Uxx-y991	60	0.56 (14.2)	130 (193)	300 (1,334)	100 (445)	10.4 (264)	5.2 (132)
OFNR	F356-072Uxx-y991	72	0.56 (14.2)	130 (194)	300 (1,334)	100 (445)	10.4 (264)	5.2 (132)
OFNR	F356-084Uxx-y991	84	0.56 (14.2)	131 (195)	300 (1,334)	100 (445)	10.4 (264)	5.2 (132)
OFNR	F356-096Uxx-y991	96	0.56 (14.2)	132 (196)	300 (1,334)	100 (445)	10.4 (264)	5.2 (132)
OFNR	F356-144Uxx-y991	144	0.63 (16.0)	149 (221)	300 (1,334)	100 (445)	12.4 (314)	6.2 (157)
OFNR	F356-216Uxx-y991	216	0.63 (16.0)	155 (230)	300 (1,334)	100 (445)	12.4 (314)	6.2 (157)
OFNR	F356-288Uxx-y991	288	0.81 (20.5)	200 (298)	600 (2,670)	200 (890)	16.2 (410)	8.1 (205)
OFNP	F456-012Uxx-y991	12	0.55 (14.0)	124 (184)	300 (1,334)	100 (445)	11.0 (280)	5.5 (140)
OFNP	F456-024Uxx-y991	24	0.55 (14.0)	124 (185)	300 (1,334)	100 (445)	11.0 (280)	5.5 (140)
OFNP	F456-048Uxx-y991	48	0.55 (14.0)	126 (187)	300 (1,334)	100 (445)	11.0 (280)	5.5 (140)
OFNP	F456-060Uxx-y991	60	0.55 (14.0)	127 (189)	300 (1,334)	100 (445)	11.0 (280)	5.5 (140)
OFNP	F456-072Uxx-y991	72	0.55 (14.0)	128 (190)	300 (1,334)	100 (445)	11.0 (280)	5.5 (140)
OFNP	F456-084Uxx-y991	84	0.55 (14.0)	128 (191)	300 (1,334)	100 (445)	11.0 (280)	5.5 (140)
OFNP	F456-096Uxx-y991	96	0.55 (14.0)	129 (192)	300 (1,334)	100 (445)	11.0 (280)	5.5 (140)
OFNP	F456-144Uxx-y991	144	0.65 (16.6)	167 (249)	300 (1,334)	100 (445)	13.0 (332)	6.5 (166)
OFNP	F456-216Uxx-y991	216	0.65 (16.6)	173 (257)	300 (1,334)	100 (445)	13.0 (332)	6.5 (166)
OFNP	F456-288Uxx-y991	288	0.85 (21.6)	252 (376)	300 (1,334)	100 (445)	17.0 (432)	8.5 (216)

FIBER TYPES / STANDARD JACKET COLORS: [*]	SINGLE MODE				MULTIMODE			
	Reduced Water Peak	TeraFlex® Bend Resistant			TeraGain® 62.5/125	TeraFlex Bend Resistant Laser Optimized 50/125		
		G.657.A1	G.657.A2	G.657.B3		10G/150	10G/300	10G/550
¹ Replace "xx" with:	10	13	14	15	23	28	30	32
¹ Replace "y" with:	Yellow = 6				Orange = D	Aqua = K		

^{*}Other jacket colors available upon request.
See "Optical Fiber Specifications" in the "Technical Information" section for detailed fiber type specifications.

UL is a registered trademark of UL LLC. Telcordia is a registered trademark of Ericsson Inc.

Compact and Rugged Indoor MDU

OFNR

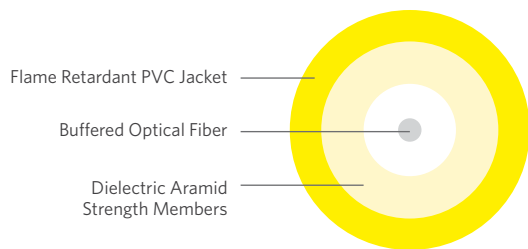

Flame Retardant PVC Jacket

Buffered Optical Fiber

Dielectric Aramid
Strength Members

SPECIFICATIONS

Configuration	Simplex 900 micron tight buffered fiber surrounded by aramid yarns and covered by a riser-rated flame retardant jacket
Strength Elements	Dielectric aramid yarns
Jacket	Yellow, flame retardant PVC (other jacket colors available upon request)
Performance Compliance	UL 1666 ANSI/ICEA S-83-596 ICEA S-115-730-2011 ANSI/TIA-568-C.3 REACH-compliant
NRTL Programs	UL, c(UL) Listed OFNR
Sustainability	UL Certified EPD HPD USGBC® Member RoHS-compliant/RoHS 2-compliant REACH-compliant

ENVIRONMENTAL SPECIFICATIONS

Operation	-20°C to +70°C
Storage/Shipping	-40°C to +70°C
Installation	-10°C to +65°C

PART NUMBERS AND PHYSICAL CHARACTERISTICS

Listing	Part Number ¹	Fiber Count	Nominal Diameter in (mm)	Nominal Weight lbs/kft (kg/km)	Maximum Tensile Loading		Minimum Bend Radius	
					Install lbs (N)	Long Term lbs (N)	Install in (mm)	Long Term in (mm)
OFNR	D3001L3yy	1	0.11 (2.9)	2.5 (4.0)	50 (220)	15 (66)	2.0 (50)	0.2 (5)
OFNR	D3001L5yy	1	0.19 (4.8)	6.2 (9.3)	100 (450)	30 (132)	2.0 (50)	0.2 (5)

Other jacket colors available upon request.

PACKAGING

	Cut to Length Plywood Reel	1,000 ft BrakeBox	1,500 ft BrakeBox	2,000 ft BrakeBox
¹ Replace "yy" with:	01	BB	BD	BC

SUSTAINABILITY LEADERSHIP



UL and the related logo are registered trademarks of UL LLC. Health Product Declaration, HPD and the related logo are trademarks of Health Product Declaration Collaborative. USGBC and the related logo are registered trademarks of U.S. Green Building Council.

PRODUCT DESCRIPTION



FIRST MANUFACTURER IN THE INDUSTRY
to offer products that contribute toward LEED!

Both the Compact MDU 2.9 mm simplex cable and the Rugged Indoor MDU 4.8 mm simplex cable meet ICEA-730 Draft specification for MDU cables. The 2.9 mm is ideal for low-stress installations where space is a premium. The 4.8 mm is more robust and can handle installation tensions as high as 100 pounds. Both cables are available with G.657.B3 compliant bend resistant single mode fiber, preventing light loss even under tight bends.

APPLICATIONS

- Multi-Dwelling Units (MDU)
- Horizontal (non-plenum) or riser spaces
- Optical entrance facility to end-user
- Passive optical networks

FEATURES

- UL® Certified Environmental Product Declaration (EPD)
- Health Product Declaration™ (HPD™)
- ICEA S-115-730-2011 and ICEA-596 compliant
- Available with G.657.B3 single mode fiber
- Riser rated
- Feet/meter length marking
- BrakeBox® payout control system

BENEFITS

- Contributes toward 1 LEED point under the Material and Resources credit (MRc)
- Contributes toward 1 LEED point under the MRc
- Insures reliable installation and performance
- Assures low attenuation loss even under installation stresses, such as tight bends and cable stapling
- Meets fire safety requirements for MDUs
- No need for length unit conversion
- Adjustable tension control on reel prevents over spin and entangling of cable

PRODUCT DESCRIPTION

FIRST MANUFACTURER IN THE INDUSTRY
to offer products that contribute toward LEED!

The Rugged Indoor/Outdoor MDU is a 4.8 mm simplex cable that meets ICEA-730 specification for MDU cables. The cable is robust and can handle installation tensions as high as 100 pounds. The black jacket is UL® Listed Sunlight Resistant and the cable design employs dry block technology to prevent water penetration without the use of gels. This cable is available with G.657.B3 compliant bend resistant single mode fiber, preventing light loss even under tight bends.

APPLICATIONS

- Multi-Dwelling Units (MDU)
- Indoor or outdoor environments
- Horizontal (non-plenum) or riser spaces
- Optical entrance facility to end-user
- Passive optical networks

FEATURES

- UL Certified Environmental Product Declaration (EPD)
- Health Product Declaration™ (HPD™)
- ICEA S-115-730-2011 and ICEA-696 compliant
- Available with G.657.B3 single mode fiber
- Dry blocked core
- UL Sunlight Resistant
- Riser rated
- Feet/meter length marking
- BrakeBox® payout control system

BENEFITS

- Contributes toward 1 LEED point under the Material and Resources credit (MRc)
- Contributes toward 1 LEED point under the MRC
- Insures reliable installation and performance
- Assures low attenuation loss even under installation stresses, such as tight bends and cable stapling
- Prevents water ingress from OSP to ISP environments
- Assures reliable performance even after long term sunlight exposure
- Meets fire safety requirements for MDUs
- No need for length unit conversion
- Adjustable tension control on reel prevents over spin and entangling of cable

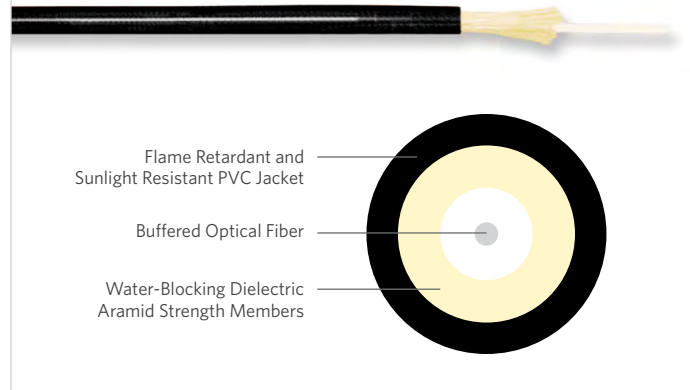

SPECIFICATIONS

Configuration	Simplex 900 micron tight buffered fiber surrounded by water-blocking aramid yarns and covered by a riser-rated flame retardant and sunlight resistant jacket
Strength Elements	Dielectric aramid yarns
Water-Blocking	SAP Dry Block
Jacket	Black, flame retardant, sunlight resistant PVC
Performance Compliance	UL 1666 Telcordia® GR-409-CORE, Issue 2 ANSI/ICEA S-83-696 ICEA S-115-730-2011 ANSI/TIA-568-C.3 REACH-compliant
NRTL Programs	UL, c(UL) Listed OFNR UL, c(UL) Listed Sunlight Resistant
Sustainability	UL Certified EPD HPD USGBC® Member RoHS-compliant/RoHS 2-compliant REACH-compliant

ENVIRONMENTAL SPECIFICATIONS

Operation	-40°C to +70°C
Storage/Shipping	-40°C to +70°C
Installation	-10°C to +65°C

PART NUMBERS AND PHYSICAL CHARACTERISTICS

Listing	Part Number ¹	Fiber Count	Nominal Diameter in (mm)	Nominal Weight lbs/kft (kg/km)	Maximum Tensile Loading		Minimum Bend Radius	
					Install lbs (N)	Long Term lbs (N)	Install in (mm)	Long Term in (mm)
OFNR	D5001L5yy	1	0.19 (4.8)	6.2 (9.3)	100 (450)	30 (132)	2.0 (50)	0.3 (7.5)

PACKAGING

	Cut to Length Plywood Reel	1,000 ft BrakeBox	1,500 ft BrakeBox	2,000 ft BrakeBox
¹ Replace "yy" with:	01	BB	BD	BC

SUSTAINABILITY LEADERSHIP



UL and the related logo are registered trademarks of UL LLC. Health Product Declaration, HPD and the related logo are trademarks of Health Product Declaration Collaborative. Telcordia is a registered trademark of Ericsson Inc. USGBC and the related logo are registered trademarks of U.S. Green Building Council.

Indoor/Outdoor Sunlight Resistant

OFNP



Flame Retardant, Chemical and Sunlight Resistant PVDF Jacket
 Flame Retardant PVDF Jacket
 Buffered Optical Fiber
 Central Strength Member
 Water-Blocking Tape
 Dielectric Aramid Strength Members
 Rip Cord

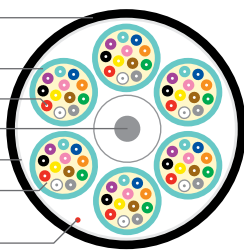

SPECIFICATIONS

18-36 Fiber Multi-Unit Configuration	6-fiber sub-units are grouped to form core; core consists of sub-units cabled with additional strength members
48-72 Fiber Multi-Unit Configuration	12-fiber sub-units are grouped to form core; core consists of sub-units cabled with additional strength members
Jacket	Flame retardant (FR), sunlight resistant black PVDF
Performance Compliance	UL 1651 CSA C22.2 No. 232 NFPA 262 Telcordia® GR-409-CORE, Issue 1 Telcordia GR-409-CORE, Issue 2 ANSI/ICEA S-83-596
NRTL Programs	UL, c(UL) Listed OFNP UL, c(UL) Listed Sunlight Resistant
Sustainability	UL Certified EPD HPD USGBC® Member RoHS-compliant/RoHS 2-compliant REACH-compliant

ENVIRONMENTAL SPECIFICATIONS

Operation	-20°C to +75°C
Storage/Shipping	-40°C to +75°C
Installation	-20°C to +65°C

SUSTAINABILITY LEADERSHIP



UL and the related logo are registered trademarks of UL LLC. Health Product Declaration, HPD and the related logo are trademarks of Health Product Declaration Collaborative. Telcordia is a registered trademark of Ericsson Inc. USGBC and the related logo are registered trademarks of U.S. Green Building Council.

PRODUCT DESCRIPTION



FIRST MANUFACTURER IN THE INDUSTRY
to offer products that contribute toward LEED!

Indoor/Outdoor Sunlight Resistant Tight Buffer Plenum optical fiber cables are ideally suited for installations that require partial or complete routing of pathways outside the building. These cables can be installed in inner ducts and steam tunnels, as well as within building riser and plenum locations. The tight buffer feature of these indoor/outdoor cables eliminates the need for breakout kits and/or other special termination equipment associated with loose tube cables. The outer jacket is comprised of a durable UL® Listed sunlight resistant fluoropolymer that allows for the cable to be exposed to direct sunlight without the concern of material degradation. The cable is not designed for prolonged submersion in water, therefore it is not recommended for direct buried service nor within buried conduit which can flood. Please consult Technical Support to determine the best cable for your application.

APPLICATIONS

- Intra-building backbones
- Inter-building backbones, such as conduit pathways or tunnels, that are not subject to flooding or constant water submersion
- Service entrance to communication closets

FEATURES

- UL Certified Environmental Product Declaration (EPD)
- Health Product Declaration™ (HPD™)
- Tested and qualified to Telcordia® GR-409-CORE
- Exceeds ANSI/TIA-568-C.3 optical performance
- 900 µm tight buffered fibers
- Black, UL Listed sunlight resistant outer jacket
- -20 °C Low Temperature Performance
- OFNP weather resistant, indoor/outdoor design
- All dielectric
- Jacket rip cord

BENEFITS

- Contributes toward 1 LEED point under the Material and Resources credit (MRc)
- Contributes toward 1 LEED point under the MRc
- Assurance that cable investment will last
- Future-proof fiber performance for current and future networking applications
- Connect directly to mechanical connectors
- Long periods of direct sunlight exposure will not damage cable
- Allows operation at low temperatures
- Eliminates the need to purchase separate cables for plenum indoor/outdoor applications
- No additional grounding materials need to be purchased
- Saves time in cable preparation

PART NUMBERS AND PHYSICAL CHARACTERISTICS

Listing	Part Number ¹	Fiber Type	Fiber Count	Nominal Diameter in (mm)	Nominal Weight lbs/kft (kg/km)	Maximum Tensile Loading		Minimum Bend Radius		Package
						Install lbs (N)	Long Term lbs (N)	Install in (mm)	Long Term in (mm)	
OFNP	24018x101	Single mode	18	0.54 (13.8)	117 (175)	600 (2,700)	180 (800)	8.1 (206)	5.4 (138)	Plywood reel
OFNP	24024x101	Single mode	24	0.57 (14.6)	141 (211)	600 (2,700)	180 (800)	8.6 (219)	5.7 (146)	Plywood reel
OFNP	24030x101	Single mode	30	0.63 (16.0)	174 (259)	600 (2,700)	180 (800)	9.4 (240)	6.3 (160)	Plywood reel
OFNP	24036x101	Single mode	36	0.69 (17.4)	206 (307)	600 (2,700)	180 (800)	10.3 (261)	6.9 (174)	Plywood reel
OFNP	24048x101	Single mode	48	0.67 (17.1)	184 (275)	600 (2,700)	180 (800)	10.1 (257)	6.7 (171)	Plywood reel
OFNP	24060x101	Single mode	60	0.74 (18.9)	231 (344)	600 (2,700)	180 (800)	11.1 (283)	7.4 (189)	Plywood reel
OFNP	24072x101	Single mode	72	0.81 (20.6)	277 (413)	600 (2,700)	180 (800)	12.2 (309)	8.1 (206)	Plywood reel
OFNP	24018xG01	Multimode	18	0.54 (13.8)	117 (175)	600 (2,700)	180 (800)	8.1 (206)	5.4 (138)	Plywood reel
OFNP	24024xG01	Multimode	24	0.57 (14.6)	141 (211)	600 (2,700)	180 (800)	8.6 (219)	5.7 (146)	Plywood reel
OFNP	24030xG01	Multimode	30	0.63 (16.0)	174 (259)	600 (2,700)	180 (800)	9.4 (240)	6.3 (160)	Plywood reel
OFNP	24036xG01	Multimode	36	0.69 (17.4)	206 (307)	600 (2,700)	180 (800)	10.3 (261)	6.9 (174)	Plywood reel
OFNP	24048xG01	Multimode	48	0.67 (17.1)	184 (275)	600 (2,700)	180 (800)	10.1 (257)	6.7 (171)	Plywood reel
OFNP	24060xG01	Multimode	60	0.74 (18.9)	231 (344)	600 (2,700)	180 (800)	11.1 (283)	7.4 (189)	Plywood reel
OFNP	24072xG01	Multimode	72	0.81 (20.6)	277 (413)	600 (2,700)	180 (800)	12.2 (309)	8.1 (206)	Plywood reel

SINGLE MODE FIBER TYPES

	TeraFlex® Bend Resistant		
	G.657.A1	G.657.A2	G.657.B3
¹ Replace "x" with:	K	J	L
I/O Jacket Color	Black		

MULTIMODE OPTICAL FIBER TYPES

	TeraGain® 62.5/125	TeraFlex Bend Resistant Laser Optimized 50/125		
		10G/150	10G/300	10G/550
¹ Replace "x" with:	6	M	N	P
I/O Jacket Color	Black			

See "Optical Fiber Specifications" in the "Technical Information" section for detailed fiber type specifications.

Dry Block, Sunlight Resistant, Indoor/Outdoor, Tight Buffer

OFNR

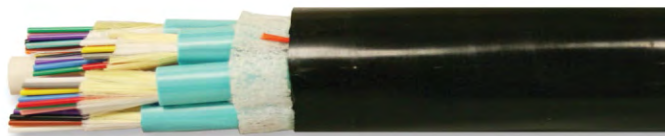

Flame Retardant, Chemical and Sunlight Resistant PVC Jacket
 Flame Retardant PVC Jacket
 Buffered Optical Fiber
 Central Strength Member
 Water-Blocking Tape
 Water-Blocking Dielectric
 Aramid Strength Members
 Rip Cord

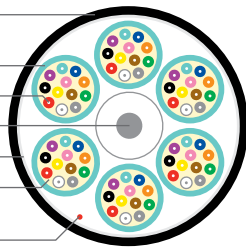

SPECIFICATIONS

2-12 Fiber Single Unit Configuration

Flexible tight buffer material extruded over fiber to 900 µm diameter; color coded fibers are combined with dielectric aramid yarns for strength and water blocking

18-36 Fiber Multi-Unit Configuration

Dry water-blocked 6-fiber sub-units are grouped to form cable core; core consists of sub-units cabled with additional strength members and water-blocking elements

48-144 Fiber Multi-Unit Configuration

Dry water-blocked 12-fiber sub-units are grouped to form cable core; core consists of sub-units cabled with additional strength members and water-blocking elements

Jacket

Flame retardant, chemical and sunlight resistant black PVC

Performance Compliance

UL 1651
 CSA C22.2 No. 232
 UL 1666
 Telcordia® GR-20-CORE, Issue 3 - Water Penetration
 ANSI/ICEA S-83-596 (single unit designs)
 ANSI/ICEA S-104-696-2001 (multi-unit designs)
 ANSI/TIA-568-C.3

NRTL Programs

UL, c(UL) Listed OFNR
 UL, c(UL) Listed Sunlight Resistant

Sustainability

UL Certified EPD
 HPD
 USGBC® Member
 RoHS-compliant/RoHS 2-compliant
 REACH-compliant

ENVIRONMENTAL SPECIFICATIONS

Operation	-40°C to +75°C
Storage/Shipping	-40°C to +75°C
Installation	-20°C to +65°C

SUSTAINABILITY LEADERSHIP



UL and the related logo are registered trademarks of UL LLC. Health Product Declaration, HPD and the related logo are trademarks of Health Product Declaration Collaborative. Telcordia is a registered trademark of Ericsson Inc. USGBC and the related logo are registered trademarks of U.S. Green Building Council.

PRODUCT DESCRIPTION

FIRST MANUFACTURER IN THE INDUSTRY
 to offer products that contribute toward LEED!

The Dry Block, Sunlight Resistant Indoor/Outdoor, Tight Buffer Riser-Rated Cable line offers the system designer the ultimate in premises optical fiber cable utility. These cables can be installed in open spaces, trays, conduits, inner-ducts, trenches, steam tunnels and building riser locations. These cables incorporate the latest in dry water-blocking technology. This system of water blocking eliminates the need to clean off the traditional gel-based water-blocking compounds found in loose tube cables. In addition, breakout kits and or other special termination equipment associated with loose tube Outside Plant (OSP) cables are not required. The outer jacket is comprised of a durable UL® Listed, sunlight resistant, black polymer that allows for the cable to be exposed to long-term direct sunlight without the concern of material degradation. All fiber types are available, including 50/125 µm, 62.5/125 µm and single mode.

APPLICATIONS

- Intra/inter-building backbones
- Trench/conduit/duct/tray pathways
- Dry or wet locations

FEATURES

- UL Certified Environmental Product Declaration (EPD)
- Health Product Declaration™ (HPD™)
- Exceeds ANSI/TIA-568-C.3 optical performance
- Dry-block design meets Telcordia® GR-20-CORE water-block requirements
- 900 µm tight-buffered fibers
- UL/NEC Listed OFNR
- All dielectric
- Jacket rip cord
- Black, UL Listed sunlight resistant outer jacket
- BrakeBox® payout control system

BENEFITS

- Contributes toward 1 LEED point under the Material and Resources credit (MRC)
- Contributes toward 1 LEED point under the MRC
- Future-proof fiber performance for current and future multi-gigabit applications
- Cable integrity maintained even if damage occurs to protective layers
- Attaches directly to mechanical connectors
- Eliminates the need to purchase separate cables for OSP and indoor/riser applications
- No additional grounding materials need to be purchased
- Saves time in cable preparation
- Long periods of direct sunlight exposure will not damage cable
- Adjustable tension control on reel prevents over spin and entangling of cable

PART NUMBERS AND PHYSICAL CHARACTERISTICS

Listing	Part Number ¹	Fiber Count	Nominal Diameter in (mm)	Nominal Weight lbs/kft (kg/km)	Maximum Tensile Loading		Minimum Bend Radius		Package ¹
					Install lbs (N)	Long Term lbs (N)	Install in (mm)	Long Term in (mm)	
OFNR	W3002xxyy	2	0.20 (5.0)	14 (21)	150 (670)	45 (200)	3.0 (75)	2.0 (50)	use key
OFNR	W3004xxyy	4	0.20 (5.0)	15 (23)	150 (670)	45 (200)	3.0 (75)	2.0 (50)	use key
OFNR	W3006xxyy	6	0.20 (5.0)	16 (23)	150 (670)	45 (200)	3.0 (75)	2.0 (50)	use key
OFNR	W3008xxyy	8	0.24 (6.0)	21 (31)	150 (670)	45 (200)	3.5 (90)	2.4 (60)	use key
OFNR	W3012xxyy	12	0.26 (6.5)	25 (38)	150 (670)	45 (200)	3.8 (97)	2.6 (65)	use key
OFNR	W3018xx01	18	0.55 (14.1)	100 (149)	600 (2,700)	180 (800)	8.3 (211)	5.5 (141)	Plywood reel
OFNR	W3024xx01	24	0.59 (14.9)	122 (182)	600 (2,700)	180 (800)	8.8 (224)	5.9 (149)	Plywood reel
OFNR	W3030xx01	30	0.63 (16.1)	147 (220)	600 (2,700)	180 (800)	9.5 (242)	6.3 (161)	Plywood reel
OFNR	W3036xx01	36	0.70 (17.7)	179 (267)	600 (2,700)	180 (800)	10.5 (266)	7.0 (177)	Plywood reel
OFNR	W3048xx01	48	0.70 (17.8)	161 (241)	600 (2,700)	180 (800)	10.5 (267)	7.0 (178)	Plywood reel
OFNR	W3060xx01	60	0.78 (19.8)	204 (304)	600 (2,700)	180 (800)	11.7 (297)	7.8 (198)	Plywood reel
OFNR	W3072xx01	72	0.84 (21.3)	243 (362)	600 (2,700)	180 (800)	12.6 (320)	8.4 (213)	Plywood reel
OFNR	W3084xx01	84	0.91 (23.2)	294 (439)	600 (2,700)	180 (800)	13.7 (347)	9.1 (232)	Plywood reel
OFNR	W3096xx01	96	0.98 (25.0)	345 (515)	600 (2,700)	180 (800)	14.8 (375)	9.8 (250)	Plywood reel
OFNR	W3144xx01	144	1.11 (28.3)	375 (559)	600 (2,700)	180 (800)	16.7 (425)	11.1 (283)	Plywood reel

SINGLE MODE OPTICAL FIBER TYPES

	TeraFlex® Bend Resistant		
	G.657.A1	G.657.A2	G.657.B3
¹ Replace "xx" with:	K1	J1	L1
I/O Jacket Color	Black		

MULTIMODE OPTICAL FIBER TYPES

	TeraGain® 62.5/125	TeraFlex Bend Resistant Laser Optimized 50/125		
		10G/150	10G/300	10G/550
¹ Replace "xx" with:	6G	MG	NG	PG
I/O Jacket Color	Black			

See "Optical Fiber Specifications" in the "Technical Information" section for detailed fiber type specifications.

PACKAGING

	Cut to Length Plywood Reel	1,000 ft BrakeBox	1,500 ft BrakeBox	2,000 ft BrakeBox
¹ Replace "yy" with:	01	BB	BD	BC

Dry Block, Sunlight Resistant, Indoor/Outdoor

OFNP

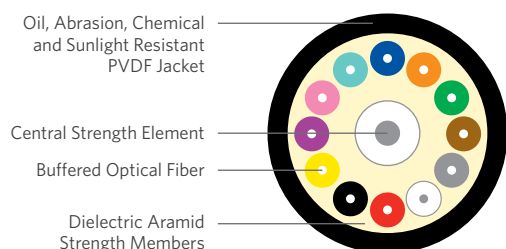

SPECIFICATIONS

Configuration	2 to 24 optical fibers surrounded by dielectric strength elements with an overall jacket
Fiber Type	900 micron tight buffered 250 micron optical fiber
Dielectric Strength Elements	Glass Reinforced Plastic (GRP) and aramid yarns
Water-Blocking	SAP Dry Block
Jacket	Oil, chemical, abrasion and UV resistant plenum grade black PVDF
Maximum Attenuation dB/km	Single mode: @ 1300 nm: 0.7 @ 1380 nm: 0.7 @ 1550 nm: 0.7 Multimode: @ 850 nm: 3.5 @ 1300 nm: 1.5
Performance Compliance	UL 1651 CSA C22.2 No. 232 NFPA 262 ANSI/ICEA S-104-696-2001 ANSI/TIA-568-C.3
NRTL Programs	UL, c(UL) Listed OFNP UL, c(UL) Listed Sunlight Resistant
Sustainability	UL Certified EPD HPD USGBC® Member RoHS-compliant/RoHS 2-compliant REACH-compliant

ENVIRONMENTAL SPECIFICATIONS

Operation	-40°C to +70°C
Storage/Shipping	-40°C to +70°C
Installation	0°C to +60°C

SUSTAINABILITY LEADERSHIP



UL and the related logo are registered trademarks of UL LLC. Health Product Declaration, HPD and the related logo are trademarks of Health Product Declaration Collaborative. USGBC and the related logo are registered trademarks of U.S. Green Building Council.

PRODUCT DESCRIPTION



FIRST MANUFACTURER IN THE INDUSTRY
to offer products that contribute toward LEED!

The Superior Essex Dry Block, Sunlight Resistant Indoor/Outdoor Plenum cable is designed to survive the toughest installation and environmental conditions. Not only does the cable exceed the rigorous Indoor/Outdoor plenum cable performance requirements of ICEA 696, but its proprietary thermoplastic jacket makes it resistant to mechanical abrasion, chemicals, oil and sunlight. The cable core consists of 2 through 24 fibers. GRP and aramid yarn dielectric strength elements give the cable both strength and flexibility and the core is fully water-blocking using dry SAP technology. The cable is available in TeraFlex® Bend Resistant optical fiber types, including both single mode and 50 micron multimode.

APPLICATIONS

- Intra/inter-building backbones
- Conduit/duct/tray pathways
- Dry or wet locations

FEATURES

- UL® Certified Environmental Product Declaration (EPD)
- Health Product Declaration™ (HPD™)
- 900 micron tight buffered optical fibers
- Full water blocking with SAP Dry Block
- Tough, thermoplastic jacket
- Meets or exceeds ANSI/ICEA S-104-696-2001
- Plenum (OFNP) rated designs
- Available in both single mode and multimode TeraFlex Bend Resistant fiber types
- BrakeBox® payout control system for 2 to 12 fiber counts

BENEFITS

- Contributes toward 1 LEED point under the Material and Resources credit (MRc)
- Contributes toward 1 LEED point under the MRC
- Allows for either fusion or mechanical connectors
- Prevents water ingress from OSP splice enclosures
- Abrasion, chemical, oil and sunlight resistant
- Worry-free installation and performance
- Plenum listing allows for cable placement in both plenum and riser spaces
- Choose the fiber needed for long distance, short-haul FTTP and data center applications
- Adjustable tension control on reel prevents over spin and entangling of cable

PART NUMBERS AND PHYSICAL CHARACTERISTICS

Listing	Part Number ¹	Fiber Count	Nominal Diameter in (mm)	Nominal Weight lbs/kft (kg/km)	Maximum Tensile Loading		Minimum Bend Radius		Package ¹
					Install lbs (N)	Long Term lbs (N)	Install in (mm)	Long Term in (mm)	
OFNP	W4002xxyy	2	0.23 (5.9)	24 (36)	300 (1,340)	90 (400)	9.3 (236)	4.6 (118)	use key
OFNP	W4004xxyy	4	0.23 (5.9)	25 (37)	300 (1,340)	90 (400)	9.3 (236)	4.6 (118)	use key
OFNP	W4006xxyy	6	0.23 (5.9)	26 (39)	300 (1,340)	90 (400)	9.3 (236)	4.6 (118)	use key
OFNP	W4008xxyy	8	0.26 (6.7)	32 (47)	300 (1,340)	90 (400)	10.6 (268)	5.3 (134)	use key
OFNP	W4012xxyy	12	0.30 (7.5)	41 (62)	300 (1,340)	90 (400)	11.8 (300)	5.9 (150)	use key
OFNP	W4024xx01	24	0.32 (8.2)	51 (77)	300 (1,340)	90 (400)	12.9 (328)	6.5 (164)	Plywood reel

SINGLE MODE OPTICAL FIBER TYPES

	TeraFlex® Bend Resistant		
	G.657.A1	G.657.A2	G.657.B3
¹ Replace "xx" with:	K1	J1	L1
I/O Jacket Color	Black		

MULTIMODE OPTICAL FIBER TYPES

	TeraGain® 62.5/125	TeraFlex Bend Resistant Laser Optimized 50/125		
		10G/150	10G/300	10G/550
¹ Replace "xx" with:	6G	MG	NG	PG
I/O Jacket Color	Black			

Other jacket colors available upon request. See "Optical Fiber Specifications" in the "Technical Information" section for detailed fiber type specifications.

PACKAGING

	Cut to Length Plywood Reel	1,000 ft BrakeBox	1,500 ft BrakeBox	2,000 ft BrakeBox
¹ Replace "yy" with:	01	BB	BD	BC

Hybrid

Premises Fiber OFNR/OFNP

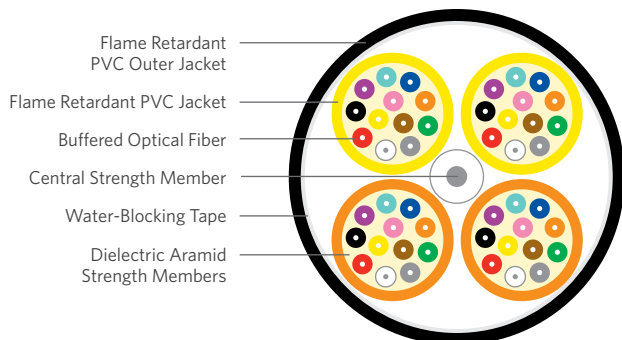

SPECIFICATIONS

Tight Buffer Configuration	Flexible tight buffer material extruded over the fiber to a diameter of 900 µm for use with standard connectors; dielectric aramid yarns are applied for additional strength and covered with a flame retardant PVC jacket
Fiber Configuration	Single mode fibers are placed first in the color sequence, followed by multimode fibers
Outer Jacket	Premises: Flame retardant (FR), chemical resistant PVC Indoor/Outdoor: Black, FR, chemical resistant and sunlight resistant PVC
Performance Compliance	UL 1651 CSA C22.2 No. 232 UL 1666 NFPA 262 Telcordia® GR-409-CORE, Issue 1 Premises: Telcordia GR-409-CORE, Issue 2 and ANSI/ICEA S-83-596 Indoor/Outdoor: Telcordia GR-20-CORE, Issue 3 – Water Penetration and ANSI/ICEA S-104-696 ANSI/TIA-568-C.3
NRTL Programs	UL, c(UL) Listed OFNR UL, c(UL) Listed OFNP
Sustainability	UL Certified EPD HPD USGBC® Member RoHS-compliant/RoHS 2-compliant REACH-compliant

ENVIRONMENTAL SPECIFICATIONS

Operation	-40°C to +75°C
Storage/Shipping	-40°C to +75°C
Installation	-20°C to +65°C

SINGLE MODE OPTICAL FIBER TYPES

	Reduced Water Peak	TeraFlex® Bend Resistant		
		G.657.A1	G.657.A2	G.657.B3
Premises Jacket Colors*	Yellow	Yellow	Yellow	Yellow
I/O Jacket Color	Black	Black	Black	Black

*Other jacket colors available upon request.

See "Optical Fiber Specifications" in the "Technical Information" section for detailed fiber type specifications.

MULTIMODE OPTICAL FIBER TYPES

	TeraGain® 62.5/125	TeraGain Laser Optimized 50/125			TeraFlex Bend Resistant Laser Optimized 50/125		
		10G/150	10G/300	10G/550	10G/150	10G/300	10G/550
Premises Jacket Colors*	Orange	Aqua	Aqua	Aqua	Aqua	Aqua	Aqua
I/O Jacket Color	Black	Black	Black	Black	Black	Black	Black

PRODUCT DESCRIPTION



FIRST MANUFACTURER IN THE INDUSTRY
to offer products that contribute toward LEED!

Superior Essex offers a broad line of products including multimode and single mode fibers within the same optical fiber cable. The use of hybrid fiber designs have proven useful to network systems designers because they offer the flexibility to run diverse applications upgrades without the need to install new cables. Superior Essex hybrid optical fiber cables are available in stranded tight buffer premises distribution cables, as well as all other loose tube cable product designs. Hybrid cables are used for standard campus networking applications and can be manufactured with a wide variety of fiber type combinations. They will save the designer and the customer significant costs over the lifetime of the physical cable plant.

Single mode fibers are assigned first in the color and/or sub-unit scheme. Multimode fibers are assigned remaining colors and/or sub-units.

APPLICATIONS

- Intra-building backbones
- Inter-building backbone (in conduit)
- Conduit pathways
- Service entrance to communication closets

FEATURES

- UL® Certified Environmental Product Declaration (EPD)
- Health Product Declaration™ (HPD™)
- Telcordia® GR-409-CORE and GR-20-CORE qualified designs
- TeraGain® multimode and single mode under one jacket
- Compliant with ANSI/TIA-568-C.3
- Design options include: interlock armored, indoor/outdoor, tight buffered riser and plenum
- Subunits are color coded according to fiber type

BENEFITS

- Contributes toward 1 LEED point under the Material and Resources credit (MRc)
- Contributes toward 1 LEED point under the MRC
- Most cost-effective cables for the varied applications
- Eliminates the need for additional pathway space for different cable types
- Assures compliance for all current networking applications
- Cable designs available for every application
- Easily identify fiber type

SUSTAINABILITY LEADERSHIP



UL and the related logo are registered trademarks of UL LLC. Health Product Declaration, HPD and the related logo are trademarks of Health Product Declaration Collaborative. Telcordia is a registered trademark of Ericsson Inc. USGBC and the related logo are registered trademarks of U.S. Green Building Council.

PART NUMBERS AND PHYSICAL CHARACTERISTICS

Listing	Part Number	Configuration	Fiber Type and Fiber Count			Nominal Diameter in (mm)	Nominal Weight lbs/kft (kg/km)	Maximum Tensile Loading		Minimum Bend Radius		Package
			RWP SMF	TeraGain® 62.5/125	TeraGain 10G/300			Install lbs (N)	Long Term lbs (N)	Install in (mm)	Long Term in (mm)	
Premises Distribution												
OFNR	43008HGA1	Single unit	4	-	4	0.24 (6.0)	20 (30)	150 (660)	45 (200)	3.5 (90)	2.4 (60)	Reel
OFNR	43012HGA1	Single unit	6	6	-	0.26 (6.5)	25 (37)	150 (660)	45 (200)	3.8 (98)	2.6 (65)	Reel
OFNR	43012HGC1	Single unit	6	-	6	0.26 (6.5)	25 (37)	150 (660)	45 (200)	3.8 (98)	2.6 (65)	Reel
OFNR	43024HK1Q	Single unit	12	12	-	0.33 (8.5)	44 (66)	300 (1,320)	90 (400)	5.0 (128)	3.3 (85)	Reel
OFNR	43024HKB1	Single unit	12	-	12	0.33 (8.5)	44 (66)	300 (1,320)	90 (400)	5.0 (128)	3.3 (85)	Reel
OFNP	44008HGA1	Single unit	2	6	-	0.21 (5.4)	19 (28)	100 (440)	30 (130)	3.2 (81)	2.1 (54)	Reel
OFNP	44008HGB1	Single unit	4	-	4	0.21 (5.4)	19 (28)	100 (440)	30 (130)	3.2 (81)	2.1 (54)	Reel
OFNP	44012HGA1	Single unit	6	6	-	0.24 (6.2)	24 (35)	100 (440)	30 (130)	3.7 (93)	2.4 (62)	Reel
OFNP	44012HGC1	Single unit	6	-	6	0.24 (6.2)	24 (35)	100 (440)	30 (130)	3.7 (93)	2.4 (62)	Reel
OFNP	44012HKA1	Single unit	6	-	6	0.24 (6.2)	24 (35)	100 (440)	30 (130)	3.7 (93)	2.4 (62)	Reel
OFNP	44024HKA1	Single unit	12	12	-	0.31 (7.8)	42 (62)	300 (1,320)	90 (400)	4.6 (117)	3.1 (78)	Reel
OFNR	43018HGA1	Multi-unit	6	12	-	0.54 (13.7)	96 (143)	300 (1,320)	90 (400)	8.1 (206)	5.4 (137)	Reel
OFNR	43024HGA1	Multi-unit	12	12	-	0.57 (14.6)	117 (174)	300 (1,320)	90 (400)	8.6 (218)	5.7 (146)	Reel
OFNR	43024HGB1	Multi-unit	6	18	-	0.57 (14.6)	117 (174)	300 (1,320)	90 (400)	8.6 (218)	5.7 (146)	Reel
OFNR	43036HGO1	Multi-unit	12	24	-	0.68 (17.4)	171 (255)	300 (1,320)	90 (400)	10.2 (260)	6.8 (174)	Reel
OFNR	43036HGB1	Multi-unit	24	12	-	0.68 (17.4)	171 (255)	300 (1,320)	90 (400)	10.2 (260)	6.8 (174)	Reel
OFNR	43036HGC1	Multi-unit	18	18	-	0.68 (17.4)	171 (255)	300 (1,320)	90 (400)	10.2 (260)	6.8 (174)	Reel
OFNR	43048HGB1	Multi-unit	24	24	-	0.69 (17.5)	155 (232)	300 (1,320)	90 (400)	10.3 (262)	6.9 (175)	Reel
OFNR	43048HGD1	Multi-unit	12	36	-	0.69 (17.5)	155 (232)	300 (1,320)	90 (400)	10.3 (262)	6.9 (175)	Reel
OFNR	43048HGC1	Multi-unit	24	-	24	0.69 (17.5)	155 (232)	300 (1,320)	90 (400)	10.3 (262)	6.9 (175)	Reel
OFNR	43060HGA1	Multi-unit	12	48	-	0.77 (19.5)	195 (291)	300 (1,320)	90 (400)	11.5 (292)	7.7 (195)	Reel
OFNR	43060HGC1	Multi-unit	24	36	-	0.77 (19.5)	195 (291)	300 (1,320)	90 (400)	11.5 (292)	7.7 (195)	Reel
OFNR	43072HGA1	Multi-unit	24	48	-	0.82 (21.0)	233 (348)	300 (1,320)	90 (400)	12.4 (314)	8.2 (210)	Reel
OFNR	43072HGC1	Multi-unit	36	36	-	0.82 (21.0)	233 (348)	300 (1,320)	90 (400)	12.4 (314)	8.2 (210)	Reel
OFNR	43096HGA1	Multi-unit	48	-	48	0.97 (24.7)	337 (503)	300 (1,320)	90 (400)	14.6 (370)	9.7 (247)	Reel
OFNP	44018HGA1	Multi-unit	6	12	-	0.54 (13.8)	117 (175)	150 (660)	45 (200)	8.1 (206)	5.4 (138)	Reel
OFNP	44024HGC1	Multi-unit	12	12	-	0.57 (14.6)	141 (211)	150 (660)	45 (200)	8.6 (219)	5.7 (146)	Reel
OFNP	44024HGD1	Multi-unit	6	18	-	0.57 (14.6)	141 (211)	150 (660)	45 (200)	8.6 (219)	5.7 (146)	Reel
OFNP	44024HGG1	Multi-unit	12	-	12	0.57 (14.6)	141 (211)	150 (660)	45 (200)	8.6 (219)	5.7 (146)	Reel
OFNP	44036HGA1	Multi-unit	12	24	-	0.69 (17.4)	206 (307)	150 (660)	45 (200)	10.3 (261)	6.9 (174)	Reel
OFNP	44036HGC1	Multi-unit	18	18	-	0.69 (17.4)	206 (307)	150 (660)	45 (200)	10.3 (261)	6.9 (174)	Reel
OFNP	44048HGA1	Multi-unit	12	36	-	0.67 (17.1)	184 (275)	150 (660)	45 (200)	10.1 (257)	6.7 (171)	Reel
OFNP	44048HGC1	Multi-unit	24	24	-	0.67 (17.1)	184 (275)	150 (660)	45 (200)	10.1 (257)	6.7 (171)	Reel
OFNP	44060HGA1	Multi-unit	12	48	-	0.74 (18.9)	229 (341)	150 (660)	45 (200)	11.2 (284)	7.4 (189)	Reel
OFNP	44060HGC1	Multi-unit	24	36	-	0.74 (18.9)	229 (341)	150 (660)	45 (200)	11.2 (284)	7.4 (189)	Reel
OFNP	44072HGA1	Multi-unit	24	48	-	0.81 (20.6)	276 (412)	150 (660)	45 (200)	12.2 (309)	8.1 (206)	Reel
OFNP	44072HGC1	Multi-unit	36	36	-	0.81 (20.6)	276 (412)	150 (660)	45 (200)	12.2 (309)	8.1 (206)	Reel
Indoor/Outdoor Tight Buffer												
OFNR	W3012HGB1	Single unit	6	6	-	0.26 (6.5)	25 (38)	300 (1,335)	90 (400)	3.8 (97)	2.6 (65)	Reel
OFNR	W3012HGD1	Single unit	6	-	6	0.26 (6.5)	25 (38)	300 (1,335)	90 (400)	3.8 (97)	2.6 (65)	Reel
OFNR	W3018HGA1	Multi-unit	6	12	-	0.55 (14.1)	102 (152)	600 (2,640)	180 (800)	8.3 (211)	5.5 (141)	Reel
OFNR	W3024HGA1	Multi-unit	6	18	-	0.59 (14.9)	123 (184)	600 (2,640)	180 (800)	8.8 (224)	5.9 (149)	Reel
OFNR	W3024HGC1	Multi-unit	12	12	-	0.59 (14.9)	123 (184)	600 (2,640)	180 (800)	8.8 (224)	5.9 (149)	Reel
OFNR	W3024HGE1	Multi-unit	12	-	12	0.59 (14.9)	123 (184)	600 (2,640)	180 (800)	8.8 (224)	5.9 (149)	Reel
OFNR	W3036HGA1	Multi-unit	12	24	-	0.70 (17.7)	179 (267)	600 (2,640)	180 (800)	10.5 (266)	7.0 (177)	Reel
OFNR	W3036HGC1	Multi-unit	18	18	-	0.70 (17.7)	179 (267)	600 (2,640)	180 (800)	10.5 (266)	7.0 (177)	Reel
OFNR	W3036HGE1	Multi-unit	24	12	-	0.70 (17.7)	179 (267)	600 (2,640)	180 (800)	10.5 (266)	7.0 (177)	Reel
OFNR	W3048HGE1	Multi-unit	12	36	-	0.70 (17.8)	162 (242)	600 (2,640)	180 (800)	10.5 (267)	7.0 (178)	Reel
OFNR	W3048HGC1	Multi-unit	24	24	-	0.70 (17.8)	162 (242)	600 (2,640)	180 (800)	10.5 (267)	7.0 (178)	Reel
OFNR	W3048HGB1	Multi-unit	24	-	24	0.70 (17.8)	162 (242)	600 (2,640)	180 (800)	10.5 (267)	7.0 (178)	Reel
OFNR	W3060HGA1	Multi-unit	12	48	-	0.78 (19.8)	204 (304)	600 (2,640)	180 (800)	11.7 (297)	7.8 (198)	Reel
OFNR	W3072HGA1	Multi-unit	24	48	-	0.84 (21.3)	243 (362)	600 (2,640)	180 (800)	12.6 (320)	8.4 (213)	Reel
OFNR	W3072HGC1	Multi-unit	36	36	-	0.84 (21.3)	243 (362)	600 (2,640)	180 (800)	12.6 (320)	8.4 (213)	Reel
OFNR	W3096HGA1	Multi-unit	48	48	-	0.98 (25.0)	345 (515)	600 (2,640)	180 (800)	14.8 (375)	9.8 (250)	Reel
OFNR	W3096HGB1	Multi-unit	48	-	48	0.98 (25.0)	345 (515)	600 (2,640)	180 (800)	14.8 (375)	9.8 (250)	Reel
OFNR	W3144HGC1	Multi-unit	72	72	-	1.11 (28.3)	375 (559)	600 (2,640)	180 (800)	16.7 (425)	11.1 (283)	Reel

Other configurations available upon request. See "Optical Fiber Specifications" in the "Technical Information" section for detailed fiber type specifications.

Interlock Armored, Tight Buffer

OFCR/OFCP

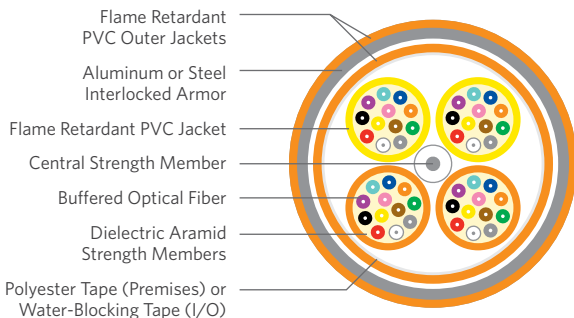

SPECIFICATIONS

Interlock Armored

Flexible, heavy duty interlocking aluminum or steel tape helically applied over the inner cable core; further protection is provided by an optional flame retardant outer jacket

Outer Jacket

OFCR: Flame retardant (FR), PVC
OFCP: FR, LSPVC

UL 1569
UL 1651
CSA C22.2 No. 232
UL 1666

Performance Compliance

NFPA 262
Telcordia® GR-409-CORE, Issue 1
Telcordia GR-409-CORE, Issue 2
ANSI/ICEA S-83-596
ANSI/TIA-568-C.3

NRTL Programs

UL, c(UL) Listed OFCR
UL, c(UL) Listed OFCP

Sustainability

UL Certified EPD
HPD
USGBC® Member
RoHS-compliant/RoHS 2-compliant
REACH-compliant

PRODUCT DESCRIPTION



FIRST MANUFACTURER IN THE INDUSTRY
to offer products that contribute toward LEED!

Interlock Armored Optical Fiber Cables provide an extremely well protected cable package ideally suited for mechanically challenging environments. The armor is available in aluminum or steel and comes with either an OFCR (riser) or OFCP (plenum) rating. This design offers the system designer a product that can be installed in areas where added mechanical protection and security are required. The flexible interlock armored cable design is also popular for retrofit applications and eliminates the need to install rigid conduit while still meeting building code guidelines.

APPLICATIONS

- Intra-building backbones
- Conduit pathways
- Service entrance to communication closets

FEATURES

- UL® Certified Environmental Product Declaration (EPD)
- Health Product Declaration™ (HPD™)
- Thick, flexible metallic armor
- Flame retardant, UL Listed designs

BENEFITS

- Contributes toward 1 LEED point under the Material and Resources credit (MRc)
- Contributes toward 1 LEED point under the MRc
- Reduce incidences of circuit disruption due to rodents or mechanically abusive applications
- Eliminates the need for multiple cables for installation

ENVIRONMENTAL SPECIFICATIONS

	Riser	Plenum
Operation	-20°C to +75°C	0°C to +75°C
Storage/Shipping	-40°C to +75°C	-40°C to +75°C
Installation	-20°C to +65°C	0°C to +65°C

SUSTAINABILITY LEADERSHIP



greenwizzard
THE BUILDING PRODUCT MANAGEMENT SOLUTION

UL and the related logo are registered trademarks of UL LLC. Health Product Declaration, HPD and the related logo are trademarks of Health Product Declaration Collaborative. Telcordia is a registered trademark of Ericsson Inc. USGBC and the related logo are registered trademarks of U.S. Green Building Council.

PART NUMBERS AND PHYSICAL CHARACTERISTICS

Listing	Part Number ¹	Configuration	Fiber Count	Nominal Diameter in (mm)	Nominal Weight lbs/kft (kg/km)	Maximum Compression lbf/in (N/cm)	Maximum Tensile Loading		Minimum Bend Radius	
							Install lbs (N)	Long Term lbs (N)	Install in (mm)	Long Term in (mm)
OFCR	L3002x301	Single unit	2	0.54 (13.8)	90 (134)	286 (500)	150 (670)	45 (200)	8.2 (207)	5.4 (138)
OFCR	L3004x301	Single unit	4	0.54 (13.8)	93 (139)	286 (500)	150 (670)	45 (200)	8.2 (207)	5.4 (138)
OFCR	L3006x401	Single unit	6	0.54 (13.8)	96 (144)	286 (500)	150 (670)	45 (200)	8.2 (207)	5.4 (138)
OFCR	L3008x401	Single unit	8	0.54 (13.8)	101 (150)	287 (500)	150 (670)	45 (200)	8.2 (207)	5.4 (138)
OFCR	L3012x401	Single unit	12	0.61 (15.6)	116 (173)	286 (500)	150 (670)	45 (200)	9.2 (234)	6.1 (156)
OFCR	L3018xK1Q	Single unit	18	0.67 (17.1)	145 (216)	228 (400)	300 (1,340)	90 (400)	10.1 (256)	6.7 (171)
OFCR	L3024xK1Q	Single unit	24	0.73 (18.5)	174 (260)	228 (400)	300 (1,340)	90 (400)	11.0 (278)	7.3 (185)
OFCP	L4002x301	Single unit	2	0.50 (12.7)	78 (116)	286 (500)	150 (670)	45 (200)	7.5 (191)	5.0 (127)
OFCP	L4004x301	Single unit	4	0.50 (12.7)	79 (118)	286 (500)	150 (670)	45 (200)	7.5 (191)	5.0 (127)
OFCP	L4006x401	Single unit	6	0.50 (12.7)	88 (131)	286 (500)	150 (670)	45 (200)	7.5 (191)	5.0 (127)
OFCP	L4008x401	Single unit	8	0.50 (12.7)	90 (134)	286 (500)	150 (670)	45 (200)	7.5 (191)	5.0 (127)
OFCP	L4012x401	Single unit	12	0.55 (13.9)	104 (155)	286 (500)	150 (670)	45 (200)	8.2 (209)	5.5 (139)
OFCP	L4018xK1Q	Single unit	18	0.60 (15.2)	129 (192)	228 (400)	150 (670)	45 (200)	9.0 (229)	6.0 (152)
OFCP	L4024xK1Q	Single unit	24	0.62 (15.6)	139 (207)	228 (400)	150 (670)	45 (200)	9.2 (235)	6.2 (156)
OFCR	L3018x401	Multi-unit	18	0.95 (24.1)	240 (358)	228 (400)	300 (1,340)	90 (400)	14.2 (362)	9.5 (241)
OFCR	L3024x401	Multi-unit	24	0.93 (23.6)	265 (396)	228 (400)	300 (1,340)	90 (400)	14.0 (354)	9.3 (236)
OFCR	L3036x401	Multi-unit	36	1.05 (26.7)	351 (523)	171 (300)	300 (1,340)	90 (400)	15.7 (400)	10.5 (267)
OFCR	L3048x401	Multi-unit	48	1.02 (26.0)	321 (479)	171 (300)	300 (1,340)	90 (400)	15.4 (390)	10.2 (260)
OFCR	L3072x401	Multi-unit	72	1.14 (28.9)	409 (610)	171 (300)	600 (2,700)	180 (800)	17.1 (434)	11.4 (289)
OFCR	L3096x401	Multi-unit	96	1.17 (29.7)	443 (660)	171 (300)	600 (2,700)	180 (800)	17.5 (445)	11.7 (297)
OFCR	L3144x401	Multi-unit	144	1.35 (34.2)	573 (854)	171 (300)	600 (2,700)	180 (800)	20.2 (513)	13.5 (342)
OFCP	L4018x401	Multi-unit	18	0.85 (21.7)	257 (383)	228 (400)	300 (1,340)	90 (400)	12.8 (326)	8.5 (217)
OFCP	L4024x401	Multi-unit	24	0.88 (22.4)	276 (412)	228 (400)	300 (1,340)	90 (400)	13.2 (335)	8.8 (224)
OFCP	L4036x401	Multi-unit	36	1.02 (25.8)	375 (559)	171 (300)	300 (1,340)	90 (400)	15.2 (387)	10.2 (258)
OFCP	L4048x401	Multi-unit	48	0.91 (23.1)	339 (505)	171 (300)	300 (1,340)	90 (400)	13.6 (347)	9.1 (231)
OFCP	L4072x401	Multi-unit	72	1.10 (27.9)	442 (659)	171 (300)	600 (2,700)	180 (800)	16.5 (418)	11.0 (279)

¹Part numbers listed above include aluminum interlock armored. Steel interlock armored available upon request.

SINGLE MODE OPTICAL FIBER TYPES

	Reduced Water Peak	TeraFlex® Bend Resistant		
		G.657.A1	G.657.A2	G.657.B3
¹ Replace "x" with:	3	K	J	L
Jacket Colors*		Yellow		

MULTIMODE OPTICAL FIBER TYPES

	TeraGain® 62.5/125	TeraFlex Bend Resistant Laser Optimized 50/125		
		10G/150	10G/300	10G/550
¹ Replace "x" with:	6	M	N	P
Jacket Colors*	Orange	Teal		

*Other jacket colors available upon request. See "Optical Fiber Specifications" in the "Technical Information" section for detailed fiber type specifications.

Indoor/Outdoor, Interlock Armored, Tight Buffer

OFCR/OFCP



Flame Retardant and Sunlight Resistant PVC Outer Jackets

Aluminum or Steel Interlocked Armor

Flame Retardant PVC Jacket

Central Strength Member

Buffered Optical Fiber

Dielectric Aramid Strength Members

Polyester Tape (Premises) or Water-Blocking Tape (I/O)

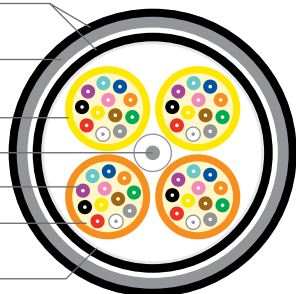

SPECIFICATIONS

Interlock Armored

Flexible, heavy duty interlocking aluminum or steel tape helically applied over the inner cable core; further protection is provided by an optional flame retardant outer jacket

Outer Jacket

Black, FR, chemical resistant and sunlight resistant PVC

UL 1569
UL 1651
CSA C22.2 No. 232
UL 1666

Performance Compliance

NFPA 262
Telcordia® GR-409-CORE, Issue 1
Telcordia GR-409-CORE, Issue 2
ANSI/ICEA S-83-596
ANSI/ICEA S-104-696
ANSI/TIA-568-C.3

NRTL Programs

UL, c(UL) Listed OFCR
UL, c(UL) Listed OFCP

Sustainability

UL Certified EPD
HPD
USGBC® Member
RoHS-compliant/RoHS 2-compliant
REACH-compliant

PRODUCT DESCRIPTION

FIRST MANUFACTURER IN THE INDUSTRY to offer products that contribute toward LEED!

Interlock Armored Optical Fiber Cables provide an extremely well protected cable package ideally suited for harsh environments. The armor is available in aluminum or steel and comes with either an OFCR (riser) or OFCP (plenum) rating. This design offers the system designer a product that can be installed in areas where added mechanical protection and security are required. The flexible interlock armored cable design is also popular for retrofit applications and eliminates the need to install rigid conduit while still meeting building code guidelines.

APPLICATIONS

- Intra-building backbones
- Conduit pathways
- Service entrance to communication closets

FEATURES

- UL® Certified Environmental Product Declaration (EPD)
- Health Product Declaration™ (HPD™)
- Thick, flexible metallic armor
- Flame retardant, UL Listed designs
- Full line of Superior Essex cables available

BENEFITS

- Contributes toward 1 LEED point under the Material and Resources credit (MRC)
- Contributes toward 1 LEED point under the MRC
- Reduce incidences of circuit disruption due to rodents or mechanically abusive applications
- Eliminates the need for multiple cables for installation
- Customized designs reduces cable inventory requirements

ENVIRONMENTAL SPECIFICATIONS

	Riser	Plenum
Operation	-40°C to +75°C	-40°C to +70°C
Storage/Shipping	-40°C to +75°C	-40°C to +70°C
Installation	-20°C to +65°C	0°C to +60°C

SUSTAINABILITY LEADERSHIP



UL and the related logo are registered trademarks of UL LLC. Health Product Declaration, HPD and the related logo are trademarks of Health Product Declaration Collaborative. Telcordia is a registered trademark of Ericsson Inc. USGBC and the related logo are registered trademarks of U.S. Green Building Council.

PART NUMBERS AND PHYSICAL CHARACTERISTICS

Listing	Part Number ¹	Configuration	Fiber Count	Nominal Diameter in (mm)	Nominal Weight lbs/kft (kg/km)	Maximum Compression lbf/in (N/cm)	Maximum Tensile Loading		Minimum Bend Radius	
							Install lbs (N)	Long Term lbs (N)	Install in (mm)	Long Term in (mm)
OFCR	L3002xW01	Single unit	2	0.54 (13.8)	90 (134)	286 (500)	150 (670)	45 (200)	8.2 (207)	5.4 (138)
OFCR	L3004xW01	Single unit	4	0.54 (13.8)	93 (139)	286 (500)	150 (670)	45 (200)	8.2 (207)	5.4 (138)
OFCR	L3006xW01	Single unit	6	0.54 (13.8)	96 (144)	286 (500)	150 (670)	45 (200)	8.2 (207)	5.4 (138)
OFCR	L3008xW01	Single unit	8	0.54 (13.8)	101 (150)	286 (500)	150 (670)	45 (200)	8.2 (207)	5.4 (138)
OFCR	L3012xW01	Single unit	12	0.61 (15.6)	116 (173)	286 (500)	150 (670)	45 (200)	9.2 (234)	6.1 (156)
OFCP	L4002xW01	Single unit	2	0.50 (12.7)	78 (116)	286 (500)	150 (670)	45 (200)	7.5 (191)	5.0 (127)
OFCP	L4004xW01	Single unit	4	0.50 (12.7)	79 (118)	286 (500)	150 (670)	45 (200)	7.5 (191)	5.0 (127)
OFCP	L4006xW01	Single unit	6	0.50 (12.7)	88 (131)	286 (500)	150 (670)	45 (200)	7.5 (191)	5.0 (127)
OFCP	L4008xW01	Single unit	8	0.50 (12.7)	90 (134)	286 (500)	150 (670)	45 (200)	7.5 (191)	5.0 (127)
OFCP	L4012xW01	Single unit	12	0.55 (13.9)	104 (155)	286 (500)	150 (670)	45 (200)	8.2 (209)	5.5 (139)
OFCR	L3018xW01	Multi-unit	18	0.95 (24.1)	248 (370)	228 (400)	300 (1,340)	90 (400)	14.2 (362)	9.5 (241)
OFCR	L3024xW01	Multi-unit	24	0.93 (23.6)	265 (396)	228 (400)	300 (1,340)	90 (400)	14.0 (354)	9.3 (236)
OFCR	L3036xW01	Multi-unit	36	1.05 (26.7)	351 (523)	171 (300)	300 (1,340)	90 (400)	15.7 (400)	10.5 (267)
OFCR	L3048xW01	Multi-unit	48	1.02 (26.0)	321 (479)	171 (300)	300 (1,340)	90 (400)	15.4 (390)	10.2 (260)
OFCR	L3072xW01	Multi-unit	72	1.14 (28.9)	409 (610)	171 (300)	600 (2,700)	180 (800)	17.1 (434)	11.4 (289)
OFCR	L3096xW01	Multi-unit	96	1.17 (29.7)	443 (660)	171 (300)	600 (2,700)	180 (800)	17.5 (445)	11.7 (297)
OFCR	L3144xW01	Multi-unit	144	1.35 (34.2)	573 (854)	171 (300)	600 (2,700)	180 (800)	20.2 (513)	13.5 (342)
OFCP	L4018x201	Multi-unit	18	0.85 (21.7)	257 (383)	228 (400)	300 (1,340)	90 (400)	12.8 (326)	8.5 (217)
OFCP	L4024x201	Multi-unit	24	0.88 (22.4)	276 (412)	228 (400)	300 (1,340)	90 (400)	13.2 (335)	8.8 (224)
OFCP	L4036x201	Multi-unit	36	1.02 (25.8)	375 (559)	171 (300)	300 (1,340)	90 (400)	15.2 (387)	10.2 (258)
OFCP	L4048x201	Multi-unit	48	0.91 (23.1)	339 (505)	171 (300)	300 (1,340)	90 (400)	13.6 (347)	9.1 (231)
OFCP	L4072x201	Multi-unit	72	1.10 (27.9)	442 (659)	171 (300)	300 (1,340)	90 (400)	16.5 (418)	11.0 (279)

¹Part numbers listed above include aluminum interlock armored. Steel interlock armored available upon request.

SINGLE MODE OPTICAL FIBER TYPES			
	TeraFlex® Bend Resistant		
	G.657.A1	G.657.A2	G.657.B3
¹ Replace "x" with:	K	J	L
Jacket Color	Black		

MULTIMODE OPTICAL FIBER TYPES				
	TeraGain® 62.5/125	TeraFlex Bend Resistant Laser Optimized 50/125		
		10G/150	10G/300	10G/550
¹ Replace "x" with:	6	M	N	P
Jacket Color	Black			

¹Other jacket colors available upon request.
See "Optical Fiber Specifications" in the "Technical Information" section for detailed fiber type specifications.

Bundled Composite Category 6

CMR

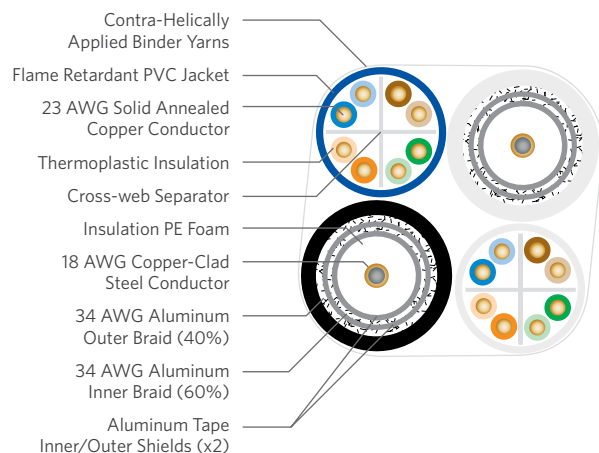

SPECIFICATIONS

CAT 6 UTP Component

Pair Count: 4
 Conductor: Solid annealed copper
 AWG (mm): 23 (0.57)
 Insulation: Thermoplastic
 Separator: Cross-web
 Jacket: Flame retardant PVC

Characteristic Impedance (Ohms)	100 ± 15
Nominal Velocity of Propagation (%)	70
Fiber Component*	62.5/125 µm duplex, 5 mm round, 900 µm tight buffered

Coax RG-6 Quad Shield Component

Conductor: Copper clad steel
 AWG (mm): 18 (1.02)
 Insulation: Polyethylene
 Inner Shield: 2.8 mil aluminum foil
 Inner Braid: 34 AWG aluminum (60%)
 Outer Shield: 1.8 mil aluminum foil
 Outer Braid: 34 AWG aluminum (40%)
 Jacket: PVC
 Electrical: See "Coax RG-6, Quad Shield CM/CATV, CMR/CATVR, CMP/CL2P, Interlock Armored CMR" on page A-104

Binder Yarn	Flexible, dual binder yarns, contra-helically applied
-------------	---

PRODUCT DESCRIPTION

Superior Essex offers multiple configurations of skip-wrapped or bundled riser-rated (CMR) composite cables to support common drop configurations used in residential structured wiring installations. These composite cables improve installation time and reduce the chance of violating minimum bend radius of the cable. The individual components support many technologies, including extended bandwidth satellite service, 1000BASE-T and 100BASE-TX Ethernet and high-definition TV signals. This product is also available with an optical fiber cable.

APPLICATIONS

- 10BASE-T through 1000BASE-T Ethernet
- Power over Ethernet (PoE) - IEEE 802.3af
- PoE+ - IEEE 802.3at Type 1 and 2
- ATM and token ring
- HDTV, CATV, CCTV and DBS

FEATURES

- All-in-one cable design
- RG-6 Quad Shield coaxial cable with typical bandwidth that exceeds 3 GHz
- Multiple constructions available
- Optional optical fiber premises cable
- Flexible, dual binder yarns, contra-helically applied

BENEFITS

- Reduces installation time, provides additional protection to the individual cables
- "Future-Proofing" the installation. Supports extended bandwidth satellite service and high-definition TV signals
- Customized flexibility for the application
- Integrated fiber reduces the need to install separate cables for home interior optical networks
- Maintains maximum flexibility and allows for easy breakout

SPECIFICATIONS (CONTINUED)

Component Performance Compliance	UL® 444 CSA C22.2 No. 214-08 UL 1666 ANSI/TIA-568-C.2 ANSI/ICEA S-83-596-2001 Article 800, NEC (NFPA 70) RoHS-compliant/RoHS 2-compliant
Component NRTL Programs	UL, c(UL) Listed CMR

PART NUMBERS AND PHYSICAL CHARACTERISTICS

Listing	Part Number	Type and Number of Cable Components			Nominal Diameter in (mm)	Nominal Weight lbs/kft (kg/km)	Package
		CAT 6	RG-6 Quad	62.5 2-fiber*			
CMR	D3-2009SA	1	1	-	0.53 (14)	56 (124)	Cut to length on plywood reel
CMR	D3-5009SA	1	2	-	0.56 (14)	88 (195)	Cut to length on plywood reel
CMR	D3-A009SA	2	1	-	0.51 (13)	81 (178)	Cut to length on plywood reel
CMR	D3-D009SA	2	2	-	0.67 (17)	113 (248)	Cut to length on plywood reel
CMR	D3-J009SA	3	1	-	0.67 (17)	105 (232)	Cut to length on plywood reel
CMR	D3-M009SA	3	2	-	0.81 (21)	137 (302)	Cut to length on plywood reel
CMR	D3-S009SA	4	1	-	0.82 (21)	130 (286)	Cut to length on plywood reel
CMR	D3-V009SA	4	2	-	0.85 (22)	162 (356)	Cut to length on plywood reel
CMR	D3-B169SA	2	1	1	0.56 (14)	95 (210)	Cut to length on plywood reel
CMR	D3-E169SA	2	2	1	0.51 (13)	127 (280)	Cut to length on plywood reel
CMR	D3-K169SA	3	1	1	0.67 (17)	120 (263)	Cut to length on plywood reel
CMR	D3-N169SA	3	2	1	0.67 (17)	152 (334)	Cut to length on plywood reel
CMR	D3-T169SA	4	1	1	0.81 (21)	144 (317)	Cut to length on plywood reel

*Other fiber types and fiber counts available upon request. UL is a registered trademark of UL LLC.

Bundled Composite Category 5e

CMR

PRODUCT DESCRIPTION

Superior Essex offers multiple configurations of skip-wrapped or bundled riser-rated (CMR) composite cables to support common drop configurations used in residential structured wiring installations. These composite cables improve installation time and reduce the chance of violating minimum bend radius of the cable. The individual components support many technologies, including extended bandwidth satellite service, 1000BASE-T and 100BASE-TX Ethernet and high definition TV signals. This product is also available with an optical fiber cable.

APPLICATIONS

- 10BASE-T through 1000BASE-T Ethernet
- Power over Ethernet (PoE) - IEEE 802.3af
- PoE+ - IEEE 802.3at Type 1 and 2
- ATM and token ring
- HDTV, CATV, CCTV and DBS

FEATURES

- All-in-one cable design
- RG-6 Quad Shield coaxial cable with typical bandwidth that exceeds 3 GHz
- Multiple constructions available
- Optional optical fiber premises cable
- Flexible, dual binder yarns, contra-helically applied

BENEFITS

- Reduces installation time, provides additional protection to the individual cables
- "Future-Proofing" the installation. Supports extended bandwidth satellite service and high-definition TV signals
- Customized flexibility for the application
- Integrated fiber reduces the need to install separate cables for home interior optical networks
- Maintains maximum flexibility and allows for easy breakout

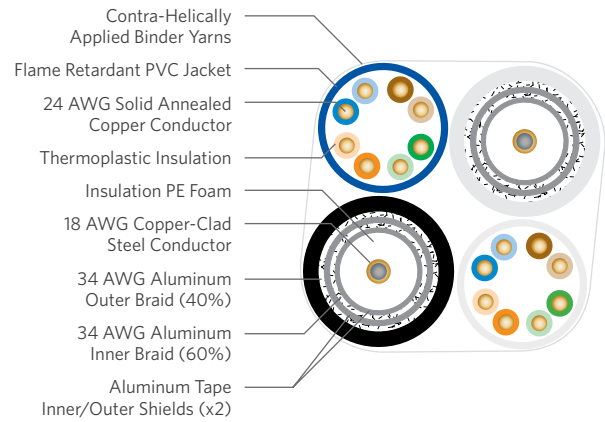

SPECIFICATIONS

CAT 5e UTP Component	Pair Count: 4 Conductor: Solid annealed copper AWG (mm): 24 (0.51) Insulation: Thermoplastic Jacket: Flame retardant PVC
Characteristic Impedance (Ohms)	100 ± 15
Nominal Velocity of Propagation (%)	70
Fiber Component*	62.5/125 µm duplex, 5 mm round, 900 µm tight buffered
Coax RG-6 Quad Shield Component	Conductor: Copper clad steel AWG (mm): 18 (1.02) Insulation: Polyethylene Inner Shield: 2.8 mil aluminum foil Inner Braid: 34 AWG aluminum (60%) Outer Shield: 1.8 mil aluminum foil Outer Braid: 34 AWG aluminum (40%) Jacket: PVC Electrical: See "Coax RG-6, Quad Shield CM/CATV, CMR/CATVR, CMP/CL2P, Interlock Armored CMR" on page A-104
Binder Yarn	Flexible, dual binder yarns, contra-helically applied

SPECIFICATIONS (CONTINUED)

Component Performance Compliance	UL® 444 CSA C22.2 No. 214-08 UL 1666 ANSI/TIA-568-C.2 ANSI/ICEA S-83-596-2001 Article 800, NEC (NFPA 70) RoHS-compliant/RoHS 2-compliant
Component NRTL Programs	UL, c(UL) Listed CMR

PART NUMBERS AND PHYSICAL CHARACTERISTICS

Listing	Part Number	Type and Number of Cable Components			Nominal Diameter in (mm)	Nominal Weight lbs/kft (kg/km)	Package
		CAT 5e	RG-6 Quad	62.5 2-fiber*			
CMR	D1-2009S5	1	1	-	0.49 (12)	51 (113)	Cut to length on plywood reel
CMR	D1-5009S5	1	2	-	0.53 (13)	83 (183)	Cut to length on plywood reel
CMR	D1-A009S5	2	1	-	0.45 (12)	71 (156)	Cut to length on plywood reel
CMR	D1-D009S5	2	2	-	0.61 (16)	103 (226)	Cut to length on plywood reel
CMR	D1-J009S5	3	1	-	0.58 (15)	90 (198)	Cut to length on plywood reel
CMR	D1-M009S5	3	2	-	0.73 (19)	122 (269)	Cut to length on plywood reel
CMR	D1-S009S5	4	1	-	0.71 (18)	110 (241)	Cut to length on plywood reel
CMR	D1-V009S5	4	2	-	0.85 (22)	142 (311)	Cut to length on plywood reel
CMR	D1-3169S5	1	1	1	0.53 (13)	66 (145)	Cut to length on plywood reel
CMR	D1-6169S5	1	2	1	0.45 (12)	98 (215)	Cut to length on plywood reel
CMR	D1-B169S5	2	1	1	0.61 (16)	85 (187)	Cut to length on plywood reel
CMR	D1-E169S5	2	2	1	0.58 (15)	117 (258)	Cut to length on plywood reel
CMR	D1-K169S5	3	1	1	0.73 (19)	105 (230)	Cut to length on plywood reel
CMR	D1-N169S5	3	2	1	0.71 (18)	137 (300)	Cut to length on plywood reel
CMR	D1-T169S5	4	1	1	0.85 (22)	124 (273)	Cut to length on plywood reel
CMR	D1-W169S5	4	2	1	0.85 (22)	156 (343)	Cut to length on plywood reel

*Other fiber types and fiber counts available upon request. UL is a registered trademark of UL LLC.

Residential Broadband Riser

Coax RG-6 Quad Shield, Category 6 and Optical Fiber

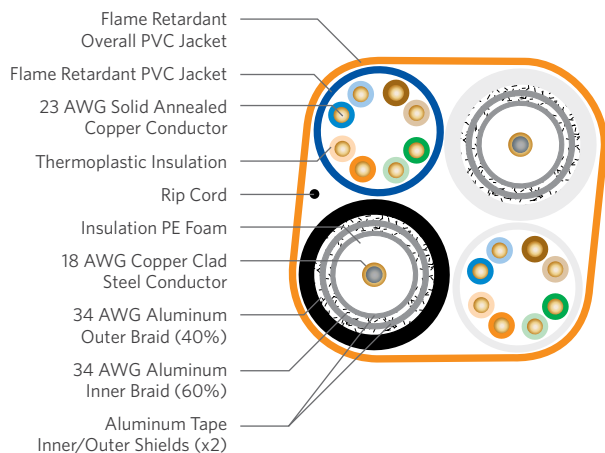

SPECIFICATIONS

CAT 6 UTP Component	Pair Count: 4 Conductor: Solid annealed copper AWG (mm): 23 (0.57) Insulation: Thermoplastic Jacket: Flame retardant PVC
Characteristic Impedance Ohms	100 ± 15
Nominal Velocity of Propagation %	70
Fiber Component	62.5/125 µm duplex, 5 mm round, 900 µm tight buffered
Coax RG-6 Quad Shield Component	Conductor: Copper clad steel AWG (mm): 18 (1.02) Insulation: Polyethylene Inner Shield: 2.8 mil aluminum foil Inner Braid: 34 AWG aluminum (60%) Outer Shield: 1.8 mil aluminum foil Outer Braid: 34 AWG aluminum (40%) Jacket: PVC Electrical: See "Coax RG-6, Quad Shield CM/CATV, CMR/CATVR, CMP/CL2P, Interlock Armored CMR" on page A-104
Overall Jacket	Orange, flame retardant PVC UL® 444 CSA C22.2 No. 214-08 UL 1666
Performance Compliance	ANSI/TIA-568-C.2 ANSI/ICEA S-83-596-2001 Article 800, NEC (NFPA 70) RoHS-compliant/RoHS 2-compliant
NRTL Programs	UL, c(UL) Listed CMR

PRODUCT DESCRIPTION

Superior Essex offers multiple configurations of Residential Broadband riser-rated (CMR) composite cables to support the three common drop configurations used in residential structured wiring installations. These composite cables improve installation time and reduce the chance of violating minimum bend radius of the cable. The individual components support many technologies, including extended bandwidth satellite service, 1000BASE-T and 100BASE-TX Ethernet and high-definition TV signals. This product is also available with a 62.5 µm duplex multimode fiber.

APPLICATIONS

- 10BASE-T through 1000BASE-T Ethernet
- Power over Ethernet (PoE) - IEEE 802.3af
- PoE+ - IEEE 802.3at Type 1 and 2
- ATM and token ring
- HDTV, CATV, CCTV and DBS

FEATURES

- All-in-one cable design
- RG-6 Quad Shield coaxial cable with typical bandwidth that exceeds 3 GHz
- Multiple constructions available
- TeraGain® multimode optical fiber (optional)

BENEFITS

- Reduces installation time, provides additional protection to the individual cables
- "Future-Proofing" the installation. Supports extended bandwidth satellite service and high-definition TV signals
- Customized flexibility for the application
- Integrated fiber reduces the need to install separate cables for home interior optical networks

PART NUMBERS AND PHYSICAL CHARACTERISTICS

Part Number	Description	Nominal Diameter in (mm)	Approx. Weight lbs/kft (kg/km)	Standard Length ft (m)	Package	Packages per Pallet
72-512-01	1 RG-6 Quad x 1 CAT 6	0.37 x 0.54 (9.27 x 13.59)	70 (104)	1,000 (305)	Plywood reel	4
72-621-03	2 RG-6 Quad x 2 CAT 6	0.62 x 0.54 (15.7 x 13.5)	130 (193)	500 (152)	Plywood reel	4
7A-621-03	2 RG-6 Quad x 2 CAT 6 x 1 Duplex 62.5/125 MMF	0.62 x 0.54 (15.7 x 13.6)	144 (214)	500 (152)	Plywood reel	4

UL is a registered trademark of UL LLC.

Residential Broadband Riser

Coax RG-6 Quad Shield, Category 5e and Optical Fiber

PRODUCT DESCRIPTION

Superior Essex offers multiple configurations of Residential Broadband riser-rated (CMR) composite cables to support the three common drop configurations used in residential structured wiring installations. These composite cables improve installation time and reduce the chance of violating minimum bend radius of the cable. The individual components support many technologies, including extended bandwidth satellite service, 1000BASE-T and 100BASE-TX Ethernet and high definition TV signals. This product is also available with a 62.5 µm duplex multimode fiber.

APPLICATIONS

- 10BASE-T through 1000BASE-T Ethernet
- Power over Ethernet (PoE) - IEEE 802.3af
- PoE+ - IEEE 802.3at Type 1 and 2
- ATM and token ring
- HDTV, CATV, CCTV and DBS

FEATURES

- All-in-one cable design
- RG-6 Quad Shield coaxial cable with typical bandwidth that exceeds 3 GHz
- Multiple constructions available
- TeraGain® multimode optical fiber (optional)
- CAT 5e, 4-pair

BENEFITS

- Reduces installation time, provides additional protection to the individual cables
- "Future-Proofing" the installation. Supports extended bandwidth satellite service and high-definition TV signals
- Customized flexibility for the application
- Integrated fiber reduces the need to install separate cables for home interior optical networks
- For high bandwidth applications

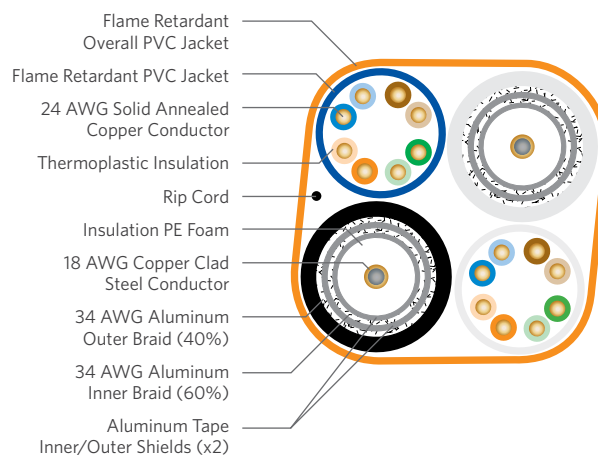

SPECIFICATIONS

CAT 5e UTP Component	Pair Count: 4 Conductor: Solid annealed copper AWG (mm): 24 (0.51) Insulation: Thermoplastic Jacket: Flame retardant PVC
Characteristic Impedance Ohms	100 ± 15
Nominal Velocity of Propagation %	70
Fiber Component	62.5/125 µm duplex, 5 mm round, 900 µm tight buffered
Coax RG-6 Quad Shield Component	Conductor: Copper clad steel AWG (mm): 18 (1.02) Insulation: Polyethylene Inner Shield: 2.8 mil aluminum foil Inner Braid: 34 AWG aluminum (60%) Outer Shield: 1.8 mil aluminum foil Outer Braid: 34 AWG aluminum (40%) Jacket: PVC Electrical: See "Coax RG-6, Quad Shield CM/CATV, CMR/CATVR, CMP/CL2P, Interlock Armored CMR" on page A-104
Overall Jacket	Orange, flame retardant PVC UL® 444 CSA C22.2 No. 214-08 UL 1666
Performance Compliance	ANSI/TIA-568-C.2 ANSI/ICEA S-83-596-2001 Article 800, NEC (NFPA 70) RoHS-compliant/RoHS 2-compliant
NRTL Programs	UL, c(UL) Listed CMR

PART NUMBERS AND PHYSICAL CHARACTERISTICS

Part Number	Description	Nominal Diameter in (mm)	Approx. Weight lbs/kft (kg/km)	Standard Length ft (m)	Package	Packages per Pallet
72-312-01	1 RG-6 Quad x 1 CAT 5e	0.365 x 0.535 (9.27 x 13.59)	73 (109)	1,000 (305)	Plywood reel	4
72-421-03	2 RG-6 Quad x 2 CAT 5e	0.640 x 0.535 (16.00 x 13.59)	135 (201)	500 (152)	Plywood reel	4
7A-421-03	2 RG-6 Quad x 2 CAT 5e x 1 Duplex 62.5/125 MMF	0.660 x 0.537 (16.80 x 13.64)	149 (222)	500 (152)	Plywood reel	4

UL is a registered trademark of UL LLC.

10Gain® XP Category 6A

CMR/CMP

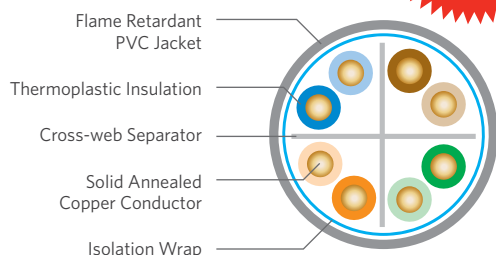

SPECIFICATIONS

Pair Count	4
Conductor	Solid annealed copper
AWG (mm)	23 (0.57)
Insulation	CMR: Thermoplastic CMP: FEP
Insulation Colors	Pair 1: ColorTip Light Blue, Blue Pair 2: ColorTip Light Orange, Orange Pair 3: ColorTip Light Green, Green Pair 4: ColorTip Light Brown, Brown
Separator	Cross-web
Isolation Wrap	Proprietary construction
Jacket	CMR: Flame retardant (FR) PVC CMP: FR, low smoke PVC
Characteristic Impedance Ohms	100 ± 15
Velocity of Propagation %	CMR: 66 CMP: 71
Performance Compliance	UL 444 CSA C22.2 No. 214-08 UL 1666 NFPA 262 ANSI/TIA-568-C.2 Article 800, NEC (NFPA 70)
NRTL Programs	UL Verified CAT 6A UL, c(UL) Listed CMR UL, c(UL) Listed CMP
Sustainability	UL Certified EPD HPD Multi-Attribute Certification USGBC® Member RoHS-compliant/RoHS 2-compliant REACH-compliant

PRODUCT DESCRIPTION



FIRST MANUFACTURER IN THE INDUSTRY
to offer products that contribute toward LEED!

10Gain® XP, with its non-conductive Isolation Wrap, is the first Category 6A cable without a continuous shield to offer 7 dB margin over Alien Crosstalk (AXT) performance requirements in ANSI/TIA-568-C.2. The uniquely designed Isolation Wrap contains discontinuous sections of metallized material, held in place by a polymeric layer. **10Gain XP** has a nominal 0.265 (CMP) or 0.275 (CMR) inch diameter which allows for higher cable density than other CAT 6A cable products. **10Gain XP** fully complies with UL® 444 requirements for an unshielded twisted pair product. 10Gain XP is ideal for applications requiring higher levels of current and simultaneously up to 10 Gigabit Ethernet.

APPLICATIONS

- 10BASE-T through 10GBASE-T Ethernet
- Power over Ethernet (PoE) – IEEE 802.3af
- PoE+ – IEEE 802.3at Type 1 and 2
- 4PPoE+ – IEEE 802.3bt Type 3 and 4 draft D1.2
- ATM and token ring
- Backward compatible to legacy protocols and applications

FEATURES

- UL Certified Environmental Product Declaration (EPD)
- Health Product Declaration™ (HPD™)
- Multi-Attribute Certification by GreenCircle Certified, LLC
- Non-conductive Isolation Wrap
- Tested to 650 MHz
- Nominal 0.265 (CMP) or 0.275 (CMR) inch diameter
- CableID® alpha numeric code printed every 2 feet
- ColorTip® circuit identification system
- Tested up to 100 W in most severe temperature conditions in a bundle of 100 cables

BENEFITS

- Contributes toward 1 LEED point under the Material and Resources credit (MRC)
- Contributes toward 1 LEED point under the MRC
- Offers an overview of the sustainability of a product, its packaging and manufacturing
- Guaranteed 7 dB AXT performance in virtually any installation environment without grounding or bonding
- Assures ample bandwidth headroom
- Allows higher cable density, smaller bend radius and lowers installation costs
- Allows both ends of a cable run to be easily identifiable without the need to separately label or tone the cable
- Easily identifiable conductor mates even in low-light environments
- Offers 82% power efficiency and lowest temperature increase inside a bundle

PART NUMBERS AND PHYSICAL CHARACTERISTICS

Listing	Part Number ¹	Nominal Diameter in (mm)	Approx. Weight lbs/kft (kg/km)	Package	Packages per Pallet
CMR	6H-246-xA	0.275 (6.99)	29 (43)	1,000' BrakeBox	12
CMR	6H-272-xA	0.275 (6.99)	29 (43)	1,000' Plywood reel	12
CMP	6H-246-xB	0.265 (6.73)	35 (52)	1,000' BrakeBox	12
CMP	6H-272-xB	0.265 (6.73)	35 (52)	1,000' Plywood reel	12

JACKET COLORS

¹Replace "x" with:

Blue = 2

Gray = 3

White = 4

Green = 5

Yellow = 6

Purple = 7

Red = 9

Orange = D

Black = E

ELECTRICAL SPECIFICATIONS

Frequency MHz	Insertion Loss @ 20°C Maximum dB/100 m		NEXT Minimum dB/100 m		ACR Minimum dB/100 m		PSNEXT Minimum dB/100 m		PSACR Minimum dB/100 m	
	Guaranteed	Typical	Guaranteed	Typical	Guaranteed	Typical	Guaranteed	Typical	Guaranteed	Typical
1	2.1	2.0	74.3	78.3	72.2	77.3	72.3	77.3	70.2	76.3
4	3.8	3.7	65.3	69.3	61.5	66.6	63.3	68.3	59.5	65.6
8	5.3	5.1	60.8	64.8	55.4	60.6	58.8	63.8	53.4	59.6
10	5.9	5.7	59.3	63.3	53.4	58.6	57.3	62.3	51.4	57.6
16	7.5	7.3	56.2	60.2	48.8	54.0	54.2	59.2	46.8	53.0
20	8.4	8.1	54.8	58.8	46.4	51.7	52.8	57.8	44.4	51.2
25	9.4	9.1	53.3	57.3	44.0	49.7	51.3	56.3	42.0	49.0
31.25	10.5	10.2	51.9	55.9	41.4	47.2	49.9	54.9	39.4	46.7
62.5	15.0	14.4	47.4	51.4	32.4	39.0	45.4	50.4	30.4	38.4
100	19.1	18.4	44.3	48.3	25.2	32.4	42.3	47.3	23.2	31.7
200	27.6	26.5	39.8	43.8	12.2	20.1	37.8	42.8	10.2	19.5
250	31.1	29.8	38.3	42.3	7.3	15.5	36.3	41.3	5.3	15.1
300	34.3	32.9	37.1	41.1	2.9	11.4	35.1	40.1	0.9	10.8
400	40.1	38.3	35.3	39.3		4.6	33.3	38.3		3.6
500	45.3	43.0	33.8	37.8			31.8	36.8		
600		47.5		36.4				35.6		
650		49.7		35.9				35.1		

Frequency MHz	Return Loss Minimum dB/100 m		ACRF Minimum dB/100 m		PSACRF Minimum dB/100 m		PSANEXT Minimum dB/100 m		PSAACRF Minimum dB/100 m	
	Guaranteed	Typical	Guaranteed	Typical	Guaranteed	Typical	Guaranteed	Typical	Guaranteed	Typical
1	20.0	22.0	67.8	73.8	64.8	70.8	74.0	96.5	74.0	80.0
4	23.0	25.0	55.8	61.8	52.8	58.8	74.0	87.5	73.2	79.2
8	24.5	26.5	49.7	55.7	46.7	52.7	74.0	83.0	67.1	73.1
10	25.0	27.0	47.8	53.8	44.8	50.8	74.0	81.5	65.2	71.2
16	25.0	27.0	43.7	49.7	40.7	46.7	74.0	80.0	61.1	67.1
20	25.0	27.0	41.8	47.8	38.8	44.8	74.0	80.0	59.2	65.2
25	24.3	26.3	39.8	45.8	36.8	42.8	74.0	80.0	57.2	63.2
31.25	23.6	25.6	37.9	43.9	34.9	40.9	74.0	80.0	55.3	61.3
62.5	21.5	23.5	31.9	37.9	28.9	34.9	72.6	78.6	49.3	55.3
100	20.1	22.1	27.8	33.8	24.8	30.8	69.5	75.5	45.2	51.2
200	18.0	20.0	21.8	27.8	18.8	24.8	65.0	71.0	39.2	45.2
250	17.3	19.3	19.8	25.8	16.8	22.8	63.5	69.5	37.2	43.2
300	16.8	18.8	18.3	24.3	15.3	21.3	62.3	68.3	35.7	41.7
400	15.9	17.9	15.8	21.8	12.8	18.8	60.5	66.5	34.2	39.2
500	15.2	17.2	13.8	19.8	10.8	16.8	59.0	65.0	31.2	37.2
600		16.7		18.2		15.2		63.8		35.6
650		16.4		17.5		14.5		63.3		34.9

SUSTAINABILITY LEADERSHIP



UL and the related logo are registered trademarks of UL LLC. Health Product Declaration, HPD and the related logo are trademarks of Health Product Declaration Collaborative. GreenCircle Certified logo is a registered trademark of GreenCircle Certified, LLC. USGBC and the related logo are registered trademarks of U.S. Green Building Council.

10Gain® Category 6A

CMR/CMP

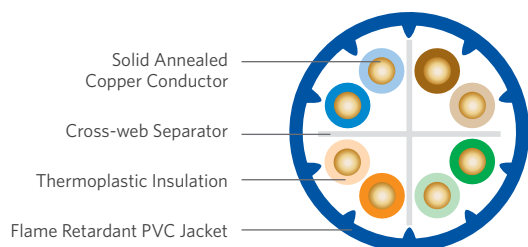

SPECIFICATIONS

Pair Count	4
Conductor	Solid annealed copper
AWG (mm)	23 (0.57)
Insulation	CMR: Polyolefin CMP: FEP
Insulation Colors	Pair 1: ColorTip Light Blue, Blue Pair 2: ColorTip Light Orange, Orange Pair 3: ColorTip Light Green, Green Pair 4: ColorTip Light Brown, Brown
Separator	Cross-web
Jacket	CMR: Flame retardant (FR) PVC CMP: FR, low smoke PVC
Characteristic Impedance Ohms	100 ± 15
Velocity of Propagation %	CMR: 65 CMP: 68
Performance Compliance	UL 444 CSA C22.2 No. 214-08 UL 1666 NFPA 262 ANSI/TIA-568-C.2 Article 800, NEC (NFPA 70)
NRTL Programs	UL Verified CAT 6A UL, c(UL) Listed CMR UL, c(UL) Listed CMP
Sustainability	UL Certified EPD HPD Multi-Attribute Certification USGBC® Member RoHS-compliant/RoHS 2-compliant REACH-compliant

PRODUCT DESCRIPTION



FIRST MANUFACTURER IN THE INDUSTRY
to offer products that contribute toward LEED!

10Gain® cable brings Category 6A UTP performance to a new level. This cable meets the internal and alien cross-talk performance requirements of ANSI/TIA-568-C.2 as tested in a 6 around 1 configuration. With guaranteed performance out to 500 MHz and independently verified and monitored by UL, 10Gain CAT 6A cable demonstrates superior capability for 10 Gigabit Ethernet (10 GbE) and all other bandwidth intensive and legacy applications.

APPLICATIONS

- 10BASE-T through 10GBASE-T Ethernet
- Power over Ethernet (PoE) - IEEE 802.3af
- PoE+ - IEEE 802.3at Type 1 and 2
- ATM and token ring
- Backward compatible to legacy protocols and applications

FEATURES

- UL Certified Environmental Product Declaration (EPD)
- Health Product Declaration™ (HPD™)
- Multi-Attribute Certification by GreenCircle Certified, LLC
- UL Verified CAT 6A
- Tested to 650 MHz
- Exceptional PSACR and PSAACRF (PSAELFEXT) performance
- CableID® alpha numeric code printed every 2 feet
- QuickCount® marking system in feet and meters
- ColorTip® circuit identification system

BENEFITS

- Contributes toward 1 LEED point under the Material and Resources credit (MRc)
- Contributes toward 1 LEED point under the MRC
- Offers an overview of the sustainability of a product, its packaging and manufacturing
- Assures consistent, worry-free performance
- Assures ample bandwidth headroom
- Performance assurance for 10 GbE and multiple high-bandwidth applications
- Allows both ends of a cable run to be easily identifiable without the need to separately label or tone the cable
- Provides remaining length of cable on reel
- Easily identifiable conductor mates even in low-light environments

PART NUMBERS AND PHYSICAL CHARACTERISTICS

Listing	Part Number ¹	Nominal Diameter in (mm)	Approx. Weight lbs/kft (kg/km)	Package	Packages per Pallet
CMR	6A-272-xA	0.350 (8.9)	51 (76)	1,000' Plywood reel	12
CMP	6A-246-xB	0.295 (7.5)	43 (64)	1,000' BrakeBox	12
CMP	6A-272-xB	0.295 (7.5)	43 (64)	1,000' Plywood reel	12

JACKET COLORS

¹Replace "x" with:

Blue = 2

Gray = 3

White = 4

Green = 5

Yellow = 6

Purple = 7

Red = 9

Orange = D

ELECTRICAL SPECIFICATIONS

Frequency MHz	Insertion Loss @ 20°C Maximum dB/100 m			NEXT Minimum dB/100 m			ACR Minimum dB/100 m			PSNEXT Minimum dB/100 m			PSACR Minimum dB/100 m		
	TIA-568-C.2		Superior Essex	TIA-568-C.2		Superior Essex	TIA-568-C.2		Superior Essex	TIA-568-C.2		Superior Essex	TIA-568-C.2		Superior Essex
	Specified	Guar.	Typical	Specified	Guar.	Typical	Calculated	Guar.	Typical	Specified	Guar.	Typical	Calculated	Guar.	Typical
1	2.7	2.0	1.7	74.3	75.3	92.4	72.2	74.3	90.7	72.3	74.3	90.3	70.2	72.3	88.7
4	3.8	3.6	3.4	65.3	66.3	82.2	61.5	63.5	78.9	63.3	65.3	80.5	59.5	61.5	77.2
8	5.3	5.1	4.7	60.8	61.8	78.0	55.5	57.5	73.3	58.8	60.8	76.4	53.5	55.5	71.7
10	5.9	5.7	5.3	59.3	60.3	76.5	53.4	55.4	71.2	57.3	59.3	74.8	51.4	53.4	69.6
16	7.5	7.2	6.7	56.2	57.2	73.8	48.8	50.8	67.2	54.2	56.2	72.0	46.7	48.8	65.4
20	8.4	8.1	7.6	54.8	55.8	71.1	46.4	48.5	63.6	52.8	54.8	69.7	44.4	46.5	62.2
25	9.4	9.1	8.5	53.3	54.3	68.9	43.9	46.0	60.5	51.3	53.3	67.4	41.9	44.0	59.1
31.25	10.5	10.2	9.5	51.9	52.9	68.3	41.4	43.5	58.9	49.9	51.9	67.0	39.4	41.5	57.6
62.5	15.0	14.5	13.6	47.4	48.4	64.3	32.4	34.5	50.8	45.4	47.4	62.3	30.4	32.5	49.0
100	19.1	18.5	17.4	44.3	45.3	61.2	25.2	27.3	44.0	42.3	44.3	59.2	23.2	25.3	42.2
200	27.6	26.8	25.1	39.8	40.8	57.1	12.2	14.3	32.4	37.8	39.8	54.9	10.2	12.3	30.3
250	31.1	30.2	28.2	38.3	39.3	55.9	7.2	9.4	27.6	36.3	38.3	53.3	5.2	7.4	25.4
300	34.3	33.3	31.1	37.1	38.1	53.7	2.8	5.0	22.8	35.1	37.1	51.5	0.8	3.0	20.9
350	37.2	36.3	33.8	36.1	37.1	52.7		1.0	19.1	34.1	36.1	50.1			16.9
400	40.1	39.0	36.3	35.3	37.3	52.4			15.3	33.3	36.3	49.3			13.5
500	45.3	44.1	41.0	33.8	35.8	48.7			7.7	31.8	34.8	46.2			5.8
550			43.2			45.6			2.3			43.7			1.0
600			45.3			44.0						42.2			
650			47.5			42.0						40.2			

Frequency MHz	Return Loss Minimum dB/100 m			ACRF Minimum dB/100 m			PSACRF Minimum dB/100 m			PSANEXT Minimum dB/100 m			PSAACRF Minimum dB/100 m		
	TIA-568-C.2		Superior Essex	TIA-568-C.2		Superior Essex	TIA-568-C.2		Superior Essex	TIA-568-C.2		Superior Essex	TIA-568-C.2		Superior Essex
	Specified	Guar.	Typical	Specified	Guar.	Typical	Specified	Guar.	Typical	Specified	Guar.	Typical	Specified	Guar.	Typical
1	20.0	20.0	27.3	67.8	72.8	83.6	64.8	69.8	81.2	67.0	67.0	94.8	67.0	67.0	71.2
4	23.0	23.0	33.1	55.8	60.8	72.0	52.8	57.8	69.6	67.0	67.0	85.7	66.2	66.2	70.3
8	24.5	24.5	35.3	49.7	54.7	66.2	46.7	51.7	63.7	67.0	67.0	81.2	60.1	60.1	64.3
10	25.0	25.0	36.0	47.8	52.8	64.4	44.8	49.8	61.8	67.0	67.0	79.8	58.2	58.2	62.4
16	25.0	25.0	36.5	43.7	48.7	60.3	40.7	45.7	57.8	67.0	67.0	76.7	54.1	54.1	58.3
20	25.0	25.0	38.4	41.8	46.8	58.4	38.8	43.8	56.0	67.0	67.0	75.3	52.2	52.2	56.4
25	24.3	24.3	37.6	39.8	44.8	56.3	36.8	41.8	54.1	67.0	67.0	73.8	50.2	50.2	54.4
31.25	23.6	23.6	37.8	37.9	42.9	54.3	34.9	39.9	52.1	67.0	67.0	72.4	48.3	48.3	52.5
62.5	21.5	21.5	36.6	31.9	36.9	48.3	28.9	33.9	46.1	65.6	65.6	67.8	42.3	42.3	46.5
100	20.1	20.1	33.5	27.8	32.8	44.5	24.8	29.8	42.3	62.5	62.5	64.8	38.2	38.2	42.4
200	18.0	18.0	30.7	21.8	26.8	38.4	18.8	23.8	36.2	58.0	58.0	60.3	32.2	32.2	36.4
250	17.3	17.3	30.3	19.8	24.8	35.0	16.8	21.8	33.4	56.5	56.5	58.8	30.2	30.2	34.4
300	16.8	16.8	26.9	18.3	23.3	33.8	15.3	20.3	31.6	55.3	55.3	57.6	28.7	28.7	32.8
350	16.3	16.3	27.0	16.9	21.9	32.5	13.9	18.9	30.4	54.3	54.3	56.6	27.3	27.3	31.5
400	15.9	15.9	26.9	15.8	19.8	31.8	12.8	17.8	29.8	53.5	53.5	55.7	26.2	26.2	30.3
500	15.2	15.2	24.8	13.8	17.8	29.8	10.8	15.8	28.1	52.0	52.0	54.3	24.2	24.2	28.4
550			24.2			28.8			26.9			53.7			27.6
600			22.7			28.6			26.4			53.1			26.8
650			19.6			27.2			25.3			52.6			26.1

SUSTAINABILITY LEADERSHIP



UL and the related logo are registered trademarks of UL LLC. Health Product Declaration, HPD and the related logo are trademarks of Health Product Declaration Collaborative. GreenCircle Certified logo is a registered trademark of GreenCircle Certified, LLC. USGBC and the related logo are registered trademarks of U.S. Green Building Council.

Category 6A U/FTP (STP)

CMR/CMP

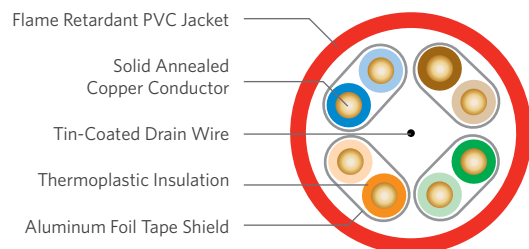

SPECIFICATIONS

Configuration	Copper pairs each surrounded by aluminum/Mylar foil with center drain wire and jacket
Pair Count	4
Conductor	Solid annealed copper
AWG (mm)	23 (0.57)
Insulation	CMR: Polyolefin CMP: FEP
Insulation Colors	Pair 1: ColorTip Light Blue, Blue Pair 2: ColorTip Light Orange, Orange Pair 3: ColorTip Light Green, Green Pair 4: ColorTip Light Brown, Brown
Drain Wire	Tinned copper
Jacket	CMR: Flame retardant (FR) PVC CMP: FR, low smoke PVC
Characteristic Impedance Ohms	100 ± 15
Nominal Velocity of Propagation %	CMR: 73 CMP: 77
Performance Compliance	UL 444 CSA C22.2 No. 214-08 UL 1666 NFPA 262 ANSI/TIA-568-C.2 Article 800, NEC (NFPA 70)
NRTL Programs	UL, c(UL) or ETL, c(ETL) Listed CMR UL, c(UL) or ETL, c(ETL) Listed CMP
Sustainability	UL Certified EPD HPD Multi-Attribute Certification USGBC® Member RoHS-compliant/RoHS 2-compliant REACH-compliant

PART NUMBERS AND PHYSICAL CHARACTERISTICS

Listing	Part Number ¹	Nominal Diameter in (mm)	Approx. Weight lbs/kft (kg/km)	Package	Packages per Pallet
CMR	6S-220-xA	0.32 (8.1)	44 (66)	1,000' Plywood reel	12
CMP	6S-220-xB	0.32 (8.1)	51 (76)	1,000' Plywood reel	12

JACKET COLORS

¹Replace "x" with: Blue = 2 Gray = 3 White = 4 Green = 5 Yellow = 6 Red = 9 Orange = D Black = E

PRODUCT DESCRIPTION



FIRST MANUFACTURER IN THE INDUSTRY
to offer products that contribute toward LEED!

Superior Essex offers Shielded Twisted Pair Category 6A cables in both plenum and riser versions. The cable has guaranteed performance to 600 MHz and meets or exceeds ANSI/TIA-568-C.2 for CAT 6A cables required for 10GBASE-T applications. The cable consists of four (4) balanced 23 AWG copper pairs. Each pair is wrapped with a Mylar® backed aluminum foil with the drain wire in the center of all 4 copper pairs. The wrapped pairs are then jacketed with an appropriate flexible PVC jacket for either plenum or riser applications.

APPLICATIONS

- 10BASE-T through 10GBASE-T Ethernet
- Power over Ethernet (PoE) – IEEE 802.3af
- PoE+ – IEEE 802.3at Type 1 and 2
- ATM and token ring
- Backward compatible to legacy protocols and applications

FEATURES

- UL Certified Environmental Product Declaration (EPD)
- Health Product Declaration™ (HPD™)
- Multi-Attribute Certification by GreenCircle Certified, LLC
- Individually foil shielded pairs
- Exceeds specification ANSI/TIA-568-C.2 for CAT 6A cable performance
- Riser and plenum rated designs
- QuickCount® marking system in feet and meters
- ColorTip® circuit identification system

BENEFITS

- Contributes toward 1 LEED point under the Material and Resources credit (MRc)
- Contributes toward 1 LEED point under the MRc
- Offers an overview of the sustainability of a product, its packaging and manufacturing
- Protects against EMI/RFI and provides exceptional NEXT, PSNEXT, ELFEXT, and electrical performance
- Meets 10GBASE-T application requirements for both Insertion Loss and Return Loss and exceeds requirements for alien and internal crosstalk performance
- UL 1666 and NFPA 262 fire rating options help to reduce additional expensive materials required to meet building safety codes
- Provides remaining length of cable on reel
- Easily identifiable conductor mates even in low-light environments

ELECTRICAL SPECIFICATIONS

Frequency MHz	Insertion Loss @ 20°C Maximum dB/100 m			NEXT Minimum dB/100 m			ACR Minimum dB/100 m			PSNEXT Minimum dB/100 m			PSACR Minimum dB/100 m		
	TIA-568-C.2		Superior Essex	TIA-568-C.2		Superior Essex	TIA-568-C.2		Superior Essex	TIA-568-C.2		Superior Essex	TIA-568-C.2		Superior Essex
	Specified	Guar.	Typical	Specified	Guar.	Typical	Calculated	Guar.	Typical	Specified	Guar.	Typical	Calculated	Guar.	Typical
1	2.1	2.1	2.0	74.3	82.3	84.8	72.2	80.2	82.8	72.3	80.3	82.8	70.2	78.2	80.8
4	3.8	3.8	3.7	65.3	73.3	75.8	61.5	69.5	72.1	63.3	71.3	73.8	59.5	67.5	70.1
8	5.3	5.3	5.2	60.8	68.8	71.3	55.5	63.5	66.1	58.8	66.8	69.3	53.5	61.5	64.1
10	5.9	5.9	5.8	59.3	67.3	69.8	53.4	61.4	64.0	57.3	65.3	67.8	51.4	59.4	62.0
16	7.5	7.5	7.3	56.2	64.2	66.7	48.7	56.7	59.4	54.2	62.2	64.7	46.7	54.7	57.4
20	8.4	8.4	8.2	54.8	62.8	65.3	46.4	54.4	57.1	52.8	60.8	63.3	44.4	52.4	55.1
25	9.4	9.4	9.2	53.3	61.3	63.8	43.9	51.9	54.6	51.3	59.3	61.8	41.9	49.9	52.6
31.25	10.5	10.5	10.3	51.9	59.9	62.4	41.4	49.4	52.1	49.9	57.9	60.4	39.4	47.4	50.1
62.5	15.0	15.0	14.7	47.4	55.4	57.9	32.4	40.4	43.2	45.4	53.4	55.9	30.4	38.4	41.2
100	19.1	19.1	18.8	44.3	52.3	54.8	25.2	33.2	36.0	42.3	50.3	52.8	23.2	31.2	34
200	27.6	27.6	27.0	39.8	47.8	50.3	12.2	20.2	23.3	37.8	45.8	48.3	10.2	18.2	21.3
250	31.1	31.1	30.4	38.3	46.3	48.8	7.2	15.2	18.4	36.3	44.3	46.8	5.2	13.2	16.4
300	34.3	34.3	33.6	37.1	45.1	47.6	2.8	10.8	14.0	35.1	43.1	45.6	0.8	8.8	12.0
350	37.2	37.2	36.5	36.1	44.1	46.6		6.9	10.1	34.1	42.1	44.6		4.9	8.1
400	40.1	40.1	39.3	35.3	43.3	45.8		3.2	6.5	33.3	41.3	43.8		1.2	4.5
500	45.3	45.3	44.4	33.8	41.8	44.3				31.8	39.8	42.3			
600		50.1	49.5		40.6	43.1					38.6	41.1			

Frequency MHz	Return Loss Minimum dB/100 m			ACRF Minimum dB/100 m			PSACRF Minimum dB/100 m			PSANEXT Minimum dB/100 m			PSAACRF Minimum dB/100 m		
	TIA-568-C.2		Superior Essex	TIA-568-C.2		Superior Essex	TIA-568-C.2		Superior Essex	TIA-568-C.2		Superior Essex	TIA-568-C.2		Superior Essex
	Specified	Guar.	Typical	Specified	Guar.	Typical	Specified	Guar.	Typical	Specified	Guar.	Typical	Specified	Guar.	Typical
1	20.0	20.0	20.6	67.8	69.8	73.8	64.8	66.8	70.8	67.0	70.0	72.0	67.0	70.0	72.0
4	23.0	23.0	23.7	55.8	57.8	61.8	52.8	54.8	58.8	67.0	70.0	72.0	66.2	69.2	71.2
8	24.5	24.5	25.3	49.7	51.7	55.7	46.7	48.7	52.7	67.0	70.0	72.0	60.1	63.1	65.1
10	25.0	25.0	25.8	47.8	49.8	53.8	44.8	46.8	50.8	67.0	70.0	72.0	58.2	61.2	63.2
16	25.0	25.0	25.8	43.7	45.7	49.7	40.7	42.7	46.7	67.0	70.0	72.0	54.1	57.1	59.1
20	25.0	25.0	25.8	41.8	43.8	47.8	38.8	40.8	44.8	67.0	70.0	72.0	52.2	55.2	57.2
25	24.3	24.3	25.1	39.8	41.8	45.8	36.8	38.8	42.8	67.0	70.0	72.0	50.2	53.2	55.2
31.25	23.6	23.6	24.3	37.9	39.9	43.9	34.9	36.9	40.9	67.0	70.0	72.0	48.3	51.3	53.3
62.5	21.5	21.5	22.2	31.9	33.9	37.9	28.9	30.9	34.9	65.6	68.6	70.6	42.3	45.3	47.3
100	20.1	20.1	20.7	27.8	29.8	33.8	24.8	26.8	30.8	62.5	65.5	67.5	38.2	41.2	43.2
200	18.0	18.0	18.5	21.8	23.8	27.8	18.8	20.8	24.8	58.0	61.0	63.0	32.2	35.2	37.2
250	17.3	17.3	17.8	19.8	21.8	25.8	16.8	18.8	22.8	56.5	59.5	61.5	30.2	33.2	35.2
300	16.8	16.8	17.3	18.3	20.3	24.3	15.3	17.3	21.3	55.3	58.3	60.3	28.7	31.7	33.7
350	16.3	16.3	16.8	16.9	18.9	22.9	13.9	15.9	19.9	54.3	57.3	59.3	27.3	30.3	32.3
400	15.9	15.9	16.4	15.8	17.8	21.8	12.8	14.8	18.8	53.5	56.5	58.5	26.2	29.2	31.2
500	15.2	15.2	15.7	13.8	15.8	19.8	10.8	12.8	16.8	52.0	55.0	57.0	24.2	27.2	29.2
600			15.1		14.2	18.2		11.2	15.2			55.1			28.6

SUSTAINABILITY LEADERSHIP



UL and the related logo are registered trademarks of UL LLC. Health Product Declaration, HPD and the related logo are trademarks of Health Product Declaration Collaborative. GreenCircle Certified logo is a registered trademark of GreenCircle Certified, LLC. USGBC and the related logo are registered trademarks of U.S. Green Building Council. Mylar is a registered trademark of E. I. du Pont de Nemours and Company or its affiliates.

Category 6A U/FTP (STP) with FEP Jacket

CMP

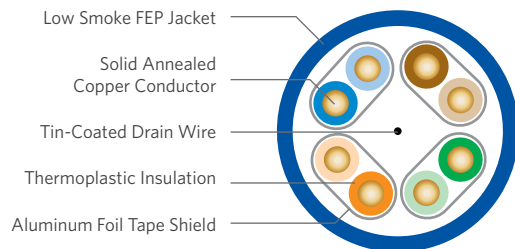

PRODUCT DESCRIPTION

Superior Essex offers Shielded Twisted Pair Category 6A cables with a plenum FEP jacket. The cable has guaranteed performance to 600 MHz and meets or exceeds ANSI/TIA-568-C.2 for CAT 6A cables required for 10GBASE-T applications. The cable consists of four (4) balanced 23 AWG copper pairs. Each pair is wrapped with a Mylar® backed aluminum foil with the drain wire in the center of all 4 copper pairs. The wrapped pairs are then jacketed with a flexible FEP jacket for plenum applications.

APPLICATIONS

- 10BASE-T through 10GBASE-T Ethernet
- Power over Ethernet (PoE) - IEEE 802.3af
- PoE+ - IEEE 802.3at Type 1 and 2
- ATM and token ring
- Backward compatible to legacy protocols and applications

FEATURES

- Individually foil shielded pairs
- Exceeds specification ANSI/TIA-568-C.2 for CAT 6A cable performance
- Plenum rated design
- FEP Jacket
- All fluoropolymer construction
- RoHS-compliant
- QuickCount® marking system in feet and meters
- ColorTip® circuit identification system
- Color-coded box labels

BENEFITS

- Protects against EMI/RFI and provides exceptional NEXT, PSNEXT, ELFEXT, and electrical performance
- Meets 10GBASE-T application requirements for both Insertion Loss and Return Loss and exceeds requirements for alien and internal crosstalk performance
- NFPA 262 fire rating options help to reduce additional expensive materials required to meet building safety codes
- Lower smoke emission in plenum test than PVC
- Resistant to chemical, moisture, thermal exposure
- No heavy metals; no toxic components
- Provides remaining length of cable on reel
- Easily identifiable conductor mates even in low-light environments
- Easily identifiable jacket colors

SPECIFICATIONS

Configuration	Copper pairs each surrounded by aluminum/Mylar® foil with center drain wire and jacket
Pair Count	4
Conductor	Solid annealed copper
AWG (mm)	23 (0.57)
Insulation	FEP
Insulation Colors	Pair 1: ColorTip Light Blue, Blue Pair 2: ColorTip Light Orange, Orange Pair 3: ColorTip Light Green, Green Pair 4: ColorTip Light Brown, Brown
Drain Wire	Tinned copper
Jacket	Low smoke FEP
Characteristic Impedance Ohms	100 ± 15
Nominal Velocity of Propagation %	77
Performance Compliance	UL 444 NFPA 262 ANSI/TIA-568-C.2 Article 800, NEC (NFPA 70) RoHS-compliant
NRTL Programs	UL Verified 6A UL, c(UL) or ETL, c(ETL) Listed CMP

PART NUMBERS AND PHYSICAL CHARACTERISTICS

Part Number ¹	Nominal Diameter in (mm)	Approx. Weight lbs/kft (kg/km)	Package	Packages per Pallet
6S-220-xP	0.27 (6.9)	55 (82)	1,000' Plywood reel	12

JACKET COLORS

¹Replace "x" with: Blue = 2 White = 4

ELECTRICAL SPECIFICATIONS

Frequency MHz	Insertion Loss @ 20°C Maximum dB/100 m			NEXT Minimum dB/100 m			ACR Minimum dB/100 m			PSNEXT Minimum dB/100 m			PSACR Minimum dB/100 m		
	TIA-568-C.2	Superior Essex		TIA-568-C.2	Superior Essex		TIA-568-C.2	Superior Essex		TIA-568-C.2	Superior Essex		TIA-568-C.2	Superior Essex	
	Specified	Guar.	Typical	Specified	Guar.	Typical	Calculated	Guar.	Typical	Specified	Guar.	Typical	Calculated	Guar.	Typical
1	2.1	2.1	2.0	74.3	82.3	84.8	72.2	80.2	82.8	72.3	80.3	82.8	70.2	78.2	80.8
4	3.8	3.8	3.7	65.3	73.3	75.8	61.5	69.5	72.1	63.3	71.3	73.8	59.5	67.5	70.1
8	5.3	5.3	5.2	60.8	68.8	71.3	55.5	63.5	66.1	58.8	66.8	69.3	53.5	61.5	64.1
10	5.9	5.9	5.8	59.3	67.3	69.8	53.4	61.4	64.0	57.3	65.3	67.8	51.4	59.4	62.0
16	7.5	7.5	7.3	56.2	64.2	66.7	48.7	56.7	59.4	54.2	62.2	64.7	46.7	54.7	57.4
20	8.4	8.4	8.2	54.8	62.8	65.3	46.4	54.4	57.1	52.8	60.8	63.3	44.4	52.4	55.1
25	9.4	9.4	9.2	53.3	61.3	63.8	43.9	51.9	54.6	51.3	59.3	61.8	41.9	49.9	52.6
31.25	10.5	10.5	10.3	51.9	59.9	62.4	41.4	49.4	52.1	49.9	57.9	60.4	39.4	47.4	50.1
62.5	15.0	15.0	14.7	47.4	55.4	57.9	32.4	40.4	43.2	45.4	53.4	55.9	30.4	38.4	41.2
100	19.1	19.1	18.8	44.3	52.3	54.8	25.2	33.2	36.0	42.3	50.3	52.8	23.2	31.2	34
200	27.6	27.6	27.0	39.8	47.8	50.3	12.2	20.2	23.3	37.8	45.8	48.3	10.2	18.2	21.3
250	31.1	31.1	30.4	38.3	46.3	48.8	7.2	15.2	18.4	36.3	44.3	46.8	5.2	13.2	16.4
300	34.3	34.3	33.6	37.1	45.1	47.6	2.8	10.8	14.0	35.1	43.1	45.6	0.8	8.8	12.0
350	37.2	37.2	36.5	36.1	44.1	46.6		6.9	10.1	34.1	42.1	44.6		4.9	8.1
400	40.1	40.1	39.3	35.3	43.3	45.8		3.2	6.5	33.3	41.3	43.8		1.2	4.5
500	45.3	45.3	44.4	33.8	41.8	44.3				31.8	39.8	42.3			
600		50.1	49.5		40.6	43.1					38.6	41.1			

Frequency MHz	Return Loss Minimum dB/100 m			ACRF Minimum dB/100 m			PSACRF Minimum dB/100 m			PSANEXT Minimum dB/100 m			PSAACRF Minimum dB/100 m		
	TIA-568-C.2	Superior Essex		TIA-568-C.2	Superior Essex		TIA-568-C.2	Superior Essex		TIA-568-C.2	Superior Essex		TIA-568-C.2	Superior Essex	
	Specified	Guar.	Typical	Specified	Guar.	Typical	Specified	Guar.	Typical	Specified	Guar.	Typical	Specified	Guar.	Typical
1	20.0	20.0	20.6	67.8	69.8	73.8	64.8	66.8	70.8	67.0	70.0	72.0	67.0	70.0	72.0
4	23.0	23.0	23.7	55.8	57.8	61.8	52.8	54.8	58.8	67.0	70.0	72.0	66.2	69.2	71.2
8	24.5	24.5	25.3	49.7	51.7	55.7	46.7	48.7	52.7	67.0	70.0	72.0	60.1	63.1	65.1
10	25.0	25.0	25.8	47.8	49.8	53.8	44.8	46.8	50.8	67.0	70.0	72.0	58.2	61.2	63.2
16	25.0	25.0	25.8	43.7	45.7	49.7	40.7	42.7	46.7	67.0	70.0	72.0	54.1	57.1	59.1
20	25.0	25.0	25.8	41.8	43.8	47.8	38.8	40.8	44.8	67.0	70.0	72.0	52.2	55.2	57.2
25	24.3	24.3	25.1	39.8	41.8	45.8	36.8	38.8	42.8	67.0	70.0	72.0	50.2	53.2	55.2
31.25	23.6	23.6	24.3	37.9	39.9	43.9	34.9	36.9	40.9	67.0	70.0	72.0	48.3	51.3	53.3
62.5	21.5	21.5	22.2	31.9	33.9	37.9	28.9	30.9	34.9	65.6	68.6	70.6	42.3	45.3	47.3
100	20.1	20.1	20.7	27.8	29.8	33.8	24.8	26.8	30.8	62.5	65.5	67.5	38.2	41.2	43.2
200	18.0	18.0	18.5	21.8	23.8	27.8	18.8	20.8	24.8	58.0	61.0	63.0	32.2	35.2	37.2
250	17.3	17.3	17.8	19.8	21.8	25.8	16.8	18.8	22.8	56.5	59.5	61.5	30.2	33.2	35.2
300	16.8	16.8	17.3	18.3	20.3	24.3	15.3	17.3	21.3	55.3	58.3	60.3	28.7	31.7	33.7
350	16.3	16.3	16.8	16.9	18.9	22.9	13.9	15.9	19.9	54.3	57.3	59.3	27.3	30.3	32.3
400	15.9	15.9	16.4	15.8	17.8	21.8	12.8	14.8	18.8	53.5	56.5	58.5	26.2	29.2	31.2
500	15.2	15.2	15.7	13.8	15.8	19.8	10.8	12.8	16.8	52.0	55.0	57.0	24.2	27.2	29.2
600			15.1		14.2	18.2		11.2	15.2			55.1			28.6

Category 6A F/UTP (ScTP)

CMR/CMP

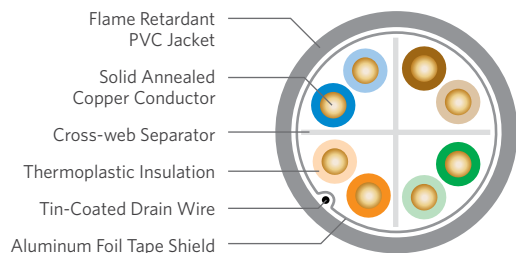

SPECIFICATIONS

Configuration	Copper pairs surrounded by aluminum PET foil with an outer drain wire and jacket
Pair Count	4
Conductor	Solid annealed copper
AWG (mm)	23 (0.57)
Insulation	CMR: Thermoplastic CMP: FEP
Insulation Colors	Pair 1: ColorTip Light Blue, Blue Pair 2: ColorTip Light Orange, Orange Pair 3: ColorTip Light Green, Green Pair 4: ColorTip Light Brown, Brown
Separator	Cross-web
Shield	Aluminum/PET
Drain Wire	Tinned copper
Jacket	CMR: Flame retardant (FR) PVC CMP: FR, low smoke PVC
Characteristic Impedance Ohms	100 ± 15
Nominal Velocity of Propagation %	CMR: 66 CMP: 71
Performance Compliance	UL 444 CSA C22.2 No. 214-08 UL 1666 NFPA 262 ANSI/TIA-568-C.2 Article 800, NEC (NFPA 70)
NRTL Programs	UL Verified CAT 6A UL, c(UL) Listed CMR UL, c(UL) Listed CMP
Sustainability	UL Certified EPD HPD Multi-Attribute Certification USGBC® Member RoHS-compliant/RoHS 2-compliant REACH-compliant

PRODUCT DESCRIPTION



FIRST MANUFACTURER IN THE INDUSTRY
to offer products that contribute toward LEED!

Category 6A F/UTP (ScTP) cable, swept out to 650 MHz, meets or exceeds ANSI/TIA-568-C.2 for CAT 6A cables, a requirement for 10GBASE-T applications. The cable is UL® Verified CAT 6A and has a typical Alien Crosstalk margin of 18 dB.

The cable consists of four (4) balanced 23 AWG copper pairs around a flame retardant cross-web. The core is wrapped with a Mylar® backed aluminum foil. A drain wire is applied longitudinally against the tape. The cable is then protected with a flexible riser or plenum rated PVC jacket.

APPLICATIONS

- 10BASE-T through 10GBASE-T Ethernet
- Power over Ethernet (PoE) - IEEE 802.3af
- PoE+ - IEEE 802.3at Type 1 and 2
- ATM and token ring
- Backward compatible to legacy protocols and applications

FEATURES

- UL Certified Environmental Product Declaration (EPD)
- Health Product Declaration™ (HPD™)
- Multi-Attribute Certification by GreenCircle Certified, LLC
- Overall shielded core
- Exceeds ANSI/TIA-568-C.2 specification for CAT 6A cable performance
- UL Verified CAT 6A
- Riser and plenum rated designs
- CableID® alpha numeric code printed every 2 feet
- QuickCount® marking system in feet and meters
- ColorTip® circuit identification system

BENEFITS

- Contributes toward 1 LEED point under the Material and Resources credit (MRC)
- Contributes toward 1 LEED point under the MRC
- Offers an overview of the sustainability of a product, its packaging and manufacturing
- Protects against EMI/RFI
- 18 dB typical margin Alien Crosstalk performance
- Meets all 10GBASE-T application requirements
- Exceeds requirements for Alien Crosstalk performance
- Assures CAT 6A performance by a nationally recognized test lab
- Meets all fire safety requirements for either backbone or horizontal applications
- Allows both ends of a cable run to be easily identifiable without the need to separately label or tone the cable
- Provides remaining length of cable on reel
- Easily identifiable conductor mates even in low-light environments

PART NUMBERS AND PHYSICAL CHARACTERISTICS

Listing	Part Number ¹	Nominal Diameter in (mm)	Approx. Weight lbs/kft (kg/km)	Package	Packages per Pallet
CMR	6F-246-xA	0.29 (7.3)	32 (48)	1,000' BrakeBox®	12
CMR	6F-272-xA	0.29 (7.3)	32 (48)	1,000' Plywood reel	12
CMR	6F-273-xA	0.29 (7.3)	32 (48)	2,500' Plywood reel	8
CMP	6F-246-xB	0.28 (7.1)	37 (55)	1,000' BrakeBox	12
CMP	6F-272-xB	0.28 (7.1)	37 (55)	1,000' Plywood reel	12
CMP	6F-273-xB	0.28 (7.1)	37 (55)	2,500' Plywood reel	8

JACKET COLORS

¹Replace "x" with:

Blue = 2

Gray = 3

White = 4

Green = 5

Yellow = 6

Purple = 7

Red = 9

Orange = D

ELECTRICAL SPECIFICATIONS

Frequency MHz	Insertion Loss @ 20°C Maximum dB/100 m			NEXT Minimum dB/100 m			ACR Minimum dB/100 m			PSNEXT Minimum dB/100 m			PSACR Minimum dB/100 m		
	TIA-568-C.2		Superior Essex	TIA-568-C.2		Superior Essex	TIA-568-C.2		Superior Essex	TIA-568-C.2		Superior Essex	TIA-568-C.2		Superior Essex
	Specified	Guar.	Typical	Specified	Guar.	Typical	Calculated	Guar.	Typical	Specified	Guar.	Typical	Calculated	Guar.	Typical
1	2.1	2.1	2.0	74.3	74.3	76.8	72.2	72.2	74.8	72.3	72.3	74.8	70.2	70.2	72.8
4	3.8	3.8	3.7	65.3	65.3	67.8	61.5	61.5	64.1	63.3	63.3	65.8	59.5	59.5	62.1
8	5.3	5.3	5.2	60.8	60.8	63.3	55.5	55.5	58.1	58.8	58.8	61.3	53.5	53.5	56.1
10	5.9	5.9	5.8	59.3	59.3	61.8	53.4	53.4	56.0	57.3	57.3	59.8	51.4	51.4	54.0
16	7.5	7.5	7.3	56.2	56.2	58.7	48.7	48.7	51.4	54.2	54.2	56.7	46.7	46.7	49.4
20	8.4	8.4	8.2	54.8	54.8	57.3	46.4	46.4	49.1	52.8	52.8	55.3	44.4	44.4	47.1
25	9.4	9.4	9.2	53.3	53.3	55.8	43.9	43.9	46.6	51.3	51.3	53.8	41.9	41.9	44.6
31.25	10.5	10.5	10.3	51.9	51.9	54.4	41.4	41.4	44.1	49.9	49.9	52.4	39.4	39.4	42.1
62.5	15.0	15.0	14.7	47.4	47.4	49.9	32.4	32.4	35.2	45.4	45.4	47.9	30.4	30.4	33.2
100	19.1	19.1	18.8	44.3	44.3	46.8	25.2	25.2	28.0	42.3	42.3	44.8	23.2	23.2	26.0
200	27.6	27.6	27.0	39.8	39.8	42.3	12.2	12.2	15.3	37.8	37.8	40.3	10.2	10.2	13.3
250	31.1	31.1	30.4	38.3	38.3	40.8	7.2	7.2	10.4	36.3	36.3	38.8	5.2	5.2	8.4
300	34.3	34.3	33.6	37.1	37.1	39.6	2.8	2.8	6.0	35.1	35.1	37.6	0.8	0.8	4.0
350	37.2	37.2	36.5	36.1	36.1	38.6			2.1	34.1	34.1	36.6			0.1
400	40.1	40.1	39.3	35.3	35.3	37.8				33.3	33.3	35.8			
500	45.3	45.3	44.4	33.8	33.8	36.3				31.8	31.8	34.3			
600		50.1	49.5		32.6	35.1					30.6	33.1			

Frequency MHz	Return Loss Minimum dB/100 m			ACRF Minimum dB/100 m			PSACRF Minimum dB/100 m			PSANEXT Minimum dB/100 m			PSAACRF Minimum dB/100 m		
	TIA-568-C.2		Superior Essex	TIA-568-C.2		Superior Essex	TIA-568-C.2		Superior Essex	TIA-568-C.2		Superior Essex	TIA-568-C.2		Superior Essex
	Specified	Guar.	Typical	Specified	Guar.	Typical	Specified	Guar.	Typical	Specified	Guar.	Typical	Specified	Guar.	Typical
1	20.0	20.0	20.6	67.8	67.8	71.8	64.8	64.8	68.8	67.0	70.0	72.0	67.0	70.0	72.0
4	23.0	23.0	23.7	55.8	55.8	59.8	52.8	52.8	56.8	67.0	70.0	72.0	66.2	69.2	71.2
8	24.5	24.5	25.3	49.7	49.7	53.7	46.7	46.7	50.7	67.0	70.0	72.0	60.1	63.1	65.1
10	25.0	25.0	25.8	47.8	47.8	51.8	44.8	44.8	48.8	67.0	70.0	72.0	58.2	61.2	63.2
16	25.0	25.0	25.8	43.7	43.7	47.7	40.7	40.7	44.7	67.0	70.0	72.0	54.1	57.1	59.1
20	25.0	25.0	25.8	41.8	41.8	45.8	38.8	38.8	42.8	67.0	70.0	72.0	52.2	55.2	57.2
25	24.3	24.3	25.1	39.8	39.8	43.8	36.8	36.8	40.8	67.0	70.0	72.0	50.2	53.2	55.2
31.25	23.6	23.6	24.3	37.9	37.9	41.9	34.9	34.9	38.9	67.0	70.0	72.0	48.3	51.3	53.3
62.5	21.5	21.5	22.2	31.9	31.9	35.9	28.9	28.9	32.9	65.6	68.6	70.6	42.3	45.3	47.3
100	20.1	20.1	20.7	27.8	27.8	31.8	24.8	24.8	28.8	62.5	65.5	67.5	38.2	41.2	43.2
200	18.0	18.0	18.5	21.8	21.8	25.8	18.8	18.8	22.8	58.0	61.0	63.0	32.2	35.2	37.2
250	17.3	17.3	17.8	19.8	19.8	23.8	16.8	16.8	20.8	56.5	59.5	61.5	30.2	33.2	35.2
300	16.8	16.8	17.3	18.3	18.3	22.3	15.3	15.3	19.3	55.3	58.3	60.3	28.7	31.7	33.7
350	16.3	16.3	16.8	16.9	16.9	20.9	13.9	13.9	17.9	54.3	57.3	59.3	27.3	30.3	32.3
400	15.9	15.9	16.4	15.8	15.8	19.8	12.8	12.8	16.8	53.5	56.5	58.5	26.2	29.2	31.2
500	15.2	15.2	15.7	13.8	13.8	17.8	10.8	10.8	14.8	52.0	55.0	57.0	24.2	27.2	29.2
600			15.1		12.2	16.2		9.8	13.8			55.1			28.6

SUSTAINABILITY LEADERSHIP



UL and the related logo are registered trademarks of UL LLC. Health Product Declaration, HPD and the related logo are trademarks of Health Product Declaration Collaborative. GreenCircle Certified logo is a registered trademark of GreenCircle Certified, LLC. USGBC and the related logo are registered trademarks of U.S. Green Building Council. Mylar is a registered trademark of E. I. du Pont de Nemours and Company or its affiliates.

NextGain® Category 6eX

CMR/CMP

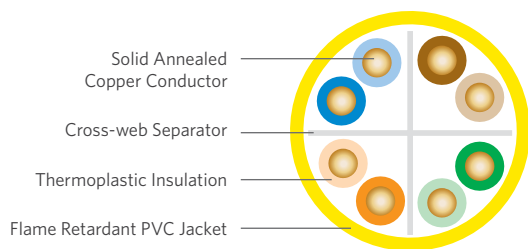

SPECIFICATIONS

Pair Count	4
Conductor	Solid annealed copper
AWG (mm)	23 (0.57)
Insulation	CMR: Polyolefin CMP: FEP
Insulation Colors	Pair 1: ColorTip Light Blue, Blue Pair 2: ColorTip Light Orange, Orange Pair 3: ColorTip Light Green, Green Pair 4: ColorTip Light Brown, Brown
Separator	Cross-web
Jacket	CMR: Flame retardant (FR) PVC CMP: FR, low smoke PVC
Characteristic Impedance Ohms	100 ± 15
Nominal Velocity of Propagation %	CMR: 70 CMP: 74
Performance Compliance	UL 444 CSA C22.2 No. 214-08 UL 1666 NFPA 262 ANSI/TIA-568-C.2 Article 800, NEC (NFPA 70)
NRTL Programs	UL Verified CAT 6 UL, c(UL) Listed CMR UL, c(UL) Listed CMP
Sustainability	UL Certified EPD HPD Multi-Attribute Certification USGBC® Member RoHS-compliant/RoHS 2-compliant REACH-compliant

PRODUCT DESCRIPTION



FIRST MANUFACTURER IN THE INDUSTRY
to offer products that contribute toward LEED!

NextGain® Category 6eX cable brings UTP performance to a new level. Guaranteed for 7 dB of margin (headroom) over base requirements of CAT 6 NEXT standards, this cable maximizes bandwidth for today's leading edge applications and those of the future. With positive ACR verified beyond 300 MHz, NextGain CAT 6eX cable demonstrates superior capability for ATM, Gigabit Ethernet and other bandwidth intensive applications.

APPLICATIONS

- 10BASE-T through 1000BASE-T Ethernet
- Power over Ethernet (PoE) - IEEE 802.3af
- PoE+ - IEEE 802.3at Type 1 and 2
- ATM and token ring
- Supports legacy protocols and applications

FEATURES

- UL Certified Environmental Product Declaration (EPD)
- Health Product Declaration™ (HPD™)
- Multi-Attribute Certification by GreenCircle Certified, LLC
- Guaranteed NEXT of 7 dB greater than CAT 6 requirements
- Guaranteed ACR of 30 dB at 100 MHz and 11.7 dB at 250 MHz
- Exceptional performance over CAT 6 requirements
- BrakeBox® payout control system
- Warrantied with numerous connectivity manufacturers
- CableID® alpha numeric code printed every 2 feet
- QuickCount® marking system in feet and meters
- ColorTip® circuit identification system
- Color coded box labels

BENEFITS

- Contributes toward 1 LEED point under the Material and Resources credit (MRc)
- Contributes toward 1 LEED point under the MRC
- Offers an overview of the sustainability of a product, its packaging and manufacturing
- "Future-proofing" the cable installation
- Performance assurance for multiple high-bandwidth applications (e.g., fast Ethernet, ATM, Gigabit Ethernet)
- Reduces BER, improving network efficiency
- Adjustable tension control on reel prevents over spin and entangling of cable
- Offers flexibility in selection of connectivity solutions
- Allows both ends of a cable run to be easily identifiable without the need to separately label or tone the cable
- Provides remaining length of cable on reel
- Easily identifiable conductor mates even in low-light environments
- Easily identifies jacket colors

PART NUMBERS AND PHYSICAL CHARACTERISTICS

Listing	Part Number ¹	Nominal Diameter in (mm)	Approx. Weight lbs/kft (kg/km)	Package	Packages per Pallet
CMR	54-246-xA	0.23 (5.8)	24 (36)	1,000' BrakeBox	12
CMR	54-272-xA	0.23 (5.8)	24 (36)	1,000' Plywood reel	16
CMP	54-246-xB	0.23 (5.7)	28 (42)	1,000' BrakeBox	12
CMP	54-272-xB	0.23 (5.7)	28 (42)	1,000' Plywood reel	16

JACKET COLORS

¹Replace "x" with:

Blue = 2

Gray = 3

White = 4

Green = 5

Yellow = 6

Purple = 7

Red = 9

ELECTRICAL SPECIFICATIONS

Frequency MHz	Insertion Loss @ 20°C Maximum dB/100 m			NEXT Minimum dB/100 m			ACR Minimum dB/100 m			PSNEXT Minimum dB/100 m		
	TIA-568-C.2	Superior Essex		TIA-568-C.2	Superior Essex		TIA-568-C.2	Superior Essex		TIA-568-C.2	Superior Essex	
	Specified	Guaranteed	Typical	Specified	Guaranteed	Typical	Calculated	Guaranteed	Typical	Specified	Guaranteed	Typical
1	2.0	2.0	1.7	74.3	81.3	94.7	72.3	79.3	92.9	72.3	79.3	92.4
4	3.8	3.8	3.4	65.3	72.3	85.5	61.5	68.5	82.1	63.3	70.3	83.4
10	6.0	5.9	5.4	59.3	66.3	78.9	53.3	60.4	73.6	57.3	64.3	76.9
16	7.6	7.5	6.9	56.2	63.2	76.2	48.6	55.7	69.3	54.2	61.2	74.0
20	8.5	8.4	7.7	54.8	61.8	74.7	46.3	53.4	66.9	52.8	59.8	72.6
25	9.5	9.4	8.7	53.3	60.3	73.2	43.8	50.9	64.5	51.3	58.3	71.1
31.25	10.7	10.6	9.8	51.9	58.9	71.1	41.2	48.3	61.3	49.9	56.9	69.2
62.5	15.4	15.3	14.1	47.4	54.4	66.6	32.0	39.1	52.6	45.4	52.4	64.6
100	19.8	19.7	18.1	44.3	51.3	64.4	24.5	31.6	46.3	42.3	49.3	62.3
200	29.0	28.8	26.3	39.8	46.8	59.0	10.8	18.0	32.9	37.8	44.8	57.0
250	32.8	32.6	29.8	38.3	45.3	58.0	5.5	12.7	28.0	36.3	43.3	55.8
300		36.2	33.0		41.2	56.5		4.7	23.5		39.2	54.3
350		39.5	35.9		40.2	55.1		0.4	19.1		38.2	52.8
400		43.0	38.5		39.3	52.9			14.2		37.3	50.6
450		46.0	41.3		38.5	50.3			9.0		36.5	49.3
500		48.9	44.0		37.8	49.8			6.9		35.8	48.8
550		51.8	46.6		37.2	49.1			3.6		35.2	48.0
650			51.1			47.0						45.1

Frequency MHz	PSACR Minimum dB/100 m			Return Loss Minimum dB/100 m			ELFEXT (ACRF) Minimum dB/100 m			PSELFEXT (PSACRF) Minimum dB/100 m		
	TIA-568-C.2	Superior Essex		TIA-568-C.2	Superior Essex		TIA-568-C.2	Superior Essex		TIA-568-C.2	Superior Essex	
	Calculated	Guaranteed	Typical	Specified	Guaranteed	Typical	Specified	Guaranteed	Typical	Specified	Guaranteed	Typical
1	70.3	77.3	90.7	20.0	20.0	28.8	67.8	73.8	86.7	64.8	70.8	84.8
4	59.5	66.5	80.1	23.0	23.0	33.2	55.7	61.7	74.8	52.7	58.7	73.0
10	51.3	58.4	71.6	25.0	25.0	35.2	47.8	53.8	67.1	44.8	50.8	65.1
16	46.6	53.7	67.2	25.0	25.0	34.8	43.7	49.7	63.2	40.7	46.7	61.2
20	44.3	51.4	65.0	25.0	25.0	35.0	41.7	47.7	61.3	38.7	44.7	59.3
25	41.8	48.9	62.5	24.3	24.3	36.6	39.8	45.8	59.4	36.8	42.8	57.4
31.25	39.2	46.3	59.6	23.6	23.6	36.6	37.9	43.9	57.6	34.9	40.9	55.5
62.5	30.0	37.1	50.7	21.5	21.5	36.0	31.8	37.8	51.8	28.8	34.8	49.7
100	22.5	29.6	44.4	20.1	20.1	35.0	27.8	33.8	48.0	24.8	30.8	45.7
200	8.8	16.0	31.0	18.0	18.0	32.6	21.7	27.7	42.1	18.7	24.7	39.8
250	3.5	10.7	26.3	17.3	17.3	31.8	19.8	25.8	40.1	16.8	22.8	37.8
300		2.7	21.8		16.8	30.7		24.2	38.3		21.2	36.0
350			17.3		16.3	29.3		22.9	37.0		19.9	34.7
400			12.6		15.9	28.7		21.7	35.6		18.7	33.1
450			7.5		15.5	27.8			34.4			32.1
500			5.3		15.2	26.7			32.9			30.6
550			2.0		14.9	25.1			31.5			29.2
650						20.4			28.2			26.0

SUSTAINABILITY LEADERSHIP



UL and the related logo are registered trademarks of UL LLC. Health Product Declaration, HPD and the related logo are trademarks of Health Product Declaration Collaborative. GreenCircle Certified logo is a registered trademark of GreenCircle Certified, LLC. USGBC and the related logo are registered trademarks of U.S. Green Building Council.

DataGain® Category 6+

CMR/CMP

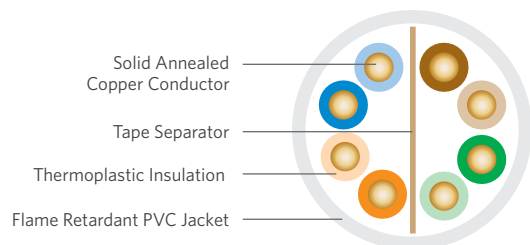

SPECIFICATIONS

Pair Count	4
Conductor	Solid annealed copper
AWG (mm)	23 (0.57)
Insulation	CMR: Polyolefin CMP: FEP
Insulation Colors	Pair 1: ColorTip Light Blue, Blue Pair 2: ColorTip Light Orange, Orange Pair 3: ColorTip Light Green, Green Pair 4: ColorTip Light Brown, Brown
Separator	Tape
Jacket	CMR: Flame retardant (FR) PVC CMP: FR, low smoke PVC
Characteristic Impedance Ohms	100 ± 15
Nominal Velocity of Propagation %	CMR: 70 CMP: 72
Performance Compliance	UL 444 CSA C22.2 No. 214-08 UL 1666 NFPA 262 ANSI/TIA-568-C.2 ANSI/ICEA S-90-661-2012 Article 800, NEC (NFPA 70)
NRTL Programs	UL Verified CAT 6 UL, c(UL) Listed CMR UL, c(UL) Listed CMP
Sustainability	UL Certified EPD HPD Multi-Attribute Certification USGBC® Member RoHS-compliant/RoHS 2-compliant REACH-compliant

PRODUCT DESCRIPTION



FIRST MANUFACTURER IN THE INDUSTRY
to offer products that contribute toward LEED!

DataGain® cable provides the best value in Category 6+ cables on the market today. The innovative design, which utilizes a tape separator, yields exceptional performance that exceeds TIA/EIA CAT 6 specifications. DataGain easily surpasses the performance of other cost-competitive CAT 6 cables.

APPLICATIONS

- 10BASE-T through 1000BASE-T Ethernet
- Power over Ethernet (PoE) - IEEE 802.3af
- PoE+ - IEEE 802.3at Type 1 and 2
- ATM and token ring

FEATURES

- UL Certified Environmental Product Declaration (EPD)
- Health Product Declaration™ (HPD™)
- Multi-Attribute Certification by GreenCircle Certified, LLC
- Guaranteed electrical performance to 400 MHz
- Guaranteed 5 dB margin in NEXT, PSNEXT, ELFEXT, PSELFEXT, ACR and PSACR
- Tested to 550 MHz
- Round design with tape separator
- Warranted with numerous connectivity manufacturers
- BrakeBox® payout control system
- CableID® alpha numeric code printed every 2 feet
- QuickCount® marking system in feet and meters
- ColorTip® circuit identification system
- Color coded box labels

BENEFITS

- Contributes toward 1 LEED point under the Material and Resources credit (MRC)
- Contributes toward 1 LEED point under the MRC
- Offers an overview of the sustainability of a product, its packaging and manufacturing
- Greater assurance of exceptional overall channel performance at a great value
- "Future-proofs" the cable installation
- Assures ample bandwidth headroom
- Reduces installation time
- Offers flexibility in selection of connectivity solutions
- Adjustable tension control on reel prevents over spin and entangling of cable
- Allows both ends of a cable run to be easily identifiable without the need to separately label or tone the cable
- Provides remaining length of cable on reel
- Easily identifiable conductor mates even in low-light environments
- Easily identifies jacket colors

PART NUMBERS AND PHYSICAL CHARACTERISTICS

Listing	Part Number ¹	Nominal Diameter in (mm)	Approx. Weight lbs/kft (kg/km)	Package	Packages per Pallet
CMR	66-246-xA	0.22 (5.5)	24 (36)	1,000' BrakeBox	27
CMR	66-272-xA	0.22 (5.5)	24 (36)	1,000' Plywood reel	16
CMR	66-240-xA	0.22 (5.5)	24 (36)	1,000' POP™ box	36
CMP	66-246-xB	0.22 (5.5)	26 (39)	1,000' BrakeBox	27
CMP	66-272-xB	0.22 (5.5)	26 (39)	1,000' Plywood reel	16
CMP	66-240-xB	0.22 (5.5)	26 (39)	1,000' POP box	36

JACKET COLORS

¹Replace "x" with:

Blue = 2

Gray = 3

White = 4

Green = 5

Yellow = 6

Purple = 7

Red = 9

Pink = C

Orange = D

Black = E

ELECTRICAL SPECIFICATIONS

Frequency MHz	Insertion Loss @ 20°C Maximum dB/100 m			NEXT Minimum dB/100 m			ACR Minimum dB/100 m			PSNEXT Minimum dB/100 m		
	TIA-568-C.2	Superior Essex		TIA-568-C.2	Superior Essex		TIA-568-C.2	Superior Essex		TIA-568-C.2	Superior Essex	
	Specified	Guaranteed	Typical	Specified	Guaranteed	Typical	Calculated	Guaranteed	Typical	Specified	Guaranteed	Typical
1	2.0	2.0	1.7	74.3	79.3	90.6	72.3	77.3	88.9	72.3	77.3	88.2
4	3.8	3.8	3.4	65.3	70.3	80.9	61.5	66.5	77.5	63.3	68.3	78.6
10	6.0	5.9	5.4	59.3	64.3	74.4	53.3	58.4	69.0	57.3	62.3	72.1
16	7.6	7.5	6.9	56.2	61.2	71.4	48.6	53.7	64.5	54.2	59.2	69.1
20	8.5	8.4	7.8	54.8	59.8	70.1	46.3	51.4	62.4	52.8	57.8	67.8
25	9.5	9.4	8.7	53.3	58.3	68.4	43.8	48.9	59.7	51.3	56.3	66.1
31.25	10.7	10.6	9.8	51.9	56.9	67.2	41.2	46.3	57.3	49.9	54.9	64.8
62.5	15.4	15.3	14.1	47.4	52.4	62.5	32.0	37.1	48.4	45.4	50.4	60.3
100	19.8	19.7	18.1	44.3	49.3	59.7	24.5	29.6	41.5	42.3	47.3	57.3
200	29.0	28.8	26.4	39.8	44.8	54.5	10.8	16.0	28.3	37.8	42.8	52.3
250	32.8	32.6	29.8	38.3	43.3	53.5	5.5	10.7	23.5	36.3	41.3	50.8
400		42.7	38.9		36.3	48.2			9.2		34.3	45.6
500			44.2			45.4						43.0
550			47.2			44.0						42.1

Frequency MHz	PSACR Minimum dB/100 m			Return Loss Minimum dB/100 m			ELFEXT (ACRF) Minimum dB/100 m			PSELFEXT (PSACRF) Minimum dB/100 m		
	TIA-568-C.2	Superior Essex		TIA-568-C.2	Superior Essex		TIA-568-C.2	Superior Essex		TIA-568-C.2	Superior Essex	
	Calculated	Guaranteed	Typical	Specified	Guaranteed	Typical	Specified	Guaranteed	Typical	Specified	Guaranteed	Typical
1	70.3	75.3	85.6	20.0	20.0	28.5	67.8	72.7	82.6	64.8	69.8	80.6
4	59.5	64.5	74.3	23.0	23.0	33.8	55.8	60.7	70.7	52.8	57.8	68.8
10	51.3	56.5	65.7	25.0	25.0	36.1	47.8	52.7	62.9	44.8	49.8	60.9
16	46.6	51.7	61.3	25.0	25.0	36.2	43.7	48.6	58.9	40.7	45.7	56.9
20	44.3	49.4	59.2	25.0	25.0	35.9	41.8	46.7	57.0	38.8	43.8	54.9
25	41.8	46.9	56.5	24.3	24.3	36.0	39.8	44.7	55.2	36.8	41.8	53.0
31.25	39.2	44.3	54.2	23.6	23.6	35.7	37.9	42.8	53.3	34.9	39.9	51.1
62.5	30.0	35.1	45.3	21.5	21.5	33.2	31.9	36.8	47.5	28.9	33.9	45.2
100	22.5	27.6	38.5	20.1	20.1	32.2	27.8	32.7	43.6	24.8	29.8	41.3
200	8.8	14.0	25.2	18.0	18.0	30.2	21.8	26.7	37.7	18.8	23.8	35.4
250	3.5	8.7	20.4	17.3	17.3	30.1	19.8	24.7	35.7	16.8	21.8	33.4
400			6.2		15.9	27.0		17.8	30.2		12.8	28.8
500						25.5			28.2			25.9
550						24.6			26.6			24.5

SUSTAINABILITY LEADERSHIP



UL and the related logo are registered trademarks of UL LLC. Health Product Declaration, HPD and the related logo are trademarks of Health Product Declaration Collaborative. GreenCircle Certified logo is a registered trademark of GreenCircle Certified, LLC. USGBC and the related logo are registered trademarks of U.S. Green Building Council.

Category 6+ LSHF

CMR

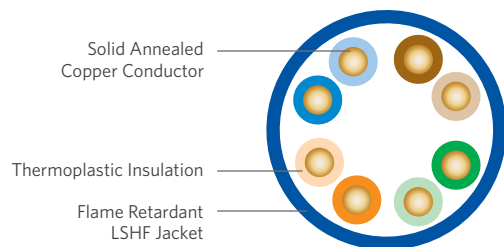

SPECIFICATIONS

Pair Count	4
Conductor	Solid annealed copper
AWG (mm)	23 (0.57)
Insulation	Solid HPDE
Insulation Colors	Pair 1: ColorTip Light Blue, Blue Pair 2: ColorTip Light Orange, Orange Pair 3: ColorTip Light Green, Green Pair 4: ColorTip Light Brown, Brown
Jacket	Flame retardant LSHF
Characteristic Impedance Ohms	100 ± 15
Nominal Velocity of Propagation %	67
Performance Compliance	UL® 444 CSA C22.2 No. 214-08 UL 1666 IEC 60134 IEC 60332-1 IEC 60754 IEC 62821-1 IEC 62821-2 IEC 62821-3 ANSI/TIA-568-C.2 Article 800, NEC (NFPA 70)
NRTL Programs	UL Verified CAT 6 UL, c(UL) Listed CMR-LSHF
Sustainability	HPD USGBC® Member RoHS-compliant/RoHS 2-compliant REACH-compliant

PRODUCT DESCRIPTION



FIRST MANUFACTURER IN THE INDUSTRY
to offer products that contribute toward LEED!

Superior Essex Category 6+ LSHF CMR cable is designed for applications requiring a Low Smoke Halogen-free (LSHF) construction. This cable does not contain any red list materials in its composition. CAT 6 compliance ensures this cable will support 1000BASE-T Gigabit Ethernet. This cable easily surpasses the Grade 2 requirements specified in the ANSI/TIA/EIA-570-B Residential Telecommunications standard.

APPLICATIONS

- 10BASE-T through 1000BASE-T Ethernet
- Power over Ethernet (PoE) - IEEE 802.3af
- PoE+ - IEEE 802.3at Type 1 and 2
- ATM and token ring

FEATURES

- Health Product Declaration™ (HPD™)
- Low Smoke Halogen-free
- Guaranteed 2 dB margin in NEXT, PSNEXT, RL, ACR and PSACR
- UL Listed CMR-LSHF
- Meets and exceeds ANSI/TIA-568-C.2 specification
- Round design without separator
- BrakeBox® payout control system
- CableID® alpha numeric code printed every 2 feet
- QuickCount® marking system in feet and meters
- ColorTip® Circuit Identification System
- Color coded box labels

BENEFITS

- Contributes toward 1 LEED point under the MRc
- Meets IEC 62821 requirements for toxicity, acidity and smoke
- “Future-proofs” the cable installation
- UL listing allows for CMR specific installations
- CAT 6+ compliance
- Reduces installation time
- Adjustable tension control on reel prevents over spin and entangling of cable
- Allows both ends of a cable run to be easily identifiable without the need to separately label or tone the cable
- Provides remaining length of cable on reel
- Easily identifiable conductor mates even in low light environments
- Easily identifies jacket colors

PART NUMBERS AND PHYSICAL CHARACTERISTICS

Listing	Part Number ¹	Nominal Diameter in (mm)	Approx. Weight lbs/kft (kg/km)	Package	Packages per Pallet
CMR-LSHF	66-246-xM	0.25 (6.3)	28 (42)	1,000' BrakeBox	12

JACKET COLORS

¹Replace “x” with: Blue = 2 White = 4

SUSTAINABILITY LEADERSHIP



UL and the related logo are registered trademarks of UL LLC. Health Product Declaration, HPD and the related logo are trademarks of Health Product Declaration Collaborative. USGBC and the related logo are registered trademarks of U.S. Green Building Council.

What is a Multi-Attribute Certification?

Certified Environmental Facts™

Company: Superior Essex®
Products: Cobra CAT 5e+ and Marathon LAN® CAT 5e
Packaging: Reel-in-a-Box
Plant Location: Hoisington, KS

Product Specific:

Recyclable Material ¹	50%
Completed LCA/EPD	Yes — Published EPD
Completed HPD	Yes — Published HPD

Packaging Specific:

Pre-Consumer Recycled Content	41%
Post-Consumer Recycled Content	47%
Recyclable Material ²	100%

Manufacturing Specific:

Carbon Footprint Reduction — Facility ³	92%
Reduced Energy Usage	4%
Reduced Water Usage	23%
Reduced Waste ⁴	0.4%
Zero Waste to Landfill Facility ⁵	Yes
ISO 9001:2008 Registered/TL 9000 Registered	Yes

Evaluation Period: 2011 - 2014
Certification Number: 14-0280
Certification Period: 11/1/2014 - 10/31/2015
 For more information on the Certified Environmental Facts of this product, please contact: info@GreenCircleCertified.com
www.GreenCircleCertified.com

1. Pertains to copper wire only. Wire must be stripped to be recycled.
 2. 100% recyclable in areas with #5 plastic recycling capabilities.
 3. Pertains to Scope 1 emissions only.
 4. Pertains to non-hazardous waste only.
 5. Details on GreenCircle certificate # 15-0238

© Copyright 2014 by GreenCircle Certified, LLC



A Multi-Attribute Certification provides a complete **overview of the sustainability of a product, its packaging and manufacturing operations**. Superior Essex Multi-Attribute Certifications are published through GreenCircle Certified, LLC in accordance with internationally recognized standards and the Federal Trade Commission's Green Guides.

Superior Essex provides CAT 5e – CAT 6 premises copper cabling products with Multi-Attribute Labels.
 Visit ce.SuperiorEssex.com/Enviro for more information.

The GreenCircle Certified logo is a registered trademark of GreenCircle Certified, LLC.

Category 6+ F/UTP (ScTP)

CMR/CMP

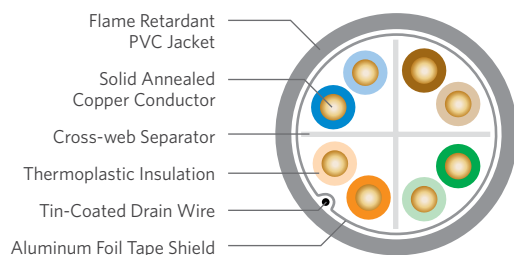

SPECIFICATIONS

Configuration	Copper pairs surrounded by aluminum PET foil with an outer drain wire and jacket
Pair Count	4
Conductor	Solid annealed copper
AWG (mm)	23 (0.57)
Insulation	CMR: Thermoplastic CMP: FEP
Insulation Colors	Pair 1: ColorTip Light Blue, Blue Pair 2: ColorTip Light Orange, Orange Pair 3: ColorTip Light Green, Green Pair 4: ColorTip Light Brown, Brown
Separator	Cross-web
Shield	Aluminum/PET with 10% overlap
Drain Wire	Tinned copper
Jacket	CMR: Flame retardant (FR) PVC CMP: FR, low smoke PVC
Characteristic Impedance Ohms	100 ± 15
Nominal Velocity of Propagation %	CMR: 66 CMP: 71
Performance Compliance	UL 444 CSA C22.2 No. 214-08 UL 1666 NFPA 262 ANSI/TIA-568-C.2 ANSI/TIA/EIA-TSB-155 Article 800, NEC (NFPA 70)
NRTL Programs	UL Verified CAT 6 UL, c(UL) Listed CMR UL, c(UL) Listed CMP
Sustainability	UL Certified EPD HPD Multi-Attribute Certification USGBC® Member RoHS-compliant/RoHS 2-compliant REACH-compliant

PRODUCT DESCRIPTION



FIRST MANUFACTURER IN THE INDUSTRY
to offer products that contribute toward LEED!

Category 6+ F/UTP (ScTP) cable, with guaranteed performance out to 500 MHz, exceeds ANSI/TIA-568-C.2 for CAT 6 cables. The cable is UL Verified CAT 6 and has a typical Alien Crosstalk margin of 18 dB. The cable can be used for 10GBASE-T applications for up to 55 meters per ANSI/TIA/EIA-TSB-155.

The cable consists of four (4) balanced 23 AWG copper pairs around a flame retardant cross-web. The core is wrapped with a Mylar® backed aluminum foil. A drain wire is applied longitudinally against the tape. The cable is then protected with a flexible riser or plenum rated PVC jacket.

APPLICATIONS

- 10GBASE-T (up to 55 meters), 1000BASE-T, 100BASE-T and legacy Ethernet applications
- Power over Ethernet (PoE) - IEEE 802.3af
- PoE+ - IEEE 802.3at Type 1 and 2
- ATM and token ring

FEATURES

- UL Certified Environmental Product Declaration (EPD)
- Health Product Declaration™ (HPD™)
- Multi-Attribute Certification by GreenCircle Certified, LLC
- Overall shielded core
- Guaranteed performance to 500 MHz
- Exceeds ANSI/TIA-568-C.2 specification for CAT 6 cable performance
- UL Verified CAT 6
- Riser and plenum rated designs
- CableID® alpha numeric code printed every 2 feet
- QuickCount® marking system in feet and meters
- ColorTip® circuit identification system

BENEFITS

- Contributes toward 1 LEED point under the Material and Resources credit (MRc)
- Contributes toward 1 LEED point under the MRC
- Offers an overview of the sustainability of a product, its packaging and manufacturing
- Protects against EMI/RFI
- 18 dB typical margin Alien Crosstalk performance
- Assures ample headroom for existing and future high bandwidth applications
- Allows for 10GBASE-T applications up to 55 meters
- Assures CAT 6 performance by a nationally recognized test lab
- Meets all fire safety requirements for either backbone or horizontal applications
- Allows both ends of a cable run to be easily identifiable without the need to separately label or tone the cable
- Provides remaining length of cable on reel
- Easily identifiable conductor mates even in low-light environments

PART NUMBERS AND PHYSICAL CHARACTERISTICS

Listing	Part Number ¹	Nominal Diameter in (mm)	Approx. Weight lbs/kft (kg/km)	Package	Packages per Pallet
CMR	6T-246-xA	0.29 (7.3)	32 (48)	1,000' BrakeBox®	12
CMR	6T-272-xA	0.29 (7.3)	32 (48)	1,000' Plywood reel	12
CMP	6T-246-xB	0.28 (7.1)	37 (55)	1,000' BrakeBox	12
CMP	6T-272-xB	0.28 (7.1)	37 (55)	1,000' Plywood reel	12

JACKET COLORS

¹Replace "x" with: Blue = 2 Gray = 3 White = 4 Green = 5 Yellow = 6 Purple = 7 Red = 9 Orange = D

ELECTRICAL SPECIFICATIONS

Frequency MHz	Insertion Loss @ 20°C Maximum dB/100 m			NEXT Minimum dB/100 m			ACR Minimum dB/100 m			PSNEXT Minimum dB/100 m		
	TIA-568-C.2	Superior Essex		TIA-568-C.2	Superior Essex		TIA-568-C.2	Superior Essex		TIA-568-C.2	Superior Essex	
	Specified	Guaranteed	Typical	Specified	Guaranteed	Typical	Calculated	Guaranteed	Typical	Specified	Guaranteed	Typical
1	2.0	2.0	1.7	74.3	74.3	82.9	72.3	72.3	82.2	72.3	72.3	81.9
4	3.8	3.8	3.4	65.3	65.3	77.6	61.5	61.5	74.2	63.3	63.3	75.0
10	6.0	6.0	5.4	59.3	59.3	70.1	53.3	53.3	64.7	57.3	57.3	68.3
16	7.6	7.6	6.9	56.2	56.2	69.6	48.6	48.6	62.5	54.2	54.2	67.1
20	8.5	8.5	7.8	54.8	54.8	68.7	46.3	46.3	60.7	52.8	52.8	65.7
25	9.5	9.5	8.8	53.3	53.3	66.1	43.8	43.8	58.7	51.3	51.3	64.7
31.25	10.7	10.7	9.8	51.9	51.9	67.8	41.2	41.2	56.2	49.9	49.9	63.4
62.5	15.4	15.4	14.2	47.4	47.4	64.0	32.0	32.0	47.8	45.4	45.4	59.1
100	19.8	19.8	18.2	44.3	44.3	58.0	24.5	24.5	38.7	42.3	42.3	55.0
200	29.0	29.0	26.6	39.8	39.8	53.8	10.8	10.8	26.5	37.8	37.8	50.6
250	32.8	32.8	30.1	38.3	38.3	51.0	5.5	5.5	21.1	36.3	36.3	48.7
300		35.5	33.4		36.2	53.8		0.6	19.4		34.8	49.1
400		42.1	39.5		34.4	49.1			8.0		32.5	44.5
500		48.0	45.1		32.9	42.9					31.0	41.7

Frequency MHz	PSACR Minimum dB/100 m			Return Loss Minimum dB/100 m			ELFEXT (ACRF) Minimum dB/100 m			PSELFEXT (PSACRF) Minimum dB/100 m		
	TIA-568-C.2	Superior Essex		TIA-568-C.2	Superior Essex		TIA-568-C.2	Superior Essex		TIA-568-C.2	Superior Essex	
	Calculated	Guaranteed	Typical	Specified	Guaranteed	Typical	Specified	Guaranteed	Typical	Specified	Guaranteed	Typical
1	70.3	70.3	80.2	20.0	20.0	26.0	67.8	67.8	78.7	64.8	64.8	76.6
4	59.5	59.5	71.6	23.0	23.0	31.1	55.8	55.8	65.9	52.8	52.8	64.2
10	51.3	51.3	62.9	25.0	25.0	36.3	47.8	47.8	58.1	44.8	44.8	56.4
16	46.6	46.6	60.2	25.0	25.0	37.7	43.7	43.7	54.0	40.7	40.7	52.2
20	44.3	44.3	58.1	25.0	25.0	36.0	41.8	41.8	52.1	38.8	38.8	50.3
25	41.8	41.8	56.1	24.3	24.3	38.6	39.8	39.8	50.2	36.8	36.8	48.4
31.25	39.2	39.2	53.6	23.6	23.6	38.3	37.9	37.9	48.1	34.9	34.9	46.4
62.5	30.0	30.0	45.0	21.5	21.5	32.8	31.9	31.9	41.4	28.9	28.9	40.3
100	22.5	22.5	37.0	20.1	20.1	30.7	27.8	27.8	36.8	24.8	24.8	35.2
200	8.8	8.8	24.0	18.0	18.0	27.6	21.8	21.8	32.6	18.8	18.8	31.8
250	3.5	3.5	18.8	17.3	17.3	28.5	19.8	19.8	32.5	16.8	16.8	31.3
300			15.8		15.9	28.6		17.5	30.8		14.5	28.9
400			5.0		14.9	24.9		14.9	24.7		11.9	23.5
500					13.7	25.0		12.5	22.5		9.5	21.5

SUSTAINABILITY LEADERSHIP



UL and the related logo are registered trademarks of UL LLC. Health Product Declaration, HPD and the related logo are trademarks of Health Product Declaration Collaborative. GreenCircle Certified logo is a registered trademark of GreenCircle Certified, LLC. USGBC and the related logo are registered trademarks of U.S. Green Building Council. Mylar is a registered trademark of E. I. du Pont de Nemours and Company or its affiliates.

Category 6

CMR/CMP

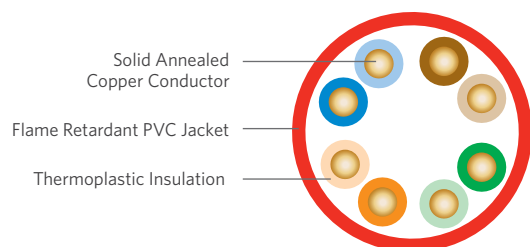
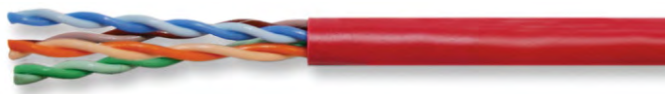

SPECIFICATIONS

Pair Count	4
Conductor	Solid annealed copper
AWG (mm)	23 (0.57)
Insulation	CMR: Polyolefin CMP: FEP
Insulation Colors	Pair 1: ColorTip Light Blue, Blue Pair 2: ColorTip Light Orange, Orange Pair 3: ColorTip Light Green, Green Pair 4: ColorTip Light Brown, Brown
Jacket	CMR: Flame retardant (FR) PVC CMP: FR, low smoke PVC
Characteristic Impedance Ohms	100 ± 15
Nominal Velocity of Propagation %	CMR: 70 CMP: 73
Performance Compliance	UL 444 CSA C22.2 No. 214-08 UL 1666 NFPA 262 ANSI/TIA-568-C.2 Article 800, NEC (NFPA 70)
NRTL Programs	UL Verified CAT 6 UL, c(UL) Listed CMR UL, c(UL) Listed CMP
Sustainability	UL Certified EPD HPD Multi-Attribute Certification USGBC® Member RoHS-compliant/RoHS 2-compliant REACH-compliant

PRODUCT DESCRIPTION



FIRST MANUFACTURER IN THE INDUSTRY
to offer products that contribute toward LEED!

Superior Essex Series 77 product line provides exceptional value for jobs that require standards compliant Category 6 cable at a cost-effective price.

APPLICATIONS

- 10BASE-T through 1000BASE-T Ethernet
- Power over Ethernet (PoE) – IEEE 802.3af
- PoE+ – IEEE 802.3at Type 1 and 2
- ATM and token ring

FEATURES

- UL Certified Environmental Product Declaration (EPD)
- Health Product Declaration™ (HPD™)
- Multi-Attribute Certification by GreenCircle Certified, LLC
- Meets ANSI/TIA-568-C.2 specification
- BrakeBox® payout control system
- CableID® alpha numeric code printed every 2 feet
- QuickCount® marking system in feet and meters
- ColorTip® circuit identification system
- Color coded box labels

BENEFITS

- Contributes toward 1 LEED point under the Material and Resources credit (MRC)
- Contributes toward 1 LEED point under the MRC
- Offers an overview of the sustainability of a product, its packaging and manufacturing
- Provides cost effective solution
- Adjustable tension control on reel prevents over spin and entangling of cable
- Allows both ends of a cable run to be easily identifiable without the need to separately label or tone the cable
- Provides remaining length of cable on reel
- Easily identifiable conductor mates even in low-light environments
- Easily identifies jacket colors

PART NUMBERS AND PHYSICAL CHARACTERISTICS

Listing	Part Number ¹	Nominal Diameter in (mm)	Approx. Weight lbs/kft (kg/km)	Package
CMR	77-xxx-yA	0.21 (5.3)	22 (33)	use key
CMP	77-xxx-yB	0.20 (5.1)	23 (34)	use key

PACKAGING

	150 ft Coil	200 ft Coil	250 ft Coil	300 ft Coil	1,000 ft POP Box	1,000 ft BrakeBox	1,000 ft Plywood Reel	2,500 ft Plywood Reel
¹ Replace "xxx" with:	225	229	230	231	240	246	272	273
Packages per Pallet	120	120	144	120	36	27	16	12

JACKET COLORS

¹Replace "y" with: Blue = 2 Gray = 3 White = 4 Green = 5 Yellow = 6 Purple = 7 Red = 9 Pink = C Orange = D Black = E

ELECTRICAL SPECIFICATIONS

Frequency MHz	Insertion Loss @ 20°C Maximum dB/100 m		NEXT Minimum dB/100 m		ACR Minimum dB/100 m		PSNEXT Minimum dB/100 m	
	TIA-568-C.2	Superior Essex	TIA-568-C.2	Superior Essex	TIA-568-C.2	Superior Essex	TIA-568-C.2	Superior Essex
	Specified	Typical	Specified	Typical	Calculated	Typical	Specified	Typical
1	2.0	1.7	74.3	82.9	72.3	82.2	72.3	81.9
4	3.8	3.4	65.3	77.6	61.5	74.2	63.3	75.0
8	5.3	4.8	60.8	74.4	55.4	68.9	58.8	71.9
10	6.0	5.4	59.3	70.1	53.3	64.7	57.3	68.3
16	7.6	6.9	56.2	69.6	48.6	62.5	54.2	67.1
20	8.5	7.8	54.8	68.7	46.3	60.7	52.8	65.7
25	9.5	8.8	53.3	66.1	43.8	58.7	51.3	64.7
31.25	10.7	9.8	51.9	67.8	41.2	56.2	49.9	63.4
62.5	15.4	14.2	47.4	64.0	32.0	47.8	45.4	59.1
100	19.8	18.2	44.3	58.0	24.5	38.7	42.3	55.0
155	25.2	23.0	41.4	54.5	16.3	31.6	39.4	52.1
200	29.0	26.6	39.8	53.8	10.8	26.5	37.8	50.6
250	32.8	30.1	38.3	51.0	5.5	21.1	36.3	48.7
300		33.4		53.8		19.4		49.1
350		36.5		50.1		14.3		47.5
400		39.5		49.1		8.0		44.5
450		42.3		44.6		3.3		43.4
500		45.1		42.9				41.7
550		47.7		41.6				39.1

Frequency MHz	PSACR Minimum dB/100 m		Return Loss Minimum dB/100 m		ELFEXT Minimum dB/100 m		PSELFEXT Minimum dB/100 m	
	TIA-568-C.2	Superior Essex	TIA-568-C.2	Superior Essex	TIA-568-C.2	Superior Essex	TIA-568-C.2	Superior Essex
	Calculated	Typical	Specified	Typical	Specified	Typical	Specified	Typical
1	70.3	80.2	20.0	26.0	67.8	78.7	64.8	76.6
4	59.5	71.6	23.0	31.1	55.8	65.9	52.8	64.2
8	53.4	67.1	24.5	34.5	49.7	60.1	46.7	58.4
10	51.3	62.9	25.0	36.3	47.8	58.1	44.8	56.4
16	46.6	60.2	25.0	37.7	43.7	54.0	40.7	52.2
20	44.3	58.1	25.0	36.0	41.8	52.1	38.8	50.3
25	41.8	56.1	24.3	38.6	39.8	50.2	36.8	48.4
31.25	39.2	53.6	23.6	38.3	37.9	48.1	34.9	46.4
62.5	30.0	45.0	21.5	32.8	31.9	41.4	28.9	40.3
100	22.5	37.0	20.1	30.7	27.8	36.8	24.8	35.2
155	14.3	29.1	18.8	28.8	24.0	33.3	21.0	31.9
200	8.8	24.0	18.0	27.6	21.8	32.6	18.8	31.8
250	3.5	18.8	17.3	28.5	19.8	32.5	16.8	31.3
300		15.8		28.6		30.8		28.9
350		11.6		29.0		26.8		25.4
400		5.0		24.9		24.7		23.5
450		1.2		23.9		23.2		21.9
500				25.0		22.5		21.5
550				24.2		22.4		22.0

SUSTAINABILITY LEADERSHIP



UL and the related logo are registered trademarks of UL LLC. Health Product Declaration, HPD and the related logo are trademarks of Health Product Declaration Collaborative. GreenCircle Certified logo is a registered trademark of GreenCircle Certified, LLC. USGBC and the related logo are registered trademarks of U.S. Green Building Council.

Category 6

CM

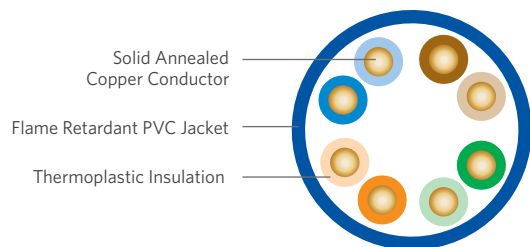

SPECIFICATIONS

Pair Count	4
Conductor	Solid annealed copper
AWG (mm)	23 (0.57)
Insulation	Polyolefin
Insulation Colors	Pair 1: ColorTip Light Blue, Blue Pair 2: ColorTip Light Orange, Orange Pair 3: ColorTip Light Green, Green Pair 4: ColorTip Light Brown, Brown
Jacket	Flame retardant (FR) PVC
Characteristic Impedance Ohms	100 ± 15
Nominal Velocity of Propagation %	70
Performance Compliance	UL® 444 CSA C22.2 No. 214-08 UL 1685 ANSI/TIA-568-C.2 ANSI/TIA/EIA-570-B Article 800, NEC (NFPA 70) RoHS-compliant/RoHS 2-compliant
NRTL Programs	UL Verified CAT 6 UL, c(UL) Listed CM

PRODUCT DESCRIPTION

Superior Essex Category 6 CM cable is designed for residential LAN applications. CAT 6 compliance ensures this cable will support 1000BASE-T Gigabit Ethernet. This cable easily surpasses the Grade 2 requirements specified in the ANSI/TIA/EIA-570-B Residential Telecommunications standard.

APPLICATIONS

- 10BASE-T through 1000BASE-T Ethernet
- Power over Ethernet (PoE) – IEEE 802.3af
- PoE+ – IEEE 802.3at Type 1 and 2
- ATM and token ring

FEATURES

- Meets ANSI/TIA-568-C.2 specification
- CableID® alpha numeric code printed every 2 feet
- QuickCount® marking system in feet and meters
- ColorTip® circuit identification system
- Color coded box labels

BENEFITS

- Provides cost effective solution
- Allows both ends of a cable run to be easily identifiable without the need to separately label or tone the cable
- Provides remaining length of cable on reel
- Easily identifiable conductor mates even in low-light environments
- Easily identifies jacket colors

PART NUMBERS AND PHYSICAL CHARACTERISTICS

Listing	Part Number ¹	Nominal Diameter in (mm)	Approx. Weight lbs/kft (kg/km)	Package	Packages per Pallet
CM	77-272-xG	0.20 (5.1)	20 (30)	1,000' Plywood reel	16

JACKET COLORS

¹ Replace "x" with:	Blue = 2	Gray = 3	White = 4	Green = 5	Red = 9
--------------------------------	----------	----------	-----------	-----------	---------

UL is a registered trademark of UL LLC.

ELECTRICAL SPECIFICATIONS

Frequency MHz	Insertion Loss @ 20°C Maximum dB/100 m		NEXT Minimum dB/100 m		ACR Minimum dB/100 m		PSNEXT Minimum dB/100 m	
	TIA-568-C.2	Superior Essex	TIA-568-C.2	Superior Essex	TIA-568-C.2	Superior Essex	TIA-568-C.2	Superior Essex
	Specified	Typical	Specified	Typical	Calculated	Typical	Specified	Typical
1	2.0	1.7	74.3	82.9	72.3	82.2	72.3	81.9
4	3.8	3.4	65.3	77.6	61.5	74.2	63.3	75.0
8	5.3	4.8	60.8	74.4	55.4	68.9	58.8	71.9
10	6.0	5.4	59.3	70.1	53.3	64.7	57.3	68.3
16	7.6	6.9	56.2	69.6	48.6	62.5	54.2	67.1
20	8.5	7.8	54.8	68.7	46.3	60.7	52.8	65.7
25	9.5	8.8	53.3	66.1	43.8	58.7	51.3	64.7
31.25	10.7	9.8	51.9	67.8	41.2	56.2	49.9	63.4
62.5	15.4	14.2	47.4	64.0	32.0	47.8	45.4	59.1
100	19.8	18.2	44.3	58.0	24.5	38.7	42.3	55.0
155	25.2	23.0	41.4	54.5	16.3	31.6	39.4	52.1
200	29.0	26.6	39.8	53.8	10.8	26.5	37.8	50.6
250	32.8	30.1	38.3	51.0	5.5	21.1	36.3	48.7
300		33.4		53.8		19.4		49.1
350		36.5		50.1		14.3		47.5
400		39.5		49.1		8.0		44.5
450		42.3		44.6		3.3		43.4
500		45.1		42.9				41.7
550		47.7		41.6				39.1

Frequency MHz	PSACR Minimum dB/100 m		Return Loss Minimum dB/100 m		ELFEXT Minimum dB/100 m		PSELFEXT Minimum dB/100 m	
	TIA-568-C.2	Superior Essex	TIA-568-C.2	Superior Essex	TIA-568-C.2	Superior Essex	TIA-568-C.2	Superior Essex
	Calculated	Typical	Specified	Typical	Specified	Typical	Specified	Typical
1	70.3	80.2	20.0	26.0	67.8	78.7	64.8	76.6
4	59.5	71.6	23.0	31.1	55.8	65.9	52.8	64.2
8	53.4	67.1	24.5	34.5	49.7	60.1	46.7	58.4
10	51.3	62.9	25.0	36.3	47.8	58.1	44.8	56.4
16	46.6	60.2	25.0	37.7	43.7	54.0	40.7	52.2
20	44.3	58.1	25.0	36.0	41.8	52.1	38.8	50.3
25	41.8	56.1	24.3	38.6	39.8	50.2	36.8	48.4
31.25	39.2	53.6	23.6	38.3	37.9	48.1	34.9	46.4
62.5	30.0	45.0	21.5	32.8	31.9	41.4	28.9	40.3
100	22.5	37.0	20.1	30.7	27.8	36.8	24.8	35.2
155	14.3	29.1	18.8	28.8	24.0	33.3	21.0	31.9
200	8.8	24.0	18.0	27.6	21.8	32.6	18.8	31.8
250	3.5	18.8	17.3	28.5	19.8	32.5	16.8	31.3
300		15.8		28.6		30.8		28.9
350		11.6		29.0		26.8		25.4
400		5.0		24.9		24.7		23.5
450		1.2		23.9		23.2		21.9
500				25.0		22.5		21.5
550				24.2		22.4		22.0

Category 6 with FEP Jacket

CMP

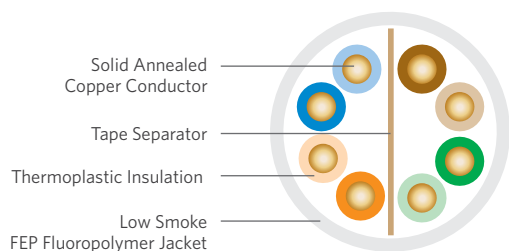

SPECIFICATIONS

Pair Count	4
Conductor	Solid annealed copper
AWG (mm)	23
Insulation	FEP
Insulation Colors	Pair 1: ColorTip Light Blue, Blue Pair 2: ColorTip Light Orange, Orange Pair 3: ColorTip Light Green, Green Pair 4: ColorTip Light Brown, Brown
Jacket	Low smoke FEP
Characteristic Impedance Ohms	100 ± 15
Nominal Velocity of Propagation %	74
Performance Compliance	NFPA 262 ANSI/TIA-568-C.2 Article 800, NEC (NFPA 70)
NRTL Programs	UL Verified 6 UL, c(UL) Listed CMP
Sustainability	UL Certified EPD HPD Multi-Attribute Certification USGBC® Member RoHS-compliant/RoHS 2-compliant REACH-compliant

ENVIRONMENTAL SPECIFICATIONS

Operation	-40°C to +200°C
Storage/Shipping	-40°C to +200°C
Installation	-40°C to +200°C

PART NUMBERS AND PHYSICAL CHARACTERISTICS

Part Number ¹	Nominal Diameter in (mm)	Approx. Weight lbs/kft (kg/km)	Package	Packages per Pallet
66-246-xP	0.20 (5.1)	25 (11)	1,000' BrakeBox	27
66-272-xP	0.20 (5.1)	25 (11)	1,000' Plywood Reel	16

JACKET COLORS

¹Replace "x" with: Blue = 2 White = 4

PRODUCT DESCRIPTION



FIRST MANUFACTURER IN THE INDUSTRY
to offer products that contribute toward LEED!

FEP Jacketed Category 6 Plenum is designed for high-risk applications such as chemical processing plants, petroleum refineries, and temperature extremes. Employing the latest polymer technology, FEP Jacketed Category 6 Plenum is constructed entirely of chemical, oil, heat, and moisture resistant FEP fluoropolymer. It is ideally suited for industrial UTP applications where severe environmental stresses would compromise standard PVC plenum cables. Additionally, the cable is specially processed to ensure a more durable print legend.

APPLICATIONS

- 10BASE-T through 1000BASE-T Ethernet
- Power over Ethernet (PoE) – IEEE 802.3af
- PoE+ – IEEE 802.3at Type 1 and 2
- ATM and token ring
- Works well in high-risk environments
- For installations with thermal or chemical exposure

FEATURES

- UL® Certified Environmental Product Declaration (EPD)
- Health Product Declaration™ (HPD™)
- Multi-Attribute Certification by GreenCircle Certified, LLC
- FEP Jacket
- All fluoropolymer construction
- RoHS-compliant
- Meets or exceeds CAT 6 requirements
- Durable cable print
- BrakeBox® payout control system
- QuickCount® marking system in feet and meters
- ColorTip® circuit identification system
- Color-coded box labels

BENEFITS

- Contributes toward 1 LEED point under the Material and Resources credit (MRc)
- Contributes toward 1 LEED point under the MRc
- Offers an overview of the sustainability of a product, its packaging and manufacturing
- Lower smoke emission in plenum test than PVC
- Resistant to chemical, moisture, thermal exposure
- No heavy metals; no toxic components
- Reliable performance
- Print legend does not rub off
- Adjustable tension control on reel prevents over spin and entangling of cable
- Provides remaining length of cable on reel
- Easily identifiable conductor mates, even in low-light environments
- Easily identifiable jacket colors

ELECTRICAL SPECIFICATIONS

Frequency MHz	Insertion Loss @ 20°C Maximum dB/100 m		NEXT Minimum dB/100 m		ACR Minimum dB/100 m		PSNEXT Minimum dB/100 m	
	TIA-568-C.2	Superior Essex	TIA-568-C.2	Superior Essex	TIA-568-C.2	Superior Essex	TIA-568-C.2	Superior Essex
	Specified	Typical	Specified	Typical	Calculated	Typical	Specified	Typical
1	2.0	1.7	74.3	82.9	72.3	82.2	72.3	81.9
4	3.8	3.4	65.3	77.6	61.5	74.2	63.3	75.0
8	5.3	4.8	60.8	74.4	55.4	68.9	58.8	71.9
10	6.0	5.4	59.3	70.1	53.3	64.7	57.3	68.3
16	7.6	6.9	56.2	69.6	48.6	62.5	54.2	67.1
20	8.5	7.8	54.8	68.7	46.3	60.7	52.8	65.7
25	9.5	8.8	53.3	66.1	43.8	58.7	51.3	64.7
31.25	10.7	9.8	51.9	67.8	41.2	56.2	49.9	63.4
62.5	15.4	14.2	47.4	64.0	32.0	47.8	45.4	59.1
100	19.8	18.2	44.3	58.0	24.5	38.7	42.3	55.0
155	25.2	23.0	41.4	54.5	16.3	31.6	39.4	52.1
200	29.0	26.6	39.8	53.8	10.8	26.5	37.8	50.6
250	32.8	30.1	38.3	51.0	5.5	21.1	36.3	48.7
300		33.4		53.8		19.4		49.1
350		36.5		50.1		14.3		47.5
400		39.5		49.1		8.0		44.5
450		42.3		44.6		3.3		43.4
500		45.1		42.9				41.7
550		47.7		41.6				39.1

Frequency MHz	PSACR Minimum dB/100 m		Return Loss Minimum dB/100 m		ELFEXT Minimum dB/100 m		PSELFEXT Minimum dB/100 m	
	TIA-568-C.2	Superior Essex	TIA-568-C.2	Superior Essex	TIA-568-C.2	Superior Essex	TIA-568-C.2	Superior Essex
	Calculated	Typical	Specified	Typical	Specified	Typical	Specified	Typical
1	70.3	80.2	20.0	26.0	67.8	78.7	64.8	76.6
4	59.5	71.6	23.0	31.1	55.8	65.9	52.8	64.2
8	53.4	67.1	24.5	34.5	49.7	60.1	46.7	58.4
10	51.3	62.9	25.0	36.3	47.8	58.1	44.8	56.4
16	46.6	60.2	25.0	37.7	43.7	54.0	40.7	52.2
20	44.3	58.1	25.0	36.0	41.8	52.1	38.8	50.3
25	41.8	56.1	24.3	38.6	39.8	50.2	36.8	48.4
31.25	39.2	53.6	23.6	38.3	37.9	48.1	34.9	46.4
62.5	30.0	45.0	21.5	32.8	31.9	41.4	28.9	40.3
100	22.5	37.0	20.1	30.7	27.8	36.8	24.8	35.2
155	14.3	29.1	18.8	28.8	24.0	33.3	21.0	31.9
200	8.8	24.0	18.0	27.6	21.8	32.6	18.8	31.8
250	3.5	18.8	17.3	28.5	19.8	32.5	16.8	31.3
300		15.8		28.6		30.8		28.9
350		11.6		29.0		26.8		25.4
400		5.0		24.9		24.7		23.5
450		1.2		23.9		23.2		21.9
500				25.0		22.5		21.5
550				24.2		22.4		22.0

SUSTAINABILITY LEADERSHIP



UL and the related logo are registered trademarks of UL LLC. Health Product Declaration, HPD and the related logo are trademarks of Health Product Declaration Collaborative. GreenCircle Certified logo is a registered trademark of GreenCircle Certified, LLC. USGBC and the related logo are registered trademarks of U.S. Green Building Council.

Category 6

CMR/CMX Outdoor Sunlight Resistant

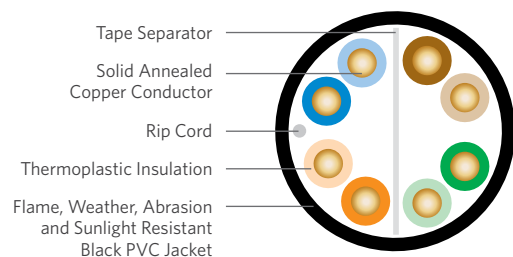

SPECIFICATIONS

Pair Count	4
Conductor	Solid annealed copper
AWG (mm)	23 (0.57)
Insulation	Polyolefin
Insulation Colors	Pair 1: ColorTip Light Blue, Blue Pair 2: ColorTip Light Orange, Orange Pair 3: ColorTip Light Green, Green Pair 4: ColorTip Light Brown, Brown
Ripcord	Non-wicking polyester yarn
Jacket	Tough, flame retardant, weather, sunlight and abrasion resistant riser PVC
Jacket Color	Black
Characteristic Impedance Ohms	100 ± 15
Nominal Velocity of Propagation %	70
Performance Compliance	UL 444 CSA C22.2 No. 214-08 UL 1581 UL 1666 ANSI/TIA-568-C.2 ANSI/TIA/EIA-570-B Article 800, NEC (NFPA 70) RoHS-compliant/RoHS 2-compliant
NRTL Programs	UL Verified CAT 6 UL, c(UL) Listed CMR UL, c(UL) Listed CMX Outdoor Sunlight Resistant

ENVIRONMENTAL SPECIFICATIONS AND TESTS

Operation	-40°F to +167°F (-40°C to +75°C)
Installation	-40°F to +140°F (-40°C to +60°C)
ANSI/ICEA S-100-685-2009 Tested down to -67°F (-55°C)	Section 7.1: -4°F (-20°C) cold bend test Section 7.2: +14°F (-10°C) cold impact test Section 7.3: -40°F (-40°C) anvil test

PART NUMBERS AND PHYSICAL CHARACTERISTICS

Part Number	Nominal Diameter in (mm)	Approx. Weight lbs/kft (kg/km)	Package	Packages per Pallet
77-246-E1	0.27 (6.9)	31 (46)	1,000' BrakeBox	12

UL is a registered trademark of UL LLC.

PRODUCT DESCRIPTION

The Superior Essex Category 6 CMR/CMX Outdoor Sunlight Resistant cable is specifically designed for extreme sunlight and temperature applications. The level of UV blocking compounds is the same as in traditional Outside Plant (OSP) cable products, with the black color preventing damage from long-term UV sunlight exposure. Applications include Ethernet interconnect cable for Wi-Fi or retrofit cable installations that employ exterior runs having long-term outdoor exposure between two environmentally protected points. CMX Outdoor cables are designed to extend the run between the Network Interface Unit and the point of entry into the interior of a residence or a premise.

Superior Essex CAT 6 CMR/CMX Outdoor Sunlight Resistant black premises cable has been tested and listed as UL® 444 Sunlight Resistant compliant. This designation requires the cable to resist 720 hours of harsh UV and heat, which is more than twice the exposure time of the standard 300 hours required in the CMX Outdoor test. In addition, the CMR listing allows the cable to be used in riser spaces per UL 1666, eliminating the need to transition to fire resistant cables.

APPLICATIONS

- 10BASE-T through 1000BASE-T Ethernet
- Power over Ethernet (PoE) - IEEE 802.3af
- PoE+ - IEEE 802.3at Type 1 and 2
- Wi-Fi - IEEE 802.11a/b/g/n

FEATURES

- Combined indoor/outdoor rating
- UL 444/UL 1581 Sunlight Resistant Listed
- Meets ANSI/TIA-568-C.2 specification
- BrakeBox® payout control system
- Moisture-resistant package
- CableID® alpha numeric code printed every 2 feet
- QuickCount® marking system in feet and meters
- ColorTip® Circuit Identification System
- Rip cord applied under jacket
- RoHS-compliant

BENEFITS

- Reduces inventory by eliminating multiple cable types
- Increased life in direct, long term sunlight
- CAT 6 performance
- Adjustable tension control on reel prevents over spin and entangling of cable
- Resists damp conditions that might weaken standard packages
- Allows both ends of a cable run to be easily identifiable without the need to separately label or tone the cable
- Provides remaining length of cable on reel
- Easily identifiable conductor mates even in low-light environments
- Facilitates easy opening
- No heavy metals; and no toxic components



CAUTIONARY INFORMATION

- Do not use as a substitute for Outside Plant (OSP) cables.
- Do not use in conduit or direct burial which can flood. These cables are not designed for extended exposure to water.

ELECTRICAL SPECIFICATIONS

Frequency MHz	Insertion Loss @ 20°C Maximum dB/100 m		NEXT Minimum dB/100 m		ACR Minimum dB/100 m		PSNEXT Minimum dB/100 m	
	TIA-568-C.2	Superior Essex	TIA-568-C.2	Superior Essex	TIA-568-C.2	Superior Essex	TIA-568-C.2	Superior Essex
	Specified	Typical	Specified	Typical	Calculated	Typical	Specified	Typical
1	2.0	1.7	74.3	82.9	72.3	82.2	72.3	81.9
4	3.8	3.4	65.3	77.6	61.5	74.2	63.3	75.0
8	5.3	4.8	60.8	74.4	55.4	68.9	58.8	71.9
10	6.0	5.4	59.3	70.1	53.3	64.7	57.3	68.3
16	7.6	6.9	56.2	69.6	48.6	62.5	54.2	67.1
20	8.5	7.8	54.8	68.7	46.3	60.7	52.8	65.7
25	9.5	8.8	53.3	66.1	43.8	58.7	51.3	64.7
31.25	10.7	9.8	51.9	67.8	41.2	56.2	49.9	63.4
62.5	15.4	14.2	47.4	64.0	32.0	47.8	45.4	59.1
100	19.8	18.2	44.3	58.0	24.5	38.7	42.3	55.0
155	25.2	23.0	41.4	54.5	16.3	31.6	39.4	52.1
200	29.0	26.6	39.8	53.8	10.8	26.5	37.8	50.6
250	32.8	30.1	38.3	51.0	5.5	21.1	36.3	48.7
300		33.4		53.8		19.4		49.1
350		36.5		50.1		14.3		47.5
400		39.5		49.1		8.0		44.5
450		42.3		44.6		3.3		43.4
500		45.1		42.9				41.7
550		47.7		41.6				39.1

Frequency MHz	PSACR Minimum dB/100 m		Return Loss Minimum dB/100 m		ELFEXT Minimum dB/100 m		PSELFEXT Minimum dB/100 m	
	TIA-568-C.2	Superior Essex	TIA-568-C.2	Superior Essex	TIA-568-C.2	Superior Essex	TIA-568-C.2	Superior Essex
	Calculated	Typical	Specified	Typical	Specified	Typical	Specified	Typical
1	70.3	80.2	20.0	26.0	67.8	78.7	64.8	76.6
4	59.5	71.6	23.0	31.1	55.8	65.9	52.8	64.2
8	53.4	67.1	24.5	34.5	49.7	60.1	46.7	58.4
10	51.3	62.9	25.0	36.3	47.8	58.1	44.8	56.4
16	46.6	60.2	25.0	37.7	43.7	54.0	40.7	52.2
20	44.3	58.1	25.0	36.0	41.8	52.1	38.8	50.3
25	41.8	56.1	24.3	38.6	39.8	50.2	36.8	48.4
31.25	39.2	53.6	23.6	38.3	37.9	48.1	34.9	46.4
62.5	30.0	45.0	21.5	32.8	31.9	41.4	28.9	40.3
100	22.5	37.0	20.1	30.7	27.8	36.8	24.8	35.2
155	14.3	29.1	18.8	28.8	24.0	33.3	21.0	31.9
200	8.8	24.0	18.0	27.6	21.8	32.6	18.8	31.8
250	3.5	18.8	17.3	28.5	19.8	32.5	16.8	31.3
300		15.8		28.6		30.8		28.9
350		11.6		29.0		26.8		25.4
400		5.0		24.9		24.7		23.5
450		1.2		23.9		23.2		21.9
500				25.0		22.5		21.5
550				24.2		22.4		22.0

Category 6

CMR/CMX Outdoor

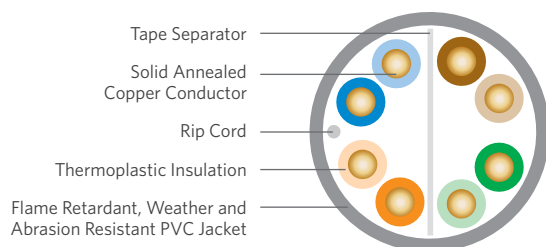

SPECIFICATIONS

Pair Count	4
Conductor	Solid annealed copper
AWG (mm)	23 (0.57)
Insulation	Polyolefin
Insulation Colors	Pair 1: ColorTip Light Blue, Blue Pair 2: ColorTip Light Orange, Orange Pair 3: ColorTip Light Green, Green Pair 4: ColorTip Light Brown, Brown
Ripcord	Non-wicking polyester yarn
Jacket	Tough, flame retardant, weather, UV and abrasion resistant riser PVC
Characteristic Impedance Ohms	100 ± 15
Nominal Velocity of Propagation %	70
Performance Compliance	UL 444 CSA C22.2 No. 214-08 UL 1581 UL 1666 ANSI/TIA-568-C.2 ANSI/TIA/EIA-570-B Article 800, NEC (NFPA 70) RoHS-compliant/RoHS 2-compliant
NRTL Programs	UL Verified CAT 6 UL, c(UL) Listed CMR UL, c(UL) Listed CMX Outdoor

ENVIRONMENTAL SPECIFICATIONS AND TESTS

Operation	-40°F to +167°F (-40°C to +75°C)
Installation	-40°F to +140°F (-40°C to +60°C)
ANSI/ICEA S-100-685-2009 Tested down to -67°F (-55°C)	Section 7.1: -4°F (-20°C) cold bend test Section 7.2: +14°F (-10°C) cold impact test Section 7.3: -40°F (-40°C) anvil test

PART NUMBERS AND PHYSICAL CHARACTERISTICS

Part Number ¹	Nominal Diameter in (mm)	Approx. Weight lbs/kft (kg/km)	Package	Packages per Pallet
77-246-x1	0.27 (6.9)	31 (46)	1,000' BrakeBox	12

JACKET COLORS

¹ Replace "x" with:	Beige = 1	Blue = 2	Gray = 3	White = 4
--------------------------------	-----------	----------	----------	-----------

UL is a registered trademark of UL LLC.

PRODUCT DESCRIPTION

The Superior Essex Category 6 CMR/CMX Outdoor cable is specifically designed for outdoor applications. UV-blocking compounds aid in protecting the cable from light. Applications include Ethernet interconnect cable for Wi-Fi or retrofit cable installations that employ exterior runs having long-term outdoor exposure between two environmentally protected points. CMX Outdoor cables are designed to extend the run between the Network Interface Unit and the point of entry into the interior of a residence or a premise.

Superior Essex CAT 6 CMR/CMX Outdoor premises cable has been tested and listed as UL® 444 Outdoor compliant. This designation requires the cable to resist 300 hours of UV and heat. In addition, the CMR listing allows the cable to be used in riser spaces per UL 1666, eliminating the need to transition to fire resistant cables.

APPLICATIONS

- 10BASE-T through 1000BASE-T Ethernet
- Power over Ethernet (PoE) - IEEE 802.3af
- PoE+ - IEEE 802.3at Type 1 and 2
- Wi-Fi - IEEE 802.11a/b/g/n

FEATURES

- Combined indoor/outdoor rating
- Meets ANSI/TIA-568-C.2 specification
- BrakeBox® payout control system
- Moisture-resistant package
- CableID® alpha numeric code printed every 2 feet
- QuickCount® marking system in feet and meters
- ColorTip® Circuit Identification System
- Rip cord applied under jacket
- RoHS-compliant

BENEFITS

- Reduces inventory by eliminating multiple cable types
- CAT 6 performance
- Adjustable tension control on reel prevents over spin and entangling of cable
- Resists damp conditions that might weaken standard packages
- Allows both ends of a cable run to be easily identifiable without the need to separately label or tone the cable
- Provides remaining length of cable on reel
- Easily identifiable conductor mates even in low-light environments
- Facilitates easy opening
- No heavy metals; and no toxic components



CAUTIONARY INFORMATION

- Do not use as a substitute for Outside Plant (OSP) cables.
- Do not use in conduit or direct burial which can flood. These cables are not designed for extended exposure to water.

ELECTRICAL SPECIFICATIONS

Frequency MHz	Insertion Loss @ 20°C Maximum dB/100 m		NEXT Minimum dB/100 m		ACR Minimum dB/100 m		PSNEXT Minimum dB/100 m	
	TIA-568-C.2	Superior Essex	TIA-568-C.2	Superior Essex	TIA-568-C.2	Superior Essex	TIA-568-C.2	Superior Essex
	Specified	Typical	Specified	Typical	Calculated	Typical	Specified	Typical
1	2.0	1.7	74.3	82.9	72.3	82.2	72.3	81.9
4	3.8	3.4	65.3	77.6	61.5	74.2	63.3	75.0
8	5.3	4.8	60.8	74.4	55.4	68.9	58.8	71.9
10	6.0	5.4	59.3	70.1	53.3	64.7	57.3	68.3
16	7.6	6.9	56.2	69.6	48.6	62.5	54.2	67.1
20	8.5	7.8	54.8	68.7	46.3	60.7	52.8	65.7
25	9.5	8.8	53.3	66.1	43.8	58.7	51.3	64.7
31.25	10.7	9.8	51.9	67.8	41.2	56.2	49.9	63.4
62.5	15.4	14.2	47.4	64.0	32.0	47.8	45.4	59.1
100	19.8	18.2	44.3	58.0	24.5	38.7	42.3	55.0
155	25.2	23.0	41.4	54.5	16.3	31.6	39.4	52.1
200	29.0	26.6	39.8	53.8	10.8	26.5	37.8	50.6
250	32.8	30.1	38.3	51.0	5.5	21.1	36.3	48.7
300		33.4		53.8		19.4		49.1
350		36.5		50.1		14.3		47.5
400		39.5		49.1		8.0		44.5
450		42.3		44.6		3.3		43.4
500		45.1		42.9				41.7
550		47.7		41.6				39.1

Frequency MHz	PSACR Minimum dB/100 m		Return Loss Minimum dB/100 m		ELFEXT Minimum dB/100 m		PSELFEXT Minimum dB/100 m	
	TIA-568-C.2	Superior Essex	TIA-568-C.2	Superior Essex	TIA-568-C.2	Superior Essex	TIA-568-C.2	Superior Essex
	Calculated	Typical	Specified	Typical	Specified	Typical	Specified	Typical
1	70.3	80.2	20.0	26.0	67.8	78.7	64.8	76.6
4	59.5	71.6	23.0	31.1	55.8	65.9	52.8	64.2
8	53.4	67.1	24.5	34.5	49.7	60.1	46.7	58.4
10	51.3	62.9	25.0	36.3	47.8	58.1	44.8	56.4
16	46.6	60.2	25.0	37.7	43.7	54.0	40.7	52.2
20	44.3	58.1	25.0	36.0	41.8	52.1	38.8	50.3
25	41.8	56.1	24.3	38.6	39.8	50.2	36.8	48.4
31.25	39.2	53.6	23.6	38.3	37.9	48.1	34.9	46.4
62.5	30.0	45.0	21.5	32.8	31.9	41.4	28.9	40.3
100	22.5	37.0	20.1	30.7	27.8	36.8	24.8	35.2
155	14.3	29.1	18.8	28.8	24.0	33.3	21.0	31.9
200	8.8	24.0	18.0	27.6	21.8	32.6	18.8	31.8
250	3.5	18.8	17.3	28.5	19.8	32.5	16.8	31.3
300		15.8		28.6		30.8		28.9
350		11.6		29.0		26.8		25.4
400		5.0		24.9		24.7		23.5
450		1.2		23.9		23.2		21.9
500				25.0		22.5		21.5
550				24.2		22.4		22.0

Cobra Category 5e+

CMR/CMP

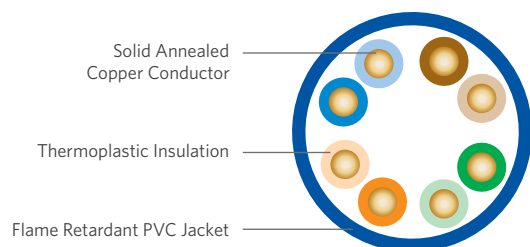

SPECIFICATIONS

Pair Count	4
Conductor	Solid annealed copper
AWG (mm)	24 (0.51)
Insulation	CMR: Polyolefin CMP: FEP
Insulation Colors	Pair 1: ColorTip Light Blue, Blue Pair 2: ColorTip Light Orange, Orange Pair 3: ColorTip Light Green, Green Pair 4: ColorTip Light Brown, Brown
Jacket	CMR: Flame retardant (FR) PVC CMP: FR, low smoke PVC
Characteristic Impedance Ohms	100 ± 15
Nominal Velocity of Propagation %	CMR: 70 CMP: 73
Performance Compliance	UL 444 CSA C22.2 No. 214-08 UL 1666 NFPA 262 ANSI/TIA-568-C.2 ANSI/ICEA S-90-661-2012 Article 800, NEC (NFPA 70)
NRTL Programs	UL Verified CAT 5e UL, c(UL) Listed CMR UL, c(UL) Listed CMP
Sustainability	UL Certified EPD HPD Multi-Attribute Certification USGBC® Member RoHS-compliant/RoHS 2-compliant REACH-compliant

PRODUCT DESCRIPTION



FIRST MANUFACTURER IN THE INDUSTRY
to offer products that contribute toward LEED!

Cobra Category 5e+ cable is the performance leader in its class. Cobra cable is ideal for installations that require true “future proofing” in channel performance. By design, Cobra cables are manufactured to the highest quality standards, design requirements and materials to ensure that every box provides significant margin over ANSI/TIA-568-C.2 specifications for NEXT, Power Sum NEXT and Insertion Loss.

APPLICATIONS

- 10BASE-T through 100BASE-T Ethernet
- Power over Ethernet (PoE) - IEEE 802.3af
- PoE+ - IEEE 802.3at Type 1 and 2
- ATM and token ring

FEATURES

- UL Certified Environmental Product Declaration (EPD)
- Health Product Declaration™ (HPD™)
- Multi-Attribute Certification by GreenCircle Certified, LLC
- Guaranteed NEXT of 3 dB greater than ANSI/TIA-568-C.2 specification across frequency range
- Guaranteed ACR of 19.5 dB at 100 MHz
- Exceptional PSNEXT, PSELFEXT and PSACR over CAT 5e
- “WideMouth” POP™ Box design
- CableID® alpha numeric code printed every 2 feet
- QuickCount® marking system in feet and meters
- ColorTip® circuit identification system
- Color coded box labels

BENEFITS

- Contributes toward 1 LEED point under the Material and Resources credit (MRC)
- Contributes toward 1 LEED point under the MRC
- Offers an overview of the sustainability of a product, its packaging and manufacturing
- Greater assurance of exceptional overall channel performance
- Performance assurance for multiple high-bandwidth applications
- Reduces BER, improving network efficiency
- Reduces tension on wire to ensure proper electrical performance after installation
- Allows both ends of a cable run to be easily identifiable without the need to separately label or tone the cable
- Provides remaining length of cable on reel
- Easily identifiable conductor mates even in low-light environments
- Easily identifies jacket colors

PART NUMBERS AND PHYSICAL CHARACTERISTICS

Listing	Part Number ¹	Nominal Diameter in (mm)	Approx. Weight lbs./kft (kg/km)	Package	Packages per Pallet
CMR	52-200-x5	0.19 (4.8)	19 (28)	1,000' Reel-in-a-Box	45
CMR	52-240-x5	0.19 (4.8)	19 (28)	1,000' POP box	36
CMP	52-200-x8	0.19 (4.8)	19 (28)	1,000' Reel-in-a-Box	45
CMP	52-241-x8	0.19 (4.8)	19 (28)	1,000' POP box	36

JACKET COLORS

¹Replace “x” with: Blue = 2 Gray = 3 White = 4 Green = 5 Yellow = 6 Purple = 7 Red = 9 Brown = B Orange = D Black = E

ELECTRICAL SPECIFICATIONS

Frequency MHz	Insertion Loss @ 20°C Maximum dB/100 m			NEXT Minimum dB/100 m			ACR Minimum dB/100 m			PSNEXT Minimum dB/100 m		
	TIA-568-C.2	Superior Essex		TIA-568-C.2	Superior Essex		TIA-568-C.2	Superior Essex		TIA-568-C.2	Superior Essex	
	Specified	Guaranteed	Typical	Specified	Guaranteed	Typical	Calculated	Guaranteed	Typical	Specified	Guaranteed	Typical
1	2.0	2.0	1.8	65.3	68.3	79.5	63.3	67.4	77.7	62.3	66.3	77.2
4	4.1	4.0	3.6	56.3	59.3	69.9	52.2	56.4	66.4	53.3	57.3	67.5
8	5.8	5.7	5.1	51.8	54.8	65.1	46.0	50.3	60.0	48.8	52.8	62.7
10	6.5	6.4	5.8	50.3	53.3	63.6	43.8	48.2	57.9	47.3	51.3	61.2
16	8.2	8.1	7.4	47.2	50.3	60.4	39.0	43.4	53.1	44.2	48.3	58.0
20	9.3	9.2	8.3	45.8	48.8	59.0	36.5	41.0	50.9	42.8	46.8	56.6
25	10.4	10.3	9.3	44.3	47.3	57.5	33.9	38.5	48.3	41.3	45.3	55.1
31.25	11.7	11.6	10.4	42.9	45.9	56.0	31.2	35.8	45.7	39.9	43.9	53.5
62.5	17.0	16.8	14.9	38.4	41.4	51.7	21.4	26.2	36.8	35.4	39.4	49.2
100	22.0	21.7	19.1	35.3	38.3	48.5	13.3	21.0	29.5	32.3	36.3	46.0
155		27.7	24.2		35.5	45.7		9.3	21.6		33.5	43.1
200		32.1	27.8		29.8	43.6		3.5	16.0		27.8	41.0
250		36.5	31.4		28.3	42.0			10.7		26.3	39.4
300		40.5	34.7		27.2	40.4			5.9		25.2	37.9
350		44.4	37.7		26.2	39.3			1.7		24.2	36.8

Frequency MHz	PSACR Minimum dB/100 m			Return Loss Minimum dB/100 m			ELFEXT Minimum dB/100 m			PSELFEXT Minimum dB/100 m		
	TIA-568-C.2	Superior Essex		TIA-568-C.2	Superior Essex		TIA-568-C.2	Superior Essex		TIA-568-C.2	Superior Essex	
	Calculated	Guaranteed	Typical	Specified	Guaranteed	Typical	Specified	Guaranteed	Typical	Specified	Guaranteed	Typical
1	60.3	64.4	75.4	20.0	20.0	28.5	63.8	63.8	72.6	60.8	60.8	70.8
4	49.2	53.4	64.0	23.0	23.0	35.6	51.8	51.7	60.7	48.8	48.8	59.0
8	43.0	47.3	57.7	24.5	24.5	35.7	45.7	45.7	54.8	42.7	42.7	53.1
10	40.8	45.2	55.6	25.0	25.0	35.9	43.8	43.8	52.9	40.8	40.8	51.1
16	36.0	40.4	50.8	25.0	25.0	35.2	39.7	39.7	48.9	36.7	36.7	47.1
20	33.5	38.0	48.6	25.0	25.0	34.9	37.8	37.7	47.0	34.8	34.8	45.2
25	30.9	35.5	46.0	24.3	24.3	35.3	35.8	35.8	45.1	32.8	32.8	43.3
31.25	28.2	32.8	43.4	23.6	23.6	34.8	33.9	33.9	43.2	30.9	30.9	41.3
62.5	18.4	23.2	34.6	21.5	21.5	31.8	27.9	27.8	37.2	24.9	24.9	35.2
100	10.3	18.0	27.3	20.1	20.1	30.1	23.8	23.8	33.2	20.8	20.8	31.1
155		6.3	19.4		18.8	28.4		19.9	29.3		16.9	27.2
200		0.5	13.9		18.0	27.3		11.7	27.1		10.7	25.0
250			8.6		17.3	26.1		9.8	25.1		8.8	23.1
300			3.8		16.8	25.1		8.2	23.7		7.2	21.5
350					16.3	24.0		6.9	22.5		5.9	20.3

SUSTAINABILITY LEADERSHIP



UL and the related logo are registered trademarks of UL LLC. Health Product Declaration, HPD and the related logo are trademarks of Health Product Declaration Collaborative. GreenCircle Certified logo is a registered trademark of GreenCircle Certified, LLC. USGBC and the related logo are registered trademarks of U.S. Green Building Council.

Category 5e+ F/UTP (ScTP)

CMR/CMP

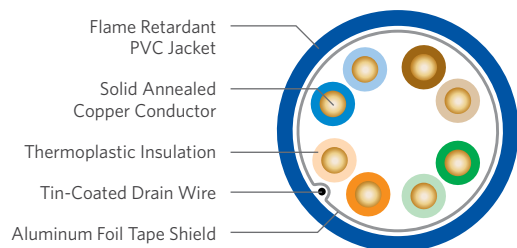

Flame Retardant PVC Jacket
Solid Annealed Copper Conductor
Thermoplastic Insulation
Tin-Coated Drain Wire
Aluminum Foil Tape Shield

SPECIFICATIONS

Pair Count	4
Conductor	Solid annealed copper
AWG (mm)	24 (0.51)
Insulation	CMR: Polyolefin CMP: FEP
Insulation Colors	Pair 1: ColorTip Light Blue, Blue Pair 2: ColorTip Light Orange, Orange Pair 3: ColorTip Light Green, Green Pair 4: ColorTip Light Brown, Brown
Shield	Aluminum foil tape
Drain Wire	24 AWG tinned copper
Jacket	CMR: Flame retardant (FR) PVC CMP: FR, low smoke PVC
Characteristic Impedance Ohms	100 ± 15
Nominal Velocity of Propagation %	CMR: 67 CMP: 70
Performance Compliance	UL 444 CSA C22.2 No. 214-08 UL 1666 NFPA 262 ANSI/TIA-568-C.2 ANSI/ICEA S-90-661-2012 Article 800, NEC (NFPA 70)
NRTL Programs	UL Verified CAT 5e UL, c(UL) Listed CMR UL, c(UL) Listed CMP
Sustainability	UL Certified EPD HPD Multi-Attribute Certification USGBC® Member RoHS-compliant/RoHS 2-compliant REACH-compliant

PRODUCT DESCRIPTION



FIRST MANUFACTURER IN THE INDUSTRY
to offer products that contribute toward LEED!

Superior Essex offers Screen Twisted Pair (ScTP) shielded Category 5e+ cables in both plenum and riser versions. The cable has guaranteed performance out to 350 MHz and meets all applicable ANSI/TIA-568-C.2 requirements. The cable consists of four balanced 24 AWG copper pairs. The core is wrapped with an aluminum foil tape and has a tin coated drain wire. The tape wrapped core is jacketed with the appropriate flexible PVC jacket for plenum or riser applications.

APPLICATIONS

- 10BASE-T through 1000BASE-T Ethernet
- Power over Ethernet (PoE) - IEEE 802.3af
- PoE+ - IEEE 802.3at Type 1 and 2
- ATM and token ring
- Applications requiring secure networks or protection from EMI/RFI

FEATURES

- UL Certified Environmental Product Declaration (EPD)
- Health Product Declaration™ (HPD™)
- Multi-Attribute Certification by GreenCircle Certified, LLC
- Aluminum foil tape covers all 4-pair
- Exceeds ANSI/TIA-568-C.2 for CAT 5e cable performance
- Guaranteed performance to 350 MHz
- CableID® alpha numeric code printed every 2 feet
- QuickCount® marking system in feet and meters
- ColorTip® circuit identification system
- Color coded box labels

BENEFITS

- Contributes toward 1 LEED point under the Material and Resources credit (MRC)
- Contributes toward 1 LEED point under the MRC
- Offers an overview of the sustainability of a product, its packaging and manufacturing
- Protects against EMI/RFI and provides greater security
- Assures compliance for all current networking applications (up to 1000BASE-T)
- Assures ample bandwidth headroom
- Allows both ends of a cable run to be easily identifiable without the need to separately label or tone the cable
- Provides remaining length of cable on reel
- Easily identifiable conductor mates even in low-light environments
- Easily identifies jacket colors

PART NUMBERS AND PHYSICAL CHARACTERISTICS

Listing	Part Number ¹	Nominal Diameter in (mm)	Approx. Weight lbs./kft (kg/km)	Package	Packages per Pallet
CMR	5F-220-x5	0.26 (6.6)	31 (46)	1,000' Plywood reel	12
CMP	5F-220-x8	0.25 (6.4)	30 (45)	1,000' Plywood reel	12

JACKET COLORS

¹Replace "x" with:

Blue = 2

Gray = 3

White = 4

Green = 5

Yellow = 6

Red = 9

Orange = D

Black = E

ELECTRICAL SPECIFICATIONS

Frequency MHz	Insertion Loss @ 20°C Maximum dB/100 m			NEXT Minimum dB/100 m			ACR Minimum dB/100 m			PSNEXT Minimum dB/100 m		
	TIA-568-C.2	Superior Essex		TIA-568-C.2	Superior Essex		TIA-568-C.2	Superior Essex		TIA-568-C.2	Superior Essex	
	Specified	Guaranteed	Typical	Specified	Guaranteed	Typical	Calculated	Guaranteed	Typical	Specified	Guaranteed	Typical
1	2.0	2.0	1.8	65.3	68.3	79.5	63.3	67.4	77.7	62.3	66.3	77.2
4	4.1	4.0	3.6	56.3	59.3	69.9	52.2	56.4	66.4	53.3	57.3	67.5
8	5.8	5.7	5.1	51.8	54.8	65.1	46.0	50.3	60.0	48.8	52.8	62.7
10	6.5	6.4	5.8	50.3	53.3	63.6	43.8	48.2	57.9	47.3	51.3	61.2
16	8.2	8.1	7.4	47.2	50.3	60.4	39.0	43.4	53.1	44.2	48.3	58.0
20	9.3	9.2	8.3	45.8	48.8	59.0	36.5	41.0	50.9	42.8	46.8	56.6
25	10.4	10.3	9.3	44.3	47.3	57.5	33.9	38.5	48.3	41.3	45.3	55.1
31.25	11.7	11.6	10.4	42.9	45.9	56.0	31.2	35.8	45.7	39.9	43.9	53.5
62.5	17.0	16.8	14.9	38.4	41.4	51.7	21.4	26.2	36.8	35.4	39.4	49.2
100	22.0	21.7	19.1	35.3	38.3	48.5	13.3	21.0	29.5	32.3	36.3	46.0
155		27.7	24.2		35.5	45.7		9.3	21.6		33.5	43.1
200		32.1	27.8		29.8	43.6		3.5	16.0		27.8	41.0
250		36.5	31.4		28.3	42.0			10.7		26.3	39.4
300		40.5	34.7		27.2	40.4			5.9		25.2	37.9
350		44.4	37.7		26.2	39.3			1.7		24.2	36.8

Frequency MHz	PSACR Minimum dB/100 m			Return Loss Minimum dB/100 m			ELFEXT Minimum dB/100 m			PSELFEXT Minimum dB/100 m		
	TIA-568-C.2	Superior Essex		TIA-568-C.2	Superior Essex		TIA-568-C.2	Superior Essex		TIA-568-C.2	Superior Essex	
	Calculated	Guaranteed	Typical	Specified	Guaranteed	Typical	Specified	Guaranteed	Typical	Specified	Guaranteed	Typical
1	60.3	64.4	75.4	20.0	20.0	28.5	63.8	63.8	72.6	60.8	60.8	70.8
4	49.2	53.4	64.0	23.0	23.0	35.6	51.8	51.7	60.7	48.8	48.8	59.0
8	43.0	47.3	57.7	24.5	24.5	35.7	45.7	45.7	54.8	42.7	42.7	53.1
10	40.8	45.2	55.6	25.0	25.0	35.9	43.8	43.8	52.9	40.8	40.8	51.1
16	36.0	40.4	50.8	25.0	25.0	35.2	39.7	39.7	48.9	36.7	36.7	47.1
20	33.5	38.0	48.6	25.0	25.0	34.9	37.8	37.7	47.0	34.8	34.8	45.2
25	30.9	35.5	46.0	24.3	24.3	35.3	35.8	35.8	45.1	32.8	32.8	43.3
31.25	28.2	32.8	43.4	23.6	23.6	34.8	33.9	33.9	43.2	30.9	30.9	41.3
62.5	18.4	23.2	34.6	21.5	21.5	31.8	27.9	27.8	37.2	24.9	24.9	35.2
100	10.3	18.0	27.3	20.1	20.1	30.1	23.8	23.8	33.2	20.8	20.8	31.1
155		6.3	19.4		18.8	28.4		19.9	29.3		16.9	27.2
200		0.5	13.9		18.0	27.3		11.7	27.1		10.7	25.0
250			8.6		17.3	26.1		9.8	25.1		8.8	23.1
300			3.8		16.8	25.1		8.2	23.7		7.2	21.5
350					16.3	24.0		6.9	22.5		5.9	20.3

SUSTAINABILITY LEADERSHIP



UL and the related logo are registered trademarks of UL LLC. Health Product Declaration, HPD and the related logo are trademarks of Health Product Declaration Collaborative. GreenCircle Certified logo is a registered trademark of GreenCircle Certified, LLC. USGBC and the related logo are registered trademarks of U.S. Green Building Council.

PowerWise™ Category 5e+

CMR/CMP

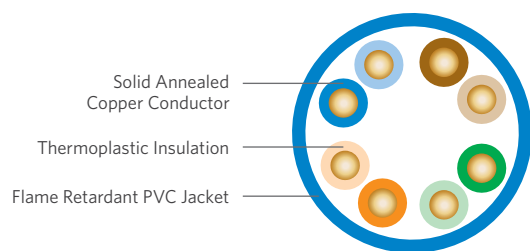

PRODUCT DESCRIPTION

PowerWise™ Category 5e+ cables provide the best performance and overall value for 4-Pair Power over Ethernet (4PPoE) applications requiring up to 100W of power and up to 1 Gigabit Ethernet performance. PowerWise CAT 5e+ cables are specifically designed to mitigate temperature build-up, offer exceptional energy efficiency and ensure performance (up to 1 Gigabit Ethernet) over the lifetime of your system.

PowerWise CAT 5e+ cable provides the performance benefits of a typical CAT 5E cable including a small diameter. Cable temperature increases are reduced and power efficiency is increased as a result of 22 gauge conductors. Plenum rated conductors are also 100% FEP insulated and ensure cable performance over the life of your system. PowerWise CAT 5e+ cables are the best solution to connect and power your 4PPoE applications compared to standard CAT 5e and 6 designs.

APPLICATIONS

- 10BASE-T through 1000BASE-T Ethernet
- Power over Ethernet (PoE) - IEEE 802.3af
- PoE+ - IEEE 802.3at Type 1 and 2
- 4PPoE - IEEE 802.3bt Type 3 and 4 draft D1.2
- ATM and token ring

FEATURES

- Guaranteed 0.3 dB headroom for IL, ACR and PSACR
- Tested 350 MHz
- Tested in most severe temperature conditions in bundle of 100 cables
- BrakeBox® payout control system
- CableID® alpha numeric code printed every 2 feet
- QuickCount marking system in feet and meters
- ColorTip® circuit identification system
- Color coded box labels

BENEFITS

- Performance assurance for exceptional overall channel performance
- Assures ample bandwidth Headroom
- AWG 22 insulated wire offers 88% power efficiency and lowest temperature increase inside a bundle, the best of its class
- Adjustable tension control on reel prevents over spin and entangling of cable
- Allows both ends of a cable run to be easily identifiable without the need to separately label or tone the cable
- Provides remaining length of cable on reel
- Easily identifiable conductor mates even in low-light environments
- Easily identifies jacket colors

SPECIFICATIONS

Pair Count	4
Conductor	Solid annealed copper
AWG (mm)	22 (0.51)
Insulation	Thermoplastic
Insulation Colors	Pair 1: ColorTip Light Blue, Blue Pair 2: ColorTip Light Orange, Orange Pair 3: ColorTip Light Green, Green Pair 4: ColorTip Light Brown, Brown
Jacket	CMR: Flame retardant (FR) PVC CMP: FR, low smoke PVC
Characteristic Impedance Ohms	100 ± 15
Nominal Velocity of Propagation %	CMR: 71 CMP: 74
Performance Compliance	UL 444 CSA C22.2 No. 214-08 UL 1666 NFPA 262 ANSI/TIA-568-C.2 ANSI/ICEA S-90-661-2012 Article 800, NEC (NFPA 70)
NRTL Programs	UL Verified CAT 5e UL, c(UL) Listed CMR UL, c(UL) Listed CMP

PART NUMBERS AND PHYSICAL CHARACTERISTICS

Listing	Part Number ¹	Nominal Diameter in (mm)	Approx. Weight lbs/kft (kg/km)	Package	Packages per Pallet
CMR	PW52-H46-y5	0.23 (4.6)	28 (25)	1,000 ft BrakeBox	12
CMR	PW52-H72-y5	0.23 (4.6)	28 (25)	1,000 ft Plywood Reel	16
CMP	PW52-H46-y8	0.23 (4.8)	37 (28)	1,000 ft BrakeBox	12
CMP	PW52-H72-y8	0.23 (4.8)	37 (28)	1,000 ft Plywood Reel	16

JACKET COLORS

¹Replace "y" with:

Blue = 2

Gray = 3

White = 4

Green = 5

Yellow = 6

Red = 9

ELECTRICAL SPECIFICATIONS

Frequency MHz	Insertion Loss @ 20°C Maximum dB/100 m			NEXT Minimum dB/100 m		ACR Minimum dB/100 m			PSNEXT Minimum dB/100 m	
	TIA-568-C.2	Superior Essex		TIA-568-C.2	Superior Essex	TIA-568-C.2	Superior Essex		TIA-568-C.2	Superior Essex
	Specified	Guaranteed	Typical	Specified	Typical	Calculated	Guaranteed	Typical	Specified	Typical
1	2	1.7	1.7	65.3	76.8	63.3	63.6	81.0	62.3	75.3
4	4.1	3.8	3.7	56.3	67.8	52.2	52.5	70.1	53.3	66.3
8	5.8	5.5	5.4	51.8	63.3	46.0	46.3	63.9	48.8	61.8
10	6.5	6.2	6.0	50.3	61.8	43.8	44.1	61.8	47.3	60.3
16	8.2	7.9	7.7	47.2	58.7	39.0	39.3	57.0	44.3	57.2
20	9.3	9.0	8.6	45.8	57.3	36.5	36.8	54.7	42.8	55.8
25	10.4	10.1	9.6	44.3	55.8	33.9	34.2	52.2	41.3	54.3
31.25	11.7	11.4	10.8	42.9	54.4	31.2	31.5	49.6	39.9	52.9
62.5	17	16.7	15.5	38.4	49.9	21.4	21.7	40.4	35.4	48.4
100	22	21.7	19.8	35.3	46.8	13.3	13.6	33.0	32.3	45.3
155			24.8		43.9			25.1		42.4
200			28.2		42.3			20.1		40.8
250			31.8		40.8			15.0		39.3
300			35		39.6			10.6		38.1
350			38.3		38.6			6.3		37.1

Frequency MHz	PSACR Minimum dB/100 m			Return Loss Minimum dB/100 m		ELFEXT Minimum dB/100 m		PSELFEXT Minimum dB/100 m	
	TIA-568-C.2	Superior Essex		TIA-568-C.2	Superior Essex	TIA-568-C.2	Superior Essex	TIA-568-C.2	Superior Essex
	Calculated	Guaranteed	Typical	Specified	Typical	Specified	Typical	Specified	Typical
1	60.3	60.6	78.3	20.0	33.0	63.8	74.6	60.8	69.3
4	49.2	49.5	67.4	23.0	36.0	51.8	62.6	48.8	57.3
8	43.0	43.3	61.2	24.5	37.5	45.7	56.5	42.7	51.2
10	40.8	41.1	59.1	25.0	38.0	43.8	54.6	40.8	49.3
16	36.1	36.4	54.3	25.0	38.0	39.7	50.5	36.7	45.2
20	33.5	33.8	52.0	25.0	38.0	37.8	48.6	34.8	43.3
25	30.9	31.2	49.5	24.3	37.3	35.8	46.6	32.8	41.3
31.25	28.2	28.5	46.9	23.6	36.6	33.9	44.7	30.9	39.4
62.5	18.4	18.7	37.7	21.5	34.5	27.9	38.7	24.9	33.4
100	10.3	10.6	30.3	20.1	33.1	23.8	34.6	20.8	29.3
155			22.4		31.8		30.8		25.5
200			17.4		31.0		28.6		23.3
250			12.3		30.3		26.6		21.3
300			7.9		29.8		25.1		19.8
350			3.6		29.3		23.7		18.4

Marathon LAN® Category 5e

CMR/CMP

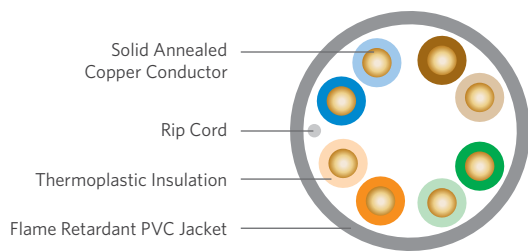

SPECIFICATIONS

Pair Count	4
Conductor	Solid annealed copper
AWG (mm)	24 (0.51)
Insulation	Thermoplastic
Insulation Colors	Pair 1: ColorTip Light Blue, Blue Pair 2: ColorTip Light Orange, Orange Pair 3: ColorTip Light Green, Green Pair 4: ColorTip Light Brown, Brown
Jacket	CMR: Flame retardant (FR) PVC CMP: FR, low smoke PVC
Characteristic Impedance Ohms	100 ± 15
Nominal Velocity of Propagation %	CMR: 71 CMP: 74
Performance Compliance	UL 444 CSA C22.2 No. 214-08 UL 1666 NFPA 262 ANSI/TIA-568-C.2 ANSI/ICEA S-90-661-2012 Article 800, NEC (NFPA 70)
NRTL Programs	UL or ETL Verified CAT 5e UL, c(UL) Listed CMR UL, c(UL) Listed CMP
Sustainability	UL Certified EPD HPD Multi-Attribute Certification USGBC® Member RoHS-compliant/RoHS 2-compliant REACH-compliant

PRODUCT DESCRIPTION



FIRST MANUFACTURER IN THE INDUSTRY
to offer products that contribute toward LEED!

Marathon LAN® Category 5e cable offers an exceptional value for jobs that require standards compliance at a cost-effective price. While Marathon LAN cable meets all of the ANSI/TIA-568-C.2 specifications, it also offers other features that make it easier to use, save on installation time and expense and ensure product quality during the installation. From the QuickCount® feature, which marks the exact cable remaining in the box, to the WideMouth payout design, which reduces tension on the wire as it is pulled during installation, Marathon LAN cable provides more overall value than any other CAT 5e product available today.

APPLICATIONS

- 10BASE-T through 100BASE-T Ethernet
- Power over Ethernet (PoE) – IEEE 802.3af
- PoE+ – IEEE 802.3at Type 1 and 2
- ATM and token ring

FEATURES

- UL Certified Environmental Product Declaration (EPD)
- Health Product Declaration™ (HPD™)
- Multi-Attribute Certification by GreenCircle Certified, LLC
- Meets ANSI/TIA-568-C.2 specification
- Tested to 350 MHz
- “WideMouth” POP™ box design
- CableID® alpha numeric code printed every 2 feet
- QuickCount marking system in feet and meters
- ColorTip® circuit identification system
- Color coded box labels

BENEFITS

- Contributes toward 1 LEED point under the Material and Resources credit (MRC)
- Contributes toward 1 LEED point under the MRC
- Offers an overview of the sustainability of a product, its packaging and manufacturing
- Provides cost-effective solution
- Assures ample bandwidth headroom
- Reduces tension on wire to ensure proper electrical performance after installation
- Allows both ends of a cable run to be easily identifiable without the need to separately label or tone the cable
- Provides remaining length of cable on reel
- Easily identifiable conductor mates even in low-light environments
- Easily identifies jacket colors

PART NUMBERS AND PHYSICAL CHARACTERISTICS

Listing	Part Number ¹	Nominal Diameter in (mm)	Approx. Weight lbs/kft (kg/km)	Package
CMR	51-xxx-y5	0.18 (4.6)	17 (25)	use key
CMP	51-xxx-y8	0.19 (4.8)	19 (28)	use key

PACKAGING

	150 ft Coil	200 ft Coil	250 ft Coil	300 ft Coil	1,000 ft POP Box	1,000 ft Reel-in-a-box	1,000 ft Plywood Reel	2,500 ft Plywood Reel
¹ Replace “xxx” with:	225	229	230	231	CMR: 240 CMP: 241	243	220	273
Packages per Pallet	240	120	144	120	45	45	36	16

JACKET COLORS

¹Replace “y” with: Blue = 2 Gray = 3 White = 4 Green = 5 Yellow = 6 Purple = 7 Red = 9 Pink = C Orange = D Black = E

ELECTRICAL SPECIFICATIONS

Frequency MHz	Insertion Loss @ 20°C Maximum dB/100 m		NEXT Minimum dB/100 m		ACR Minimum dB/100 m		PSNEXT Minimum dB/100 m	
	TIA-568-C.2	Superior Essex	TIA-568-C.2	Superior Essex	TIA-568-C.2	Superior Essex	TIA-568-C.2	Superior Essex
	Specified	Typical	Specified	Typical	Calculated	Typical	Specified	Typical
1	2.0	1.8	65.3	76.8	63.3	81.0	62.3	75.3
4	4.1	3.7	56.3	67.8	52.2	70.1	53.3	66.3
8	5.8	5.4	51.8	63.3	46.0	63.9	48.8	61.8
10	6.5	6.0	50.3	61.8	43.8	61.8	47.3	60.3
16	8.2	7.7	47.2	58.7	39.0	57.0	44.3	57.2
20	9.3	8.6	45.8	57.3	36.5	54.7	42.8	55.8
25	10.4	9.6	44.3	55.8	33.9	52.2	41.3	54.3
31.25	11.7	10.8	42.9	54.4	31.2	49.6	39.9	52.9
62.5	17.0	15.5	38.4	49.9	21.4	40.4	35.4	48.4
100	22.0	19.8	35.3	46.8	13.3	33.0	32.3	45.3
155		24.8		43.9		25.1		42.4
200		28.2		42.3		20.1		40.8
250		31.8		40.8		15.0		39.3
300		35.0		39.6		10.6		38.1
350		38.3		38.6		6.3		37.1

Frequency MHz	PSACR Minimum dB/100 m		Return Loss Minimum dB/100 m		ELFEXT Minimum dB/100 m		PSELFEXT Minimum dB/100 m	
	TIA-568-C.2	Superior Essex	TIA-568-C.2	Superior Essex	TIA-568-C.2	Superior Essex	TIA-568-C.2	Superior Essex
	Calculated	Typical	Specified	Typical	Specified	Typical	Specified	Typical
1	60.3	78.3	20.0	33.0	63.8	74.6	60.8	69.3
4	49.2	67.4	23.0	36.0	51.8	62.6	48.8	57.3
8	43.0	61.2	24.5	37.5	45.7	56.5	42.7	51.2
10	40.8	59.1	25.0	38.0	43.8	54.6	40.8	49.3
16	36.1	54.3	25.0	38.0	39.7	50.5	36.7	45.2
20	33.5	52.0	25.0	38.0	37.8	48.6	34.8	43.3
25	30.9	49.5	24.3	37.3	35.8	46.6	32.8	41.3
31.25	28.2	46.9	23.6	36.6	33.9	44.7	30.9	39.4
62.5	18.4	37.7	21.5	34.5	27.9	38.7	24.9	33.4
100	10.3	30.3	20.1	33.1	23.8	34.6	20.8	29.3
155		22.4		31.8		30.8		25.5
200		17.4		31.0		28.6		23.3
250		12.3		30.3		26.6		21.3
300		7.9		29.8		25.1		19.8
350		3.6		29.3		23.7		18.4

SUSTAINABILITY LEADERSHIP



UL and the related logo are registered trademarks of UL LLC. Health Product Declaration, HPD and the related logo are trademarks of Health Product Declaration Collaborative. GreenCircle Certified logo is a registered trademark of GreenCircle Certified, LLC. USGBC and the related logo are registered trademarks of U.S. Green Building Council.

Category 5e LSZH

CM

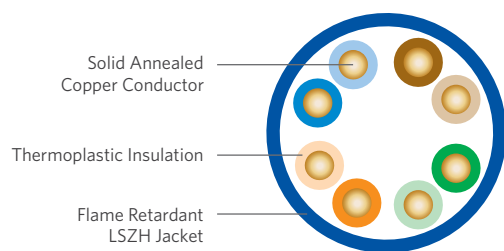

SPECIFICATIONS

Pair Count	4
Conductor	Solid annealed copper
AWG (mm)	24 (0.51)
Insulation	Polyolefin
Insulation Colors	Pair 1: ColorTip Light Blue, Blue Pair 2: ColorTip Light Orange, Orange Pair 3: ColorTip Light Green, Green Pair 4: ColorTip Light Brown, Brown
Jacket	Flame retardant LSZH
Characteristic Impedance Ohms	100 ± 15
Nominal Velocity of Propagation %	67
Performance Compliance	UL 444 CSA C22.2 No. 214-08 UL 1685 IEC 61156-5 IEC 60332-1 IEC 60134 IEC 60754 ANSI/TIA-568-C.2 ANSI/ICEA S-90-661-2012 ANSI/TIA/EIA-570-B Article 800, NEC (NFPA 70) RoHS-compliant/RoHS 2-compliant
NRTL Programs	UL, c(UL) Listed CM

PART NUMBERS AND PHYSICAL CHARACTERISTICS

Listing	Part Number ¹	Nominal Diameter in (mm)	Approx. Weight lbs/kft (kg/km)	Package	Packages per Pallet
CM	51-240-xL	0.19 (4.8)	20 (29)	1,000' POP™ box	36

JACKET COLORS

¹Replace "x" with: Blue = 2 White = 4

UL is a registered trademark of UL LLC.

PRODUCT DESCRIPTION

Superior Essex Category 5e LSZH CM cable is designed for applications requiring a Low Smoke Zero Halogen (LSZH) construction. CAT 5e compliance ensures this cable will support 1000BASE-T Gigabit Ethernet. This cable easily surpasses the Grade 2 requirements specified in the ANSI/TIA/EIA-570-B Residential Telecommunications standard.

APPLICATIONS

- 10BASE-T through 1000BASE-T Ethernet
- Power over Ethernet (PoE) – IEEE 802.3af
- PoE+ – IEEE 802.3at Type 1 and 2
- ATM and token ring

FEATURES

- Low Smoke Zero Halogen
- UL® Listed CM
- Meets ANSI/TIA-568-C.2 specification
- QuickCount® marking system in feet and meters
- ColorTip® Circuit Identification System

BENEFITS

- Meets IEC requirements for toxicity, acidity and smoke
- UL listing allows for CM specific installations
- CAT 5e compliance
- Provides remaining length of cable on reel
- Easily identifiable conductor mates even in low light environments

PRODUCT DESCRIPTION

Superior Essex Category 5e CM cable is designed for residential LAN applications. CAT 5e compliance ensures this cable will support 1000BASE-T Gigabit Ethernet. This cable easily surpasses the Grade 2 requirements specified in the ANSI/TIA/EIA-570-B Residential Telecommunications standard.

APPLICATIONS

- 10BASE-T through 1000BASE-T Ethernet
- Power over Ethernet (PoE) - IEEE 802.3af
- PoE+ - IEEE 802.3at Type 1 and 2
- ATM and token ring

FEATURES

- Meets ANSI/TIA-568-C.2 specification
- CableID® alpha numeric code printed every 2 feet
- QuickCount® marking system in feet and meters
- ColorTip® Circuit Identification System

BENEFITS

- CAT 5e compliance
- Allows both ends of a cable run to be easily identifiable without the need to separately label or tone the cable
- Provides remaining length of cable on reel
- Easily identifiable conductor mates even in low light environments

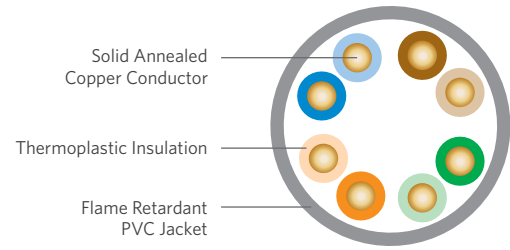

SPECIFICATIONS

Pair Count	4
Conductor	Solid annealed copper
AWG (mm)	24 (0.51)
Insulation	Polyolefin
Insulation Colors	Pair 1: ColorTip Light Blue, Blue Pair 2: ColorTip Light Orange, Orange Pair 3: ColorTip Light Green, Green Pair 4: ColorTip Light Brown, Brown
Jacket	Flame retardant PVC
Characteristic Impedance Ohms	100 ± 15
Nominal Velocity of Propagation %	72
Performance Compliance	UL® 444 CSA C22.2 No. 214-08 UL 1685 ANSI/TIA-568-C.2 ANSI/ICEA S-90-661-2012 ANSI/TIA/EIA-570-B Article 800, NEC (NFPA 70) RoHS-compliant/RoHS 2-compliant
NRTL Programs	UL Verified CAT 5e UL, c(UL) Listed CM

PART NUMBERS AND PHYSICAL CHARACTERISTICS

Listing	Part Number ¹	Nominal Diameter in (mm)	Approx. Weight lbs/kft (kg/km)	Package	Packages per Pallet
CM	51-240-xG	0.18 (4.6)	17 (25)	1,000' POP™ box	45

JACKET COLORS

¹ Replace "x" with:	Blue = 2	Gray = 3	White = 4	Green = 5	Red = 9
--------------------------------	----------	----------	-----------	-----------	---------

UL is a registered trademark of UL LLC.

Category 5e

CMR/CMX Outdoor Sunlight Resistant

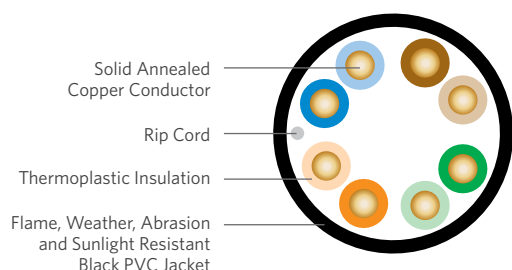

SPECIFICATIONS

Pair Count	4
Conductor	Solid annealed copper
AWG (mm)	24 (0.51)
Insulation	Polyolefin
Insulation Colors	Pair 1: ColorTip Light Blue, Blue Pair 2: ColorTip Light Orange, Orange Pair 3: ColorTip Light Green, Green Pair 4: ColorTip Light Brown, Brown
Ripcord	Non-wicking polyester yarn
Jacket	Tough, flame retardant, weather, sunlight and abrasion resistant riser PVC
Jacket Color	Black
Characteristic Impedance Ohms	100 ± 15
Nominal Velocity of Propagation %	70
Performance Compliance	UL 444 CSA C22.2 No. 214-08 UL 1581 UL 1666 ANSI/TIA-568-C.2 ANSI/ICEA S-90-661-2012 ANSI/TIA/EIA-570-B Article 800, NEC (NFPA 70) RoHS-compliant/RoHS 2-compliant
NRTL Programs	UL Verified CAT 5e UL, c(UL) Listed CMR UL, c(UL) Listed CMX Outdoor Sunlight Resistant

ENVIRONMENTAL SPECIFICATIONS AND TESTS

Operation	-40°F to +167°F (-40°C to +75°C)
Installation	-40°F to +140°F (-40°C to +60°C)
ANSI/ICEA S-100-685-2009 Tested down to -67°F (-55°C)	Section 7.1: -4°F (-20°C) cold bend test Section 7.2: +14°F (-10°C) cold impact test Section 7.3: -40°F (-40°C) anvil test

PART NUMBERS AND PHYSICAL CHARACTERISTICS

Part Number	Nominal Diameter in (mm)	Approx. Weight lbs/kft (kg/km)	Package	Packages per Pallet
51-240-E1	0.21 (5.3)	21 (31)	1,000' POP™ box	36

PRODUCT DESCRIPTION

The Superior Essex Category 5e CMR/CMX Outdoor Sunlight Resistant cable is specifically designed for extreme sunlight and temperature applications. The level of UV-blocking compounds is the same as in traditional Outside Plant (OSP) cable products with the black color preventing damage from long-term UV sunlight exposure. Applications include Ethernet interconnect cable for Wi-Fi or retrofit cable installations that employ exterior runs having long-term outdoor exposure between two environmentally protected points. CMX Outdoor cables are designed to extend the run between the Network Interface Unit and the point of entry into the interior of a residence or a premise.

Superior Essex CAT 5e CMR/CMX Outdoor Sunlight Resistant black premises cable has been tested and listed as UL® 444 Sunlight Resistant compliant. This designation requires the cable to resist 720 hours of harsh UV and heat, which is more than twice the exposure time of the standard 300 hours required in the CMX Outdoor test. In addition, the CMR listing allows the cable to be used in riser spaces per UL 1666, eliminating the need to transition to fire resistant cables.

APPLICATIONS

- 10BASE-T through 1000BASE-T Ethernet
- Power over Ethernet (PoE) - IEEE 802.3af
- PoE+ - IEEE 802.3at Type 1 and 2
- Wi-Fi - IEEE 802.11a/b/g/n

FEATURES

- Combines indoor/outdoor applications into one product with the added feature of Sunlight Resistant black color jacket
- Exceeds UL 444
- Meets ANSI/TIA-568-C.2 specification
- Moisture-resistant package
- CableID® alpha numeric code printed every 2 feet
- QuickCount® marking system in feet and meters
- ColorTip® Circuit Identification System
- Rip cord applied under jacket
- RoHS-compliant
- Combined indoor/outdoor rating
- UL 444/UL 1581 Sunlight Resistant Listed

BENEFITS

- Provides cost-effective solution
- 720 hour sunlight resistant specification
- CAT 5e performance
- Resists damp conditions that might weaken standard packages
- Allows both ends of a cable run to be easily identifiable without the need to separately label or tone the cable
- Provides remaining length of cable on reel
- Easily identifiable conductor mates even in low-light environments
- Facilitates easy opening
- No heavy metals; and no toxic components
- Reduces inventory by eliminating multiple cable types
- Increased life in direct, long term sunlight



CAUTIONARY INFORMATION

- Do not use as a substitute for Outside Plant (OSP) cables.
- Do not use in conduit or direct burial which can flood. These cables are not designed for extended exposure to water.

ELECTRICAL SPECIFICATIONS

Frequency MHz	Insertion Loss @ 20°C Maximum dB/100 m		NEXT Minimum dB/100 m		ACR Minimum dB/100 m		PSNEXT Minimum dB/100 m	
	TIA-568-C.2	Superior Essex	TIA-568-C.2	Superior Essex	TIA-568-C.2	Superior Essex	TIA-568-C.2	Superior Essex
	Specified	Typical	Specified	Typical	Calculated	Typical	Specified	Typical
1	2.0	1.8	65.3	76.8	63.3	81.0	62.3	75.3
4	4.1	3.7	56.3	67.8	52.2	70.1	53.3	66.3
8	5.8	5.4	51.8	63.3	46.0	63.9	48.8	61.8
10	6.5	6.0	50.3	61.8	43.8	61.8	47.3	60.3
16	8.2	7.7	47.2	58.7	39.0	57.0	44.3	57.2
20	9.3	8.6	45.8	57.3	36.5	54.7	42.8	55.8
25	10.4	9.6	44.3	55.8	33.9	52.2	41.3	54.3
31.25	11.7	10.8	42.9	54.4	31.2	49.6	39.9	52.9
62.5	17.0	15.5	38.4	49.9	21.4	40.4	35.4	48.4
100	22.0	19.8	35.3	46.8	13.3	33.0	32.3	45.3
155		24.8		43.9		25.1		42.4
200		28.2		42.3		20.1		40.8
250		31.8		40.8		15.0		39.3
300		35.0		39.6		10.6		38.1
350		38.3		38.6		6.3		37.1

Frequency MHz	PSACR Minimum dB/100 m		Return Loss Minimum dB/100 m		ELFEXT Minimum dB/100 m		PSELFEXT Minimum dB/100 m	
	TIA-568-C.2	Superior Essex	TIA-568-C.2	Superior Essex	TIA-568-C.2	Superior Essex	TIA-568-C.2	Superior Essex
	Calculated	Typical	Specified	Typical	Specified	Typical	Specified	Typical
1	60.3	78.3	20.0	33.0	63.8	74.6	60.8	69.3
4	49.2	67.4	23.0	36.0	51.8	62.6	48.8	57.3
8	43.0	61.2	24.5	37.5	45.7	56.5	42.7	51.2
10	40.8	59.1	25.0	38.0	43.8	54.6	40.8	49.3
16	36.1	54.3	25.0	38.0	39.7	50.5	36.7	45.2
20	33.5	52.0	25.0	38.0	37.8	48.6	34.8	43.3
25	30.9	49.5	24.3	37.3	35.8	46.6	32.8	41.3
31.25	28.2	46.9	23.6	36.6	33.9	44.7	30.9	39.4
62.5	18.4	37.7	21.5	34.5	27.9	38.7	24.9	33.4
100	10.3	30.3	20.1	33.1	23.8	34.6	20.8	29.3
155		22.4		31.8		30.8		25.5
200		17.4		31.0		28.6		23.3
250		12.3		30.3		26.6		21.3
300		7.9		29.8		25.1		19.8
350		3.6		29.3		23.7		18.4

UL is a registered trademark of UL LLC.

Category 5e

CMR/CMX Outdoor

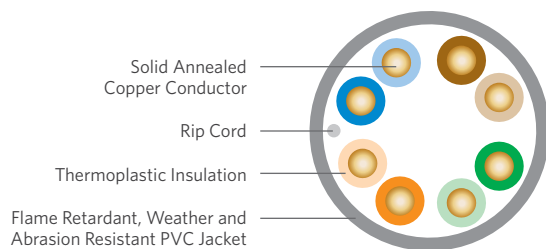

SPECIFICATIONS

Pair Count	4
Conductor	Solid annealed copper
AWG (mm)	24 (0.51)
Insulation	Polyolefin
Insulation Colors	Pair 1: ColorTip Light Blue, Blue Pair 2: ColorTip Light Orange, Orange Pair 3: ColorTip Light Green, Green Pair 4: ColorTip Light Brown, Brown
Ripcord	Non-wicking polyester yarn
Jacket	Tough, flame retardant, weather and abrasion resistant PVC
Characteristic Impedance Ohms	100 ± 15
Nominal Velocity of Propagation %	70
Performance Compliance	UL 444 CSA C22.2 No. 214-08 UL 1581 UL 1666 ANSI/TIA-568-C.2 ANSI/ICEA S-90-661-2012 ANSI/TIA/EIA-570-B Article 800, NEC (NFPA 70) RoHS-compliant/RoHS 2-compliant
NRTL Programs	UL Verified CAT 5e UL, c(UL) Listed CMR UL, c(UL) Listed CMX Outdoor

ENVIRONMENTAL SPECIFICATIONS AND TESTS

Operation	-40°F to +167°F (-40°C to +75°C)
Installation	-40°F to +140°F (-40°C to +60°C)
ANSI/ICEA S-100-685-2009 Tested down to -67°F (-55°C)	Section 7.1: -4°F (-20°C) cold bend test Section 7.2: +14°F (-10°C) cold impact test Section 7.3: -40°F (-40°C) anvil test

PART NUMBERS AND PHYSICAL CHARACTERISTICS

Part Number ¹	Nominal Diameter in (mm)	Approx. Weight lbs/kft (kg/km)	Package	Packages per Pallet
51-240-x1	0.21 (5.3)	21 (31)	1,000' POP™ box	36

JACKET COLORS

¹ Replace "x" with:	Beige = 1	Blue = 2	Gray = 3	White = 4
--------------------------------	-----------	----------	----------	-----------

UL is a registered trademark of UL LLC.

PRODUCT DESCRIPTION

The Superior Essex Category 5e CMR/CMX Outdoor cable is specifically designed for outdoor applications. UV-blocking compounds aid in protecting the cable from light. Applications include Ethernet interconnect cable for Wi-Fi or retrofit cable installations that employ exterior runs having long-term outdoor exposure between two environmentally protected points. CMX Outdoor cables are designed to extend the run between the Network Interface Unit and the point of entry into the interior of a residence or a premise.

Superior Essex CAT 5e CMR/CMX Outdoor premises cable has been tested and listed as UL® 444 Outdoor compliant. This designation requires the cable to resist 300 hours of UV and heat. In addition, the CMR listing allows the cable to be used in riser spaces per UL 1666, eliminating the need to transition to fire resistant cables.

APPLICATIONS

- 10BASE-T through 1000BASE-T Ethernet
- Power over Ethernet (PoE) - IEEE 802.3af
- PoE+ - IEEE 802.3at Type 1 and 2
- ATM and token ring

FEATURES

- Tough, weather resistant PVC jacket
- Combined indoor/outdoor rating
- Meets ANSI/TIA-568-C.2 specification
- Moisture-resistant package
- CableID® alpha numeric code printed every 2 feet
- QuickCount® marking system in feet and meters
- ColorTip® Circuit Identification System

BENEFITS

- Increases life of cable by providing low temperature handling and UV resistance; cable jacket resists cracking over time
- Reduces inventory by eliminating multiple cable types
- CAT 5e compliance
- Resists damp conditions that might weaken standard packages
- Allows both ends of a cable run to be easily identifiable without the need to separately label or tone the cable
- Provides remaining length of cable on reel
- Easily identifiable conductor mates even in low light environments



CAUTIONARY INFORMATION

- Do not use as a substitute for Outside Plant (OSP) cables.
- Do not use in conduit or direct burial which can flood. These cables are not designed for extended exposure to water.

ELECTRICAL SPECIFICATIONS

Frequency MHz	Insertion Loss @ 20°C Maximum dB/100 m		NEXT Minimum dB/100 m		ACR Minimum dB/100 m		PSNEXT Minimum dB/100 m	
	TIA-568-C.2	Superior Essex	TIA-568-C.2	Superior Essex	TIA-568-C.2	Superior Essex	TIA-568-C.2	Superior Essex
	Specified	Typical	Specified	Typical	Calculated	Typical	Specified	Typical
1	2.0	1.8	65.3	76.8	63.3	81.0	62.3	75.3
4	4.1	3.7	56.3	67.8	52.2	70.1	53.3	66.3
8	5.8	5.4	51.8	63.3	46.0	63.9	48.8	61.8
10	6.5	6.0	50.3	61.8	43.8	61.8	47.3	60.3
16	8.2	7.7	47.2	58.7	39.0	57.0	44.3	57.2
20	9.3	8.6	45.8	57.3	36.5	54.7	42.8	55.8
25	10.4	9.6	44.3	55.8	33.9	52.2	41.3	54.3
31.25	11.7	10.8	42.9	54.4	31.2	49.6	39.9	52.9
62.5	17.0	15.5	38.4	49.9	21.4	40.4	35.4	48.4
100	22.0	19.8	35.3	46.8	13.3	33.0	32.3	45.3
155		24.8		43.9		25.1		42.4
200		28.2		42.3		20.1		40.8
250		31.8		40.8		15.0		39.3
300		35.0		39.6		10.6		38.1
350		38.3		38.6		6.3		37.1

Frequency MHz	PSACR Minimum dB/100 m		Return Loss Minimum dB/100 m		ELFEXT Minimum dB/100 m		PSELFEXT Minimum dB/100 m	
	TIA-568-C.2	Superior Essex	TIA-568-C.2	Superior Essex	TIA-568-C.2	Superior Essex	TIA-568-C.2	Superior Essex
	Calculated	Typical	Specified	Typical	Specified	Typical	Specified	Typical
1	60.3	78.3	20.0	33.0	63.8	74.6	60.8	69.3
4	49.2	67.4	23.0	36.0	51.8	62.6	48.8	57.3
8	43.0	61.2	24.5	37.5	45.7	56.5	42.7	51.2
10	40.8	59.1	25.0	38.0	43.8	54.6	40.8	49.3
16	36.1	54.3	25.0	38.0	39.7	50.5	36.7	45.2
20	33.5	52.0	25.0	38.0	37.8	48.6	34.8	43.3
25	30.9	49.5	24.3	37.3	35.8	46.6	32.8	41.3
31.25	28.2	46.9	23.6	36.6	33.9	44.7	30.9	39.4
62.5	18.4	37.7	21.5	34.5	27.9	38.7	24.9	33.4
100	10.3	30.3	20.1	33.1	23.8	34.6	20.8	29.3
155		22.4		31.8		30.8		25.5
200		17.4		31.0		28.6		23.3
250		12.3		30.3		26.6		21.3
300		7.9		29.8		25.1		19.8
350		3.6		29.3		23.7		18.4

Category 5e F/UTP (ScTP)

CMR/CMX Outdoor Sunlight Resistant



Flame, Weather, Abrasion and Sunlight Resistant Black PVC Jacket

Solid Annealed Copper Conductor

Thermoplastic Insulation

Tin-Coated Drain Wire

Aluminum Foil Tape Shield

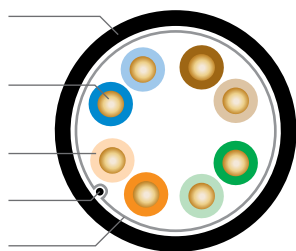

SPECIFICATIONS

Pair Count	4
Conductor	Solid annealed copper
AWG (mm)	24 (0.51)
Insulation	Polyolefin
Insulation Colors	Pair 1: ColorTip Light Blue, Blue Pair 2: ColorTip Light Orange, Orange Pair 3: ColorTip Light Green, Green Pair 4: ColorTip Light Brown, Brown
Shield	Aluminum foil tape
Drain Wire	24 AWG tinned copper
Jacket	Tough, flame retardant, sunlight, weather, and abrasion resistant, black, riser-rated PVC
Characteristic Impedance Ohms	100 ± 15
Nominal Velocity of Propagation %	67
Performance Compliance	UL 444 CSA C22.2 No. 214-08 UL 1581 UL 1666 NFPA 262 ANSI/TIA-568-C.2 ANSI/ICEA S-90-661-2012 Article 800, NEC (NFPA 70) RoHS-compliant/RoHS 2-compliant
NRTL Programs	UL Verified CAT 5e UL, c(UL) Listed CMR UL, c(UL) Listed CMX Outdoor Sunlight Resistant

ENVIRONMENTAL SPECIFICATIONS AND TESTS

Operation	-40°F/+167°F (-40°C to +75°C)
Installation	-40°F to +140°F (-40°C to +60°C)
ANSI/ICEA S-100-685-2009 Tested down to -67°F (-55°C)	Section 7.1: -4°F (-20°C) cold bend test Section 7.2: +14°F (-10°C) cold impact test Section 7.3: -40°F (-40°C) anvil test

PART NUMBERS AND PHYSICAL CHARACTERISTICS

Part Number ¹	Nominal Diameter in (mm)	Approx. Weight lbs/kft (kg/km)	Package	Packages per Pallet
5F-220-E1	0.26 (6.6)	29 (43)	1,000' Plywood reel	12

PRODUCT DESCRIPTION

The Superior Essex Category 5e F/UTP (ScTP) CMR/CMX Outdoor Sunlight Resistant cable is specifically designed for extreme sunlight and temperature applications that require shielding and a ground wire for Power-over-Ethernet (PoE) devices. The level of UV-blocking compounds is the same as in traditional Outside Plant (OSP) cable products with the black color preventing damage from long-term UV sunlight exposure. Applications include Ethernet interconnect cable for Wi-Fi or retrofit cable installations that employ exterior runs having long-term outdoor exposure between two environmentally protected points. CMX Outdoor cables are designed to extend the run between the Network Interface Unit and the point of entry into the interior of a residence or a premise.

Superior Essex CAT 5e F/UTP (ScTP) CMR/CMX Outdoor Sunlight Resistant black premises cable has been tested and listed as UL® 444 Sunlight Resistant compliant. This designation requires the cable to resist 720 hours of harsh UV and heat, which is more than twice the exposure time of the standard 300 hours required in the CMX Outdoor test. In addition, the CMR listing allows the cable to be used in riser spaces per UL 1666, eliminating the need to transition to fire resistant cables.

The cable is sweep-tested to 350 MHz and meets all applicable ANSI/TIA-568-C.2 requirements. It supports 1000BASE-T and surpasses the Grade 2 requirements specified in the ANSI/TIA/EIA-570-B Residential Telecommunications Standard.

APPLICATIONS

- 10BASE-T through 1000BASE-T Ethernet
- Power over Ethernet (PoE) - IEEE 802.3af
- PoE+ - IEEE 802.3at Type 1 and 2
- Wi-Fi - IEEE 802.11a/b/g/n
- Applications requiring secure networks or protection from EMI/RFI
- Indoor/Outdoor Ethernet applications

FEATURES

- UL 444/UL 1581 Sunlight Resistant Listed
- Combined CMR Riser Indoor and CMX Outdoor Sunlight Resistant Listing
- Meets ANSI/TIA-568-C.2 specification
- Moisture-resistant package
- CableID® alpha numeric code printed every 2 feet
- QuickCount® marking system in feet and meters
- ColorTip® Circuit Identification System
- RoHS-compliant

BENEFITS

- Increased life in direct, long term sunlight
- Reduces inventory by eliminating multiple cable types
- CAT 5e compliant
- Resists damp conditions that might weaken standard packages
- Allows both ends of a cable run to be easily identifiable without the need to separately label or tone the cable
- Provides remaining length of cable on reel
- Easily identifiable conductor mates even in low-light environments
- Free of heavy metal and toxic components



CAUTIONARY INFORMATION

- Do not use as a substitute for Outside Plant (OSP) cables.
- Do not use in conduit or direct burial which can flood. These cables are not designed for extended exposure to water.

ELECTRICAL SPECIFICATIONS

Frequency MHz	Insertion Loss @ 20°C Maximum dB/100 m		NEXT Minimum dB/100 m		ACR Minimum dB/100 m		PSNEXT Minimum dB/100 m	
	TIA-568-C.2	Superior Essex	TIA-568-C.2	Superior Essex	TIA-568-C.2	Superior Essex	TIA-568-C.2	Superior Essex
	Specified	Typical	Specified	Typical	Calculated	Typical	Specified	Typical
1	2.0	1.8	65.3	79.4	63.3	77.7	62.3	77.2
4	4.1	3.6	56.3	69.9	52.2	66.4	53.3	67.4
8	5.8	5.1	51.8	65.1	46.0	60.0	48.8	62.7
10	6.5	5.8	50.3	63.6	43.8	57.9	47.3	61.2
16	8.2	7.4	47.3	60.4	39.1	53.1	44.3	58.0
20	9.3	8.2	45.8	59.0	36.5	50.9	42.8	56.6
25	10.4	9.3	44.3	57.5	33.9	48.3	41.3	55.1
31.25	11.7	10.5	42.9	56.0	31.2	45.7	39.9	53.5
62.5	17.0	14.9	38.4	51.7	21.4	36.8	35.4	49.2
100	22.0	19.2	35.3	48.5	13.3	29.5	32.3	46.0
155		24.2		45.7		21.6		43.1
200		27.8		43.6		16.0		41.0
250		31.4		42.0		10.7		39.4
300		34.7		40.4		5.9		37.7
350		37.8		39.3		1.7		36.8

Frequency MHz	PSACR Minimum dB/100 m		Return Loss Minimum dB/100 m		ELFEXT Minimum dB/100 m		PSELFEXT Minimum dB/100 m	
	TIA-568-C.2	Superior Essex	TIA-568-C.2	Superior Essex	TIA-568-C.2	Superior Essex	TIA-568-C.2	Superior Essex
	Calculated	Typical	Specified	Typical	Specified	Typical	Specified	Typical
1	60.3	75.4	20.0	28.5	63.8	72.6	60.8	70.6
4	49.2	64.0	23.0	35.6	51.7	60.7	48.7	59.0
8	43.0	57.7	24.5	35.7	45.7	54.8	42.7	53.1
10	40.8	55.6	25.0	35.9	43.8	52.9	40.8	51.1
16	36.1	50.8	25.0	35.2	39.7	48.9	36.7	47.1
20	33.5	48.6	25.0	34.9	37.7	47.0	34.7	45.2
25	30.9	46.0	24.3	35.2	35.8	45.1	32.8	43.3
31.25	28.2	43.4	23.6	34.8	33.9	43.2	30.9	41.3
62.5	18.4	34.6	21.5	31.8	27.8	37.2	24.8	35.2
100	10.3	27.3	20.1	30.1	23.8	33.2	20.8	31.1
155		19.4		28.4		29.3		27.2
200		13.9		27.3		27.1		25.0
250		8.6		26.1		25.1		23.1
300		3.8		25.1		23.7		21.5
350				24.0		22.5		20.3

UL is a registered trademark of UL LLC.

Category 5e F/UTP (ScTP)

CMR/CMX Outdoor



Flame Retardant, Weather and Abrasion Resistant PVC Jacket

Solid Annealed Copper Conductor

Thermoplastic Insulation

Tin-Coated Drain Wire

Aluminum Foil Tape Shield

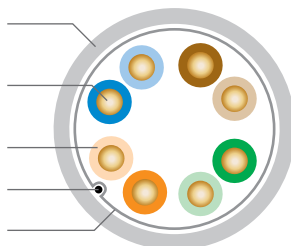

SPECIFICATIONS

Pair Count	4
Conductor	Solid annealed copper
AWG (mm)	24 (0.51)
Insulation	Polyolefin
Insulation Colors	Pair 1: ColorTip Light Blue, Blue Pair 2: ColorTip Light Orange, Orange Pair 3: ColorTip Light Green, Green Pair 4: ColorTip Light Brown, Brown
Shield	Aluminum foil tape
Drain Wire	24 AWG tinned copper
Jacket	Tough, flame retardant, UV, weather, and abrasion resistant PVC
Characteristic Impedance Ohms	100 ± 15
Nominal Velocity of Propagation %	67
Performance Compliance	UL 444 CSA C22.2 No. 214-08 UL 1666 NFPA 262 ANSI/TIA-568-C.2 ANSI/ICEA S-90-661-2012 Article 800, NEC (NFPA 70) RoHS-compliant/RoHS 2-compliant
NRTL Programs	UL Verified CAT 5e UL, c(UL) Listed CMR UL, c(UL) Listed CMX Outdoor

ENVIRONMENTAL SPECIFICATIONS AND TESTS

Operation	-40°F to +167°F (-40°C to +75°C)
Installation	-40°F to +140°F (-40°C to +60°C)
ANSI/ICEA S-100-685-2009 Tested down to -67°F (-55°C)	Section 7.1: -4°F (-20°C) cold bend test Section 7.2: +14°F (-10°C) cold impact test Section 7.3: -40°F (-40°C) anvil test

PART NUMBERS AND PHYSICAL CHARACTERISTICS

Part Number ¹	Nominal Diameter in (mm)	Approx. Weight lbs/kft (kg/km)	Package	Packages per Pallet
5F-220-x1	0.26 (6.6)	29 (43)	1,000' Plywood reel	12

JACKET COLORS

¹Replace "x" with:

Beige = 1

Blue = 2

Gray = 3

White = 4

PRODUCT DESCRIPTION

The Superior Essex Category 5e F/UTP (ScTP) CMR/CMX Outdoor cable is specifically designed for outdoor applications that require shielding and a ground wire for Power-over-Ethernet (PoE) devices. UV-blocking compounds aid in protecting the cable from light. Applications include Ethernet interconnect cable for Wi-Fi or retrofit cable installations that employ exterior runs having long-term outdoor exposure between two environmentally protected points. CMX Outdoor cables are designed to extend the run between the Network Interface Unit and the point of entry into the interior of a residence or a premise.

Superior Essex CAT 5e F/UTP (ScTP) CMR/CMX Outdoor premises cable has been tested and listed as UL® 444 Outdoor compliant. This designation requires the cable to resist 300 hours of UV and heat. In addition, the CMR listing allows the cable to be used in riser spaces per UL 1666, eliminating the need to transition to fire resistant cables.

The cable is sweep-tested to 350 MHz and meets all applicable ANSI/TIA-568-C.2 requirements. It supports 1000BASE-T and surpasses the Grade 2 requirements specified in the ANSI/TIA/EIA-570-B Residential Telecommunications Standard.

APPLICATIONS

- 10BASE-T through 1000BASE-T Ethernet
- Power over Ethernet (PoE) - IEEE 802.3af
- PoE+ - IEEE 802.3at Type 1 and 2
- ATM and token ring
- Applications requiring secure networks or protection from EMI/RFI
- Indoor/Outdoor Ethernet Applications

FEATURES

- Tough, weather resistant PVC jacket
- Combined indoor/outdoor rating
- Meets ANSI/TIA-568-C.2
- Moisture-resistant package
- CableID® alpha numeric code printed every 2 feet
- QuickCount® marking system in feet and meters
- ColorTip® Circuit Identification System
- RoHS-compliant

BENEFITS

- Increases life of cable by providing low temperature handling and sunlight resistance; cable jacket resists cracking over time
- Reduces inventory by eliminating multiple cable types
- CAT 5e compliant
- Resists damp conditions that might weaken standard packages
- Allows both ends of a cable run to be easily identifiable without the need to separately label or tone the cable
- Provides remaining length of cable on reel
- Easily identifiable conductor mates even in low-light environments
- Free of heavy metal and toxic components



CAUTIONARY INFORMATION

- Do not use as a substitute for Outside Plant (OSP) cables.
- Do not use in conduit or direct burial which can flood. These cables are not designed for extended exposure to water.

ELECTRICAL SPECIFICATIONS

Frequency MHz	Insertion Loss @ 20°C Maximum dB/100 m		NEXT Minimum dB/100 m		ACR Minimum dB/100 m		PSNEXT Minimum dB/100 m	
	TIA-568-C.2	Superior Essex	TIA-568-C.2	Superior Essex	TIA-568-C.2	Superior Essex	TIA-568-C.2	Superior Essex
	Specified	Typical	Specified	Typical	Calculated	Typical	Specified	Typical
1	2.0	1.8	65.3	79.4	63.3	77.7	62.3	77.2
4	4.1	3.6	56.3	69.9	52.2	66.4	53.3	67.4
8	5.8	5.1	51.8	65.1	46.0	60.0	48.8	62.7
10	6.5	5.8	50.3	63.6	43.8	57.9	47.3	61.2
16	8.2	7.4	47.3	60.4	39.1	53.1	44.3	58.0
20	9.3	8.2	45.8	59.0	36.5	50.9	42.8	56.6
25	10.4	9.3	44.3	57.5	33.9	48.3	41.3	55.1
31.25	11.7	10.5	42.9	56.0	31.2	45.7	39.9	53.5
62.5	17.0	14.9	38.4	51.7	21.4	36.8	35.4	49.2
100	22.0	19.2	35.3	48.5	13.3	29.5	32.3	46.0
155		24.2		45.7		21.6		43.1
200		27.8		43.6		16.0		41.0
250		31.4		42.0		10.7		39.4
300		34.7		40.4		5.9		37.7
350		37.8		39.3		1.7		36.8

Frequency MHz	PSACR Minimum dB/100 m		Return Loss Minimum dB/100 m		ELFEXT Minimum dB/100 m		PSELFEXT Minimum dB/100 m	
	TIA-568-C.2	Superior Essex	TIA-568-C.2	Superior Essex	TIA-568-C.2	Superior Essex	TIA-568-C.2	Superior Essex
	Calculated	Typical	Specified	Typical	Specified	Typical	Specified	Typical
1	60.3	75.4	20.0	28.5	63.8	72.6	60.8	70.6
4	49.2	64.0	23.0	35.6	51.7	60.7	48.7	59.0
8	43.0	57.7	24.5	35.7	45.7	54.8	42.7	53.1
10	40.8	55.6	25.0	35.9	43.8	52.9	40.8	51.1
16	36.1	50.8	25.0	35.2	39.7	48.9	36.7	47.1
20	33.5	48.6	25.0	34.9	37.7	47.0	34.7	45.2
25	30.9	46.0	24.3	35.2	35.8	45.1	32.8	43.3
31.25	28.2	43.4	23.6	34.8	33.9	43.2	30.9	41.3
62.5	18.4	34.6	21.5	31.8	27.8	37.2	24.8	35.2
100	10.3	27.3	20.1	30.1	23.8	33.2	20.8	31.1
155		19.4		28.4		29.3		27.2
200		13.9		27.3		27.1		25.0
250		8.6		26.1		25.1		23.1
300		3.8		25.1		23.7		21.5
350				24.0		22.5		20.3

UL is a registered trademark of UL LLC.

6-Pair Category 5e

CMR

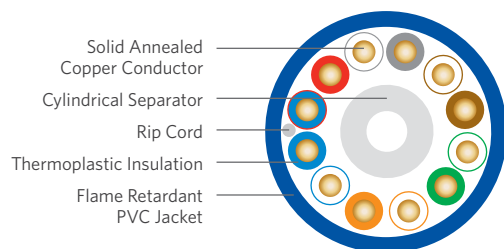

SPECIFICATIONS

Pair Count	6
Conductor	Solid annealed copper
AWG (mm)	24 (0.51)
Insulation	Polyolefin
Separator	Round filler
Jacket	Flame retardant PVC
Characteristic Impedance Ohms	100 ± 15
Nominal Velocity of Propagation %	71
Performance Compliance	UL® 444 CSA C22.2 No. 214-08 UL 1666 ANSI/TIA-568-C.2 ANSI/ICEA S-90-661-2012 Article 800, NEC (NFPA 70) RoHS-compliant/RoHS 2-compliant
NRTL Programs	UL, c(UL) Listed CMR

PART NUMBERS AND PHYSICAL CHARACTERISTICS

Listing	Part Number ¹	Nominal Diameter in (mm)	Approx. Weight lbs/kft (kg/km)	Package	Packages per Pallet
CMR	51-347-x5	0.26 (6.6)	32 (48)	1,000' Reel-in-a-Box	27
CMR	51-372-x5	0.26 (6.6)	32 (48)	1,000' Plywood reel	16

JACKET COLORS

¹Replace "x" with: Blue = 2 Gray = 3

UL is a registered trademark of UL LLC.

PRODUCT DESCRIPTION

6-pair UTP cable, with Category 5e (ANSI/TIA-568-C.2) performance, is the solution to a growing number of special installation needs. More customers are demanding two additional pairs above the standard 4-pair cable for high-bandwidth applications. Two additional pairs provide the flexibility for utility metering and other telemetry needs without the expense of adding a separate cable and without additional space. The Superior Essex 6-pair CAT 5e cable delivers the performance expected, while offering the many features and user advantages of all our high performance premises products.

APPLICATIONS

- 10BASE-T through 1000BASE-T Ethernet
- Power over Ethernet (PoE) - IEEE 802.3af
- PoE+ - IEEE 802.3at Type 1 and 2
- ATM and token ring

FEATURES

- Two additional pairs in excess of the standard 4-pair construction
- ANSI/TIA-568-C.2 compliance
- CableID® alpha numeric code printed every 2 feet
- QuickCount® marking system in feet and meters
- Warrantied with all leading connectivity manufacturers

BENEFITS

- Eliminates expense of additional cable when 6-pair are required, reduces cabling space requirements; speeds installation time
- Any of the 6-pair can be used for CAT 5e applications
- Allows both ends of a cable run to be easily identifiable without the need to separately label or tone the cable
- Eliminates guesswork of footage on reel and reduces scrap
- Offers flexibility in selection of connectivity solutions

25-Pair Power Sum Category 5e

CMR/CMP

PRODUCT DESCRIPTION

25-Pair Power Sum Category 5e UTP cables are designed to provide support for both backbone and horizontal applications. These applications include inter-closet backbone links, equipment cabling between cross-connect and hub equipment and zone distribution horizontal cabling between wiring closets and multiple work area transition points. The cable is available in CMP and CMR ratings and is UL® verified to meet all requirements of ANSI/TIA-568-C.2.

APPLICATIONS

- 10BASE-T through 1000BASE-T Ethernet
- Power over Ethernet (PoE) - IEEE 802.3af
- PoE+ - IEEE 802.3at Type 1 and 2
- ATM and token ring

FEATURES

- Small outside diameter
- Vibrant insulation colors
- Flexible jacket material
- Marked in feet and meters

BENEFITS

- Handles tight installations
- Easier identification of conductors
- Ease of use during installation
- Dual length marking complies with government, military and international requirements

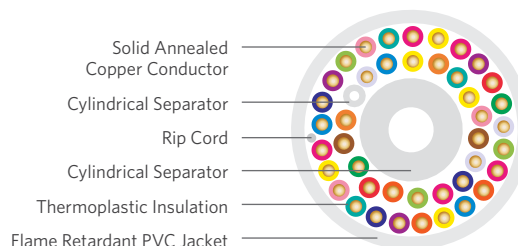

SPECIFICATIONS

Pair Count	25
Conductor	Solid annealed copper
AWG (mm)	24 (0.51)
Insulation	CMR: Thermoplastic CMP: FEP
Separator	Cylindrical
Jacket	CMR: White, flame retardant PVC CMP: White, fluoropolymer
Characteristic Impedance Ohms	100 ± 15
Nominal Velocity of Propagation %	CMR: 69 CMP: 73
Performance Compliance	UL 444 CSA C22.2 No. 214-08 UL 1666 NFPA 262 ANSI/TIA-568-C.2 ANSI/ICEA S-90-661-2012 Article 800, NEC (NFPA 70) RoHS-compliant/RoHS 2-compliant
NRTL Programs	UL Verified CAT 5e UL, c(UL) Listed CMR UL, c(UL) Listed CMP

PART NUMBERS AND PHYSICAL CHARACTERISTICS

Listing	Part Number ¹	Nominal Diameter in (mm)	Approx. Weight lbs/kft (kg/km)	Package	Packages per Pallet
CMR	51-478-45	0.57 (14.5)	144 (214)	1,000' Plywood reel	4
CMP	51-478-48	0.48 (12.2)	148 (220)	1,000' Plywood reel	4

UL is a registered trademark of UL LLC.

25-Pair Category 5e Indoor/Outdoor

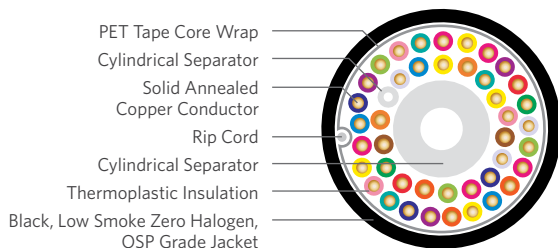

PRODUCT DESCRIPTION

With its CM fire rating and UV resistant black jacket, this 25-pair, 24 gauge, Category 5e tight twisted copper conductor cable can be installed in both premises and outside plant (OSP) environments. The CAT 5e tight twist lays provide superior crosstalk performance, supporting digital subscriber line (xDSL) and IPTV broadband technologies in both the OSP pedestal and customer premises. In addition, the cable jacket is fungus resistant which is important in OSP pedestal environments. The cable meets or exceeds ANSI/TIA-568-C.2 for CAT 5e backbone cables and is able to support up to 1000BASE-T Ethernet technologies.

APPLICATIONS

- ADSL, VDSL, VDSL+ and VDSL+2
- 10BASE-T through 1000BASE-T Ethernet
- Power over Ethernet (PoE) – IEEE 802.3af
- PoE+ – IEEE 802.3at Type 1 and 2
- ATM and token ring

FEATURES

- Small outside diameter
- Vibrant insulation colors
- Black, CM rated, non-halogen, OSP grade jacket material
- Fungus resistance
- Compliant to ANSI/TIA-568-C.2 for CAT 5e
- Specially designed tight twist lays
- Low temperature bend performance

BENEFITS

- Handles tight installations
- Easy identification of conductors
- Provides full sunlight resistance and fire protection in a flexible jacket
- Non-nutritive to fungus and ideal for installation in humid environments
- Capable of 1000BASE-T
- Provides superior Alien Crosstalk performance for xDSL applications
- Allows installation at -20°C temperatures

SPECIFICATIONS

Pair Count	25
Conductor	Solid annealed copper
AWG (mm)	24 (0.51)
Insulation	Thermoplastic
Separators	Cylindrical, flame retardant thermoplastic
Core Wrap	PET Tape
Jacket	Black, CM rated, non-halogen OSP grade
Input Impedance Ohms Guaranteed @ 1-100 MHz	100 ± 15
Delay Skew ns/100 m	Maximum: 45 Typical: 30
Nominal Velocity of Propagation %	69
DC Resistance Ohms/100 m	Maximum: 9.38 Typical: 9.0
Resistance Unbalance %	Maximum: 5.0 Typical: 0.7
Performance Compliance	UL® 444 CSA C22.2 No. 214-08 ANSI/TIA-568-C.2 ANSI/ICEA S-90-661-2012 Article 800, NEC (NFPA 70) RoHS-compliant/RoHS 2-compliant
NRTL Programs	UL, c(UL) Listed CM

PART NUMBERS AND PHYSICAL CHARACTERISTICS

Part Number	Nominal Diameter in (mm)	Approx. Weight lbs/kft (kg/km)	Package
51-499-EL	0.59 (15)	148 (221)	1,000' Plywood reel

UL is a registered trademark of UL LLC.

PRODUCT DESCRIPTION

Interlock Armored Category 6, Category 5e, Category 3 and/or RG-6 Quad Coax Riser cables provide significant mechanical protection. Interlock armored cables with two or more components of the same type can have either different colored components or uniquely labeled components with the same color. Multiple cables can be constructed in either aluminum or steel interlock armored; and the final cable is available in bare metal or with an overall jacket. Each component cable is tested after interlock armoring to ensure that it meets all applicable industry requirements. Cable configurations that include optical fiber distribution cables are also available.

FEATURES

- Aluminum or steel interlock armored
- Category components meets ANSI/TIA-568-C.2 for CAT 3, CAT 5e and CAT 6
- CMR rated components

BENEFITS

- Protects against mechanical stresses
- Protects against EMI/RFI for reliable performance
- Provides additional fire protection over riser rating
- Installs faster and easier than EMT conduit and conventional wire
- Supports applications up to 1000BASE-T
- Maintains the fire rating with interlock armored removed

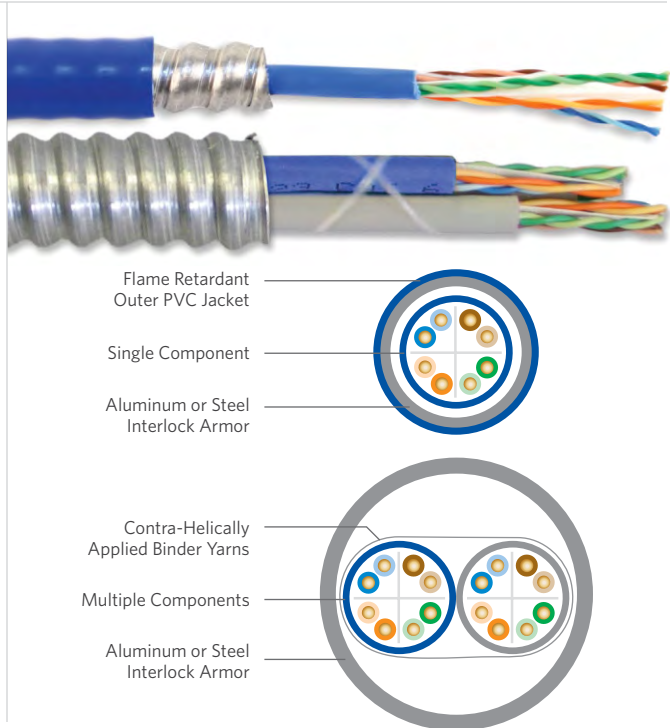

SPECIFICATIONS

Overall Cable Configuration	Single to multiple component riser cables surrounded by aluminum or steel interlock armored
Armor	Interlocked aluminum or interlocked steel
Armor Jacket Options	Non-jacketed or jacketed (matches component color)
Armor/Component Jacket	Riser grade PVC
Component Fire Listings	UL® 1666, UL CMR, c(UL) CMR
Performance Compliance	UL 1569 UL 444 CSA C22.2 No. 214-08 ANSI/TIA-568-C.2 ANSI/ICEA S-90-661-2012 Article 800, NEC (NFPA 70) RoHS-compliant/RoHS 2-compliant
NRTL Programs	UL, c(UL) Listed CMR

PART NUMBERS AND PHYSICAL CHARACTERISTICS

Part Number ¹	Configuration	Component	Number of Components	Nominal Diameter in (mm)	Approx. Weight lbs/kft (kg/km)	Package
K4-199-xA	Aluminum interlock armored, no outer jacket	4-pair CAT 6	1	0.49 (12.5)	67 (100)	1,000' Wood reel
L4-199-xA	Aluminum interlock armored, with outer jacket*	4-pair CAT 6	1	0.55 (14.0)	104 (155)	1,000' Wood reel
K4-299-yA	Aluminum interlock armored, no outer jacket	4-pair CAT 6	2	0.80 (20.2)	117 (174)	1,000' Wood reel
L4-299-yA	Aluminum interlock armored, with outer jacket*	4-pair CAT 6	2	0.87 (22.2)	196 (292)	1,000' Wood reel
K2-199-x5	Aluminum interlock armored, no outer jacket	4-pair CAT 5e	1	0.44 (11.1)	55 (82)	1,000' Wood reel
L2-199-x5	Aluminum interlock armored, with outer jacket*	4-pair CAT 5e	1	0.50 (12.6)	88 (132)	1,000' Wood reel
K2-299-y5	Aluminum interlock armored, no outer jacket	4-pair CAT 5e	2	0.80 (20.2)	105 (156)	1,000' Wood reel
L2-299-y5	Aluminum interlock armored, with outer jacket*	4-pair CAT 5e	2	0.88 (22.2)	184 (274)	1,000' Wood reel
KC-919-x5	Aluminum interlock armored, no outer jacket	RG-6 Quad**	1	0.53 (13.5)	73 (109)	1,000' Wood reel
K8-A99-33	Aluminum interlock armored, no outer jacket	25-pair CAT 3	1	0.79 (20.2)	159 (237)	1,000' Wood reel

*For single unit cables, the outer jacket color matches the internal component jacket color. For multi-unit cables, the outer jacket standard color is blue. Additional cable combinations are available. **Coaxial available with component jacket color in black or white.

SINGLE COMPONENT JACKET COLORS

¹Replace "x" with:

Blue = 2	Gray = 3	White = 4	Green = 5	Yellow = 6	Purple = 7	Red = 9	Orange = D	Black = E
----------	----------	-----------	-----------	------------	------------	---------	------------	-----------

DUAL COMPONENT JACKET COLORS

¹Replace "y" with "S" ¹Replace "y" with "T"

Blue	White	Blue	Gray
------	-------	------	------

Other color sequences are available upon request. UL is a registered trademark of UL LLC.

Bundled Category 6

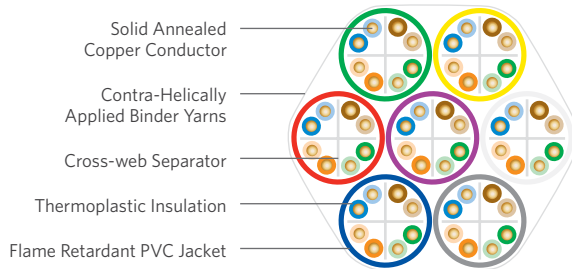

SPECIFICATIONS

Conductor	Solid annealed copper
AWG (mm)	23 (0.57)
Insulation	CMR: Thermoplastic CMP: FEP
Insulation Colors	Pair 1: ColorTip Light Blue, Blue Pair 2: ColorTip Light Orange, Orange Pair 3: ColorTip Light Green, Green Pair 4: ColorTip Light Brown, Brown
Separator	Cross-web
Jacket	CMR: Flame retardant (FR) PVC CMP: FR, low smoke PVC
Characteristic Impedance Ohms	100 ± 15
Nominal Velocity of Propagation %	CMR: 70 CMP: 74
Component Performance Compliance	UL® 444 CSA C22.2 No. 214-08 UL 1666 NFPA 262 ANSI/TIA-568-C.2 Article 800, NEC (NFPA 70) RoHS-compliant/RoHS 2-compliant
Component NRTL Programs	UL, c(UL) Listed CMR UL, c(UL) Listed CMP

PRODUCT DESCRIPTION

Superior Essex Bundled UTP cables reduce the amount of cable pulls in an installation and simplify cable management. These bundled cables consist of multiple Category 6 compliant cables bundled together and bound by contra-helically applied binder yarns. The binder configuration allows for easy breakout and offers greater flexibility compared to an overjacket design. Contrasting jacket colors allow for easy identification.

APPLICATIONS

- 10BASE-T through 1000BASE-T Ethernet
- Power over Ethernet (PoE) - IEEE 802.3af
- PoE+ - IEEE 802.3at Type 1 and 2
- ATM and token ring

FEATURES

- Binding of multiple UTP cables
- Multiple construction options (2 to 7 cable sub-units)
- Warrantied with numerous connectivity manufacturers
- ColorTip® circuit identification system
- Flexible, dual binder yarns, contra-helically applied

BENEFITS

- Reduces installation time
- Improves cable management
- Sizes available for small and large projects
- Easily identifiable conductor mates, even in low light environment
- Maintains maximum flexibility and allows for easy breakout

PART NUMBERS AND PHYSICAL CHARACTERISTICS

Listing	Part Number	Cable Sub-units	Jacket Colors*	Nominal Diameter in (mm)	Approx. Weight lbs/kft (kg/km)	Standard Length ft (m)	Reel Size F x T x D (in)
CMR	56-202-2A	2	Blue, Gray	0.44 (11.2)	48 (106)	2,500 (762)	30 x 18 x 12
CMR	56-202-3A	3	Blue, Gray, White	0.48 (12.1)	72 (159)	2,500 (762)	30 x 18 x 12
CMR	56-202-4A	4	Blue, Gray, White, Yellow	0.53 (13.6)	97 (213)	2,500 (762)	30 x 18 x 12
CMR	56-201-5A	5	Blue, Gray, White, Yellow, Green	0.61 (15.5)	121 (266)	2,500 (762)	30 x 18 x 12
CMR	56-201-6A	6	Blue, Gray, White, Yellow, Green, Red	0.70 (17.8)	145 (319)	2,500 (762)	30 x 18 x 12
CMR	56-201-7A	7	Blue, Gray, White, Yellow, Green, Red, Purple	0.70 (17.8)	176 (387)	1,000 (305)	30 x 18 x 12
CMP	56-202-2B	2	Blue, Gray	0.48 (12.1)	57 (126)	2,500 (762)	30 x 18 x 12
CMP	56-202-3B	3	Blue, Gray, White	0.51 (13.0)	86 (189)	2,500 (762)	30 x 18 x 12
CMP	56-202-4B	4	Blue, Gray, White, Yellow	0.57 (14.6)	115 (252)	2,500 (762)	30 x 18 x 12
CMP	56-201-5B	5	Blue, Gray, White, Yellow, Green	0.64 (16.3)	143 (315)	2,500 (762)	30 x 18 x 12
CMP	56-201-6B	6	Blue, Gray, White, Yellow, Green, Red	0.71 (18.1)	172 (378)	2,500 (762)	30 x 18 x 12
CMP	56-201-7B	7	Blue, Gray, White, Yellow, Green, Red, Purple	0.71 (18.1)	201 (441)	1,000 (305)	30 x 18 x 12

*Other jacket color combinations available.

JACKET COLORS

Blue	Gray	White	Yellow	Green	Red	Purple
------	------	-------	--------	-------	-----	--------

UL is a registered trademark of UL LLC.



800.551.8948
SuperiorEssex.com

All information, content, data, specifications, packaging and part numbers detailed herein are subject to change. For the most up-to-date information, please visit SuperiorEssex.com. Purchase of this product is subject exclusively to the then current Superior Essex International LP Terms and Conditions of Sale for Communications and Energy Cable, Wire and Connectivity Products, which can be found on our website, SuperiorEssex.com, or provided to you upon request.

Rev 7/15
Ed 13.0

PRODUCT DESCRIPTION

Superior Essex Bundled UTP cables reduce the amount of cable pulls in an installation and simplify cable management. These bundled cables consist of multiple Category 5e compliant cables bundled together and bound by contra-helically applied binder yarns. The binder configuration allows for easy breakout and offers greater flexibility compared to a composite overjacket design. Contrasting jacket colors allow easy identification.

APPLICATIONS

- 10BASE-T through 1000BASE-T Ethernet
- Power over Ethernet (PoE) - IEEE 802.3af
- PoE+ - IEEE 802.3at Type 1 and 2
- ATM and token ring

FEATURES

- Binding of multiple UTP cables
- Multiple construction options (2 to 7 cable sub-units)
- Warrantied with numerous connectivity manufacturers
- ColorTip® circuit identification system
- Flexible, dual binder yarns, contra-helically applied

BENEFITS

- Reduces installation time
- Improves cable management
- Sizes available for small and large projects
- Easily identifiable conductor mates, even in low light environment
- Maintains maximum flexibility and allows for easy breakout

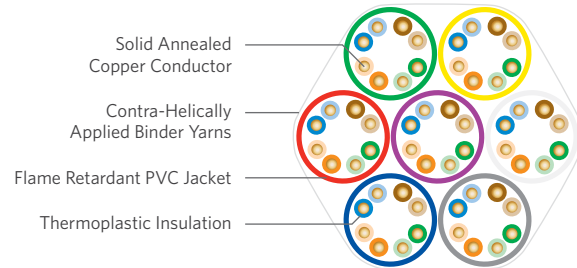

SPECIFICATIONS

Conductor	Solid annealed copper
AWG (mm)	24 (0.51)
Insulation	Thermoplastic
Insulation Colors	Pair 1: ColorTip Light Blue, Blue Pair 2: ColorTip Light Orange, Orange Pair 3: ColorTip Light Green, Green Pair 4: ColorTip Light Brown, Brown
Jacket	CMR: Flame retardant (FR) PVC CMP: FR, low smoke PVC
Characteristic Impedance Ohms	100 ± 15
Nominal Velocity of Propagation %	CMR: 70 CMP: 73
Component Performance Compliance	UL® 444 CSA C22.2 No. 214-08 UL 1666 NFPA 262 ANSI/TIA-568-C.2 ANSI/ICEA S-90-661-2012 Article 800, NEC (NFPA 70) RoHS-compliant/RoHS 2-compliant
Component NRTL Programs	UL, c(UL) Listed CMP UL, c(UL) Listed CMR

PART NUMBERS AND PHYSICAL CHARACTERISTICS

Listing	Part Number	Cable Sub-units	Jacket Colors*	Nominal Diameter in (mm)	Approx. Weight lbs/kft (kg/km)	Standard Length ft (m)	Reel Size F x T x D (in)
CMR	56-202-25	2	Blue, Gray	0.38 (9.7)	38 (083)	2,500 (762)	30 x 18 x 12
CMR	56-202-35	3	Blue, Gray, White	0.41 (10.4)	57 (125)	2,500 (762)	30 x 18 x 12
CMR	56-202-45	4	Blue, Gray, White, Yellow	0.46 (11.7)	76 (167)	2,500 (762)	30 x 18 x 12
CMR	56-201-55	5	Blue, Gray, White, Yellow, Green	0.51 (13.0)	95 (208)	2,500 (762)	30 x 18 x 12
CMR	56-201-65	6	Blue, Gray, White, Yellow, Green, Red	0.56 (14.2)	114 (250)	2,500 (762)	30 x 18 x 12
CMR	56-201-75	7	Blue, Gray, White, Yellow, Green, Red, Purple	0.56 (14.2)	133 (292)	1,000 (305)	30 x 18 x 12
CMP	56-202-28	2	Blue, Gray	0.35 (8.9)	39 (085)	2,500 (762)	30 x 18 x 12
CMP	56-202-38	3	Blue, Gray, White	0.38 (9.6)	58 (127)	2,500 (762)	30 x 18 x 12
CMP	56-202-48	4	Blue, Gray, White, Yellow	0.42 (10.8)	77 (170)	2,500 (762)	30 x 18 x 12
CMP	56-201-58	5	Blue, Gray, White, Yellow, Green	0.48 (12.1)	96 (212)	2,500 (762)	30 x 18 x 12
CMP	56-201-68	6	Blue, Gray, White, Yellow, Green, Red	0.53 (13.4)	116 (254)	2,500 (762)	30 x 18 x 12
CMP	56-201-78	7	Blue, Gray, White, Yellow, Green, Red, Purple	0.53 (13.4)	135 (297)	1,000 (305)	30 x 18 x 12

*Other jacket color combinations available.

JACKET COLORS

Blue	Gray	White	Yellow	Green	Red	Purple
------	------	-------	--------	-------	-----	--------

UL is a registered trademark of UL LLC.

OSP Broadband BBD

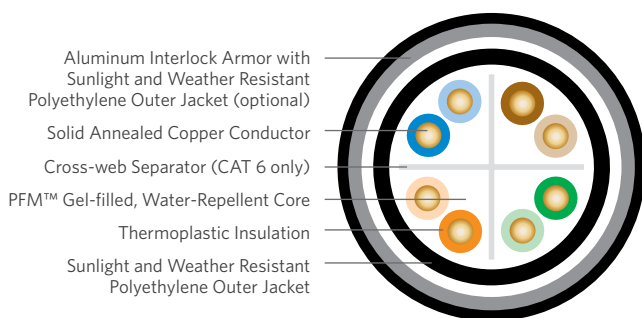
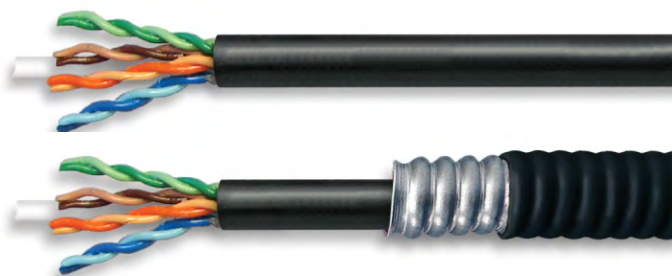

Aluminum Interlock Armor with Sunlight and Weather Resistant Polyethylene Outer Jacket (optional)

Solid Annealed Copper Conductor

Cross-web Separator (CAT 6 only)

PFM™ Gel-filled, Water-Repellent Core

Thermoplastic Insulation

Sunlight and Weather Resistant Polyethylene Outer Jacket

SPECIFICATIONS

Pair Count	4
Conductor	Solid annealed copper
Insulation	Polyolefin
Separator	CAT 6: Polyolefin cross-web CAT 5e: none
Jacket	Black, sunlight and weather resistant polyethylene
Optional Outer Armor	Interlocked aluminum armor covered with black, sunlight and weather resistant polyethylene jacket
Characteristic Impedance Ohms	100 ± 15
Nominal Velocity of Propagation %	CAT 6A/6: 68 CAT 5e: 65
Performance Compliance	ANSI/TIA-568-C.2 ANSI/ICEA S-107-704-2012 RoHS-compliant/RoHS 2-compliant REACH-compliant

ENVIRONMENTAL SPECIFICATIONS AND TESTS

Operation	-40°F to +167°F (-40°C to +75°C)
Installation	-40°F to +140°F (-40°C to +60°C)
ANSI/ICEA S-100-685-2009 Tested down to -67°F (-55°C)	Section 7.1: -4°F (-20°C) cold bend test Section 7.2: +14°F (-10°C) cold impact test Section 7.3: -40°F (-40°C) anvil test

PART NUMBERS AND PHYSICAL CHARACTERISTICS

Category	Configuration	Part Number	Product Code	AWG (mm)	Nominal Diameter in (mm)	Approx. Weight lbs/kft (kg/km)	Package
CAT 6	Interlock armored	L4-001-68	BBD6	23 (0.57)	0.56 (14.1)	101 (150)	1,000' Plywood reel
CAT 6	n/a	04-001-68	BBD6	23 (0.57)	0.30 (7.6)	33 (49)	1,000' Plywood reel
CAT 5e	n/a	04-001-58	BBD5e	24 (0.51)	0.26 (6.6)	24 (36)	1,000' Plywood reel

Additional part numbers, constructions and packaging available upon request.

PRODUCT DESCRIPTION

BBD is an Outside Plant (OSP) unshielded Broadband category cable. It is designed to provide an extension of the LAN beyond the premises or in situations where the NEC code requires an OSP-rated cable when it is in contact with earth, whether in a conduit or not. The cable consists of a core of four (4) balanced twisted pairs surrounded by Superior Essex PFM™ gel that does not drip or flow, even in cell tower applications at elevated temperatures. The core is jacketed with a sunlight and abrasion resistant black, polyethylene outer jacket. This unshielded design is suitable for the following deployments: duct, underground conduit and tower.

The BBD is available in a variety of performances including CAT 5e and CAT 6. An optional Aluminum Interlock Armor with overjacket is also available (not suitable for tower deployment).

APPLICATIONS

- 10BASE-T through 1000BASE-T Ethernet
- Power over Ethernet (PoE) - IEEE 802.3af
- PoE+ - IEEE 802.3at Type 1 and 2
- ATM and token ring

FEATURES

- Transmission performance characterized to 500 MHz for CAT 6 and 350 MHz for CAT 5e
- Unshielded
- PFM gel-filled core construction
- OSP-grade black polyethylene jacket
- ColorTip® circuit identification system
- Aluminum interlock armored construction

BENEFITS

- Assures ample overhead for reliable transmission in an OSP-rated cable allowing extension of the premises LAN
- Small, robust design
- Prevents intrusion of moisture and easily wipes clean during installation
- Outside plant rated cable for years of reliable performance
- Easily identifiable conductor mates even in low-light environments
- Protects against mechanical stresses
- Installs faster and easier than EMT conduit and conventional wire



TECHNICAL GUIDELINE

Special connectivity is required for these cable designs. Refer to the "Resources" section on our site for the Technical Guideline, "OSP Broadband Installation Guidelines," for more information.

PRODUCT DESCRIPTION

BBDN is an Outside Plant (OSP) Broadband category cable. It is designed to provide an extension of the LAN beyond the premises or in situations where the NEC code requires an OSP-rated cable when it is in contact with earth, whether in a conduit or not. The cable consists of four (4) balanced twisted pairs surrounded by Superior Essex PFM™ gel that does not drip or flow, even in cell tower applications at elevated temperatures. The jacketed core is covered with dry block and an 8 mil aluminum tape shield providing exceptional Alien Crosstalk (AXT) performance. The outer jacket is OSP-grade black, polyethylene for superior sunlight and abrasion resistance. This shielded design is suitable for the following deployments: duct, underground conduit, tower, lashed aerial or open trench.

The BBDN is available in a variety of performances including CAT 5e, CAT 6 and CAT 6A. An optional Aluminum Interlock Armor with overjacket is also available (not suitable for tower deployment).

APPLICATIONS

- CAT 6A: 10BASE-T through 10GBASE-T Ethernet; CAT 6/5e: 10BASE-T through 1000BASE-T Ethernet
- Power over Ethernet (PoE) - IEEE 802.3af
- PoE+ - IEEE 802.3at Type 1 and 2
- ATM and token ring

FEATURES

- Transmission performance characterized to 500 MHz for CAT 6A/6 and 350 MHz for CAT 5e
- 8 mil aluminum tape shield
- Dry block between shield and inner jacket
- PFM gel-filled core construction
- OSP-grade black polyethylene jacket
- ColorTip® circuit identification system
- Aluminum interlock armored construction

BENEFITS

- Assures ample overhead for reliable transmission in an OSP-rated cable allowing extension of the premises LAN
- Rugged shield provides protection against EMI/RFI
- Prevents water ingress between shield and inner cable preventing damage to equipment
- Prevents intrusion of moisture and easily wipes clean during installation
- Outside plant rated cable for years of reliable performance
- Easily identifiable conductor mates even in low-light environments
- Protects against mechanical stresses
- Installs faster and easier than EMT conduit and conventional wire

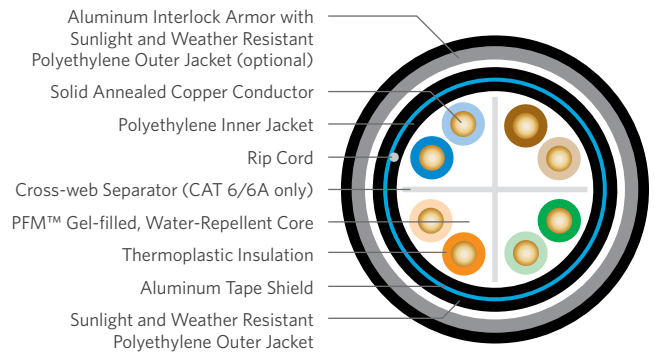

SPECIFICATIONS

Pair Count	4
Conductor	Solid annealed copper
Insulation	Polyolefin
Separator	CAT 6A/6: Polyolefin cross-web CAT 5e: none
Inner Shield	Electrically continuous 0.008 in (0.20 mm) polymer coated smooth aluminum tape shield, applied with an overlap
Dry Water Block	SAP powder
Jacket	Black, sunlight and weather resistant polyethylene
Optional Outer Armor	Interlocked aluminum armor covered with black, sunlight and weather resistant polyethylene jacket
Characteristic Impedance Ohms	100 ± 15
Nominal Velocity of Propagation %	CAT 6A/6: 68 CAT 5e: 65
Performance Compliance	ANSI/TIA-568-C.2 ANSI/ICEA S-107-704-2012 RoHS-compliant/RoHS 2-compliant REACH-compliant

ENVIRONMENTAL SPECIFICATIONS AND TESTS

Operation	-40°F to +167°F (-40°C to +75°C)
Installation	-40°F to +140°F (-40°C to +60°C)
ANSI/ICEA S-100-685-2009 Tested down to -67°F (-55°C)	Section 7.1: -4°F (-20°C) cold bend test Section 7.2: +14°F (-10°C) cold impact test Section 7.3: -40°F (-40°C) anvil test



TECHNICAL GUIDELINE

Special connectivity is required for these cable designs. Refer to the "Resources" section on our site for the Technical Guideline, "OSP Broadband Installation Guidelines," for more information.

PART NUMBERS AND PHYSICAL CHARACTERISTICS

Category	Part Number	Product Code	AWG (mm)	Nominal Diameter in (mm)	Approx. Weight lbs/kft (kg/km)	Package
CAT 6A	04-001-A4	BBDN6A	23 (0.57)	0.39 (9.8)	59 (88)	1,000' Plywood reel
CAT 6	04-001-64	BBDN6	23 (0.57)	0.39 (9.8)	59 (88)	1,000' Plywood reel
CAT 5e	04-001-54	BBDNe	24 (0.51)	0.36 (9.1)	49 (73)	1,000' Plywood reel

Additional part numbers, constructions and packaging available upon request.

OSP Broadband BBDG

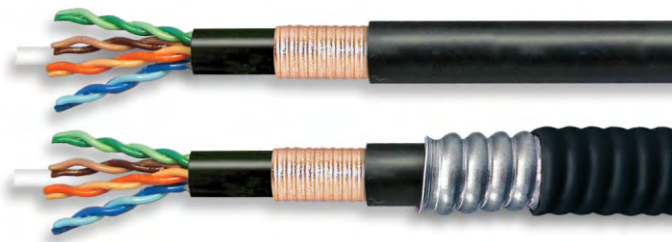

Aluminum Interlock Armor with Sunlight and Weather Resistant Polyethylene Outer Jacket (optional)
Solid Annealed Copper Conductor
Polyethylene Inner Jacket
Rip Cord
Cross-web Separator (CAT 6/6A only)
PFM™ Gel-filled, Water-Repellent Core
Thermoplastic Insulation
Copper-clad Steel Armor
Sunlight and Weather Resistant Polyethylene Outer Jacket

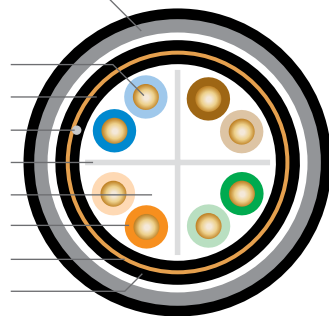

SPECIFICATIONS

Pair Count	4
Conductor	Solid annealed copper
Insulation	Polyolefin
Separator	CAT 6A/6: Polyolefin cross-web CAT 5e: none
Inner Armor	Electrically continuous 0.005 in (0.13 mm) corrugated copper-clad steel armor, applied with an overlap
Dry Water Block	SAP yarn
Jacket	Black, sunlight and weather resistant polyethylene
Optional Outer Armor	Interlocked aluminum armor covered with black, sunlight and weather resistant polyethylene jacket
Characteristic Impedance Ohms	100 ± 15
Nominal Velocity of Propagation %	CAT 6A/6: 68 CAT 5e: 65
Performance Compliance	ANSI/TIA-568-C.2 ANSI/ICEA S-107-704-2012 RoHS-compliant/RoHS 2-compliant REACH-compliant

ENVIRONMENTAL SPECIFICATIONS AND TESTS

Operation	-40°F to +167°F (-40°C to +75°C)
Installation	-40°F to +140°F (-40°C to +60°C)
ANSI/ICEA S-100-685-2009 Tested down to -67°F (-55°C)	Section 7.1: -4°F (-20°C) cold bend test Section 7.2: +14°F (-10°C) cold impact test Section 7.3: -40°F (-40°C) anvil test

PART NUMBERS AND PHYSICAL CHARACTERISTICS

Category	Part Number	Product Code	AWG (mm)	Nominal Diameter in (mm)	Approx. Weight lbs/kft (kg/km)	Package
CAT 6A	04-001-A5	BBDG6A	23 (0.57)	0.39 (9.8)	72 (107)	1,000' Plywood reel
CAT 6	04-001-65	BBDG6	23 (0.57)	0.39 (9.8)	72 (107)	1,000' Plywood reel
CAT 5e	04-001-55	BBDGe	24 (0.51)	0.36 (9.1)	60 (89)	1,000' Plywood reel

Additional part numbers, constructions and packaging available upon request.

PRODUCT DESCRIPTION

BBDG is an Outside Plant (OSP) Broadband category cable. It is designed to provide an extension of the LAN beyond the premises or in situations where the NEC code requires an OSP-rated cable when it is in contact with earth, whether in a conduit or not. The cable consists of four (4) balanced twisted pairs surrounded by Superior Essex PFM™ gel that does not drip or flow, even in cell tower applications at elevated temperatures. The jacketed core is covered with dry block and a corrugated, copper-clad steel armor providing exceptional Alien Crosstalk (AXT) performance. The outer jacket is an OSP-grade black polyethylene for superior sunlight and abrasion resistance. This armored design is suitable for the following deployments: duct, underground conduit, tower, lashed aerial, direct burial or open trench.

The BBDG is available in a variety of performances including CAT 5e, CAT 6 and CAT 6A. An optional Aluminum Interlock Armor with overjacket is also available (not suitable for tower deployment).

APPLICATIONS

- CAT 6A: 10BASE-T through 10GBASE-T Ethernet;
CAT 6/5e: 10BASE-T through 1000BASE-T Ethernet
- Power over Ethernet (PoE) - IEEE 802.3af
- PoE+ - IEEE 802.3at Type 1 and 2
- ATM and token ring

FEATURES

- Transmission performance characterized to 500 MHz for CAT 6A/6 and 350 MHz for CAT 5e
- Corrugated, copper-clad steel armor
- Dry block between armor and inner jacket
- PFM gel-filled core construction
- OSP-grade black polyethylene jacket
- ColorTip® circuit identification system
- Aluminum interlock armored construction

BENEFITS

- Assures ample overhead for reliable transmission in an OSP-rated cable allowing extension of the premises LAN
- Rugged shield provides protection against EMI/RFI and provides rodent resistance
- Prevents water ingress between armor and inner cable preventing damage to equipment
- Prevents intrusion of moisture and easily wipes clean during installation
- Outside plant rated cable for years of reliable performance
- Easily identifiable conductor mates even in low-light environments
- Protects against mechanical stresses
- Installs faster and easier than EMT conduit and conventional wire



TECHNICAL GUIDELINE

Special connectivity is required for these cable designs. Refer to the "Resources" section on our site for the Technical Guideline, "OSP Broadband Installation Guidelines," for more information.

OSP Broadband Indoor/Outdoor

Halogen-Free CM/CMX

PRODUCT DESCRIPTION

BBD Indoor/Outdoor Halogen-Free is a CM/CMX rated category cable combining Outside Plant (OSP) Broadband features with an indoor application. It is designed to provide an extension of the LAN beyond the premises or in situations where the NEC code requires an OSP-rated cable and can be used inside the building according to NEC CM rated rules. The cable consists of four (4) balanced twisted pairs surrounded by Superior Essex PFM™ gel that does not drip or flow, even in cell tower applications at elevated temperatures. The jacketed core is covered with dry block and a shield providing exceptional Alien Crosstalk (AXT) performance. The outer jacket is an OSP-grade, black, halogen-free polyethylene for superior sunlight and abrasion resistance. This shielded design is suitable for the following deployments: duct, underground conduit, tower, lashed aerial, open trench or low-risk direct burial.

The OSP Broadband Indoor/Outdoor is available in a variety of performances including CAT 6 and CAT 6A. It is also available in BBDG (copper-clad steel armor) and BBDN (aluminum tape shield; not suitable for direct burial deployment) constructions.

APPLICATIONS

- CAT 6A: 10BASE-T through 10GBASE-T Ethernet;
- CAT 6: 10BASE-T through 1000BASE-T
- Power over Ethernet (PoE) - IEEE 802.3af
- PoE+ - IEEE 802.3at Type 1 and 2
- ATM and token ring

FEATURES

- | FEATURES | BENEFITS |
|---|---|
| Transmission performance characterized to 500 MHz | Assures ample overhead for reliable transmission in an OSP-rated cable allowing extension of the premises LAN |
| Corrugated, copper-clad steel armor | Rugged shield provides protection against EMI/RFI and provides rodent resistance |
| Shield/armor | Rugged shield provides protection against EMI/RFI and provides rodent resistance (BBDG only) |
| Dry block between shield/armor and inner jacket | Prevents water ingress between shield/armor and inner cable preventing damage to equipment |
| PFM gel-filled core construction | Prevents intrusion of moisture and easily wipes clean during installation |
| OSP-grade black polyethylene jacket | Outside plant rated cable for years of reliable performance |
| UL® CM listed | Allows for CM specific application |
| | Ideal for indoor/outdoor deployment |



TECHNICAL GUIDELINE

Special connectivity is required for these cable designs. Refer to the "Resources" section on our site for the Technical Guideline, "OSP Broadband Installation Guidelines," for more information.

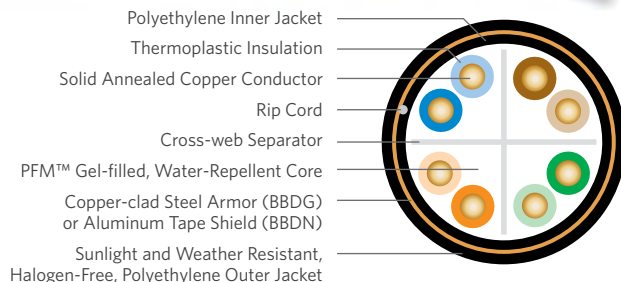
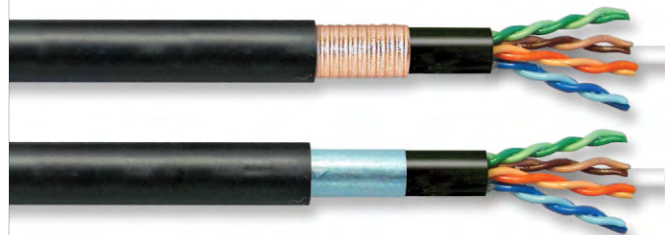

SPECIFICATIONS

Pair Count	4
Conductor	Solid annealed copper
Insulation	Polyolefin
Separator	CAT 6A/6: Polyolefin cross-web CAT 5e: none
Shield/Armor	BBDG: Electrically continuous 0.005 in (0.13 mm) corrugated copper-clad steel armor, applied with an overlap BBDN: Electrically continuous 0.008 in (0.20 mm) polymer coated smooth aluminum tape shield, applied with an overlap
Dry Water Block	BBDG: SAP yarn BBDN: SAP powder
Inner/Outer Jackets	Black, halogen-free, sunlight and weather-resistant polyethylene
Characteristic Impedance Ohms	100 ± 15
Nominal Velocity of Propagation %	CAT 6A/6: 68 CAT 5e: 65
Performance Compliance	ANSI/TIA-568-C.2 CSA C22.2 No. 214-08 UL 444 UL 1685 UL 2556 ANSI/ICEA S-107-704-2012 RoHS-compliant/RoHS 2-compliant REACH-compliant
NRTL Programs	UL, c(UL) listed CM UL, c(UL) listed CMX Outdoor Sunlight Resistant

ENVIRONMENTAL SPECIFICATIONS AND TESTS

Operation	-40°F to +167°F (-40°C to +75°C)
Installation	-40°F to +140°F (-40°C to +60°C)
ANSI/ICEA S-100-685-2009	Section 7.1: -4°F (-20°C) cold bend test Section 7.2: +14°F (-10°C) cold impact test Section 7.3: -40°F (-40°C) anvil test

PART NUMBERS AND PHYSICAL CHARACTERISTICS

Category	Part Number	Product Code	AWG (mm)	Nominal Diameter in (mm)	Approx. Weight lbs/kft (kg/km)	Package
CAT 6A	04-001-A3	BBDG6A	23 (0.57)	0.39 (9.8)	91 (136)	1,000' Plywood reel
CAT 6A	04-001-A2	BBDN6A	23 (0.57)	0.39 (9.8)	84 (125)	1,000' Plywood reel
CAT 6	04-001-63	BBDG6	23 (0.57)	0.39 (9.8)	91 (136)	1,000' Plywood reel
CAT 6	04-001-62	BBDN6	23 (0.57)	0.39 (9.8)	84 (125)	1,000' Plywood reel

Additional part numbers, constructions and packaging available upon request. UL is a registered trademark of UL LLC.

OSP Broadband Duplex

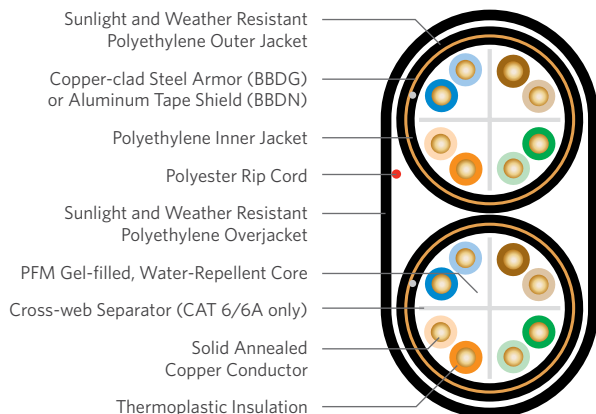
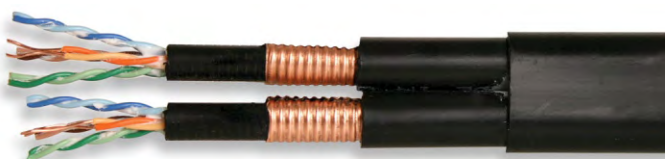

SPECIFICATIONS

Pair Count	4
Conductor	Solid annealed copper
Insulation	Polyolefin
Separator	CAT 6A/6: Polyolefin cross-web CAT 5e: none
Shield/Armor	BBDG: Electrically continuous 0.005 in (0.13 mm) corrugated copper-clad steel armor, applied with an overlap BBDN: Electrically continuous 0.008 in (0.20 mm) polymer coated smooth aluminum tape shield, applied with an overlap
Dry Water Block	BBDG: SAP yarn BBDN: SAP powder
Inner Jacket/Outer Jacket/Overjacket	Black, sunlight and weather-resistant polyethylene
Characteristic Impedance Ohms	100 ± 15
Nominal Velocity of Propagation %	CAT 6A/6: 68 CAT 5e: 65
Performance Compliance	ANSI/TIA-568-C.2 ANSI/ICEA S-107-704-2012 RoHS-compliant/RoHS 2-compliant REACH-compliant

ENVIRONMENTAL SPECIFICATIONS AND TESTS

Operation	-40°F to +167°F (-40°C to +75°C)
Installation	-40°F to +140°F (-40°C to +60°C)
ANSI/ICEA S-100-685-2009	Section 7.1: -4°F (-20°C) cold bend test Section 7.2: +14°F (-10°C) cold impact test Section 7.3: -40°F (-40°C) anvil test

PART NUMBERS AND PHYSICAL CHARACTERISTICS

Category	Part Number	Product Code	AWG (mm)	Dimensions		Approx. Weight lbs/kft (kg/km)	Package
				Minor in (mm)	Major in (mm)		
CAT 5e	04-A01-55	BBDGe	24 (0.51)	0.44 (11.2)	0.76 (19.3)	148 (221)	1,000' Plywood reel

Additional part numbers, constructions and packaging available upon request.

PRODUCT DESCRIPTION

BBD Duplex is an Outside Plant (OSP) Broadband category cable. It is designed to provide an extension of the LAN beyond the premises or in situations where the NEC code requires an OSP-rated cable when it is in contact with earth, whether in a conduit or not. The cable consists of a core of four balanced twisted pairs surrounded by Superior Essex PFM™ gel that does not drip or flow, even in cell tower applications at elevated temperatures. The jacketed core is covered with dry block and a shield providing exceptional Alien Crosstalk (AXT) performance. Two cores are then jacketed together under a sunlight and abrasion-resistant black, polyethylene overjacket including an aramid rip cord. This feature reduces installation and lease costs in tower application. This shielded design is suitable for the following deployments: duct, underground conduit, tower, lashed aerial, open trench or direct burial.

The OSP Broadband Duplex is available in a variety of performances including CAT 5e, CAT 6 and CAT 6A. It is also available in BBDG (copper-clad steel armor) and BBDN (aluminum tape shield; not suitable for direct burial deployment) constructions.

APPLICATIONS

- CAT 6A: 10BASE-T through 10GBASE-T Ethernet;
- CAT 6/5e: 10BASE-T through 1000BASE-T
- Power over Ethernet (PoE) - IEEE 802.3af
- PoE+ - IEEE 802.3at Type 1 and 2
- ATM and token ring

FEATURES

- Transmission performance characterized to 500 MHz for CAT 6A/6 and 350 MHz for CAT 5e
- Corrugated, copper-clad steel armor
- Shield/armor
- Dry block between shield/armor and inner jacket
- PFM gel-filled core construction
- OSP-grade black polyethylene jacket
- ColorTip™ circuit identification system

BENEFITS

- Assures ample overhead for reliable transmission in an OSP-rated cable allowing extension of the premises LAN
- Rugged shield provides protection against EMI/RFI and provides rodent resistance
- Rugged shield provides protection against EMI/RFI and provides rodent resistance (BBDG only)
- Prevents water ingress between shield in inner cable preventing damage to equipment
- Prevents intrusion of moisture and easily wipes clean during installation
- Outside plant rated cable for years of reliable performance
- Easily identifiable conductor mates even in low-light environments



TECHNICAL GUIDELINE

Special connectivity is required for these cable designs. Refer to the "Resources" section on our site for the Technical Guideline, "OSP Broadband Installation Guidelines," for more information.

MEGAPIC® OSP Broadband Backbone Category 5

PRODUCT DESCRIPTION

MEGAPIC® Category 5 cables provide an extension of the LAN beyond the premises. These cables are ideal for direct burial, underground and lashed aerial applications.

APPLICATIONS

- 10BASE-T
- ATM and token ring
- ADSL, VDSL, VDSL+
- MEGAPIC-NF: Higher pair count shielded distribution cable for use in lashed aerial, direct burial and duct installations
- MEGAPIC-GF: Higher pair count shielded distribution cable for use in lashed aerial, direct burial and installations in high risk areas where additional mechanical protection is required

FEATURES

- Transmission performance characterized to 100 MHz
- Metallic shield tapes
- Fully filled constructions

BENEFITS

- Extends the LAN to the entire campus
- Facilitates grounding according to NEC requirements
- Helps prevent intrusion of moisture

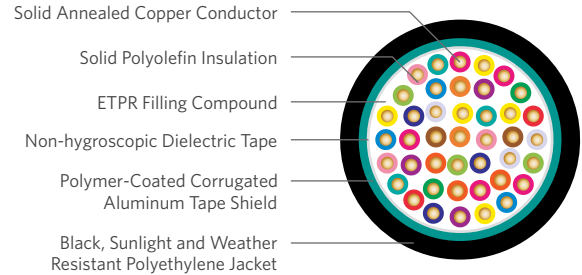

SPECIFICATIONS

Pair Count	Available in 25-pair, 50-pair and 100-pair
Conductor	Solid annealed copper
AWG (mm)	24 (0.51)
Filling Compound	80°C ETPR (extended thermoplastic rubber)
Core Wrap	Non-hygroscopic dielectric tape
Shield	MEGAPIC-NF: Electrically continuous 0.008 in (0.20 mm) polymer coated corrugated aluminum tape, applied with an overlap and shield interface is flooded MEGAPIC-GF: ASP sheath consisting of an inner electrically continuous 0.008 in (0.20 mm) polymer coated corrugated aluminum tape applied with a gap and covered with an outer electrically continuous 0.006 in (0.15 mm) polymer coated corrugated steel tape applied with an overlap; interfaces of both tapes are flooded
Jacket	Black, sunlight and weather resistant polyethylene
Characteristic Impedance Ohms	100 ± 15
Nominal Velocity of Propagation %	58
Performance Compliance	ANSI/TIA-568-C.2 ANSI/ICEA S-99-689-2012 RoHS-compliant/RoHS 2-compliant

PART NUMBERS AND PHYSICAL CHARACTERISTICS

Part Number	Name	Pair Count	Nominal Diameter in (mm)	Approx. Weight lbs/kft (kg/km)	Standard Length ft (m)	Package
04-097-31	MEGAPIC-NF	25	0.68 (17.3)	208 (310)	5,000 (1,524)	Wood reel
04-100-31	MEGAPIC-NF	50	0.91 (23.1)	388 (578)	5,000 (1,524)	Wood reel
04-104-31	MEGAPIC-NF	100	1.22 (31.0)	701 (1,044)	1,000 (305)	Wood reel
04-097-37	MEGAPIC-GF	25	0.71 (18.0)	258 (385)	5,000 (1,524)	Wood reel
04-100-37	MEGAPIC-GF	50	0.91 (24.4)	436 (650)	5,000 (1,524)	Wood reel
04-104-37	MEGAPIC-GF	100	1.26 (23.1)	807 (1,202)	1,000 (305)	Wood reel



TECHNICAL GUIDELINE

Special connectivity is required for these cable designs. Refer to the "Resources" section on our site for the Technical Guideline, "OSP Broadband Installation Guidelines," for more information.

Category 3

CMR/CMP 2-Pair - 400-Pair

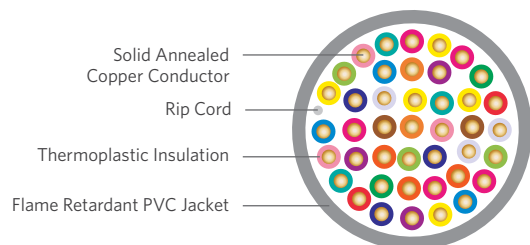

SPECIFICATIONS

Pair Count	Available in 2-pair up to 400-pair
Conductor	Solid annealed copper
AWG (mm)	24 (0.51)
Insulation	Thermoplastic
Jacket	CMR: Flame retardant (FR) PVC CMP: FR, low smoke PVC
Characteristic Impedance Ohms	100 ± 15
Performance Compliance	UL® 444 CSA C22.2 No. 214-08 UL 1666 NFPA 262 ANSI/TIA-568-C.2 ANSI/ICEA S-90-661-2012 Article 800, NEC (NFPA 70) RoHS-compliant/RoHS 2-compliant
NRTL Programs	UL, c(UL) Listed CMR UL, c(UL) Listed CMP

PRODUCT DESCRIPTION

The ideal choice for LAN transmission with specified bandwidth up to 16 MHz. These cables are used for voice and data communications and can handle application bandwidths up to 16 MHz. Other uses for these cables include indoor use on customer premises for the interconnection of telephone key systems, PBX and intercom systems. Product is offered for both plenum (CMP) and riser (CMR) applications.

APPLICATIONS

- 4 Mbps token ring (IEEE 802.5)
- Analog voice
- 10 Mbps 10BASE-T Ethernet (IEEE 802.3)
- Telecommunications closet wiring

FEATURES

- CMR and CMP constructions use extremely flexible, FR-PVC jacket
- Jacket color options
- Band marked or striped insulated conductors

BENEFITS

- Easier and less time-consuming installations, no kinking of outer jacket
- Improves backbone sub-system identification, reduces labor and mistakes
- Reduces termination time and improves circuit identification

PART NUMBERS AND PHYSICAL CHARACTERISTICS

Listing	Part Number	Pair Count	Jacket Color	Nominal Diameter in (mm)	Approx. Weight lbs/kft (kg/km)	Package	Packages per Pallet
CMR	18-042-13	2	Beige	0.12 (3.1)	9 (13)	1,000' POP™ box	45
CMR	18-042-33	2	Gray	0.12 (3.1)	9 (13)	1,000' POP box	45
CMR	18-141-13	3	Beige	0.14 (3.5)	12 (18)	1,000' POP box	45
CMR	18-141-33	3	Gray	0.14 (3.5)	12 (18)	1,000' POP box	45
CMR	18-241-13	4	Beige	0.16 (3.9)	15 (22)	1,000' POP box	45
CMR	18-241-23	4	Blue	0.16 (3.9)	15 (22)	1,000' POP box	45
CMR	18-241-33	4	Gray	0.16 (3.9)	15 (22)	1,000' POP box	45
CMR	18-241-43	4	White	0.16 (3.9)	15 (22)	1,000' POP box	45
CMR	18-341-13	6	Beige	0.19 (4.8)	22 (32)	1,000' POP box	45
CMR	18-341-33	6	Gray	0.19 (4.8)	22 (32)	1,000' POP box	45
CMR	18-872-13	12	Beige	0.27 (6.9)	47 (71)	1,000' Plywood reel	16
CMR	18-872-33	12	Gray	0.27 (6.9)	47 (71)	1,000' Plywood reel	16
CMR	18-475-13	25	Beige	0.38 (9.6)	92 (137)	1,000' Plywood reel	12
CMR	18-499-13	25	Beige	0.38 (9.6)	92 (137)	Cut to length	1
CMR	18-475-33	25	Gray	0.38 (9.6)	92 (137)	1,000' Plywood reel	12
CMR	18-499-33	25	Gray	0.38 (9.6)	92 (137)	Cut to length	1
CMR	18-579-13	50	Beige	0.56 (14.2)	187 (279)	1,000' Plywood reel	4
CMR	18-599-13	50	Beige	0.56 (14.2)	187 (279)	Cut to length	1
CMR	18-579-33	50	Gray	0.56 (14.2)	187 (279)	1,000' Plywood reel	4
CMR	18-599-33	50	Gray	0.56 (14.2)	187 (279)	Cut to length	1
CMR	18-789-13	100	Beige	0.74 (18.7)	361 (538)	Cut to length	1
CMR	18-789-33	100	Gray	0.74 (18.7)	361 (538)	Cut to length	1
CMR	18-D99-33	150	Gray	0.92 (23.4)	541 (807)	Cut to length	1
CMR	18-A99-33	200	Gray	1.05 (26.6)	711 (1,060)	Cut to length	1
CMR	18-B99-33	300	Gray	1.27 (32.2)	1,049 (1,564)	Cut to length	1
CMR	18-C99-33	400	Gray	1.45 (36.9)	1,386 (2,067)	Cut to length	1
CMP	18-041-36	2	Gray	0.13 (3.3)	10 (15)	1,000' POP box	45
CMP	18-141-36	3	Gray	0.15 (3.7)	14 (20)	1,000' POP box	45
CMP	18-241-26	4	Blue	0.16 (4.2)	17 (26)	1,000' POP box	45
CMP	18-241-36	4	Gray	0.16 (4.2)	17 (26)	1,000' POP box	45
CMP	18-241-46	4	White	0.16 (4.2)	17 (26)	1,000' POP box	45
CMP	18-241-56	4	Green	0.16 (4.2)	17 (26)	1,000' POP box	45
CMP	18-341-36	6	Gray	0.20 (5.0)	24 (37)	1,000' POP box	45
CMP	18-341-46	6	White	0.20 (5.0)	24 (37)	1,000' POP box	45
CMP	18-872-46	12	White	0.30 (7.6)	49 (73)	1,000' Plywood reel	16
CMP	18-475-36	25	Gray	0.43 (10.9)	114 (171)	1,000' Plywood reel	12
CMP	18-499-36	25	Gray	0.43 (10.9)	114 (171)	Cut to length	1
CMP	18-475-46	25	White	0.43 (10.9)	114 (171)	1,000' Plywood reel	12
CMP	18-499-46	25	White	0.43 (10.9)	114 (171)	Cut to length	1
CMP	18-579-36	50	Gray	0.60 (15.3)	227 (339)	1,000' Plywood reel	4
CMP	18-599-36	50	Gray	0.60 (15.3)	227 (339)	Cut to length	1
CMP	18-799-36	100	Gray	0.84 (21.3)	446 (665)	Cut to length	1
CMP	18-799-46	100	White	0.84 (21.3)	446 (666)	Cut to length	1
CMP	18-A99-36	200	Gray	1.16 (29.4)	850 (1,268)	Cut to length	1
CMP	18-B99-36	300	Gray	1.44 (36.7)	1,315 (1,960)	Cut to length	1
CMP	18-B99-46	300	White	1.44 (36.7)	1,315 (1,961)	Cut to length	1
CMP	18-C99-36	400	Gray	1.64 (41.7)	1,720 (2,565)	Cut to length	1

UL is a registered trademark of UL LLC.

Category 3 Station Wire

CMR/CMX Outdoor

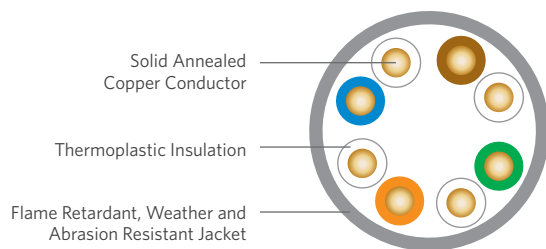
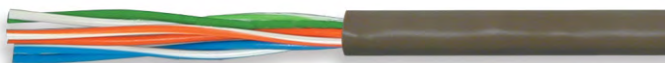

SPECIFICATIONS

Pair Count	Available in 2-pair to 12-pair
Conductor	Solid annealed copper
AWG (mm)	Available in 22 (0.64) and 24 (0.51)
Insulation	Thermoplastic
Jacket	Tough, flame retardant, weather and abrasion resistant PVC
Performance Compliance	UL 444 CSA C22.2 No. 214-08 UL 1666 Extreme CMR/CMX Outdoor Includes ICEA -40°C Anvil Test ANSI/TIA-568-C.2 ANSI/ICEA S-100-685 Article 800, NEC (NFPA 70) RoHS-compliant/RoHS 2-compliant
NRTL Programs	UL, c(UL) Listed CMR UL, c(UL) Listed CMX Outdoor

ENVIRONMENTAL SPECIFICATIONS AND TESTS

Operation	CMR/CMX Outdoor: -4°F to +149°F (-20°C to +65°C) Extreme CMR/CMX Outdoor: -40°F to +167°F (-40°C to +75°C)
Installation	+14°F to +140°F (-10°C to +60°C)
ANSI/ICEA S-100-685-2009	CMR/CMX Outdoor: Section 7.1: -4°F (-20°C) cold bend test Section 7.2: +14°F (-10°C) cold impact test Extreme CMR/CMX Outdoor: Section 7.1: -4°F (-20°C) cold bend test Section 7.2: +14°F (-10°C) cold impact test Section 7.3: -40°F (-40°C) anvil test

PRODUCT DESCRIPTION

The Superior Essex Category 3 Station Wires CMR/CMX Outdoor cable is specifically designed for outdoor, indoor, or a combination of both applications. CMX Outdoor cables extend the run between the Network Interface Unit and the point of entry into the interior of a residence or a premise. Their twisted pair construction is small and lightweight.

These Category 3 (CAT 3) cables have been tested and listed as UL® 444 Outdoor compliant, requiring the cable to resist 300 hours of UV and heat. In addition, the CMR listing allows the cable to be used in riser spaces per UL 1666, eliminating the need to transition to fire resistant cables. UV-blocking compounds also aid in protecting the cable from light.

Two levels of Outdoor Protection are available: CMR/CMX Outdoor and Extreme CMR/CMX Outdoor which meets the -40°C anvil test.

APPLICATIONS

- 4 Mbps token ring (IEEE 802.5)
- Analog voice
- 10 Mbps 10BASE-T Ethernet (IEEE 802.3)
- Telecommunications closet wiring

FEATURES

- Extremely flexible, FR-PVC jacket
- CMR/CMX Outdoor combination
- Extreme CMR/CMX Outdoor combination
- Beige, gray and ivory jacket colors
- Various conductor colors

BENEFITS

- Easier and less time-consuming installations, no kinking of outer jacket
- Indoor/outdoor use
- Indoor/outdoor use with extreme cold temperature feature
- Enhances appearance on outdoor siding
- Customer preference



CAUTIONARY INFORMATION

- Do not use as a substitute for Outside Plant (OSP) cables.
- Do not use in conduit or direct burial which can flood. These cables are not designed for extended exposure to water.

PART NUMBERS AND PHYSICAL CHARACTERISTICS

Listing	Part Number	Pair Count	AWG (mm)	Jacket Color	Nominal Diameter in (mm)	Approx. Weight lbs/kft (kg/km)	Package	Packages per Pallet
CMR/CMX Outdoor	12-202-37 ¹	2	22 (0.64)	Beige	0.18 (4.7)	17 (26)	1,000' POP™ box	45
CMR/CMX Outdoor	12-203-37 ¹	3	22 (0.64)	Beige	0.22 (5.5)	24 (36)	1,000' POP box	45
CMR/CMX Outdoor	12-204-37 ¹	4	22 (0.64)	Beige	0.22 (5.6)	29 (43)	1,000' POP box	36
CMR/CMX Outdoor	12-214-37 ¹	4	22 (0.64)	Gray	0.22 (5.6)	29 (43)	1,000' POP box	36
CMR/CMX Outdoor	12-402-37 ¹	2	24 (0.51)	Beige	0.15 (3.7)	12 (18)	1,000' POP box	45
CMR/CMX Outdoor	12-403-37 ¹	3	24 (0.51)	Beige	0.17 (4.3)	16 (24)	1,000' POP box	45
CMR/CMX Outdoor	12-404-37 ¹	4	24 (0.51)	Beige	0.20 (5.0)	20 (30)	1,000' POP box	45
CMR/CMX Outdoor	12-212-32 ²	2	22 (0.64)	Beige	0.18 (4.7)	17 (26)	1,000' POP box	45
CMR/CMX Outdoor	12-213-32 ²	3	22 (0.64)	Beige	0.22 (5.5)	24 (36)	1,000' POP box	45
CMR/CMX Outdoor	12-206-32 ²	4	22 (0.64)	Beige	0.22 (5.6)	29 (43)	1,000' POP box	45
CMR/CMX Outdoor	12-412-32 ²	2	24 (0.51)	Beige	0.15 (3.7)	12 (18)	1,000' POP box	45
CMR/CMX Outdoor	12-414-32 ²	4	24 (0.51)	Beige	0.20 (5.0)	20 (30)	1,000' POP box	45
Extreme CMR/CMX Outdoor	11-002-89 ³	2	22 (0.64)	Gray	0.17 (4.3)	19 (29)	125' Coil pack	128
Extreme CMR/CMX Outdoor	11-002-88 ³	2	22 (0.64)	Ivory	0.17 (4.3)	19 (29)	125' Coil pack	256
Extreme CMR/CMX Outdoor	11-002-87 ³	2	22 (0.64)	Ivory	0.17 (4.3)	19 (29)	1,000' POP box	45
Extreme CMR/CMX Outdoor	11-003-12 ³	2	24 (0.51)	Ivory	0.15 (3.7)	12 (18)	1,000' POP box	45
Extreme CMR/CMX Outdoor	11-003-13 ³	2	24 (0.51)	Gray	0.15 (3.7)	12 (18)	1,000' POP box	45
Extreme CMR/CMX Outdoor	11-003-91 ³	4	24 (0.51)	White	0.20 (5.0)	20 (30)	1,000' POP box	45
Extreme CMR/CMX Outdoor	11-003-92 ³	4	24 (0.51)	Ivory	0.20 (5.0)	20 (30)	1,000' POP box	45
Extreme CMR/CMX Outdoor	12-303-62 ^{3*}	6	24 (0.51)	Gray	0.21 (5.3)	27 (41)	1,000' POP box	36
Extreme CMR/CMX Outdoor	12-805-62 ^{3*}	12	24 (0.51)	Gray	0.28 (7.2)	49 (74)	1,000' Plywood reel	16
Extreme CMR/CMX Outdoor	12-414-52 ⁴	3	22 (0.64)	Beige	0.22 (5.5)	24 (36)	1,000' POP box	45
Extreme CMR/CMX Outdoor	12-415-52 ⁴	2	24 (0.51)	Beige	0.15 (3.7)	12 (18)	1,000' POP box	45
Extreme CMR/CMX Outdoor	12-416-52 ⁴	3	24 (0.51)	Beige	0.17 (4.3)	16 (24)	1,000' POP box	45
Extreme CMR/CMX Outdoor	12-417-52 ⁴	4	24 (0.51)	Beige	0.20 (5.0)	20 (30)	1,000' POP box	45

¹These products use a tubed jacket design with the following color code: Blue/White, Orange/White, Green/White, Brown/White.

²These products use a tubed jacket design with the following color code: Red/Green, Yellow/Black, Blue/White, Orange/Brown.

³These products use a tubed jacket design with the following color code: Blue/White, Orange/White, Green/White and Brown/White. 2-pair 22 AWG products are a pressure extruded design.

^{3*}Copper conductors are PVC insulated.

⁴These products use a tubed jacket design with the following color code: Red/Green, Yellow/Black, Blue/White, Orange/Brown.

UL is a registered trademark of UL LLC.

ARMM Series

CMR

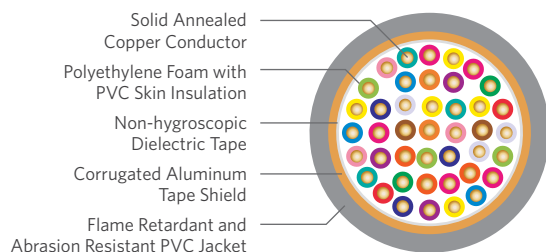

Solid Annealed
Copper Conductor

Polyethylene Foam with
PVC Skin Insulation

Non-hygroscopic
Dielectric Tape

Corrugated Aluminum
Tape Shield

Flame Retardant and
Abrasion Resistant PVC Jacket

SPECIFICATIONS

Pair Count	Available in 25-pair up to 2,400-pair
Conductor	Solid annealed copper
AWG (mm)	24 (0.51)
Insulation	Polyethylene foam with PVC skin
Shield	Corrugated 8 mil aluminum tape
Jacket	Gray, flame retardant and abrasion resistant PVC
Characteristic Impedance Ohms	100 ± 15
Nominal Velocity of Propagation %	71
Performance Compliance	UL® 444 CSA C22.2 No. 214-08 UL 1666 Telcordia® GR-111 ANSI/TIA-568-C.2 Article 800, NEC (NFPA 70) RoHS-compliant/RoHS 2-compliant
NRTL Programs	UL, c(UL) Listed CMR

PRODUCT DESCRIPTION

The ARMM Series cables are intended for vertical and horizontal distribution in commercial buildings and meet Category 3 electrical specifications. This includes all applications except those in plenums. These cables have a fire-retardant PVC jacket and have been listed as CMR rated, in accordance with the National Electrical Code. ARMM cables are color coded to match standard Outside Plant (OSP) cable designs. The cable consists of solid soft bare copper that's insulated with foam polyethylene and a skin of PVC. Cores through 900-pair are color coded to match the standard PIC color code. Cables 1,200-pair and larger have a "Mirror Image" color code. Spare pairs are offered in cables of 1,200-pair and larger. An alvyn sheath is applied overall. The alvyn sheath consists of a 8 mil aluminum tape applied longitudinally and bonded to a gray PVC outer jacket.

APPLICATIONS

- Riser shafts without using conduits
- 4 Mbps token ring
- Analog voice
- 10BASE-T Ethernet

FEATURES

- CMR rating
- Shielded design

BENEFITS

- Meets NFPA code for riser applications
- Provides EMI/RFI shielding

PART NUMBERS AND PHYSICAL CHARACTERISTICS

Listing	Part Number	Pair Count	Nominal Diameter in (mm)	Approx. Weight lbs/kft (kg/km)	Package
CMR	02-097-03	25	0.51 (13)	146 (218)	Cut to length
CMR	02-100-03	50	0.64 (16)	241 (360)	Cut to length
CMR	02-104-03	100	0.89 (23)	447 (667)	Cut to length
CMR	02-106-03	150	1.02 (26)	618 (922)	Cut to length
CMR	02-108-03	200	1.14 (29)	788 (1,175)	Cut to length
CMR	02-110-03	300	1.35 (34)	1,129 (1,684)	Cut to length
CMR	02-112-03	400	1.53 (39)	1,427 (2,128)	Cut to length
CMR	02-116-03	600	1.85 (47)	2,106 (3,140)	Cut to length
CMR	02-118-03	900	2.20 (56)	3,060 (4,563)	Cut to length
CMR	02-120-03	1,200	2.50 (63)	4,008 (5,977)	Cut to length
CMR	02-121-03	1,500	2.80 (71)	5,013 (7,476)	Cut to length
CMR	02-124-03	1,800	3.05 (77)	5,958 (8,884)	Cut to length
CMR	02-125-03	2,100	3.30 (84)	6,908 (10,302)	Cut to length
CMR	02-126-03	2,400	3.52 (89)	7,852 (11,709)	Cut to length

UL is a registered trademark of UL LLC.



Save Time, Save Money

Superior Essex Offers Multiple Product Features
To Make Your Next Cable Installation Run More Smoothly



CABLEID® ALPHA NUMERIC CODING

- Unique 4-character code printed every 2 feet on the cable jacket for each 1000-foot box and reel of copper data cable
- Both ends of each cable run are easily identifiable without the need to separately label or tone the cable
- Reduces installation time and cost for initial installations and for moves, adds and changes



COLORTIP® CIRCUIT IDENTIFICATION

- Circumferentially colors 100% of the conductor for easily identifiable tip and ring mates
- Distinct colors reduces termination time and errors, even in low light environments
- Permanent, heavy-metal-free color that doesn't rub or wear off



QUICKCOUNT® FEET/METERS MARKING

- Jacket marking in feet and meters
- Provides remaining length of cable on reel removing the guesswork for cable installers
- Saves time and cost during installation



BRAKEBOX® PAYOUT CONTROL

The BrakeBox packaging is a true advantage for installers who are pulling cable in multiple locations.

- Stacks, travels and protects cable better than an open reel
- Two resistance mechanisms on both sides of the box, each with three variable resistance settings
- Controls back-tension to prevent over-spin and tangling

Coax RG-6, Quad Shield

CM/CATV, CMR/CATVR, CMP/CL2P, Interlock Armored CMR

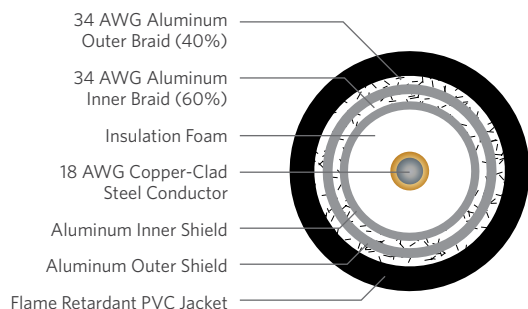

SPECIFICATIONS

Conductor	Copper clad steel
AWG (mm)	18 (1.02)
Inner Shield	CM/CMR: 2.8 mil aluminum foil CMP: Aluminum/polyester/aluminum
Inner Braid	34 AWG aluminum (60%)
Outer Shield	CM/CMR: 1.8 mil aluminum foil CMP: Aluminum/polyester/aluminum
Outer Braid	34 AWG aluminum (40%)
Insulation	CM/CMR: Polyethylene CMP: Foamed fluoropolymer
Jacket	PVC (polyvinyl chloride)
Nominal Impedance Ohms	75
Nominal Velocity of Propagation %	CM/CMR: 85 CMP: 83
Performance Compliance	UL® 13 UL 444 CSA C22.2 No. 214-08 UL 1685 UL 1666 NFPA 262 RoHS-compliant/RoHS 2-compliant
NRTL Programs	UL, c(UL) Listed CM UL, c(UL) Listed CMR UL, c(UL) Listed CMP

UL is a registered trademark of UL LLC.

PRODUCT DESCRIPTION

Superior Essex RG-6, Quad Shield coaxial cables are designed to support technologies such as extended bandwidth satellite service, high definition TV signals, CATV and two-way cable modems. Superior Essex maintains tight tolerances to cable diameter requirements of leading connector manufacturers. Also available as interlock armored coax.

APPLICATIONS

- HDTV, CATV and CCTV
- Two-way cable modems
- Extended bandwidth satellite service

FEATURES

- RG-6, Quad Shield Coaxial cable with bandwidth that exceeds 3 GHz
- Tight foamed polyethylene (CM and CMR) or fluoropolymer (CMP) insulating skin bonds around center conductor
- Black and white jacket colors available for CM and CMR versions
- Interlock armored version

BENEFITS

- "Future-proofing" the installation. Supports extended bandwidth satellite service and high-definition TV signals
- Exhibits better transmission characteristics
- Helps differentiate incoming service versus internal cabling infrastructure
- Provides additional mechanical and fire safety protection

PART NUMBERS AND PHYSICAL CHARACTERISTICS

Listing	Part Number	Component Jacket Color	Nominal Diameter			Approx. Weight lbs/kft (kg/km)	Package	Packages per Pallet
			Overall in (mm)	Dielectric in (mm)	Shield in (mm)			
CM/CATV	78-147-91	White	0.30 (7.5)	0.18 (4.6)	0.19 (4.8)	29 (43)	1,000' Plywood reel	27
CM/CATV	79-147-91	Black	0.30 (7.5)	0.18 (4.6)	0.19 (4.8)	29 (43)	1,000' Plywood reel	27
CM/CATV	78-147-9P	White	0.30 (7.5)	0.18 (4.6)	0.19 (4.8)	29 (43)	1,000' POP™ box	20
CM/CATV	79-147-9P	Black	0.30 (7.5)	0.18 (4.6)	0.19 (4.8)	29 (43)	1,000' POP box	20
CMR/CATVR	78-148-91	White	0.30 (7.5)	0.18 (4.6)	0.19 (4.8)	30 (45)	1,000' Plywood reel	27
CMR/CATVR	79-148-91	Black	0.30 (7.5)	0.18 (4.6)	0.19 (4.8)	30 (45)	1,000' Plywood reel	27
CMP/CL2P	78-14C-91	White	0.26 (6.7)	0.17 (4.3)	0.23 (5.9)	30 (45)	1,000' Plywood reel	25
Aluminum Interlock Armored (no outer jacket)								
CMR	KC-919-45	White	0.53 (13.5)	0.18 (4.6)	0.19 (4.8)	73 (109)	1,000' Plywood reel	1
CMR	KC-919-E5	Black	0.53 (13.5)	0.18 (4.6)	0.19 (4.8)	73 (109)	1,000' Plywood reel	1

ELECTRICAL SPECIFICATIONS

Frequency MHz	CM/CATV and CMR/CATVR Attenuation Maximum		CM/CATV and CMR/CATVR SRL, Typical dB
	Specification dB/100 ft (dB/100 m)	Typical dB/100 ft (dB/100 m)	
55	1.6 (5.3)	1.3 (4.8)	20
211	3.1 (10.1)	2.7 (9.0)	20
270	3.5 (11.5)	3.1 (10.3)	20
300	3.7 (12.1)	3.4 (11.0)	20
330	3.9 (12.8)	3.6 (11.7)	20
400	4.3 (14.1)	4.0 (13.1)	20
450	4.6 (15.0)	4.1 (13.6)	20
550	5.1 (16.7)	4.7 (15.3)	20
750	6.0 (19.7)	5.2 (17.1)	20
870	6.5 (21.3)	6.0 (19.7)	20
1000	7.0 (23.0)	6.5 (21.2)	20
1200		7.2 (23.7)	18
1450		8.0 (26.1)	18
1800		8.8 (29.0)	18
2200		9.8 (32.1)	18
2600		10.7 (35.2)	15
3000		11.7 (38.3)	15

Frequency MHz	CMP/CL2P Attenuation, Nominal dB/100 ft (dB/100 m)	CMP/CL2P SRL, Nominal dB
1	0.3 (1.0)	20
10	0.7 (2.3)	20
50	1.5 (4.9)	20
100	2.1 (6.9)	20
200	3.1 (10.2)	20
500	5.0 (16.4)	20
700	6.4 (21.0)	20
1000	7.3 (23.9)	20
2300	12.2 (40.0)	20
3000	14.3 (46.9)	20

Coax RG-6, 80% Shield

CMP/CL2P

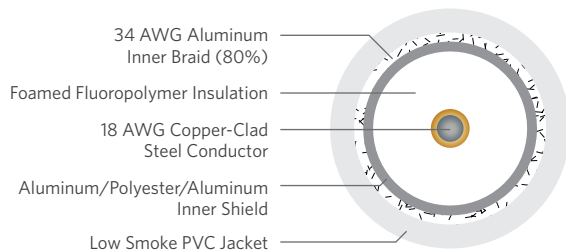

PRODUCT DESCRIPTION

The Superior Essex RG-6, 80% Shield coaxial plenum cable is designed to support analog, digital and high-bandwidth technologies. Superior Essex maintains tight tolerances to cable diameter requirements of leading connector manufacturers.

APPLICATIONS

- HDTV, CATV and CCTV
- Two-way cable modems
- Extended bandwidth satellite service

FEATURES

- RG-6, 80% Shield coaxial cable with bandwidth that exceeds 2.2 GHz
- Tight foamed fluoropolymer insulating skin bonds around center conductor
- Natural white jacket color

BENEFITS

- "Future-proofing" the installation
- Exhibits better transmission characteristics
- Helps differentiate incoming service versus internal cabling infrastructure

SPECIFICATIONS

Conductor	Solid bare copper clad steel
AWG (mm)	18 (1.02)
Inner Braid	34 AWG aluminum (80%)
Inner Shield	Aluminum/polyester/aluminum
Jacket	Low smoke PVC
Nominal Impedance Ohms	75
Nominal Velocity of Propagation %	85
Performance Compliance	UL® 13 UL 444 NFPA 262 RoHS-compliant/RoHS 2-compliant
NRTL Programs	UL, c(UL) Listed CMP

UL is a registered trademark of UL LLC.

PART NUMBERS AND PHYSICAL CHARACTERISTICS

Listing	Part Number	Jacket Color	Nominal Diameter		Approx. Weight lbs/kft (kg/km)	Package	Packages per Pallet
			Inner Shield in (mm)	Overall in (mm)			
CMP/CL2P	78-16C-91	White	0.17 (4.4)	0.23 (5.9)	21 (13.5)	1,000' Plywood reel	27

ELECTRICAL SPECIFICATIONS

Frequency MHz	Attenuation, Nominal, Specification dB/100 ft (dB/100 m)	SRL, Nominal dB
1	0.3 (1.0)	20
10	0.7 (2.2)	20
50	1.5 (4.9)	20
100	2.1 (6.9)	20
200	3.1 (10.2)	20
500	5.0 (16.4)	20
700	6.4 (21.0)	20
1000	7.3 (23.9)	20
1450	8.6 (28.1)	20
1800	9.7 (31.9)	20
2300	12.2 (40.0)	20
3000	14.2 (46.6)	20

Coax RG-6, Tri-Shield 70% CM/CMR

PRODUCT DESCRIPTION

Superior Essex RG-6 Tri-Shield 70% braided coaxial cables exceed the requirements specified in ANSI/SCTE 74-2003. The shielding consists of an inner aluminum/polyester foil bonded to the insulation, an aluminum 34 AWG braid, and an outer aluminum/polyester foil. This RG-6 Tri-Shield will support such technologies as extended bandwidth satellite service, high definition TV signals, CATV and two-way cable modems.

APPLICATIONS

- HDTV
- Extended bandwidth satellite service

FEATURES

- RG-6 (18 AWG copper clad steel center conductor)
- Available in CM Outdoor (60°C rated jacket) or CMR (75°C rated jacket)
- Tri-Shield consists of inner aluminum/polyester foil, aluminum braid, outer aluminum/polyester foil
- Bonded inner foil
- 100% coverage over the 70% (34 AWG aluminum) braiding
- Reel-in-a-Box design
- White or black outer jacket (UV rated for exterior use)

BENEFITS

- Standard and popular size
- Indoor/outdoor use
- Added shielding for higher service levels
- Stops moisture
- Offers better shielding protection and stops interference
- Water-resistant package is easy to carry and store
- Jacket color helps differentiate incoming versus internal cabling

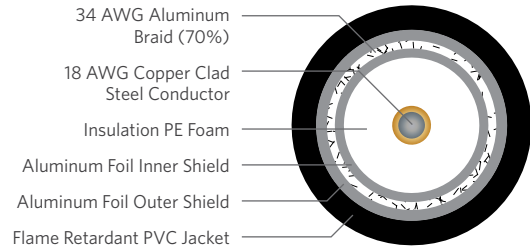

SPECIFICATIONS

Conductor	Copper clad steel
AWG (mm)	18 (1.0)
Inner Shield	Aluminum/polyester foil (100%)
Center Shield	34 AWG aluminum braid (70%)
Outer Shield	Aluminum/polyester foil (100%)
Nominal Impedance Ohms	75
Jacket	Flame retardant PVC
Performance Compliance	UL 444 CSA C22.2 No. 214-08 UL 1685 ANSI/SCTE 74-2003 Appropriate ASTM standards RoHS-compliant
NRTL Programs	UL, c(UL) Listed CM UL, c(UL) Listed CMR

PART NUMBERS AND PHYSICAL CHARACTERISTICS

Listing	Part Number	Jacket Color	Nominal Diameter in (mm)	Approx. Weight lbs/kft (kg/km)	Package	Packages per Pallet
CM	78-11A-9R	White	0.28 (7.1)	32 (48)	1,000' Reel-in-a-Box	27
CM	79-11A-9R	Black	0.28 (7.1)	32 (48)	1,000' Reel-in-a-Box	27
CMR	79-11B-9R	Black	0.28 (7.1)	32 (48)	1,000' Reel-in-a-Box	27

ELECTRICAL SPECIFICATIONS

Frequency MHz	Maximum Attenuation @ 68°F (20°C) dB/100 m
55	5.2
211	10.0
250	10.8
270	11.0
330	12.2
350	12.6
450	14.4
500	15.3
550	16.1
600	16.7
750	18.5
870	20.0
1000	21.5

Coax RG-6, 60% Shield

CM

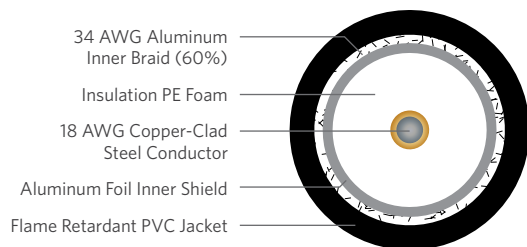

34 AWG Aluminum Inner Braid (60%)
Insulation PE Foam
18 AWG Copper-Clad Steel Conductor
Aluminum Foil Inner Shield
Flame Retardant PVC Jacket

SPECIFICATIONS

Conductor	Copper clad steel
AWG (mm)	18 (1.02)
Inner Braid	34 AWG aluminum (60%)
Inner Shield	2.8 mil aluminum foil
Jacket	Flame retardant PVC
Nominal Impedance Ohms	75
Nominal Velocity of Propagation %	85
Performance Compliance	UL® 444 UL 1685 ANSI/SCTE 74-2003 RoHS-compliant/RoHS 2-compliant
NRTL Programs	UL, c(UL) Listed CM

UL is a registered trademark of UL LLC.

PRODUCT DESCRIPTION

Superior Essex RG-6, 60% Shield coaxial cables are designed to support analog, digital and high-bandwidth technologies. Superior Essex maintains tight tolerances to cable diameter requirements of leading connector manufacturers.

APPLICATIONS

- HDTV, CATV and CCTV
- Two-way cable modems
- Extended bandwidth satellite service

FEATURES

- RG-6, 60% Shield Coaxial cable with bandwidth that exceeds 2.2 GHz
- Tight foamed polyethylene insulating skin bonds around center conductor
- Black and white jacket colors available

BENEFITS

- "Future-proofing" the installation
- Exhibits better transmission characteristics
- Helps differentiate incoming service versus internal cabling infrastructure

PART NUMBERS AND PHYSICAL CHARACTERISTICS

Listing	Part Number	Jacket Color	Nominal Diameter		Approx. Weight lbs/kft (kg/km)	Package	Packages per Pallet
			Inner Shield in (mm)	Overall in (mm)			
CM	78-107-9P	White	0.18 (4.6)	0.28 (7.1)	21 (13.5)	1,000' POP™ box	20
CM	79-107-9P	Black	0.18 (4.6)	0.28 (7.1)	21 (13.5)	1,000' POP box	20
CM	78-107-91	White	0.18 (4.6)	0.28 (7.1)	21 (13.5)	1,000' Plywood reel	27
CM	79-107-91	Black	0.18 (4.6)	0.28 (7.1)	21 (13.5)	1,000' Plywood reel	27

ELECTRICAL SPECIFICATIONS

Frequency MHz	Attenuation, Nominal, Specification dB/100 ft (dB/100 m)	SRL, Nominal dB
55	6.04 (1.84)	20
211	11.6 (3.55)	20
250	12.6 (3.85)	20
270	13.1 (4.00)	20
330	14.5 (4.41)	20
350	14.9 (4.54)	20
450	16.9 (5.14)	20
500	17.7 (5.41)	20
550	18.6 (5.66)	20
600	19.4 (5.91)	20
750	21.6 (6.59)	20
870	23.2 (7.08)	20
1000	24.8 (7.57)	20
1200	27.1 (8.27)	17
1450	29.7 (9.05)	17
1800	32.9 (10.0)	17
2250	36.6 (11.2)	17

What is an Environmental Product Declaration (EPD)?

An Environmental Product Declaration is a **source of transparent, scientifically-based information that discloses the potential environmental impact of a product or product family**. Superior Essex Environmental Product Declarations are verified by UL® Environment, a division of the safety science company Underwriters Laboratories.

Superior Essex provides premises copper and optical fiber cabling products with EPDs. Visit [ce.SuperiorEssex.com/Enviro](https://www.superioressex.com/Enviro) for more information.



What is a Health Product Declaration™ (HPD™)?

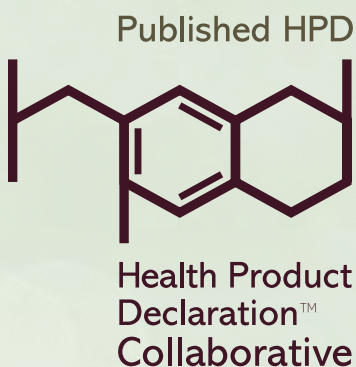

A Health Product Declaration is a **report that describes product contents and each ingredient's relationship to human and ecological health**. Superior Essex Health Product Declarations are published according to the Health Product Declaration Collaborative Standard.

Superior Essex provides premises copper and optical fiber cabling products with HPDs. Visit [ce.SuperiorEssex.com/Enviro](https://www.superioressex.com/Enviro) for more information.

UL and the related logo are registered trademarks of UL LLC. Health Product Declaration, HPD and the related logo are trademarks of Health Product Declaration Collaborative.

Coax RG-59, 95% Shield

CMR/CL2R, CMP/CL2P

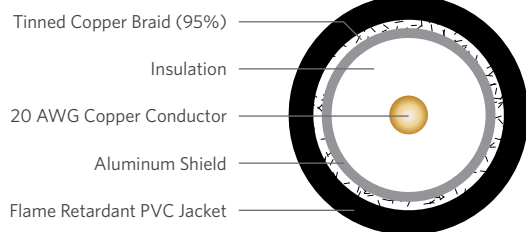

Tinned Copper Braid (95%)

Insulation

20 AWG Copper Conductor

Aluminum Shield

Flame Retardant PVC Jacket

SPECIFICATIONS

Conductor	Solid copper
AWG (mm)	20 (0.81)
Shield	Aluminum foil
Braid	Tinned copper (95%)
Jacket	Flame retardant PVC
Nominal Impedance Ohms	75.0
Nominal Velocity of Propagation %	CMR: 83 CMP: 84
Performance Compliance	UL® 13 UL 444 UL 1666 NEC Article 725 NEC Article 800 NFPA 262 RoHS-compliant/RoHS 2-compliant
NRTL Programs	UL, c(UL) Listed CMR UL, c(UL) Listed CMP

UL is a registered trademark of UL LLC.

PRODUCT DESCRIPTION

Closed circuit security cameras use baseband frequencies, typically under 5 MHz. These applications are best suited for the bare copper center conductors of the Superior Essex RG-59 coaxial cable, which also features 95% tinned copper braiding. RG-59 is specifically designed for applications operating below 1 GHz, but will also support higher frequency applications at shorter distances than RG-6 coaxial cable.

APPLICATIONS

- CATV
- Video camera signals

FEATURES

- Small size
- Copper center conductor
- Foamed polyethylene dielectric (CMR) or fluoropolymer (CMP)
- Bonded aluminum shield tape
- 95% tinned copper braid
- Black and white jacket colors available for CMR version

BENEFITS

- Suitable for tight applications and preferred for lower frequency signals
- Ideal for lower frequency signals
- Exhibits better transmission characteristics
- Blocks RFI
- Ideal for lower frequency signals
- Helps differentiate incoming service versus internal cabling infrastructure

PART NUMBERS AND PHYSICAL CHARACTERISTICS

Listing	Part Number	Jacket Color	Nominal Diameter in (mm)	Approx. Weight lbs/kft (kg/km)	Package	Packages per Pallet
CMR/CL2R	78-558-91	White	0.24 (6.1)	34 (50.7)	1,000' Plywood reel	25
CMR/CL2R	79-558-91	Black	0.24 (6.1)	34 (50.7)	1,000' Plywood reel	25
CMP/CL2P	78-55C-91	White	0.19 (5.1)	27 (12.0)	1,000' Plywood reel	25

ELECTRICAL SPECIFICATIONS

Frequency MHz	CMR/CL2R Attenuation, Nominal dB/100 ft (dB/100 m)	CMP/CL2P Attenuation, Nominal dB/100 ft (dB/100 m)
1	0.3 (1.0)	0.3 (1.0)
3.58	0.6 (1.8)	0.6 (2.0)
5	0.6 (2.1)	0.7 (2.3)
7	0.7 (2.4)	0.8 (2.7)
10	0.9 (2.9)	1.1 (3.4)
67.5	2.1 (6.7)	2.2 (7.2)
71.5	2.1 (6.9)	2.3 (7.4)
100	2.3 (7.6)	2.7 (8.9)
135	2.7 (8.9)	3.2 (10.5)
143	2.8 (9.1)	3.3 (10.7)
180	3.1 (10.2)	3.7 (12.0)
270	3.8 (12.5)	4.6 (14.9)
360	4.4 (14.5)	5.3 (17.2)
540	5.5 (17.9)	6.4 (21.0)
720	6.4 (20.9)	7.3 (23.9)
750	6.5 (21.3)	7.4 (24.3)
1000	7.6 (24.9)	9.4 (30.8)
2000	10.9 (35.8)	14.6 (47.8)
3000	13.3 (43.7)	18.8 (61.5)

Coax RG-59, 95% Shield + 18/2

CMP/CL2P

PRODUCT DESCRIPTION

Closed circuit security cameras use baseband frequencies, typically under 5 MHz. These applications are best suited for the bare copper center conductors of the Superior Essex RG-59 coaxial cable, which also features 95% bare copper braiding. RG-59 is specifically designed for applications operating below 1 GHz, but will also support higher frequency applications at shorter distances than RG-6 coaxial cable. This cable includes a web-attached 18 AWG copper pair to power camera.

APPLICATIONS

- CCTV with power feed
- Video camera signals

FEATURES

- Small size
- Copper center conductor
- Foamed fluoropolymer
- 95% bare copper braid
- Web-attached 18 AWG power-pairs

BENEFITS

- Suitable for tight applications and preferred for lower frequency signals
- Lower signal attenuation
- Exhibits better transmission characteristics
- Lower signal attenuation
- Single cable run for video and power feeds

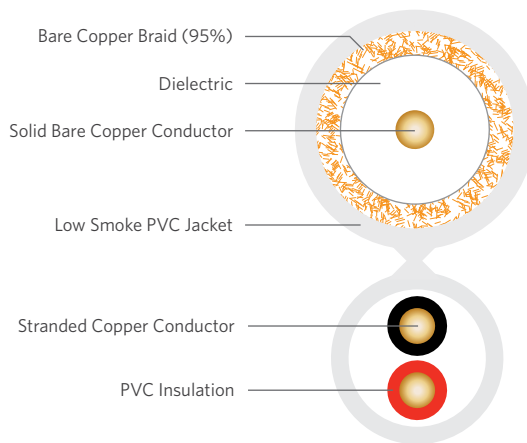

COMPOSITE SPECIFICATIONS	
Jacket	Low smoke PVC
Performance Compliance	UL® 13 UL 444 NFPA 262 RoHS-compliant/RoHS 2-compliant
NRTL Programs	UL, c(UL) Listed CMP

UL is a registered trademark of UL LLC.

COAX COMPONENT SPECIFICATIONS	
Conductor	Solid bare copper
AWG (mm)	20 (0.82)
Dielectric	Foamed fluoropolymer
Braid	Bare copper (95% coverage)
Nominal Velocity of Propagation %	80
Nominal Impedance Ohms	75.0
DC Resistance Ohms/kft	11.0

POWER COMPONENT SPECIFICATIONS	
Conductor Count	2
Conductor	Stranded copper
AWG (mm)	18 (1.22)
Insulation	Low smoke PVC
Insulation Colors	Conductor 1: Black Conductor 2: Red
DC Resistance Ohms/kft	7.0

PART NUMBERS AND PHYSICAL CHARACTERISTICS						
Listing	Part Number	Jacket Color	Nominal Diameter in (mm)	Approx. Weight lbs/kft (kg/km)	Package	Packages per Pallet
CMP/CL2P	86-57D-A1	White	0.36 (9.2) x 0.20 (5.0)	47 (70.1)	1,000' Plywood reel	27

ELECTRICAL SPECIFICATIONS	
Frequency MHz	CMP/CL2P Attenuation, Nominal dB/100 ft (dB/100 m)
1	0.35 (1.15)
10	1.04 (3.41)
100	3.25 (10.66)
200	4.63 (15.19)
400	7.12 (23.60)
700	9.97 (32.43)
900	10.79 (36.06)
1000	11.66 (38.25)

Fire Alarm, Non-Shielded

Power Limited, Riser/Plenum

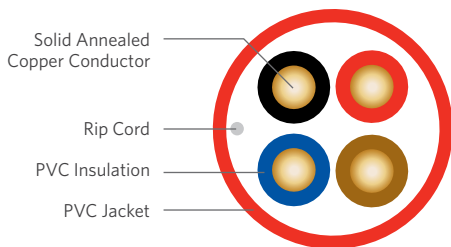

SPECIFICATIONS

Conductor Count	Available with 2 through 8 conductors
Conductor	Fully annealed, solid bare copper
AWG (mm)	Available in 12 (2.05) through 22 (0.64)
Insulation	PVC
Insulation Colors	Conductor 1: Black Conductor 2: Red Conductor 3: Brown Conductor 4: Blue Conductor 5: Orange Conductor 6: Yellow Conductor 7: Violet Conductor 8: Gray
Jacket	Riser: Red, Flame Retardant (FR) PVC (Available in other jacket colors) Plenum: Red, Low smoke PVC (Available in other jacket colors)
Package	Black, ribbed, plastic recyclable spool, Reel-in-a-Box or wood reel
Performance Compliance	NEC Article 760 NEC Article 725 NEC Article 800 UL® 1424 FPLR/FPLP UL 13 CL3R/CL3P UL 444 CMR/CMP* UL 1666 NFPA 262 California State Fire Marshall RoHS-compliant/RoHS 2-compliant
NRTL Programs	UL Listed CMR, CL3R, FPLR UL Listed CMP, CL3P, FPLP

*CMR/CMP listing does not apply to 12 AWG and 14 AWG Superior Essex Fire Alarm cables. UL is a registered trademark of UL LLC.

ENVIRONMENTAL SPECIFICATIONS

Operation	-4°F to +167°F (-20°C to +75°C)
Installation	+32°F to +149°F (0°C to +65°C)

PRODUCT DESCRIPTION

Fire Alarm cables are used for a variety of life safety devices, and are required to comply with many codes and standards. Superior Essex has grouped its fire alarm cable products into just two categories for simplicity: riser and plenum. All riser listed fire alarm cables provide full compliance to NEC Article 760, NEC Article 725, FPLR and CL3R. All plenum listed fire alarm cables provide compliance to NEC Article 760, NEC Article 725, FPLP and CL3P. These cables are offered in a wide range of conductor counts and gauges. All cables are power limited rated for 300V.

APPLICATIONS

- Smoke detectors
- Alarm notification
- Strobes
- Sirens
- Pull stations
- Addressable control systems
- Circuits controlled and powered by the fire alarm system
- Sprinkler and sprinkler supervisory systems

FEATURES

- Red color jacket (standard)
- Non-plenum, riser rated
- Plenum rated
- Jacket rip cord
- CableID® alpha numeric code printed every 2 feet
- QuickCount® marking system in feet and meters
- Black, plastic recyclable spool packaging (standard)

BENEFITS

- Identified as universal fire alarm cable
- Simplifies selection with multiple listings (FPL, FPLR, CL3R and CMR*)
- Simplifies selection with multiple listings (FPLP, CL3P and CMP*)
- Easy to open; saves cable preparation time
- Allows both ends of a cable run to be easily identifiable without the need to separately label or tone the cable
- Saves on installation time
- Provides remaining length of cable on spool resulting in less scrap
- Robust and easy to handle

PART NUMBERS AND PHYSICAL CHARACTERISTICS

Listing	Part Number ¹	Conductor Count	AWG (mm)	Nominal Diameter in (mm)	Approx. Weight lbs/kft (kg/km)
FPLR/CL3R	2F-41x-91	2	12 (2.05)	0.23 (5.8)	49 (73)
FPLR/CL3R	2F-42x-91	3	12 (2.05)	0.25 (6.2)	73 (33)
FPLR/CL3R	2F-31x-91	2	14 (1.63)	0.20 (5.1)	33 (49)
FPLR/CL3R	2F-32x-91	3	14 (1.63)	0.21 (5.4)	46 (20)
FPLR/CL3R	2F-33x-91	4	14 (1.63)	0.25 (6.4)	66 (99)
FPLR/CL3R/CMR	2F-21x-91	2	16 (1.29)	0.17 (4.3)	23 (34)
FPLR/CL3R/CMR	2F-22x-91	3	16 (1.29)	0.18 (4.6)	32 (14)
FPLR/CL3R/CMR	2F-23x-91	4	16 (1.29)	0.20 (5.1)	42 (63)
FPLR/CL3R/CMR	2F-11x-91	2	18 (1.02)	0.15 (3.8)	16 (24)
FPLR/CL3R/CMR	2F-12x-91	3	18 (1.02)	0.16 (4.1)	22 (9)
FPLR/CL3R/CMR	2F-13x-91	4	18 (1.02)	0.17 (4.3)	29 (43)
FPLR/CL3R/CMR	2F-14x-91	6	18 (1.02)	0.21 (5.3)	42 (63)
FPLR/CL3R/CMR	2F-51x-91	2	22 (0.64)	0.12 (3.0)	8 (12)
FPLR/CL3R/CMR	2F-52x-91	3	22 (0.64)	0.13 (3.3)	10 (4)
FPLR/CL3R/CMR	2F-53x-91	4	22 (0.64)	0.14 (3.6)	14 (21)
FPLP/CL3P	2F-41x-93	2	12 (2.05)	0.23 (5.8)	50 (74)
FPLP/CL3P	2F-31x-93	2	14 (1.63)	0.20 (5.1)	34 (51)
FPLP/CL3P	2F-32x-93	3	14 (1.63)	0.21 (5.4)	47 (21)
FPLP/CL3P	2F-33x-93	4	14 (1.63)	0.23 (5.8)	64 (95)
FPLP/CL3P/CMP	2F-21x-93	2	16 (1.29)	0.17 (4.3)	24 (36)
FPLP/CL3P/CMP	2F-22x-93	3	16 (1.29)	0.18 (4.6)	33 (14)
FPLP/CL3P/CMP	2F-23x-93	4	16 (1.29)	0.20 (5.1)	43 (64)
FPLP/CL3P/CMP	2F-11x-93	2	18 (1.02)	0.15 (3.8)	17 (25)
FPLP/CL3P/CMP	2F-12x-93	3	18 (1.02)	0.16 (4.1)	23 (10)
FPLP/CL3P/CMP	2F-13x-93	4	18 (1.02)	0.17 (4.3)	29 (43)
FPLP/CL3P/CMP	2F-14x-93	6	18 (1.02)	0.21 (5.3)	43 (64)
FPLP/CL3P/CMP	2F-15x-93	8	18 (1.02)	0.23 (5.8)	56 (83)
FPLP/CL3P/CMP	2F-51x-93	2	22 (0.64)	0.12 (3.0)	9 (13)
FPLP/CL3P/CMP	2F-52x-93	3	22 (0.64)	0.13 (3.3)	11 (4)
FPLP/CL3P/CMP	2F-53x-93	4	22 (0.64)	0.14 (3.6)	15 (22)

Additional jacket colors are available.

	Plastic Spool		Reel-in-a-Box		Wood Reel	Shrink Wrap	
	1,000'	500'	1,000'	500'	1,000'	250'	500'
¹ Replace "x" with:	2	3	4	5	6	7	8

Fire Alarm, Shielded

Power Limited, Riser/Plenum

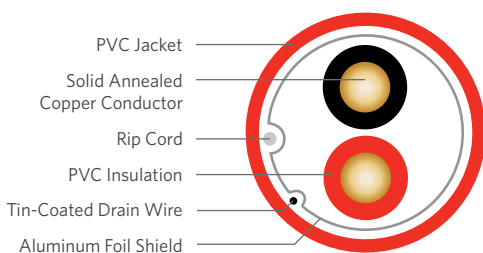

SPECIFICATIONS

Conductor Count	Available with 2 through 6 conductors
Conductor	Fully annealed, solid bare copper
AWG (mm)	Available in 12 (2.05) through 22 (0.64)
Insulation	PVC
Insulation Colors	Conductor 1: Black Conductor 2: Red Conductor 3: Brown Conductor 4: Blue Conductor 5: Orange Conductor 6: Yellow Conductor 7: Violet Conductor 8: Gray
Shield	1-mil overall aluminum polyester foil shield with 24 AWG (0.51 mm) solid tinned copper drain wire
Jacket	Riser: Red, Flame Retardant (FR) PVC (Available in other jacket colors) Plenum: Red, Low smoke PVC (Available in other jacket colors)
Package	Black, ribbed, plastic recyclable spool, Reel-in-a-Box or wood reel
Performance Compliance	NEC Article 760 NEC Article 725 NEC Article 800 UL® 1424 FPLR/FPLP UL 13 CL3R/CL3P UL 444 CMR/CMP* UL 1666 NFPA 262 California State Fire Marshall RoHS-compliant/RoHS 2-compliant
NRTL Programs	UL Listed CMR, CL3R, FPLR UL Listed CMP, CL3P, FPLP

*CMR/CMP listing does not apply to 12 AWG and 14 AWG Superior Essex Fire Alarm cables. UL is a registered trademark of UL LLC.

ENVIRONMENTAL SPECIFICATIONS

Operation	-4°F to +167°F (-20°C to +75°C)
Installation	+32°F to +149°F (0°C to +65°C)

PRODUCT DESCRIPTION

Fire Alarm cables are used for a variety of life safety devices, and are required to comply with many codes and standards. Superior Essex has grouped its fire alarm cable products into just two categories for simplicity: riser and plenum. All riser listed fire alarm cables provide full compliance to NEC Article 760, NEC Article 725, FPLR and CL3R. All plenum listed fire alarm cables provide compliance to NEC Article 760, NEC Article 725, FPLP and CL3P. These cables are offered in a wide range of conductor counts and gauges. All cables are power limited rated for 300V.

APPLICATIONS

- Smoke detectors
- Alarm notification
- Strobes
- Sirens
- Pull stations
- Addressable control systems
- Circuits controlled and powered by the fire alarm system
- Sprinkler and sprinkler supervisory systems

FEATURES

- Red color jacket (standard)
- Non-plenum, riser rated
- Plenum rated
- Jacket rip cord
- CableID® alpha numeric code printed every 2 feet
- QuickCount® marking system in feet and meters
- Black, plastic recyclable spool packaging (standard)
- Shielded

BENEFITS

- Identified as universal fire alarm cable
- Simplifies selection with multiple listings (FPL, FPLR, CL3R and CMR*)
- Simplifies selection with multiple listings (FPLP, CL3P and CMP*)
- Easy to open; saves cable preparation time
- Allows both ends of a cable run to be easily identifiable without the need to separately label or tone the cable
- Saves on installation time
- Provides remaining length of cable on spool resulting in less scrap
- Robust and easy to handle
- Electromagnetic Interference (EMI) protection

PART NUMBERS AND PHYSICAL CHARACTERISTICS

Listing	Part Number ¹	Conductor Count	AWG (mm)	Nominal Diameter in (mm)	Approx. Weight lbs/kft (kg/km)
FPLR/CL3R	2F-41x-92	2	12 (2.05)	0.24 (6.1)	51 (76)
FPLR/CL3R	2F-31x-92	2	14 (1.63)	0.21 (5.3)	36 (54)
FPLR/CL3R	2F-32x-92	3	14 (1.63)	0.22 (5.7)	49 (22)
FPLR/CL3R	2F-33x-92	4	14 (1.63)	0.24 (6.1)	65 (97)
FPLR/CL3R/CMR	2F-21x-92	2	16 (1.29)	0.18 (4.6)	25 (37)
FPLR/CL3R/CMR	2F-22x-92	3	16 (1.29)	0.19 (4.9)	35 (15)
FPLR/CL3R/CMR	2F-23x-92	4	16 (1.29)	0.21 (5.3)	44 (65)
FPLR/CL3R/CMR	2F-11x-92	2	18 (1.02)	0.16 (4.1)	18 (27)
FPLR/CL3R/CMR	2F-12x-92	3	18 (1.02)	0.17 (4.3)	25 (11)
FPLR/CL3R/CMR	2F-13x-92	4	18 (1.02)	0.18 (4.6)	31 (46)
FPLR/CL3R/CMR	2F-14x-92	6	18 (1.02)	0.22 (5.6)	44 (65)
FPLR/CL3R/CMR	2F-51x-92	2	22 (0.64)	0.13 (3.3)	10 (15)
FPLR/CL3R/CMR	2F-52x-92	3	22 (0.64)	0.14 (3.5)	13 (5)
FPLR/CL3R/CMR	2F-53x-92	4	22 (0.64)	0.15 (3.8)	16 (24)
FPLP/CL3P	2F-41x-94	2	12 (2.05)	0.24 (6.1)	53 (79)
FPLP/CL3P	2F-42x-94	3	12 (2.05)	0.26 (6.5)	76 (34)
FPLP/CL3P	2F-31x-94	2	14 (1.63)	0.21 (5.3)	36 (54)
FPLP/CL3P	2F-32x-94	3	14 (1.63)	0.22 (5.7)	50 (22)
FPLP/CL3P	2F-33x-94	4	14 (1.63)	0.24 (6.1)	66 (98)
FPLP/CL3P/CMP	2F-21x-94	2	16 (1.29)	0.18 (4.6)	26 (39)
FPLP/CL3P/CMP	2F-22x-94	3	16 (1.29)	0.19 (4.9)	35 (15)
FPLP/CL3P/CMP	2F-23x-94	4	16 (1.29)	0.21 (5.3)	45 (67)
FPLP/CL3P/CMP	2F-11x-94	2	18 (1.02)	0.16 (4.1)	19 (28)
FPLP/CL3P/CMP	2F-12x-94	3	18 (1.02)	0.17 (4.3)	25 (11)
FPLP/CL3P/CMP	2F-13x-94	4	18 (1.02)	0.18 (4.6)	32 (48)
FPLP/CL3P/CMP	2F-14x-94	6	18 (1.02)	0.22 (5.6)	45 (67)
FPLP/CL3P/CMP	2F-51x-94	2	22 (0.64)	0.13 (3.3)	11 (16)
FPLP/CL3P/CMP	2F-52x-94	3	22 (0.64)	0.14 (3.5)	13 (5)
FPLP/CL3P/CMP	2F-53x-94	4	22 (0.64)	0.15 (3.8)	17 (25)

Additional jacket colors are available.

PACKAGING OPTIONS

	Plastic Spool		Reel-in-a-Box		Wood Reel	Shrink Wrap	
	1,000'	500'	1,000'	500'	1,000'	250'	500'
¹ Replace "x" with:	2	3	4	5	6	7	8

Interlock Armored

Fire Alarm Riser

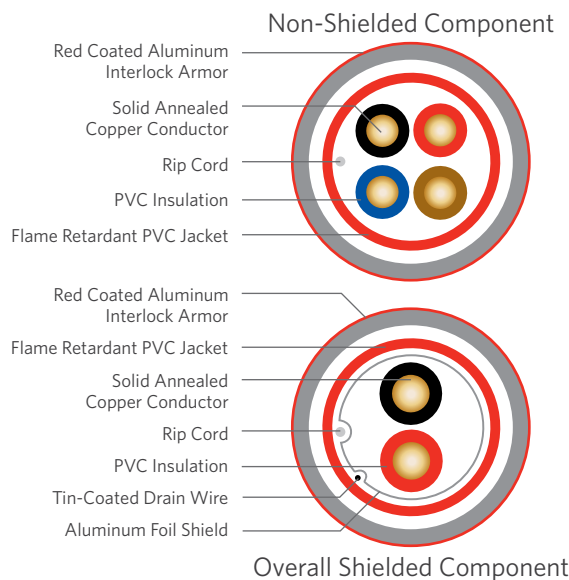

SPECIFICATIONS

Overall Cable Configuration	Single component cable surrounded by red aluminum interlock armor
Component Jacket	Red, Flame Retardant PVC
Armor	Red, interlocked aluminum
Performance Compliance	NEC Article 760 NEC Article 725 NEC Article 800 UL® 1424 FPLR UL 13 CL3R UL 444 CMR* UL 1666 UL 1569, Sections 19 and 23 California State Fire Marshall RoHS-compliant/RoHS 2-compliant
NRTL Programs	UL Listed FPLR, CL3R, CMR

*CMR listing does not apply to 12 AWG and 14 AWG Superior Essex Fire Alarm cables. UL is a registered trademark of UL LLC.

ENVIRONMENTAL SPECIFICATIONS

Operation	-4°F to +167°F (-20°C to +75°C)
Installation	+32°F to +149°F (0°C to +65°C)

PRODUCT DESCRIPTION

Superior Essex has a full line of fire alarm riser rated cables with red interlocked aluminum armor. The addition of aluminum interlock armor over the red jacketed fire alarm cable provides significant mechanical protection and installation savings; adding the interlock armor eliminates the requirement for rigid, expensive pipes or conduits. These cables are available in both shielded and non-shielded versions with a wide range of conductor counts and gauges. The fire alarm cables with interlock armor can be used for a variety of life safety devices such as sirens, smoke detectors, and control systems. Together the cable and the interlocking armor provide multiple compliance levels, including NEC Article 760 (FPLR), NEC Article 725 (CL3R), and NEC Article 800 (CMR). All fire alarm cables are power limited rated for 300V. Each individual cable is retested after adding the interlock armoring to ensure all applicable industry requirements are met.

APPLICATIONS

- Smoke detectors
- Alarm notification
- Strobes
- Sirens
- Pull stations
- Addressable control systems
- Circuits controlled and powered by the fire alarm system
- Sprinkler and sprinkler supervisory systems

FEATURES

- Red aluminum interlock armor
- Installed directly from reel
- 50% cost savings
- Aluminum interlock armor can be removed

BENEFITS

- Protects against mechanical stress and EMI/RFI for ensured and reliable performance
- Faster installation; fewer tools/equipment and less labor is required
- Saves labor and installation time; rigid conduit and pipes not necessary; finish job faster
- Maintains the fire rating even after interlock armor is removed

PART NUMBERS AND PHYSICAL CHARACTERISTICS

Listing	Part Number	Conductor Count	AWG (mm)	Nominal Diameter in (mm)	Approx. Weight lbs/kft (kg/km)	Package
Non-Shielded Component						
FPLR/CL3R	K2F-419-91	2	12 (2.05)	0.50 (12.7)	83 (124)	1,000' Wood reel
FPLR/CL3R	K2F-429-91	3	12 (2.05)	0.50 (12.7)	107 (159)	1,000' Wood reel
FPLR/CL3R	K2F-319-91	2	14 (1.63)	0.50 (12.7)	67 (100)	1,000' Wood reel
FPLR/CL3R	K2F-329-91	3	14 (1.63)	0.50 (12.7)	80 (119)	1,000' Wood reel
FPLR/CL3R	K2F-339-91	4	14 (1.63)	0.50 (12.7)	100 (149)	1,000' Wood reel
FPLR/CL3R/CMR	K2F-219-91	2	16 (1.29)	0.50 (12.7)	57 (85)	1,000' Wood reel
FPLR/CL3R/CMR	K2F-229-91	3	16 (1.29)	0.50 (12.7)	66 (98)	1,000' Wood reel
FPLR/CL3R/CMR	K2F-239-91	4	16 (1.29)	0.50 (12.7)	76 (113)	1,000' Wood reel
FPLR/CL3R/CMR	K2F-119-91	2	18 (1.02)	0.50 (12.7)	50 (74)	1,000' Wood reel
FPLR/CL3R/CMR	K2F-129-91	3	18 (1.02)	0.50 (12.7)	56 (83)	1,000' Wood reel
FPLR/CL3R/CMR	K2F-139-91	4	18 (1.02)	0.50 (12.7)	63 (94)	1,000' Wood reel
FPLR/CL3R/CMR	K2F-519-91	2	22 (0.64)	0.50 (12.7)	42 (63)	1,000' Wood reel
FPLR/CL3R/CMR	K2F-529-91	3	22 (0.64)	0.50 (12.7)	44 (66)	1,000' Wood reel
FPLR/CL3R/CMR	K2F-539-91	4	22 (0.64)	0.50 (12.7)	48 (71)	1,000' Wood reel
Overall Shielded Component						
FPLR/CL3R	K2F-419-92	2	12 (2.05)	0.50 (12.7)	85 (127)	1,000' Wood reel
FPLR/CL3R	K2F-319-92	2	14 (1.63)	0.50 (12.7)	70 (104)	1,000' Wood reel
FPLR/CL3R	K2F-329-92	3	14 (1.63)	0.50 (12.7)	83 (124)	1,000' Wood reel
FPLR/CL3R	K2F-339-92	4	14 (1.63)	0.50 (12.7)	99 (147)	1,000' Wood reel
FPLR/CL3R/CMR	K2F-219-92	2	16 (1.29)	0.50 (12.7)	59 (88)	1,000' Wood reel
FPLR/CL3R/CMR	K2F-229-92	3	16 (1.29)	0.50 (12.7)	69 (103)	1,000' Wood reel
FPLR/CL3R/CMR	K2F-239-92	4	16 (1.29)	0.50 (12.7)	78 (116)	1,000' Wood reel
FPLR/CL3R/CMR	K2F-119-92	2	18 (1.02)	0.50 (12.7)	52 (77)	1,000' Wood reel
FPLR/CL3R/CMR	K2F-129-92	3	18 (1.02)	0.50 (12.7)	59 (88)	1,000' Wood reel
FPLR/CL3R/CMR	K2F-139-92	4	18 (1.02)	0.50 (12.7)	65 (97)	1,000' Wood reel
FPLR/CL3R/CMR	K2F-519-92	2	22 (0.64)	0.50 (12.7)	44 (66)	1,000' Wood reel
FPLR/CL3R/CMR	K2F-529-92	3	22 (0.64)	0.50 (12.7)	47 (70)	1,000' Wood reel
FPLR/CL3R/CMR	K2F-539-92	4	22 (0.64)	0.50 (12.7)	50 (74)	1,000' Wood reel

Additional cable combinations are available. Other color sequences available upon request.

Security Control, Non-Shielded

Power Limited, Riser/Plenum

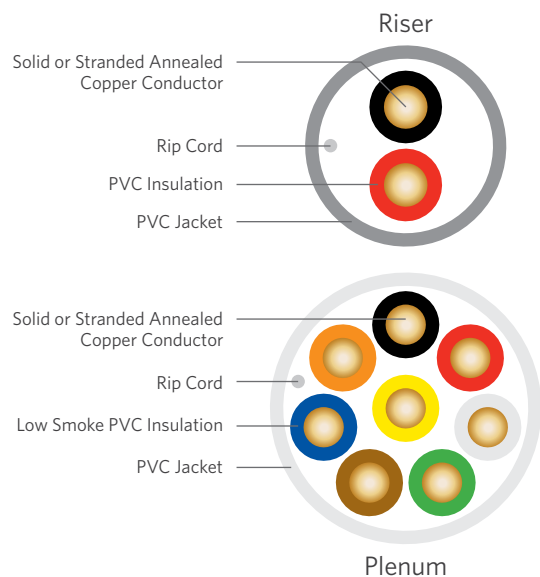

SPECIFICATIONS

Conductor Count	Available with 2 through 12 conductors
Conductor	Fully annealed, solid or stranded bare copper
AWG (mm)	Available in 12 (2.05) through 22 (0.64)
Insulation	Low smoke PVC
Insulation Colors	Conductor 1: Black Conductor 2: Red Conductor 3: White Conductor 4: Green Conductor 5: Brown Conductor 6: Blue Conductor 7: Orange Conductor 8: Yellow Conductor 9: Violet Conductor 10: Gray Conductor 11: Pink Conductor 12: Tan
Jacket	Riser: Gray, Flame Retardant (FR) PVC (Available in other jacket colors) Plenum: White, Low smoke PVC (Available in other jacket colors)
Package	Black, ribbed, plastic recyclable spool, Reel-in-a-Box or wood reel
Performance Compliance	NEC Article 725 NEC Article 800 NEC Article 760 UL® 13 CL3R/CL3P UL 444 CMR/CMP* UL 1424 FPLR/FPLP UL 1666 NFPA 262 California State Fire Marshall RoHS-compliant/RoHS 2-compliant
NRTL Programs	UL Listed CL3R, CMR, FPLR UL Listed CL3P, CMP, FPLP

*CMR/CMP listing does not apply to 12 AWG and 14 AWG Superior Essex Security Control cables. UL is a registered trademark of UL LLC.

PRODUCT DESCRIPTION

Security Control cables are used for a variety of building control and audio applications. The non-shielded security control cable series is ideal for environments where electromagnetic interference (EMI) is not a concern or the cable is not required to be grounded. All riser listed security control cables provide compliance to NEC Article 725, NEC Article 760, CL3R and FPLR. All plenum listed security control cables provide compliance to NEC Article 725, NEC Article 760, CL3P and FPLP. All security control cables are power limited rated for 300V.

APPLICATIONS

- Intercom
- Security
- Audio, public address system, speakers
- Burglar alarm system
- Telephone stations
- Background music
- Sensors

FEATURES

- Non-plenum, riser rated
- Plenum rated
- Jacket rip cord
- CableID® alpha numeric code printed every 2 feet
- QuickCount® marking system in feet and meters
- Black, plastic recyclable spool packaging (standard)

BENEFITS

- Simplifies selection with multiple listings (CL3R, CMR*, FPL and FPLR)
- Simplifies selection with multiple listings (CL3P, CMP* and FPLP)
- Easy to open; saves cable preparation time
- Allows both ends of a cable run to be easily identifiable without the need to separately label or tone the cable
- Saves on installation time
- Provides remaining length of cable on spool resulting in less scrap
- Robust and easy to handle

ENVIRONMENTAL SPECIFICATIONS

Operation	-4°F to +167°F (-20°C to +75°C)
Installation	+32°F to +149°F (0°C to +65°C)

PART NUMBERS AND PHYSICAL CHARACTERISTICS

Listing	Part Number ¹	Conductor Count	AWG (mm)	Conductor Type	Jacket Color ²	Nominal Diameter in (mm)	Approx. Weight lbs/kft (kg/km)
CL3R/FPLR	2F-F1x-31	2	12 (2.05)	19 x 0.0185	Gray	0.25 (6.4)	51 (76)
CL3R/FPLR	2F-F2x-31	3	12 (2.05)	19 x 0.0185	Gray	0.27 (6.8)	77 (34)
CL3R/FPLR	2F-E1x-31	2	14 (1.85)	19 x 0.0147	Gray	0.22 (5.6)	34 (51)
CL3R/FPLR	2F-E2x-31	3	14 (1.85)	19 x 0.0147	Gray	0.23 (6.0)	47 (21)
CL3R/FPLR	2F-E3x-31	4	14 (1.85)	19 x 0.0147	Gray	0.25 (6.4)	64 (95)
CL3R/CMR/FPLR	2F-D1x-31	2	16 (1.46)	19 x 0.0117	Gray	0.19 (4.8)	24 (36)
CL3R/CMR/FPLR	2F-D2x-31	3	16 (1.46)	19 x 0.0117	Gray	0.20 (5.1)	32 (14)
CL3R/CMR/FPLR	2F-D3x-31	4	16 (1.46)	19 x 0.0117	Gray	0.22 (5.6)	43 (64)
CL3R/CMR/FPLR	2F-C1x-31	2	18 (1.16)	7 x 26 AWG	Gray	0.16 (4.1)	17 (25)
CL3R/CMR/FPLR	2F-C2x-31	3	18 (1.16)	7 x 26 AWG	Gray	0.17 (4.3)	22 (9)
CL3R/CMR/FPLR	2F-C3x-31	4	18 (1.16)	7 x 26 AWG	Gray	0.19 (4.8)	30 (45)
CL3R/CMR/FPLR	2F-C4x-31	6	18 (1.16)	7 x 26 AWG	Gray	0.23 (5.8)	43 (64)
CL3R/CMR/FPLR	2F-C5x-31	8	18 (1.16)	7 x 26 AWG	Gray	0.25 (6.4)	56 (83)
CL3R/CMR/FPLR	2F-C7x-31	12	18 (1.16)	7 x 26 AWG	Gray	0.30 (7.6)	83 (124)
CL3R/CMR/FPLR	2F-B1x-31	2	20 (0.92)	7 x 28 AWG	Gray	0.14 (3.6)	12 (18)
CL3R/CMR/FPLR	2F-B2x-31	3	20 (0.92)	7 x 28 AWG	Gray	0.15 (3.8)	15 (6)
CL3R/CMR/FPLR	2F-B3x-31	4	20 (0.92)	7 x 28 AWG	Gray	0.16 (4.1)	21 (31)
CL3R/CMR/FPLR	2F-A1x-31	2	22 (0.73)	7 x 30 AWG	Gray	0.13 (3.3)	9 (13)
CL3R/CMR/FPLR	2F-A2x-31	3	22 (0.73)	7 x 30 AWG	Gray	0.14 (3.5)	11 (4)
CL3R/CMR/FPLR	2F-A3x-31	4	22 (0.73)	7 x 30 AWG	Gray	0.15 (3.8)	15 (22)
CL3R/CMR/FPLR	2F-A4x-31	6	22 (0.73)	7 x 30 AWG	Gray	0.18 (4.6)	21 (31)
CL3R/CMR/FPLR	2F-A5x-31	8	22 (0.73)	7 x 30 AWG	Gray	0.19 (4.8)	28 (42)
CL3R/CMR/FPLR	2F-A6x-31	10	22 (0.73)	7 x 30 AWG	Gray	0.22 (5.6)	34 (51)
CL3R/CMR/FPLR	2F-A7x-31	12	22 (0.73)	7 x 30 AWG	Gray	0.23 (5.8)	40 (60)
CL3R/CMR/FPLR	2F-51x-31	2	22 (0.64)	Solid	Gray	0.12 (3.0)	8 (12)
CL3R/CMR/FPLR	2F-52x-31	3	22 (0.64)	Solid	Gray	0.13 (3.3)	10 (4)
CL3R/CMR/FPLR	2F-53x-31	4	22 (0.64)	Solid	Gray	0.14 (3.6)	14 (21)
CL3P/FPLP	2F-F1x-43	2	12 (2.05)	19 x 0.0185	White	0.25 (6.4)	52 (77)
CL3P/FPLP	2F-F2x-43	3	12 (2.05)	19 x 0.0185	White	0.27 (6.8)	78 (35)
CL3P/FPLP	2F-E1x-43	2	14 (1.85)	19 x 0.0147	White	0.22 (5.6)	35 (52)
CL3P/FPLP	2F-E2x-43	3	14 (1.85)	19 x 0.0147	White	0.23 (6.0)	48 (21)
CL3P/FPLP	2F-E3x-43	4	14 (1.85)	19 x 0.0147	White	0.25 (6.4)	65 (97)
CL3P/CMP/FPLP	2F-D1x-43	2	16 (1.46)	19 x 0.0117	White	0.19 (4.8)	24 (36)
CL3P/CMP/FPLP	2F-D2x-43	3	16 (1.46)	19 x 0.0117	White	0.20 (5.1)	32 (14)
CL3P/CMP/FPLP	2F-D3x-43	4	16 (1.46)	19 x 0.0117	White	0.22 (5.6)	44 (65)
CL3P/CMP/FPLP	2F-C1x-43	2	18 (1.16)	7 x 26 AWG	White	0.16 (4.1)	17 (25)
CL3P/CMP/FPLP	2F-C2x-43	3	18 (1.16)	7 x 26 AWG	White	0.17 (4.3)	22 (9)
CL3P/CMP/FPLP	2F-C3x-43	4	18 (1.16)	7 x 26 AWG	White	0.19 (4.8)	30 (45)
CL3P/CMP/FPLP	2F-C4x-43	6	18 (1.16)	7 x 26 AWG	White	0.23 (5.8)	44 (65)
CL3P/CMP/FPLP	2F-C5x-43	8	18 (1.16)	7 x 26 AWG	White	0.25 (6.4)	57 (85)
CL3P/CMP/FPLP	2F-C7x-43	12	18 (1.16)	7 x 26 AWG	White	0.30 (7.6)	85 (126)
CL3P/CMP/FPLP	2F-B1x-43	2	20 (0.92)	7 x 28 AWG	White	0.14 (3.6)	13 (19)
CL3P/CMP/FPLP	2F-B2x-43	3	20 (0.92)	7 x 28 AWG	White	0.15 (3.8)	16 (7)
CL3P/CMP/FPLP	2F-B3x-43	4	20 (0.92)	7 x 28 AWG	White	0.16 (4.1)	22 (33)
CL3P/CMP/FPLP	2F-A1x-43	2	22 (0.73)	7 x 30 AWG	White	0.13 (3.3)	9 (13)
CL3P/CMP/FPLP	2F-A2x-43	3	22 (0.73)	7 x 30 AWG	White	0.14 (3.5)	11 (4)
CL3P/CMP/FPLP	2F-A3x-43	4	22 (0.73)	7 x 30 AWG	White	0.15 (3.8)	16 (24)
CL3P/CMP/FPLP	2F-A4x-43	6	22 (0.73)	7 x 30 AWG	White	0.18 (4.6)	22 (33)
CL3P/CMP/FPLP	2F-A5x-43	8	22 (0.73)	7 x 30 AWG	White	0.19 (4.8)	28 (42)
CL3P/CMP/FPLP	2F-A6x-43	10	22 (0.73)	7 x 30 AWG	White	0.22 (5.6)	35 (52)
CL3P/CMP/FPLP	2F-A7x-43	12	22 (0.73)	7 x 30 AWG	White	0.23 (5.8)	41 (61)
CL3P/CMP/FPLP	2F-51x-43	2	22 (0.64)	Solid	White	0.12 (3.0)	9 (13)
CL3P/CMP/FPLP	2F-52x-43	3	22 (0.64)	Solid	White	0.13 (3.3)	11 (4)
CL3P/CMP/FPLP	2F-53x-43	4	22 (0.64)	Solid	White	0.14 (3.6)	15 (22)

¹Additional jacket colors are available.

PACKAGING OPTIONS

	Plastic Spool		Reel-in-a-Box		Wood Reel	Shrink Wrap	
	1,000'	500'	1,000'	500'	1,000'	250'	500'
¹ Replace "x" with:	2	3	4	5	6	7	8

Security Control, Shielded

Power Limited, Riser/Plenum

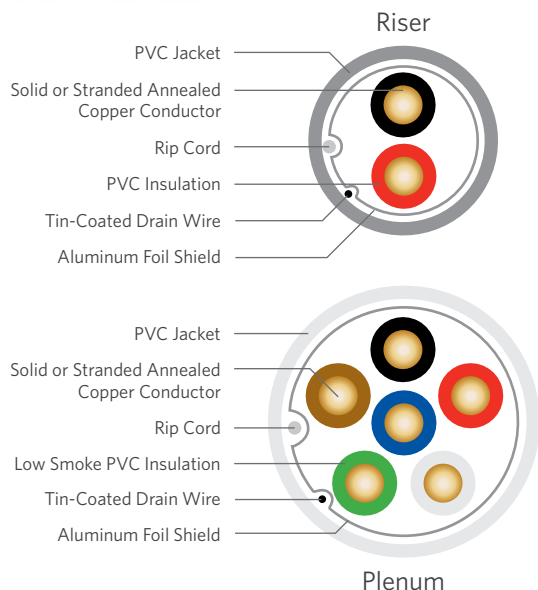

SPECIFICATIONS

Conductor Count	Available with 2 through 12 conductors
Conductor	Fully annealed, solid or stranded bare copper
AWG (mm)	Available in 12 (2.05) through 22 (0.64)
Insulation	PVC
Insulation Colors	Conductor 1: Black Conductor 2: Red Conductor 3: White Conductor 4: Green Conductor 5: Brown Conductor 6: Blue Conductor 7: Orange Conductor 8: Yellow Conductor 9: Violet Conductor 10: Gray Conductor 11: Pink Conductor 12: Tan
Shield	1-mil overall aluminum polyester foil shield with 24 AWG (0.51 mm) solid tinned copper drain wire
Jacket	Riser: Gray, Flame Retardant (FR) PVC (Available in other jacket colors) Plenum: White, Low smoke PVC (Available in other jacket colors)
Package	Black, ribbed, plastic recyclable spool, Reel-in-a-Box or wood reel
Performance Compliance	NEC Article 725 NEC Article 800 NEC Article 760 UL® 13 CL3R/CL3P UL 444 CMR/CMP* UL 1424 FPLR/FPLP UL 1666 NFPA 262 California State Fire Marshall RoHS-compliant/RoHS 2-compliant
NRTL Programs	UL Listed CL3R, CMR, FPLR UL Listed CL3P, CMP, FPLP

*CMR/CMP listing does not apply to 12 AWG and 14 AWG Superior Essex Security Control cables. UL is a registered trademark of UL LLC.

PRODUCT DESCRIPTION

Security Control cables are used for a variety building control and audio applications. The security control, shielded cable series is ideal for environments where electromagnetic interference (EMI) is a concern or the cable is required to be grounded. All riser listed security control cables provide compliance to NEC Article 725, NEC Article 760, CL3R and FPLR. All plenum listed security control cables provide compliance to NEC Article 725, NEC Article 760, CL3P and FPLP. All security control cables are power limited rated for 300V.

APPLICATIONS

- Intercom
- Security
- Audio, public address system, speakers
- Burglar alarm system
- Telephone stations
- Background music

FEATURES

- Non-plenum, riser rated
- Plenum rated
- Jacket rip cord
- Overall shield
- CableID® alpha numeric code printed every 2 feet
- QuickCount® marking system in feet and meters
- Black, plastic recyclable spool packaging (standard)

BENEFITS

- Simplifies selection with multiple listings (CL3R, CMR*, FPL and FPLR)
- Simplifies selection with multiple listings (CL3P, CMP* and FPLP)
- Easy to open; saves cable preparation time
- Electromagnetic Interference (EMI) protection
- Allows both ends of a cable run to be easily identifiable without the need to separately label or tone the cable
- Saves on installation time
- Provides remaining length of cable on spool resulting in less scrap
- Robust and easy to handle

ENVIRONMENTAL SPECIFICATIONS

Operation	-4°F to +167°F (-20°C to +75°C)
Installation	+32°F to +149°F (0°C to +65°C)

PART NUMBERS AND PHYSICAL CHARACTERISTICS

Listing	Part Number ¹	Conductor Count	AWG (mm)	Conductor Type	Jacket Color ²	Nominal Diameter in (mm)	Approx. Weight lbs/kft (kg/km)
CL3R/FPLR	2F-F1x-32	2	12 (2.05)	19 x 0.0185	Gray	0.26 (6.6)	53 (79)
CL3R/FPLR	2F-E1x-32	2	14 (1.85)	19 x 0.0147	Gray	0.23 (5.8)	36 (54)
CL3R/FPLR	2F-E2x-32	3	14 (1.85)	19 x 0.0147	Gray	0.25 (6.2)	49 (22)
CL3R/FPLR	2F-E3x-32	4	14 (1.85)	19 x 0.0147	Gray	0.26 (6.6)	66 (98)
CL3R/CMR/FPLR	2F-D1x-32	2	16 (1.46)	19 x 0.0117	Gray	0.20 (5.1)	26 (39)
CL3R/CMR/FPLR	2F-D2x-32	3	16 (1.46)	19 x 0.0117	Gray	0.21 (5.4)	35 (15)
CL3R/CMR/FPLR	2F-D3x-32	4	16 (1.46)	19 x 0.0117	Gray	0.23 (5.8)	45 (67)
CL3R/CMR/FPLR	2F-C1x-32	2	18 (1.16)	7 x 26 AWG	Gray	0.17 (4.3)	19 (28)
CL3R/CMR/FPLR	2F-C2x-32	3	18 (1.16)	7 x 26 AWG	Gray	0.18 (4.6)	24 (10)
CL3R/CMR/FPLR	2F-C3x-32	4	18 (1.16)	7 x 26 AWG	Gray	0.20 (5.1)	32 (48)
CL3R/CMR/FPLR	2F-C4x-32	6	18 (1.16)	7 x 26 AWG	Gray	0.24 (6.1)	45 (67)
CL3R/CMR/FPLR	2F-C5x-32	8	18 (1.16)	7 x 26 AWG	Gray	0.26 (6.6)	59 (88)
CL3R/CMR/FPLR	2F-C6x-32	10	18 (1.16)	7 x 26 AWG	Gray	0.29 (7.4)	72 (107)
CL3R/CMR/FPLR	2F-C7x-32	12	18 (1.16)	7 x 26 AWG	Gray	0.31 (7.9)	86 (128)
CL3R/CMR/FPLR	2F-B1x-32	2	20 (0.92)	7 x 28 AWG	Gray	0.15 (3.8)	14 (21)
CL3R/CMR/FPLR	2F-B2x-32	3	20 (0.92)	7 x 28 AWG	Gray	0.16 (4.1)	18 (8)
CL3R/CMR/FPLR	2F-B3x-32	4	20 (0.92)	7 x 28 AWG	Gray	0.17 (4.3)	23 (34)
CL3R/CMR/FPLR	2F-A1x-32	2	22 (0.73)	7 x 30 AWG	Gray	0.14 (3.6)	11 (16)
CL3R/CMR/FPLR	2F-A2x-32	3	22 (0.73)	7 x 30 AWG	Gray	0.15 (3.8)	13 (5)
CL3R/CMR/FPLR	2F-A3x-32	4	22 (0.73)	7 x 30 AWG	Gray	0.16 (4.1)	17 (25)
CL3R/CMR/FPLR	2F-A4x-32	6	22 (0.73)	7 x 30 AWG	Gray	0.19 (4.8)	24 (36)
CL3R/CMR/FPLR	2F-A5x-32	8	22 (0.73)	7 x 30 AWG	Gray	0.20 (5.1)	30 (45)
CL3R/CMR/FPLR	2F-A6x-32	10	22 (0.73)	7 x 30 AWG	Gray	0.23 (5.8)	36 (54)
CL3R/CMR/FPLR	2F-A7x-32	12	22 (0.73)	7 x 30 AWG	Gray	0.24 (6.1)	42 (63)
CL3R/CMR/FPLR	2F-51x-32	2	22 (0.64)	Solid	Gray	0.13 (3.3)	10 (15)
CL3R/CMR/FPLR	2F-52x-32	3	22 (0.64)	Solid	Gray	0.14 (3.5)	13 (5)
CL3P/FPLP	2F-F1x-44	2	12 (2.05)	19 x 0.0185	White	0.26 (6.6)	54 (80)
CL3P/FPLP	2F-F2x-44	3	12 (2.05)	19 x 0.0185	White	0.28 (7.0)	81 (36)
CL3P/FPLP	2F-E1x-44	2	14 (1.85)	19 x 0.0147	White	0.23 (5.8)	37 (55)
CL3P/FPLP	2F-E2x-44	3	14 (1.85)	19 x 0.0147	White	0.25 (6.2)	50 (22)
CL3P/FPLP	2F-E3x-44	4	14 (1.85)	19 x 0.0147	White	0.26 (6.6)	67 (100)
CL3P/CMP/FPLP	2F-D1x-44	2	16 (1.46)	19 x 0.0117	White	0.20 (5.1)	26 (39)
CL3P/CMP/FPLP	2F-D2x-44	3	16 (1.46)	19 x 0.0117	White	0.21 (5.4)	35 (15)
CL3P/CMP/FPLP	2F-D3x-44	4	16 (1.46)	19 x 0.0117	White	0.23 (5.8)	46 (68)
CL3P/CMP/FPLP	2F-C1x-44	2	18 (1.16)	7 x 26 AWG	White	0.17 (4.3)	19 (28)
CL3P/CMP/FPLP	2F-C2x-44	3	18 (1.16)	7 x 26 AWG	White	0.18 (4.6)	25 (11)
CL3P/CMP/FPLP	2F-C3x-44	4	18 (1.16)	7 x 26 AWG	White	0.20 (5.1)	33 (49)
CL3P/CMP/FPLP	2F-C4x-44	6	18 (1.16)	7 x 26 AWG	White	0.24 (6.1)	47 (70)
CL3P/CMP/FPLP	2F-C5x-44	8	18 (1.16)	7 x 26 AWG	White	0.26 (6.6)	60 (89)
CL3P/CMP/FPLP	2F-C7x-44	12	18 (1.16)	7 x 26 AWG	White	0.31 (7.9)	87 (129)
CL3P/CMP/FPLP	2F-B1x-44	2	20 (0.92)	7 x 28 AWG	White	0.15 (3.8)	15 (22)
CL3P/CMP/FPLP	2F-B2x-44	3	20 (0.92)	7 x 28 AWG	White	0.16 (4.1)	18 (8)
CL3P/CMP/FPLP	2F-B3x-44	4	20 (0.92)	7 x 28 AWG	White	0.17 (4.3)	24 (36)
CL3P/CMP/FPLP	2F-A1x-44	2	22 (0.73)	7 x 30 AWG	White	0.14 (3.6)	11 (16)
CL3P/CMP/FPLP	2F-A2x-44	3	22 (0.73)	7 x 30 AWG	White	0.15 (3.8)	14 (6)
CL3P/CMP/FPLP	2F-A3x-44	4	22 (0.73)	7 x 30 AWG	White	0.16 (4.1)	18 (27)
CL3P/CMP/FPLP	2F-A4x-44	6	22 (0.73)	7 x 30 AWG	White	0.19 (4.8)	24 (36)
CL3P/CMP/FPLP	2F-A5x-44	8	22 (0.73)	7 x 30 AWG	White	0.20 (5.1)	31 (46)
CL3P/CMP/FPLP	2F-A6x-44	10	22 (0.73)	7 x 30 AWG	White	0.23 (5.8)	37 (55)
CL3P/CMP/FPLP	2F-A7x-44	12	22 (0.73)	7 x 30 AWG	White	0.24 (6.1)	43 (64)
CL3P/CMP/FPLP	2F-51x-44	2	22 (0.64)	Solid	White	0.13 (3.3)	11 (16)
CL3P/CMP/FPLP	2F-52x-44	3	22 (0.64)	Solid	White	0.14 (3.5)	13 (5)

²Additional jacket colors are available.

PACKAGING OPTIONS

	Plastic Spool		Reel-in-a-Box		Wood Reel	Shrink Wrap	
	1,000'	500'	1,000'	500'		1,000'	250'
¹ Replace "x" with:	2	3	4	5	6	7	8

Access Control Composite

Riser/Plenum

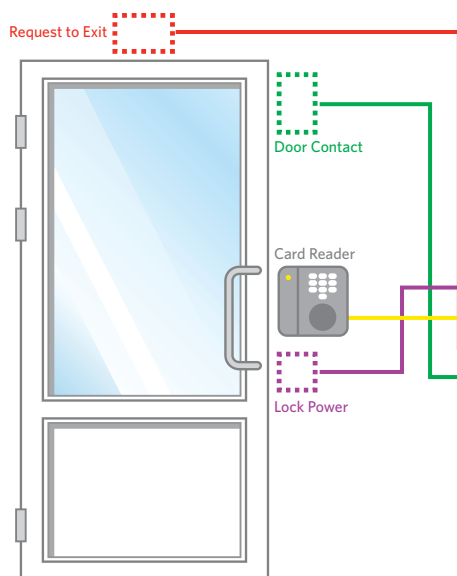
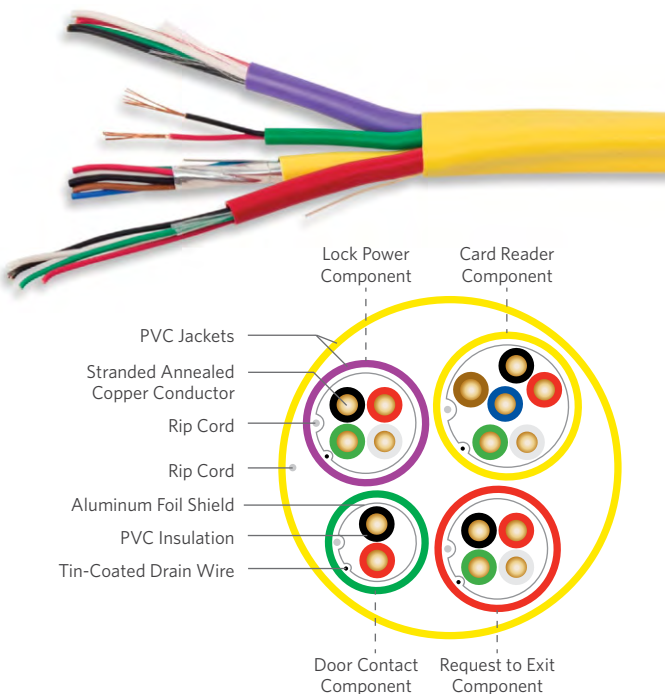

PRODUCT DESCRIPTION

The Access Control Composite series combines four components that are required for card reader/keypad, door contact, request to exit and lock power device connectivity in a single cable. These composites are offered with an option to shield all components or just the single card reader component. Both riser and plenum jacket constructions are available.

APPLICATIONS

- Access control

FEATURES

- Four components in a single jacket
- Twisted pair in card reader component
- Jacket rip cord
- Overall shield (where applicable)
- QuickCount marking system in feet and meters

BENEFITS

- Save labor costs with a one cable run
- Satisfies requirements of RS-232 and RS-485 protocols
- Easy to open; saves cable preparation time
- Electromagnetic Interference (EMI) protection
- Provides remaining length of cable on spool resulting in less scrap

COMPONENT COLOR CODING AND APPLICATION

Component Number	Cable Type	Application	Component Jacket Color
1	18 AWG x 4 conductors	Lock Power	Purple
2	22 AWG x 3 twisted pairs	Card Reader	Yellow
3	22 AWG x 4 conductors	Request to Exit	Red
4	22 AWG x 2 conductors	Door Contact	Green

ENVIRONMENTAL SPECIFICATIONS

Operation	-4°F to +167°F (-20°C to +75°C)
Installation	+32°F to +149°F (0°C to +65°C)

COMPOSITE SPECIFICATIONS

Outer Jacket	Riser: Flame Retardant (FR) PVC Plenum: Low smoke PVC
Jacket Marking	Example: XXXX FT/XXXX M SUPERIOR ESSEX ACCESS CONTROL CABLE DOOR / ZONE A B C D E / 0 1 2 3 4 5 6 7 8 9 18/4C + 22/3PR SHLD + 22/4C + 22/2C (UL) CMR/CL3R 75°C "ROHS COMPLIANT"
Package	Wood reel
Performance Compliance	NEC Article 725 NEC Article 800 NEC Article 760 UL® 13 CL3R/CL3P UL 444 CMR/CMP UL 1424 FPLR/FPLP UL 1666 NFPA 262 California State Fire Marshall RoHS-compliant/RoHS 2-compliant
NRTL Programs	UL Listed CL3R, CMR, FPLR UL Listed CL3P, CMP, FPLP

UL is a registered trademark of UL LLC.

COMPONENT SPECIFICATIONS

Conductor/Pair Count	Available with 2 through 4 conductors and available with 3 twisted pairs
Conductor	Fully annealed, stranded bare copper
AWG (mm)	Available in 18 (1.16) and 22 (0.64)
Insulation	Low smoke PVC
Shield (where applicable)	1-mil overall aluminum polyester foil shield with 24 AWG (0.51 mm) solid tinned copper drain wire
Component Jacket	Riser: Flame Retardant (FR) PVC Plenum: Low smoke PVC
Component Jacket Marking	Example: LOCK POWER DOOR / ZONE A B C D E / 0 1 2 3 4 5 6 7 8 9 18 AWG/4C PLENUM

PART NUMBERS AND PHYSICAL CHARACTERISTICS

Listing	Part Number ¹	Component Number	Application	Component Description	Insulation Colors	Component Jacket Color	Outer Jacket Color	Nominal Diameter in (mm)	Approx. Weight lbs/kft (kg/km)
CMR/CL3R/ FPLR	AC-A1x-55	1	Lock Power	18 AWG x 4 conductors, non-shielded	Black, Red, White, Green	Purple	Green	0.46 (11.7)	105 (156)
		2	Card Reader	22 AWG x 3 twisted pairs, shielded	Black/Red, White/Green, Brown/Blue	Yellow			
		3	Request Exit	22 AWG x 4 conductors, non-shielded	Black, Red, White, Green	Red			
		4	Door Contact	22 AWG x 2 conductors, non-shielded	Black, Red	Green			
CMR/CL3R/ FPLR	AC-A2x-55	1	Lock Power	18 AWG x 4 conductors, shielded	Black, Red, White, Green	Purple	Green	0.47 (11.9)	110 (164)
		2	Card Reader	22 AWG x 3 twisted pairs, shielded	Black/Red, White/Green, Brown/Blue	Yellow			
		3	Request Exit	22 AWG x 4 conductors, shielded	Black, Red, White, Green	Red			
		4	Door Contact	22 AWG x 2 conductors, shielded	Black, Red	Green			
CMP/CL3P/ FPLP	AC-A1x-68	1	Lock Power	18 AWG x 4 conductors, non-shielded	Black, Red, White, Green	Purple	Yellow	0.46 (11.7)	105 (156)
		2	Card Reader	22 AWG x 3 twisted pairs, shielded	Black/Red, White/Green, Brown/Blue	Yellow			
		3	Request Exit	22 AWG x 4 conductors, non-shielded	Black, Red, White, Green	Red			
		4	Door Contact	22 AWG x 2 conductors, non-shielded	Black, Red	Green			
CMP/CL3P/ FPLP	AC-A2x-68	1	Lock Power	18 AWG x 4 conductors, shielded	Black, Red, White, Green	Purple	Yellow	0.47 (11.9)	110 (164)
		2	Card Reader	22 AWG x 3 twisted pairs, shielded	Black/Red, White/Green, Brown/Blue	Yellow			
		3	Request Exit	22 AWG x 4 conductors, shielded	Black, Red, White, Green	Red			
		4	Door Contact	22 AWG x 2 conductors, shielded	Black, Red	Green			

PACKAGING OPTIONS

	Wood Reel	
	1,000'	500'
¹ Replace "x" with:	2	3

ABAM (600B) and ABMM Series

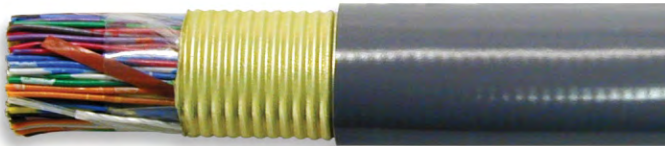

SPECIFICATIONS

Conductor	Tinned copper
Insulation	PE/PVC
Core Wrap	Non-hygroscopic, dielectric tape
Shield	Corrugated 8 mil aluminum bonded to the outer jacket
Jacket	Gray PVC printed at 2 foot intervals including product identification, pair count, UL information and sequential lengths in feet and meters
Performance Compliance	Telcordia® GR-137 (select sections) Telcordia GR-111 ASTM B33 - Tinned Copper UL® 444 CSA C22.2 No. 214-08 UL 1666 ANSI/TIA-568-C.2 RoHS-compliant/RoHS 2-compliant
NRTL Programs	UL, c(UL) Listed CMR

PRODUCT DESCRIPTION

The ABAM (600B) and ABMM Series Central Office (CO) Cables are designed for use between switching and transmission equipment for distances up to 650 feet. The ABAM (600B) series offers low attenuation by using 22 AWG conductors. Both ABAM (600B) and ABMM series (24 AWG) are manufactured with a dark gray smooth PVC jacket and a 0.008 inch corrugated aluminum shield for additional Electromagnetic Interference (EMI) reduction.

APPLICATIONS

- T1/DS1
- T1C/DS1C
- DS2
- 4 Mbps token ring (IEEE 802.5)
- 10 Mbps 10BASE-T Ethernet (IEEE 802.3)

FEATURES

- 22 and 24 AWG tinned copper conductors
- 100 Ohm nominal Impedance
- 0.008 inch corrugated aluminum shield
- CMR listed
- CAT 3 compliant
- Band marked conductors

BENEFITS

- Low attenuation, enabling longer run length; tinned copper conductors minimize change in wire-wrap joint resistance
- Impedance mismatch with OSP cable is minimized
- Higher EMI isolation over foil shields; great mechanical strength
- Suitable for horizontal and vertical installations
- Suitable for network applications
- Easy identification of conductor ring mates

PART NUMBERS AND PHYSICAL CHARACTERISTICS

Series	Part Number	Product Code	Pair Count	AWG (mm)	Nominal Diameter in (mm)	Approx. Weight lbs/kft (kg/km)	Standard Length ft (m)	Package
ABAM	55-399-25	606B	6	22 (0.6)	0.42 (11)	87 (129)	10,000 (3,048)	Reel
ABAM	55-499-25	607B	12	22 (0.6)	0.50 (13)	132 (196)	7,000 (2,135)	Reel
ABAM	55-599-25	608B	16	22 (0.6)	0.55 (14)	159 (237)	7,000 (2,135)	Reel
ABAM	55-999-25	613B	30	22 (0.6)	0.69 (18)	257 (382)	5,000 (1,524)	Reel
ABAM	55-A99-25	615B	32	22 (0.6)	0.71 (18)	270 (402)	5,000 (1,524)	Reel
ABAM	55-B99-25	610B	50	22 (0.6)	0.84 (21)	383 (570)	7,500 (2,285)	Reel
ABAM	55-D99-25	612B	75	22 (0.6)	1.02 (26)	561 (835)	3,000 (915)	Reel
ABAM	55-E99-25	611B	100	22 (0.6)	1.14 (29)	711 (1,058)	7,500 (2,285)	Reel
ABMM	55-799-24	-	25	24 (0.5)	0.57 (15)	164 (244)	10,000 (3,048)	Reel
ABMM	55-B99-24	-	50	24 (0.5)	0.73 (19)	276 (411)	10,000 (3,048)	Reel
ABMM	55-E99-24	-	100	24 (0.5)	0.99 (25)	505 (725)	10,000 (3,048)	Reel
ABMM	55-V99-24	-	600	24 (0.5)	2.10 (53)	2,378 (3,539)	1,000 (305)	Reel
ABMM	55-W99-24	-	900	24 (0.5)	2.51 (64)	3,456 (5,143)	1,000 (305)	Reel

ELECTRICAL SPECIFICATIONS

Frequency MHz	Attenuation @ 68°F (20°C) Maximum Guaranteed dB/100 m	PSNEXT Minimum Guaranteed dB/100 m	Minimum SRL dB/100 m
0.772	2.2	43	12
1	2.6	41	12
4	5.6	32	12
8	8.5	27	12
10	9.7	26	12
16	13.1	23	10

Characteristic Impedance Ohms	Delay Skew Maximum ns/100 m	DC Resistance Maximum Ohms/100 m	Resistance Unbalance Maximum %
100 ± 15	45	9.38	5

Telcordia is a registered trademark of Ericsson Inc. UL is a registered trademark of UL LLC.



PRODUCT DESCRIPTION

The 1249C Series Central Office (CO) Cables are designed for use between switching and transmission equipment for distances up to 450 feet. With short twist lays, 1249C series offers superior crosstalk performance over standard telephone cable. It is manufactured with a dual foil shield for additional Electromagnetic Interference (EMI) reduction and is double jacketed for protection of the twisted pairs. The 1249C series meets or exceeds all applicable requirements of Telcordia® GR-137 specifications.

APPLICATIONS

- T1/DS1
- T1C/DS1C
- DS2

FEATURES

- 26 AWG tinned copper conductors
- Solid Polyolefin insulation
- 100 Ohm nominal Impedance
- Short pair lays/tight twists
- Dual aluminum foil shields
- Tinned copper drain wire
- CMR listed
- Rip cord
- Solid color insulation

BENEFITS

- Small diameter and light weight result in smaller cable bundles and easier handling; minimize change in wire-wrap joint resistance
- Greater crush resistance and improved transmission characteristics
- Impedance mismatch with OSP cable is minimized
- Improved crosstalk performance and pair identification
- Higher EMI isolation over a single foil shield
- Easier termination and superior grounding
- Suitable for horizontal and riser installations
- Added ease of jacket removal
- Easy identification of conductor ring mates

SPECIFICATIONS

Conductor	Tinned copper
Insulation	Flame retardant polyethylene
Shield	Dual aluminum foil
Jacket	Gray PVC printed at 2 foot intervals including product identification, pair count, UL information and sequential lengths in feet and meters
Performance Compliance	Telcordia® GR-137-CORE, Issue 2, May 2013 Telcordia GR-499-CORE (Pulse shape compliance at 450 feet) ASTM B33 - Tinned Copper UL® 444 CSA C22.2 No. 214-08 UL 1666 RoHS-compliant/RoHS 2-compliant
NRTL Programs	UL, c(UL) Listed CMR

PART NUMBERS AND PHYSICAL CHARACTERISTICS

Part Number	Pair Count	AWG (mm)	Nominal Diameter in (mm)	Approx. Weight lbs/kft (kg/km)	Standard Length ft (m)	Package
55-499-20	12	26 (0.4)	0.35 (8.8)	50 (74)	7,000 (2,133)	Reel
55-799-20	25	26 (0.4)	0.45 (11.4)	88 (131)	5,000 (1,524)	Reel
55-899-20	28	26 (0.4)	0.47 (11.9)	93 (138)	5,000 (1,524)	Reel
55-999-20	30	26 (0.4)	0.49 (12.4)	101 (150)	4,000 (1,219)	Reel
55-A99-20	32	26 (0.4)	0.50 (12.7)	105 (156)	4,000 (1,219)	Reel
55-B99-20	50	26 (0.4)	0.59 (14.9)	153 (228)	3,000 (914)	Reel
55-E99-20	100	26 (0.4)	0.76 (19.3)	277 (412)	3,000 (914)	Reel

ELECTRICAL SPECIFICATIONS

Frequency MHz	PSNEXT Mean dB		PSNEXT Worst Pair dB	
	Minimum	Typical	Minimum	Typical
0.15	58	66	53	60
0.772	47	53	42	48
1.6	43	47	38	43
3.15	38	42	33	37
6.3	34	38	29	32

Bit Rate Mb/s	Frequency MHz	Attenuation @ 68°F (20°C)		Conductor DC Resistance @ 68°F (20°C) Maximum Individual Ohms/kft (Ohms/km)	Mutual Capacitance Nominal pF/ft (pF/m)	Characteristic Impedance @ 0.772 MHz Ohms
		Maximum Average* dB/kft (dB/100 m)	Typical dB/kft (dB/100 m)			
1.544	0.772	7.8 (2.6)	6.4 (2.1)	46.1 (151)	16 (52)	102 ± 15.3

*For cables with 12-pair or less, the maximum average attenuation may be increased by 10% over the values shown.

Telcordia is a registered trademark of Ericsson Inc. UL is a registered trademark of UL LLC.

1161A Series Category 3



PRODUCT DESCRIPTION

The 1161A Series Central Office (CO) Cables are designed for use between switching and transmission equipment, spanning distances up to 565 feet. With short twist lays, 1161A series offers superior crosstalk performance over standard telephone cable. It is manufactured with a foil shield for Electromagnetic Interference (EMI) reduction. The 1161A series meets or exceeds all applicable requirements of Telcordia® GR-137 specifications.

APPLICATIONS

- T1/DS1
- T1C/DS1C
- DS2

FEATURES

- 24 AWG tinned copper conductors
- Solid color Polyolefin insulation
- 100 Ohm nominal Impedance
- Short pair lays/tight twists
- Aluminum foil shield
- Tinned copper drain wire
- CMR listed
- 75°C rating
- Rip cord

BENEFITS

- Small diameter and light weight results in smaller bundles of cables and improved flexibility (compared with 600 Series)
- Tinned copper conductors minimize change in wire-wrap joint resistance
- Greater crush resistance and improved transmission characteristics
- Impedance mismatch with OSP cable is minimized
- Improved crosstalk performance and pair identification
- EMI isolation
- Easier termination and superior grounding
- Suitable for horizontal and riser installations
- Wider operating temperature range
- Added ease of jacket removal

SPECIFICATIONS

Conductor	Tinned copper
Insulation	Polyolefin
Core Wrap	Non-hygroscopic, dielectric tape
Shield	Aluminum foil
Jacket	Gray PVC printed at 2 foot intervals including product identification, pair count, UL information and sequential lengths in feet and meters
Performance Compliance	Telcordia® GR-137-CORE, Issue 2, May 2013 Telcordia GR-499-CORE (Pulse shape compliance at 565 feet) ASTM B33 - Tinned Copper UL® 444 CSA C22.2 No. 214-08 UL 1666 ANSI/TIA-568-C.2 RoHS-compliant/RoHS 2-compliant
NRTL Programs	UL, c(UL) Listed CMR

PART NUMBERS AND PHYSICAL CHARACTERISTICS

Part Number	Pair Count	AWG (mm)	Nominal Diameter in (mm)	Approx. Weight lbs/kft (kg/km)	Standard Length ft (m)	Package
55-F99-21	8	24 (0.5)	0.35 (8.9)	45 (67)	10,000 (3,048)	Reel
55-599-21*	16	24 (0.5)	0.41 (10)	77 (115)	7,000 (2,133)	Reel
55-799-21*	25	24 (0.5)	0.48 (12)	112 (167)	5,000 (1,524)	Reel
55-899-21*	28	24 (0.5)	0.51 (13)	123 (183)	5,000 (1,524)	Reel
55-A99-21*	32	24 (0.5)	0.55 (14)	143 (213)	4,000 (1,219)	Reel
55-B99-21*	50	24 (0.5)	0.66 (17)	210 (313)	3,000 (914)	Reel
55-E99-21*	100	24 (0.5)	0.89 (23)	389 (579)	1,000 (305)	Reel

*For cables with 12-pair or less, the maximum average attenuation may be increased by 10% over the values shown.

ELECTRICAL SPECIFICATIONS

Frequency MHz	PSNEXT Mean		PSNEXT Worst Pair	
	Minimum dB	Typical dB	Minimum dB	Typical dB
0.15	58	66	53	60
0.772	47	53	42	48
1.6	43	47	38	43
3.15	38	42	33	37
6.3	34	38	29	32

Bit Rate Mb/s	Frequency MHz	Attenuation @ 68°F (20°C)		Maximum Individual Conductor DC Resistance @ 68°F (20°C) Ohms/kft (Ohms/km)	Nominal Mutual Capacitance pF/ft (pF/m)	Characteristic Impedance @ 0.772 MHz Ohms
		Maximum Average* dB/kft (dB/100 m)	Typical dB/kft (dB/100 m)			
1.544	0.772	6.3 (2.1)	5.4 (1.8)	28.6 (93.8)	16 (52)	102 ± 15.3

*For cables with 12-pair or less, the maximum average attenuation may be increased by 10% over the values shown. Telcordia is a registered trademark of Ericsson Inc. UL is a registered trademark of UL LLC.



PRODUCT DESCRIPTION

The 600C Series Central Office (CO) Cables are designed for use between switching and transmission equipment for distances up to 650 feet. This series offers the lowest attenuation of all the CO cable products by using 22 AWG conductors. It is manufactured with a dual foil shield for additional Electromagnetic Interference (EMI) reduction. The 600C series meets or exceeds all applicable requirements of Telcordia® GR-137 specifications.

APPLICATIONS

- T1/DS1
- T1C/DS1C
- DS2

FEATURES

- 22 AWG tinned copper conductors
- Solid Polyolefin insulation
- 100 Ohm nominal Impedance
- Dual aluminum foil shield
- Tinned copper drain wire
- CMR listed
- Rip cord
- Band marked

BENEFITS

- Low attenuation, enabling longer run length; tinned copper conductors minimize change in wire-wrap joint resistance
- Greater crush resistance and improved transmission characteristics; smaller cable over dual insulated type
- Impedance mismatch with OSP cable is minimized
- Higher EMI isolation over a single foil shield; smaller cable diameter than 600B Series
- Easier termination and superior grounding
- Suitable for horizontal and riser installations
- Added ease of jacket removal
- Easy identification of conductor ring mates

SPECIFICATIONS

Conductor	Tinned copper
Insulation	Polyolefin
Shield	Dual aluminum foil
Jacket	Gray PVC printed at 2 foot intervals including product identification, pair count, UL information and sequential lengths in feet and meters
Performance Compliance	Telcordia® GR-137-CORE, Issue 2, May 2013 Telcordia GR-499-CORE (Pulse shape compliance at 650 feet) ASTM B33 - Tinned Copper UL® 444 CSA C22.2 No. 214-08 UL 1666 RoHS-compliant/RoHS 2-compliant
NRTL Programs	UL, c(UL) Listed CMR

PART NUMBERS AND PHYSICAL CHARACTERISTICS

Part Number	Product Code	Pair Count	AWG (mm)	Nominal Diameter in (mm)	Approx. Weight lbs/kft (kg/km)	Standard Length ft (m)	Package
55-399-38	606C	6	22 (0.6)	0.33 (8.3)	52 (77)	10,000 (3,048)	Reel
55-499-38	607C	12	22 (0.6)	0.43 (10.9)	89 (132)	7,000 (2,133)	Reel
55-599-38	608C	16	22 (0.6)	0.49 (12.4)	118 (176)	7,000 (2,133)	Reel
55-699-38	617C	20	22 (0.6)	0.53 (13.4)	141 (210)	5,000 (1,524)	Reel
55-799-38	609C	25	22 (0.6)	0.58 (14.7)	172 (256)	5,000 (1,524)	Reel
55-899-38	616C	28	22 (0.6)	0.61 (15.5)	189 (281)	5,000 (1,524)	Reel
55-999-38	613C	30	22 (0.6)	0.64 (16.2)	201 (299)	5,000 (1,524)	Reel
55-A99-38	615C	32	22 (0.6)	0.65 (16.5)	213 (317)	5,000 (1,524)	Reel
55-B99-38	610C	50	22 (0.6)	0.79 (20.0)	324 (482)	3,000 (914)	Reel

ELECTRICAL SPECIFICATIONS

Frequency MHz	PSNEXT Mean		PSNEXT Worst Pair	
	Minimum dB	Typical dB	Minimum dB	Typical dB
0.15	58	66	53	60
0.772	47	53	42	48
1.6	43	47	38	43
3.15	38	42	33	37
6.3	34	38	29	32

Attenuation @ 68°F (20°C)				Conductor DC Resistance @ 68°F (20°C)	Mutual Capacitance	Characteristic Impedance @ 0.772 MHz
Bit Rate Mb/s	Frequency MHz	Maximum Average* dB/kft (dB/100 m)	Typical dB/kft (dB/100 m)	Maximum Individual Ohms/kft (Ohms/km)	Nominal pF/ft (pF/m)	@ 0.772 MHz Ohms
1.544	0.772	5.0 (1.6)	4.0 (1.3)	18 (59.1)	16 (52)	102 ± 15.3

*For cables with 12-pair or less, the maximum average attenuation may be increased by 10% over the values shown. Telcordia is a registered trademark of Ericsson Inc. UL is a registered trademark of UL LLC.

25-Pair Category 5e Shielded

CMR



SPECIFICATIONS

Conductor	Tinned copper
Insulation	Polyolefin
Shield	Aluminum foil
Jacket	Flame retardant PVC
Jacket Marking	Printed at 2 foot intervals; information includes product identification, pair count, UL information and sequential lengths in feet and meters
Input Impedance Ohms	100 ± 15 @ 1-100 MHz
Nominal Velocity of Propagation %	69
Performance Compliance	ASTM B33 - Tinned Copper UL® 444 CSA C22.2 No. 214-08 UL 1666 ANSI/TIA-568-C.2 RoHS-compliant/RoHS 2-compliant
NRTL Programs	UL, c(UL) Listed CMR

PRODUCT DESCRIPTION

This 25-pair, 24 AWG, Category 5e Tin Copper Shielded Cable is utilized to connect equipment within a remote terminal cabinet or within a Central Office (CO). Tight twist lays offer superior crosstalk performance for supporting digital subscriber line (xDSL) technologies and higher IPTV data speeds. Assembled with a cable connector on both ends, the combination facilitates quick installation within the cabinet. The cable is manufactured with a blue or gray colored double jacket separated by a single aluminum foil shield for additional Electromagnetic Interference (EMI) reduction and added protection for the twisted pairs.

APPLICATIONS

- Remote terminal connecting cable
- Central Office cable

FEATURES

- Small outside diameter
- Vibrant insulation colors
- Performance compliance with ANSI/TIA-568-C.2 specification

BENEFITS

- Facilitates routing within a remote terminal
- Easier identification of conductors
- Provides cost-effective solution

PART NUMBERS AND PHYSICAL CHARACTERISTICS

Part Number	Pair Count	AWG (mm)	Jacket Color	Nominal Diameter in (mm)	Approx. Weight lbs/kft (kg/km)	Package
55-779-19	25	24 (0.5)	Green	0.57 (15)	145 (216)	5,000' Reel
55-789-19	25	24 (0.5)	Gray	0.57 (15)	145 (216)	5,000' Reel
55-799-19	25	24 (0.5)	Blue	0.57 (15)	145 (216)	5,000' Reel

ELECTRICAL SPECIFICATIONS

Frequency MHz	Attenuation @ 68°F (20°C) Maximum dB/100 m		NEXT Minimum dB/100 m		ACR Minimum dB/100 m		PSNEXT Minimum dB/100 m	
	TIA-568-C.2	Superior Essex	TIA-568-C.2	Superior Essex	TIA-568-C.2	Superior Essex	TIA-568-C.2	Superior Essex
	Specified	Typical	Specified	Typical	Calculated	Typical	Specified	Typical
1	2.0	1.8	65.3	77.7	63.3	75.9	62.3	75.2
4	4.1	3.7	56.3	68.7	52.2	64.9	53.3	66.0
8	5.8	5.4	51.8	61.3	46.0	55.8	48.8	58.7
10	6.5	6.0	50.3	60.7	43.8	54.5	47.3	58.3
16	8.2	7.7	47.2	56.1	39.1	48.3	44.3	53.7
20	9.3	8.6	45.8	55.3	36.5	46.5	42.8	52.9
25	10.4	9.6	44.3	53.8	33.9	44.0	41.3	51.4
31.25	11.7	10.8	42.9	52.7	31.2	41.6	39.9	50.0
62.5	17.0	15.5	38.4	48.0	21.4	32.2	35.4	45.5
100	22.0	19.8	35.3	44.5	13.3	24.2	32.3	42.2

Frequency MHz	PSACR Minimum dB/100 m		Return Loss Minimum dB/100 m		ELFEXT Minimum dB/100 m		PSELFEXT Minimum dB/100 m	
	TIA-568-C.2	Superior Essex	TIA-568-C.2	Superior Essex	TIA-568-C.2	Superior Essex	TIA-568-C.2	Superior Essex
	Calculated	Typical	Specified	Typical	Specified	Typical	Specified	Typical
1	60.3	73.3	20.0	40.1	63.8	69.2	60.8	68.5
4	49.2	62.2	23.0	40.1	51.7	57.7	48.7	57.0
8	43.0	53.2	24.5	39.8	45.7	51.6	42.7	49.5
10	40.8	52.2	25.0	37.3	43.8	49.0	40.8	48.2
16	36.1	46.0	25.0	36.7	39.7	45.6	36.7	43.8
20	33.5	44.2	25.0	36.0	37.7	43.6	34.7	42.8
25	30.9	41.7	24.3	34.5	35.8	42.0	32.8	40.7
31.25	28.2	39.0	23.6	32.6	33.9	40.1	30.9	39.3
62.5	18.4	29.9	21.5	31.6	27.8	34.7	24.8	33.5
100	10.3	22.1	20.1	31.7	23.8	30.4	20.8	29.4

UL is a registered trademark of UL LLC

Resources at Your Fingertips

Our Web site is a great resource for information to help with your next installation, including:

Support ▪ **Product FAQs** ▪ **Warranties**
Videos ▪ **Technical Guidelines**
Literature ▪ **Installation References**

All-in-one convenient location.

Visit ce.SuperiorEssex.com for the latest information and tools.



Switchboard 100 Ohm



SPECIFICATIONS

Conductor	Tinned copper
Insulation	PVC
Jacket	Gray PVC
Jacket Marking	Printed at 2 foot intervals; information includes product identification, pair count, UL information and sequential lengths in feet and meters
Performance Compliance	ASTM B33 - Tinned Copper UL® 444 CSA C22.2 No. 214-08 UL 1666 Telcordia® GR-137-CORE, Issue 2, May 2013 (select sections) RoHS-compliant/RoHS 2-compliant
NRTL Programs	UL, c(UL) Listed CMR

ELECTRICAL SPECIFICATIONS

Conductor Size AWG (mm)	Conductor DC Resistance @ 68°F (20°C) Maximum Individual Ohms/kft (Ohms/km)	Mutual Capacitance Nominal pF/ft (pF/m)	Characteristic Impedance @ 1 MHz Ohms	Maximum Average Attenuation* @ 0.772 MHz @ 68°F (20°C) dB/kft (dB/km)
24 (0.5)	28.6 (93.8)	20 (66)	100 ± 15	6.3 (20)
26 (0.4)	46.1 (151)	20 (66)	100 ± 15	7.8 (25)

*For cables with 12-pair or less, the maximum average attenuation may be increased by 10% over the values shown.

UL is a registered trademark of UL LLC. Telcordia is a registered trademark of Ericsson Inc.

PRODUCT DESCRIPTION

Switchboard 100 Central Office (CO) Cables are designed for indoor use in CO exchanges, or in premises telephone rooms. These cables are used for interconnection of distribution frames and digital switching and transmission equipment systems. Switchboard 100 provides 100 Ohm characteristic impedance. The product line consists of 24 or 26 AWG tinned insulated copper wires that are twisted into pairs. The pairs are stranded together utilizing a standard color code scheme.

APPLICATIONS

- T1/DS1
- T1C/DS1C
- 4 Mbps token ring (IEEE 802.5)
- 10 Mbps 10BASE-T Ethernet (IEEE 802.3)

FEATURES

- 100 Ohm nominal Impedance
- Tinned copper conductors
- CMR listed
- Rip cord
- Band marked

BENEFITS

- Impedance mismatch with Outside Plant (OSP) cable is minimized
- Minimize change in wire-wrap joint resistance
- Suitable for horizontal and riser installations
- Added ease of jacket removal
- Easy identification of conductor ring mates

PART NUMBERS AND PHYSICAL CHARACTERISTICS

Part Number	Product Code	Pair Count	AWG (mm)	Nominal Diameter in (mm)	Approx. Weight lbs/kft (kg/km)	Standard Length ft (m)	Package
55-021-23	TIW 2/24	2	24 (0.5)	0.14 (4)	10 (15)	5,000 (1,524)	Reel
55-241-23	TIW 4/24 or 286A	4	24 (0.5)	0.18 (5)	18 (27)	1,000 (305)	POP box
55-341-23	TIW 6/24 or 252A	6	24 (0.5)	0.22 (6)	26 (39)	1,000 (305)	POP box
55-F31-23	294A	8	24 (0.5)	0.24 (7)	33 (49)	1,000 (305)	Reel
55-G99-23	TIW 10/24 or 253A	10	24 (0.5)	0.25 (7)	40 (60)	7,000 (2,133)	Reel
55-499-23	TIW 12/24 or 265A	12	24 (0.5)	0.28 (7)	49 (73)	7,000 (2,133)	Reel
55-599-23	TIW 16/24	16	24 (0.5)	0.32 (8)	64 (95)	7,000 (2,133)	Reel
55-699-23	255A	20	24 (0.5)	0.35 (9)	78 (116)	5,000 (1,524)	Reel
55-799-23	TIW 25/24	25	24 (0.5)	0.39 (10)	96 (143)	5,000 (1,524)	Reel
55-899-23	TIW 28/24	28	24 (0.5)	0.41 (10)	107 (159)	5,000 (1,524)	Reel
55-A99-23	TIW 32/24	32	24 (0.5)	0.43 (11)	121 (180)	5,000 (1,524)	Reel
55-P99-23	269A	36	24 (0.5)	0.46 (12)	135 (201)	5,000 (1,524)	Reel
55-B99-23	TIW 50/24 or 270A	50	24 (0.5)	0.53 (13)	184 (274)	3,000 (914)	Reel
55-S99-23	267A	72	24 (0.5)	0.65 (17)	276 (411)	3,000 (914)	Reel
55-E99-23	TIW 100/24 or 262A	100	24 (0.5)	0.77 (20)	374 (557)	1,000 (305)	Reel
55-U99-23	287A	120	24 (0.5)	0.83 (21)	445 (662)	1,000 (305)	Reel
55-399-26	816A	6	26 (0.4)	0.18 (5)	17 (25)	5,000 (1,524)	Reel
55-F99-26	811A	8	26 (0.4)	0.19 (5)	22 (33)	5,000 (1,524)	Reel
55-G99-26	820A	10	26 (0.4)	0.20 (6)	27 (40)	5,000 (1,524)	Reel
55-799-26	824A	25	26 (0.4)	0.31 (8)	65 (97)	5,000 (1,524)	Reel
55-A99-26	808A	32	26 (0.4)	0.35 (9)	81 (121)	5,000 (1,524)	Reel
55-Q99-26	803A	40	26 (0.4)	0.39 (10)	100 (149)	5,000 (1,524)	Reel
55-P99-26	822A	48	26 (0.4)	0.42 (11)	118 (176)	5,000 (1,524)	Reel
55-B99-26	813A	50	26 (0.4)	0.43 (11)	123 (183)	5,000 (1,524)	Reel
55-R99-26	809A	64	26 (0.4)	0.48 (12)	154 (229)	5,000 (1,524)	Reel
55-K99-26	823A	96	26 (0.4)	0.58 (15)	228 (339)	5,000 (1,524)	Reel
55-E99-26	806A	100	26 (0.4)	0.61 (16)	236 (351)	5,000 (1,524)	Reel
55-H99-26	810A	128	26 (0.4)	0.69 (18)	316 (470)	5,000 (1,524)	Reel
55-L99-26	814A	144	26 (0.4)	0.73 (19)	353 (525)	5,000 (1,524)	Reel

Note: Standard USA Color Code Scheme

Switchboard 100 Ohm

200A/800A Series (Canadian Color Code)



PRODUCT DESCRIPTION

The 200A and 800A Series Central Office (CO) Cables are designed for indoor use in central offices or in premises telephone rooms, and are utilized between a distribution frame and digital switching/transmission equipment. This series offers 24 and 26 AWG tinned copper at 100 Ohm characteristic impedance levels. Used primarily in Canada, the color code and lay-up scheme has distinctively colored insulation in combination with single dots and double dots or dashes of colored ink. Each wire within a unit is readily distinguishable from all other wires within the same unit. Cables may contain pairs or a combination of pairs and singles. The pairs and singles are assembled together to form a core. Some cable sizes contain "spare pairs." The core is covered by a gray PVC jacket. The 200A and 800A series meet or exceed all applicable requirements of Telcordia® GR-137.

APPLICATIONS

- T1/DS1
- T1C/DS1C

FEATURES

- 24 and 26 AWG tinned copper conductors
- Solid PVC insulation
- 100 Ohm nominal impedance
- Standard pair lays
- CMR listed
- Non-shielded design
- Rip cord

BENEFITS

- Small diameter and light weight result in smaller cable bundles and easier handling; tinned copper conductors minimize change in wire-wrap joint resistance
- Greater crush resistance and improved transmission characteristics
- Impedance mismatch with OSP cable is minimized
- Improved crosstalk performance and pair identification
- Suitable for horizontal and riser installations
- Lower cost
- Added ease of jacket removal

SPECIFICATIONS

Conductor	Tinned copper
Insulation	PVC
Jacket	Gray PVC
Jacket Marking	Printed at 2 foot intervals on the jacket; information includes product identification, pair count, UL information and sequential lengths in feet and meters
Performance Compliance	Telcordia® GR-137-CORE, Issue 2, May 2013 (select sections) ASTM B33 - Tinned Copper UL® 444 CSA C22.2 No. 214-08 UL 1666 RoHS-compliant/RoHS 2-compliant
NRTL Programs	UL, c(UL) Listed CMR

PART NUMBERS AND PHYSICAL CHARACTERISTICS

Part Number	Product Code	Pair Count	AWG (mm)	Nominal Diameter in (mm)	Approx. Weight lbs/kft (kg/km)	Standard Length ft (m)	Package
55-399-46	252A	6	24 (0.5)	0.22 (5.6)	26 (39)	3,000 (915)	Reel
55-699-46	255A	20	24 (0.5)	0.35 (8.9)	78 (116)	3,000 (915)	Reel
55-E99-46	262A	101.5	24 (0.5)	0.82 (21)	383 (570)	400 (120)	Reel
55-N99-46	266A	24	24 (0.5)	0.42 (11)	94 (140)	1,200 (365)	Reel
55-P99-46	269A	36	24 (0.5)	0.44 (11)	134 (199)	1,000 (305)	Reel
55-599-47	807A	17	26 (0.4)	0.26 (6.6)	47 (70)	3,000 (915)	Reel
55-A99-47	808A	33	26 (0.4)	0.37 (9.4)	86 (128)	2,000 (610)	Reel
55-R99-47	809A	66	26 (0.4)	0.51 (13)	164 (244)	1,325 (405)	Reel
55-H99-47	810A	132	26 (0.4)	0.67 (17)	330 (491)	700 (215)	Reel
55-Y99-47	821A	52	26 (0.4)	0.45 (11)	131 (195)	1,100 (335)	Reel
55-N99-47	824A	25	26 (0.4)	0.32 (8.1)	66 (98)	2,400 (730)	Reel
55-E99-47	806A	103	26 (0.4)	0.65 (17)	265 (394)	1,000 (305)	Reel

Note: Standard Canadian Color Scheme

ELECTRICAL SPECIFICATIONS

Conductor Size AWG (mm)	Conductor DC Resistance @ 68°F (20°C) Maximum Individual Ohms/kft (Ohms/km)	Mutual Capacitance Nominal pF/ft (pF/m)	Characteristic Impedance @ 1 MHz Ohms	Maximum Average Attenuation* @ 0.772 MHz @ 68°F (20°C) dB/kft (dB/km)
24 (0.5)	28.6 (93.8)	20 (66)	100 ± 15	6.3 (20.7)
26 (0.4)	46.1 (151)	20 (66)	100 ± 15	7.8 (25.6)

*For cables with 12-pair or less, the maximum average attenuation may be increased by 10% over the values shown.

Telcordia is a registered trademark of Ericsson Inc. UL is a registered trademark of UL LLC.

PRODUCT DESCRIPTION

The T100 Series Central Office (CO) Cables are designed for use between switching and transmission equipment for distances up to 450 feet. They are manufactured with a longitudinal aluminum-polyester foil shield with aluminum facing the jacket for additional Electromagnetic Interference (EMI) reduction. The pairs are stranded together utilizing distinctive colored insulation in combination with markings of colored ink. The outer jacket is a gray flame retardant PVC. T100 series meets or exceeds all applicable requirements of Telcordia® GR-137 specifications.

APPLICATIONS

- T1/DS1
- T1C/DS1C

FEATURES

- 24 AWG tinned copper conductors
- CMR listed
- Solid PVC insulation
- 100 Ohm nominal impedance
- Standard pair lays
- Longitudinal aluminum/polyester foil shield with aluminum facing the jacket
- 24 AWG tinned copper drain wire
- Rip cord
- Band marked

BENEFITS

- Small diameter and light weight result in smaller cable bundles and easier handling; tinned copper conductors minimize change in wire-wrap joint resistance
- Suitable for horizontal and riser installations
- Greater crush resistance and improved transmission characteristics
- Impedance mismatch with OSP cable is minimized
- Improved crosstalk performance and pair identification
- EMI isolation
- Easier termination and superior grounding
- Added ease of jacket removal
- Easy pair identification



SPECIFICATIONS

Conductor	Tinned copper
Insulation	PVC
Shield	Aluminum/polyester foil
Jacket	Gray PVC
Jacket Marking	Printed at 2 foot intervals; information includes product identification, pair count, UL information and sequential lengths in feet and meters
Performance Compliance	Telcordia® GR-137-CORE, Issue 2, May 2013 (select sections) ASTM B33 - Tinned Copper UL® 444 (pulse shape compliance at 450 feet) CSA C22.2 No. 214-08 UL 1666 RoHS-compliant/RoHS 2-compliant
NRTL Programs	UL, c(UL) Listed CMR

PART NUMBERS AND PHYSICAL CHARACTERISTICS

Part Number	Product Code	Pair Count	AWG (mm)	Nominal Diameter in (mm)	Approx. Weight lbs/kft (kg/km)	Standard Length ft (m)	Package
55-399-43	T106	6	24 (0.5)	0.30 (7.6)	37 (55)	6,644 (2,025)	Reel
55-F99-43	T108	8	24 (0.5)	0.31 (7.9)	45 (67)	5,578 (1,700)	Reel
55-499-43	T112	12	24 (0.5)	0.34 (8.6)	59 (88)	6,644 (2,025)	Reel
55-599-43	T116	16	24 (0.5)	0.36 (9.1)	74 (110)	6,644 (2,025)	Reel
55-699-43	T120	20	24 (0.5)	0.41 (10)	91 (135)	5,315 (1,620)	Reel
55-799-43	T125	25	24 (0.5)	0.43 (11)	106 (158)	5,315 (1,620)	Reel
55-899-43	T128	28	24 (0.5)	0.44 (11)	114 (170)	5,000 (1,524)	Reel
55-999-43	T130	30	24 (0.5)	0.44 (11)	121 (180)	4,429 (1,350)	Reel
55-A99-43	T132	32	24 (0.5)	0.47 (12)	131 (195)	3,937 (1,200)	Reel

ELECTRICAL SPECIFICATIONS

Conductor DC Resistance @ 68°F (20°C) Maximum Individual Ohms/kft (Ohms/km)	Mutual Capacitance Nominal pF/ft (pF/m)	Characteristic Impedance @ 1 MHz Ohms	Maximum Average Attenuation @ 0.772 MHz @ 68°F (20°C) dB/kft (dB/km)
28.6 (93.8)	20 (66)	100 ± 15	7.2 (23.6)

Telcordia is a registered trademark of Ericsson Inc. UL is a registered trademark of UL LLC.

Switchboard 85 and Shielded Switchboard 85



SPECIFICATIONS

Conductor	Tinned copper
Insulation	PVC
Jacket	Gray PVC
Jacket Marking	Printed at 2 foot intervals; information includes product identification, pair count, UL information and sequential lengths in feet and meters
Shield	SSWBD: Aluminum/polyester SWBD: None
Performance Compliance	ASTM B33 - Tinned Copper UL® 444 CSA C22.2 No. 214-08 UL 1666 RoHS-compliant/RoHS 2-compliant
NRTL Programs	UL, c(UL) Listed CMR

PRODUCT DESCRIPTION

Switchboard Cables are designed for indoor use in central exchanges, the interconnection of distribution frames, and for switching and transmission equipment systems. Switchboard cables are available in both shielded and unshielded designs.

APPLICATIONS

- T1/DS1
- T1C/DS1C

FEATURES

- SSWBD: Aluminum foil shield
- SSWBD: Tinned copper drain wire
- Tinned copper conductors
- CMR listed
- Rip cord
- Band marked

BENEFITS

- EMI isolation
- Easier termination and superior grounding
- Minimize change in wire-wrap joint resistance
- Suitable for horizontal and riser installations
- Added ease of jacket removal
- Easy identification of conductor ring mates

PART NUMBERS AND PHYSICAL CHARACTERISTICS

Part Number	Product Code	Shield	Pair Count	AWG (mm)	Nominal Diameter in (mm)	Approx. Weight lbs/kft (kg/km)	Standard Length ft (m)	Package
02-097-61	SSWBD	Aluminum foil	25	24 (0.5)	0.35 (8.9)	88 (131)	5,000 (1,524)	Reel
02-098-61	SSWBD	Aluminum foil	32	24 (0.5)	0.41 (10)	113 (168)	5,000 (1,524)	Reel
02-100-61	SSWBD	Aluminum foil	50	24 (0.5)	0.48 (12)	167 (249)	5,000 (1,524)	Reel
02-104-61	SSWBD	Aluminum foil	100	24 (0.5)	0.63 (16)	314 (467)	5,000 (1,524)	Reel
02-840-10	SWBD	-	6	24 (0.5)	0.18 (4.6)	22 (33)	1,000 (305)	Reel
02-841-10	SWBD	-	12	24 (0.5)	0.24 (6.1)	41 (61)	1,000 (305)	Reel
02-431-10	SWBD	-	25	24 (0.5)	0.31 (7.9)	79 (118)	1,000 (305)	Reel
02-815-10	SWBD	-	25	24 (0.5)	0.31 (7.9)	79 (118)	5,000 (1,524)	Reel
02-832-10	SWBD	-	32	24 (0.5)	0.36 (9.1)	100 (149)	5,000 (1,524)	Reel
02-813-10	SWBD	-	50	24 (0.5)	0.45 (11)	157 (234)	5,000 (1,524)	Reel
02-820-10	SWBD	-	100	24 (0.5)	0.60 (15)	302 (449)	5,000 (1,524)	Reel

ELECTRICAL SPECIFICATIONS

Product	Conductor DC Resistance @ 68°F (20°C) Maximum Individual Ohms/kft (Ohms/km)	Mutual Capacitance Nominal pF/ft (pF/m)	Characteristic Impedance @ 1 MHz Ohms	Attenuation Nominal @ 0.772 MHz @ 68°F (20°C) dB/kft (dB/km)
SSWBD	28.6 (93.8)	20 (66)	85 ± 15	11 (36)
SWBD	28.6 (93.8)	20 (66)	85 ± 15	11 (36)

UL is a registered trademark of UL LLC.

PRODUCT DESCRIPTION

Distribution Frame Wires are designed for cross-connection of equipment in telephone switch and equipment rooms requiring point-to-point hook ups.

APPLICATIONS

- Normal use

FEATURES

- Solid tinned copper conductors in 22 AWG or 24 AWG are insulated with semi-rigid polyvinyl chloride (PVC)
- Each insulated conductor is identified by a solid insulation color

BENEFITS

- Facilitates wire wrapping and tight connections
- Easy identification



SPECIFICATIONS

Conductor	Tinned copper
Insulation	Semi-rigid PVC
Performance Compliance	ASTM B33 - Tinned Copper UL® 444 CSA C22.2 No. 214-08 GR 136 CORE (normal use) RoHS-compliant/RoHS 2-compliant
NRTL Programs	UL, c(UL) Listed CM

PART NUMBERS AND PHYSICAL CHARACTERISTICS

Part Number	Number of Conductors	AWG (mm)	Insulation Color	Nominal Diameter in (mm)	Approx. Weight lbs/kft (kg/km)	Package
12-001-11	1	22 (0.6)	Red	0.04 (1.0)	2 (3)	750 m Spool
12-002-11	1	22 (0.6)	White	0.04 (1.0)	2 (3)	750 m Spool
12-004-11	1	22 (0.6)	Black	0.04 (1.0)	2 (3)	750 m Spool
12-303-13	1	22 (0.6)	Green	0.04 (1.0)	2 (3)	1,000 m Spool
12-001-12	2	22 (0.6)	Red/Green	0.08 (2.0)	5 (7)	500 m Spool
12-003-12	2	22 (0.6)	Blue/White	0.08 (2.0)	5 (7)	500 m Spool
12-004-12	2	22 (0.6)	Brown/Blue	0.08 (2.0)	5 (7)	500 m Spool
12-005-12	2	22 (0.6)	Black/White	0.08 (2.0)	5 (7)	500 m Spool
12-001-13	2	22 (0.6)	Red/White	0.08 (2.0)	5 (7)	305 m Spool
12-003-13	2	22 (0.6)	Blue/White	0.08 (2.0)	5 (7)	1,000' Spool
12-005-13	2	22 (0.6)	Black/White	0.08 (2.0)	5 (7)	1,000' Spool
12-101-13	2	24 (0.5)	Red/White	0.08 (2.0)	4 (6)	1,000' Spool
12-102-13	2	24 (0.5)	Red/Yellow	0.08 (2.0)	4 (6)	1,000' Spool
12-103-13	2	24 (0.5)	White/Blue	0.08 (2.0)	4 (6)	1,000' Spool
12-104-13	2	24 (0.5)	Violet/Blue	0.08 (2.0)	4 (6)	305 m Spool
12-105-13	2	24 (0.5)	Black/White	0.08 (2.0)	4 (6)	1,000' Spool
12-106-13	2	24 (0.5)	Red/White	0.08 (2.0)	4 (6)	6,000' Spool
12-107-13	2	24 (0.5)	Black/White	0.08 (2.0)	4 (6)	6,000' Spool
12-108-13	2	24 (0.5)	White/Blue	0.08 (2.0)	4 (6)	6,000' Spool
12-109-13	2	24 (0.5)	Yellow/Blue	0.08 (2.0)	4 (6)	1,000' Spool
12-112-13	2	24 (0.5)	Red/White	0.08 (2.0)	4 (6)	3,000' Parallel cone
12-304-13	2	22 (0.6)	Brown/Blue	0.08 (2.0)	5 (7)	1,000 m Parallel cone
12-305-13	2	22 (0.6)	Black/White	0.08 (2.0)	5 (7)	1,000 m Parallel cone
12-311-13	2	22 (0.6)	Red/Green	0.08 (2.0)	5 (7)	3,000' Spool
12-313-13	2	22 (0.6)	Blue/White	0.08 (2.0)	5 (7)	3,280' Parallel cone
12-318-13	2	22 (0.6)	White/Orange	0.08 (2.0)	5 (7)	3,000' Spool
12-403-13	2	22 (0.6)	White/Blue	0.08 (2.0)	5 (7)	3,000' Spool
12-406-13	2	22 (0.6)	Yellow/Violet	0.08 (2.0)	5 (7)	3,000' Spool
12-501-13	2	22 (0.6)	Red/White	0.08 (2.0)	5 (7)	2,300' Spool
12-031-12	4	22 (0.6)	Blue/White, Red/Green	0.12 (3.0)	9 (13)	1,640' Parallel cone
12-032-13	4	22 (0.6)	Black/White, Black/White	0.12 (3.0)	9 (13)	1,640' Parallel cone
12-033-13	4	22 (0.6)	Yellow/Blue, Orange/Brown	0.12 (3.0)	9 (13)	1,640' Parallel cone
12-034-13	5	22 (0.6)	Yellow/Blue, Orange/Brown, Green	0.17 (4.3)	13 (20)	500 m Parallel cone
12-035-13	5	22 (0.6)	Black/White, Black/White, Green	0.17 (4.3)	13 (20)	500 m Parallel cone

UL is a registered trademark of UL LLC.

Heavy Duty Distribution Frame Wire

HD-DFW



SPECIFICATIONS

Conductor	Tinned copper
Insulation	Heavy duty, abrasion resistant PVC
Performance Compliance	ASTM B33 - Tinned Copper UL® 444 CSA C22.2 No. 214-08 UL 1666 GR-136-CORE (high stress use) Applicable GR-136 Core requirements for high stress applications RoHS-compliant/RoHS 2-compliant
NRTL Programs	UL, c(UL) Listed CMR

PRODUCT DESCRIPTION

Heavy Duty Distribution Frame Wire consists of 22 AWG tinned copper conductors with a heavy duty, abrasion resistant, flame retardant PVC insulation. HD-DFW is available in 2 or 4 conductors, and is used for making an interconnection between the incoming cable (tip termination) terminals and the equipment on the main distribution frame in the Central Office (CO). HD-DFW is suitable for use with either a solderless wrap or soldered terminals.

APPLICATIONS

- High stress use

FEATURES

- Solid tinned copper conductors in 22 AWG (0.6 mm) are insulated with PVC
- Each insulated conductor is identified by a solid insulation color
- Heavy duty insulation

BENEFITS

- Facilitates solid connections
- Easy identification
- Added protection for long runs

PART NUMBERS AND PHYSICAL CHARACTERISTICS

Part Number	Number of Conductors	AWG (mm)	Insulation Color	Nominal Diameter in (mm)	Approx. Weight lbs/kft (kg/km)	Standard Length ft (m)	Package
12-201-15	2	22 (0.6)	White/Blue	0.08 (2.0)	5 (7)	3,000 (914)	Parallel cone
12-202-15	2	22 (0.6)	White/Blue	0.08 (2.0)	5 (7)	574 (175)	Parallel cone
12-203-15	2	22 (0.6)	White/Blue	0.08 (2.0)	5 (7)	3,281 (1,000)	Parallel cone
12-204-15	2	22 (0.6)	White/Green	0.08 (2.0)	5 (7)	3,000 (914)	Parallel cone
12-205-15	2	22 (0.6)	White/Orange	0.08 (2.0)	5 (7)	3,000 (914)	Parallel cone
12-206-15	2	22 (0.6)	White/Red	0.08 (2.0)	5 (7)	3,000 (914)	Parallel cone
12-207-15	2	22 (0.6)	Yellow/Black	0.08 (2.0)	5 (7)	3,000 (914)	Parallel cone
12-208-15	2	22 (0.6)	Yellow/Green	0.08 (2.0)	5 (7)	3,000 (914)	Parallel cone
12-209-15	2	22 (0.6)	Yellow/Orange	0.08 (2.0)	5 (7)	3,000 (914)	Parallel cone
12-210-15	2	22 (0.6)	Black/Orange	0.08 (2.0)	5 (7)	3,000 (914)	Parallel cone
12-211-15	2	22 (0.6)	Orange/Blue	0.08 (2.0)	5 (7)	3,000 (914)	Parallel cone
12-216-15	2	22 (0.6)	Black/Green	0.08 (2.0)	5 (7)	3,000 (914)	Parallel cone
12-401-15	4	22 (0.6)	White/Blue, Red/Green	0.12 (3.0)	9 (13)	1,500 (457)	Parallel cone
12-402-15	4	22 (0.6)	Yellow/Blue, Red/Green	0.12 (3.0)	9 (13)	1,500 (457)	Parallel cone

UL is a registered trademark of UL LLC.

Tight Twist Distribution Frame Wire

DFW

PRODUCT DESCRIPTION

Tight Twist Distribution Frame Wire is necessary for the deployment of both xDSL and HI-CAP (T-1/HDSL) circuits within the distribution frames of central offices. This higher capacity frame wire is manufactured with a tight twist to minimize the impacts of electromagnetic interferences within this indoor environment. The Tight Twist Distribution Frame Wire is available in a 24 gauge size with a heavy duty flame retardant PVC insulation. Heavy duty in this application means a higher level of abrasion resistance, higher cut through and a higher temperature rating. The 22 AWG product is intended for use on main distribution frames (conventional type), while the 24 AWG is intended for use on COSMIC (Modular) distributing frames. The product is available in various put-ups.



APPLICATIONS

- xDSL
- HI-CAP
- T-1/HDSL
- High stress use

FEATURES

- 24 AWG solid tinned annealed copper
- Heavy duty, high temperature, high stress insulation
- Twisting sufficient to meet xDSL requirements

BENEFITS

- Facilitates solid connection
- Added protection for long wire runs
- Twist pattern sufficient for xDSL transmission level

SPECIFICATIONS

Conductor	Tinned copper
Insulation	Flame retardant PVC
Performance Compliance	ASTM B33 - Tinned Copper UL® 444 CSA C22.2 No. 214-08 Applicable GR-136 Core requirement for high stress applications RoHS-compliant/RoHS 2-compliant
NRTL Programs	UL, c(UL) Listed CM

PART NUMBERS AND PHYSICAL CHARACTERISTICS

Part Number	AWG (mm)	Insulation Color	Nominal Diameter in (mm)	Standard Length ft (m)	Package
12-217-T5	24 (0.5)	Violet/Blue	0.07 (1.8)	500 (152)	Spool
12-218-T5	24 (0.5)	Violet/Blue	0.07 (1.8)	1,000 (305)	Spool

UL is a registered trademark of UL LLC.



800.551.8948
SuperiorEssex.com

All information, content, data, specifications, packaging and part numbers detailed herein are subject to change. For the most up-to-date information, please visit SuperiorEssex.com. Purchase of this product is subject exclusively to the then current **Superior Essex International LP Terms and Conditions of Sale for Communications and Energy Cable, Wire and Connectivity Products**, which can be found on our website, SuperiorEssex.com, or provided to you upon request.

OSP FIBER CABLE

Dri-Lite® Loose Tube Single Jacket All Dielectric Series 11D	B-2
Dri-Lite® Loose Tube Double Jacket Non-Armor Series 1GD	B-3
Dri-Lite® Loose Tube Single Jacket Single Armor Series 12D	B-4
Dri-Lite® Loose Tube Double Jacket Single Armor Series 1AD	B-5
Dri-Lite® Loose Tube Double Jacket Double Armor Series 1DD	B-6
Dri-Lite® Loose Tube Triple Jacket Double Armor Series 1CD	B-7
Loose Tube Single Jacket All Dielectric Series 11	B-8
Loose Tube Double Jacket Non-Armor Series 1G	B-9
Loose Tube Single Jacket Single Armor Series 12	B-10
Loose Tube Double Jacket Single Armor Series 1A	B-11
Loose Tube Double Jacket Double Armor Series 1D	B-12
Loose Tube Triple Jacket Double Armor Series 1C	B-13
Dri-Lite® Loose Tube Single Jacket Self Support Series 11DM	B-14
Dri-Lite® Loose Tube Double Jacket Self Support Series 1GDM	B-15
Dri-Lite® Loose Tube Single Jacket Single Armor Self Support Series 12DM	B-16
Dri-Lite® Loose Tube Double Jacket Single Armor Self Support Series 1ADM	B-17
Loose Tube Single Jacket Self Support Series 11M	B-18
Loose Tube Double Jacket Self Support Series 1GM	B-19
Loose Tube Single Jacket Single Armor Self Support Series 12M	B-20
Loose Tube Double Jacket Single Armor Self Support Series 1AM	B-21
Dri-Lite® Loose Tube Single Jacket Long-Span Self Support Series 11MLS	B-22
ADSS 100 Series 1F100	B-23
ADSS 200 Series 1F200	B-24
ADSS 400 Series 1F400	B-25
Single Loose Tube All Dielectric Series 51	B-26
Single Loose Tube Single Armor Series 52	B-27
Single Flex Tube All Dielectric Series F1	B-28
Single Flex Tube Single Armor Series F2	B-29
Flex Tube Locate Series FM	B-30
Ribbon Locate Series RM	B-31
Loose Tube Single Jacket All Dielectric Nylon Series 1NY	B-32
Dri-Lite® Loose Tube Indoor/Outdoor OFNR Series 13D	B-33
Loose Tube Indoor/Outdoor OFNR Series 13	B-34
Interlock Armored OSP Fiber OFCR Series 13I	B-35
Loose Tube Single Jacket All Dielectric Indoor/Outdoor LSZH Series HZD	B-36
Loose Tube Single Jacket Single Armor Indoor/Outdoor LSZH Series HZA	B-37
Single Loose Tube Indoor/Outdoor OFNR Series 53	B-38
Heavy Duty Loose Tube OFNR Series 1H	B-39
Loose Tube 12 AWG Composite Series 1N	B-40
UG FTTP Series 513	B-41
Buried FTTP, Steel Armor Series 52S	B-42
Buried FTTP, Steel Armor Series 52U	B-43
Figure 8 FTTP Series 573Q	B-44
Buried FTTP, Aluminum Armor Series 523	B-45
Buried Drop Composite, Aluminum Armor Series 72	B-46
Buried Drop Composite, Steel Armor Series 72S	B-47
Universal Drop FTTP Series 6U	B-48
Toneable Drop FTTP Series 6T	B-49
Universal Flex FTTP Series 6S	B-50
Toneable Flex FTTP Series 6R	B-51
Universal FTTP Tight Buffered Indoor/Outdoor Drop Series W7U	B-52
Toneable FTTP Tight Buffered Indoor/Outdoor Drop Series W7T	B-53
Dri-Lite® Ribbon Series R1D	B-54
Dri-Lite® Ribbon Single Armor Series R2D	B-55
Stranded Tube Ribbon Single Armor Series S2	B-57
Single Tube Ribbon Series R1	B-58
Single Tube Ribbon Single Armor Series R2	B-59

OSP COMPOSITE CABLE

Composite Right of Way Series MR	B-60
Composite Category 5e Drop Series 5F	B-61
Composite Drop Web Series 5W	B-62
Composite Drop Overjacket Series 71 OJ	B-63
Composite OSP Web Series 5V	B-64
Composite OSP Overjacket Series 70 OJ	B-65
Composite Round CF Series L	B-66

RDUP/RUS OSP COPPER CABLE

SEALPIC®	B-68
SEALPIC®-84	B-70
SEALPIC®-FSF-84	B-72
SEALPIC®-FSF RDUP PE-89	B-74
CASPIC®-FSF RDUP PE-89	B-76
SEALPIC®-F RDUP PE-39	B-78
CUPIC-F® RDUP PE-39	B-80
GOPIC®-F RDUP PE-39	B-82

BELL OSP COPPER CABLE

ALPETH BHBA, BHAA, BKMA and BKTA	B-84
PASP BHBH, BHAB, BKMH and BKTH	B-86
Self-Support BHAS and BKMS	B-88
Reinforced Self-Support BHAP, BKMP and BKTP	B-89
Bonded STALPETH DCAZ, DCMZ and DCTZ	B-90
STEAMPETH DKTN	B-92
Power Station High Potential Filled ASP CMAW	B-93
Filled ALPETH ANBA, ANAA, ANMA and ANTA	B-94
Filled ASP ANBV, ANAW, ANMW and ANTW	B-96
T-SCREEN® Filled ASP KNAW and KNMW	B-99

CANADIAN OSP COPPER CABLE

CELLFIB BJBB, BJAB, BJMB and BJTB	B-100
Canadian ALPETH BHBB, BHAB, BKMB and BKTB	B-102
SEALPAP BHHF, BHAF, BKMF and BKTF	B-104
Canadian Bonded STALPETH DCAZ, DCMZ and DCTZ	B-106
Aerial Drop Wire ADW	B-110
Canadian Integrated Messenger Wire IM/F, IM/H and IM/G	B-108
Canadian ADP NMS with QuickCount® in Meters	B-109
Buried Distribution Wire BCBD	B-111

OSP COPPER WIRE

C-Rural Wire	B-112
IMRDW	B-113
IMRDWS	B-114
ADP NMS	B-115
ADP NMS Compact Design 6 x 24	B-116
ADP S	B-117
Integrated Messenger Wire IM/F, IM/H and IM/G	B-118
BDW A	B-119
BDW G	B-120
BW GDJ	B-121
BW AF	B-123
Non-Jacketed Tight Twist Cable Core	B-124
Air Pipe	B-124
Bridle Wire	B-125
Temporary Drop Wire TDW	B-125
E-Block Wire	B-126
Ground Wire Bare or Jacketed	B-127
Cross-Connect Category 5 Wire XCW	B-128
Indoor/Outdoor Cross-Connect Wire XCW	B-129

Dri-Lite® Loose Tube Single Jacket All Dielectric

Series 11D

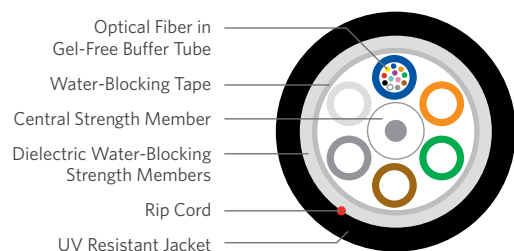

PRODUCT DESCRIPTION

Loose tube cables are the product of choice as the backbone in Outside Plant (OSP) environments. The durable loose tube design offers reliable transmission performance over a broad temperature range. Optical fibers and water-blocking elements are placed inside gel-free buffer tubes. The core is constructed by stranding the buffer tubes around a central member using a reverse oscillating lay (ROL). The core is wrapped with flexible strength members covered with a water-blocking tape, then encased with a black jacket. A rip cord is included under the jacket for ease of entry.

APPLICATIONS

- Underground duct and lashed aerial
- Trunk, distribution and feeder cable
- Local loop, metro, long-haul and broadband network

FEATURES

- Available with up to 288-fiber
- Multiple fiber types including hybrids
- Central strength members available in metallic or dielectric
- Dry (SAP) core standard
- Standard tube size for all fiber counts
- Gel-free tubes

BENEFITS

- High fiber density
- Multiple network applications
- Metallic option offers ease of location, dielectric design eliminates grounding issues
- Reduces cable prep and installation time
- Reduces the number of tools required
- Speeds fiber access and cleanup

SPECIFICATIONS

Fiber Count	Available in 12-fiber up to 288-fiber
Standards Compliance	Telcordia® GR-20-CORE RDUP PE-90 Designation MLT ICEA S-87-640-2011 RoHS-compliant

Telcordia is a registered trademark of Ericsson Inc.

ENVIRONMENTAL SPECIFICATIONS

Operation/Storage	-40°C to +70°C
Installation	-30°C to +70°C

PART NUMBER KEY

1	1	_	_	_	x	D	0	y
1	2	3	4	5	6	7	8	9
Product family	Fiber count (012-288)	Fiber type	Internal designator	Water block/ marking (1-8)				

Contact Customer Service for availability of non-standard offerings.

PART NUMBERS AND PHYSICAL CHARACTERISTICS

Part Number ¹	Fiber Count	Nominal Diameter in (mm)	Approx. Weight lbs/kft (kg/km)	Maximum Tensile Loading		Minimum Bend Radius	
				Install lbs (N)	Long Term lbs (N)	Install in (mm)	Long Term in (mm)
11012xD0y	12	0.41 (10.3)	47 (70)	600 (2,700)	200 (890)	8.2 (206)	4.1 (103)
11024xD0y	24	0.41 (10.3)	47 (70)	600 (2,700)	200 (890)	8.2 (206)	4.1 (103)
11036xD0y	36	0.41 (10.3)	47 (70)	600 (2,700)	200 (890)	8.2 (206)	4.1 (103)
11048xD0y	48	0.41 (10.3)	47 (70)	600 (2,700)	200 (890)	8.2 (206)	4.1 (103)
11060xD0y	60	0.41 (10.3)	47 (70)	600 (2,700)	200 (890)	8.2 (206)	4.1 (103)
11072xD0y	72	0.43 (11.0)	61 (91)	600 (2,700)	200 (890)	8.6 (220)	4.3 (110)
11096xD0y	96	0.50 (12.7)	79 (118)	600 (2,700)	200 (890)	10.0 (254)	5.0 (127)
11144xD0y	144	0.63 (16.0)	124 (185)	600 (2,700)	200 (890)	12.6 (320)	6.3 (160)
11216xD0y	216	0.63 (16.0)	120 (179)	600 (2,700)	200 (890)	12.6 (320)	6.3 (160)
11288xD0y	288	0.74 (18.9)	161 (240)	600 (2,700)	200 (890)	14.8 (378)	7.4 (189)

FIBER TYPES:

SINGLE MODE

Reduced Water Peak	Zero Water Peak	TeraFlex® Bend Resistant		
		G.657.A1	G.657.A2	G.657.B3
		NZDS	LEAF	

HYBRID

Hybrid

MULTIMODE

TeraGain®	TeraFlex Bend Resistant Laser Optimized 50/125	
62.5/125	10G/150	10G/300
		10G/550

¹Replace "x" with:

3	2	K	J	L	8	S
---	---	---	---	---	---	---

See "Optical Fiber Specifications" in the "Technical Information" section for detailed fiber type specifications.

WATER BLOCK AND JACKET PRINT CODES

Dry core		Dry core special	
Feet	Meters	Feet	Meters

¹Replace "y" with: 1 2 5 6

Dri-Lite® Loose Tube Double Jacket Non-Armor

Series 1GD

PRODUCT DESCRIPTION

Loose tube cables are the product of choice as the backbone in Outside Plant (OSP) environments. The durable loose tube design offers reliable transmission performance over a broad temperature range. Optical fibers are placed inside gel-free buffer tubes. The core is constructed by stranding the buffer tubes around a central member using a reverse oscillating lay (ROL). The core is wrapped with flexible strength members covered with a water-blocking tape, then encased with a black inner jacket. Water-blocking yarns and a black outer jacket are applied. Rip cords are included under each jacket for ease of entry.

APPLICATIONS

- Underground duct and lashed aerial
- Trunk, distribution and feeder cables
- Local loop, metro, long-haul and broadband network

FEATURES

- Available with up to 288-fiber
- Multiple fiber types including hybrids
- Central strength members available in metallic or dielectric
- Dry (SAP) core standard
- Standard tube size for all fiber counts
- Gel-free tubes

BENEFITS

- High fiber density
- Multiple network applications
- Metallic option offers ease of location, dielectric design eliminates grounding issues
- Reduces cable prep and installation time
- Reduces the number of tools required
- Speeds fiber access and cleanup

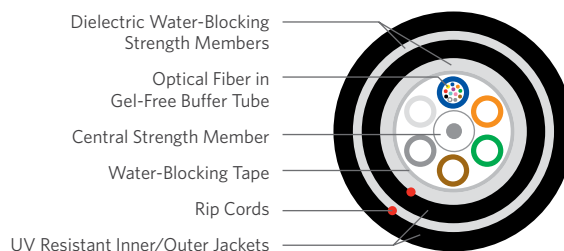

SPECIFICATIONS

Fiber Count	Available in 12-fiber up to 288-fiber
Standards Compliance	Telcordia® GR-20-CORE RDUP PE-90 Designation MLT ICEA S-87-640-2011 RoHS-compliant

Telcordia is a registered trademark of Ericsson Inc.

ENVIRONMENTAL SPECIFICATIONS

Operation/Storage	-40°C to +70°C
Installation	-30°C to +70°C

PART NUMBER KEY

1	G	-	-	-	x	D	0	y
1	2	3	4	5	6	7	8	9
Product family	Fiber count (012-288)	Fiber type	Internal designator	Water block/ marking (1-8)				

Contact Customer Service for availability of non-standard offerings.

PART NUMBERS AND PHYSICAL CHARACTERISTICS

Part Number ¹	Fiber Count	Nominal Diameter in (mm)	Approx. Weight lbs/kft (kg/km)	Maximum Tensile Loading		Minimum Bend Radius	
				Install lbs (N)	Long Term lbs (N)	Install in (mm)	Long Term in (mm)
1G012xD0y	12	0.50 (12.8)	73 (109)	600 (2,700)	200 (890)	10.0 (256)	5.0 (128)
1G024xD0y	24	0.50 (12.8)	73 (109)	600 (2,700)	200 (890)	10.0 (256)	5.0 (128)
1G036xD0y	36	0.50 (12.8)	73 (109)	600 (2,700)	200 (890)	10.0 (256)	5.0 (128)
1G048xD0y	48	0.50 (12.8)	73 (109)	600 (2,700)	200 (890)	10.0 (256)	5.0 (128)
1G072xD0y	72	0.53 (13.4)	86 (128)	600 (2,700)	200 (890)	10.6 (268)	5.3 (134)
1G096xD0y	96	0.59 (15.1)	110 (164)	600 (2,700)	200 (890)	11.8 (302)	5.9 (151)
1G144xD0y	144	0.72 (18.4)	162 (242)	600 (2,700)	200 (890)	14.4 (368)	7.2 (184)
1G216xD0y	216	0.72 (18.4)	157 (235)	600 (2,700)	200 (890)	14.4 (368)	7.2 (184)
1G288xD0y	288	0.84 (21.3)	205 (306)	600 (2,700)	200 (890)	16.8 (426)	8.4 (213)

FIBER TYPES:

SINGLE MODE

Reduced Water Peak	Zero Water Peak	TeraFlex® Bend Resistant				NZDS	LEAF
		G.657.A1	G.657.A2	G.657.B3			

¹Replace "x" with:

3	2	K	J	L	8	S
---	---	---	---	---	---	---

HYBRID

Hybrid
H

MULTIMODE

TeraGain®	TeraFlex Bend Resistant Laser Optimized 50/125		
62.5/125	10G/150	10G/300	10G/550

6	M	N	P
---	---	---	---

See "Optical Fiber Specifications" in the "Technical Information" section for detailed fiber type specifications.

WATER BLOCK AND JACKET PRINT CODES

Dry core		Dry core special	
Feet	Meters	Feet	Meters

¹Replace "y" with:

1	2	5	6
---	---	---	---

Dri-Lite® Loose Tube Single Jacket Single Armor

Series 12D

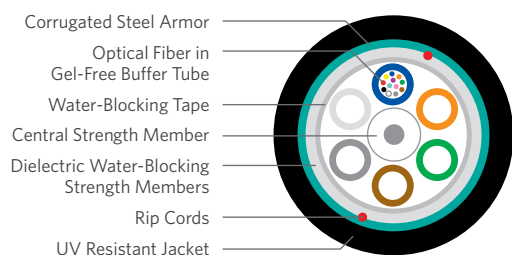

PRODUCT DESCRIPTION

Loose tube cables are the product of choice as the backbone in Outside Plant (OSP) environments. The durable loose tube design offers reliable transmission performance over a broad temperature range. Optical fibers and water-blocking elements are placed inside gel-free buffer tubes. The core is constructed by stranding the buffer tubes around a central member using a reverse oscillating lay (ROL). The core is wrapped with flexible strength members covered with a water-blocking tape. A corrugated steel armor is applied and then encased with a black jacket. Rip cords are included under the armor for ease of entry.

APPLICATIONS

- Direct bury, underground duct and lashed aerial
- Trunk, distribution and feeder cable
- Local loop, metro, long-haul and broadband network

FEATURES

- Available with up to 288-fiber
- Multiple fiber types including hybrids
- Dry (SAP) core standard
- Standard tube size for all fiber counts
- Corrugated steel armor
- Gel-free tubes

BENEFITS

- High fiber density
- Multiple network applications
- Reduces cable prep and installation time
- Reduces the number of tools required
- Improves compressive strength and rodent protection
- Speeds fiber access and cleanup

SPECIFICATIONS

Fiber Count Available in 12-fiber up to 288-fiber

Standards Compliance Telcordia® GR-20-CORE
RDUP PE-90 Designation MLT
ICEA S-87-640-2011
RoHS-compliant

Telcordia is a registered trademark of Ericsson Inc.

ENVIRONMENTAL SPECIFICATIONS

Operation/Storage -40°C to +70°C

Installation -30°C to +70°C

PART NUMBER KEY

1	2	-	-	-	x	D	0	y
1	2	3	4	5	6	7	8	9
Product family	Fiber count (012-288)			Fiber type	Internal designator	Water block/markings (1-8)		

Contact Customer Service for availability of non-standard offerings.

PART NUMBERS AND PHYSICAL CHARACTERISTICS

Part Number ¹	Fiber Count	Nominal Diameter in (mm)	Approx. Weight lbs/kft (kg/km)	Maximum Tensile Loading		Minimum Bend Radius	
				Install lbs (N)	Long Term lbs (N)	Install in (mm)	Long Term in (mm)
12012xD0y	12	0.46 (11.7)	84 (125)	600 (2,700)	200 (890)	9.2 (234)	4.6 (117)
12024xD0y	24	0.46 (11.7)	84 (125)	600 (2,700)	200 (890)	9.2 (234)	4.6 (117)
12036xD0y	36	0.46 (11.7)	84 (125)	600 (2,700)	200 (890)	9.2 (234)	4.6 (117)
12048xD0y	48	0.46 (11.7)	84 (125)	600 (2,700)	200 (890)	9.2 (234)	4.6 (117)
12072xD0y	72	0.49 (12.3)	100 (149)	600 (2,700)	200 (890)	9.8 (246)	4.9 (123)
12096xD0y	96	0.56 (14.3)	125 (186)	600 (2,700)	200 (890)	11.2 (286)	5.6 (143)
12144xD0y	144	0.69 (17.6)	182 (271)	600 (2,700)	200 (890)	13.8 (352)	6.9 (176)
12216xD0y	216	0.69 (17.6)	177 (264)	600 (2,700)	200 (890)	13.8 (352)	6.9 (176)
12288xD0y	288	0.80 (20.3)	228 (340)	600 (2,700)	200 (890)	16.0 (406)	8.0 (203)

FIBER TYPES:

SINGLE MODE

Reduced Water Peak Zero Water Peak TeraFlex® Bend Resistant
G.657.A1 G.657.A2 G.657.B3 NZDS LEAF

¹Replace "x" with: 3 2 K J L 8 S

HYBRID

Hybrid

MULTIMODE

TeraGain® TeraFlex Bend Resistant Laser Optimized 50/125
62.5/125 10G/150 10G/300 10G/550

6 M N P

See "Optical Fiber Specifications" in the "Technical Information" section for detailed fiber type specifications.

WATER BLOCK AND JACKET PRINT CODES

Dry core Dry core special
Feet Meters Feet Meters

¹Replace "y" with: 1 2 5 6

Dri-Lite® Loose Tube Double Jacket Single Armor

Series 1AD

PRODUCT DESCRIPTION

Loose tube cables are the product of choice as the backbone in Outside Plant (OSP) environments. The durable loose tube design offers reliable transmission performance over a broad temperature range. Optical fibers are placed inside gel-free buffer tubes. The core is constructed by stranding the buffer tubes around a central member using a reverse oscillating lay (ROL). The core is wrapped with flexible strength members covered with a water-blocking tape then encased with a black inner jacket. Water-blocking yarns and a corrugated steel armor are applied and a black outer jacket completes the cable construction. Rip cords are included under the inner jacket and armor for ease of entry.

APPLICATIONS

- Direct bury, underground duct and lashed aerial
- Trunk, distribution and feeder cables
- Local loop, metro, long-haul and broadband network

FEATURES

- Available with up to 288-fiber
- Multiple fiber types including hybrids
- Dry (SAP) core standard
- Standard tube size for all fiber counts
- Corrugated steel armor
- Gel-free tubes

BENEFITS

- High fiber density
- Multiple network applications
- Reduces cable prep and installation time
- Reduces the number of tools required
- Improves compressive strength and rodent protection
- Speeds fiber access and cleaning

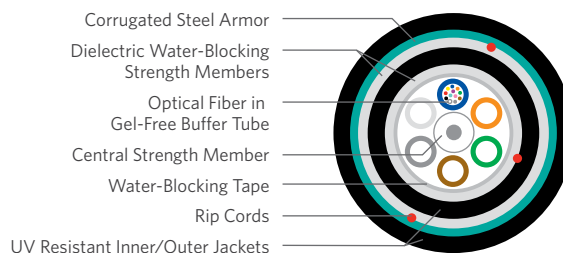

SPECIFICATIONS

Fiber Count	Available in 12-fiber up to 288-fiber
Standards Compliance	Telcordia® GR-20-CORE RDUP PE-90 Designation MLT ICEA S-87-640-2011 RoHS-compliant

Telcordia is a registered trademark of Ericsson Inc.

ENVIRONMENTAL SPECIFICATIONS

Operation/Storage	-40°C to +70°C
Installation	-30°C to +70°C

PART NUMBER KEY

1	A	-	-	-	x	D	0	y
1	2	3	4	5	6	7	8	9
Product family	Fiber count (012-288)				Fiber type	Internal designator	Water block/markings (1-8)	

Contact Customer Service for availability of non-standard offerings.

PART NUMBERS AND PHYSICAL CHARACTERISTICS

Part Number ¹	Fiber Count	Nominal Diameter in (mm)	Approx. Weight lbs/kft (kg/km)	Maximum Tensile Loading		Minimum Bend Radius	
				Install lbs (N)	Long Term lbs (N)	Install in (mm)	Long Term in (mm)
1A012xD0y	12	0.56 (14.1)	119 (178)	600 (2,700)	200 (890)	11.2 (282)	5.6 (141)
1A024xD0y	24	0.56 (14.1)	119 (178)	600 (2,700)	200 (890)	11.2 (282)	5.6 (141)
1A036xD0y	36	0.56 (14.1)	119 (178)	600 (2,700)	200 (890)	11.2 (282)	5.6 (141)
1A048xD0y	48	0.56 (14.1)	119 (178)	600 (2,700)	200 (890)	11.2 (282)	5.6 (141)
1A072xD0y	72	0.58 (14.9)	138 (206)	600 (2,700)	200 (890)	11.6 (298)	5.8 (149)
1A096xD0y	96	0.65 (16.6)	166 (248)	600 (2,700)	200 (890)	13.0 (322)	6.5 (166)
1A144xD0y	144	0.78 (19.9)	230 (343)	600 (2,700)	200 (890)	15.6 (398)	7.8 (199)
1A216xD0y	216	0.78 (19.9)	226 (336)	600 (2,700)	200 (890)	15.6 (398)	7.8 (199)
1A288xD0y	288	0.90 (22.9)	283 (422)	600 (2,700)	200 (890)	18.0 (458)	9.0 (229)

FIBER TYPES:

SINGLE MODE

Reduced Water Peak	Zero Water Peak	TeraFlex® Bend Resistant				NZDS	LEAF
		G.657.A1	G.657.A2	G.657.B3			

¹Replace "x" with:

3	2	K	J	L	8	S
---	---	---	---	---	---	---

HYBRID

Hybrid
H

MULTIMODE

TeraGain®	TeraFlex Bend Resistant Laser Optimized 50/125		
62.5/125	10G/150	10G/300	10G/550

6	M	N	P
---	---	---	---

See "Optical Fiber Specifications" in the "Technical Information" section for detailed fiber type specifications.

WATER BLOCK AND JACKET PRINT CODES

Dry core		Dry core special	
Feet	Meters	Feet	Meters

¹Replace "y" with:

1	2	5	6
---	---	---	---

Dri-Lite® Loose Tube Double Jacket Double Armor

Series 1DD

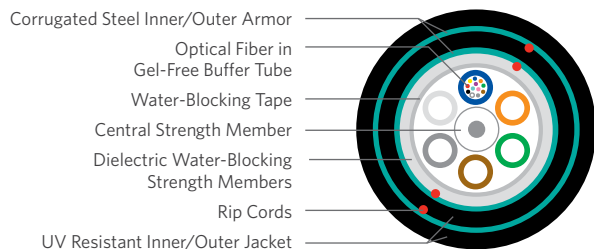

PRODUCT DESCRIPTION

Loose tube cables are the product of choice as the backbone in Outside Plant (OSP) environments. The durable loose tube design offers reliable transmission performance over a broad temperature range. Optical fibers are placed inside gel-free buffer tubes. The core is constructed by stranding the buffer tubes around a central member using a reverse oscillating lay (ROL). The core is wrapped with flexible strength members and covered with a water-blocking tape. A corrugated steel armor is applied and encased with a black inner jacket. More water-blocking yarns, a corrugated steel armor and a black outer jacket complete the cable construction. Rip cords are included under each armor for ease of entry.

APPLICATIONS

- Direct bury, underground duct and lashed aerial
- Trunk, distribution and feeder cable
- Local loop, metro, long-haul and broadband network

FEATURES

- Available with up to 216-fiber
- Multiple fiber types including hybrids
- Dry (SAP) core standard
- Standard tube size for all fiber counts
- Corrugated steel armor
- Gel-free tubes

BENEFITS

- High fiber density
- Multiple network applications
- Reduces cable prep and installation time
- Reduces the number of tools required
- Improves compressive strength and rodent protection
- Speeds fiber access and cleanup

SPECIFICATIONS

Fiber Count Available in 12-fiber up to 216-fiber

Standards Compliance Telcordia® GR-20-CORE
RDUP PE-90 Designation MLT
ICEA S-87-640-2011
RoHS-compliant

Telcordia is a registered trademark of Ericsson Inc.

ENVIRONMENTAL SPECIFICATIONS

Operation/Storage -40°C to +70°C

Installation -30°C to +70°C

PART NUMBER KEY

1	D	_	_	_	x	D	0	y
1	2	3	4	5	6	7	8	9
Product family	Fiber count (012-216)			Fiber type	Internal designator	Water block/markings (1-8)		

Contact Customer Service for availability of non-standard offerings.

PART NUMBERS AND PHYSICAL CHARACTERISTICS

Part Number ¹	Fiber Count	Nominal Diameter in (mm)	Approx. Weight lbs/kft (kg/km)	Maximum Tensile Loading		Minimum Bend Radius	
				Install lbs (N)	Long Term lbs (N)	Install in (mm)	Long Term in (mm)
1D0y2xD0y	12	0.63 (16.1)	178 (266)	600 (2,700)	200 (890)	12.6 (322)	6.3 (161)
1D024xD0y	24	0.63 (16.1)	178 (266)	600 (2,700)	200 (890)	12.6 (322)	6.3 (161)
1D036xD0y	36	0.63 (16.1)	178 (266)	600 (2,700)	200 (890)	12.6 (322)	6.3 (161)
1D048xD0y	48	0.63 (16.1)	178 (266)	600 (2,700)	200 (890)	12.6 (322)	6.3 (161)
1D072xD0y	72	0.66 (16.9)	196 (293)	600 (2,700)	200 (890)	13.2 (338)	6.6 (169)
1D096xD0y	96	0.74 (18.9)	233 (348)	600 (2,700)	200 (890)	14.8 (378)	7.4 (189)
1D144xD0y	144	0.88 (22.4)	315 (470)	600 (2,700)	200 (890)	17.6 (448)	8.8 (224)
1D216xD0y	216	0.88 (22.4)	310 (463)	600 (2,700)	200 (890)	17.6 (448)	8.8 (224)

FIBER TYPES:

SINGLE MODE

Reduced Water Peak Zero Water Peak TeraFlex® Bend Resistant

G.657.A1 G.657.A2 G.657.B3 NZDS LEAF

¹Replace "x" with:

3 2 K J L 8 S

HYBRID

Hybrid

MULTIMODE

TeraGain® TeraFlex Bend Resistant Laser Optimized 50/125

62.5/125 10G/150 10G/300 10G/550

See "Optical Fiber Specifications" in the "Technical Information" section for detailed fiber type specifications.

WATER BLOCK AND JACKET PRINT CODES

Dry core Dry core special

Feet Meters Feet Meters

¹Replace "y" with: 1 2 5 6

Dri-Lite® Loose Tube Triple Jacket Double Armor

Series 1CD

PRODUCT DESCRIPTION

Loose tube cables are the product of choice as the backbone in Outside Plant (OSP) environments. The durable loose tube design offers reliable transmission performance over a broad temperature range. Optical fibers are placed inside gel-free buffer tubes. The core is constructed by stranding the buffer tubes around a central member using a reverse oscillating lay (ROL). The core is wrapped with flexible strength members covered with a water-blocking tape, then encased in a black inner jacket. Flexible strength members are applied with a corrugated steel armor and an intermediate black jacket. Another layer of flexible strength members with a corrugated steel armor and a black outer jacket completes the cable construction. Rip cords are included under the inner jacket and each armor for ease of entry.

APPLICATIONS

- Direct bury, underground duct and lashed aerial
- Trunk, distribution and feeder cables
- Local loop, metro, long-haul and broadband network

FEATURES

- Available with up to 144-fiber
- Multiple fiber types including hybrids
- Dry (SAP) core standard
- Standard tube size for all fiber counts
- Corrugated steel armor
- Gel-free tubes

BENEFITS

- High fiber density
- Multiple network applications
- Reduces cable prep and installation time
- Reduces the number of tools required
- Improves compressive strength and rodent protection
- Speeds fiber access and cleanup



- Corrugated Steel Inner/Outer Armor
- Optical Fiber in Gel-Free Buffer Tube
- Water-Blocking Tape
- Central Strength Member
- Dielectric Water-Blocking Strength Members
- Rip Cords
- UV Resistant Inner, Central and Outer Jackets

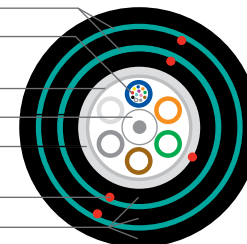

SPECIFICATIONS

Fiber Count	Available in 12-fiber up to 144-fiber
Standards Compliance	Telcordia® GR-20-CORE RDUP PE-90 Designation MLT ICEA S-87-640-2011 RoHS-compliant

Telcordia is a registered trademark of Ericsson Inc.

ENVIRONMENTAL SPECIFICATIONS

Operation/Storage	-40°C to +70°C
Installation	-30°C to +70°C

PART NUMBER KEY

1	C	_	_	_	x	D	0	y
1	2	3	4	5	6	7	8	9
Product family	Fiber count (012-144)				Fiber type	Internal designator	Water block/markings (1-8)	

Contact Customer Service for availability of non-standard offerings.

PART NUMBERS AND PHYSICAL CHARACTERISTICS

Part Number ¹	Fiber Count	Nominal Diameter in (mm)	Approx. Weight lbs/kft (kg/km)	Maximum Tensile Loading		Minimum Bend Radius	
				Install lbs (N)	Long Term lbs (N)	Install in (mm)	Long Term in (mm)
1C012xD0y	12	0.73 (18.6)	229 (341)	600 (2,700)	200 (890)	14.6 (372)	7.3 (186)
1C024xD0y	24	0.73 (18.6)	229 (341)	600 (2,700)	200 (890)	14.6 (372)	7.3 (186)
1C036xD0y	36	0.73 (18.6)	229 (341)	600 (2,700)	200 (890)	14.6 (372)	7.3 (186)
1C048xD0y	48	0.73 (18.6)	229 (341)	600 (2,700)	200 (890)	14.6 (372)	7.3 (186)
1C072xD0y	72	0.76 (19.4)	252 (376)	600 (2,700)	200 (890)	15.2 (384)	7.6 (194)
1C096xD0y	96	0.83 (21.1)	289 (431)	600 (2,700)	200 (890)	16.6 (422)	8.3 (211)
1C144xD0y	144	0.96 (24.4)	376 (560)	600 (2,700)	200 (890)	19.2 (488)	9.6 (244)

FIBER TYPES:

SINGLE MODE

Reduced Water Peak		Zero Water Peak		TeraFlex® Bend Resistant			
				G.657.A1	G.657.A2	G.657.B3	NZDS LEAF

¹Replace "x" with:

3	2	K	J	L	8	S
---	---	---	---	---	---	---

See "Optical Fiber Specifications" in the "Technical Information" section for detailed fiber type specifications.

HYBRID

Hybrid

H

MULTIMODE

TeraGain®	TeraFlex Bend Resistant Laser Optimized 50/125		
62.5/125	10G/150	10G/300	10G/550

6	M	N	P
---	---	---	---

WATER BLOCK AND JACKET PRINT CODES

Dry core		Dry core special	
Feet	Meters	Feet	Meters

¹Replace "y" with:

1	2	5	6
---	---	---	---

Loose Tube Single Jacket All Dielectric

Series 11

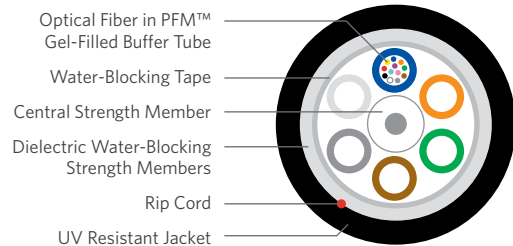

SPECIFICATIONS

Fiber Count Available in 2-fiber up to 288-fiber

Standards Compliance Telcordia® GR-20-CORE
RDUP PE-90 Designation MLT
ICEA S-87-640-2011
RoHS-compliant

Telcordia is a registered trademark of Ericsson Inc.

ENVIRONMENTAL SPECIFICATIONS

Operation/Storage -40°C to +70°C

Installation -30°C to +70°C

PART NUMBER KEY

1	1	-	-	-	x	x	0	y
1	2	3	4	5	6	7	8	9
Product family	Fiber count (002-288)				Fiber type	Internal designator	Water block/markings (1-8)	

Contact Customer Service for availability of non-standard offerings.

PART NUMBERS AND PHYSICAL CHARACTERISTICS

Part Number ¹	Fiber Count	Nominal Diameter in (mm)	Approx. Weight lbs/kft (kg/km)	Maximum Tensile Loading		Minimum Bend Radius	
				Install lbs (N)	Long Term lbs (N)	Install in (mm)	Long Term in (mm)
11006xx0y	6	0.41 (10.3)	47 (70)	600 (2,700)	200 (890)	8.2 (206)	4.1 (103)
11012xx0y	12	0.41 (10.3)	47 (70)	600 (2,700)	200 (890)	8.2 (206)	4.1 (103)
11018xx0y	18	0.41 (10.3)	47 (70)	600 (2,700)	200 (890)	8.2 (206)	4.1 (103)
11024xx0y	24	0.41 (10.3)	47 (70)	600 (2,700)	200 (890)	8.2 (206)	4.1 (103)
11036xx0y	36	0.41 (10.3)	47 (70)	600 (2,700)	200 (890)	8.2 (206)	4.1 (103)
11048xx0y	48	0.41 (10.3)	47 (70)	600 (2,700)	200 (890)	8.2 (206)	4.1 (103)
11060xx0y	60	0.41 (10.3)	47 (70)	600 (2,700)	200 (890)	8.2 (206)	4.1 (103)
11072xx0y	72	0.43 (11.0)	61 (91)	600 (2,700)	200 (890)	8.6 (220)	4.3 (110)
11096xx0y	96	0.50 (12.7)	79 (118)	600 (2,700)	200 (890)	10.0 (254)	5.0 (127)
11144xx0y	144	0.63 (16.0)	124 (185)	600 (2,700)	200 (890)	12.6 (320)	6.3 (160)
11216xx0y	216	0.63 (16.0)	120 (179)	600 (2,700)	200 (890)	12.6 (320)	6.3 (160)
11288xx0y	288	0.74 (18.9)	161 (240)	600 (2,700)	200 (890)	14.8 (378)	7.4 (189)

FIBER TYPES:

SINGLE MODE

HYBRID

MULTIMODE

	Reduced Water Peak	Zero Water Peak	TeraFlex® Bend Resistant				Hybrid	TeraGain® TeraFlex Bend Resistant Laser Optimized 50/125				
			G.657.A1	G.657.A2	G.657.B3	NZDS		LEAF	62.5/125	10G/150	10G/300	10G/550
¹ For ≤ 36 fibers replace "xx" with:	3T	2T	KT	JT	LT	8T	ST	H ₋	6G	MG	NG	PG
¹ For > 36 fibers replace "xx" with:	31	21	K1	J1	L1	81	S1					

See "Optical Fiber Specifications" in the "Technical Information" section for detailed fiber type specifications.

WATER BLOCK AND JACKET PRINT CODES

	Dry core		Dry core special	
	Feet	Meters	Feet	Meters
¹ Replace "y" with:	1	2	5	6

PRODUCT DESCRIPTION

Loose tube cables are the product of choice as the backbone in Outside Plant (OSP) environments. The durable loose tube design offers reliable transmission performance over a broad temperature range. Optical fibers are placed inside filled buffer tubes containing PFM™ gel. The core is constructed by stranding the buffer tubes around a central member using a reverse oscillating lay (ROL). The core is wrapped with flexible strength members covered with a water-blocking tape, then encased with a black jacket. A rip cord is included under the jacket for ease of entry.

APPLICATIONS

- Underground duct and lashed aerial
- Trunk, distribution and feeder cable
- Local loop, metro, long-haul and broadband network

FEATURES

- Available with up to 288-fiber
- Multiple fiber types including hybrids
- Central strength members available in metallic or dielectric
- Dry (SAP) core standard
- Standard tube size for all fiber counts
- PFM gel

BENEFITS

- High fiber density
- Multiple network applications
- Metallic option offers ease of location, dielectric design eliminates grounding issues
- Reduces cable prep and installation time
- Reduces the number of tools required
- Non-sticky gel speeds fiber access and cleanup

Loose Tube Double Jacket Non-Armor

Series 1G

PRODUCT DESCRIPTION

Loose tube cables are the product of choice as the backbone in Outside Plant (OSP) environments. The durable loose tube design offers reliable transmission performance over a broad temperature range. Optical fibers are placed inside filled buffer tubes containing PFM™ gel. The core is constructed by stranding the buffer tubes around a central member using a reverse oscillating lay (ROL). The core is wrapped with flexible strength members covered with a water-blocking tape, then encased with a black inner jacket. Water-blocking yarns and a black outer jacket are applied. Rip cords are included under each jacket for ease of entry.

APPLICATIONS

- Underground duct and lashed aerial
- Trunk, distribution and feeder cables
- Local loop, metro, long-haul and broadband network

FEATURES

- Available with up to 288-fiber
- Multiple fiber types including hybrids
- Central strength members available in metallic or dielectric
- Dry (SAP) core standard
- Standard tube size for all fiber counts
- PFM gel

BENEFITS

- High fiber density
- Multiple network applications
- Metallic option offers ease of location, dielectric design eliminates grounding issues
- Reduces cable prep and installation time
- Reduces the number of tools required
- Non-sticky gel speeds fiber access and clean-up

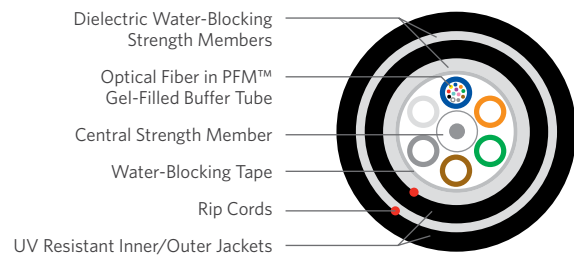

SPECIFICATIONS

Fiber Count	Available in 6-fiber up to 288-fiber
Standards Compliance	Telcordia® GR-20-CORE RDUP PE-90 Designation MLT ICEA S-87-640-2011 RoHS-compliant

Telcordia is a registered trademark of Ericsson Inc.

ENVIRONMENTAL SPECIFICATIONS

Operation/Storage	-40°C to +70°C
Installation	-30°C to +70°C

PART NUMBER KEY

1	G	_	_	_	x	x	0	y
1	2	3	4	5	6	7	8	9
Product family	Fiber count (006-288)				Fiber type	Internal designator	Water block/markings (1-8)	

Contact Customer Service for availability of non-standard offerings.

PART NUMBERS AND PHYSICAL CHARACTERISTICS

Part Number ¹	Fiber Count	Nominal Diameter in (mm)	Approx. Weight lbs/kft (kg/km)	Maximum Tensile Loading		Minimum Bend Radius	
				Install lbs (N)	Long Term lbs (N)	Install in (mm)	Long Term in (mm)
1G006xx0y	6	0.50 (12.8)	73 (109)	600 (2,700)	200 (890)	10.0 (256)	5.0 (128)
1G012xx0y	12	0.50 (12.8)	73 (109)	600 (2,700)	200 (890)	10.0 (256)	5.0 (128)
1G024xx0y	24	0.50 (12.8)	73 (109)	600 (2,700)	200 (890)	10.0 (256)	5.0 (128)
1G036xx0y	36	0.50 (12.8)	73 (109)	600 (2,700)	200 (890)	10.0 (256)	5.0 (128)
1G048xx0y	48	0.50 (12.8)	73 (109)	600 (2,700)	200 (890)	10.0 (256)	5.0 (128)
1G072xx0y	72	0.53 (13.4)	86 (128)	600 (2,700)	200 (890)	10.6 (268)	5.3 (134)
1G096xx0y	96	0.59 (15.1)	110 (164)	600 (2,700)	200 (890)	11.8 (302)	5.9 (151)
1G144xx0y	144	0.72 (18.4)	163 (242)	600 (2,700)	200 (890)	14.4 (368)	7.2 (184)
1G216xx0y	216	0.72 (18.4)	157 (235)	600 (2,700)	200 (890)	14.4 (368)	7.2 (184)
1G288xx0y	288	0.84 (21.3)	205 (306)	600 (2,700)	200 (890)	16.8 (426)	8.4 (213)

FIBER TYPES:

SINGLE MODE

	Reduced Water Peak	Zero Water Peak	TeraFlex® Bend Resistant				
			G.657.A1	G.657.A2	G.657.B3	NZDS	LEAF
¹ For ≤ 36 fibers replace "xx" with:	3T	2T	KT	JT	LT	8T	ST
¹ For > 36 fibers replace "xx" with:	31	21	K1	J1	L1	81	S1

HYBRID

Hybrid
H_

MULTIMODE

TeraGain®	TeraFlex Bend Resistant Laser Optimized 50/125			
	62.5/125	10G/150	10G/300	10G/550
6G	MG	NG	PG	

See "Optical Fiber Specifications" in the "Technical Information" section for detailed fiber type specifications.

WATER BLOCK AND JACKET PRINT CODES

	Dry core		Dry core special	
	Feet	Meters	Feet	Meters
¹ Replace "y" with:	1	2	5	6

Loose Tube Single Jacket Single Armor

Series 12

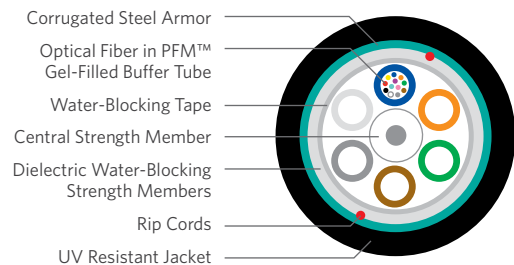

SPECIFICATIONS

Fiber Count Available in 2-fiber up to 288-fiber

Standards Compliance Telcordia® GR-20-CORE
RDUP PE-90 Designation MLT
ICEA S-87-640-2011
RoHS-compliant

Telcordia is a registered trademark of Ericsson Inc.

ENVIRONMENTAL SPECIFICATIONS

Operation/Storage -40°C to +70°C

Installation -30°C to +70°C

PART NUMBER KEY

1	2	3	4	5	6	7	8	9
Product family	Fiber count (002-288)		Fiber type	Internal designator	Water block/markings (1-8)			

Contact Customer Service for availability of non-standard offerings.

PART NUMBERS AND PHYSICAL CHARACTERISTICS

Part Number ¹	Fiber Count	Nominal Diameter in (mm)	Approx. Weight lbs/kft (kg/km)	Maximum Tensile Loading		Minimum Bend Radius	
				Install lbs (N)	Long Term lbs (N)	Install in (mm)	Long Term in (mm)
12006xx0y	6	0.46 (11.7)	84 (125)	600 (2,700)	200 (890)	9.2 (234)	4.6 (117)
12012xx0y	12	0.46 (11.7)	84 (125)	600 (2,700)	200 (890)	9.2 (234)	4.6 (117)
12018xx0y	18	0.46 (11.7)	84 (125)	600 (2,700)	200 (890)	9.2 (234)	4.6 (117)
12024xx0y	24	0.46 (11.7)	84 (125)	600 (2,700)	200 (890)	9.2 (234)	4.6 (117)
12036xx0y	36	0.46 (11.7)	84 (125)	600 (2,700)	200 (890)	9.2 (234)	4.6 (117)
12048xx0y	48	0.46 (11.7)	84 (125)	600 (2,700)	200 (890)	9.2 (234)	4.6 (117)
12072xx0y	72	0.49 (12.3)	100 (149)	600 (2,700)	200 (890)	9.8 (246)	4.9 (123)
12096xx0y	96	0.56 (14.3)	125 (186)	600 (2,700)	200 (890)	11.2 (286)	5.6 (143)
12144xx0y	144	0.69 (17.6)	182 (271)	600 (2,700)	200 (890)	13.8 (352)	6.9 (176)
12192xx0y	192	0.69 (17.6)	177 (264)	600 (2,700)	200 (890)	13.8 (352)	6.9 (176)
12216xx0y	216	0.69 (17.6)	177 (264)	600 (2,700)	200 (890)	13.8 (352)	6.9 (176)
12288xx0y	288	0.80 (20.3)	228 (340)	600 (2,700)	200 (890)	16.0 (406)	8.0 (203)

FIBER TYPES:

SINGLE MODE

HYBRID

MULTIMODE

	Reduced Water Peak	Zero Water Peak	TeraFlex® Bend Resistant				Hybrid	TeraGain® TeraFlex Bend Resistant Laser Optimized 50/125				
			G.657.A1	G.657.A2	G.657.B3	NZDS		LEAF	62.5/125	10G/150	10G/300	10G/550
¹ For ≤ 36 fibers replace "xx" with:	3T	2T	KT	JT	LT	8T	ST	H ₋	6G	MG	NG	PG
¹ For > 36 fibers replace "xx" with:	31	21	K1	J1	L1	81	S1					

See "Optical Fiber Specifications" in the "Technical Information" section for detailed fiber type specifications.

WATER BLOCK AND JACKET PRINT CODES

	Dry core		Dry core special	
	Feet	Meters	Feet	Meters
¹ Replace "y" with:	1	2	5	6

PRODUCT DESCRIPTION

Loose tube cables are the product of choice as the backbone in Outside Plant (OSP) environments. The durable loose tube design offers reliable transmission performance over a broad temperature range. Optical fibers are placed inside filled buffer tubes containing PFM™ gel. The core is constructed by stranding the buffer tubes around a central member using a reverse oscillating lay (ROL). The core is wrapped with flexible strength members covered with a water-blocking tape. A corrugated steel armor is applied and then encased with a black jacket. Rip cords are included under the armor for ease of entry.

APPLICATIONS

- Direct bury, underground duct and lashed aerial
- Trunk, distribution and feeder cable
- Local loop, metro, long-haul and broadband network

FEATURES

- Available with up to 288-fiber
- Multiple fiber types including hybrids
- Dry (SAP) core standard
- Standard tube size for all fiber counts
- Corrugated steel armor
- PFM gel

BENEFITS

- High fiber density
- Multiple network applications
- Reduces cable prep and installation time
- Reduces the number of tools required
- Improves compressive strength and rodent protection
- Non-sticky gel speeds fiber access and clean-up

Loose Tube Double Jacket Single Armor

Series 1A

PRODUCT DESCRIPTION

Loose tube cables are the product of choice as the backbone in Outside Plant (OSP) environments. The durable loose tube design offers reliable transmission performance over a broad temperature range. Optical fibers are placed inside filled buffer tubes containing PFM™ gel. The core is constructed by stranding the buffer tubes around a central member using a reverse oscillating lay (ROL). The core is wrapped with flexible strength members covered with a water-blocking tape then encased with a black inner jacket. Water-blocking yarns and a corrugated steel armor are applied and a black outer jacket completes the cable construction. Rip cords are included under the inner jacket and armor for ease of entry.

APPLICATIONS

- Direct bury, underground duct and lashed aerial
- Trunk, distribution and feeder cables
- Local loop, metro, long-haul and broadband network

FEATURES

- Available with up to 288-fiber
- Multiple fiber types including hybrids
- Dry (SAP) core standard
- Standard tube size for all fiber counts
- Corrugated steel armor
- PFM gel

BENEFITS

- High fiber density
- Multiple network applications
- Reduces cable prep and installation time
- Reduces the number of tools required
- Improves compressive strength and rodent protection
- Non-sticky gel speeds fiber access and clean-up

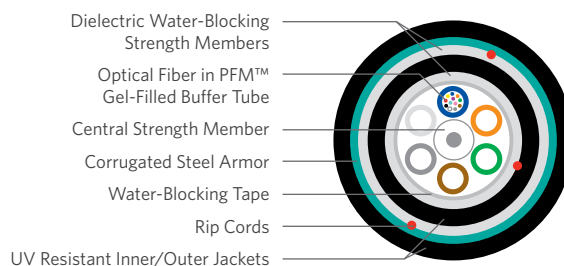

SPECIFICATIONS

Fiber Count	Available in 2-fiber up to 288-fiber
Standards Compliance	Telcordia® GR-20-CORE RDUP PE-90 Designation MLT ICEA S-87-640-2011 RoHS-compliant

Telcordia is a registered trademark of Ericsson Inc.

ENVIRONMENTAL SPECIFICATIONS

Operation/Storage	-40°C to +70°C
Installation	-30°C to +70°C

PART NUMBER KEY

1	A	—	—	—	x	x	0	y
1	2	3	4	5	6	7	8	9
Product family	Fiber count (002-288)	Fiber type	Internal designator	Water block/ marking (1-8)				

Contact Customer Service for availability of non-standard offerings.

PART NUMBERS AND PHYSICAL CHARACTERISTICS

Part Number ¹	Fiber Count	Nominal Diameter in (mm)	Approx. Weight lbs/kft (kg/km)	Maximum Tensile Loading		Minimum Bend Radius	
				Install lbs (N)	Long Term lbs (N)	Install in (mm)	Long Term in (mm)
1A006xx0y	6	0.56 (14.1)	119 (178)	600 (2,700)	200 (890)	11.2 (282)	5.6 (141)
1A012xx0y	12	0.56 (14.1)	119 (178)	600 (2,700)	200 (890)	11.2 (282)	5.6 (141)
1A024xx0y	24	0.56 (14.1)	119 (178)	600 (2,700)	200 (890)	11.2 (282)	5.6 (141)
1A036xx0y	36	0.56 (14.1)	119 (178)	600 (2,700)	200 (890)	11.2 (282)	5.6 (141)
1A048xx0y	48	0.56 (14.1)	119 (178)	600 (2,700)	200 (890)	11.2 (282)	5.6 (141)
1A072xx0y	72	0.58 (14.9)	138 (206)	600 (2,700)	200 (890)	11.6 (298)	5.8 (149)
1A096xx0y	96	0.65 (16.6)	166 (248)	600 (2,700)	200 (890)	13.0 (322)	6.5 (166)
1A144xx0y	144	0.78 (19.9)	230 (343)	600 (2,700)	200 (890)	15.6 (398)	7.8 (199)
1A216xx0y	216	0.78 (19.9)	226 (336)	600 (2,700)	200 (890)	15.6 (398)	7.8 (199)
1A288xx0y	288	0.90 (22.9)	283 (422)	600 (2,700)	200 (890)	18.0 (458)	9.0 (229)

FIBER TYPES:

SINGLE MODE

HYBRID

MULTIMODE

	Reduced Water Peak		Zero Water Peak		TeraFlex® Bend Resistant			Hybrid	TeraGain® Laser Optimized 50/125			
	3T	2T	G.657.A1	G.657.A2	G.657.B3	NZDS	LEAF		62.5/125	10G/150	10G/300	10G/550
¹ For ≤ 36 fibers replace "xx" with:	3T	2T	KT	JT	LT	8T	ST	H _L	6G	MG	NG	PG
¹ For > 36 fibers replace "xx" with:	31	21	K1	J1	L1	81	S1					

See "Optical Fiber Specifications" in the "Technical Information" section for detailed fiber type specifications.

WATER BLOCK AND JACKET PRINT CODES

	Dry core		Dry core special	
	Feet	Meters	Feet	Meters
¹ Replace "y" with:	1	2	5	6

Loose Tube Double Jacket Double Armor

Series 1D



Corrugated Steel Inner/Outer Armor
Optical Fiber in PFM™
Gel-Filled Buffer Tube
Water-Blocking Tape
Central Strength Member
Dielectric Water-Blocking
Strength Members
Rip Cords
UV Resistant Inner/Outer Jackets

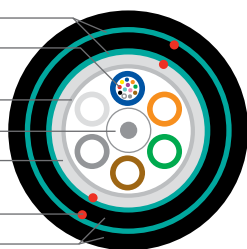

PRODUCT DESCRIPTION

Loose tube cables are the product of choice as the backbone in Outside Plant (OSP) environments. The durable loose tube design offers reliable transmission performance over a broad temperature range. Optical fibers are placed inside filled buffer tubes containing PFM™ gel. The core is constructed by stranding the buffer tubes around a central member using a reverse oscillating lay (ROL). The core is wrapped with flexible strength members and covered with a water-blocking tape. A corrugated steel armor is applied and encased with a black inner jacket. More water-blocking yarns, a corrugated steel armor and a black outer jacket complete the cable construction. Rip cords are included under each armor for ease of entry.

APPLICATIONS

- Direct bury, underground duct and lashed aerial
- Trunk, distribution and feeder cable
- Local loop, metro, long-haul and broadband network

SPECIFICATIONS

Fiber Count	Available in 6-fiber up to 288-fiber
Standards Compliance	Telcordia® GR-20-CORE RDUP PE-90 Designation MLT ICEA S-87-640-2011 RoHS-compliant

Telcordia is a registered trademark of Ericsson Inc.

ENVIRONMENTAL SPECIFICATIONS

Operation/Storage	-40°C to +70°C
Installation	-30°C to +70°C

PART NUMBER KEY

1	D	—	—	—	x	x	0	y
1	2	3	4	5	6	7	8	9
Product family	Fiber count (006-288)	Fiber type	Internal designator	Water block/markings (1-8)				

Contact Customer Service for availability of non-standard offerings.

PART NUMBERS AND PHYSICAL CHARACTERISTICS

Part Number ¹	Fiber Count	Nominal Diameter in (mm)	Approx. Weight lbs/kft (kg/km)	Maximum Tensile Loading		Minimum Bend Radius	
				Install lbs (N)	Long Term lbs (N)	Install in (mm)	Long Term in (mm)
1D006xx0y	6	0.63 (16.1)	178 (266)	600 (2,700)	200 (890)	12.6 (322)	6.3 (161)
1D012xx0y	12	0.63 (16.1)	178 (266)	600 (2,700)	200 (890)	12.6 (322)	6.3 (161)
1D024xx0y	24	0.63 (16.1)	178 (266)	600 (2,700)	200 (890)	12.6 (322)	6.3 (161)
1D036xx0y	36	0.63 (16.1)	178 (266)	600 (2,700)	200 (890)	12.6 (322)	6.3 (161)
1D048xx0y	48	0.63 (16.1)	178 (266)	600 (2,700)	200 (890)	12.6 (322)	6.3 (161)
1D072xx0y	72	0.66 (16.9)	196 (293)	600 (2,700)	200 (890)	13.2 (338)	6.6 (169)
1D096xx0y	96	0.74 (18.9)	233 (348)	600 (2,700)	200 (890)	14.8 (378)	7.4 (189)
1D144xx0y	144	0.88 (22.4)	315 (470)	600 (2,700)	200 (890)	17.6 (448)	8.8 (224)
1D216xx0y	216	0.88 (22.4)	310 (463)	600 (2,700)	200 (890)	17.6 (448)	8.8 (224)
1D288xx0y	288	0.99 (25.1)	377 (562)	600 (2,700)	200 (890)	19.8 (502)	9.9 (251)

FIBER TYPES:

SINGLE MODE

HYBRID

MULTIMODE

	Reduced Water Peak		Zero Water Peak		TeraFlex® Bend Resistant			Hybrid	TeraGain® TeraFlex Bend Resistant Laser Optimized 50/125			
	3T	2T	G.657.A1	G.657.A2	G.657.B3	NZDS	LEAF		62.5/125	10G/150	10G/300	10G/550
¹ For ≤ 36 fibers replace "xx" with:			KT	JT	LT	8T	ST	H_	6G	MG	NG	PG
¹ For > 36 fibers replace "xx" with:	31	21	K1	J1	L1	81	S1					

See "Optical Fiber Specifications" in the "Technical Information" section for detailed fiber type specifications.

WATER BLOCK AND JACKET PRINT CODES

	Dry core		Dry core special	
	Feet	Meters	Feet	Meters
¹ Replace "y" with:	1	2	5	6

FEATURES

- Available with up to 288-fiber
- Multiple fiber types including Hybrids
- Dry (SAP) core standard
- Standard tube size for all fiber counts
- Corrugated steel armor
- PFM gel

BENEFITS

- High fiber density
- Multiple network applications
- Reduces cable prep and installation time
- Reduces the number of tools required
- Improves compressive strength and rodent protection
- Non-sticky gel speeds fiber access and clean-up

Loose Tube Triple Jacket Double Armor

Series 1C

PRODUCT DESCRIPTION

Loose tube cables are the product of choice as the backbone in Outside Plant (OSP) environments. The durable loose tube design offers reliable transmission performance over a broad temperature range. Optical fibers are placed inside filled buffer tubes containing PFM™ gel. The core is constructed by stranding the buffer tubes around a central member using a reverse oscillating lay (ROL). The core is wrapped with flexible strength members covered with a water-blocking tape, then encased in a black inner jacket. Flexible strength members are applied with a corrugated steel armor and an intermediate black jacket. Another layer of flexible strength members with a corrugated steel armor and a black outer jacket completes the cable construction. Rip cords are included under the inner jacket and each armor for ease of entry.

APPLICATIONS

- Direct bury, underground duct and lashed aerial
- Trunk, distribution and feeder cables
- Local loop, metro, long-haul and broadband network

FEATURES

- Available with up to 144-fiber
- Multiple fiber types including hybrids
- Dry (SAP) core standard
- Standard tube size for all fiber counts
- Corrugated steel armor
- PFM gel

BENEFITS

- High fiber density
- Multiple network applications
- Reduces cable prep and installation time
- Reduces the number of tools required
- Improves compressive strength and rodent protection
- Non-sticky gel speeds fiber access and clean-up

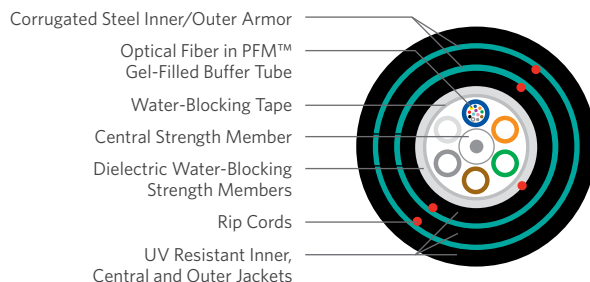

SPECIFICATIONS

Fiber Count	Available in 6-fiber up to 144-fiber
Standards Compliance	Telcordia® GR-20-CORE RDUP PE-90 Designation MLT ICEA S-87-640-2011 RoHS-compliant

Telcordia is a registered trademark of Ericsson Inc.

ENVIRONMENTAL SPECIFICATIONS

Operation/Storage	-40°C to +70°C
Installation	-30°C to +70°C

PART NUMBER KEY

1	C	-	-	-	x	x	0	y
1	2	3	4	5	6	7	8	9
Product family	Fiber count (006-144)	Fiber type	Internal designator	Water block/ marking (1-8)				

Contact Customer Service for availability of non-standard offerings.

PART NUMBERS AND PHYSICAL CHARACTERISTICS

Part Number ¹	Fiber Count	Nominal Diameter in (mm)	Approx. Weight lbs/kft (kg/km)	Maximum Tensile Loading		Minimum Bend Radius	
				Install lbs (N)	Long Term lbs (N)	Install in (mm)	Long Term in (mm)
1C006xx0y	6	0.73 (18.6)	229 (341)	600 (2,700)	200 (890)	14.6 (372)	7.3 (186)
1C012xx0y	12	0.73 (18.6)	229 (341)	600 (2,700)	200 (890)	14.6 (372)	7.3 (186)
1C024xx0y	24	0.73 (18.6)	229 (341)	600 (2,700)	200 (890)	14.6 (372)	7.3 (186)
1C036xx0y	36	0.73 (18.6)	229 (341)	600 (2,700)	200 (890)	14.6 (372)	7.3 (186)
1C048xx0y	48	0.73 (18.6)	229 (341)	600 (2,700)	200 (890)	14.6 (372)	7.3 (186)
1C072xx0y	72	0.76 (19.4)	252 (376)	600 (2,700)	200 (890)	15.2 (384)	7.6 (194)
1C096xx0y	96	0.83 (21.1)	289 (431)	600 (2,700)	200 (890)	16.6 (422)	8.3 (211)
1C144xx0y	144	0.96 (24.4)	376 (560)	600 (2,700)	200 (890)	19.2 (488)	9.6 (244)

FIBER TYPES:

SINGLE MODE

Reduced Water Peak	Zero Water Peak	TeraFlex® Bend Resistant				
		G.657.A1	G.657.A2	G.657.B3	NZDS	LEAF
3T	2T	KT	JT	LT	8T	ST
31	21	K1	J1	L1	81	S1

HYBRID

Hybrid
H_L

MULTIMODE

TeraGain®	TeraFlex Bend Resistant Laser Optimized 50/125		
	62.5/125	10G/150	10G/300
10G/150	10G/300	10G/550	10G/550
6G	MG	NG	PG

See "Optical Fiber Specifications" in the "Technical Information" section for detailed fiber type specifications.

WATER BLOCK AND JACKET PRINT CODES

	Dry core		Dry core special	
	Feet	Meters	Feet	Meters
¹ Replace "y" with:	1	2	5	6

Dri-Lite® Loose Tube Single Jacket Self Support

Series 11DM

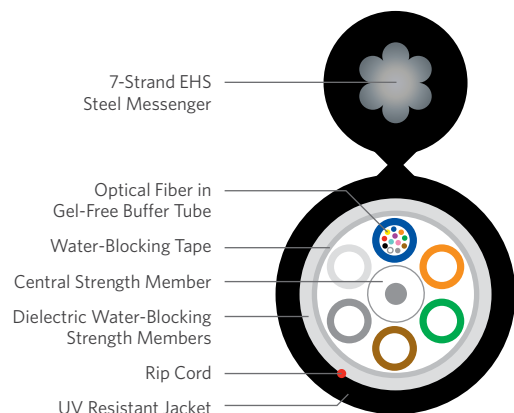
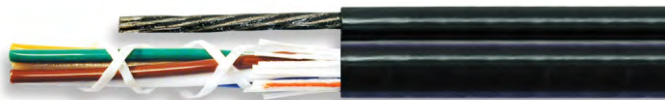

PRODUCT DESCRIPTION

Loose tube cables are the product of choice as the backbone in Outside Plant (OSP) applications. Loose tube self support cables are designed for use in aerial applications as an alternative to lashing. These cables reduce installation time and costs. Superior Essex offers self support cables for spans up to 700 feet. The loose tube design offers reliable transmission performance over a broad temperature range. The durable loose tube design features optical fibers placed inside gel-free buffer tubes. The core is constructed by stranding the buffer tubes around a central member using a reverse oscillating lay (ROL). The core is wrapped with flexible strength members, a water-blocking tape and then encased with a black jacket and an integrated EHS steel messenger. A rip cord is included under the jacket for ease of entry.

APPLICATIONS

- Aerial self support
- Trunk, distribution and feeder cable
- Local loop, metro, long-haul and broadband network

FEATURES

- Available with up to 288-fiber
- Multiple fiber types including hybrids
- Dry (SAP) core standard
- Standard tube size for all fiber counts
- Conforms to standard pole attachment hardware
- Gel-free construction

BENEFITS

- High fiber density
- Multiple network applications
- Reduces cable prep and installation time
- Reduces the number of tools required
- Standard installation practices
- Speeds fiber access and clean-up

SPECIFICATIONS

Fiber Count	Available in 6-fiber up to 288-fiber
Standards Compliance	Telcordia® GR-20-CORE RDUP PE-90 Designation MLT-8 ICEA S-87-640-2011 RoHS-compliant

Telcordia is a registered trademark of Ericsson Inc.

PART NUMBER KEY

1	1	_	_	_	x	D	M	y
1	2	3	4	5	6	7	8	9
Product family	Fiber count (006-288)		Fiber type	Internal designator	Water block/ marking (1-8)			

Contact Customer Service for availability of non-standard offerings.

ENVIRONMENTAL SPECIFICATIONS

Operation/Storage	-40°C to +70°C
Installation	-30°C to +70°C

PART NUMBERS AND PHYSICAL CHARACTERISTICS

Part Number ¹	Fiber Count	Dimensions		Nominal Weight lbs/kft (kg/km)	Fiber Cable Component Maximum Tensile Loading		Support Messenger Breaking Strength lbs	Minimum Bend Radius	
		Minor in (mm)	Major in (mm)		Install lbs (N)	Long Term lbs (N)		Install in (mm)	Long Term in (mm)
11012xDMy	12	0.41 (10.4)	0.89 (22.6)	208 (310)	600 (2,700)	200 (890)	6,650	8.2 (208)	4.1 (104)
11024xDMy	24	0.41 (10.4)	0.89 (22.6)	208 (310)	600 (2,700)	200 (890)	6,650	8.2 (208)	4.1 (104)
11048xDMy	48	0.41 (10.4)	0.89 (22.6)	208 (310)	600 (2,700)	200 (890)	6,650	8.2 (208)	4.1 (104)
11072xDMy	72	0.43 (10.9)	0.93 (23.6)	224 (334)	600 (2,700)	200 (890)	6,650	8.6 (218)	4.3 (109)
11096xDMy	96	0.50 (12.7)	1.01 (25.7)	245 (365)	600 (2,700)	200 (890)	6,650	10.0 (254)	5.0 (127)
11144xDMy	144	0.63 (16.0)	1.13 (28.7)	290 (432)	600 (2,700)	200 (890)	6,650	12.6 (320)	6.3 (160)
11216xDMy	216	0.63 (16.0)	1.13 (28.7)	290 (432)	600 (2,700)	200 (890)	6,650	12.6 (320)	6.3 (160)
11288xDMy	288	0.74 (18.8)	1.24 (31.5)	327 (488)	600 (2,700)	200 (890)	6,650	14.8 (376)	7.4 (188)

FIBER TYPES:

SINGLE MODE

Reduced Water Peak	Zero Water Peak	TeraFlex® Bend Resistant			
		G.657.A1	G.657.A2	G.657.B3	NZDS LEAF

¹Replace "x" with:

3	2	K	J	L	8	S
---	---	---	---	---	---	---

HYBRID

Hybrid

MULTIMODE

TeraGain®	TeraFlex Bend Resistant	Laser Optimized	50/125
62.5/125	10G/150	10G/300	10G/550

6	M	N	P
---	---	---	---

See "Optical Fiber Specifications" in the "Technical Information" section for detailed fiber type specifications.

WATER BLOCK AND JACKET PRINT CODES

Dry core		Dry core special	
Feet	Meters	Feet	Meters

¹Replace "y" with:

1	2	5	6
---	---	---	---

Dri-Lite® Loose Tube Double Jacket Self Support

Series 1GDM

PRODUCT DESCRIPTION

Loose tube cables are the product of choice as the backbone in Outside Plant (OSP) applications. Loose tube self support cables are designed for use in aerial applications as an alternative to lashing. These cables reduce installation time and costs. Superior Essex offers self support cables for spans up to 700 feet. The loose tube design offers reliable transmission performance over a broad temperature range. Optical fibers are placed inside gel-free buffer tubes. The core is constructed by stranding the buffer tubes around a central member using a reverse oscillating lay (ROL) and wrapped with flexible strength members, a water-blocking tape and then encased with a black inner jacket. Flexible strength members are applied and a black outer jacket with integrated EHS steel messenger completes the cable construction. Rip cords are included under each jacket for ease of entry.

APPLICATIONS

- Aerial self support
- Trunk, distribution and feeder cable
- Local loop, metro, long-haul and broadband network

FEATURES

- Available with up to 120-fiber
- Multiple fiber types including hybrids
- Dry (SAP) core standard
- Conforms to standard pole attachment hardware
- Gel-free construction

BENEFITS

- High fiber density
- Multiple network applications
- Reduces cable prep and installation time
- Standard installation practices
- Speeds fiber access and clean-up

ENVIRONMENTAL SPECIFICATIONS

Operation/Storage	-40°C to +70°C
Installation	-30°C to +70°C

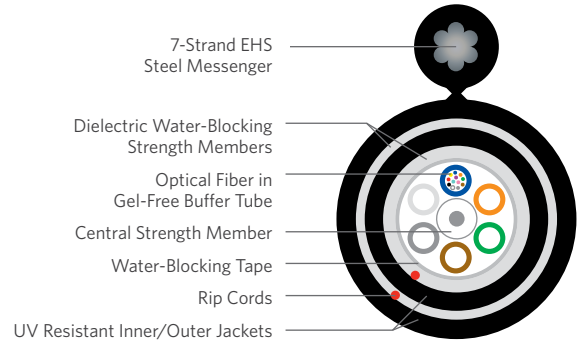
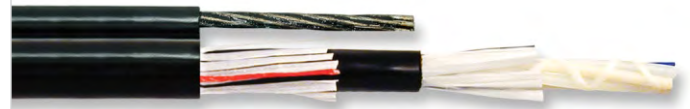

SPECIFICATIONS

Fiber Count	Available in 6-fiber up to 120-fiber
Standards Compliance	Telcordia® GR-20-CORE RDUP PE-90 Designation MLT-8 ICEA S-87-640-2011 RoHS-compliant

Telcordia is a registered trademark of Ericsson Inc.

PART NUMBER KEY

1	G	_	_	_	x	D	M	y
1	2	3	4	5	6	7	8	9
Product family	Fiber count (006-120)			Fiber type	Internal designator	Water block/ marking (1-8)		

Contact Customer Service for availability of non-standard offerings.

PART NUMBERS AND PHYSICAL CHARACTERISTICS

Part Number ¹	Fiber Count	Dimensions		Nominal Weight lbs/kft (kg/km)	Fiber Cable Component Maximum Tensile Loading		Support Messenger Breaking Strength lbs	Minimum Bend Radius	
		Minor in (mm)	Major in (mm)		Install lbs (N)	Long Term lbs (N)		Install in (mm)	Long Term in (mm)
1G006xDMy	6	0.50 (12.8)	0.99 (25.0)	242 (360)	600 (2,700)	200 (890)	6,650	10.0 (256)	5.0 (128)
1G012xDMy	12	0.50 (12.8)	0.99 (25.0)	242 (360)	600 (2,700)	200 (890)	6,650	10.0 (256)	5.0 (128)
1G024xDMy	24	0.50 (12.8)	0.99 (25.0)	242 (360)	600 (2,700)	200 (890)	6,650	10.0 (256)	5.0 (128)
1G036xDMy	36	0.50 (12.8)	0.99 (25.0)	242 (360)	600 (2,700)	200 (890)	6,650	10.0 (256)	5.0 (128)
1G048xDMy	48	0.50 (12.8)	0.99 (25.0)	242 (360)	600 (2,700)	200 (890)	6,650	10.0 (256)	5.0 (128)
1G072xDMy	72	0.53 (13.4)	1.03 (26.0)	257 (382)	600 (2,700)	200 (890)	6,650	10.6 (268)	5.3 (134)
1G096xDMy	96	0.59 (15.1)	1.10 (28.0)	279 (415)	600 (2,700)	200 (890)	6,650	11.8 (302)	5.9 (151)
1G120xDMy	120	0.66 (16.8)	1.26 (32.0)	343 (510)	600 (2,700)	200 (890)	6,650	13.2 (336)	6.6 (168)

FIBER TYPES:	SINGLE MODE						HYBRID	MULTIMODE				
	Reduced Water Peak	Zero Water Peak	TeraFlex® Bend Resistant					TeraGain®	TeraFlex Bend Resistant Laser Optimized 50/125			
			G.657.A1	G.657.A2	G.657.B3	NZDS	LEAF	Hybrid	62.5/125	10G/150	10G/300	10G/550
¹ Replace "x" with:	3	2	K	J	L	8	S	H	6	M	N	P

See "Optical Fiber Specifications" in the "Technical Information" section for detailed fiber type specifications.

WATER BLOCK AND JACKET PRINT CODES

	Dry core		Dry core special	
	Feet	Meters	Feet	Meters
¹ Replace "y" with:	1	2	5	6

Dri-Lite® Loose Tube Single Jacket Single Armor Self Support

Series 12DM

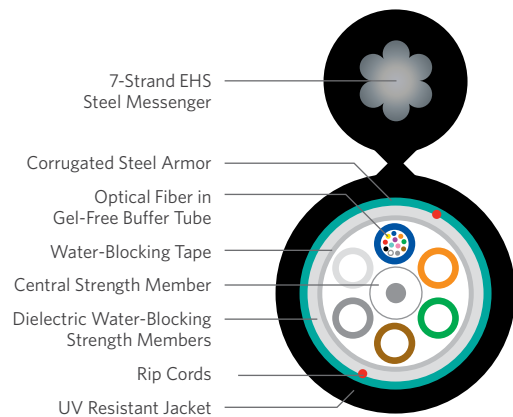
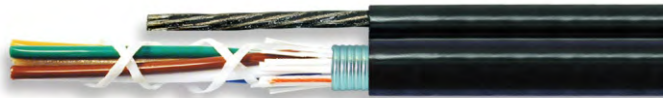

PRODUCT DESCRIPTION

Loose tube cables are the product of choice as the backbone in Outside Plant (OSP) applications. Loose tube self support cables are designed for use in aerial applications as an alternative to lashing. These cables reduce installation time and costs. Superior Essex offers self support cables for spans up to 700 feet. The loose tube design offers reliable transmission performance over a broad temperature range. The durable loose tube design features optical fibers placed inside gel-free buffer tubes. The core is constructed by stranding the buffer tubes around a central member using a reverse oscillating lay (ROL) and wrapped with flexible strength members covered with a water-blocking tape. A corrugated steel armor is applied and then encased in a black jacket with an integrated EHS steel messenger. Rip cords are included under the armor for ease of entry.

APPLICATIONS

- Aerial self support
- Trunk, distribution and feeder cable
- Local loop, metro, long-haul and broadband network

FEATURES

- Available with up to 288-fiber
- Multiple fiber types including hybrids
- Dry (SAP) core standard
- Corrugated steel armor
- Utilizes standard pole attachment hardware
- Gel-free construction

BENEFITS

- High fiber density
- Multiple network applications
- Reduces cable prep and installation time
- Improves compressive strength and rodent protection
- Standard installation practices
- Speeds fiber access and clean-up

SPECIFICATIONS

Fiber Count	Available in 6-fiber up to 288-fiber
Standards Compliance	Telcordia® GR-20-CORE RDUP PE-90 Designation MLT-8 ICEA S-87-640-2011 RoHS-compliant

Telcordia is a registered trademark of Ericsson Inc.

PART NUMBER KEY

1	2	-	-	-	x	D	M	y
1	2	3	4	5	6	7	8	9
Product family	Fiber count (006-288)			Fiber type	Internal designator	Water block/ marking (1-8)		

Contact Customer Service for availability of non-standard offerings.

ENVIRONMENTAL SPECIFICATIONS

Operation/Storage	-40°C to +70°C
Installation	-30°C to +70°C

PART NUMBERS AND PHYSICAL CHARACTERISTICS

Part Number ¹	Fiber Count	Dimensions		Nominal Weight lbs/kft (kg/km)	Fiber Cable Component Maximum Tensile Loading		Support Messenger Breaking Strength lbs	Minimum Bend Radius	
		Minor in (mm)	Major in (mm)		Install lbs (N)	Long Term lbs (N)		Install in (mm)	Long Term in (mm)
12012xDMy	12	0.46 (11.7)	0.94 (23.9)	249 (371)	600 (2,700)	200 (890)	6,650	9.2 (234)	4.6 (117)
12024xDMy	24	0.46 (11.7)	0.94 (23.9)	249 (371)	600 (2,700)	200 (890)	6,650	9.2 (234)	4.6 (117)
12048xDMy	48	0.46 (11.7)	0.94 (23.9)	249 (371)	600 (2,700)	200 (890)	6,650	9.2 (234)	4.6 (117)
12072xDMy	72	0.49 (12.4)	0.99 (25.1)	266 (397)	600 (2,700)	200 (890)	6,650	9.8 (249)	4.9 (124)
12096xDMy	96	0.56 (14.2)	1.09 (27.7)	306 (456)	600 (2,700)	200 (890)	6,650	11.2 (284)	5.6 (142)
12144xDMy	144	0.69 (17.5)	1.19 (30.2)	348 (519)	600 (2,700)	200 (890)	6,650	13.8 (351)	6.9 (175)
12216xDMy	216	0.69 (17.5)	1.19 (30.2)	348 (519)	600 (2,700)	200 (890)	6,650	13.8 (351)	6.9 (175)
12288xDMy	288	0.80 (20.3)	1.30 (33.0)	394 (588)	600 (2,700)	200 (890)	6,650	16.0 (406)	8.0 (203)

FIBER TYPES:

SINGLE MODE

Reduced Water Peak	Zero Water Peak	TeraFlex® Bend Resistant			
		G.657.A1	G.657.A2	G.657.B3	NZDS LEAF
¹ Replace "x" with:	3	2	K	J	L 8 S

HYBRID

Hybrid
H

MULTIMODE

TeraGain®	TeraFlex Bend Resistant Laser Optimized 50/125		
62.5/125	10G/150	10G/300	10G/550
6	M	N	P

See "Optical Fiber Specifications" in the "Technical Information" section for detailed fiber type specifications.

WATER BLOCK AND JACKET PRINT CODES

	Dry core		Dry core special	
	Feet	Meters	Feet	Meters
¹ Replace "y" with:	1	2	5	6

Dri-Lite® Loose Tube Double Jacket Single Armor Self Support

Series 1ADM

PRODUCT DESCRIPTION

Loose tube cables are the product of choice as the backbone in Outside Plant (OSP) applications. Loose tube self support cables are designed for use in aerial applications as an alternative to lashing. These cables reduce installation time and costs. Superior Essex offers self support cables for spans up to 700 feet. The loose tube design offers reliable transmission performance over a broad temperature range. Optical fibers are placed inside gel-free buffer tubes. The core is constructed by stranding the buffer tubes around a central member using a reverse oscillating lay (ROL). The core is wrapped with flexible strength members covered with a water-blocking tape then encased with a black polyethylene inner jacket. Water-blocking yarns and a corrugated steel armor are applied and a black outer jacket with an integrated EHS steel messenger completes the cable construction. Rip cords are included under the armor and inner jacket for ease of entry.

APPLICATIONS

- Aerial self support
- Trunk, distribution and feeder cable
- Local loop, metro, long-haul and broadband network

FEATURES

- Available with up to 120-fiber
- Multiple fiber types including hybrids
- Dry (SAP) core standard
- Corrugated steel armor
- Utilizes standard pole attachment hardware
- Gel-free construction

BENEFITS

- High fiber density
- Multiple network applications
- Reduces cable prep and installation time
- Improves compressive strength and rodent protection
- Standard installation practices
- Speeds fiber access and clean-up

ENVIRONMENTAL SPECIFICATIONS

Operation/Storage	-40°C to +70°C
Installation	-30°C to +70°C

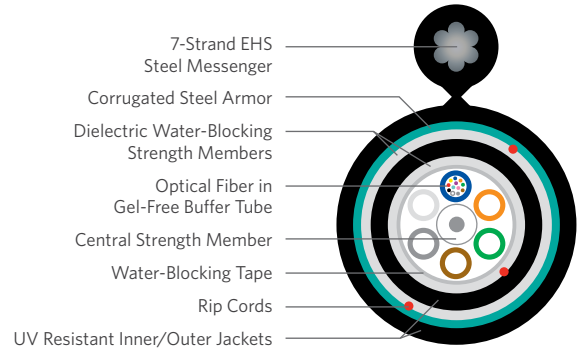

SPECIFICATIONS

Fiber Count	Available in 6-fiber up to 120-fiber
Standards Compliance	Telcordia® GR-20-CORE RDUP PE-90 Designation MLT-8 ICEA S-87-640-2011 RoHS-compliant

Telcordia is a registered trademark of Ericsson Inc.

PART NUMBER KEY

1	A	-	-	-	x	D	M	y
1	2	3	4	5	6	7	8	9
Product family	Fiber count (006-120)			Fiber type	Internal designator	Water block/ marking (1-8)		

Contact Customer Service for availability of non-standard offerings.

PART NUMBERS AND PHYSICAL CHARACTERISTICS

Part Number ¹	Fiber Count	Dimensions		Nominal Weight lbs/kft (kg/km)	Fiber Cable Component Maximum Tensile Loading		Support Messenger Breaking Strength lbs	Minimum Bend Radius	
		Minor in (mm)	Major in (mm)		Install lbs (N)	Long Term lbs (N)		Install in (mm)	Long Term in (mm)
1A006xDMy	6	0.56 (14.1)	1.03 (26.0)	287 (427)	600 (2,700)	200 (890)	6,650	11.2 (282)	5.6 (141)
1A012xDMy	12	0.56 (14.1)	1.03 (26.0)	287 (427)	600 (2,700)	200 (890)	6,650	11.2 (282)	5.6 (141)
1A024xDMy	24	0.56 (14.1)	1.03 (26.0)	287 (427)	600 (2,700)	200 (890)	6,650	11.2 (282)	5.6 (141)
1A036xDMy	36	0.56 (14.1)	1.03 (26.0)	287 (427)	600 (2,700)	200 (890)	6,650	11.2 (282)	5.6 (141)
1A048xDMy	48	0.56 (14.1)	1.03 (26.0)	287 (427)	600 (2,700)	200 (890)	6,650	11.2 (282)	5.6 (141)
1A072xDMy	72	0.58 (14.9)	1.12 (28.0)	322 (479)	600 (2,700)	200 (890)	6,650	11.6 (298)	5.8 (149)
1A096xDMy	96	0.65 (16.6)	1.18 (30.0)	354 (527)	600 (2,700)	200 (890)	6,650	13.0 (332)	6.5 (166)
1A120xDMy	120	0.72 (18.3)	1.35 (34.0)	432 (643)	600 (2,700)	200 (890)	6,650	14.4 (376)	7.2 (183)

FIBER TYPES:

SINGLE MODE

Reduced Water Peak	Zero Water Peak	TeraFlex® Bend Resistant				NZDS	LEAF
		G.657.A1	G.657.A2	G.657.B3			
¹ Replace "x" with:	3	2	K	J	L	8	S

HYBRID

Hybrid	H
--------	---

MULTIMODE

TeraGain®	TeraFlex Bend Resistant Laser Optimized 50/125		
62.5/125	10G/150	10G/300	10G/550
	M	N	P

See "Optical Fiber Specifications" in the "Technical Information" section for detailed fiber type specifications.

WATER BLOCK AND JACKET PRINT CODES

Dry core		Dry core special	
Feet	Meters	Feet	Meters

¹ Replace "y" with:	1	2	5	6
--------------------------------	---	---	---	---

Loose Tube Single Jacket Self Support

Series 11M

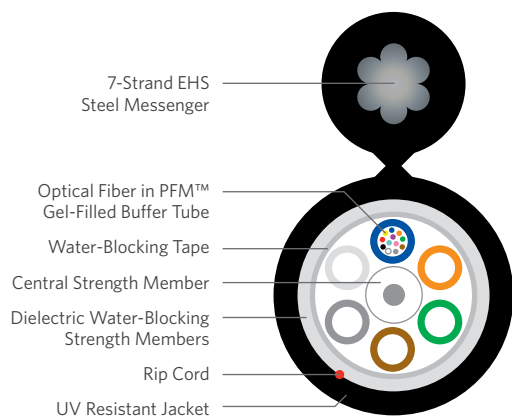
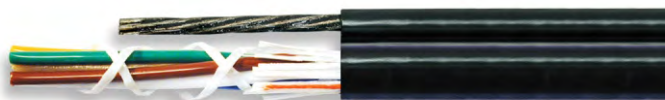

PRODUCT DESCRIPTION

Loose tube cables are the product of choice as the backbone in Outside Plant (OSP) applications. Loose tube self support cables are designed for use in aerial applications as an alternative to lashing. These cables reduce installation time and costs. Superior Essex offers self support cables for spans up to 700 feet. The loose tube design offers reliable transmission performance over a broad temperature range. The durable loose tube design features optical fibers placed inside PFM™ gel-filled buffer tubes. The core is constructed by stranding the buffer tubes around a central member using a reverse oscillating lay (ROL). The core is wrapped with flexible strength members, a water-blocking tape and then encased with a black jacket and an integrated EHS steel messenger. A rip cord is included under the jacket for ease of entry.

APPLICATIONS

- Aerial self support
- Trunk, distribution and feeder cable
- Local loop, metro, long-haul and broadband network

FEATURES

- Available with up to 288-fiber
- Multiple fiber types including hybrids
- Dry (SAP) core standard
- Standard tube size for all fiber counts
- Conforms to standard pole attachment hardware
- PFM gel

BENEFITS

- High fiber density
- Multiple network applications
- Reduces cable prep and installation time
- Reduces the number of tools required
- Standard installation practices
- Non-sticky gel speeds fiber access and clean-up

SPECIFICATIONS

Fiber Count	Available in 6-fiber up to 288-fiber
Standards Compliance	Telcordia® GR-20-CORE RDUP PE-90 Designation MLT-8 ICEA S-87-640-2011 RoHS-compliant

PART NUMBER KEY

1	1	_	_	_	x	x	M	y
1	2	3	4	5	6	7	8	9
Product family	Fiber count (006-288)			Fiber type	Internal designator	Water block/marking (1-8)		

Contact Customer Service for availability of non-standard offerings.

ENVIRONMENTAL SPECIFICATIONS

Operation/Storage	-40°C to +70°C
Installation	-30°C to +70°C

PART NUMBERS AND PHYSICAL CHARACTERISTICS

Part Number ¹	Fiber Count	Dimensions		Nominal Weight lbs/kft (kg/km)	Fiber Cable Component Maximum Tensile Loading		Support Messenger Breaking Strength lbs	Minimum Bend Radius	
		Minor in (mm)	Major in (mm)		Install lbs (N)	Long Term lbs (N)		Install in (mm)	Long Term in (mm)
11012xxMy	12	0.41 (10.4)	0.89 (22.6)	208 (310)	600 (2,700)	200 (890)	6,650	8.2 (208)	4.1 (104)
11024xxMy	24	0.41 (10.4)	0.89 (22.6)	208 (310)	600 (2,700)	200 (890)	6,650	8.2 (208)	4.1 (104)
11048xxMy	48	0.41 (10.4)	0.89 (22.6)	208 (310)	600 (2,700)	200 (890)	6,650	8.2 (208)	4.1 (104)
11072xxMy	72	0.43 (10.9)	0.93 (23.6)	224 (334)	600 (2,700)	200 (890)	6,650	8.6 (218)	4.3 (109)
11096xxMy	96	0.50 (12.7)	1.01 (25.7)	245 (365)	600 (2,700)	200 (890)	6,650	10.0 (254)	5.0 (127)
11144xxMy	144	0.63 (16.0)	1.13 (28.7)	290 (432)	600 (2,700)	200 (890)	6,650	12.6 (320)	6.3 (160)
11216xxMy	216	0.63 (16.0)	1.13 (28.7)	290 (432)	600 (2,700)	200 (890)	6,650	12.6 (320)	6.3 (160)
11288xxMy	288	0.74 (18.8)	1.24 (31.5)	327 (488)	600 (2,700)	200 (890)	6,650	14.8 (376)	7.4 (188)

FIBER TYPES:

SINGLE MODE

HYBRID

MULTIMODE

	Reduced Water Peak		Zero Water Peak		TeraFlex® Bend Resistant			Hybrid	TeraGain® TeraFlex Bend Resistant Laser Optimized 50/125			
	3T	2T	G.657.A1	G.657.A2	G.657.B3	NZDS	LEAF		62.5/125	10G/150	10G/300	10G/550
¹ For ≤ 36 fibers replace "xx" with:	3T	2T	KT	JT	LT	8T	ST	H ₁	6G	MG	NG	PG
¹ For > 36 fibers replace "xx" with:	31	21	K1	J1	L1	81	S1					

See "Optical Fiber Specifications" in the "Technical Information" section for detailed fiber type specifications.

WATER BLOCK AND JACKET PRINT CODES

	Dry core		Dry core special	
	Feet	Meters	Feet	Meters
¹ Replace "y" with:	1	2	5	6

Loose Tube Double Jacket Self Support

Series 1GM

PRODUCT DESCRIPTION

Loose tube cables are the product of choice as the backbone in Outside Plant (OSP) applications. Loose tube self support cables are designed for use in aerial applications as an alternative to lashing. These cables reduce installation time and costs. Superior Essex offers self support cables for spans up to 700 feet. The loose tube design offers reliable transmission performance over a broad temperature range. Optical fibers are placed inside filled buffer tubes containing PFM™ gel. The core is constructed by stranding the buffer tubes around a central member using a reverse oscillating lay (ROL) and wrapped with flexible strength members, a water-blocking tape and then encased with a black inner jacket. Flexible strength members are applied and a black outer jacket with integrated EHS steel messenger completes the cable construction. Rip cords are included under each jacket for ease of entry.

APPLICATIONS

- Aerial self support
- Trunk, distribution and feeder cable
- Local loop, metro, long-haul and broadband network

FEATURES

- Available with up to 120-fiber
- Multiple fiber types including hybrids
- Dry (SAP) core standard
- Conforms to standard pole attachment hardware
- PFM gel

BENEFITS

- High fiber density
- Multiple network applications
- Reduces cable prep and installation time
- Standard installation practices
- Non-sticky gel speeds fiber access and clean-up

ENVIRONMENTAL SPECIFICATIONS

Operation/Storage	-40°C to +70°C
Installation	-30°C to +70°C

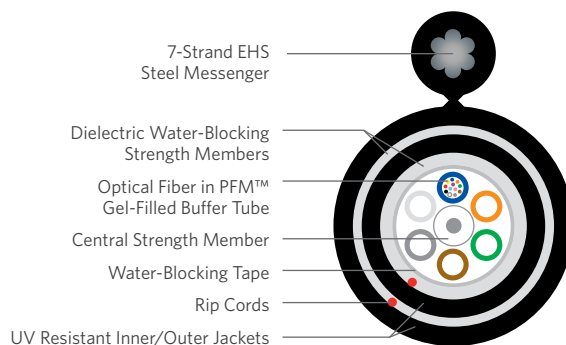

SPECIFICATIONS

Fiber Count	Available in 6-fiber up to 120-fiber
Standards Compliance	Telcordia® GR-20-CORE RDUP PE-90 Designation MLT-8 ICEA S-87-640-2011 RoHS-compliant

Telcordia is a registered trademark of Ericsson Inc.

PART NUMBER KEY

1	G	_	_	_	x	x	M	y
1	2	3	4	5	6	7	8	9
Product family	Fiber count (006-120)				Fiber type	Internal designator	Water block/markings (1-8)	

Contact Customer Service for availability of non-standard offerings.

PART NUMBERS AND PHYSICAL CHARACTERISTICS

Part Number ¹	Fiber Count	Dimensions		Nominal Weight lbs/kft (kg/km)	Fiber Cable Component Maximum Tensile Loading		Support Messenger Breaking Strength lbs	Minimum Bend Radius	
		Minor in (mm)	Major in (mm)		Install lbs (N)	Long Term lbs (N)		Install in (mm)	Long Term in (mm)
1G006xxMy	6	0.50 (12.8)	0.99 (25.0)	242 (360)	600 (2,700)	200 (890)	6,650	10.0 (256)	5.0 (128)
1G012xxMy	12	0.50 (12.8)	0.99 (25.0)	242 (360)	600 (2,700)	200 (890)	6,650	10.0 (256)	5.0 (128)
1G024xxMy	24	0.50 (12.8)	0.99 (25.0)	242 (360)	600 (2,700)	200 (890)	6,650	10.0 (256)	5.0 (128)
1G036xxMy	36	0.50 (12.8)	0.99 (25.0)	242 (360)	600 (2,700)	200 (890)	6,650	10.0 (256)	5.0 (128)
1G048xxMy	48	0.50 (12.8)	0.99 (25.0)	242 (360)	600 (2,700)	200 (890)	6,650	10.0 (256)	5.0 (128)
1G072xxMy	72	0.53 (13.4)	1.03 (26.0)	257 (382)	600 (2,700)	200 (890)	6,650	10.6 (268)	5.3 (134)
1G096xxMy	96	0.59 (15.1)	1.10 (28.0)	279 (415)	600 (2,700)	200 (890)	6,650	11.8 (302)	5.9 (151)
1G120xxMy	120	0.66 (16.8)	1.26 (32.0)	343 (510)	600 (2,700)	200 (890)	6,650	13.2 (336)	6.6 (168)

FIBER TYPES:

SINGLE MODE

HYBRID

MULTIMODE

	Reduced Water Peak		Zero Water Peak		TeraFlex® Bend Resistant			Hybrid	TeraGain® Laser Optimized 50/125			
	3T	2T	G.657.A1	G.657.A2	G.657.B3	NZDS	LEAF		62.5/125	10G/150	10G/300	10G/550
¹ For ≤ 36 fibers replace "xx" with:	3T	2T	KT	JT	LT	8T	ST	H _L	6G	MG	NG	PG
¹ For > 36 fibers replace "xx" with:	31	21	K1	J1	L1	81	S1					

See "Optical Fiber Specifications" in the "Technical Information" section for detailed fiber type specifications.

WATER BLOCK AND JACKET PRINT CODES

	Dry core		Dry core special	
	Feet	Meters	Feet	Meters
¹ Replace "y" with:	1	2	5	6

Loose Tube Single Jacket Single Armor Self Support

Series 12M

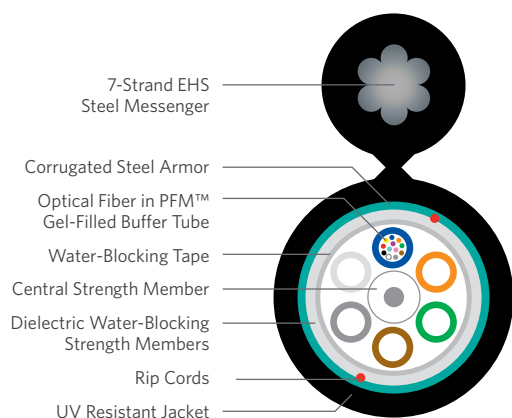
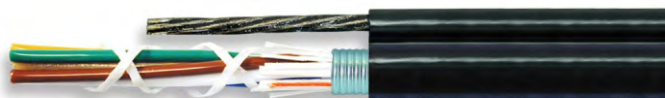

PRODUCT DESCRIPTION

Loose tube cables are the product of choice as the backbone in Outside Plant (OSP) applications. Loose tube self support cables are designed for use in aerial applications as an alternative to lashing. These cables reduce installation time and costs. Superior Essex offers self support cables for spans up to 700 feet. The loose tube design offers reliable transmission performance over a broad temperature range. The durable loose tube design features optical fibers placed inside PFM™ gel-filled buffer tubes. The core is constructed by stranding the buffer tubes around a central member using a reverse oscillating lay (ROL) and wrapped with flexible strength members covered with a water-blocking tape. A corrugated steel armor is applied and then encased in a black jacket with an integrated EHS steel messenger. Rip cords are included under the armor for ease of entry.

APPLICATIONS

- Aerial self support
- Trunk, distribution and feeder cable
- Local loop, metro, long-haul and broadband network

FEATURES

- Available with up to 288-fiber
- Multiple fiber types including hybrids
- Dry (SAP) core standard
- Corrugated steel armor
- Utilizes standard pole attachment hardware
- PFM gel

BENEFITS

- High fiber density
- Multiple network applications
- Reduces cable prep and installation time
- Improves compressive strength and rodent protection
- Standard installation practices
- Non-sticky gel speeds fiber access and clean-up

SPECIFICATIONS

Fiber Count Available in 6-fiber up to 288-fiber

Standards Compliance Telcordia® GR-20-CORE
RDUP PE-90 Designation MLT-8
ICEA S-87-640-2011
RoHS-compliant

Telcordia is a registered trademark of Ericsson Inc.

PART NUMBER KEY

1	2	3	4	5	6	7	8	9
Product family	Fiber count (006-288)	Fiber type	Internal designator	Water block/ marking (1-8)				

Contact Customer Service for availability of non-standard offerings.

ENVIRONMENTAL SPECIFICATIONS

Operation/Storage	-40°C to +70°C
Installation	-30°C to +70°C

PART NUMBERS AND PHYSICAL CHARACTERISTICS

Part Number ¹	Fiber Count	Dimensions		Nominal Weight lbs/kft (kg/km)	Fiber Cable Component Maximum Tensile Loading		Support Messenger Breaking Strength lbs	Minimum Bend Radius	
		Minor in (mm)	Major in (mm)		Install lbs (N)	Long Term lbs (N)		Install in (mm)	Long Term in (mm)
12012xxMy	12	0.46 (11.7)	0.94 (23.9)	249 (371)	600 (2,700)	200 (890)	6,650	9.2 (234)	4.6 (117)
12024xxMy	24	0.46 (11.7)	0.94 (23.9)	249 (371)	600 (2,700)	200 (890)	6,650	9.2 (234)	4.6 (117)
12048xxMy	48	0.46 (11.7)	0.94 (23.9)	249 (371)	600 (2,700)	200 (890)	6,650	9.2 (234)	4.6 (117)
12072xxMy	72	0.49 (12.4)	0.99 (25.1)	266 (397)	600 (2,700)	200 (890)	6,650	9.8 (249)	4.9 (124)
12096xxMy	96	0.56 (14.2)	1.09 (27.7)	306 (456)	600 (2,700)	200 (890)	6,650	11.2 (284)	5.6 (142)
12144xxMy	144	0.69 (17.5)	1.19 (30.2)	348 (519)	600 (2,700)	200 (890)	6,650	13.8 (351)	6.9 (175)
12216xxMy	216	0.69 (17.5)	1.19 (30.2)	348 (519)	600 (2,700)	200 (890)	6,650	13.8 (351)	6.9 (175)
12288xxMy	288	0.80 (20.3)	1.30 (33.0)	394 (588)	600 (2,700)	200 (890)	6,650	16.0 (406)	8.0 (203)

FIBER TYPES:	SINGLE MODE							HYBRID	MULTIMODE			
	Reduced Water Peak	Zero Water Peak	TeraFlex® Bend Resistant				Hybrid		TeraFlex Bend Resistant Laser Optimized 50/125			
			G.657.A1	G.657.A2	G.657.B3	NZDS		LEAF		TeraGain® 62.5/125	10G/150	10G/300
¹ For ≤ 36 fibers replace "xx" with:	3T	2T	KT	JT	LT	8T	ST	H _L	6G	MG	NG	PG
¹ For > 36 fibers replace "xx" with:	31	21	K1	J1	L1	81	S1					

See "Optical Fiber Specifications" in the "Technical Information" section for detailed fiber type specifications.

WATER BLOCK AND JACKET PRINT CODES

	Dry core		Dry core special	
	Feet	Meters	Feet	Meters
¹ Replace "y" with:	1	2	5	6

Loose Tube Double Jacket Single Armor Self Support

Series 1AM

PRODUCT DESCRIPTION

Loose tube cables are the product of choice as the backbone in Outside Plant (OSP) applications. Loose tube self support cables are designed for use in aerial applications as an alternative to lashing. These cables reduce installation time and costs. Superior Essex offers self support cables for spans up to 700 feet. The loose tube design offers reliable transmission performance over a broad temperature range. Optical fibers are placed inside filled buffer tubes containing PFM™ gel. The core is constructed by stranding the buffer tubes around a central member using a reverse oscillating lay (ROL). The core is wrapped with flexible strength members covered with a water-blocking tape then encased with a black polyethylene inner jacket. Water-blocking yarns and a corrugated steel armor are applied and a black outer jacket with an integrated EHS steel messenger completes the cable construction. Rip cords are included under the armor and inner jacket for ease of entry.

APPLICATIONS

- Aerial self support
- Trunk, distribution and feeder cable
- Local loop, metro, long-haul and broadband network

FEATURES

- Available with up to 120-fiber
- Multiple fiber types including hybrids
- Dry (SAP) core standard
- Corrugated steel armor
- Utilizes standard pole attachment hardware
- PFM gel

BENEFITS

- High fiber density
- Multiple network applications
- Reduces cable prep and installation time
- Improves compressive strength and rodent protection
- Standard installation practices
- Non-sticky gel speeds fiber access and clean-up

ENVIRONMENTAL SPECIFICATIONS

Operation/Storage	-40°C to +70°C
Installation	-30°C to +70°C

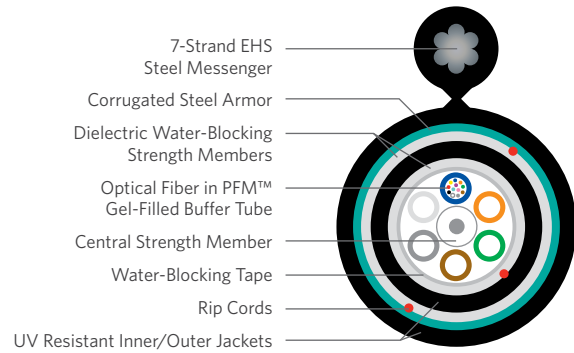

SPECIFICATIONS

Fiber Count	Available in 6-fiber up to 120-fiber
Standards Compliance	Telcordia® GR-20-CORE RDUP PE-90 Designation MLT-8 ICEA S-87-640-2011 RoHS-compliant

Telcordia is a registered trademark of Ericsson Inc.

PART NUMBER KEY

1	A	_	_	_	x	x	M	y
1	2	3	4	5	6	7	8	9
Product family	Fiber count (006-120)	Fiber type	Internal designator	Water block/ marking (1-8)				

Contact Customer Service for availability of non-standard offerings.

PART NUMBERS AND PHYSICAL CHARACTERISTICS

Part Number ¹	Fiber Count	Dimensions		Nominal Weight lbs/kft (kg/km)	Fiber Cable Component Maximum Tensile Loading		Support Messenger Breaking Strength lbs	Minimum Bend Radius	
		Minor in (mm)	Major in (mm)		Install lbs (N)	Long Term lbs (N)		Install in (mm)	Long Term in (mm)
1A006xxMy	6	0.56 (14.1)	1.03 (26.0)	287 (427)	600 (2,700)	200 (890)	6,650	11.2 (282)	5.6 (141)
1A012xxMy	12	0.56 (14.1)	1.03 (26.0)	287 (427)	600 (2,700)	200 (890)	6,650	11.2 (282)	5.6 (141)
1A024xxMy	24	0.56 (14.1)	1.03 (26.0)	287 (427)	600 (2,700)	200 (890)	6,650	11.2 (282)	5.6 (141)
1A036xxMy	36	0.56 (14.1)	1.03 (26.0)	287 (427)	600 (2,700)	200 (890)	6,650	11.2 (282)	5.6 (141)
1A048xxMy	48	0.56 (14.1)	1.03 (26.0)	287 (427)	600 (2,700)	200 (890)	6,650	11.2 (282)	5.6 (141)
1A072xxMy	72	0.58 (14.9)	1.12 (28.0)	322 (479)	600 (2,700)	200 (890)	6,650	11.6 (298)	5.8 (149)
1A096xxMy	96	0.65 (16.6)	1.18 (30.0)	354 (527)	600 (2,700)	200 (890)	6,650	13.0 (332)	6.5 (166)
1A120xxMy	120	0.72 (18.3)	1.35 (34.0)	432 (643)	600 (2,700)	200 (890)	6,650	14.4 (376)	7.2 (183)

FIBER TYPES:	SINGLE MODE	HYBRID	MULTIMODE
	Reduced Water Peak Zero Water Peak TeraFlex® Bend Resistant G.657.A1 G.657.A2 G.657.B3 NZDS LEAF	Hybrid	TeraGain® TeraFlex Bend Resistant Laser Optimized 50/125 62.5/125 10G/150 10G/300 10G/550
¹ For ≤ 36 fibers replace "xx" with:	3T 2T KT JT LT 8T ST	H _L	6G MG NG PG
¹ For > 36 fibers replace "xx" with:	31 21 K1 J1 L1 81 S1		

See "Optical Fiber Specifications" in the "Technical Information" section for detailed fiber type specifications.

WATER BLOCK AND JACKET PRINT CODES

	Dry core		Dry core special	
	Feet	Meters	Feet	Meters
¹ Replace "y" with:	1	2	5	6

Dri-Lite® Loose Tube Single Jacket Long-Span Self Support

Series 11MLS

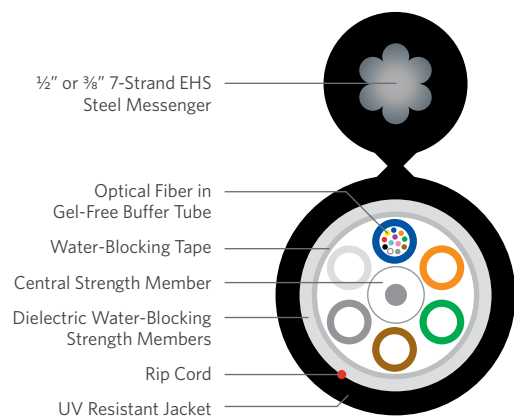
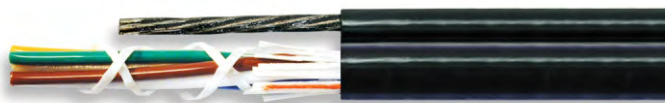

1/2" or 3/8" 7-Strand EHS Steel Messenger

Optical Fiber in Gel-Free Buffer Tube

Water-Blocking Tape

Central Strength Member

Dielectric Water-Blocking Strength Members

Rip Cord

UV Resistant Jacket

PRODUCT DESCRIPTION

Superior Essex now offers long-span Figure 8 optical fiber cables using a 1/2" or 3/8" messenger which can span lengths greater than 1,000 feet. Loose tube cables are the product of choice as the backbone in Outside Plant (OSP) applications. Loose tube self support cables are designed for use in aerial applications as an alternative to lashing. These cables reduce installation time and costs. The durable loose tube design features optical fibers placed inside gel-free buffer tubes. The core is constructed by stranding the buffer tubes around a central member using a reverse oscillating lay (ROL). The core is wrapped with flexible strength members, a water-blocking tape and then encased with a black jacket and an integrated EHS steel messenger. A rip cord is included under the jacket for ease of entry.

APPLICATIONS

- Aerial self support
- Trunk, distribution and feeder cable
- Local loop, metro, long-haul and broadband network

FEATURES

- Available with up to 288-fiber
- Dry (SAP) core standard
- Standard tube size for all fiber counts
- Conforms to standard pole attachment hardware
- Gel-free cable

BENEFITS

- High fiber density
- Reduces cable prep and installation time
- Reduces the number of tools required
- Standard installation practices
- Speeds fiber access and clean-up

SPECIFICATIONS

Fiber Count	Available in 6-fiber up to 288-fiber
Standards Compliance	Telcordia® GR-20-CORE RDUP PE-90 Designation MLT-8 ICEA S-87-640-2011 RoHS-compliant

Telcordia is a registered trademark of Ericsson Inc.

PART NUMBER KEY

1	1	—	—	—	K or J	D	L or K	y
1	2	3	4	5	6	7	8	9
Product family	Fiber count (006-288)	Fiber type	Internal designator	Water block/ marking (1-8)				

Contact Customer Service for availability of non-standard offerings.

ENVIRONMENTAL SPECIFICATIONS

Operation/Storage	-40°C to +70°C
Installation	-30°C to +70°C

PART NUMBERS AND PHYSICAL CHARACTERISTICS

Part Number ¹	Fiber Count	Support Messenger Size in (mm)	Cable Dimensions		Nominal Weight lbs/kft (kg/km)	Fiber Cable Component Maximum Tensile Loading		Support Messenger Breaking Strength lbs	Minimum Bend Radius	
			Minor in (mm)	Major in (mm)		Install lbs (N)	Long Term lbs (N)		Install in (mm)	Long Term in (mm)
11012KDly	12	0.500 (12.7)	0.62 (15.7)	1.11 (28.3)	630 (940)	600 (2,700)	200 (890)	39,030	12.4 (314)	6.2 (157)
11060KDly	60	0.500 (12.7)	0.62 (15.7)	1.11 (28.3)	630 (940)	600 (2,700)	200 (890)	39,030	12.4 (314)	6.2 (157)
11072KDly	72	0.500 (12.7)	0.62 (15.7)	1.14 (29.0)	644 (961)	600 (2,700)	200 (890)	39,030	12.4 (314)	6.2 (157)
11096KDly	96	0.500 (12.7)	0.62 (15.7)	1.21 (30.7)	653 (974)	600 (2,700)	200 (890)	39,030	12.4 (314)	6.2 (157)
11144KDly	144	0.500 (12.7)	0.63 (16.0)	1.34 (34.0)	698 (1,041)	600 (2,700)	200 (890)	39,030	12.6 (320)	6.3 (160)
11216KDly	216	0.500 (12.7)	0.63 (16.0)	1.34 (34.0)	698 (1,041)	600 (2,700)	200 (890)	39,030	12.6 (320)	6.3 (160)
11288KDly	288	0.500 (12.7)	0.74 (18.9)	1.45 (36.9)	735 (1,097)	600 (2,700)	200 (890)	39,030	14.9 (378)	7.4 (189)
11012KDKy	12	0.375 (9.5)	0.48 (12.1)	0.95 (24.1)	353 (526)	600 (2,700)	200 (890)	15,400	9.5 (242)	4.8 (121)
11060KDKy	60	0.375 (9.5)	0.48 (12.1)	0.95 (24.1)	353 (526)	600 (2,700)	200 (890)	15,400	9.5 (242)	4.8 (121)
11072KDKy	72	0.375 (9.5)	0.48 (12.1)	1.00 (25.4)	367 (547)	600 (2,700)	200 (890)	15,400	9.5 (242)	4.8 (121)
11096KDKy	96	0.375 (9.5)	0.50 (12.7)	1.07 (27.1)	385 (574)	600 (2,700)	200 (890)	15,400	10.0 (254)	5.0 (127)
11144KDKy	144	0.375 (9.5)	0.63 (16.0)	1.21 (30.8)	430 (641)	600 (2,700)	200 (890)	15,400	12.6 (320)	6.3 (160)
11216KDKy	216	0.375 (9.5)	0.63 (16.0)	1.21 (30.8)	430 (641)	600 (2,700)	200 (890)	15,400	12.6 (320)	6.3 (160)
11288KDKy	288	0.375 (9.5)	0.74 (18.9)	1.31 (33.3)	460 (687)	600 (2,700)	200 (890)	15,400	14.9 (378)	7.4 (189)

FIBER TYPES:

SINGLE MODE

TeraFlex® Bend Resistant

G.657.A1 G.657.A2

¹Replace "x" with:

K J

WATER BLOCK AND JACKET PRINT CODES

Dry core Dry core special

Feet Meters Feet Meters

¹Replace "y" with:

1 2 5 6

See "Optical Fiber Specifications" in the "Technical Information" section for detailed fiber type specifications.

PRODUCT DESCRIPTION

ADSS 100 is an All Dielectric Self Supporting (ADSS) cable suitable for aerial applications with span lengths from 60 meters to 160 meters depending on loading conditions and sag requirements. The exact span limit will vary depending on wind and loading conditions, sag requirements and other factors. This black, PE-jacketed cable is UV-stabilized and water blocked for outdoor aerial applications. The loose tube design provides stable and highly reliable transmission parameters for a variety of voice, data, video and imaging applications. The high modulus aramid yarns provide high tensile strength and long term reliability. Sag and tension charts are available.

APPLICATIONS

- Low-voltage transmission and distribution system (space potential ≤ 12 kV)
- Railways, power and telecommunications pole routes
- Suitable for all type of aerial lines

FEATURES

- Available with up to 288-fiber
- Dry core standard
- Lower cost than Figure 8
- Energized installation
- Custom print

BENEFITS

- High fiber density
- Reduces cable prep time
- Reduced network cost
- No downtime
- Personalization

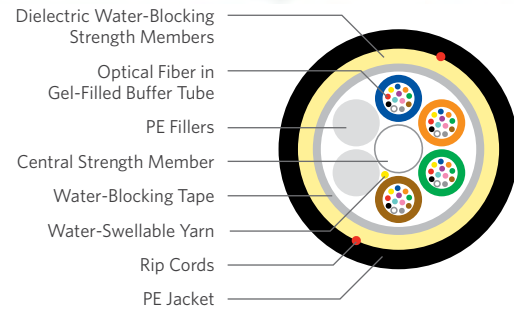

SPECIFICATIONS

Fiber Count	Available in 6-fiber up to 288-fiber
Compressive Strength lbs/in (N/cm)	Install: 125 (220) Long Term: 63 (110)
Maximum Span NESC Loading District ft (m)	Light: 492 (150) Medium: 328 (100) Heavy: 197 (60) <i>Max span would vary at different sag percentages.</i>
Recommended Hardware	FIBERLIGN® dead-end for ADSS Limited Tension
Standards Design and Test	ICEA S-87-640 IEEE 1222

FIBERLIGN is a registered trademark of Preformed Line Products (PLP).

ENVIRONMENTAL SPECIFICATIONS

Operation/Storage	-40°C to +70°C
Installation	-30°C to +70°C

PART NUMBER KEY

F	E	1	1	-	-	-	-	x	x	x	-	E	9	9	1 or 2
1	2	3	4	5	6	7	8	9	10	11	12	13	14	15	16
Fiber cable	Cable type		100 meter span	-	Fiber count (006-288)				Fiber type			-	Jacket color	Package	Jacket print

Contact Customer Service for availability of non-standard offerings.

PART NUMBERS AND PHYSICAL CHARACTERISTICS

Previous Part Number	Current Part Number ¹	Fiber Count	Nominal Diameter in (mm)	Nominal Weight lbs/kft (kg/km)	Minimum Bend Radius	
					Install in (mm)	Long Term in (mm)
1F0063111	FE11-006xxx-E99y	6	0.50 (12.6)	70 (105)	10.0 (253)	5.0 (126)
1F0123T11	FE11-012xxx-E99y	12	0.50 (12.6)	70 (105)	10.0 (253)	5.0 (126)
1F0243T11	FE11-024xxx-E99y	24	0.50 (12.6)	70 (105)	10.0 (253)	5.0 (126)
1F0483111	FE11-048xxx-E99y	48	0.50 (12.6)	70 (105)	10.0 (253)	5.0 (126)
1F0723111	FE11-072xxx-E99y	72	0.50 (12.6)	70 (105)	10.0 (253)	5.0 (126)
1F0963111	FE11-096xxx-E99y	96	0.53 (13.4)	91 (136)	10.6 (268)	5.3 (134)
1F1443111	FE11-144xxx-E99y	144	0.68 (17.2)	146 (217)	13.5 (343)	6.8 (172)
1F2163111	FE11-216xxx-E99y	216	0.68 (17.2)	166 (247)	13.5 (343)	6.8 (172)
1F2883111	FE11-288xxx-E99y	288	0.81 (20.5)	187 (278)	16.2 (411)	8.1 (205)

FIBER TYPES:

SINGLE MODE

Reduced Water Peak	Zero Water Peak	TeraFlex® Bend Resistant					
		G.657.A1	G.657.A2	G.657.B3	NZDS	LEAF	
¹ Replace "xxx" with:	U10	U17	U13	U14	U15	U19	C19

See "Optical Fiber Specifications" in the "Technical Information" section for detailed fiber type specifications.

JACKET PRINT

	Feet	Meters
¹ Replace "y" with:	1	2

ADSS 200

Series 1F200

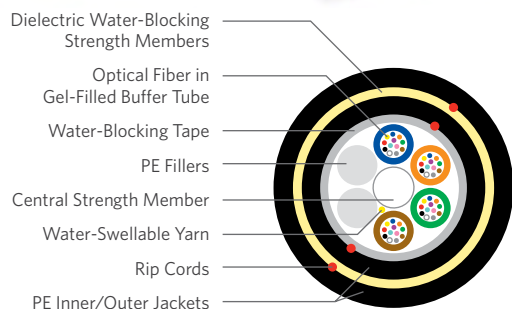

PRODUCT DESCRIPTION

ADSS 200 is an All Dielectric Self Supporting (ADSS) cable suitable for aerial applications with span lengths from 140 meters to 260 meters depending on loading conditions and sag requirements. The exact span limit will vary depending on wind and loading conditions, sag requirements and other factors. This black, PE-jacketed cable is UV-stabilized and water blocked for outdoor aerial applications. The loose tube design provides stable and highly reliable transmission parameters for a variety of voice, data, video and imaging applications. The high modulus aramid yarns provide high tensile strength and long term reliability. Sag and tension charts are available.

APPLICATIONS

- Low-voltage transmission and distribution system (space potential ≤ 12 kV)
- Railways, power and telecommunications pole routes
- Suitable for all type of aerial lines

FEATURES

- Available with up to 288-fiber
- Dry core standard
- Lower cost than Figure 8
- Energized installation
- Custom print

BENEFITS

- High fiber density
- Reduces cable prep time
- Reduced network cost
- No downtime
- Personalization

SPECIFICATIONS

Fiber Count	Available in 6-fiber up to 288-fiber
Compressive Strength lbs/in (N/cm)	Install: 125 (220) Long Term: 63 (110)
Maximum Span NESC Loading District ft (m)	Light: 853 (260) Medium: 656 (200) Heavy: 459 (140) <i>Max span would vary at different sag percentages.</i>
Recommended Hardware	FIBERLIGN® dead-end for ADSS Medium Tension
Standards Design and Test	ICEA S-87-640 IEEE 1222

FIBERLIGN is a registered trademark of Preformed Line Products (PLP).

ENVIRONMENTAL SPECIFICATIONS

Operation/Storage	-40°C to +70°C
Installation	-30°C to +70°C

PART NUMBER KEY

F	E	1	2	-	-	-	-	x	x	x	-	E	9	9	1 or 2	
1	2	3	4	5	6	7	8	9	10	11	12	13	14	15	16	
Fiber cable	Cable type		200 meter span	-	Fiber count (006-288)				Fiber type			-	Jacket color	Package		Jacket print

Contact Customer Service for availability of non-standard offerings.

PART NUMBERS AND PHYSICAL CHARACTERISTICS

Previous Part Number	Current Part Number ¹	Fiber Count	Nominal Diameter in (mm)	Nominal Weight lbs/kft (kg/km)	Minimum Bend Radius	
					Install in (mm)	Long Term in (mm)
1F0063121	FE12-006xxx-E99y	6	0.55 (14.0)	91 (135)	11.1 (282)	5.5 (141)
1F0123T21	FE12-012xxx-E99y	12	0.55 (14.0)	91 (135)	11.1 (282)	5.5 (141)
1F0243T21	FE12-024xxx-E99y	24	0.55 (14.0)	91 (135)	11.1 (282)	5.5 (141)
1F0483121	FE12-048xxx-E99y	48	0.55 (14.0)	91 (135)	11.1 (282)	5.5 (141)
1F0723121	FE12-072xxx-E99y	72	0.55 (14.0)	91 (135)	11.1 (282)	5.5 (141)
1F0963121	FE12-096xxx-E99y	96	0.60 (15.2)	107 (160)	12.0 (304)	6.0 (152)
1F1443121	FE12-144xxx-E99y	144	0.76 (19.3)	154 (230)	15.2 (386)	7.6 (193)
1F2163121	FE12-216xxx-E99y	216	0.76 (19.3)	177 (265)	15.2 (386)	7.6 (193)
1F2883121	FE12-288xxx-E99y	288	0.85 (21.7)	201 (300)	17.1 (434)	8.5 (217)

FIBER TYPES:

SINGLE MODE

Reduced Water Peak	Zero Water Peak	TeraFlex® Bend Resistant				
		G.657.A1	G.657.A2	G.657.B3	NZDS	LEAF
¹ Replace "xxx" with: U10	U17	U13	U14	U15	U19	C19

See "Optical Fiber Specifications" in the "Technical Information" section for detailed fiber type specifications.

JACKET PRINT

	Feet	Meters
¹ Replace "y" with:	1	2

PRODUCT DESCRIPTION

All Dielectric Self Supporting (ADSS) cables are suitable for aerial applications with a maximum span of 400 meters. This black, PE-jacketed cable is UV-stabilized and water blocked for outdoor aerial applications. The loose tube design provides stable and highly reliable transmission parameters for a variety of voice, data, video and imaging applications. The high modulus aramid yarns provide high tensile strength and long term reliability.

APPLICATIONS

- Low-voltage transmission and distribution system
- Space potential ≤ 12 kV with PE jacket
- Railways, power and telecommunications pole routes
- Suitable for all type of aerial lines

FEATURES

- Available with up to 288-fiber
- Dry core standard
- Lower cost than Figure 8
- Energized installation

BENEFITS

- High fiber density
- Reduces cable prep time
- Reduced network cost
- No downtime

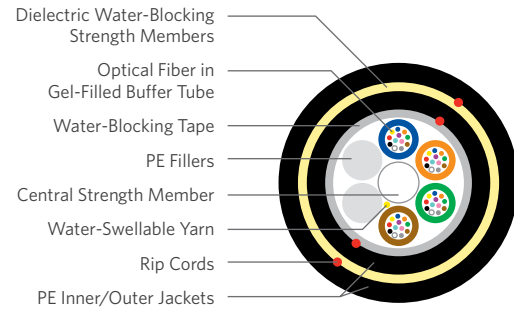

SPECIFICATIONS

Fiber Count	Available in 6-fiber up to 288-fiber
Compressive Strength lbs/in (N/cm)	Install: 125 (220) Long Term: 63 (110)
Maximum Span NESC Loading District ft (m)	Light: 1,640 (500) Medium: 1,312 (400) Heavy: 853 (260)

Max span would vary at different sag percentages.

ENVIRONMENTAL SPECIFICATIONS

Operation/Storage	-40°C to +70°C
Installation	-30°C to +70°C

PART NUMBER KEY

F	E	1	4	-	-	-	-	U	1	0	-	E	9	9	1
1	2	3	4	5	6	7	8	9	10	11	12	13	14	15	16
Fiber cable	Cable type		400 meter span	-	Fiber count (006-288)			Fiber type (SMF Reduced Water Peak)			-	Jacket color	Package		Jacket print (feet)

Contact Customer Service for availability of non-standard offerings.

PART NUMBERS AND PHYSICAL CHARACTERISTICS

Previous Part Number	Current Part Number ¹	Fiber Count	Nominal Diameter in (mm)	Nominal Weight lbs/kft (kg/km)	Minimum Bend Radius	
					Install in (mm)	Long Term in (mm)
1F006314L	FE14-006U10-E991	6	0.55 (14.0)	101 (150)	11.0 (280)	5.5 (140)
1F012314L	FE14-012U10-E991	12	0.55 (14.0)	101 (150)	11.0 (280)	5.5 (140)
1F024314L	FE14-024U10-E991	24	0.55 (14.0)	101 (150)	11.0 (280)	5.5 (140)
1F048314L	FE14-048U10-E991	48	0.55 (14.0)	101 (150)	11.0 (280)	5.5 (140)
1F096314L	FE14-096U10-E991	96	0.61 (15.4)	121 (180)	12.2 (308)	6.1 (154)
1F144314L	FE14-144U10-E991	144	0.74 (18.7)	171 (255)	14.8 (374)	7.4 (187)
1F288314L	FE14-288U10-E991	288	0.85 (21.6)	218 (325)	17.0 (432)	8.5 (216)

Single Loose Tube All Dielectric

Series 51

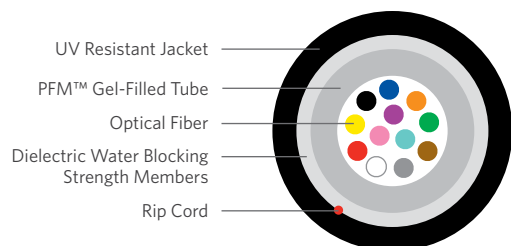

PRODUCT DESCRIPTION

Loose tube cables are the product of choice as the backbone in Outside Plant (OSP) applications. Single Loose tube cables offer a low cost alternative to traditional stranded loose tube cables. The loose tube design offers reliable transmission performance over a broad temperature range. The durable single loose tube design features optical fibers placed inside a single PFM™ gel-filled tube. The core tube includes up to 8-fiber bundles, each containing up to 12 optical fibers bound within a color coded binder. The core tube is then helically wrapped with water-blocking strength members, then encased with a black jacket. A rip cord is included under the jacket to provide ease of access to the core tube.

APPLICATIONS

- Underground duct and lashed aerial
- Trunk, distribution and feeder cable
- Local loop, metro, long-haul and broadband network

FEATURES

- Available with up to 96-fiber
- Multiple fiber types
- Dielectric outer strength members
- Dry (SAP) core standard
- Highly flexible
- Small cable diameter
- Fewer cable components
- PFM gel

BENEFITS

- High fiber density
- Multiple network applications
- Eliminates grounding or bonding problems
- Reduces cable prep and installation time
- Easy handling
- Installation of more fibers in less space
- Reduces cost
- Non-sticky gel speeds fiber access and clean-up

SPECIFICATIONS

Fiber Count Available in 6-fiber up to 96-fiber

Standards Compliance Telcordia® GR-20-CORE
RDUP PE-90 Designation SLT
ICEA S-87-640-2011
RoHS-compliant

Telcordia is a registered trademark of Ericsson Inc.

ENVIRONMENTAL SPECIFICATIONS

Operation/Storage -40°C to +70°C

Installation -30°C to +70°C

PART NUMBER KEY

5	1	–	–	–	x	x	0	y
1	2	3	4	5	6	7	8	9
Product family	Fiber count (006-096)	Fiber type	Internal designator	Water block/ marking (1-8)				

Contact Customer Service for availability of non-standard offerings.

PART NUMBERS AND PHYSICAL CHARACTERISTICS

Part Number ¹	Fiber Count	Nominal Diameter in (mm)	Approx. Weight lbs/kft (kg/km)	Maximum Tensile Loading		Minimum Bend Radius	
				Install lbs (N)	Long Term lbs (N)	Install in (mm)	Long Term in (mm)
51006xx0y	6	0.31 (7.9)	36 (54)	600 (2,700)	200 (890)	6.2 (158)	3.1 (79)
51012xx0y	12	0.31 (7.9)	36 (54)	600 (2,700)	200 (890)	6.2 (158)	3.1 (79)
51024xx0y	24	0.39 (9.8)	51 (75)	600 (2,700)	200 (890)	7.8 (196)	3.9 (98)
51036xx0y	36	0.39 (9.8)	51 (75)	600 (2,700)	200 (890)	7.8 (196)	3.9 (98)
51048xx0y	48	0.39 (9.8)	51 (75)	600 (2,700)	200 (890)	7.8 (196)	3.9 (98)
51072xx0y	72	0.46 (11.6)	68 (102)	600 (2,700)	200 (890)	9.2 (232)	4.6 (116)
51096xx0y	96	0.46 (11.6)	68 (102)	600 (2,700)	200 (890)	9.2 (232)	4.6 (116)

FIBER TYPES:

SINGLE MODE

Reduced Water Peak	Zero Water Peak	TeraFlex® Bend Resistant			NZDS	LEAF
		G.657.A1	G.657.A2	G.657.B3		
¹ Replace "xx" with:	31	21	K1	J1	L1	81 S1

MULTIMODE

TeraGain®	TeraFlex Bend Resistant Laser Optimized 50/125		
62.5/125	10G/150	10G/300	10G/550
6G	MG	NG	PG

See "Optical Fiber Specifications" in the "Technical Information" section for detailed fiber type specifications.

WATER BLOCK AND JACKET PRINT CODES

Dry core		Dry core special	
Feet	Meters	Feet	Meters
¹ Replace "y" with:	1	2	5
	2	5	6

Single Loose Tube Single Armor

Series 52

PRODUCT DESCRIPTION

Loose tube cables are the product of choice as the backbone in Outside Plant (OSP) applications. Single Loose tube cables offer a low cost alternative to traditional stranded loose tube cables. Armored cables are designed for improved mechanical and rodent protection in direct bury applications. The loose tube design offers reliable transmission performance over a broad temperature range. The durable single loose tube design features optical fibers placed inside a single PFM™ gel-filled tube. The core tube includes up to 8-fiber bundles, each containing up to 12 optical fibers bound with a color coded binder. The core is wrapped with flexible strength members and covered with a water-blocking tape. A corrugated steel armor is applied and then encased with a black jacket. Rip cords are included under the armor for ease of access to the core tube.

APPLICATIONS

- Direct bury
- Trunk, distribution and feeder cable
- Local loop, metro, long-haul and broadband network

FEATURES

- Available with up to 96-fiber
- Multiple fiber types
- Dry (SAP) core standard
- Highly flexible
- Fewer cable components
- Corrugated Armor
- PFM gel

BENEFITS

- High fiber density
- Multiple network applications
- Reduces cable prep and installation time
- Easy handling
- Reduces cost
- Improves compressive strength and rodent protection
- Non-sticky gel speeds fiber access and clean-up

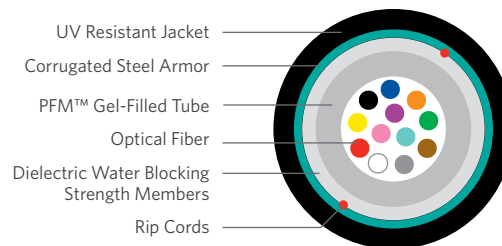

SPECIFICATIONS

Fiber Count	Available in 6-fiber up to 96-fiber
Standards Compliance	Telcordia® GR-20-CORE RDUP PE-90 Designation SLT ICEA S-87-640-2011 RoHS-compliant

Telcordia is a registered trademark of Ericsson Inc.

ENVIRONMENTAL SPECIFICATIONS

Operation/Storage	-40°C to +70°C
Installation	-30°C to +70°C

PART NUMBER KEY

5	2	-	-	-	x	x	0	y
1	2	3	4	5	6	7	8	9
Product family	Fiber count (006-096)				Fiber type	Internal designator	Water block/markings (1-8)	

Contact Customer Service for availability of non-standard offerings.

PART NUMBERS AND PHYSICAL CHARACTERISTICS

Part Number ¹	Fiber Count	Nominal Diameter in (mm)	Approx. Weight lbs/kft (kg/km)	Maximum Tensile Loading		Minimum Bend Radius	
				Install lbs (N)	Long Term lbs (N)	Install in (mm)	Long Term in (mm)
52002xx0y	2	0.36 (9.1)	62 (92)	600 (2,700)	200 (890)	7.2 (183)	3.6 (91)
52004xx0y	4	0.36 (9.1)	62 (92)	600 (2,700)	200 (890)	7.2 (183)	3.6 (91)
52006xx0y	6	0.36 (9.1)	62 (92)	600 (2,700)	200 (890)	7.2 (183)	3.6 (91)
52012xx0y	12	0.36 (9.1)	62 (92)	600 (2,700)	200 (890)	7.2 (183)	3.6 (91)
52024xx0y	24	0.44 (11.0)	83 (124)	600 (2,700)	200 (890)	8.8 (224)	4.4 (112)
52036xx0y	36	0.44 (11.0)	83 (124)	600 (2,700)	200 (890)	8.8 (224)	4.4 (112)
52048xx0y	48	0.44 (11.0)	83 (124)	600 (2,700)	200 (890)	8.8 (224)	4.4 (112)
52072xx0y	72	0.50 (12.8)	111 (165)	600 (2,700)	200 (890)	10.0 (254)	5.0 (127)
52096xx0y	96	0.50 (12.8)	111 (165)	600 (2,700)	200 (890)	10.0 (254)	5.0 (127)

FIBER TYPES:

SINGLE MODE

Reduced Water Peak	Zero Water Peak	TeraFlex® Bend Resistant					
		G.657.A1	G.657.A2	G.657.B3	NZDS	LEAF	

¹Replace "xx" with:

31	21	K1	J1	L1	81	S1
----	----	----	----	----	----	----

MULTIMODE

TeraGain®	TeraFlex Bend Resistant Laser Optimized 50/125		
62.5/125	10G/150	10G/300	10G/550

6G	MG	NG	PG
----	----	----	----

See "Optical Fiber Specifications" in the "Technical Information" section for detailed fiber type specifications.

WATER BLOCK AND JACKET PRINT CODES

Dry core		Dry core special	
Feet	Meters	Feet	Meters

¹Replace "y" with:

1	2	5	6
---	---	---	---

Single Flex Tube All Dielectric

Series F1

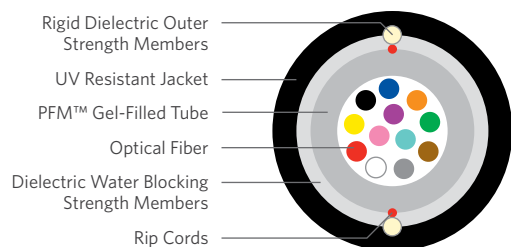

SPECIFICATIONS

Fiber Count Available in 6-fiber up to 96-fiber

Standards Compliance Telcordia® GR-20-CORE
RDUP PE-90 Designation SLT
ICEA S-87-640-2011
RoHS-compliant

Telcordia is a registered trademark of Ericsson Inc.

ENVIRONMENTAL SPECIFICATIONS

Operation/Storage -40°C to +70°C

Installation -30°C to +70°C

PART NUMBER KEY

F	1	_	_	_	x	x	0	y
1	2	3	4	5	6	7	8	9
Product family	Fiber count (006-096)			Fiber type	Internal designator		Water block/marketing (1-8)	

Contact Customer Service for availability of non-standard offerings.

PART NUMBERS AND PHYSICAL CHARACTERISTICS

Part Number ¹	Fiber Count	Nominal Diameter in (mm)	Approx. Weight lbs/kft (kg/km)	Maximum Tensile Loading		Minimum Bend Radius	
				Install lbs (N)	Long Term lbs (N)	Install in (mm)	Long Term in (mm)
F1006xx0y	6	0.47 (11.9)	75 (112)	600 (2,700)	200 (890)	9.4 (238)	4.7 (119)
F1012xx0y	12	0.47 (11.9)	75 (112)	600 (2,700)	200 (890)	9.4 (238)	4.7 (119)
F1024xx0y	24	0.47 (11.9)	75 (112)	600 (2,700)	200 (890)	9.4 (238)	4.7 (119)
F1036xx0y	36	0.47 (11.9)	75 (112)	600 (2,700)	200 (890)	9.4 (238)	4.7 (119)
F1048xx0y	48	0.47 (11.9)	75 (112)	600 (2,700)	200 (890)	9.4 (238)	4.7 (119)
F1072xx0y	72	0.55 (14.0)	101 (150)	600 (2,700)	200 (890)	11.0 (279)	5.5 (139)
F1096xx0y	96	0.55 (14.0)	101 (150)	600 (2,700)	200 (890)	11.0 (279)	5.5 (139)

FIBER TYPES:

SINGLE MODE

Reduced Water Peak Zero Water Peak TeraFlex® Bend Resistant
G.657.A1 G.657.A2 G.657.B3 NZDS LEAF

¹ For ≤ 12 fibers replace "xx" with:	36	26	K6	J6	L6	86	S6
¹ For > 12 fibers replace "xx" with:	31	21	K1	J1	L1	81	S1

MULTIMODE

TeraGain® TeraFlex Bend Resistant Laser Optimized 50/125
62.5/125 10G/150 10G/300 10G/550

6G	MG	NG	PG
----	----	----	----

See "Optical Fiber Specifications" in the "Technical Information" section for detailed fiber type specifications.

WATER BLOCK AND JACKET PRINT CODES

Dry core Dry core special
Feet Meters Feet Meters

¹ Replace "y" with:	1	2	5	6
--------------------------------	---	---	---	---

PRODUCT DESCRIPTION

Loose tube cables are the product of choice as the backbone in Outside Plant (OSP) applications. Single Loose tube cables offer a low cost alternative to traditional stranded loose tube cables. The highly flexible single tube reduces installation problems. The loose tube design offers reliable transmission performance over a broad temperature range. The single flex tube design features optical fibers placed inside a single PFM™ gel-filled tube. The core tube includes up to 8-fiber bundles, each containing up to 12 optical fibers bound with a color coded binder. The core is wrapped with water-blocking tape and then encased with a black jacket containing rigid strength rods. A rip cord is included under the jacket for ease of access to the core tube.

APPLICATIONS

- Underground duct and lashed aerial
- Trunk, distribution and feeder cable
- Local loop, metro, long-haul and broadband network

FEATURES

- Available with up to 96-fiber
- Multiple fiber types
- Dielectric outer strength members
- Dry (SAP) core standard
- Highly flexible
- Small cable diameter
- Fewer cable components
- PFM gel

BENEFITS

- High fiber density
- Multiple network applications
- Eliminates grounding or bonding problems
- Reduces cable prep and installation time
- Easy handling
- Installation of more fibers in less space
- Reduces cost
- Non-sticky gel speeds fiber access and clean-up

Single Flex Tube Single Armor

Series F2

PRODUCT DESCRIPTION

Single loose tube cables offer a low cost alternative to traditional stranded loose tube cables and the armor provides additional protection for certain environments. The highly flexible single tube reduces installation problems. The loose tube design offers reliable transmission performance over a broad temperature range. The single flex tube design features optical fibers placed inside a single PFM™ gel-filled tube. The core tube includes up to 8-fiber bundles, each containing up to 12 optical fibers bound with a color coded binder. The core is wrapped with flexible strength members covered with a water-blocking tape, a corrugated steel armor is applied and then encased with a black jacket containing rigid steel rods. Rip cords are included under the armor for ease of access to the core tube.

APPLICATIONS

- Direct bury, underground duct and lashed aerial
- Trunk, distribution and feeder cable
- Local loop, metro, long-haul and broadband network

FEATURES

- Available with up to 96-fiber
- Multiple fiber types
- Metallic outer strength members
- Dry (SAP) core standard
- Highly flexible
- Small cable diameter
- Fewer cable components
- Corrugated Armor
- PFM gel

BENEFITS

- High fiber density
- Multiple network applications
- Offers ease of location
- Reduces cable prep and installation time
- Easy handling
- Installation of more fibers in less space
- Reduces cost
- Improves compressive strength and rodent protection
- Non-sticky gel speeds fiber access and clean-up

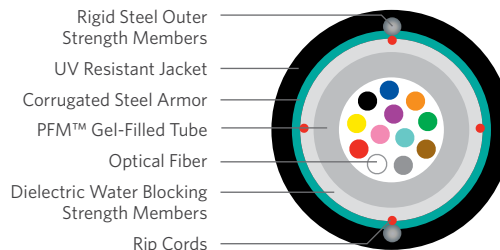

SPECIFICATIONS

Fiber Count	Available in 6-fiber up to 96-fiber
Standards Compliance	Telcordia® GR-20-CORE RDUP PE-90 Designation SLT ICEA S-87-640-2011 RoHS-compliant

Telcordia is a registered trademark of Ericsson Inc.

ENVIRONMENTAL SPECIFICATIONS

Operation/Storage	-40°C to +70°C
Installation	-30°C to +70°C

PART NUMBER KEY

F	2	-	-	-	x	x	S	y
1	2	3	4	5	6	7	8	9
Product family	Fiber count (006-096)				Fiber type	Internal designator	Water block/ marking (1-8)	

Contact Customer Service for availability of non-standard offerings.

PART NUMBERS AND PHYSICAL CHARACTERISTICS

Part Number ¹	Fiber Count	Nominal Diameter in (mm)	Approx. Weight lbs/kft (kg/km)	Maximum Tensile Loading		Minimum Bend Radius	
				Install lbs (N)	Long Term lbs (N)	Install in (mm)	Long Term in (mm)
F2006xxSy	6	0.51 (13.0)	117 (174)	600 (2,700)	200 (890)	10.2 (259)	5.1 (129)
F2012xxSy	12	0.51 (13.0)	117 (174)	600 (2,700)	200 (890)	10.2 (259)	5.1 (129)
F2024xxSy	24	0.51 (13.0)	117 (174)	600 (2,700)	200 (890)	10.2 (259)	5.1 (129)
F2036xxSy	36	0.51 (13.0)	117 (174)	600 (2,700)	200 (890)	10.2 (259)	5.1 (129)
F2048xxSy	48	0.51 (13.0)	117 (174)	600 (2,700)	200 (890)	10.2 (259)	5.1 (129)
F2072xxSy	72	0.58 (15.0)	150 (223)	600 (2,700)	200 (890)	11.6 (295)	5.8 (147)
F2096xxSy	96	0.58 (15.0)	150 (223)	600 (2,700)	200 (890)	11.6 (295)	5.8 (147)

FIBER TYPES:

SINGLE MODE

	Reduced Water Peak	Zero Water Peak	TeraFlex® Bend Resistant				
			G.657.A1	G.657.A2	G.657.B3	NZDS	LEAF
¹ For ≤ 12 fibers replace "xx" with:	36	26	K6	J6	L6	86	S6
¹ For > 12 fibers replace "xx" with:	31	21	K1	J1	L1	81	S1

MULTIMODE

TeraGain®	TeraFlex Bend Resistant Laser Optimized 50/125		
62.5/125	10G/150	10G/300	10G/550
6G	MG	NG	PG

See "Optical Fiber Specifications" in the "Technical Information" section for detailed fiber type specifications.

WATER BLOCK AND JACKET PRINT CODES

	Dry core		Dry core special	
	Feet	Meters	Feet	Meters
¹ Replace "y" with:	1	2	5	6

Flex Tube Locate

Series FM

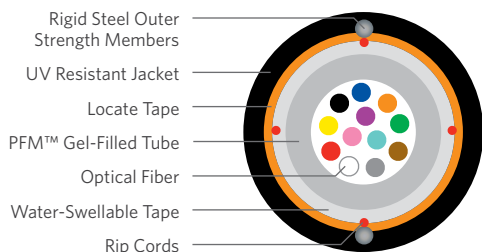

SPECIFICATIONS

Fiber Count	Available in 6-fiber up to 96-fiber
Standards Compliance	Telcordia® GR-20-CORE ICEA S-87-640-2011 RoHS-compliant

Telcordia is a registered trademark of Ericsson Inc.

ENVIRONMENTAL SPECIFICATIONS

Operation/Storage	-40°C to +70°C
Installation	-30°C to +70°C

PART NUMBER KEY

F	M	-	-	-	x	1	S	y
1	2	3	4	5	6	7	8	9
Product family	Fiber count (006-096)			Fiber type	Internal designator	Water block/marking (1-8)		

Contact Customer Service for availability of non-standard offerings.

PART NUMBERS AND PHYSICAL CHARACTERISTICS

Part Number ¹	Fiber Count	Nominal Diameter in (mm)	Approx. Weight lbs/kft (kg/km)	Maximum Tensile Loading		Minimum Bend Radius	
				Install lbs (N)	Long Term lbs (N)	Install in (mm)	Long Term in (mm)
FM006x1Sy	6	0.51 (12.9)	111 (165)	600 (2,700)	200 (890)	10.2 (258)	5.1 (129)
FM012x1Sy	12	0.51 (12.9)	111 (165)	600 (2,700)	200 (890)	10.2 (258)	5.1 (129)
FM024x1Sy	24	0.51 (12.9)	111 (165)	600 (2,700)	200 (890)	10.2 (258)	5.1 (129)
FM036x1Sy	36	0.51 (12.9)	111 (165)	600 (2,700)	200 (890)	10.2 (258)	5.1 (129)
FM048x1Sy	48	0.51 (12.9)	111 (165)	600 (2,700)	200 (890)	10.2 (258)	5.1 (129)
FM072x1Sy	72	0.59 (14.9)	131 (195)	600 (2,700)	200 (890)	11.8 (298)	5.9 (149)
FM096x1Sy	96	0.59 (14.9)	131 (195)	600 (2,700)	200 (890)	11.8 (298)	5.9 (149)

FIBER TYPES:

SINGLE MODE

Reduced Water Peak	Zero Water Peak	TeraFlex® Bend Resistant			NZDS	LEAF
		G.657.A1	G.657.A2	G.657.B3	8	S

¹Replace "x" with:

3	2	K	J	L	8	S
---	---	---	---	---	---	---

MULTIMODE

TeraGain®	TeraFlex Bend Resistant Laser Optimized 50/125		
62.5/125	10G/150	10G/300	10G/550

6	M	N	P
---	---	---	---

See "Optical Fiber Specifications" in the "Technical Information" section for detailed fiber type specifications.

WATER BLOCK AND JACKET PRINT CODES

Dry core		Dry core special	
Feet	Meters	Feet	Meters

¹ Replace "y" with:	1	2	5	6
--------------------------------	---	---	---	---

PRODUCT DESCRIPTION

Flex Tube Locate cables are designed to offer low resistivity (less than 10 Ohms per mile) and are for use in long distance remote location systems. These cables make use of a highly flexible tube that contains up to 8 loose optical fiber bundles, each containing 12 optical fibers. PFM™ gel is used inside the tube to reduce the time needed to access the fibers. The core is wrapped with a water-swellable tape to block water flow. A copper metallic locatable tape is applied and then encased in a black, UV resistant outer jacket of HDPE. Ripcords are included under the tape for ease of access to the core tube.

APPLICATIONS

- Direct bury, underground duct and lashed aerial
- Trunk, distribution and feeder cable
- Local loop, metro, long-haul and broadband network

FEATURES

- Available with up to 96-fiber
- Multiple fiber types
- Metallic outer strength members
- Dry (SAP) core standard
- Highly flexible
- Small cable diameter
- Fewer cable components
- Less than 10 Ohms/mile resistivity
- PFM gel

BENEFITS

- High fiber density
- Multiple network applications
- Offers ease of location
- Reduces cable prep and installation time
- Easy handling
- Installation of more fibers in less space
- Reduces cost
- Remote locate system
- Non-sticky gel speeds fiber access and clean-up

PRODUCT DESCRIPTION

Ribbon Locate cables are designed to offer low resistivity (less than 10 Ohms per mile) and are for use in long distance remote location systems. These cables make use of a highly flexible tube that contains up to 18 ribbons, each containing 12 optical fibers. PFM™ gel is used in the tube to reduce the time needed to access the fibers. The core is wrapped with a water-swallowable yarns to block water flow. A copper metallic locatable tape is applied and then encased in a black UV resistant outer jacket of HDPE. Ripcords are included under the tape for ease of access to the core tube.

APPLICATIONS

- Direct bury
- Broadband network
- Local loop
- Trunk, distribution and feeder cables

FEATURES

- Available with up to 216-fiber
- Multiple fiber types available
- Metallic outer strength members
- Highly flexible tube
- Less than 10 Ohms/mile resistivity
- Ribbon fiber
- Meets or exceeds Telcordia® specifications
- PFM gel

BENEFITS

- High fiber density
- Multiple network applications
- Metallic design offers easy location
- Easy handling and easy tube access
- Remote locate system
- Saves labor cost by offering mass fusion splicing
- Industry approved
- Non-sticky gel allows for easier and faster clean up

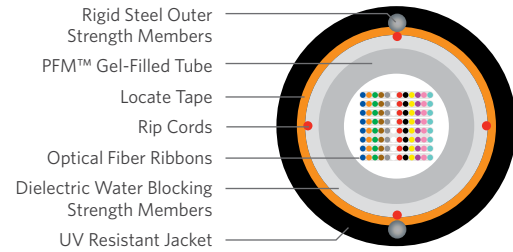

SPECIFICATIONS

Fiber Count Available in 60-fiber up to 216-fiber

Standards Compliance Telcordia® GR-20-CORE
ICEA S-87-640-2011
RoHS-compliant

Telcordia is a registered trademark of Ericsson Inc.

ENVIRONMENTAL SPECIFICATIONS

Operation/Storage -40°C to +70°C

Installation -30°C to +70°C

PART NUMBER KEY

R	M	-	-	-	x	1	S	y
1	2	3	4	5	6	7	8	9
Product family		Fiber count (060-216)			Fiber type	Internal designator		Water block/markings (1-8)

Contact Customer Service for availability of non-standard offerings.

PART NUMBERS AND PHYSICAL CHARACTERISTICS

Part Number ¹	Fiber Count	Nominal Diameter in (mm)	Nominal Weight lbs/kft (kg/km)	Maximum Tensile Loading		Minimum Bend Radius	
				Install lbs (N)	Long Term lbs (N)	Install in (mm)	Long Term in (mm)
RM060x1Sy	60	0.58 (15.0)	150 (223)	600 (2,700)	200 (890)	11.6 (295)	5.8 (147)
RM072x1Sy	72	0.58 (15.0)	150 (223)	600 (2,700)	200 (890)	11.6 (295)	5.8 (147)
RM096x1Sy	96	0.58 (15.0)	150 (223)	600 (2,700)	200 (890)	11.6 (295)	5.8 (147)
RM144x1Sy	144	0.66 (17.0)	187 (279)	600 (2,700)	200 (890)	13.2 (335)	6.0 (152)
RM192x1Sy	192	0.66 (17.0)	195 (290)	600 (2,700)	200 (890)	13.6 (345)	6.8 (173)
RM216x1Sy	216	0.66 (17.0)	195 (290)	600 (2,700)	200 (890)	13.6 (345)	6.8 (173)

FIBER TYPES:

SINGLE MODE

HYBRID

	Reduced Water Peak	Zero Water Peak	TeraFlex® Bend Resistant G.657.A1	NZDS	LEAF	Hybrid
¹ Replace "x" with:	3	2	K	8	S	H

See "Optical Fiber Specifications" in the "Technical Information" section for detailed fiber type specifications.

WATER BLOCK AND JACKET PRINT CODES

	Dry core		Dry core special	
	Feet	Meters	Feet	Meters
¹ Replace "y" with:	1	2	5	6

Loose Tube Single Jacket All Dielectric Nylon

Series 1NY

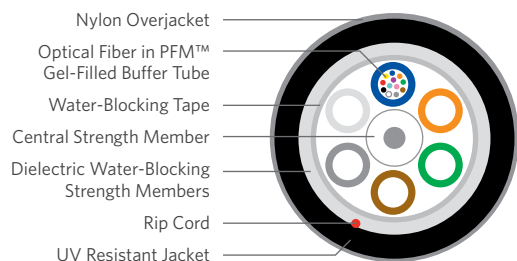

PRODUCT DESCRIPTION

Loose tube cables are the product of choice as the backbone in Outside Plant (OSP) environments. The durable loose tube design offers reliable transmission performance over a broad temperature range. Optical fibers are placed inside filled buffer tubes containing PFM™ gel. The core is constructed by stranding the buffer tubes around a central member using a reverse oscillating lay (ROL). The core is wrapped with flexible strength members covered with a water-blocking tape, then encased with a black jacket. A rip cord is included under the jacket for ease of entry. The nylon overjacket completes the cable.

APPLICATIONS

- Underground duct and lashed aerial
- Trunk, distribution and feeder cable
- Local loop, metro, long-haul and broadband network

SPECIFICATIONS

Fiber Count	Available in 6-fiber up to 288-fiber
Standards Compliance	Telcordia® GR-20-CORE RDUP PE-90 Designation MLT ICEA S-87-640-2011 RoHS-compliant

Telcordia is a registered trademark of Ericsson Inc.

ENVIRONMENTAL SPECIFICATIONS

Operation/Storage	-40°C to +70°C
Installation	-30°C to +70°C

PART NUMBER KEY

1	2	-	-	-	x	N	0	y
1	2	3	4	5	6	7	8	9
Product family	Fiber count (006-288)			Fiber type	Internal designator	Water block/marking (1-8)		

Contact Customer Service for availability of non-standard offerings.

PART NUMBERS AND PHYSICAL CHARACTERISTICS

Part Number ¹	Fiber Count	Nominal Diameter in (mm)	Approx. Weight lbs/kft (kg/km)	Maximum Tensile Loading		Minimum Bend Radius	
				Install lbs (N)	Long Term lbs (N)	Install in (mm)	Long Term in (mm)
11006xN0y	6	0.49 (12.4)	70 (105)	600 (2,700)	200 (890)	9.8 (248)	4.9 (124)
11012xN0y	12	0.49 (12.4)	70 (105)	600 (2,700)	200 (890)	9.8 (248)	4.9 (124)
11024xN0y	24	0.49 (12.4)	70 (105)	600 (2,700)	200 (890)	9.8 (248)	4.9 (124)
11036xN0y	36	0.49 (12.4)	70 (105)	600 (2,700)	200 (890)	9.8 (248)	4.9 (124)
11048xN0y	48	0.49 (12.4)	70 (105)	600 (2,700)	200 (890)	9.8 (248)	4.9 (124)
11072xN0y	72	0.53 (13.5)	86 (129)	600 (2,700)	200 (890)	10.6 (270)	5.3 (135)
11096xN0y	96	0.61 (15.4)	107 (160)	600 (2,700)	200 (890)	12.2 (308)	6.1 (154)
11144xN0y	144	0.75 (19.0)	162 (241)	600 (2,700)	200 (890)	15.0 (380)	7.5 (190)
11216xN0y	216	0.78 (19.8)	161 (239)	600 (2,700)	200 (890)	15.6 (396)	7.8 (198)
11288xN0y	288	0.87 (22.0)	203 (302)	600 (2,700)	200 (890)	17.4 (440)	8.7 (220)

FIBER TYPES:

SINGLE MODE

Reduced Water Peak	Zero Water Peak	TeraFlex® Bend Resistant			
		G.657.A1	G.657.A2	G.657.B3	NZDS LEAF

¹Replace "x" with:

3	2	K	J	L	8	S
---	---	---	---	---	---	---

HYBRID

Hybrid

MULTIMODE

TeraGain®	TeraFlex Bend Resistant Laser Optimized 50/125		
62.5/125	10G/150	10G/300	10G/550

6	M	N	P
---	---	---	---

See "Optical Fiber Specifications" in the "Technical Information" section for detailed fiber type specifications.

WATER BLOCK AND JACKET PRINT CODES

Dry core		Dry core special	
Feet	Meters	Feet	Meters

¹Replace "y" with:

1	2	5	6
---	---	---	---

PRODUCT DESCRIPTION

Loose tube riser cables are ideal for campus environments, private networks and local area networks. These dual purpose cables save money and installation time by allowing a direct transition from indoor to outdoor applications with a single cable. Because these cables are fully water blocked with dry elements, stripping and termination is faster. These cables comply with the standards for both Outside Plant (OSP) and indoor riser applications. The loose tube design offers reliable transmission performance over a broad temperature range. The durable loose tube design features optical fibers placed inside gel-free buffer tubes. The core is constructed by stranding the buffer tubes around a central member using a reverse oscillating lay (ROL). It is wrapped with flexible strength members, covered with a heat resistant, water-blocking tape and then encased with a black, flame and sunlight resistant jacket. A rip cord is included under the jacket for ease of entry.

APPLICATIONS

- Underground duct and lashed aerial
- Trunk, distribution and feeder cable
- Local loop, metro, long-haul and broadband network

FEATURES

- Available with up to 288-fiber
- Multiple fiber types including hybrids
- UL Listed, sunlight resistant
- Dielectric outer strength members
- Dry (SAP) core standard
- Standard tube size for all fiber counts
- Transitions from indoor to outdoor to indoor with no termination
- Gel-free

BENEFITS

- High fiber density
- Multiple network applications
- Longer cable life
- Eliminates grounding or bonding problems
- Reduces cable prep and installation time
- Reduces the number of tools required
- Reduces labor cost
- Speeds fiber access and clean-up

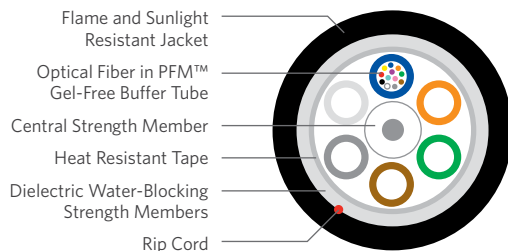

SPECIFICATIONS

Fiber Count	Available in 2-fiber up to 288-fiber
Performance Compliance	Telcordia® GR-20-CORE, Issue 3 UL 1666 RoHS-compliant
NRTL Programs	UL, c(UL) Listed OFNR

Telcordia is a registered trademark of Ericsson Inc.

ENVIRONMENTAL SPECIFICATIONS

Operation/Storage	-40°C to +70°C
Installation	-10°C to +70°C

PART NUMBER KEY

1	3	-	-	-	x	x	0	y
1	2	3	4	5	6	7	8	9
Product family	Fiber count (006-288)				Fiber type	Internal designator	Water block/ marking (1-8)	

Contact Customer Service for availability of non-standard offerings.

PART NUMBERS AND PHYSICAL CHARACTERISTICS

Listing	Part Number ¹	Fiber Count	Nominal Diameter in (mm)	Nominal Weight lbs/kft (kg/km)	Maximum Tensile Loading		Minimum Bend Radius	
					Install lbs (N)	Long Term lbs (N)	Install in (mm)	Long Term in (mm)
OFNR	13006Dx0y	6	0.45 (11.4)	80 (119)	600 (2,700)	200 (890)	9.0 (228)	4.5 (114)
OFNR	13012Dx0y	12	0.45 (11.4)	80 (119)	600 (2,700)	200 (890)	9.0 (228)	4.5 (114)
OFNR	13024Dx0y	24	0.45 (11.4)	80 (119)	600 (2,700)	200 (890)	9.0 (228)	4.5 (114)
OFNR	13036Dx0y	36	0.45 (11.4)	80 (119)	600 (2,700)	200 (890)	9.0 (228)	4.5 (114)
OFNR	13048Dx0y	48	0.45 (11.4)	80 (119)	600 (2,700)	200 (890)	9.0 (228)	4.5 (114)
OFNR	13072Dx0y	72	0.48 (12.0)	93 (138)	600 (2,700)	200 (890)	9.6 (240)	4.8 (120)
OFNR	13096Dx0y	96	0.54 (13.8)	120 (179)	600 (2,700)	200 (890)	10.8 (276)	5.4 (138)
OFNR	13144Dx0y	144	0.68 (17.1)	184 (275)	600 (2,700)	200 (890)	13.6 (342)	6.8 (171)
OFNR	13216Dx0y	216	0.68 (17.1)	168 (251)	600 (2,700)	200 (890)	13.6 (342)	6.8 (171)
OFNR	13288Dx0y	288	0.79 (20.0)	221 (330)	600 (2,700)	200 (890)	15.8 (400)	7.9 (200)

FIBER TYPES:

SINGLE MODE

Reduced Water Peak	Zero Water Peak	TeraFlex® Bend Resistant			
		G.657.A1	G.657.A2	G.657.B3	NZDS LEAF

HYBRID

Hybrid

MULTIMODE

TeraGain® 62.5/125	TeraFlex Bend Resistant Laser Optimized 50/125		
	10G/150	10G/300	10G/550

¹Replace "x" with:

3	2	K	J	L	8	S
---	---	---	---	---	---	---

H

6	M	N	P
---	---	---	---

See "Optical Fiber Specifications" in the "Technical Information" section for detailed fiber type specifications.

WATER BLOCK AND JACKET PRINT CODES

Dry core		Dry core special	
Feet	Meters	Feet	Meters

¹Replace "y" with:

1	2	5	6
---	---	---	---

Loose Tube Indoor/Outdoor

OFNR Series 13

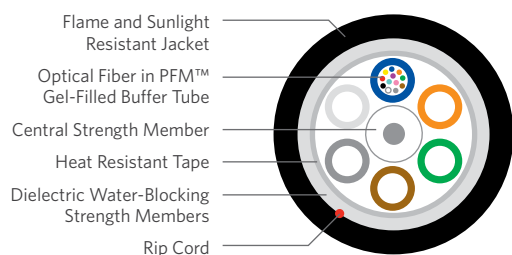

PRODUCT DESCRIPTION

Loose tube riser cables are ideal for campus environments, private networks and local area networks. These dual purpose cables save money and installation time by allowing a direct transition from indoor to outdoor applications with a single cable. Because these cables are fully water blocked with dry elements, stripping and termination is faster. These cables comply with the standards for both Outside Plant (OSP) and indoor riser applications. The loose tube design offers reliable transmission performance over a broad temperature range. The durable loose tube design features optical fibers placed inside PFM™ gel-filled buffer tubes. The core is constructed by stranding the buffer tubes around a central member using a reverse oscillating lay (ROL). It is wrapped with flexible strength members, covered with a heat resistant, water-blocking tape and then encased with a black, flame and sunlight resistant jacket. A rip cord is included under the jacket for ease of entry.

SPECIFICATIONS

Fiber Count	Available in 6-fiber up to 288-fiber
Performance Compliance	Telcordia® GR-20-CORE, Issue 3 UL® 1666 RoHS-compliant
NRTL Programs	UL, c(UL) Listed OFNR

Telcordia is a registered trademark of Ericsson Inc. UL is a registered trademark of UL LLC.

ENVIRONMENTAL SPECIFICATIONS

Operation/Storage	-40°C to +70°C
Installation	-10°C to +70°C

PART NUMBER KEY

1	3	_	_	_	x	x	0	y
1	2	3	4	5	6	7	8	9
Product family	Fiber count (006-288)	Fiber type	Internal designator	Water block/ marking (1-8)				

Contact Customer Service for availability of non-standard offerings.

APPLICATIONS

- Underground duct and lashed aerial
- Trunk, distribution and feeder cable
- Local loop, metro, long-haul and broadband network

FEATURES

- Available with up to 288-fiber
- Multiple fiber types including hybrids
- UL Listed, sunlight resistant
- Dielectric outer strength members
- Dry (SAP) core standard
- Standard tube size for all fiber counts
- Transitions from indoor to outdoor to indoor with no termination
- PFM gel

BENEFITS

- High fiber density
- Multiple network applications
- Longer cable life
- Eliminates grounding or bonding problems
- Reduces cable prep and installation time
- Reduces the number of tools required
- Reduces labor cost
- Non-sticky gel speeds fiber access and clean-up

PART NUMBERS AND PHYSICAL CHARACTERISTICS

Listing	Part Number ¹	Fiber Count	Nominal Diameter in (mm)	Nominal Weight lbs/kft (kg/km)	Maximum Tensile Loading		Minimum Bend Radius	
					Install lbs (N)	Long Term lbs (N)	Install in (mm)	Long Term in (mm)
OFNR	13006xx0y	6	0.45 (11.4)	80 (119)	600 (2,700)	200 (890)	9.0 (228)	4.5 (114)
OFNR	13012xx0y	12	0.45 (11.4)	80 (119)	600 (2,700)	200 (890)	9.0 (228)	4.5 (114)
OFNR	13024xx0y	24	0.45 (11.4)	80 (119)	600 (2,700)	200 (890)	9.0 (228)	4.5 (114)
OFNR	13036xx0y	36	0.45 (11.4)	80 (119)	600 (2,700)	200 (890)	9.0 (228)	4.5 (114)
OFNR	13048xx0y	48	0.45 (11.4)	80 (119)	600 (2,700)	200 (890)	9.0 (228)	4.5 (114)
OFNR	13072xx0y	72	0.48 (12.0)	93 (138)	600 (2,700)	200 (890)	9.6 (240)	4.8 (120)
OFNR	13096xx0y	96	0.54 (13.8)	120 (179)	600 (2,700)	200 (890)	10.8 (276)	5.4 (138)
OFNR	13144xx0y	144	0.68 (17.1)	184 (275)	600 (2,700)	200 (890)	13.6 (342)	6.8 (171)
OFNR	13216xx0y	216	0.68 (17.1)	168 (251)	600 (2,700)	200 (890)	13.6 (342)	6.8 (171)
OFNR	13288xx0y	288	0.79 (20.0)	221 (330)	600 (2,700)	200 (890)	15.8 (400)	7.9 (200)

FIBER TYPES:

SINGLE MODE

HYBRID

MULTIMODE

	Reduced Water Peak		Zero Water Peak		TeraFlex® Bend Resistant			Hybrid	TeraGain® 62.5/125	TeraFlex Bend Resistant Laser Optimized 50/125		
	3T	2T	G.657.A1	G.657.A2	G.657.B3	NZDS	LEAF			10G/150	10G/300	10G/550
¹ For ≤ 36 fibers replace "xx" with:			KT	JT	LT	8T	ST	H_	6G	MG	NG	PG
¹ For > 36 fibers replace "xx" with:	31	21	K1	J1	L1	81	S1					

See "Optical Fiber Specifications" in the "Technical Information" section for detailed fiber type specifications.

WATER BLOCK AND JACKET PRINT CODES

	Dry core		Dry core special	
	Feet	Meters	Feet	Meters
¹ Replace "y" with:	1	2	5	6

PRODUCT DESCRIPTION

Interlock Armored Optical Fiber Cables provide for an extremely well protected cable package ideally suited for harsh environments. The armor is available in aluminum or steel and comes with an OFCR (riser) rating. This design offers the system designer a product that can be installed in high traffic areas where added mechanical protection and security are required. The flexible interlock armored cable design is also popular for retrofit applications and eliminates the need to install rigid conduit while still meeting building code guidelines.

APPLICATIONS

- Intrabuilding backbones
- Conduit pathways
- Service entrance to communication closets

FEATURES

- Thick, flexible metallic armor
- Flame retardant, UL Listed designs
- Full line of Superior Essex cables available

BENEFITS

- Reduce incidences of circuit disruption due to rodents or mechanically abusive applications
- Eliminates the need for multiple cables for installation
- Customized designs reduces cable inventory requirements

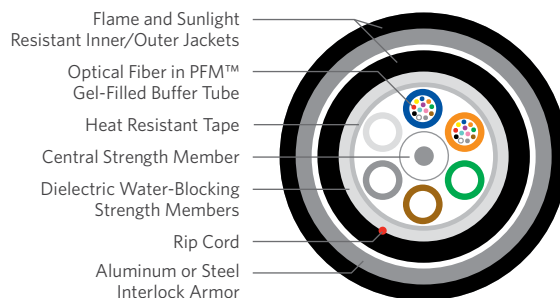

SPECIFICATIONS

Fiber Count	Available in 6-fiber up to 144-fiber
Core Configuration	Loose Tube Indoor/Outdoor OFNR Series 13 cable
Interlock Armored	Flexible, heavy duty interlocking aluminum or steel tape helically applied over the inner cable core; further protection is provided by an optional outer jacket
Outer Jacket	Black, flame retardant, chemical resistant and sunlight resistant PVC
Performance Compliance	UL® 1569 Telcordia® GR-20-CORE, Issue 2 UL 1666 RoHS-compliant
NRTL Programs	UL, c(UL) Listed OFCR

UL is a registered trademark of UL LLC. Telcordia is a registered trademark of Ericsson Inc.

PART NUMBER KEY

L	3	_	_	_	x	1	0	y
1	2	3	4	5	6	7	8	9
Product family	Fiber count (006-144)				Fiber type	Internal designator	Water block/ marking (1-8)	

Contact Customer Service for availability of non-standard offerings.

ENVIRONMENTAL SPECIFICATIONS

Operation/Storage	-40°C to +70°C
Installation	-10°C to +70°C

PART NUMBERS AND PHYSICAL CHARACTERISTICS

Listing	Part Number ¹	Fiber Count	Nominal Diameter in (mm)	Nominal Weight lbs/kft (kg/km)	Maximum Tensile Loading		Minimum Bend Radius	
					Install lbs (N)	Long Term lbs (N)	Install in (mm)	Long Term in (mm)
OFNR	L3006x10y	6	0.96 (24.3)	301 (448)	600 (2,700)	200 (890)	14.5 (367)	9.6 (243)
OFNR	L3012x10y	12	0.96 (24.3)	301 (448)	600 (2,700)	200 (890)	14.5 (367)	9.6 (243)
OFNR	L3024x10y	24	0.96 (24.3)	301 (448)	600 (2,700)	200 (890)	14.5 (367)	9.6 (243)
OFNR	L3048x10y	48	0.96 (24.3)	301 (448)	600 (2,700)	200 (890)	14.5 (367)	9.6 (243)
OFNR	L3072x10y	72	1.01 (25.5)	316 (470)	600 (2,700)	200 (890)	15.2 (383)	10.1 (255)
OFNR	L3096x10y	96	1.07 (27.1)	346 (515)	600 (2,700)	200 (890)	16.1 (406)	10.7 (271)
OFNR	L3144x10y	144	1.20 (30.8)	424 (631)	600 (2,700)	200 (890)	18.3 (463)	12.2 (308)

FIBER TYPES:

SINGLE MODE

Reduced Water Peak	Zero Water Peak	TeraFlex® Bend Resistant			
		G.657.A1	G.657.A2	G.657.B3	NZDS LEAF

HYBRID

Hybrid

MULTIMODE

TeraGain® 62.5/125	TeraFlex Bend Resistant Laser Optimized 50/125		
	10G/150	10G/300	10G/550

¹Replace "x" with:

3	2	K	J	L	8	S
---	---	---	---	---	---	---

See "Optical Fiber Specifications" in the "Technical Information" section for detailed fiber type specifications.

WATER BLOCK AND JACKET PRINT CODES

Dry core		Dry core special	
Feet	Meters	Feet	Meters

¹Replace "y" with:

1	2	5	6
---	---	---	---

Loose Tube Single Jacket All Dielectric Indoor/Outdoor LSZH

Series HZD

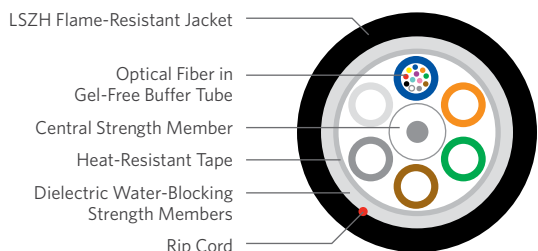

PRODUCT DESCRIPTION

Low Smoke Zero Halogen cables are ideal for indoor/outdoor applications such as campus environments, tunnels and subway passages. Series HZD cables comply with NFPA-130, UL 1666 and are rated OFNR-LS. These dual purpose cables save money and installation time by allowing a direct transition from indoor to outdoor applications with a single cable. Because these cables are fully water blocked with dry elements, stripping and termination is faster. These cables comply with the standards for both Outside Plant (OSP) and indoor riser applications. The loose tube design offers reliable transmission performance over a broad temperature range. The durable, loose tube design features optical fibers placed inside gel-free buffer tubes which are stranded around a central member. The core is wrapped with flexible strength members, covered with a heat-resistant, water-blocking tape and then encased with a black, flame and sunlight-resistant jacket. A rip cord is included under the jacket for ease of entry.

APPLICATIONS

- Underground duct and lashed aerial
- Campus environment
- Tunnels, subways, rapid rail

FEATURES

- Available with up to 288-fiber
- Multiple fiber types including hybrids
- UL Listed, sunlight resistant
- Transitions from indoor to outdoor to indoor with no termination
- Gel free

BENEFITS

- High fiber density
- Multiple network applications
- Longer cable life
- Reduces labor cost
- Speeds fiber access and cleanup

SPECIFICATIONS

Fiber Count	Available in 6-fiber up to 288-fiber
Performance Compliance	Telcordia® GR-20-CORE NFPA-130 UL® 1666 UL 1685 RoHS-compliant
NRTL Programs	UL, c(UL) Listed OFNR

Telcordia is a registered trademark of Ericsson Inc. UL is a registered trademark of UL LLC.

ENVIRONMENTAL SPECIFICATIONS

Operation/Storage	-40°C to +70°C
Installation	-30°C to +70°C

PART NUMBER KEY

F	H	1	0	-	-	-	-	x	x	x	-	E	9	9	1 or 2	
1	2	3	4	5	6	7	8	9	10	11	12	13	14	15	16	
Fiber cable	Cable type			-	Fiber count (006-288)				Fiber type			-	Jacket color	Package		Jacket print

Contact Customer Service for availability of non-standard offerings.

PART NUMBERS AND PHYSICAL CHARACTERISTICS

Listing	Previous Part Number	Current Part Number ¹	Fiber Count	Nominal Diameter in (mm)	Nominal Weight lbs/kft (kg/km)	Maximum Tensile Loading		Minimum Bend Radius	
						Install lbs (N)	Long Term lbs (N)	Install in (mm)	Long Term in (mm)
OFNR-LS	HZ0063021	FH10-006xxx-E99y	6	0.47 (11.8)	92 (137)	600 (2,700)	200 (890)	9.4 (236)	4.7 (118)
OFNR-LS	HZ0123021	FH10-012xxx-E99y	12	0.47 (11.8)	92 (137)	600 (2,700)	200 (890)	9.4 (236)	4.7 (118)
OFNR-LS	HZ0243021	FH10-024xxx-E99y	24	0.47 (11.8)	92 (137)	600 (2,700)	200 (890)	9.4 (236)	4.7 (118)
OFNR-LS	HZ0363021	FH10-036xxx-E99y	36	0.47 (11.8)	92 (137)	600 (2,700)	200 (890)	9.4 (236)	4.7 (118)
OFNR-LS	HZ0483021	FH10-048xxx-E99y	48	0.47 (11.8)	92 (137)	600 (2,700)	200 (890)	9.4 (236)	4.7 (118)
OFNR-LS	HZ0603021	FH10-060xxx-E99y	60	0.47 (11.8)	92 (137)	600 (2,700)	200 (890)	9.4 (236)	4.7 (118)
OFNR-LS	HZ0723021	FH10-072xxx-E99y	72	0.49 (11.9)	106 (158)	600 (2,700)	200 (890)	9.8 (239)	4.9 (119)
OFNR-LS	HZ0963021	FH10-096xxx-E99y	96	0.56 (12.4)	124 (185)	600 (2,700)	200 (890)	11.2 (249)	5.6 (124)
OFNR-LS	HZ1443021	FH10-144xxx-E99y	144	0.69 (14.2)	169 (252)	600 (2,700)	200 (890)	13.8 (284)	6.9 (142)
OFNR-LS	HZ2163021	FH10-216xxx-E99y	216	0.69 (14.2)	169 (252)	600 (2,700)	200 (890)	13.8 (284)	6.9 (142)
OFNR-LS	HZ2883021	FH10-288xxx-E99y	288	0.97 (20.0)	207 (309)	600 (2,700)	200 (890)	19.4 (400)	9.7 (200)

FIBER TYPES:

SINGLE MODE

Reduced Water Peak	Corning® RWP	Zero Water Peak	TeraFlex® Bend Resistant				
			G.657.A1	G.657.A2	G.657.B3	NZDS	LEAF

HYBRID

Hybrid
call for info

MULTIMODE

TeraFlex Bend Resistant Laser Optimized 50/125			
TeraGain®			
62.5/125	10G/150	10G/300	10G/550
U23	U28	U30	U32

¹Replace "xxx" with: U10 C10 U17 U13 U14 U15 U19 C19

See "Optical Fiber Specifications" in the "Technical Information" section for detailed fiber type specifications.

JACKET PRINT

	Feet	Meters
¹ Replace "y" with:	1	2

Loose Tube Single Jacket Single Armor Indoor/Outdoor LSZH

Series HZA

PRODUCT DESCRIPTION

Low Smoke Zero Halogen cables are ideal for indoor/outdoor applications such as campus environments, tunnels and subway passages. Series HZA cables comply with NFPA-130, UL 1666 and are rated OFCR-LS. These dual purpose cables save money and installation time by allowing a direct transition from indoor to outdoor applications with a single cable. Because these cables are fully water blocked with dry elements, stripping and termination is faster. These cables comply with the standards for both Outside Plant (OSP) and indoor riser applications. The loose tube design offers reliable transmission performance over a broad temperature range. The durable, loose tube design features optical fibers placed inside gel-free buffer tubes which are stranded around a central member. The core is wrapped with flexible strength members, covered with a heat-resistant, water-blocking tape, corrugated steel armor and then encased with a black, flame and sunlight-resistant jacket. A rip cord is included under the jacket for ease of entry.

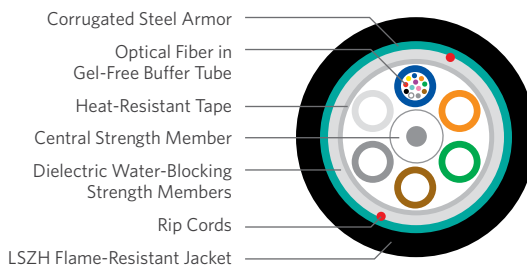

APPLICATIONS

- Underground duct and lashed aerial
- Campus environment
- Tunnels, subways, rapid rail

FEATURES

- Available with up to 288-fiber
- Multiple fiber types including hybrids
- UL Listed, sunlight resistant
- Transitions from indoor to outdoor to indoor with no termination
- Gel free

BENEFITS

- High fiber density
- Multiple network applications
- Longer cable life
- Reduces labor cost
- Speeds fiber access and cleanup

SPECIFICATIONS

Fiber Count	Available in 6-fiber up to 288-fiber
Performance Compliance	Telcordia® GR-20-CORE NFPA-130 UL® 1666 UL 1685 RoHS-compliant
NRTL Programs	UL, c(UL) Listed OFNR

Telcordia is a registered trademark of Ericsson Inc. UL is a registered trademark of UL LLC. Corning is a registered trademark of Corning Incorporated.

ENVIRONMENTAL SPECIFICATIONS

Operation/Storage	-40°C to +70°C
Installation	-30°C to +70°C

PART NUMBER KEY

F	H	2	6	-	-	-	-	x	x	x	-	E	9	9	1 or 2	
1	2	3	4	5	6	7	8	9	10	11	12	13	14	15	16	
Fiber cable	Cable type			-	Fiber count (006-288)				Fiber type			-	Jacket color	Package		Jacket print

Contact Customer Service for availability of non-standard offerings.

PART NUMBERS AND PHYSICAL CHARACTERISTICS

Listing	Previous Part Number	Current Part Number ¹	Fiber Count	Nominal Diameter in (mm)	Nominal Weight lbs/kft (kg/km)	Maximum Tensile Loading		Minimum Bend Radius	
						Install lbs (N)	Long Term lbs (N)	Install in (mm)	Long Term in (mm)
OFCR-LS	HZ0063121	FH26-006xxx-E99y	6	0.52 (13.2)	129 (192)	600 (2,700)	200 (890)	10.4 (264)	5.2 (132)
OFCR-LS	HZ0123121	FH26-012xxx-E99y	12	0.52 (13.2)	129 (192)	600 (2,700)	200 (890)	10.4 (264)	5.2 (132)
OFCR-LS	HZ0243121	FH26-024xxx-E99y	24	0.52 (13.2)	129 (192)	600 (2,700)	200 (890)	10.4 (264)	5.2 (132)
OFCR-LS	HZ0363121	FH26-036xxx-E99y	36	0.52 (13.2)	129 (192)	600 (2,700)	200 (890)	10.4 (264)	5.2 (132)
OFCR-LS	HZ0483121	FH26-048xxx-E99y	48	0.52 (13.2)	129 (192)	600 (2,700)	200 (890)	10.4 (264)	5.2 (132)
OFCR-LS	HZ0603121	FH26-060xxx-E99y	60	0.52 (13.2)	129 (192)	600 (2,700)	200 (890)	10.4 (264)	5.2 (132)
OFCR-LS	HZ0723121	FH26-072xxx-E99y	72	0.55 (14.0)	129 (192)	600 (2,700)	200 (890)	11.0 (279)	5.5 (140)
OFCR-LS	HZ9603121	FH26-096xxx-E99y	96	0.62 (15.7)	145 (216)	600 (2,700)	200 (890)	12.4 (315)	6.2 (157)
OFCR-LS	HZ1443121	FH26-144xxx-E99y	144	0.75 (19.0)	170 (254)	600 (2,700)	200 (890)	15.0 (381)	7.5 (191)
OFCR-LS	HZ2163121	FH26-216xxx-E99y	216	0.75 (19.0)	170 (254)	600 (2,700)	200 (890)	15.0 (381)	7.5 (191)
OFCR-LS	HZ2883121	FH26-288xxx-E99y	288	0.87 (22.0)	288 (430)	600 (2,700)	200 (890)	17.4 (444)	8.7 (220)

FIBER TYPES:	SINGLE MODE						HYBRID			MULTIMODE				
	Reduced Water Peak		Corning® RWP	Zero Water Peak	TeraFlex® Bend Resistant			NZDS	LEAF	Hybrid	TeraFlex Bend Resistant Laser Optimized 50/125			
	U10	C10	U17	G.657.A1	G.657.A2	G.657.B3	U19	C19	call for info	62.5/125	10G/150	10G/300	10G/550	
¹ Replace "xxx" with:	U10	C10	U17	U13	U14	U15	U19	C19	call for info	U23	U28	U30	U32	

See "Optical Fiber Specifications" in the "Technical Information" section for detailed fiber type specifications.

JACKET PRINT

	Feet	Meters
¹ Replace "y" with:	1	2

Single Loose Tube Indoor/Outdoor

OFNR Series 53

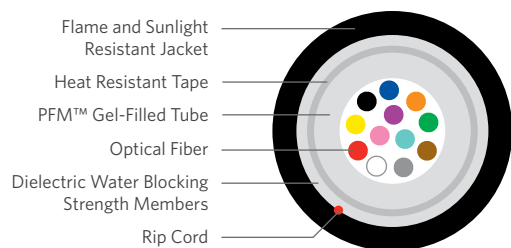

PRODUCT DESCRIPTION

Loose tube riser cables are ideal for campus environments, private networks and local area networks. These dual purpose cables save money and installation time by allowing a direct transition from indoor to outdoor applications with a single cable. Loose tube cables are the product of choice as the backbone in Outside Plant (OSP) applications. Single Loose tube cables offer a low cost alternative to traditional stranded loose tube cables. The loose tube design offers reliable transmission performance over a broad temperature range. The durable single loose tube design features optical fibers placed inside a single PFM™ gel-filled tube. The core tube includes up to 8-fiber bundles, each containing up to 12 optical fibers bound with a color coded binder. The core tube is then helically wrapped with water-blocking strength members, then encased with a black, flame resistant jacket. A rip cord is included under the jacket to provide ease of access to the core tube.

APPLICATIONS

- UL Listed sunlight resistant indoor/outdoor
- Lashed aerial, duct or riser
- Inter-building connection
- Campus environments

FEATURES

- Available with up to 96-fiber
- Multiple fiber types
- UL Listed, sunlight resistant
- Dielectric outer strength members
- Dry (SAP) core standard
- Highly flexible
- Small cable diameter
- Fewer cable components
- Transitions from indoor to outdoor to indoor with no termination
- PFM gel

BENEFITS

- High fiber density
- Multiple network applications
- Longer cable life
- Eliminates grounding or bonding problems
- Reduces cable prep and installation time
- Easy handling
- Installation of more fibers in less space
- Reduces cost
- Reduces labor cost
- Non-sticky gel speeds fiber access and clean-up

SPECIFICATIONS

Fiber Count	Available in 6-fiber up to 96-fiber
Performance Compliance	Telcordia® GR-20-CORE, Issue 3 UL® 1666 RoHS-compliant
NRTL Programs	UL, c(UL) Listed OFNR

Telcordia is a registered trademark of Ericsson Inc. UL is a registered trademark of UL LLC.

ENVIRONMENTAL SPECIFICATIONS

Operation/Storage	-40°C to +70°C
Installation	-10°C to +70°C

PART NUMBER KEY

5	3	-	-	-	x	x	0	y
1	2	3	4	5	6	7	8	9
Product family	Fiber count (006-096)	Fiber type	Internal designator	Water block/marking (1-8)				

Contact Customer Service for availability of non-standard offerings.

PART NUMBERS AND PHYSICAL CHARACTERISTICS

Listing	Part Number ¹	Fiber Count	Nominal Diameter in (mm)	Nominal Weight lbs/kft (kg/km)	Maximum Tensile Loading		Minimum Bend Radius	
					Install lbs (N)	Long Term lbs (N)	Install in (mm)	Long Term in (mm)
OFNR	53006xx0y	6	0.30 (7.5)	35 (53)	600 (2,700)	200 (890)	6.0 (150)	3.0 (75)
OFNR	53012xx0y	12	0.30 (7.5)	35 (53)	600 (2,700)	200 (890)	6.0 (150)	3.0 (75)
OFNR	53024xx0y	24	0.37 (9.5)	52 (77)	600 (2,700)	200 (890)	7.4 (190)	3.7 (95)
OFNR	53036xx0y	36	0.37 (9.5)	52 (77)	600 (2,700)	200 (890)	7.4 (190)	3.7 (95)
OFNR	53048xx0y	48	0.37 (9.5)	52 (77)	600 (2,700)	200 (890)	7.4 (190)	3.7 (95)
OFNR	53072xx0y	72	0.50 (12.8)	96 (143)	600 (2,700)	200 (890)	10.0 (256)	5.0 (128)
OFNR	53096xx0y	96	0.50 (12.8)	96 (143)	600 (2,700)	200 (890)	10.0 (256)	5.0 (128)

FIBER TYPES:

SINGLE MODE

Reduced Water Peak Zero Water Peak TeraFlex® Bend Resistant

G.657.A1 G.657.A2 G.657.B3 NZDS LEAF

¹Replace "xx" with:

31 21 K1 J1 L1 81 S1

MULTIMODE

TeraGain® TeraFlex Bend Resistant Laser Optimized 50/125

62.5/125 10G/150 10G/300 10G/550

¹Replace "y" with:

6G MG NG PG

See "Optical Fiber Specifications" in the "Technical Information" section for detailed fiber type specifications.

WATER BLOCK AND JACKET PRINT CODES

Dry core Dry core special

Feet Meters Feet Meters

¹Replace "y" with:

1 2 5 6

Heavy Duty Loose Tube

OFNR Series 1H

PRODUCT DESCRIPTION

Heavy Duty Loose Tube OFNR Cables are ideally suited for harsh environment applications including mining, steel mills, refineries, lumber mills and many other situations requiring a durable cable construction. These cables have been specifically designed to have greater tensile, crush and impact ratings. With a dual layer of flexible strength members and a double layer of durable flame retardant and sunlight resistant jackets, this cable design possesses features ideal for environmentally demanding applications. The heavy duty loose tube design features optical fibers placed inside PFM™ gel-filled buffer tubes. The core is constructed by stranding the buffer tubes around a central member using reverse oscillating lay (ROL). The core is wrapped with flexible strength members and covered by a water-blocking tape, then encased in a black flame resistant jacket. A second layer of flexible strength members is applied and then encased in a black, flame and sunlight resistant jacket. Rip cords are included under each jacket for ease of entry.

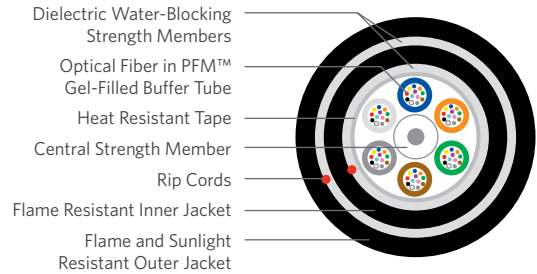
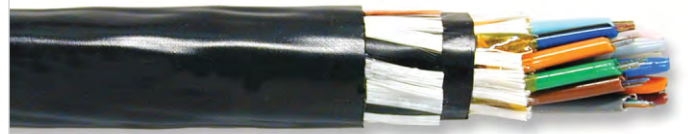

APPLICATIONS

- IEEE networks from 10 Mbps to 10 Gbps
- Long vertical runs
- Cable trays
- Outdoor/indoor pathways

FEATURES

- Multiple fiber types including hybrids
- UL Listed, sunlight resistant
- Transitions from indoor to outdoor
- Heavy duty design
- PFM gel

BENEFITS

- Multiple network applications
- Longer cable life
- Reduces labor costs
- Allows for harsh environment application
- Non-sticky gel speeds fiber access and clean-up

SPECIFICATIONS

Fiber Count	Available in 6-fiber up to 216-fiber
Performance Compliance	Telcordia® GR-20-CORE, Issue 3 UL® 1666 RoHS-compliant
NRTL Programs	UL, c(UL) Listed OFNR

Telcordia is a registered trademark of Ericsson Inc. UL is a registered trademark of UL LLC.

ENVIRONMENTAL SPECIFICATIONS

Operation/Storage	-40°C to +70°C
Installation	-10°C to +70°C

PART NUMBER KEY

1	H	_	_	_	x	x	0	y
1	2	3	4	5	6	7	8	9
Product family	Fiber count (006-216)				Fiber type	Internal designator	Water block/markings (1-8)	

Contact Customer Service for availability of non-standard offerings.

PART NUMBERS AND PHYSICAL CHARACTERISTICS

Listing	Part Number ¹	Fiber Count	Nominal Diameter in (mm)	Nominal Weight lbs/kft (kg/km)	Impact n*m	Maximum Tensile Loading		Minimum Bend Radius		Crush lbs/in (N/cm)	Vertical Rise ft (m)
						Install lbs (N)	Long Term lbs (N)	Install in (mm)	Long Term in (mm)		
OFNR	1H006xx0y	6	0.52 (13.1)	112 (167)	4.41	600 (2,700)	200 (890)	10.4 (262)	5.2 (131)	260 (450)	2,200 (671)
OFNR	1H012xx0y	12	0.52 (13.1)	112 (167)	4.41	600 (2,700)	200 (890)	10.4 (262)	5.2 (131)	260 (450)	2,200 (671)
OFNR	1H024xx0y	24	0.52 (13.1)	112 (167)	4.41	600 (2,700)	200 (890)	10.4 (262)	5.2 (131)	260 (450)	2,200 (671)
OFNR	1H036xx0y	36	0.52 (13.1)	112 (167)	4.41	600 (2,700)	200 (890)	10.4 (262)	5.2 (131)	260 (450)	2,200 (671)
OFNR	1H048xx0y	48	0.52 (13.1)	112 (167)	4.41	600 (2,700)	200 (890)	10.4 (262)	5.2 (131)	260 (450)	2,200 (671)
OFNR	1H072xx0y	72	0.54 (14.3)	125 (186)	5.15	600 (2,700)	200 (890)	10.8 (286)	5.4 (143)	260 (450)	1,840 (560)
OFNR	1H096xx0y	96	0.61 (16.0)	156 (231)	5.88	600 (2,700)	200 (890)	12.1 (320)	6.1 (160)	260 (450)	1,450 (443)
OFNR	1H144xx0y	144	0.74 (19.6)	221 (328)	6.62	600 (2,700)	200 (890)	14.8 (392)	7.4 (196)	260 (450)	1,050 (320)
OFNR	1H216xx0y	216	0.74 (19.6)	221 (328)	6.62	600 (2,700)	200 (890)	14.8 (392)	7.4 (196)	260 (450)	1,050 (320)

FIBER TYPES:

SINGLE MODE

HYBRID

MULTIMODE

	Reduced Water Peak		Zero Water Peak		TeraFlex® Bend Resistant				Hybrid	TeraGain® TeraFlex Bend Resistant Laser Optimized 50/125			
	3T	2T	G.657.A1	G.657.A2	G.657.B3	NZDS	LEAF	62.5/125		10G/150	10G/300	10G/550	
¹ For ≤ 36 fibers replace "xx" with:			KT	JT	LT	8T	ST	H _L	6G	MG	NG	PG	
¹ For > 36 fibers replace "xx" with:	31	21	K1	J1	L1	81	S1						

See "Optical Fiber Specifications" in the "Technical Information" section for detailed fiber type specifications.

WATER BLOCK AND JACKET PRINT CODES

	Dry core		Dry core special	
	Feet	Meters	Feet	Meters
¹ Replace "y" with:	1	2	5	6

Loose Tube 12 AWG Composite

Series 1N

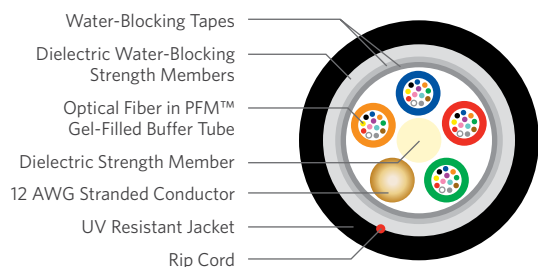

PRODUCT DESCRIPTION

Loose Tube 12 AWG Composite Cable is a stranded, single jacket, non-armored, gel-filled loose tube cable containing a 12 AWG stranded conductor, which provides long distance tone for location. A rip cord is included under the jacket to provide ease of entry.

APPLICATIONS

- Underground duct and lashed aerial
- Broadband network

FEATURES

- Available with up to 48-fiber
- Multiple fiber types
- PFM™ gel
- Dry (SAP) core standard
- Multiple fiber vendors
- 12 AWG stranded conductor

BENEFITS

- High fiber density
- Multiple network applications
- Non-sticky gel speeds fiber access and clean-up
- Reduces cable prep and installation time
- Meets customer preferences
- Meets 10 Ohms/mile standard

SPECIFICATIONS

Fiber Count Available in 12-fiber up to 48-fiber

Standards Compliance Telcordia® GR-20-CORE
RoHS-compliant

Telcordia is a registered trademark of Ericsson Inc.

ENVIRONMENTAL SPECIFICATIONS

Operation/Storage -40°C to +70°C

Installation -30°C to +70°C

PART NUMBER KEY

1	N	_	_	_	x	x	0	y
1	2	3	4	5	6	7	8	9
Product family	Fiber count (012-048)				Fiber type	Internal designator	Water block/markings (1-8)	

Contact Customer Service for availability of non-standard offerings.

PART NUMBERS AND PHYSICAL CHARACTERISTICS

Part Number ¹	Fiber Count	Nominal Diameter in (mm)	Approx. Weight lbs/kft (kg/km)	Maximum Tensile Loading		Minimum Bend Radius	
				Install lbs (N)	Long Term lbs (N)	Install in (mm)	Long Term in (mm)
1N012xx0y	12	0.41 (10.3)	76 (113)	600 (2,700)	200 (890)	8.2 (206)	4.1 (103)
1N024xx0y	24	0.41 (10.3)	76 (113)	600 (2,700)	200 (890)	8.2 (206)	4.1 (103)
1N036xx0y	36	0.41 (10.3)	76 (113)	600 (2,700)	200 (890)	8.2 (206)	4.1 (103)
1N048xx0y	48	0.41 (10.3)	76 (113)	600 (2,700)	200 (890)	8.2 (206)	4.1 (103)

FIBER TYPES:	SINGLE MODE						HYBRID	MULTIMODE				
	Reduced Water Peak	Zero Water Peak	TeraFlex® Bend Resistant			NZDS		LEAF	TeraGain® Laser Optimized 50/125			
			G.657.A1	G.657.A2	G.657.B3			Hybrid	62.5/125	10G/150	10G/300	10G/550
¹ For ≤ 36 fibers replace "xx" with:	3T	2T	KT	JT	LT	8T	ST	H_	6G	MG	NG	PG
¹ For > 36 fibers replace "xx" with:	31	21	K1	J1	L1	81	S1					

See "Optical Fiber Specifications" in the "Technical Information" section for detailed fiber type specifications.

WATER BLOCK AND JACKET PRINT CODES

	Dry core		Dry core special	
	Feet	Meters	Feet	Meters
¹ Replace "y" with:	1	2	5	6

PRODUCT DESCRIPTION

UG FTTP are all dielectric cables designed for Outside Plant (OSP) applications, specifically as a drop cable. The reduced diameter maximizes duct space and offers the lowest installed cost. The loose tube design offers reliable transmission performance over a broad temperature range. The single loose tube design features optical fibers placed inside a single PFM™ gel-filled tube. The core tube is then helically wrapped with water-blocking strength members and encased with a black jacket. A rip cord is included to provide ease of access to the cable core.

APPLICATIONS

- Drop cables
- Broadband network
- Local loop
- Fiber to the premise

FEATURES

- Available with up to 12-fiber
- Multiple fiber types including TeraFlex® bend resistant
- Dielectric outer strength members
- Highly flexible
- Small cable diameter
- Dry (SAP) core design
- PFM gel

BENEFITS

- High fiber density
- Multiple network applications
- Eliminates grounding or bonding problems
- Easy handling
- Installation of more fibers in less space, reduced cost
- Reduces cable prep and installation time
- Non-sticky gel allows for easier and faster clean up

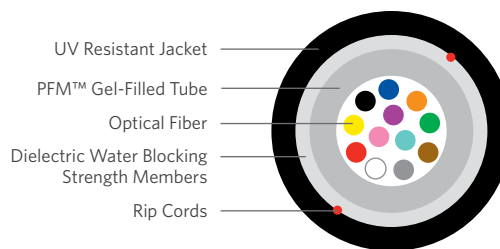

SPECIFICATIONS

Fiber Count	Available in 2-fiber up to 12-fiber
Standards Compliance	Telcordia® GR-20-CORE RDUP PE-90 Designation 513 RoHS-compliant

Telcordia is a registered trademark of Ericsson Inc.

ENVIRONMENTAL SPECIFICATIONS

Operation/Storage	-40°C to +70°C
Installation	-30°C to +70°C

PART NUMBER KEY

5	1	_	_	_	x	x	0	y
1	2	3	4	5	6	7	8	9
Product family	Fiber count (002-012)				Fiber type	Internal designator	Water block/markings (1-8)	

Contact Customer Service for availability of non-standard offerings.

PART NUMBERS AND PHYSICAL CHARACTERISTICS

Part Number ¹	Fiber Count	Nominal Diameter in (mm)	Approx. Weight lbs/kft (kg/km)	Maximum Tensile Loading		Minimum Bend Radius	
				Install lbs (N)	Long Term lbs (N)	Install in (mm)	Long Term in (mm)
51002xx0y	2	0.26 (6.7)	26 (38)	300 (1,335)	100 (445)	5.2 (132)	2.6 (66)
51004xx0y	4	0.26 (6.7)	26 (38)	300 (1,335)	100 (445)	5.2 (132)	2.6 (66)
51006xx0y	6	0.26 (6.7)	26 (38)	300 (1,335)	100 (445)	5.2 (132)	2.6 (66)
51008xx0y	8	0.26 (6.7)	26 (38)	300 (1,335)	100 (445)	5.2 (132)	2.6 (66)
51012xx0y	12	0.26 (6.7)	26 (38)	300 (1,335)	100 (445)	5.2 (132)	2.6 (66)

FIBER TYPES:

SINGLE MODE

Reduced Water Peak	Zero Water Peak	TeraFlex® Bend Resistant				
		G.657.A1	G.657.A2	G.657.B3	NZDS	LEAF

¹Replace "xx" with:

33	23	K3	J3	L3	83	S3
----	----	----	----	----	----	----

MULTIMODE

TeraGain®	TeraFlex Bend Resistant Laser Optimized 50/125		
62.5/125	10G/150	10G/300	10G/550

6G	MG	NG	PG
----	----	----	----

See "Optical Fiber Specifications" in the "Technical Information" section for detailed fiber type specifications.

WATER BLOCK AND JACKET PRINT CODES

Dry core		Dry core special	
Feet	Meters	Feet	Meters

¹Replace "y" with:

1	2	5	6
---	---	---	---

Buried FTTP, Steel Armor

Series 52S

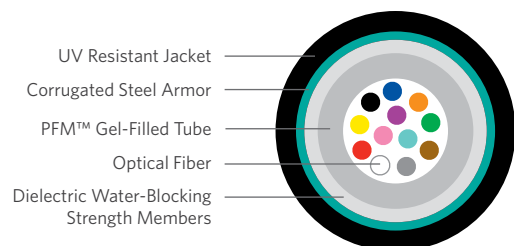

PRODUCT DESCRIPTION

Buried FTTP cables are designed for Outside Plant (OSP) applications, specifically as a drop cable. The reduced diameter maximizes duct space and offers additional armoring protection. The loose tube design offers reliable transmission performance over a broad temperature range. The durable single loose tube design features optical fibers placed inside a single PFM™ gel-filled tube. The core tube contains up to 12 optical fibers. The core tube is then helically wrapped with water-blocking strength members. A corrugated steel armor is applied and encased with a black jacket.

APPLICATIONS

- Drop cables
- Broadband network
- Local loop
- Fiber to the premise

FEATURES

- Corrugated steel armor
- Multiple fiber types including TeraFlex® bend resistant
- Dielectric outer strength members
- Highly flexible
- Small cable diameter
- Color coded fibers
- Dry (SAP) core design
- PFM gel

BENEFITS

- Additional compressive strength and rodent protection
- Multiple network applications
- Eliminates grounding or bonding problems
- Easy handling
- Installation of more fibers in less space, reduced cost
- Easy identification during installation
- Reduces cable prep and installation time
- Non-sticky gel allows for easier and faster clean up

SPECIFICATIONS

Fiber Count Available in 2-fiber up to 12-fiber

Standards Compliance Telcordia® GR-20-CORE
RDUP PE-90 Designation 52S
RoHS-compliant

Telcordia is a registered trademark of Ericsson Inc.

ENVIRONMENTAL SPECIFICATIONS

Operation/Storage -40°C to +70°C

Installation -30°C to +70°C

PART NUMBER KEY

5	2	-	-	-	x	S	0	y
1	2	3	4	5	6	7	8	9
Product family	Fiber count (002-012)	Fiber type	Internal designator	Water block/ marking (1-8)				

Contact Customer Service for availability of non-standard offerings.

PART NUMBERS AND PHYSICAL CHARACTERISTICS

Part Number ¹	Fiber Count	Nominal Diameter in (mm)	Nominal Weight lbs/kft (kg/km)	Maximum Tensile Loading		Minimum Bend Radius	
				Install lbs (N)	Long Term lbs (N)	Install in (mm)	Long Term in (mm)
52002xS0y	2	0.32 (8.2)	51 (77)	300 (1,335)	100 (445)	6.4 (163)	3.2 (8.2)
52004xS0y	4	0.32 (8.2)	51 (77)	300 (1,335)	100 (445)	6.4 (163)	3.2 (8.2)
52006xS0y	6	0.32 (8.2)	51 (77)	300 (1,335)	100 (445)	6.4 (163)	3.2 (8.2)
52008xS0y	8	0.32 (8.2)	51 (77)	300 (1,335)	100 (445)	6.4 (163)	3.2 (8.2)
52012xS0y	12	0.32 (8.2)	51 (77)	300 (1,335)	100 (445)	6.4 (163)	3.2 (8.2)

FIBER TYPES:

SINGLE MODE

Reduced Water Peak	Zero Water Peak	TeraFlex® Bend Resistant			NZDS	LEAF
		G.657.A1	G.657.A2	G.657.B3		
¹ Replace "x" with:	3	2	K	J	L	8 S

MULTIMODE

TeraGain® 62.5/125	TeraFlex Bend Resistant Laser Optimized 50/125		
	10G/150	10G/300	10G/550
	M	N	P

See "Optical Fiber Specifications" in the "Technical Information" section for detailed fiber type specifications.

WATER BLOCK AND JACKET PRINT CODES

	Dry core		Dry core special	
	Feet	Meters	Feet	Meters
¹ Replace "y" with:	1	2	5	6

PRODUCT DESCRIPTION

Buried FTTP cables are designed for Outside Plant (OSP) applications, specifically as a drop cable. The reduced diameter maximizes duct space and offers additional armoring protection. The loose tube design offers reliable transmission performance over a broad temperature range. The durable single loose tube design features optical fibers placed inside a single PFM™ gel-filled tube. The core tube contains up to 12 optical fibers. The core tube is then helically wrapped with water-blocking strength members. A corrugated steel armor is applied and encased with a black jacket. Rip cords are included to speed access to the fibers.

APPLICATIONS

- Drop cables
- Broadband network
- Local loop
- Fiber to the premise

FEATURES

- Corrugated steel armor
- Multiple fiber types including TeraFlex® bend resistant
- Dielectric outer strength members
- Highly flexible
- Small cable diameter
- Rip cords
- Dry (SAP) core design
- PFM gel

BENEFITS

- Additional compressive strength and rodent protection
- Multiple network applications
- Eliminates grounding or bonding problems
- Easy handling
- Installation of more fibers in less space, reduced cost
- Easy access to fibers
- Reduces cable prep and installation time
- Non-sticky gel allows for easier and faster clean up

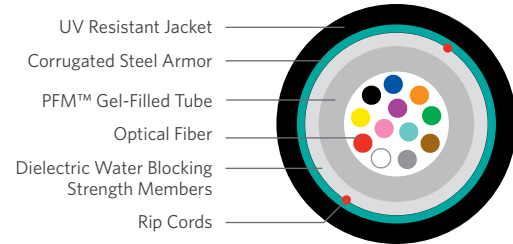
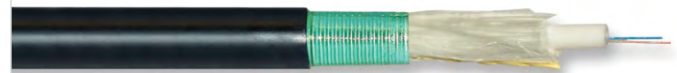

SPECIFICATIONS

Fiber Count	Available in 2-fiber up to 12-fiber
Standards Compliance	Telcordia® GR-20-CORE RDUP PE-90 Designation 52S RoHS-compliant

Telcordia is a registered trademark of Ericsson Inc.

ENVIRONMENTAL SPECIFICATIONS

Operation/Storage	-40°C to +70°C
Installation	-30°C to +70°C

PART NUMBER KEY

5	2	-	-	-	x	U	0	y
1	2	3	4	5	6	7	8	9
Product family	Fiber count (002-012)				Fiber type	Internal designator	Water block/markings (1-8)	

Contact Customer Service for availability of non-standard offerings.

PART NUMBERS AND PHYSICAL CHARACTERISTICS

Part Number ¹	Fiber Count	Nominal Diameter in (mm)	Nominal Weight lbs/kft (kg/km)	Maximum Tensile Loading		Minimum Bend Radius	
				Install lbs (N)	Long Term lbs (N)	Install in (mm)	Long Term in (mm)
52002xU0y	2	0.32 (8.2)	51 (77)	300 (1,335)	100 (445)	6.4 (163)	3.2 (8.2)
52004xU0y	4	0.32 (8.2)	51 (77)	300 (1,335)	100 (445)	6.4 (163)	3.2 (8.2)
52006xU0y	6	0.32 (8.2)	51 (77)	300 (1,335)	100 (445)	6.4 (163)	3.2 (8.2)
52008xU0y	8	0.32 (8.2)	51 (77)	300 (1,335)	100 (445)	6.4 (163)	3.2 (8.2)
52012xU0y	12	0.32 (8.2)	51 (77)	300 (1,335)	100 (445)	6.4 (163)	3.2 (8.2)

FIBER TYPES:

SINGLE MODE

Reduced Water Peak	Zero Water Peak	TeraFlex® Bend Resistant			NZDS	LEAF
		G.657.A1	G.657.A2	G.657.B3		

¹Replace "x" with:

3	2	K	J	L	8	S
---	---	---	---	---	---	---

MULTIMODE

TeraGain®	TeraFlex Bend Resistant Laser Optimized 50/125		
62.5/125	10G/150	10G/300	10G/550

6	M	N	P
---	---	---	---

See "Optical Fiber Specifications" in the "Technical Information" section for detailed fiber type specifications.

WATER BLOCK AND JACKET PRINT CODES

Dry core		Dry core special	
Feet	Meters	Feet	Meters

¹ Replace "y" with:	1	2	5	6
--------------------------------	---	---	---	---

Figure 8 FTTP

Series 573Q

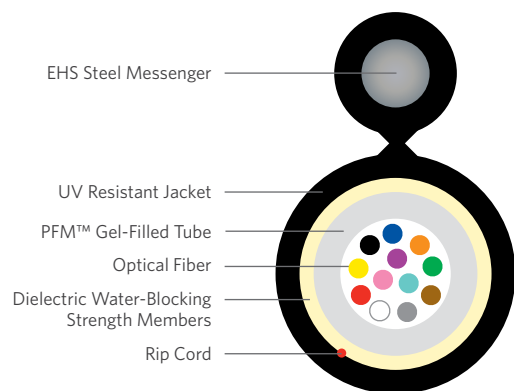

SPECIFICATIONS

Fiber Count	Available in 1-fiber up to 12-fiber inside a PFM gel-filled loose buffer tube
Strength Members	2.1 mm solid steel wire
Jacket	Black, weather resistant PVC jacket
Standards Compliance	Telcordia® GR-20-CORE RDUP PE-90 Designation 573Q RoHS-compliant

Telcordia is a registered trademark of Ericsson Inc.

ENVIRONMENTAL SPECIFICATIONS

Operation/Storage	-40°C to +70°C
Installation	-10°C to +70°C

PART NUMBER KEY

5	7	_	_	_	x	2	3	Q
1	2	3	4	5	6	7	8	9
Product family	Fiber count (001-012)				Fiber type			Internal designator

Contact Customer Service for availability of non-standard offerings.

PART NUMBERS AND PHYSICAL CHARACTERISTICS

Part Number ¹	Fiber Count	Nominal Dimensions		Nominal Weight lbs/kft (kg/km)	Maximum Tensile Loading		Minimum Bend Radius	
		Minor in (mm)	Major in (mm)		Install lbs (N)	Long Term lbs (N)	Install in (mm)	Long Term in (mm)
57001x23Q	1	0.18 (4.5)	0.35 (8.9)	34 (50)	300 (1,334)	90 (400)	3.6 (91)	1.8 (46)
57002x23Q	2	0.18 (4.5)	0.35 (8.9)	34 (50)	300 (1,334)	90 (400)	3.6 (91)	1.8 (46)
57004x23Q	4	0.18 (4.5)	0.35 (8.9)	34 (50)	300 (1,334)	90 (400)	3.6 (91)	1.8 (46)
57006x23Q	6	0.18 (4.5)	0.35 (8.9)	34 (50)	300 (1,334)	90 (400)	3.6 (91)	1.8 (46)
57008x23Q	8	0.18 (4.5)	0.35 (8.9)	34 (50)	300 (1,334)	90 (400)	3.6 (91)	1.8 (46)
57012x23Q	12	0.18 (4.5)	0.35 (8.9)	34 (50)	300 (1,334)	90 (400)	3.6 (91)	1.8 (46)

FIBER TYPES:

SINGLE MODE

Reduced Water Peak	Zero Water Peak	TeraFlex® Bend Resistant			NZDS	LEAF
		G.657.A1	G.657.A2	G.657.B3		
3	2	K	J	L	8	S

MULTIMODE

TeraGain® 62.5/125	TeraFlex Bend Resistant Laser Optimized 50/125		
	10G/150	10G/300	10G/550
6	M	N	P

¹Replace "x" with:

See "Optical Fiber Specifications" in the "Technical Information" section for detailed fiber type specifications.

PRODUCT DESCRIPTION

Figure 8 FTTP offers an aerial solution for fiber to the premise applications. This small profile aerial cable incorporates a 2.1 mm solid steel wire supporting a single enhanced loose tube containing up to 12 optical fibers and PFM™ gel. The small profile reduces cost and problems associated with wind or ice load. This is a water-blocked design, using a "dry" water-absorbing thread to prevent the migration of moisture. A black, weather resistant jacket of PVC completes the cable construction.

APPLICATIONS

- Aerial self support drop cables
- Broadband network
- Local loop
- Fiber to the premise

FEATURES

- Available with 1-fiber up to 12-fiber
- Multiple fiber types including TeraFlex® bend resistant
- PFM gel
- Dry (SAP) core standard
- PVC jacket
- Steel messenger

BENEFITS

- Offers the maximum bandwidth for FTTP business, etc.
- Multiple network applications
- Non-sticky gel reduces installation time and labor cost
- Reduces cable prep and installation time
- Improves flexibility
- Allows use of standard hardware

Buried FTTP, Aluminum Armor

Series 523

PRODUCT DESCRIPTION

Buried FTTP cables are designed for Outside Plant (OSP) applications, specifically as a drop cable. The reduced diameter maximizes duct space and offers additional armoring protection. The loose tube design offers reliable transmission performance over a broad temperature range. The durable single loose tube design features optical fibers placed inside a single PFM™ gel-filled tube. The core tube contains up to 12 optical fibers. The core tube is then helically wrapped with water-blocking strength members. A corrugated aluminum armor is applied and encased with a black jacket. Rip cords are included under the armor for ease of access to the core tube.

APPLICATIONS

- Drop cables
- Broadband network
- Local loop
- Fiber to the premise

FEATURES

- Corrugated aluminum armor
- Multiple fiber types including TeraFlex® bend resistant
- Dielectric outer strength members
- Highly flexible
- Small cable diameter
- Color coded fibers
- Dry (SAP) core design
- PFM gel

BENEFITS

- Additional compressive strength and rodent protection
- Multiple network applications
- Eliminates grounding or bonding problems
- Easy handling
- Installation of more fibers in less space, reduced cost
- Easy identification during installation
- Reduces cable prep and installation time
- Non-sticky gel allows for easier and faster clean up

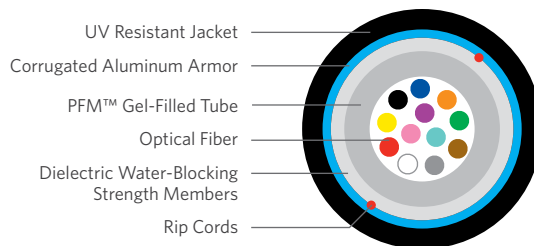
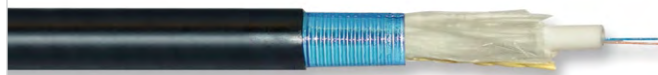

SPECIFICATIONS

Fiber Count	Available in 2-fiber up to 12-fiber
Standards Compliance	Telcordia® GR-20-CORE RDUP PE-90 Designation 523 RoHS-compliant

Telcordia is a registered trademark of Ericsson Inc.

ENVIRONMENTAL SPECIFICATIONS

Operation/Storage	-40°C to +70°C
Installation	-30°C to +70°C

PART NUMBER KEY

5	2	—	—	—	x	x	0	y
1	2	3	4	5	6	7	8	9
Product family	Fiber count (002-012)				Fiber type	Internal designator	Water block/markings (1-8)	

Contact Customer Service for availability of non-standard offerings.

PART NUMBERS AND PHYSICAL CHARACTERISTICS

Part Number ¹	Fiber Count	Nominal Diameter in (mm)	Nominal Weight lbs/kft (kg/km)	Maximum Tensile Loading		Minimum Bend Radius	
				Install lbs (N)	Long Term lbs (N)	Install in (mm)	Long Term in (mm)
52001xx0y	1	0.33 (8.4)	42 (62)	300 (1,335)	100 (445)	6.6 (168)	3.3 (8.4)
52002xx0y	2	0.33 (8.4)	42 (62)	300 (1,335)	100 (445)	6.6 (168)	3.3 (8.4)
52004xx0y	4	0.33 (8.4)	42 (62)	300 (1,335)	100 (445)	6.6 (168)	3.3 (8.4)
52006xx0y	6	0.33 (8.4)	42 (62)	300 (1,335)	100 (445)	6.6 (168)	3.3 (8.4)
52008xx0y	8	0.33 (8.4)	42 (62)	300 (1,335)	100 (445)	6.6 (168)	3.3 (8.4)
52012xx0y	12	0.33 (8.4)	42 (62)	300 (1,335)	100 (445)	6.6 (168)	3.3 (8.4)

FIBER TYPES:

SINGLE MODE

Reduced Water Peak	Zero Water Peak	TeraFlex® Bend Resistant			NZDS	LEAF
		G.657.A1	G.657.A2	G.657.B3		
33	23	K3	J3	L3	83	S3

¹Replace "xx" with:

MULTIMODE

TeraGain®	TeraFlex Bend Resistant Laser Optimized 50/125		
62.5/125	10G/150	10G/300	10G/550
6G	MG	NG	PG

See "Optical Fiber Specifications" in the "Technical Information" section for detailed fiber type specifications.

WATER BLOCK AND JACKET PRINT CODES

	Dry core		Dry core special	
	Feet	Meters	Feet	Meters
¹ Replace "y" with:	1	2	5	6

Buried Drop Composite, Aluminum Armor

Series 72

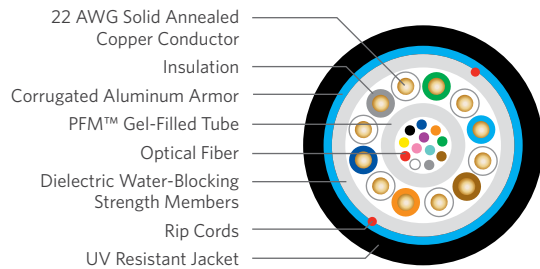

PRODUCT DESCRIPTION

Series 72 is the underground cable solution for the situation that requires both optical fiber and twisted pairs. This product is available in fiber counts up to 12 with 2-pair, 3-pair or 6-pair 22 AWG copper pairs. Series 72 serves the need for communications or power over copper pairs with optical fiber available for the future. The core is constructed with a single tube containing up to 12 optical fibers and up to 6 copper pairs. A corrugated aluminum armor and longitudinal strength elements are applied over the core tube and encased within a black, weather resistant jacket. Rip cords are included under the armor for ease of access to the core.

APPLICATIONS

- Fiber to the premise
- Broadband network
- Buried, underground

FEATURES

- Composite fiber/copper design
- Round shape
- Corrugated aluminum armor
- Dry (SAP) core standard
- PFM™ gel
- Insulation of tip conductors are marked with a stripe of the mating ring's insulation color

BENEFITS

- Multiple Network applications
- Conforms to standard practices and hardware
- Improves flexibility
- Reduces cable prep and installation time
- Non-sticky gel allows for easier and faster clean up
- Reduces the possibility of splitting pairs during installation

SPECIFICATIONS

Fiber Components	Available in 2-fiber up to 12-fiber loose inside a PFM gel-filled buffer tube
Copper Components	Available with 2, 3 or 6-pair 22 AWG solid annealed copper conductors each insulated with solid polyolefin in distinctive colors
Standards Compliance	Telcordia® GR-20-CORE RDUP PE-90 Designation 72 RoHS-compliant

Telcordia is a registered trademark of Ericsson Inc.

PART NUMBER KEY

7	2	-	-	-	x	x	2, 3, or 6	y
1	2	3	4	5	6	7	8	9
Product family	Fiber count (002-012)	Fiber type	Internal designator	Copper pairs	Water block/ marking (1-8)			

Contact Customer Service for availability of non-standard offerings.

ENVIRONMENTAL SPECIFICATIONS

Operation/Storage	-40°C to +70°C
Installation	-30°C to +70°C

ELECTRICAL SPECIFICATIONS

Conductor AWG (mm)	Conductor DC Resistance @ 68°F Maximum Individual Ohms/mile (Ohms/km)	Resistance Unbalance Maximum Individual Pair %	Minimum Dielectric Strength DC Potential Volts Conductor to Conductor
22 (0.64)	91.0 (56.4)	5.0	7,200

PART NUMBERS AND PHYSICAL CHARACTERISTICS

Part Number ¹	Copper Pair Count	Fiber Count	Nominal Diameter in (mm)	Nominal Weight lbs/kft (kg/km)	Maximum Tensile Loading		Minimum Bend Radius		Copper Max. Amperage A	Copper Max. Voltage vDC	Package
					Install lbs (N)	Long Term lbs (N)	Install in (mm)	Long Term in (mm)			
72002xx2y	2	2	0.39 (9.8)	50 (74)	300 (1,335)	100 (445)	7.8 (198)	3.9 (99)	1.0	150	Reel
72004xx2y	2	4	0.39 (9.8)	50 (74)	300 (1,335)	100 (445)	7.8 (198)	3.9 (99)	1.0	150	Reel
72006xx2y	2	6	0.39 (9.8)	50 (74)	300 (1,335)	100 (445)	7.8 (198)	3.9 (99)	1.0	150	Reel
72002xx3y	3	2	0.40 (10.1)	52 (77)	300 (1,335)	100 (445)	8.0 (202)	4.0 (101)	1.0	150	Reel
72004xx3y	3	4	0.40 (10.1)	52 (77)	300 (1,335)	100 (445)	8.0 (202)	4.0 (101)	1.0	150	Reel
72006xx3y	3	6	0.40 (10.1)	52 (77)	300 (1,335)	100 (445)	8.0 (202)	4.0 (101)	1.0	150	Reel
72002xx6y	6	2	0.44 (11.1)	56 (83)	300 (1,335)	100 (445)	8.8 (222)	4.4 (111)	1.0	150	Reel
72004xx6y	6	4	0.44 (11.1)	56 (83)	300 (1,335)	100 (445)	8.8 (222)	4.4 (111)	1.0	150	Reel
72006xx6y	6	6	0.44 (11.1)	56 (83)	300 (1,335)	100 (445)	8.8 (222)	4.4 (111)	1.0	150	Reel
72012xx6y	6	12	0.44 (11.1)	56 (83)	300 (1,335)	100 (445)	8.8 (222)	4.4 (111)	1.0	150	Reel

FIBER TYPES:

SINGLE MODE

Reduced Water Peak	Zero Water Peak	TeraFlex® Bend Resistant					
		G.657.A1	G.657.A2	G.657.B3	NZDS	LEAF	
¹ Replace "xx" with:	33	23	K3	J3	L3	83	S3

MULTIMODE

TeraGain®	TeraFlex Bend Resistant Laser Optimized 50/125			
62.5/125	10G/150	10G/300	10G/550	
	6G	MG	NG	PG

See "Optical Fiber Specifications" in the "Technical Information" section for detailed fiber type specifications.

WATER BLOCK AND JACKET PRINT CODES

Dry core		Dry core special		
Feet	Meters	Feet	Meters	
¹ Replace "y" with:	1	2	5	6

Buried Drop Composite, Steel Armor

Series 72S

PRODUCT DESCRIPTION

Series 72S is the underground cable solution for the situation that requires both optical fiber and twisted pairs. This product is available in fiber counts up to 12 with 2-pair, 3-pair or 6-pair 22 AWG copper pairs. Series 72S serves the need for communications or low voltage power over copper pairs with optical fiber available for the future. The core is constructed with a single tube containing up to 12 optical fibers and up to 6 copper pairs. A corrugated steel armor and longitudinal strength elements are applied over the core tube and encased within a black, weather resistant jacket. Rip cords are included under the armor for ease of access to the core.

APPLICATIONS

- Fiber to the premise
- Broadband network
- Buried, underground

FEATURES

- Composite fiber/copper design
- Round shape
- Corrugated steel armor
- Dry (SAP) core standard
- PFM™ gel
- Insulation of tip conductors are marked with a stripe of the mating ring's insulation color

BENEFITS

- Multiple Network applications
- Conforms to standard practices and hardware
- Improves compressive strength and rodent protection
- Reduces cable prep and installation time
- Non-sticky gel allows for easier and faster clean up
- Reduces the possibility of splitting pairs during installation

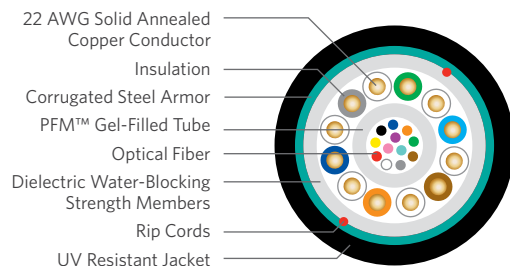

SPECIFICATIONS

Fiber Components	Available in 2-fiber up to 12-fiber loose inside a PFM gel-filled buffer tube
Copper Components	Available with 2, 3 or 6-pair 22 AWG solid annealed copper conductors each insulated with solid polyolefin in distinctive colors
Standards Compliance	Telcordia® GR-20-CORE RDUP PE-90 Designation 72S RoHS-compliant

Telcordia is a registered trademark of Ericsson Inc.

ENVIRONMENTAL SPECIFICATIONS

Operation/Storage	-40°C to +70°C
Installation	-30°C to +70°C

PART NUMBER KEY

7	2	—	—	—	x	x	2, 3, or 6	S
1	2	3	4	5	6	7	8	9
Product family	Fiber count (002-012)				Fiber type	Internal designator	Copper pairs	Steel armor

Contact Customer Service for availability of non-standard offerings.

ELECTRICAL SPECIFICATIONS

Conductor AWG (mm)	Conductor DC Resistance @ 68°F Maximum Individual Ohms/mile (Ohms/km)	Resistance Unbalance Maximum Individual Pair %	Minimum Dielectric Strength DC Potential Volts Conductor to Conductor
22 (0.64)	91.0 (56.4)	5.0	7,200

PART NUMBERS AND PHYSICAL CHARACTERISTICS

Part Number ¹	Copper Pair Count	Fiber Count	Nominal Diameter in (mm)	Nominal Weight lbs/kft (kg/km)	Maximum Tensile Loading		Minimum Bend Radius		Copper Max. Amperage A	Copper Max. Voltage vDC	Package
					Install lbs (N)	Long Term lbs (N)	Install in (mm)	Long Term in (mm)			
72002xx2S	2	2	0.39 (9.8)	67 (100)	300 (1,335)	100 (445)	7.8 (198)	3.9 (99)	1.0	150	Reel
72004xx2S	2	4	0.39 (9.8)	67 (100)	300 (1,335)	100 (445)	7.8 (198)	3.9 (99)	1.0	150	Reel
72006xx2S	2	6	0.39 (9.8)	67 (100)	300 (1,335)	100 (445)	7.8 (198)	3.9 (99)	1.0	150	Reel
72002xx3S	3	2	0.40 (10.1)	71 (106)	300 (1,335)	100 (445)	8.0 (202)	4.0 (101)	1.0	150	Reel
72004xx3S	3	4	0.40 (10.1)	71 (106)	300 (1,335)	100 (445)	8.0 (202)	4.0 (101)	1.0	150	Reel
72006xx3S	3	6	0.40 (10.1)	71 (106)	300 (1,335)	100 (445)	8.0 (202)	4.0 (101)	1.0	150	Reel
72002xx6S	6	2	0.44 (11.1)	75 (111)	300 (1,335)	100 (445)	8.8 (222)	4.4 (111)	1.0	150	Reel
72004xx6S	6	4	0.44 (11.1)	75 (111)	300 (1,335)	100 (445)	8.8 (222)	4.4 (111)	1.0	150	Reel
72006xx6S	6	6	0.44 (11.1)	75 (111)	300 (1,335)	100 (445)	8.8 (222)	4.4 (111)	1.0	150	Reel
72012xx6S	6	12	0.44 (11.1)	75 (111)	300 (1,335)	100 (445)	8.8 (222)	4.4 (111)	1.0	150	Reel

FIBER TYPES:

SINGLE MODE

Reduced Water Peak	Zero Water Peak	TeraFlex® Bend Resistant				
		G.657.A1	G.657.A2	G.657.B3	NZDS	LEAF
33	23	K3	J3	L3	83	S3

MULTIMODE

TeraGain®	TeraFlex Bend Resistant Laser Optimized 50/125		
62.5/125	10G/150	10G/300	10G/550
6G	MG	NG	PG

¹Replace "xx" with:

See "Optical Fiber Specifications" in the "Technical Information" section for detailed fiber type specifications.

Universal Drop FTTP

Series 6U

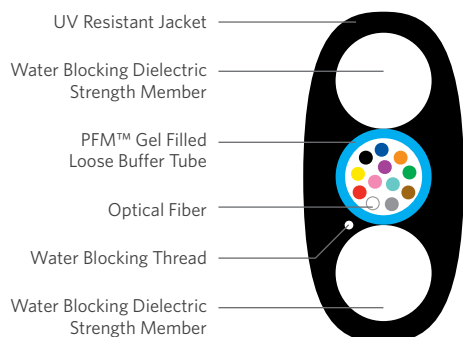

SPECIFICATIONS

Fiber Count	Available with up to 12-fiber inside a PFM gel-filled loose buffer tube
Strength Members	Water-blocking dielectric strength members placed parallel to single loose tube, one on each side, to provide necessary longitudinal strength
Jacket	Black, UV resistant jacket
Maximum Span Length at 1% Sag ft (m)	Light Loading: 330 (101) Medium Loading: 225 (69) Heavy Loading: 150 (46)
Standards Compliance	Telcordia® GR-20-CORE RDUP PE-90 Designation 570Q RoHS-compliant

Telcordia is a registered trademark of Ericsson Inc.

PART NUMBER KEY

6	U	—	—	—	x	1	R, B or 0	G, B or 1
1	2	3	4	5	6	7	8	9
Product family	Fiber count (002-012)	Fiber type	Internal designator	Package type	Internal designator			

Contact Customer Service for availability of non-standard offerings. See "Optical Fiber Cable" options in the "Technical Information" section for flooding and jacket marking options.

PART NUMBERS AND PHYSICAL CHARACTERISTICS

Part Number ¹	Fiber Count	Nominal Dimensions		Nominal Weight lbs/kft (kg/km)	Maximum Tensile Loading		Minor Dimension Bend Radius in (mm)	Package	Approx. Shipping Weight lbs (kg)
		Minor in (mm)	Major in (mm)		Install lbs (N)	Long Term lbs (N)			
6U001x101	1	0.17 (4.3)	0.32 (8.0)	24 (36)	300 (1,335)	90 (405)	3.15 (76)	Master reel	-
6U002x101	2	0.17 (4.3)	0.32 (8.0)	24 (36)	300 (1,335)	90 (405)	3.15 (76)	Master reel	-
6U002x1RG	2	0.17 (4.3)	0.32 (8.0)	24 (36)	300 (1,335)	90 (405)	3.15 (76)	2,500' Reel	132 (60)
6U002x1BB	2	0.17 (4.3)	0.32 (8.0)	24 (36)	300 (1,335)	90 (405)	3.15 (76)	1,000' Reel-in-a-Box	52 (24)
6U004x1RG	4	0.17 (4.3)	0.32 (8.0)	24 (36)	300 (1,335)	90 (405)	3.15 (76)	2,500' Reel	132 (60)
6U004x1BB	4	0.17 (4.3)	0.32 (8.0)	24 (36)	300 (1,335)	90 (405)	3.15 (76)	1,000' Reel-in-a-Box	52 (24)
6U006x1RG	6	0.17 (4.3)	0.32 (8.0)	24 (36)	300 (1,335)	90 (405)	3.15 (76)	2,500' Reel	132 (60)
6U006x1BB	6	0.17 (4.3)	0.32 (8.0)	24 (36)	300 (1,335)	90 (405)	3.15 (76)	1,000' Reel-in-a-Box	52 (24)
6U012x1RG	12	0.17 (4.3)	0.32 (8.0)	24 (36)	300 (1,335)	90 (405)	3.15 (76)	2,500' Reel	132 (60)

FIBER TYPES:

SINGLE MODE

Reduced Water Peak	Zero Water Peak	TeraFlex® Bend Resistant			
		G.657.A1	G.657.A2	G.657.B3	NZDS LEAF

¹Replace "x" with:

3	2	K	J	L	8	S
---	---	---	---	---	---	---

MULTIMODE

TeraGain®	TeraFlex Bend Resistant Laser Optimized 50/125		
62.5/125	10G/150	10G/300	10G/550

6	M	N	P
---	---	---	---

See "Optical Fiber Specifications" in the "Technical Information" section for detailed fiber type specifications.

PRODUCT DESCRIPTION

Universal Drop FTTP offers the most flexible solution for fiber to the premise applications. This all dielectric cable requires no grounding or bonding. The small profile reduces cost and increases both ease of use and access to small conduits. This durable design incorporates two dielectric rigid rods for tensile and crush protection, bracketing a single enhanced loose tube containing up to 12 optical fibers and PFM™ gel. A black, weather resistant jacket completes the cable construction.

APPLICATIONS

- Drop cables
- Broadband network
- Local loop
- Fiber to the premise

FEATURES

- Available with up to 12-fiber
- Universal design
- Dielectric
- PFM gel
- Dielectric Rods
- Multiple fiber types including TeraFlex® bend resistant

BENEFITS

- Offers the maximum bandwidth for FTTP business, etc.
- Aerial or direct bury
- Eliminates bonding and grounding
- Non-sticky gel reduces installation time and labor cost
- Excellent crush resistance
- Multiple network applications

ENVIRONMENTAL SPECIFICATIONS

Operation/Storage	-40°C to +70°C
Installation	-30°C to +70°C

PRODUCT DESCRIPTION

Toneable Drop FTTP offers the most flexible solution for fiber to the premise applications. The toneable unit allows for easy location after installation. The small profile reduces cost and increases both ease of use and access to small conduits. This product is the low cost solution to the network's last 100 meters. The durable design incorporates two dielectric rigid rods for tensile and crush protection, bracketing a single enhanced loose tube containing up to 12 optical fibers and PFM™ gel.

APPLICATIONS

- Drop cables
- Broadband network
- Local loop
- Fiber to the premise

FEATURES

- Available with up to 12-fiber
- Universal design
- Toneable element
- PFM gel
- Dielectric rods
- Dry (SAP) core standard
- Multiple fiber types including TeraFlex® bend resistant

BENEFITS

- Maximum bandwidth
- Aerial or direct bury
- Ease of location
- Non-sticky gel reduces installation time and labor cost
- Excellent crush resistance
- Reduces cable prep and installation time
- Multiple network applications

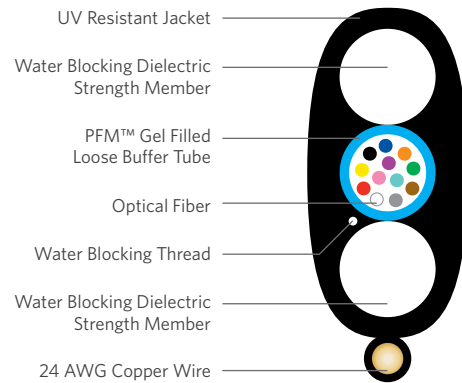

SPECIFICATIONS

Fiber Count	Available with up to 12-fiber inside a PFM gel-filled loose buffer tube
Strength Members	Water-blocking dielectric strength members placed parallel to single loose tube, to provide necessary longitudinal strength
Toneable Element	24 AWG copper wire encased in jacket
Jacket	Black, UV resistant jacket
Maximum Span Length at 1% Sag ft (m)	Light Loading: 330 (101) Medium Loading: 225 (69) Heavy Loading: 150 (46)
Standards Compliance	Telcordia® GR-20-CORE RDUP PE-90 Designation 571Q RoHS-compliant

Telcordia is a registered trademark of Ericsson Inc.

PART NUMBER KEY

6	T	-	-	-	x	1	R, B or 0	G, B or 1
1	2	3	4	5	6	7	8	9
Product family	Fiber count (002-012)	Fiber type	Internal designator	Package type	Internal designator			

Contact Customer Service for availability of non-standard offerings. See "Optical Fiber Cable" options in the "Technical Information" section for flooding and jacket marking options.

ENVIRONMENTAL SPECIFICATIONS

Operation/Storage	-40°C to +70°C
Installation	-30°C to +70°C

PART NUMBERS AND PHYSICAL CHARACTERISTICS

Part Number ¹	Fiber Count	Nominal Dimensions		Nominal Weight lbs/kft (kg/km)	Maximum Tensile Loading		Minor Dimension Bend Radius in (mm)	Package	Approx. Shipping Weight lbs (kg)
		Minor in (mm)	Major in (mm)		Install lbs (N)	Long Term lbs (N)			
6T001x101	1	0.17 (4.3)	0.35 (9.0)	27 (40)	300 (1,335)	90 (405)	3.15 (76)	Master reel	-
6T002x101	2	0.17 (4.3)	0.35 (9.0)	27 (40)	300 (1,335)	90 (405)	3.15 (76)	Master reel	-
6T002x1RG	2	0.17 (4.3)	0.35 (9.0)	27 (40)	300 (1,335)	90 (405)	3.15 (76)	2,500' Reel	121 (55)
6T002x1BB	2	0.17 (4.3)	0.35 (9.0)	27 (40)	300 (1,335)	90 (405)	3.15 (76)	1,000' Reel-in-a-Box	47 (17)
6T004x1RG	4	0.17 (4.3)	0.35 (9.0)	27 (40)	300 (1,335)	90 (405)	3.15 (76)	2,500' Reel	121 (55)
6T004x1BB	4	0.17 (4.3)	0.35 (9.0)	27 (40)	300 (1,335)	90 (405)	3.15 (76)	1,000' Reel-in-a-Box	47 (17)
6T006x1RG	6	0.17 (4.3)	0.35 (9.0)	27 (40)	300 (1,335)	90 (405)	3.15 (76)	2,500' Reel	121 (55)
6T006x1BB	6	0.17 (4.3)	0.35 (9.0)	27 (40)	300 (1,335)	90 (405)	3.15 (76)	1,000' Reel-in-a-Box	47 (17)
6T012x1RG	12	0.17 (4.3)	0.35 (9.0)	27 (40)	300 (1,335)	90 (405)	3.15 (76)	2,500' Reel	121 (55)
6T012x1BB	12	0.17 (4.3)	0.35 (9.0)	27 (40)	300 (1,335)	90 (405)	3.15 (76)	1,000' Reel-in-a-Box	47 (17)

FIBER TYPES:

SINGLE MODE

MULTIMODE

	Reduced Water Peak		Zero Water Peak		TeraFlex® Bend Resistant				TeraGain®				
					G.657.A1	G.657.A2	G.657.B3	NZDS	LEAF	62.5/125	10G/150	10G/300	10G/550
¹ Replace "x" with:	3	2	K	J	L			8	S	6	M	N	P

See "Optical Fiber Specifications" in the "Technical Information" section for detailed fiber type specifications.

Universal Flex FTTP

Series 6S

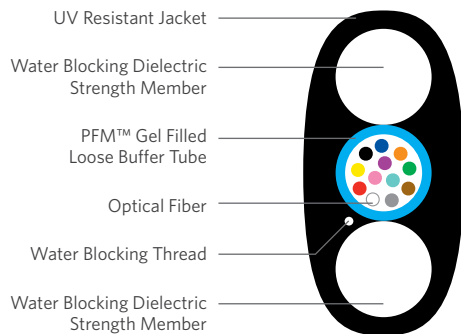

SPECIFICATIONS

Fiber Count	Available with up to 12-fiber inside a PFM gel-filled loose buffer tube
Strength Members	Water-blocking dielectric strength members placed parallel to single loose tube, one on each side, to provide necessary longitudinal strength
Jacket	Black, UV resistant PVC jacket
Maximum Span Length at 1% Sag ft (m)	Light Loading: 330 (101) Medium Loading: 225 (69) Heavy Loading: 150 (46)
Performance Compliance	Telcordia® GR-20-CORE, Issue 3 RDUP PE-90 RoHS-compliant

Telcordia is a registered trademark of Ericsson Inc.

PART NUMBER KEY

6	S	-	-	-	x	1	R, B or 0	G, B or 1
1	2	3	4	5	6	7	8	9
Product family	Fiber count (002-012)	Fiber type	Internal designator	Package type	Internal designator			

Contact Customer Service for availability of non-standard offerings. See "Optical Fiber Cable" options in the "Technical Information" section for flooding and jacket marking options.

PRODUCT DESCRIPTION

Universal Flex FTTP offers the most complete solution for the fiber to the premise application. This compact cable is RoHS-compliant (no heavy metals) and universal in application. The cable is designed for use in duct, aerial and direct bury environments. The single tube contains PFM™ gel which provides ease of clean up. This product is available with TeraFlex® optical fiber which complies with ITU G.652D and provides increased bend performance.

Universal Flex FTTP is offered as a bulk reel with a standard length of 2,500 ft or in a 1,000 ft Reel-in-a-Box (weather resistant package weighing only 39 lbs). QuickCount® print is standard on the Reel-in-a-Box and reduces scrap by identifying the length of cable remaining in the box.

APPLICATIONS

- Drop cables
- Broadband network
- Local loop
- Fiber to the premise

FEATURES

- Available with up to 12-fiber
- Multiple fiber types including TeraFlex bend resistant
- Universal design
- PFM gel
- Sunlight resistant
- Reel-in-a-Box package option

BENEFITS

- Offers the maximum bandwidth for FTTP business, etc.
- Multiple network applications
- Aerial, direct bury and conduit
- Non-sticky gel reduces installation time and labor cost
- Longer cable life
- QuickCount countdown footage marking feature reduces scrap
- Easy to carry and store

ENVIRONMENTAL SPECIFICATIONS

Operation/Storage	-40°C to +70°C
Installation	-10°C to +70°C

PART NUMBERS AND PHYSICAL CHARACTERISTICS

Part Number ¹	Fiber Count	Nominal Dimensions		Nominal Weight lbs/kft (kg/km)	Maximum Tensile Loading		Minor Dimension Bend Radius in (mm)	Package	Approx. Shipping Weight lbs (kg)
		Minor in (mm)	Major in (mm)		Install lbs (N)	Long Term lbs (N)			
6S001x101	1	0.17 (4.3)	0.32 (8.0)	31 (46)	300 (1,335)	90 (405)	3.19 (81)	Master reel	-
6S002x101	2	0.17 (4.3)	0.32 (8.0)	31 (46)	300 (1,335)	90 (405)	3.19 (81)	Master reel	-
6S002x1RG	2	0.17 (4.3)	0.32 (8.0)	31 (46)	300 (1,335)	90 (405)	3.19 (81)	2,500' Reel	109 (49)
6S002x1BB	2	0.17 (4.3)	0.32 (8.0)	31 (46)	300 (1,335)	90 (405)	3.19 (81)	1,000' Reel-in-a-Box	42 (19)
6S004x1RG	4	0.17 (4.3)	0.32 (8.0)	31 (46)	300 (1,335)	90 (405)	3.19 (81)	2,500' Reel	109 (49)
6S004x1BB	4	0.17 (4.3)	0.32 (8.0)	31 (46)	300 (1,335)	90 (405)	3.19 (81)	1,000' Reel-in-a-Box	42 (19)
6S012x1RG	12	0.17 (4.3)	0.32 (8.0)	31 (46)	300 (1,335)	90 (405)	3.19 (81)	2,500' Reel	109 (49)
6S012x1BB	12	0.17 (4.3)	0.32 (8.0)	31 (46)	300 (1,335)	90 (405)	3.19 (81)	1,000' Reel-in-a-Box	42 (19)

FIBER TYPES:

SINGLE MODE

Reduced Water Peak	Zero Water Peak	TeraFlex® Bend Resistant			NZDS	LEAF
		G.657.A1	G.657.A2	G.657.B3		
3	2	K	J	L	8	S

¹Replace "x" with:

MULTIMODE		TeraFlex Bend Resistant Laser Optimized 50/125			
TeraGain® 62.5/125	10G/150	10G/300	10G/550		
6	M	N	P		

See "Optical Fiber Specifications" in the "Technical Information" section for detailed fiber type specifications.

PRODUCT DESCRIPTION

Toneable Flex FTTP offers the most complete solution for the fiber to the premise application. This compact cable is RoHS-compliant (no heavy metals) and universal in application. The cable is designed for use in duct, aerial and direct bury environments. Cable location is made simple with the toneable copper wire. The single tube contains PFM™ gel, which provides ease of clean up. This product is standard with TeraFlex® optical fiber which complies with ITU G.652D and provides increased bend performance.

Toneable Flex FTTP is offered as a bulk reel with a standard length of 2,500 ft or in a 1,000 ft Reel-in-a-Box (weather resistant package weighing only 39 lbs). QuickCount® print is standard on the Reel-in-a-Box and reduces scrap by identifying the length of cable remaining in the box.

APPLICATIONS

- Drop cables
- Broadband network
- Local loop
- Fiber to the premise

FEATURES

- Available with up to 12-fiber
- Multiple fiber types including TeraFlex bend resistant
- Universal design
- PFM gel
- Reel-in-a-Box package option
- Toneable element

BENEFITS

- Offers the maximum bandwidth for FTTP business, etc.
- Multiple network applications
- Aerial, direct bury and conduit
- Non-sticky gel reduces installation time and labor cost
- QuickCount countdown footage marking feature reduces scrap
- Easy to carry and store
- Ease of location

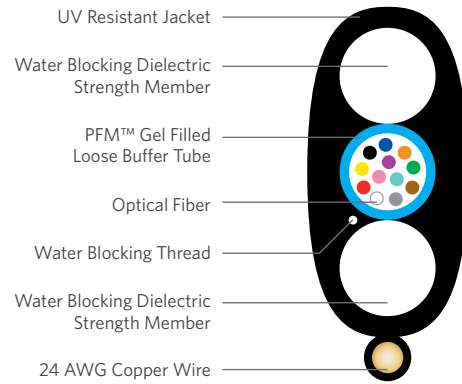

SPECIFICATIONS

Fiber Count	Available with up to 12-fiber inside a PFM gel-filled loose buffer tube
Strength Members	Water-blocking dielectric strength members placed parallel to single loose tube, one on each side, to provide necessary longitudinal strength
Toneable Element	24 AWG copper wire encased in a jacket
Jacket	Black, UV resistant PVC jacket
Maximum Span Length at 1% Sag ft (m)	Light Loading: 330 (101) Medium Loading: 225 (69) Heavy Loading: 150 (46)
Performance Compliance	Telcordia® GR-20-CORE, Issue 3 RDUP PE-90 UL® 1666 RoHS-compliant

Telcordia is a registered trademark of Ericsson Inc. UL is a registered trademark of UL LLC.

PART NUMBER KEY

6	R	—	—	—	x	1	R, B or 0	G, B or 1
1	2	3	4	5	6	7	8	9
Product family	Fiber count (002-012)	Fiber type	Internal designator	Package type	Internal designator			

Contact Customer Service for availability of non-standard offerings. See "Optical Fiber Cable" options in the "Technical Information" section for flooding and jacket marking options.

ENVIRONMENTAL SPECIFICATIONS

Operation/Storage	-40°C to +70°C
Installation	-10°C to +70°C

PART NUMBERS AND PHYSICAL CHARACTERISTICS

Part Number ¹	Fiber Count	Nominal Dimensions		Nominal Weight lbs/kft (kg/km)	Maximum Tensile Loading		Minor Dimension Bend Radius in (mm)	Package	Approx. Shipping Weight lbs (kg)
		Minor in (mm)	Major in (mm)		Install lbs (N)	Long Term lbs (N)			
6R001x101	1	0.17 (4.3)	0.35 (9.0)	34 (51)	300 (1,335)	90 (405)	3.19 (81)	Master reel	-
6R002x101	2	0.17 (4.3)	0.35 (9.0)	34 (51)	300 (1,335)	90 (405)	3.19 (81)	Master reel	-
6R002x1RG	2	0.17 (4.3)	0.35 (9.0)	34 (51)	300 (1,335)	90 (405)	3.19 (81)	2,500' Reel	102 (46)
6R002x1BB	2	0.17 (4.3)	0.35 (9.0)	34 (51)	300 (1,335)	90 (405)	3.19 (81)	1,000' Reel-in-a-Box	39 (18)
6R004x1RG	4	0.17 (4.3)	0.35 (9.0)	34 (51)	300 (1,335)	90 (405)	3.19 (81)	2,500' Reel	102 (46)
6R004x1BB	4	0.17 (4.3)	0.35 (9.0)	34 (51)	300 (1,335)	90 (405)	3.19 (81)	1,000' Reel-in-a-Box	39 (18)
6R012x1RG	12	0.17 (4.3)	0.35 (9.0)	34 (51)	300 (1,335)	90 (405)	3.19 (81)	2,500' Reel	102 (46)
6R012x1BB	12	0.17 (4.3)	0.35 (9.0)	34 (51)	300 (1,335)	90 (405)	3.19 (81)	1,000' Reel-in-a-Box	39 (18)

FIBER TYPES:

SINGLE MODE

	Reduced Water Peak		Zero Water Peak	TeraFlex® Bend Resistant			
	3	2	K	J	L	8	S
¹ Replace "x" with:	3	2	K	J	L	8	S

MULTIMODE

TeraGain®	TeraFlex Bend Resistant Laser Optimized 50/125		
62.5/125	10G/150	10G/300	10G/550
6	M	N	P

See "Optical Fiber Specifications" in the "Technical Information" section for detailed fiber type specifications.

Universal FTTP Tight Buffered Indoor/Outdoor Drop

Series W7U

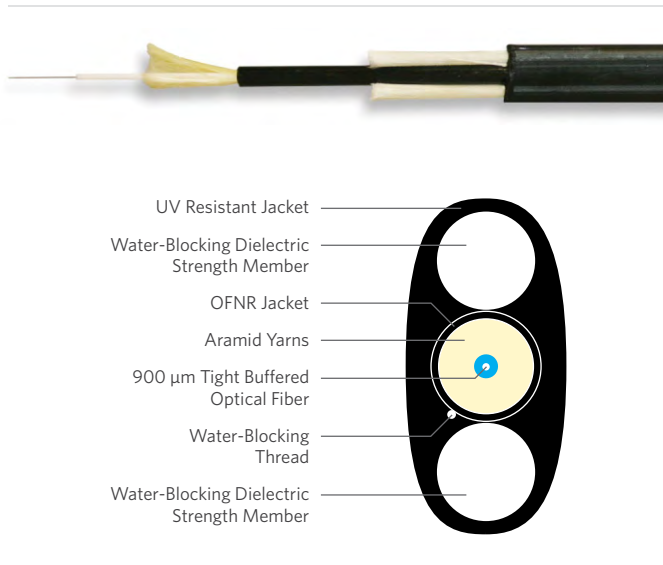

UV Resistant Jacket
Water-Blocking Dielectric Strength Member
OFNR Jacket
Aramid Yarns
900 μm Tight Buffered Optical Fiber
Water-Blocking Thread
Water-Blocking Dielectric Strength Member

PRODUCT DESCRIPTION

Series W7U FTTP is the first indoor/outdoor drop cable that is durable enough for outdoor environments and flexible enough for tight bends within residences. The patented design utilizes a fully functional 2.9 mm OFNR rated tight buffer cable as the core of a GR-20 OSP rated FTTP small flat cable. The key benefit of this cable is that it can be installed from the pedestal to the indoor ONT (Optical Network Terminal) with no intermediate termination. Significant installation savings can be realized by avoiding splicing or termination on the outside or inside wall of the residence. Further savings are realized by using an indoor ONT that does not require an electrician to install. This completely dry, flat drop cable is available in universal and toneable designs that are suitable for aerial, direct bury or conduit installation. A water-blocking thread is used to prevent water penetration.

APPLICATIONS

- Drop cables for aerial, direct bury or conduit installations
- Fiber to the premise for single family residences

FEATURES

- Universal design
- Dielectric rods
- Indoor/outdoor design
- Meets GR-20 specifications
- Cable in a cable
- TeraFlex® fiber in a flexible tight buffer cable design

BENEFITS

- Aerial, direct bury or conduit, all dielectric
- Excellent crush resistance
- Tight Buffered cable can be placed in a riser environment and is UL listed
- Industry accepted standard for OSP installations
- Eliminates splice at premises wall
- Inner cable can be wrapped around corners and stapled with no attenuation issues

SPECIFICATIONS

Maximum Span Length at 1% Sag ft (m)	Light Loading: 350 (101) Medium Loading: 275 (84) Heavy Loading: 150 (46)
Standards Compliance	Telcordia® GR-20-CORE RoHS-compliant

Telcordia is a registered trademark of Ericsson Inc.

MACRO BENDING PERFORMANCE

10 Turns on 15 mm Radius Mandrel	ITU G 657 A	TeraFlex SMF
Macro bending loss @ 1550 nm	0.25 dB Max.	≤ 0.20 dB
Macro bending loss @ 1625 nm	1.00 dB Max.	≤ 0.50 dB
1 Turn on 10 mm Radius Mandrel	ITU G 657 A	TeraFlex SMF
Macro bending loss @ 1550 nm	0.75 dB Max.	≤ 0.20 dB
Macro bending loss @ 1625 nm	1.50 dB Max.	≤ 0.20 dB

TeraFlex is an ITU G 657 A optical fiber that is completely compatible with ITU G 652 D optical fibers. TeraFlex exceeds the performance standards of ITU G 657 A as listed above.

PART NUMBER KEY

W	7	0	0	1 or 2	x	U	0	y
1	2	3	4	5	6	7	8	9
Product family	Fiber count (001 or 002)			Fiber type	Universal	Internal designator	Water block/ marking (1-8)	

Contact Customer Service for availability of non-standard offerings.

PART NUMBERS AND PHYSICAL CHARACTERISTICS

Part Number ¹	Fiber Count	Nominal Dimensions			Nominal Weight lbs/kft (kg/km)	Cable Tensile Load		Cable Bend Radius		Fiber Component Bend Radius	
		Minor in (mm)	Major in (mm)	Fiber Component in (mm)		Install lbs (N)	Long Term lbs (N)	Install in (mm)	Long Term in (mm)	Install in (mm)	Long Term in (mm)
W7001xU0y	1	0.17 (4.5)	0.32 (8.2)	0.11 (2.9)	29 (44)	300 (1,350)	90 (405)	3.6 (91)	1.8 (46)	2.2 (56)	1.1 (28)
W7002xU0y	2	0.17 (4.5)	0.32 (8.2)	0.11 (2.9)	29 (44)	300 (1,350)	90 (405)	3.6 (91)	1.8 (46)	2.2 (56)	1.1 (28)

WATER BLOCK AND JACKET PRINT CODES

Dry core	Dry core special
Feet	Meters

¹Replace "y" with: 1 2 5 6

FIBER TYPES:

SINGLE MODE

TeraFlex® Bend Resistant

G.657.A1 G.657.A2 G.657.B3

¹Replace "x" with: K J L

See "Optical Fiber Specifications" in the "Technical Information" section for detailed fiber type specifications.

Toneable FTTP Tight Buffered Indoor/Outdoor Drop

Series W7T

PRODUCT DESCRIPTION

Series W7T FTTP is the first indoor/outdoor drop cable that is durable enough for outdoor environments and flexible enough for tight bends within residences. The patented design utilizes a fully functional 2.9 mm OFNR rated tight buffer cable as the core of a GR-20 OSP rated FTTP small flat cable. The key benefit of this cable is that it can be installed from the pedestal to the indoor ONT (Optical Network Terminal) with no intermediate termination. Significant installation savings can be realized by avoiding splicing or termination on the outside or inside wall of the residence. Further savings are realized by using an indoor ONT that does not require an electrician to install. This completely dry, flat drop cable is available in universal and toneable designs that are suitable for aerial, direct bury or conduit installation. A water-blocking thread is used to prevent water penetration.

APPLICATIONS

- Drop cables for aerial, direct bury or conduit installations
- Fiber to the premise for single family residences

FEATURES

- Toneable design
- Dielectric rods
- Indoor/outdoor design
- Meets GR-20 specifications
- Cable in a cable
- TeraFlex® fiber in a flexible tight buffer cable design

BENEFITS

- Copper element allows for toneable location
- Excellent crush resistance
- Tight Buffered cable can be placed in a riser environment and is UL listed
- Industry accepted standard for OSP installations
- Eliminates splice at premises wall
- Inner cable can be wrapped around corners and stapled with no attenuation issues

ENVIRONMENTAL SPECIFICATIONS

Operation/Storage	-40°C to +70°C
Installation	-10°C to +70°C

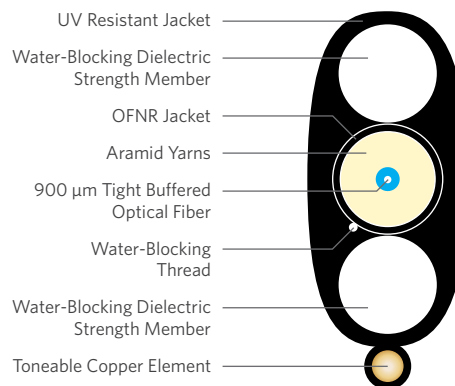

SPECIFICATIONS

Maximum Span Length at 1% Sag ft (m)	Light Loading: 350 (101)
	Medium Loading: 275 (84)
	Heavy Loading: 150 (46)
Standards Compliance	Telcordia® GR-20-CORE RoHS-compliant

Telcordia is a registered trademark of Ericsson Inc.

MACRO BENDING PERFORMANCE

10 Turns on 15 mm Radius Mandrel	ITU G 657 A	TeraFlex SMF
Macro bending loss @ 1550 nm	0.25 dB Max.	≤ 0.20 dB
Macro bending loss @ 1625 nm	1.00 dB Max.	≤ 0.50 dB
1 Turn on 10 mm Radius Mandrel	ITU G 657 A	TeraFlex SMF
Macro bending loss @ 1550 nm	0.75 dB Max.	≤ 0.20 dB
Macro bending loss @ 1625 nm	1.50 dB Max.	≤ 0.20 dB

TeraFlex is an ITU G 657 A optical fiber that is completely compatible with ITU G 652 D optical fibers. TeraFlex exceeds the performance standards of ITU G 657 A as listed above.

PART NUMBER KEY

W	7	0	0	1 or 2	x	1	0	y
1	2	3	4	5	6	7	8	9
Product family	Fiber count (001 or 002)		Fiber type	Toneable	Internal designator	Water block/ marking (1-8)		

Contact Customer Service for availability of non-standard offerings.

PART NUMBERS AND PHYSICAL CHARACTERISTICS

Part Number ¹	Fiber Count	Nominal Dimensions			Nominal Weight lbs/kft (kg/km)	Cable Tensile Load		Cable Bend Radius		Fiber Component Bend Radius	
		Minor in (mm)	Major in (mm)	Fiber Component in (mm)		Install lbs (N)	Long Term lbs (N)	Install in (mm)	Long Term in (mm)	Install in (mm)	Long Term in (mm)
W7001x10y	1	0.17 (4.5)	0.40 (10.2)	0.11 (2.9)	31 (47)	300 (1,350)	90 (405)	3.6 (91)	1.8 (46)	2.2 (56)	1.1 (28)
W7002x10y	2	0.17 (4.5)	0.40 (10.2)	0.11 (2.9)	31 (47)	300 (1,350)	90 (405)	3.6 (91)	1.8 (46)	2.2 (56)	1.1 (28)

WATER BLOCK AND JACKET PRINT CODES

	Dry core		Dry core special	
	Feet	Meters	Feet	Meters
¹ Replace "y" with:	1	2	5	6

FIBER TYPES:

SINGLE MODE

TeraFlex® Bend Resistant

G.657.A1	G.657.A2	G.657.B3
----------	----------	----------

¹Replace "x" with:

K	J	L
---	---	---

See "Optical Fiber Specifications" in the "Technical Information" section for detailed fiber type specifications.

Dri-Lite® Ribbon

Series R1D

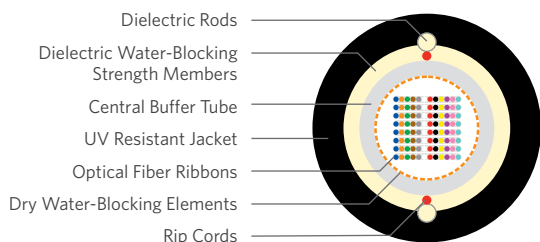

PRODUCT DESCRIPTION

Dri-Lite® Ribbon Cable is a totally gel-free cable. The cable is designed for Outside Plant (OSP) application, specifically lashed aerial and underground duct applications. Our industry leading optical ribbons are manufactured with high dimensional precision and low planarity, which equates to low losses during mass fusion splicing. The Dri-Lite Ribbon cable features optical ribbons inside a gel-free tube which contains dry water-blocking elements. The core tube contains up to eighteen 12-fiber or 24-fiber ribbons. Each ribbon unit is discretely identified and captured in an easy peel matrix for ease of ribbon breakout and management. The core tube is wrapped with a water-blocking tape. Longitudinal strength elements are applied over the core tube and encased within a black jacket. A rip cord is included under the jacket for easy access to the core tube.

APPLICATIONS

- Lashed aerial
- Underground duct
- Broadband network

FEATURES

- Gel-free water-blocking technology
- Available with up to 432-fiber
- Multiple fiber types available
- Highly flexible tube
- Meets or exceeds Telcordia® and RDUP specifications
- Small outer diameter
- Industry leading planarity

BENEFITS

- Reduces preparation time and labor cost
- High fiber density
- Multiple network applications
- Easier handling and reduced loss
- Industry approved
- Up to 432 optical fibers in less than a 1 inch nominal diameter
- Excellent mass splicing results

SPECIFICATIONS

Fiber Count	Available in 12-fiber up to 432-fiber
Standards Compliance	Telcordia® GR-20-CORE RDUP PE-90 Designation R1D

Telcordia is a registered trademark of Ericsson Inc.

ENVIRONMENTAL SPECIFICATIONS

Operation/Storage	-40°C to +70°C
Installation	-30°C to +70°C

PART NUMBER KEY

R	1	—	—	—	x	D	0	y
1	2	3	4	5	6	7	8	9
Product family	Fiber count (012-432)				Fiber type	Internal designator	Water block/ marking (1-8)	

Contact Customer Service for availability of non-standard offerings.

PART NUMBERS AND PHYSICAL CHARACTERISTICS

Part Number ¹	Fiber Count	Nominal Diameter in (mm)	Approx. Weight lbs/kft (kg/km)	Maximum Tensile Loading		Minimum Bend Radius	
				Install lbs (N)	Long Term lbs (N)	Install in (mm)	Long Term in (mm)
R1012xD0y	12	0.48 (12.2)	70 (104)	600 (2,700)	200 (890)	9.6 (244)	4.8 (122)
R1024xD0y	24	0.48 (12.2)	70 (104)	600 (2,700)	200 (890)	9.6 (244)	4.8 (122)
R1048xD0y	48	0.48 (12.2)	70 (104)	600 (2,700)	200 (890)	9.6 (244)	4.8 (122)
R1072xD0y	72	0.56 (14.2)	90 (134)	600 (2,700)	200 (890)	11.2 (284)	5.6 (142)
R1096xD0y	96	0.66 (16.8)	116 (172)	600 (2,700)	200 (890)	13.2 (336)	6.6 (168)
R1144xD0y	144	0.66 (16.8)	119 (177)	600 (2,700)	200 (890)	13.2 (336)	6.6 (168)
R1216xD0y	216	0.74 (18.8)	135 (201)	600 (2,700)	200 (890)	14.8 (376)	7.4 (188)
R1288xD0y	288	0.78 (19.8)	173 (258)	600 (2,700)	200 (890)	15.6 (396)	7.8 (198)
R1360xD0y	360	0.78 (19.8)	173 (258)	600 (2,700)	200 (890)	15.6 (396)	7.8 (198)
R1432xD0y	432	0.78 (19.8)	173 (258)	600 (2,700)	200 (890)	15.6 (396)	7.8 (198)

FIBER TYPES:

SINGLE MODE

HYBRID

Reduced Water Peak	Zero Water Peak	TeraFlex® Bend Resistant G.657.A1	NZDS	LEAF	Hybrid
--------------------	-----------------	-----------------------------------	------	------	--------

¹Replace "x" with: 3 2 K 8 S H

See "Optical Fiber Specifications" in the "Technical Information" section for detailed fiber type specifications.

WATER BLOCK AND JACKET PRINT CODES

Dry core		Dry core special	
Feet	Meters	Feet	Meters

¹Replace "y" with: 1 2 5 6

Dri-Lite® Ribbon Single Armor

Series R2D

PRODUCT DESCRIPTION

Dri-Lite® Ribbon Single Armor Cable is a totally gel-free cable designed for Outside Plant (OSP) application, specifically direct buried, lashed aerial and underground duct applications. Our industry leading optical ribbons are manufactured with high dimensional precision and low planarity, which equates to low losses during mass fusion splicing. The cable features optical ribbons inside a gel-free tube which contains dry water-blocking elements. The core tube contains up to eighteen 12-fiber or 24-fiber ribbons. Each ribbon unit is discretely identified and captured in an easy peel matrix for ease of ribbon breakout and management. The core tube is wrapped with a water-blocking tape. A corrugated steel armor and longitudinal strength elements are applied over the core tube and encased within a black jacket. Rip cords are included under the armor for easy access to the core tube.

APPLICATIONS

- Direct bury
- Lashed aerial
- Underground duct
- Broadband network

FEATURES

- Gel-free water-blocking technology
- Available with up to 432-fiber
- Multiple fiber types available
- Highly flexible tube
- Meets or exceeds Telcordia® and RDUP specifications
- Small outer diameter
- Industry leading planarity

BENEFITS

- Reduces preparation time and labor cost
- High fiber density
- Multiple network applications
- Easier handling and reduced loss
- Industry approved
- Up to 432 optical fibers in less than a 1 inch nominal diameter
- Excellent mass splicing results

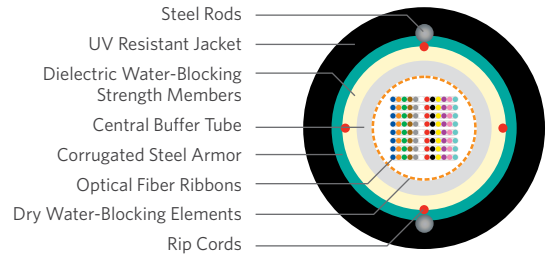
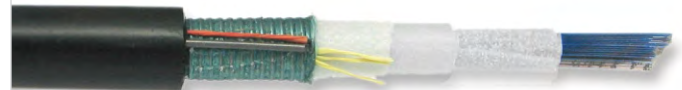

SPECIFICATIONS

Fiber Count Available in 12-fiber up to 432-fiber

Standards Compliance Telcordia® GR-20-CORE
RDUP PE-90 Designation R2D

Telcordia is a registered trademark of Ericsson Inc.

ENVIRONMENTAL SPECIFICATIONS

Operation/Storage -40°C to +70°C

Installation -30°C to +70°C

PART NUMBER KEY

R	2	_	_	_	x	D	S	y
1	2	3	4	5	6	7	8	9
Product family	Fiber count (012-432)				Fiber type	Internal designator	Water block/ marking (1-8)	

Contact Customer Service for availability of non-standard offerings.

PART NUMBERS AND PHYSICAL CHARACTERISTICS

Part Number ¹	Fiber Count	Nominal Diameter in (mm)	Approx. Weight lbs/kft (kg/km)	Maximum Tensile Loading		Minimum Bend Radius	
				Install lbs (N)	Long Term lbs (N)	Install in (mm)	Long Term in (mm)
R2012xDSy	12	0.51 (13.0)	110 (164)	600 (2,700)	200 (890)	10.2 (260)	5.1 (130)
R2024xDSy	24	0.51 (13.0)	110 (164)	600 (2,700)	200 (890)	10.2 (260)	5.1 (130)
R2048xDSy	48	0.59 (15.0)	132 (197)	600 (2,700)	200 (890)	11.8 (300)	5.9 (150)
R2072xDSy	72	0.59 (15.0)	134 (199)	600 (2,700)	200 (890)	11.8 (300)	5.9 (150)
R2096xDSy	96	0.69 (17.4)	165 (251)	600 (2,700)	200 (890)	13.8 (348)	6.9 (174)
R2144xDSy	144	0.69 (17.4)	168 (251)	600 (2,700)	200 (890)	13.8 (348)	6.9 (174)
R2192xDSy	192	0.77 (19.6)	197 (292)	600 (2,700)	200 (890)	15.4 (392)	7.7 (196)
R2216xDSy	216	0.77 (19.6)	198 (295)	600 (2,700)	200 (890)	15.4 (392)	7.7 (196)
R2288xDSy	288	0.84 (21.3)	226 (337)	600 (2,700)	200 (890)	16.8 (437)	8.4 (219)
R2360xDSy	360	0.84 (21.3)	226 (337)	600 (2,700)	200 (890)	16.8 (437)	8.4 (219)
R2432xDSy	432	0.84 (21.3)	226 (337)	600 (2,700)	200 (890)	16.8 (437)	8.4 (219)

FIBER TYPES:

SINGLE MODE

HYBRID

	Reduced Water Peak	Zero Water Peak	TeraFlex® Bend Resistant G.657.A1	NZDS	LEAF	Hybrid
¹ Replace "x" with:	3	2	K	8	S	H

See "Optical Fiber Specifications" in the "Technical Information" section for detailed fiber type specifications.

WATER BLOCK AND JACKET PRINT CODES

	Dry core		Dry core special	
	Feet	Meters	Feet	Meters
¹ Replace "y" with:	1	2	5	6

If there were a professional group
where members had access to
hundreds of industry recognized
Subject Matter Experts,
would you join??

Of course you would!!

Follow us on Twitter, LinkedIn and YouTube



Stranded Tube Ribbon Single Armor

Series S2

PRODUCT DESCRIPTION

Stranded Tube Ribbon Single Armor Cable is designed for Outside Plant (OSP) applications specifically direct bury installations. Our industry leading optical fiber ribbons are manufactured with high dimensional precision and low planarity which equates to low losses during mass fusion splicing. The stranded tube design features optical fibers ribbons placed inside gel-filled tubes. Each tube contains up to 12 discretely identified, 12-fiber ribbons for maximum design load capacity of 1,008 optical fibers. The core is helically wrapped with water-blocking strength members. A corrugated steel armor is applied over the stranded core. Rigid steel rods encased in a outer jacket completes the construction. Rip cords are included under the armor for ease of entry.

APPLICATIONS

- Direct bury
- Broadband network
- Local loop
- Trunk, distribution and feeder cables

FEATURES

- Available with up to 1,008-fiber
- Multiple fiber types available
- Multiple stranded tubes
- Corrugated steel armor
- Ribbon fiber

BENEFITS

- High fiber density
- Multiple network applications
- Individual tube access
- Compressive strength, rodent protection and ease of location
- Saves labor cost by offering mass fusion splicing

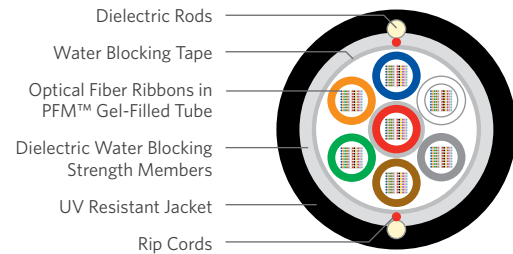

SPECIFICATIONS

Fiber Count	Available in 360-fiber up to 1,008-fiber
Standards Compliance	Telcordia® GR-20-CORE RDUP PE-90 Designation S2 RoHS-compliant

Telcordia is a registered trademark of Ericsson Inc. Corning is a registered trademark of Corning Incorporated.

ENVIRONMENTAL SPECIFICATIONS

Operation/Storage	-40°C to +70°C
Installation	-30°C to +70°C

PART NUMBER KEY

S	2	_	_	_	x	1	0	y
1	2	3	4	5	6	7	8	9
Product family	Fiber count (360-1,008)	Fiber type	Internal designator	Water block/ marking (1-8)				

Contact Customer Service for availability of non-standard offerings.

PART NUMBERS AND PHYSICAL CHARACTERISTICS

Part Number ¹	Fiber Count	Nominal Diameter in (mm)	Nominal Weight lbs/kft (kg/km)	Maximum Tensile Loading		Minimum Bend Radius	
				Install lbs (N)	Long Term lbs (N)	Install in (mm)	Long Term in (mm)
S2360x10y	360	1.27 (32.2)	536 (797)	600 (2,700)	180 (800)	25.4 (644)	12.7 (322)
S2432x10y	432	1.27 (32.2)	536 (797)	600 (2,700)	180 (800)	25.4 (644)	12.7 (322)
S2576x10y	576	1.27 (32.2)	536 (797)	600 (2,700)	180 (800)	25.4 (644)	12.7 (322)
S2720x10y	720	1.27 (32.2)	536 (797)	600 (2,700)	180 (800)	25.4 (644)	12.7 (322)
S2864x10y	864	1.27 (32.2)	536 (797)	600 (2,700)	180 (800)	25.4 (644)	12.7 (322)
S2A08x10y	1,008	1.27 (32.2)	536 (797)	600 (2,700)	180 (800)	25.4 (644)	12.7 (322)

FIBER TYPES:

SINGLE MODE

HYBRID

Reduced Water Peak	Zero Water Peak	TeraFlex® Bend Resistant G.657.A1	NZDS	LEAF	Corning® 28E+	Hybrid
--------------------	-----------------	-----------------------------------	------	------	---------------	--------

¹Replace "x" with:

3	2	K	8	S	R	H
---	---	---	---	---	---	---

See "Optical Fiber Specifications" in the "Technical Information" section for detailed fiber type specifications.

WATER BLOCK AND JACKET PRINT CODES

Dry core		Dry core special	
Feet	Meters	Feet	Meters

¹Replace "y" with:

1	2	5	6
---	---	---	---

Single Tube Ribbon

Series R1

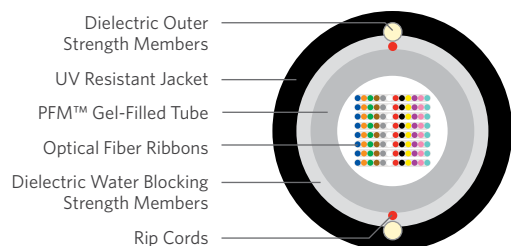

PRODUCT DESCRIPTION

Single Tube Ribbon Cable is designed for Outside Plant (OSP) applications, specifically lashed aerial and underground duct installations. Our industry leading optical ribbons are manufactured with high dimensional precision and low planarity, which equates to low losses during mass fusion splicing. The Single Tube Ribbon Cable features optical ribbons inside a single PFM™ gel-filled tube. The core tube includes up to eighteen 12-fiber or 24-fiber ribbons. Each 12-fiber ribbon unit is discretely identified and captured in an easy peel matrix for ease of ribbon breakout and management. The core tube is wrapped with a water-blocking tape. Longitudinal strength elements are applied over the core tube and encased within a black jacket. A rip cord is included under the jacket for easy access to the core tube.

APPLICATIONS

- Lashed aerial, underground duct
- Broadband network
- Local loop
- Trunk, distribution and feeder cables

FEATURES

- Available with up to 864-fiber
- Multiple fiber types available
- Dielectric strength members
- Highly flexible tube
- Ribbon fiber
- Meets or exceeds Bellcore and RDUP specifications
- PFM gel

BENEFITS

- High fiber density
- Multiple network applications
- Dielectric design eliminates grounding issues
- Easy handling and easy tube access
- Saves labor cost by offering mass fusion splicing
- Industry approved
- Non-sticky gel allows for easier and faster clean up

SPECIFICATIONS

Fiber Count	Available in 12-fiber up to 86-fiber
Standards Compliance	Telcordia® GR-20-CORE RDUP PE-90 Designation SLT-R RoHS-compliant

Telcordia is a registered trademark of Ericsson Inc.

ENVIRONMENTAL SPECIFICATIONS

Operation/Storage	-40°C to +70°C
Installation	-30°C to +70°C

PART NUMBER KEY

R	1	—	—	—	x	1	0	y
1	2	3	4	5	6	7	8	9
Product family	Fiber count (012-864)			Fiber type	Internal designator	Water block/markings (1-8)		

Contact Customer Service for availability of non-standard offerings.

PART NUMBERS AND PHYSICAL CHARACTERISTICS

Part Number ¹	Fiber Count	Nominal Diameter in (mm)	Nominal Weight lbs/kft (kg/km)	Maximum Tensile Loading		Minimum Bend Radius	
				Install lbs (N)	Long Term lbs (N)	Install in (mm)	Long Term in (mm)
R1012x10y	12	0.47 (12.0)	71 (106)	600 (2,700)	200 (890)	9.4 (239)	4.7 (119)
R1048x10y	48	0.47 (11.9)	71 (106)	600 (2,700)	200 (890)	9.4 (239)	4.7 (119)
R1072x10y	72	0.57 (14.5)	96 (143)	600 (2,700)	200 (890)	11.4 (290)	5.7 (145)
R1096x10y	96	0.57 (14.5)	96 (143)	600 (2,700)	200 (890)	11.4 (290)	5.7 (145)
R1144x10y	144	0.63 (15.9)	120 (178)	600 (2,700)	200 (890)	12.6 (320)	6.3 (160)
R1216x10y	216	0.67 (17.0)	138 (206)	600 (2,700)	200 (890)	13.4 (340)	6.7 (170)
R1288x10y	288	0.79 (20.0)	180 (267)	600 (2,700)	200 (890)	15.8 (401)	7.9 (201)
R1432x10y	432	0.79 (20.0)	188 (280)	600 (2,700)	200 (890)	15.8 (401)	7.9 (201)
R1576x101	576	0.98 (25.0)	311 (463)	600 (2,700)	200 (890)	19.6 (500)	9.8 (250)
R1864x101	864	0.98 (25.0)	311 (463)	600 (2,700)	200 (890)	19.6 (500)	9.8 (250)

FIBER TYPES:

SINGLE MODE

HYBRID

Reduced Water Peak	Zero Water Peak	TeraFlex® Bend Resistant G.657.A1	NZDS	LEAF	Hybrid
3	2	K	8	S	H

¹Replace "x" with:

See "Optical Fiber Specifications" in the "Technical Information" section for detailed fiber type specifications.

WATER BLOCK AND JACKET PRINT CODES

Dry core		Dry core special	
Feet	Meters	Feet	Meters
1	2	5	6

¹Replace "y" with:

Single Tube Ribbon Single Armor

Series R2

PRODUCT DESCRIPTION

Single Tube Ribbon Single Armor Cable is designed for Outside Plant (OSP) applications, specifically lashed aerial and underground duct installations. Our industry leading optical ribbons are manufactured with high dimensional precision and low planarity, which equates to low losses during mass fusion splicing. The Single Tube Ribbon Single Armor cable features optical ribbons inside a single PFM™ gel-filled tube. The core tube includes up to eighteen 12-fiber or 24-fiber ribbons. Each 12-fiber ribbon unit is discretely identified and captured in an easy peel matrix for ease of ribbon breakout and management. The core tube is wrapped with a water-blocking tape. A corrugated steel armor and longitudinal strength elements are applied over the core tube and encased within a black jacket. Rip cords are included under the armor for easy access to the core tube.

APPLICATIONS

- Direct bury
- Broadband network
- Local loop
- Trunk, distribution and feeder cables

FEATURES

- Available with up to 432-fiber
- Multiple fiber types available
- Metallic outer strength members
- Highly flexible tube
- Corrugated steel armor
- Ribbon fiber
- Meets or exceeds Bellcore and RDUP specifications
- PFM gel

BENEFITS

- High fiber density
- Multiple network applications
- Metallic design offers easy location
- Easy handling and easy tube access
- Compressive strength, rodent protection and ease of location
- Saves labor cost by offering mass fusion splicing
- Industry approved
- Non-sticky gel allows for easier and faster clean up

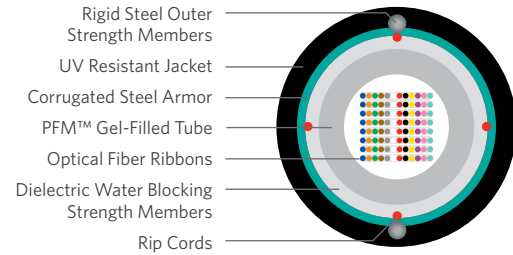

SPECIFICATIONS

Fiber Count	Available in 12-fiber up to 432-fiber
Standards Compliance	Telcordia® GR-20-CORE RDUP PE-90 Designation SLT-R RoHS-compliant

Telcordia is a registered trademark of Ericsson Inc.

ENVIRONMENTAL SPECIFICATIONS

Operation/Storage	-40°C to +70°C
Installation	-30°C to +70°C

PART NUMBER KEY

R	2	—	—	—	x	1	S	y
1	2	3	4	5	6	7	8	9
Product family	Fiber count (012-432)				Fiber type	Internal designator	Water block/markings (1-8)	

Contact Customer Service for availability of non-standard offerings.

PART NUMBERS AND PHYSICAL CHARACTERISTICS

Part Number ¹	Fiber Count	Nominal Diameter in (mm)	Nominal Weight lbs/kft (kg/km)	Maximum Tensile Loading		Minimum Bend Radius	
				Install lbs (N)	Long Term lbs (N)	Install in (mm)	Long Term in (mm)
R2012x1Sy	12	0.51 (13.0)	118 (175)	600 (2,700)	200 (890)	10.2 (259)	5.1 (130)
R2024x1Sy	24	0.51 (13.0)	118 (175)	600 (2,700)	200 (890)	10.2 (259)	5.1 (130)
R2036x1Sy	36	0.51 (13.0)	118 (175)	600 (2,700)	200 (890)	10.2 (259)	5.1 (130)
R2048x1Sy	48	0.51 (13.0)	118 (175)	600 (2,700)	200 (890)	10.2 (259)	5.1 (130)
R2072x1Sy	72	0.58 (15.0)	150 (223)	600 (2,700)	200 (890)	11.6 (295)	5.8 (147)
R2096x1Sy	96	0.58 (15.0)	150 (223)	600 (2,700)	200 (890)	11.6 (295)	5.8 (147)
R2144x1Sy	144	0.66 (17.0)	187 (279)	600 (2,700)	200 (890)	13.2 (335)	6.0 (152)
R2192x1Sy	192	0.66 (17.0)	195 (290)	600 (2,700)	200 (890)	13.6 (345)	6.8 (173)
R2216x1Sy	216	0.66 (17.0)	195 (290)	600 (2,700)	200 (890)	13.6 (345)	6.8 (173)
R2288x1Sy	288	0.84 (21.0)	256 (381)	600 (2,700)	200 (890)	16.8 (420)	8.4 (210)
R2360x1Sy	360	0.84 (21.0)	256 (381)	600 (2,700)	200 (890)	16.8 (420)	8.4 (210)
R2432x1Sy	432	0.84 (21.0)	256 (381)	600 (2,700)	200 (890)	16.8 (420)	8.4 (210)

FIBER TYPES:	SINGLE MODE					HYBRID
	Reduced Water Peak	Zero Water Peak	TeraFlex® Bend Resistant G.657.A1	NZDS	LEAF	Hybrid
¹ Replace "x" with:	3	2	K	8	S	H

See "Optical Fiber Specifications" in the "Technical Information" section for detailed fiber type specifications.

WATER BLOCK AND JACKET PRINT CODES

	Dry core		Dry core special	
	Feet	Meters	Feet	Meters
¹ Replace "y" with:	1	2	5	6

Composite Right of Way

Series MR

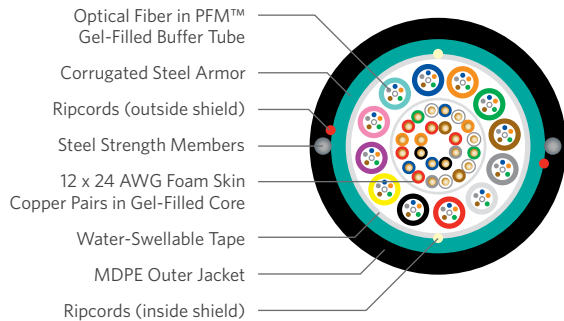

PRODUCT DESCRIPTION

The Composite Right of Way Series MR cable is designed to meet the network requirements for both twisted copper pair and optical fiber. The small 0.65 inch (16.6 mm) profile of this design easily fits into a 1-inch conduit. The cable operates within a temperature range of -40°C to +70°C, provides a maximum tensile strength of 600 lbs, and incorporates 12, 24 AWG twisted copper pairs and up to 72 strands of optical fiber. The core, 12 pairs of 24 AWG gel-filled copper, is surrounded by 12 gel-filled tubes each containing 6 optical fibers. The core is water-blocked with super absorbent polymers and then encased in a steel armor. Two steel rods for anti-buckling are included in the outer jacket.

APPLICATIONS

- Small conduits

FEATURES

- Fiber and twisted copper pair
- Single unit construction
- Available with up to 72-fiber
- Small nominal diameter

BENEFITS

- Offers the maximum bandwidth for FTTP business, etc.
- Lower installation costs
- High capacity
- Suitable for small (1 inch) conduit applications

COMPOSITE SPECIFICATIONS

Construction	Copper pairs at center of cable surrounded by stranded loose tubes of optical fiber
Water Block	Super absorbent polymer tape
Shield	Corrugated steel armor
Strength Members	Two steel strength members embedded in jacket
Jacket	MDPE
Standards Compliance	Telcordia® GR-20-CORE ICEA S-84-608-2007

Telcordia is a registered trademark of Ericsson Inc.

ENVIRONMENTAL SPECIFICATIONS

Operation/Storage	-40°C to +70°C
Installation	-30°C to +70°C

OSP COPPER SPECIFICATIONS

Conductor	12-pair 24 AWG (0.51 mm) solid annealed copper
Core Filling	Thixotropic gel

OPTICAL FIBER SPECIFICATIONS

Construction	Stranded loose tube design features optical fibers placed inside a PFM™ gel-filled tube
Fiber Count	Up to 72 optical fibers

PART NUMBERS AND PHYSICAL CHARACTERISTICS

Part Number	Fiber Count	Fiber Type	Nominal Diameter in (mm)	Approx. Weight lbs/kft (kg/km)	Install Bend Radius in (mm)	Maximum Tensile Load	
						Install lbs (N)	Long Term lbs (N)
MR0723011	72	RWP SMF	0.65 (16.6)	160 (237)	13 (332)	600 (2,700)	200 (890)

Part number listed are RWP single mode optical fiber only. Other fiber types are available. See "Optical Fiber Specifications" in the "Technical Information" section for detailed fiber type specifications.

Composite Category 5e Drop

Series 5F

PRODUCT DESCRIPTION

Series 5F combines the broadband performance of CAT 5e with the unlimited capacity of optical fiber. A BBDNe CAT 5e Outside Plant (OSP) cable and a Series 513 optical fiber cable are overjacketed into one cable in order to offer flexibility and ease of installation.

APPLICATIONS

- Drop cables
- Broadband network
- Fiber to the premise

FEATURES

- Fiber and CAT 5e
- Overjacket design
- Single unit construction
- Available with 1-fiber up to 12-fiber
- PFM™ gel

BENEFITS

- Offers the maximum bandwidth for FTTP business, etc.
- Ease of use
- Lower installation costs
- High capacity
- Non-sticky gel reduces installation time and labor cost

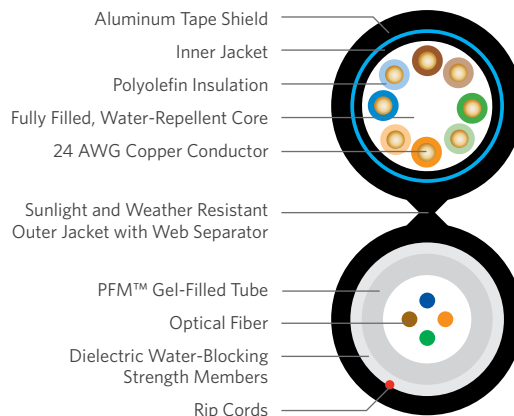

COMPOSITE SPECIFICATIONS

Single Jacket Design	Copper and fiber independent cables are jacketed into one cable in order to offer flexibility and ease of installation
Standards Compliance	Copper and fiber cables meet applicable Telcordia® and TIA standards

Telcordia is a registered trademark of Ericsson Inc.

ENVIRONMENTAL SPECIFICATIONS

Operation/Storage	-40°C to +70°C
Installation	-30°C to +70°C

PART NUMBERS AND PHYSICAL CHARACTERISTICS

Part Number	Fiber Count	Fiber Type	Nominal Diameter in (mm)	Approx. Weight lbs/kft (kg/km)	Bend Radius in (mm)	Maximum Tensile Load		Standard Quantity ft (m)
						Install lbs (N)	Long Term lbs (N)	
11-003-30	4	RWP SMF	0.63 (16) x 0.43 (10.9)	100 (148.8)	5.5 (139.7)	300 (136)	100 (45)	5,000 (1,524)

Part number listed are RWP single mode optical fiber only. Other fiber types are available. See "Optical Fiber Specifications" in the "Technical Information" section for detailed fiber type specifications.

OSP COPPER SPECIFICATIONS

Conductor	CAT 5e 4-pair 24 AWG solid annealed copper
Core Filling	Thixotropic gel
Shield	Coated smooth aluminum tape
Water Block	Super absorbent polymer

OPTICAL FIBER SPECIFICATIONS

Construction	Series 513 single loose tube design with optical fibers placed inside a PFM gel-filled tube
Fiber Count	Up to 12 optical fibers
Strength Members	Core is helically wrapped with dielectric water-blocking strength members
Water Block	Super absorbent polymer

Composite Drop Web

Series 5W

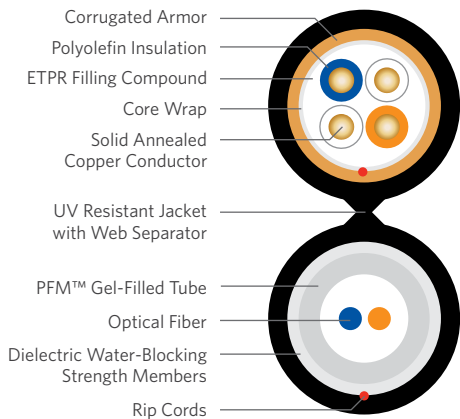

PRODUCT DESCRIPTION

Series 5W Composite Drop Cables combine fiber and copper technologies in a web design. The composite design provides a cost benefit compared to installing separate fiber and copper cables. The independent Series 513 optical fiber cable and the BSW Outside Plant (OSP) copper cable are combined in a single jacket design utilizing a web separator. This lightweight design is easy to access since the cables are easily separated at the web. In addition, each independent cable also contains a rip cord.

APPLICATIONS

- Network power and FTTP
- Drop cables

FEATURES

- Independent fiber and copper cables combined in a web design
- Web design
- Combined transport technologies in one cable
- Optical/electrical technology
- Multiple fiber types available
- PFM™ gel

BENEFITS

- Reduces cost of cable and labor
- Easy separation of technologies
- Cost-effective installation
- Ideal for multiple projects, voice, video, data and powering
- Multiple applications
- Non-sticky gel reduces installation time and labor cost

BSW OSP COPPER SPECIFICATIONS

Conductor	Solid annealed copper
Insulation	Solid polyolefin
Core Wrap	Non-hygroscopic
Filling Compound	80°C ETPR compound for water-blocking protection
Shield	Corrugated armor

OPTICAL FIBER SPECIFICATIONS

Construction	Series 513 single loose tube design features optical fibers placed inside a PFM gel-filled tube
Fiber Count	Up to 12 optical fibers
Strength Members	Core is helically wrapped with dielectric water-blocking strength members

COMPOSITE SPECIFICATIONS

Single Jacket Design	Copper and fiber jackets joined by a web separator that can be split to direct the cables to separate locations
Standards Compliance	Copper and fiber cables meet applicable Telcordia®, RDUP and ICEA specifications RoHS-compliant

Telcordia is a registered trademark of Ericsson Inc.

ENVIRONMENTAL SPECIFICATIONS

Operation/Storage	-40°C to +70°C
Installation	-30°C to +70°C

PART NUMBERS AND PHYSICAL CHARACTERISTICS

Part Number	Copper Pair Count x AWG	Fiber Count	Fiber Type	Nominal Diameter		Approx. Weight lbs/kft (kg/km)	Package
				Copper Component in (mm)	Fiber Component in (mm)		
5W002302Q	2 x 19	2	RWP SMF	0.31 (7.9)	0.26 (6.7)	131 (195)	8,000' Reel
71-202-12	5 x 19	2	RWP SMF	0.36 (9.1)	0.26 (6.7)	179 (266)	8,000' Reel
5W002301Q	2 x 22	2	RWP SMF	0.27 (6.9)	0.26 (6.7)	114 (170)	8,000' Reel
5W002303Q	5 x 22	2	RWP SMF	0.32 (8.1)	0.26 (6.7)	136 (202)	8,000' Reel
5W004301Q	6 x 22	4	RWP SMF	0.36 (9.1)	0.26 (6.7)	149 (222)	8,000' Reel

Part numbers listed are RWP single mode optical fiber only. Other fiber types are available. See "Optical Fiber Specifications" in the "Technical Information" section for detailed fiber type specifications.

Composite Drop Overjacket

Series 71 OJ

PRODUCT DESCRIPTION

Series 71 OJ Composite Drop Cables combine fiber and copper technologies in an overjacket design. The independent Series 513 optical fiber cable and the BSW Outside Plant (OSP) copper cable are combined into one overjacketed cable. The composite design provides a cost benefit compared to installing separate fiber and copper cables.

This design allows great flexibility regarding the independent cables used in the overall construction. These independent cables are encased in an outer jacket with a rip cord included for ease of entry.

APPLICATIONS

- Network power and FTTP
- Drop cables

FEATURES

- Independent fiber and copper cables combined in an overjacket design
- Overjacket design
- Combined transport technologies in one cable
- Various combinations and multiple fiber types available
- PFM™ gel

BENEFITS

- Lightweight, flexible construction
- Easy separation of technologies
- Cost-effective installation
- Ideal for multiple projects
- Non-sticky gel reduces installation time and labor cost

COMPOSITE SPECIFICATIONS

Single Jacket Design	Independent copper and fiber cables are encased in a outer jacket with a rip cord
Standards Compliance	Copper and fiber cables meet applicable Telcordia®, RDUP and ICEA specifications RoHS-compliant

Telcordia is a registered trademark of Ericsson Inc.

ENVIRONMENTAL SPECIFICATIONS

Operation/Storage	-40°C to +70°C
Installation	-30°C to +70°C

PART NUMBERS AND PHYSICAL CHARACTERISTICS

Part Number	Copper Pair Count x AWG	Fiber Count	Fiber Type	Nominal Diameter		Approx. Weight lbs/kft (kg/km)	Package
				Copper Component in (mm)	Fiber Component in (mm)		
71-055-02	2 x 22	2	RWP SMF	0.27 (6.9)	0.26 (6.7)	114 (170)	8,000' Reel
71-402-02	5 x 22	2	RWP SMF	0.32 (8.1)	0.26 (6.7)	136 (202)	8,000' Reel

Part numbers listed are RWP single mode optical fiber only. Other fiber types are available. See "Optical Fiber Specifications" in the "Technical Information" section for detailed fiber type specifications.

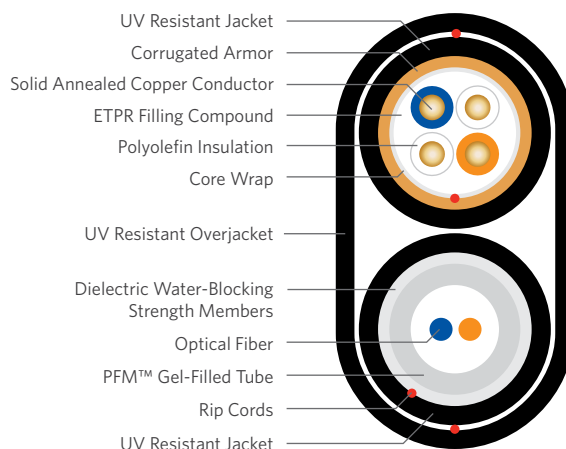

BSW OSP COPPER SPECIFICATIONS

Conductor	Solid annealed copper
Insulation	Solid polyolefin
Core Wrap	Non-hygroscopic
Filling Compound	80°C ETPR compound for water-blocking protection
Shield	Corrugated armor

OPTICAL FIBER SPECIFICATIONS

Construction	Series 513 single loose tube design features optical fibers placed inside a PFM gel-filled tube
Fiber Count	Up to 12 optical fibers
Strength Members	Core is helically wrapped with dielectric water-blocking strength members

Composite OSP Web

Series 5V

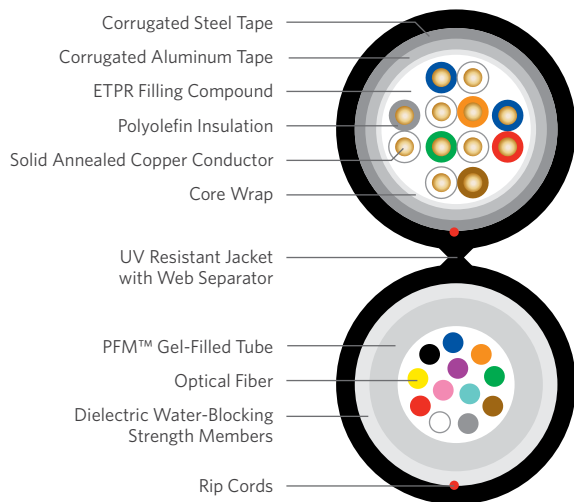
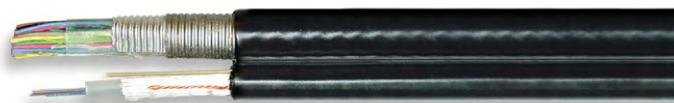

PRODUCT DESCRIPTION

Series 5V Cables are designed for Outside Plant (OSP) broadband applications. These cables combine copper and optical fiber technologies into one composite cable and are suitable for voice, video and data communications. The copper cable offers the option of providing network power to eliminate the cost of local powering. The wide range of copper and fiber counts make this cable ideal for most projects.

The construction of this product combines an ANAW OSP copper cable and a Series 51 optical fiber cable. These independent cables are simultaneously jacketed in a polyethylene outer jacket with a rip cord included for ease of entry. The web connects the cables and can be easily split to direct the cables to different locations.

APPLICATIONS

- Direct bury, conduit, lashed aerial

FEATURES

- Independent fiber and copper cables under one jacket
- Web design
- Optical/electrical technology
- Web design
- PFM™ gel

BENEFITS

- Reduces labor cost
- Easy separation to different locations
- Ideal for voice, video and data
- Lower cost
- Non-sticky gel reduces installation time and labor cost

ANAW OSP COPPER SPECIFICATIONS

Conductor	22 AWG solid annealed copper
Insulation	Inner layer of foamed, natural polyolefin covered by an outer layer of solid, colored polyolefin
Core Wrap	Non-hygroscopic
Filling Compound	80°C ETPR compound for water-blocking protection
Shield	Corrugated 8 mil aluminum tape covered by a corrugated bare 6 mil steel tape; both inner and outer surfaces of the tapes are flooded to provide a moisture barrier and inhibit corrosion

OPTICAL FIBER SPECIFICATIONS

Construction	Series 51 single loose tube design features optical fibers placed inside a PFM gel-filled tube
Fiber Count	Up to 8 optical fiber bundles, each containing up to 12-fiber within a color coded binder
Strength Members	Core is helically wrapped with dielectric water-blocking strength members

COMPOSITE SPECIFICATIONS

Single Jacket Design	Copper and fiber independent cables are simultaneously jacketed in a polyethylene outer jacket with a rip cord included for ease of entry Web connects the cables and can be easily split to direct the cables to different locations
Standards Compliance	Copper and fiber cables meet applicable Telcordia® Specifications (GR-421-CORE, GR-20 Core)

Telcordia is a registered trademark of Ericsson Inc.

ENVIRONMENTAL SPECIFICATIONS

Operation/Storage	-40°C to +70°C
Installation	-30°C to +70°C

PART NUMBERS AND PHYSICAL CHARACTERISTICS

Part Number	Copper Pair Count	Fiber Count	Fiber Type	Nominal Diameter		Approx. Weight lbs/kft (kg/km)	Package
				Copper Component in (mm)	Fiber Component in (mm)		
5V0063061	6	6	RWP SMF	0.45 (11)	0.37 (9)	176 (262)	14,800' Reel
5V0063121	12	6	RWP SMF	0.56 (14)	0.37 (9)	234 (348)	14,800' Reel
5V0123121	12	12	RWP SMF	0.56 (14)	0.37 (9)	234 (348)	14,800' Reel
5V0183181	18	18	RWP SMF	0.61 (15)	0.37 (9)	285 (425)	14,800' Reel
5V0123251	25	12	RWP SMF	0.72 (18)	0.37 (9)	355 (528)	12,700' Reel
5V0243251	25	24	RWP SMF	0.72 (18)	0.37 (9)	355 (528)	12,700' Reel

Part numbers listed are RWP single mode optical fiber only. Other fiber types are available. See "Optical Fiber Specifications" in the "Technical Information" section for detailed fiber type specifications.

Composite OSP Overjacket

Series 70 OJ

PRODUCT DESCRIPTION

Series 70 OJ Cables are designed for Outside Plant (OSP) broadband applications. These cables combine copper and optical fiber technologies into one composite cable and are suitable for voice, video and data communications. The copper cable offers the option of providing network power to eliminate the cost of local powering. The wide range of copper and fiber counts make this cable ideal for most projects.

The construction of this product combines an ANAW OSP copper cable and a Series 51 optical fiber cable. These independent cables are encased in an outer jacket with a rip cord included for ease of use.

APPLICATIONS

- Direct bury, conduit, lashed aerial

FEATURES

- Independent fiber and copper cables under one jacket
- Overjacket design
- Optical/Electrical Technology
- PFM™ gel

BENEFITS

- Reduces labor cost
- Easy separation to different locations
- Ideal for voice, video and data
- Non-sticky gel reduces installation time and labor cost

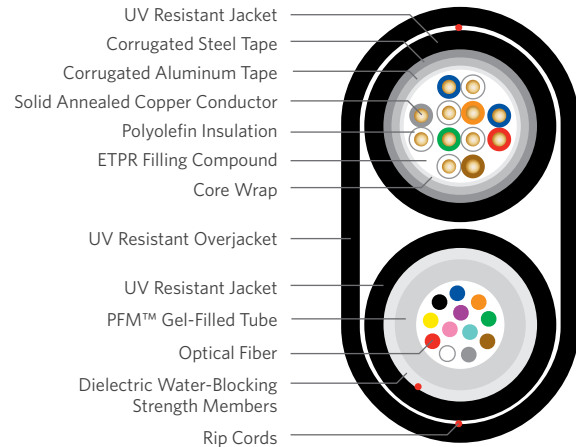

COMPOSITE SPECIFICATIONS

Single Jacket Design

Copper and fiber independent cables are encased in an overjacket with a rip cord included for ease of use

Standards Compliance

Copper and fiber cables meet applicable Telcordia® Specifications (GR-421-CORE, GR-20 Core)

Telcordia is a registered trademark of Ericsson Inc.

ENVIRONMENTAL SPECIFICATIONS

Operation/Storage

-40°C to +70°C

Installation

-30°C to +70°C

ANAW OSP COPPER SPECIFICATIONS

Conductor	22 AWG solid annealed copper
Insulation	Inner layer of foamed, natural polyolefin covered by an outer layer of solid, colored polyolefin
Core Wrap	Non-hygroscopic
Filling Compound	80°C ETPR compound provides water-blocking protection
Shield	Corrugated 8 mil aluminum tape covered by a corrugated bare 6 mil steel tape; both inner and outer surfaces of the tapes are flooded to provide a moisture barrier and inhibit corrosion

OPTICAL FIBER SPECIFICATIONS

Construction	Series 51 single loose tube design features optical fibers placed inside a PFM gel-filled tube
Fiber Count	Up to 8 optical fiber bundles, each containing up to 12-fiber within a color coded binder
Strength Members	Core is helically wrapped with dielectric water-blocking strength members

PART NUMBERS AND PHYSICAL CHARACTERISTICS

Part Number	Copper Pair Count	Fiber Count	Fiber Type	Nominal Diameter		Approx. Weight lbs/kft (kg/km)	Package
				Copper Component in (mm)	Fiber Component in (mm)		
70-425-18	36	18	RWP SMF	0.76 (19)	0.37 (9)	443 (658)	11,100' Reel
70-425-36	36	36	RWP SMF	0.76 (19)	0.37 (9)	443 (658)	11,100' Reel
70-065-24	50	24	RWP SMF	0.88 (22)	0.37 (9)	546 (811)	8,900' Reel
70-065-48	50	48	RWP SMF	0.88 (22)	0.37 (9)	546 (811)	8,900' Reel
70-067-36	75	36	RWP SMF	1.00 (25)	0.37 (9)	724 (1,077)	6,000' Reel
70-067-72	75	72	RWP SMF	1.00 (25)	0.51 (13)	734 (1,092)	6,000' Reel
70-069-48	100	48	RWP SMF	1.15 (29)	0.37 (9)	895 (1,331)	6,000' Reel
70-069-72	100	72	RWP SMF	1.15 (29)	0.51 (13)	924 (1,374)	6,000' Reel
70-071-72	150	72	RWP SMF	1.34 (34)	0.51 (13)	1,260 (1,874)	3,000' Reel
70-071-96	150	96	RWP SMF	1.34 (34)	0.51 (13)	1,260 (1,874)	3,000' Reel
70-073-96	200	96	RWP SMF	1.50 (38)	0.51 (13)	1,615 (2,403)	2,500' Reel

Part numbers listed are RWP single mode optical fiber only. Other fiber types are available. See "Optical Fiber Specifications" in the "Technical Information" section for detailed fiber type specifications.

Composite Round CF

Series L

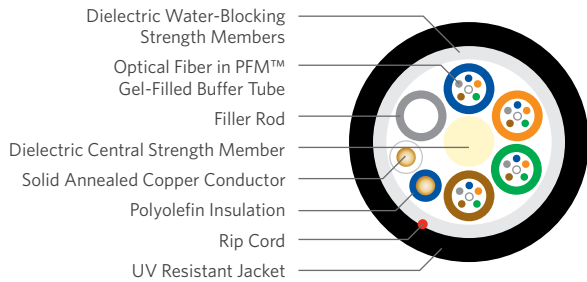

PRODUCT DESCRIPTION

Series L Cables combine the attributes of optical fiber and copper technologies in a single cable. Designed for Outside Plant (OSP) applications, these cables improve network flexibility by addressing the need to transmit electrical power while providing virtually unlimited bandwidth to the subscriber. Labor savings are also realized making this product ideal for various projects.

FEATURES

- Fiber tubes and copper pairs in one jacket
- Wide range of copper and fiber counts
- Single mode, multimode and hybrid designs
- Copper twisted pairs
- Various cable designs
- PFM™ gel

BENEFITS

- Reduced material cost and significant installation savings
- Sizes available for large and small projects
- Multiple network applications
- Capable of voice transmission, cable location and site powering
- Multiple applications
- Non-sticky gel reduces installation time and labor cost

NOTE

- Special cable lengths are available upon request
- Please contact your Superior Essex sales professional with your application requirements

SPECIFICATIONS

Construction	Loose tube, single jacket
Standards Compliance	Copper and fiber cables meet applicable Telcordia® and RDUP specifications RoHS-compliant

Telcordia is a registered trademark of Ericsson Inc.

ELECTRICAL SPECIFICATIONS

Conductor Size AWG (mm)	Conductor DC Resistance @ 68°F Maximum Individual Ohms/mile (Ohms/km)	Resistance Unbalance Maximum Individual Pair %	Dielectric Strength DC Potential - Volts Minimum Conductor to Conductor	Maximum Voltage	Maximum Amperage/Conductor
22 (0.64)	91.0 (56.6)	5.0	5,000	150 vDC	1.0 A

PART NUMBERS AND PHYSICAL CHARACTERISTICS

Part Number	Copper Pair Count	Fiber Count	Fiber Type	Optional Shield	Filling Compound	Length Marking	Nominal Diameter in (mm)	Approx. Weight lbs/kft (kg/km)	Maximum Tensile Load	
									Install lbs (N)	Long Term lbs (N)
11024C02Q	1	24	RWP SMF	-	Dry	Feet	0.43 (10.85)	58 (86)	600 (2,700)	200 (890)
11024D01Q	2	24	RWP SMF	-	Flood	Meters	0.43 (10.85)	69 (103)	600 (2,700)	200 (890)
12024D02Q	2	24	RWP SMF	Single Armor	Flood	Meters	0.48 (12.20)	107 (160)	600 (2,700)	200 (890)

Part number listed are RWP single mode optical fiber only. Other fiber types are available. See "Optical Fiber Specifications" in the "Technical Information" section for detailed fiber type specifications.



We've Got You Covered

- Standard Product Warranty (1 Year)
- PerformaLink® Warranty (25 Years)
 - Extended Premises cable warranty
 - Covers network's permanent link
 - 25 years with Legrand/Ortronics or 20 years with other approved connectivity manufacturers
- Campus Warranty (25 Years)
 - Covers Premises and OSP cables
 - 25 years with Legrand/Ortronics or 20 years with other approved connectivity manufacturers



For copies of our warranty terms and application forms, visit ce.SuperiorEssex.com/Resources/Warranties-and-Policies

SEALPIC®



SPECIFICATIONS

Conductor	Solid annealed copper
Insulation	Solid polyolefin; color coded in accordance with industry standards
Twisted Pairs	Individual insulated conductors are twisted into pairs with varying lay lengths; specific color combinations provide pair identification
≤ 25-Pair Core	Pairs are assembled into a cylindrical core
> 25-Pair Core	Cables larger than 25-pair are assembled into units, which are then used to assemble the core; units are identifiable using color-coded binders
Core Wrap	Non-hygroscopic, dielectric tape
Shield	Corrugated, copolymer coated, 8 mil aluminum tape applied longitudinally with an overlap
Jacket	Black, polyethylene
Jacket Marking	Identifying information includes a telephone handset, cable code, pair count, AWG, date of manufacture and sequential length markings at 2 foot intervals
Standards Compliance	ANSI/ICEA S-85-625-2011 Formerly PE-22 RoHS-compliant

PRODUCT DESCRIPTION

SEALPIC® Cables have an air core design and are suited for lashed aerial installations. If used in underground conduit, pressurization is recommended. SEALPIC cables are not recommended for direct burial installations.

APPLICATIONS

- Lashed aerial
- Pressurized underground conduit

FEATURES

- Twisted into pairs with varying lay lengths
- Core wrap
- Black, polyethylene jacket

BENEFITS

- Minimizes crosstalk
- Provides thermal protection
- Provides a tough protective covering designed to withstand exposure to direct sunlight, atmospheric temperature changes and stresses expected in standard installations

ELECTRICAL SPECIFICATIONS

Number of Pairs	Average Mutual Capacitance @ 1,000 Hz nF/mile (nF/km)	Capacitance Unbalance Pair to Pair @ 1 kHz		Capacitance Unbalance Pair to Ground @ 1 kHz	
		Maximum Individual pF @ 1 kft (pF @ 1 km)	Maximum RMS pF @ 1 kft (pF @ 1 km)	Maximum Individual pF @ 1 kft (pF @ 1 km)	Maximum Average pF @ 1 kft (pF @ 1 km)
12 or less	83 ± 7 (52 ± 4)	80 (145)	-	800 (2,625)	-
Over 12	83 ± 4 (52 ± 2)	80 (145)	25 (45)	800 (2,625)	175 (574)

Conductor Size AWG (mm)	Minimum Insulation Resistance @ 68°F (20°C) gigohm-mile (gigohm-km)	Maximum Average Attenuation* 772 kHz @ 68°F (20°C) dB/kft (dB/km)	Maximum Conductor Resistance @ 68°F (20°C) Ohms/sheath mile (km)	DC Resistance Unbalance Maximum %		Dielectric Strength DC Potential - Volts	
				Average	Individual Pair	Conductor to Conductor	Conductor to Shield
19 (0.90)	1.0 (1.6)	3.3 (10.8)	45.0 (28.0)	1.5	5.0	5,000	10,000
22 (0.64)	1.0 (1.6)	4.7 (15.4)	91.0 (56.5)	1.5	5.0	4,000	10,000
24 (0.51)	1.0 (1.6)	5.9 (19.4)	144.0 (89.5)	1.5	5.0	3,000	10,000

*For cables with 12-pair or less, the maximum average attenuation may be increased by 10% over the values shown.

Minimum Near End Crosstalk (NEXT) @ 772 kHz

PSWUNEXT Mean (dB)	47
PSWUNEXT Worst Pair (dB)	42

Minimum Far End Crosstalk (FEXT) @ 772 kHz

Conductor Size (AWG)	19	22	24
PSELFEXT Mean (dB/kft)	51	49	49
PSELFEXT Worst Pair (dB/kft)	45	43	43

PART NUMBERS AND PHYSICAL CHARACTERISTICS

Part Number	Pair Count	AWG (mm)	Nominal Diameter in (mm)	Approx. Weight lbs/kft (kg/km)	Standard Length ft (m)	Approx. Shipping Weight lbs (kg)	Reel Size F x T x D in
01-028-40	12	19 (0.90)	0.57 (15)	170 (255)	5,000 (1,524)	1,015 (460)	46 x 25 x 20
01-031-40	25	19 (0.90)	0.76 (19)	310 (460)	5,000 (1,524)	1,755 (795)	52 x 25 x 20
01-034-40	50	19 (0.90)	1.00 (25)	575 (855)	5,000 (1,524)	3,165 (1,435)	62 x 30 x 24
01-038-40	100	19 (0.90)	1.34 (34)	1,075 (1,600)	5,000 (1,524)	6,075 (2,755)	78 x 40 x 39
01-059-40	12	22 (0.64)	0.46 (12)	100 (150)	5,000 (1,524)	610 (275)	44 x 18 x 20
01-062-40	25	22 (0.64)	0.60 (15)	180 (270)	5,000 (1,524)	1,065 (485)	46 x 25 x 20
01-065-40	50	22 (0.64)	0.77 (20)	315 (470)	5,000 (1,524)	1,780 (805)	52 x 25 x 20
01-069-40	100	22 (0.64)	1.02 (26)	580 (865)	5,000 (1,524)	3,190 (1,445)	62 x 30 x 24
01-073-40	200	22 (0.64)	1.38 (35)	1,095 (1,630)	5,000 (1,524)	6,175 (2,800)	78 x 40 x 39
01-075-40	300	22 (0.64)	1.66 (42)	1,605 (2,390)	2,500 (762)	4,625 (2,100)	72 x 35 x 36
01-077-40	400	22 (0.64)	1.89 (48)	2,115 (3,150)	2,500 (762)	5,985 (2,715)	78 x 40 x 39
01-094-40	12	24 (0.51)	0.41 (10)	75 (110)	5,000 (1,524)	440 (200)	36 x 18 x 14
01-097-40	25	24 (0.51)	0.51 (13)	125 (185)	5,000 (1,524)	735 (330)	44 x 18 x 20
01-100-40	50	24 (0.51)	0.64 (16)	215 (320)	5,000 (1,524)	1,240 (560)	46 x 25 x 20
01-104-40	100	24 (0.51)	0.83 (21)	385 (575)	5,000 (1,524)	2,170 (985)	58 x 25 x 20
01-108-40	200	24 (0.51)	1.12 (28)	715 (1,065)	5,000 (1,524)	4,190 (1,900)	72 x 35 x 36
01-110-40	300	24 (0.51)	1.33 (34)	1,040 (1,550)	5,000 (1,524)	5,900 (2,675)	78 x 40 x 39
01-112-40	400	24 (0.51)	1.52 (39)	1,360 (2,025)	2,500 (762)	4,015 (1,820)	72 x 35 x 36
01-116-40	600	24 (0.51)	1.82 (46)	2,005 (2,985)	2,500 (762)	5,710 (2,590)	78 x 40 x 39
01-118-40	900	24 (0.51)	2.19 (56)	2,960 (4,405)	1,250 (381)	4,315 (1,955)	72 x 35 x 36
01-120-40	1,200	24 (0.51)	2.49 (63)	3,895 (5,795)	1,250 (381)	5,570 (2,525)	78 x 40 x 39
01-121-40	1,500	24 (0.51)	2.79 (71)	4,845 (7,210)	1,250 (381)	6,855 (3,110)	84 x 40 x 42
01-124-40	1,800	24 (0.51)	3.04 (77)	5,785 (8,610)	1,000 (305)	6,485 (2,940)	78 x 40 x 39

**FOR EXTREME RISK ENVIRONMENTS**

For extreme direct burial or lashed aerial installations, this cable is available with the +M feature. See the "Mechanical Protection (+M) for Extreme Risk Environments" in the "Technical Information" section for more information.

SEALPIC®-84



SPECIFICATIONS

Conductor	Solid annealed copper
Insulation	Solid polyolefin; color coded in accordance with industry standards
Twisted Pairs	Individual insulated conductors are twisted into pairs with varying lay lengths; specific color combinations provide pair identification
≤ 25-Pair Core	Pairs are assembled into a cylindrical core
> 25-Pair Core	Cables larger than 25-pair are assembled into units, which are then used to assemble the core; units are identifiable using color-coded binders
Core Wrap	Non-hygroscopic, dielectric tape
Shield	Corrugated, copolymer coated, 8 mil aluminum tape applied longitudinally with an overlap
Support Member	0.25 inch, 7-strand Extra High Strength (EHS) galvanized steel messenger serves as support member and integral part of the sheath; messenger is flooded
Jacket	Black, polyethylene
Jacket Marking	Identifying information includes a telephone handset, cable code, pair count, AWG, date of manufacture and sequential length markings at 2 foot intervals
Standards Compliance	ANSI/ICEA S-85-625-2011 Formerly PE-38 RoHS-compliant

PRODUCT DESCRIPTION

SEALPIC®-84 Cables have an air core design and are suited for aerial installations. The core and support member (messenger) lay parallel to each other forming a cross-sectional "figure 8." The support messenger is an integral part of the cable sheath, yet readily available for gripping, pulling and tensioning.

APPLICATIONS

- Aerial

FEATURES

- Twisted into pairs with varying lay lengths
- Core wrap
- Fully flooded steel support member
- Black, polyethylene jacket

BENEFITS

- Minimizes crosstalk
- Provides thermal protection
- Inhibits corrosion
- Provides a tough, protective covering designed to withstand exposure to direct sunlight, atmospheric temperature changes and stresses expected in standard installations

ELECTRICAL SPECIFICATIONS

Number of Pairs	Average Mutual Capacitance @ 1,000 Hz nF/mile (nF/km)	Capacitance Unbalance Pair to Pair @ 1 kHz		Capacitance Unbalance Pair to Ground @ 1 kHz	
		Maximum Individual pF @ 1 kft (pF @ 1 km)	Maximum RMS pF @ 1 kft (pF @ 1 km)	Maximum Individual pF @ 1 kft (pF @ 1 km)	Maximum Average pF @ 1 kft (pF @ 1 km)
12 or less	83 ± 7 (52 ± 4)	80 (145)	-	800 (2,625)	-
Over 12	83 ± 4 (52 ± 2)	80 (145)	25 (45)	800 (2,625)	175 (574)

Conductor Size AWG (mm)	Minimum Insulation Resistance @ 68°F (20°C) gigohm-mile (gigohm-km)	Maximum Average Attenuation* 772 kHz @ 68°F (20°C) dB/kft (dB/km)	Maximum Conductor Resistance @ 68°F (20°C) Ohms/sheath mile (km)	DC Resistance Unbalance Maximum %		Dielectric Strength DC Potential - Volts	
				Average	Individual Pair	Conductor to Conductor	Conductor to Shield
19 (0.90)	1.0 (1.6)	3.3 (10.8)	45.0 (28.0)	1.5	5.0	5,000	10,000
22 (0.64)	1.0 (1.6)	4.7 (15.4)	91.0 (56.5)	1.5	5.0	4,000	10,000
24 (0.51)	1.0 (1.6)	5.9 (19.4)	144.0 (89.5)	1.5	5.0	3,000	10,000

*For cables with 12-pair or less, the maximum average attenuation may be increased by 10% over the values shown.

Minimum Near End Crosstalk (NEXT) @ 772 kHz

PSWUNEXT Mean (dB)	47
PSWUNEXT Worst Pair (dB)	42

Minimum Far End Crosstalk (FEXT) @ 772 kHz

Conductor Size (AWG)	19	22	24
PSELFEXT Mean (dB/kft)	51	49	49
PSELFEXT Worst Pair (dB/kft)	45	43	43

PART NUMBERS AND PHYSICAL CHARACTERISTICS

Part Number	Pair Count	AWG (mm)	Nominal Diameter		Approx. Weight lbs/kft (kg/km)	Standard Length ft (m)	Approx. Shipping Weight lbs (kg)	Reel Size F x T x D in
			Cable only in (mm)	With Messenger in (mm)				
01-026-38	6	19 (0.90)	0.47 (12)	0.96 (24)	240 (355)	5,000 (1,524)	1,850 (839)	72 x 36 x 36
01-028-38	12	19 (0.90)	0.56 (14)	1.05 (27)	305 (455)	5,000 (1,524)	1,795 (814)	58 x 25 x 20
01-031-38	25	19 (0.90)	0.74 (19)	1.24 (31)	445 (660)	5,000 (1,524)	2,975 (1,349)	78 x 40 x 39
01-034-38	50	19 (0.90)	1.01 (26)	1.48 (38)	715 (1,065)	5,000 (1,524)	4,395 (1,993)	84 x 40 x 42
01-038-38	100	19 (0.90)	1.36 (35)	1.82 (46)	1,235 (1,840)	2,500 (762)	3,685 (1,671)	72 x 36 x 36
01-057-38	6	22 (0.64)	0.38 (9.7)	0.87 (22)	200 (300)	5,000 (1,524)	1,270 (576)	58 x 25 x 20
01-059-38	12	22 (0.64)	0.45 (11)	0.94 (24)	235 (350)	5,000 (1,524)	1,515 (687)	62 x 30 x 24
01-062-38	25	22 (0.64)	0.59 (15)	1.08 (27)	315 (470)	5,000 (1,524)	2,225 (1,009)	72 x 36 x 36
01-065-38	50	22 (0.64)	0.75 (19)	1.25 (32)	450 (670)	5,000 (1,524)	3,000 (1,361)	78 x 40 x 39
01-069-38	100	22 (0.64)	1.03 (26)	1.50 (38)	725 (1,080)	2,500 (762)	2,100 (952)	62 x 30 x 24
01-073-38	200	22 (0.64)	1.40 (36)	1.86 (47)	1,255 (1,870)	2,500 (762)	3,725 (1,689)	72 x 36 x 36
01-092-38	6	24 (0.51)	0.34 (8.6)	0.83 (21)	185 (275)	5,000 (1,524)	1,115 (506)	46 x 25 x 20
01-094-38	12	24 (0.51)	0.40 (10)	0.89 (23)	210 (315)	5,000 (1,524)	1,280 (580)	52 x 25 x 20
01-097-38	25	24 (0.51)	0.50 (13)	0.99 (25)	260 (385)	5,000 (1,524)	1,595 (723)	58 x 25 x 20
01-100-38	50	24 (0.51)	0.63 (16)	1.12 (28)	350 (520)	5,000 (1,524)	2,065 (937)	62 x 30 x 24
01-104-38	100	24 (0.51)	0.81 (21)	1.31 (33)	515 (765)	5,000 (1,524)	3,275 (1,485)	72 x 36 x 36
01-108-38	200	24 (0.51)	1.14 (29)	1.60 (41)	875 (1,300)	2,500 (762)	2,440 (1,107)	62 x 30 x 24

**TECHNICAL GUIDELINE**

Sag and Tension Technical Guidelines are available for these products.
Refer to the "Resources" section on our site for more information.

SEALPIC®-FSF-84



SPECIFICATIONS

Conductor	Solid annealed copper
Insulation	Dual insulation consisting of an inner layer of foamed, natural polyolefin over which is applied a solid (skin) layer of polyolefin colored in accordance with industry standards
Twisted Pairs	Individual insulated conductors; twisted into pairs with varying lay lengths; specific color combinations provide pair identification
≤ 25-Pair Core	Pairs are assembled into a cylindrical core
> 25-Pair Core	Cables larger than 25-pair are assembled into units, which are then used to assemble the core; units are identifiable using color-coded binders
Filling Compound	80°C ETPR compound, completely filling the interstices between the pairs and under the core wrap
Core Wrap	Non-hygroscopic, dielectric tape
Shield	Corrugated, copolymer coated, 8 mil aluminum tape applied longitudinally with an overlap; flooded shield interfaces
Support Member	0.25 inch, 7-strand Extra High Strength (EHS) galvanized steel messenger serves as support member and integral part of the sheath; messenger is flooded
Jacket	Black, polyethylene
Jacket Marking	Identifying information includes a telephone handset, cable code, pair count, AWG, date of manufacture and sequential length markings at 2 foot intervals
Standards Compliance	SEALPIC-FSF-84 cables meet the physical and electrical requirements of RDUP specification 7 CFR 1755.890 (PE-89), except that the figure 8 sheath shall meet the requirements of ANSI/ICEA S-85-625-2011 Option A RoHS-compliant

PRODUCT DESCRIPTION

SEALPIC®-FSF-84 Cables are suited for aerial applications where a filled cable design is preferred. The core and support member (messenger) lay parallel to each other forming a cross-sectional "figure 8." The support messenger is an integral part of the cable sheath, yet readily available for gripping, pulling and tensioning.

APPLICATIONS

- Aerial

FEATURES

- Twisted into pairs with varying lay lengths
- Core wrap
- Filled core
- Fully flooded shield interfaces
- Fully flooded steel support member
- Black, polyethylene jacket

BENEFITS

- Minimizes crosstalk
- Provides thermal protection
- Moisture resistant
- Inhibits corrosion and water migration
- Inhibits corrosion
- Provides a tough, protective covering designed to withstand exposure to direct sunlight, atmospheric temperature changes and stresses expected in standard installations

ELECTRICAL SPECIFICATIONS

Number of Pairs	Average Mutual Capacitance @ 1,000 Hz nF/mile (nF/km)	Capacitance Unbalance Pair to Pair @ 1 kHz		Capacitance Unbalance Pair to Ground @ 1 kHz	
		Maximum Individual pF @ 1 kft (pF @ 1 km)	Maximum RMS pF @ 1 kft (pF @ 1 km)	Maximum Individual pF @ 1 kft (pF @ 1 km)	Maximum Average pF @ 1 kft (pF @ 1 km)
12 or less	83 ± 7 (52 ± 4)	80 (145)	-	800 (2,625)	-
Over 12	83 ± 4 (52 ± 2)	80 (145)	25 (45)	800 (2,625)	175 (574)

Conductor Size AWG (mm)	Minimum Insulation Resistance @ 68°F (20°C) gigohm-mile (gigohm-km)	Maximum Average Attenuation* 772 kHz @ 68°F (20°C) dB/kft (dB/km)*	Maximum Conductor Resistance @ 68°F (20°C) Ohms/sheath mile (km)	DC Resistance Unbalance Maximum %		Dielectric Strength DC Potential - Volts	
				Average	Individual Pair	Conductor to Conductor	Conductor to Shield
22 (0.64)	1.0 (1.6)	4.5 (14.8)	91.0 (56.5)	1.5	5.0	3,600	10,000
24 (0.51)	1.0 (1.6)	5.6 (18.4)	144.0 (89.5)	1.5	5.0	3,000	10,000

*For cables with 12-pair or less, the maximum average attenuation may be increased by 10% over the values shown.

Minimum Near End Crosstalk (NEXT) @ 772 kHz

PSWUNEXT Mean (dB)	47
PSWUNEXT Worst Pair (dB)	42

Minimum Far End Crosstalk (FEXT) @ 772 kHz

Conductor Size (AWG)	22	24
PSELFEXT Mean (dB/kft)	49	49
PSELFEXT Worst Pair (dB/kft)	43	43

PART NUMBERS AND PHYSICAL CHARACTERISTICS

Part Number	Pair Count	AWG (mm)	Nominal Diameter		Approx. Weight lbs/kft (kg/km)	Standard Length ft (m)	Approx. Shipping Weight lbs (kg)	Reel Size F x T x D in
			Cable only in (mm)	With Messenger in (mm)				
09-057-05	6	22 (0.64)	0.37 (9.4)	0.84 (22)	205 (305)	5,000 (1,524)	1,255 (569)	52 x 25 x 20
09-059-05	12	22 (0.64)	0.46 (12)	0.93 (24)	250 (370)	5,000 (1,524)	1,513 (687)	52 x 25 x 20
09-062-05	25	22 (0.64)	0.59 (15)	1.06 (27)	330 (490)	5,000 (1,524)	1,945 (882)	58 x 25 x 20
09-065-05	50	22 (0.64)	0.75 (19)	1.22 (31)	485 (720)	5,000 (1,524)	2,765 (1,254)	62 x 30 x 24
09-092-05	6	24 (0.51)	0.34 (8.6)	0.83 (21)	185 (275)	5,000 (1,524)	1,115 (506)	46 x 25 x 20
09-094-05	12	24 (0.51)	0.40 (10)	0.89 (23)	210 (315)	5,000 (1,524)	1,280 (580)	52 x 25 x 20
09-097-05	25	24 (0.51)	0.50 (13)	0.99 (25)	260 (385)	5,000 (1,524)	1,595 (723)	58 x 25 x 20
09-100-05	50	24 (0.51)	0.63 (16)	1.12 (28)	350 (520)	5,000 (1,524)	2,065 (937)	62 x 30 x 24
09-104-05	100	24 (0.51)	0.81 (21)	1.31 (33)	515 (765)	5,000 (1,524)	3,275 (1,485)	72 x 36 x 36
09-108-05	200	24 (0.51)	1.14 (29)	1.60 (41)	875 (1,300)	2,500 (762)	2,440 (1,107)	62 x 30 x 24
09-110-05	300	24 (0.51)	1.36 (35)	1.81 (46)	1,200 (1,785)	2,500 (762)	3,585 (1,626)	72 x 36 x 36

**TECHNICAL GUIDELINE**

Sag and Tension Technical Guidelines are available for these products. Refer to the "Resources" section on our site for more information.

SEALPIC®-FSF

RDUP PE-89

**SPECIFICATIONS**

Conductor	Solid annealed copper
Insulation	Dual insulation consisting of an inner layer of foamed, natural polyolefin over which is applied a solid (skin) layer of polyolefin colored in accordance with industry standards
Twisted Pairs	Individual insulated conductors; twisted into pairs with varying lay lengths; specific color combinations provide pair identification
≤ 25-Pair Core	Pairs are assembled into a cylindrical core
> 25-Pair Core	Cables larger than 25-pair are assembled into units, which are then used to assemble the core; units are identifiable using color-coded binders
Filling Compound	80°C ETPR compound, completely filling the interstices between the pairs and under the core wrap
Core Wrap	Non-hygroscopic, dielectric tape applied over the core
Shield	Corrugated, copolymer coated, 8 mil aluminum tape applied longitudinally with an overlap; flooded shield interfaces
Jacket	Black, polyethylene
Jacket Marking	Identifying information includes a telephone handset, cable code, pair count, AWG, date of manufacture and sequential length markings at 2 foot intervals
Standards Compliance	ANSI/ICEA S-84-608-2011 RDUP 7 CFR 1755.890 (PE-89) RoHS-compliant

PRODUCT DESCRIPTION

SEALPIC®-FSF Cables are designed for low risk direct burial or duct applications where protection from moisture is required and aluminum shielding is desired. SEALPIC-FSF may be used aerially, but must be attached to a support strand.

APPLICATIONS

- Low risk direct burial
- Underground conduit
- Lashed aerial

FEATURES

- Twisted into pairs with varying lay lengths
- Core wrap
- Filled core
- Fully flooded shield interfaces
- Black, polyethylene jacket

BENEFITS

- Minimizes crosstalk
- Provides thermal protection
- Moisture resistant
- Inhibits corrosion and water migration
- Provides a tough, protective covering designed to withstand exposure to direct sunlight, atmospheric temperature changes and stresses expected in standard installations

ELECTRICAL SPECIFICATIONS

Number of Pairs	Average Mutual Capacitance @ 1,000 Hz nF/mile (nF/km)	Capacitance Unbalance Pair to Pair @ 1 kHz		Capacitance Unbalance Pair to Ground @ 1 kHz	
		Maximum Individual pF @ 1 kft (pF @ 1 km)	Maximum RMS pF @ 1 kft (pF @ 1 km)	Maximum Individual pF @ 1 kft (pF @ 1 km)	Maximum Average pF @ 1 kft (pF @ 1 km)
12 or less	83 ± 7 (52 ± 4)	80 (145)	-	800 (2,625)	-
Over 12	83 ± 4 (52 ± 2)	80 (145)	25 (45)	800 (2,625)	175 (574)

Conductor Size AWG (mm)	Minimum Insulation Resistance @ 68°F (20°C) gigohm-mile (gigohm-km)	Maximum Average Attenuation* 772 kHz @ 68°F (20°C) dB/kft (dB/km)	Maximum Conductor Resistance @ 68°F (20°C) Ohms/sheath mile (km)	DC Resistance Unbalance Maximum %		Dielectric Strength DC Potential - Volts	
				Average	Individual Pair	Conductor to Conductor	Conductor to Shield
19 (0.90)	1.0 (1.6)	3.2 (10.5)	45.0 (28.0)	1.5	5.0	4,500	10,000
22 (0.64)	1.0 (1.6)	4.5 (14.8)	91.0 (56.5)	1.5	5.0	3,600	10,000
24 (0.51)	1.0 (1.6)	5.6 (18.4)	144.0 (89.5)	1.5	5.0	3,000	10,000
26 (0.40)	1.0 (1.6)	7.0 (23.3)	232.0 (144.0)	1.5	5.0	2,400	10,000

*For cables with 12-pair or less, the maximum average attenuation may be increased by 10% over the values shown.

**Minimum Near End Crosstalk (NEXT)
@ 772 kHz**

PSWUNEXT Mean (dB)	47
PSWUNEXT Worst Pair (dB)	42

**Minimum Far End Crosstalk (FEXT)
@ 772 kHz**

Conductor Size (AWG)	19	22	24	26
PSELFEXT Mean (dB/kft)	51	49	49	47
PSELFEXT Worst Pair (dB/kft)	45	43	43	43

PART NUMBERS AND PHYSICAL CHARACTERISTICS

Part Number	Pair Count	AWG (mm)	Nominal Diameter in (mm)	Approx. Weight lbs/kft (kg/km)	Standard Length ft (m)	Approx. Shipping Weight lbs (kg)	Reel Size F x T x D in
09-026-02	6	19 (0.90)	0.49 (12)	120 (180)	5,000 (1,524)	710 (320)	44 x 18 x 20
09-028-02	12	19 (0.90)	0.59 (15)	190 (285)	5,000 (1,524)	1,115 (505)	46 x 25 x 20
09-031-02	25	19 (0.90)	0.78 (20)	355 (530)	5,000 (1,524)	1,980 (895)	52 x 25 x 20
09-034-02	50	19 (0.90)	1.03 (26)	655 (975)	5,000 (1,524)	3,565 (1,615)	62 x 30 x 24
09-038-02	100	19 (0.90)	1.37 (35)	1,225 (1,825)	2,500 (762)	3,430 (1,555)	65 x 30 x 32
09-057-02	6	22 (0.64)	0.39 (9.9)	70 (105)	5,000 (1,524)	415 (190)	36 x 18 x 14
09-059-02	12	22 (0.64)	0.47 (12)	115 (170)	5,000 (1,524)	685 (310)	44 x 18 x 20
09-062-02	25	22 (0.64)	0.60 (15)	200 (300)	5,000 (1,524)	1,165 (530)	46 x 25 x 20
09-065-02	50	22 (0.64)	0.77 (20)	350 (520)	5,000 (1,524)	1,955 (885)	52 x 25 x 20
09-069-02	100	22 (0.64)	1.02 (26)	650 (965)	5,000 (1,524)	3,540 (1,605)	62 x 30 x 24
09-073-02	200	22 (0.64)	1.38 (35)	1,225 (1,825)	2,500 (762)	3,350 (1,520)	62 x 30 x 24
09-075-02	300	22 (0.64)	1.65 (42)	1,800 (2,680)	1,250 (381)	2,495 (1,130)	58 x 25 x 20
09-077-02	400	22 (0.64)	1.88 (48)	2,365 (3,520)	1,250 (381)	3,245 (1,470)	62 x 30 x 24
09-081-02	600	22 (0.64)	2.28 (58)	3,505 (5,215)	1,250 (381)	4,995 (2,265)	72 x 35 x 36
09-083-02	900	22 (0.64)	2.76 (70)	5,195 (7,730)	1,250 (381)	7,290 (3,305)	84 x 40 x 42
09-085-02	1,200	22 (0.64)	3.14 (80)	6,845 (10,185)	1,250 (381)	9,730 (4,415)	96 x 40 x 48
09-087-02	1,500	22 (0.64)	3.51 (89)	8,520 (12,680)	1,000 (305)	9,695 (4,400)	96 x 40 x 48
09-092-02	6	24 (0.51)	0.36 (9.1)	55 (80)	5,000 (1,524)	320 (145)	36 x 18 x 14
09-094-02	12	24 (0.51)	0.42 (11)	85 (125)	5,000 (1,524)	490 (220)	36 x 18 x 14
09-097-02	25	24 (0.51)	0.52 (13)	140 (210)	5,000 (1,524)	810 (365)	44 x 18 x 20
09-100-02	50	24 (0.51)	0.66 (17)	240 (355)	5,000 (1,524)	1,365 (620)	46 x 25 x 20
09-104-02	100	24 (0.51)	0.85 (22)	430 (640)	5,000 (1,524)	2,395 (1,085)	58 x 25 x 20
09-108-02	200	24 (0.51)	1.14 (29)	810 (1,205)	5,000 (1,524)	4,665 (2,115)	72 x 35 x 36
09-110-02	300	24 (0.51)	1.37 (35)	1,180 (1,755)	2,500 (762)	3,320 (1,505)	65 x 30 x 32
09-112-02	400	24 (0.51)	1.55 (39)	1,545 (2,300)	2,500 (762)	4,475 (2,030)	72 x 35 x 36
09-116-02	600	24 (0.51)	1.88 (48)	2,285 (3,400)	1,250 (381)	3,145 (1,425)	62 x 30 x 24
09-118-02	900	24 (0.51)	2.25 (57)	3,350 (4,985)	1,250 (381)	4,800 (2,180)	72 x 35 x 36
09-120-02	1,200	24 (0.51)	2.57 (65)	4,420 (6,580)	1,250 (381)	6,225 (2,825)	78 x 40 x 39
09-121-02	1,500	24 (0.51)	2.86 (73)	5,490 (8,170)	1,000 (305)	6,190 (2,805)	84 x 40 x 42
09-124-02	1,800	24 (0.51)	3.12 (79)	6,560 (9,765)	1,000 (305)	7,355 (3,335)	84 x 40 x 42
09-125-02	2,100	24 (0.51)	3.40 (86)	7,690 (11,445)	1,000 (305)	8,865 (4,020)	96 x 40 x 48
09-126-02	2,400	24 (0.51)	3.59 (91)	8,695 (12,940)	1,000 (305)	9,870 (4,475)	96 x 40 x 48
09-151-02	600	26 (0.40)	1.49 (38)	1,455 (2,165)	2,500 (762)	4,250 (1,930)	72 x 35 x 36
09-153-02	900	26 (0.40)	1.78 (45)	2,120 (3,155)	1,250 (381)	3,020 (1,370)	65 x 30 x 32
09-155-02	1,200	26 (0.40)	2.03 (52)	2,785 (4,145)	1,250 (381)	4,095 (1,860)	72 x 35 x 36
09-156-02	1,500	26 (0.40)	2.28 (58)	3,480 (5,180)	1,250 (381)	4,965 (2,250)	72 x 35 x 36
09-157-02	1,800	26 (0.40)	2.48 (63)	4,150 (6,175)	1,250 (381)	5,885 (2,670)	78 x 40 x 39
09-159-02	2,400	26 (0.40)	2.86 (73)	5,515 (8,210)	1,250 (381)	8,070 (3,660)	96 x 40 x 48
09-164-02	3,600	26 (0.40)	3.45 (88)	8,165 (12,150)	1,000 (305)	9,340 (4,235)	96 x 40 x 48

**FOR EXTREME RISK ENVIRONMENTS**

For extreme direct burial or lashed aerial installations, this cable is available with the +M feature. See the "Mechanical Protection (+M) for Extreme Risk Environments" in the "Technical Information" section for more information.

CASPIC®-FSF

RDUP PE-89



SPECIFICATIONS

Conductor	Solid Annealed Copper
Insulation	Dual insulation consisting of an inner layer of foamed, natural polyolefin over which is applied a solid (skin) layer of polyolefin colored in accordance with industry standards
Twisted Pairs	Individual insulated conductors; twisted into pairs with varying lay lengths; specific color combinations provide pair identification
≤ 25-Pair Core	Pairs are assembled into a cylindrical core
> 25-Pair Core	Cables larger than 25-pair are assembled into units, which are then used to assemble the core; units are identifiable using color-coded binders
Filling Compound	80°C ETPR compound, completely filling the interstices between the pairs and under the core wrap
Core Wrap	Non-hygroscopic, dielectric tape applied over the core
Inner Shield	Corrugated, copolymer coated, 8 mil aluminum tape applied directly over the core wrap; does not butt or overlap at any point along the length of the cable; flooded shield interface
Outer Shield	Rodent resistant, corrugated, copolymer coated, 6 mil steel tape applied directly over the aluminum and overlaps; flooded shield interface
Jacket	Black, polyethylene
Jacket Marking	Identifying information includes a telephone handset, cable code, pair count, AWG, date of manufacture and sequential length markings at 2 foot intervals
Standards Compliance	ANSI/ICEA S-84-608-2011 RDUP 7 CFR 1755.890 (PE-89) RoHS-compliant

PRODUCT DESCRIPTION

CASPIC®-FSF Cables are designed for direct burial applications. CASPIC-FSF cables are recommended for use in high-risk areas where additional mechanical or rodent protection is required. CASPIC-FSF may be used aerially, but must be attached to a support strand.

APPLICATIONS

- Direct burial where additional mechanical protection is required or desired
- Lashed aerial where additional mechanical protection is required or desired

FEATURES

- Twisted into pairs with varying lay lengths
- Core wrap
- Filled core
- Dual shield design
- Fully flooded shield interfaces
- Black, polyethylene jacket

BENEFITS

- Minimizes crosstalk
- Provides thermal protection
- Moisture resistant
- Rodent resistant
- Inhibits corrosion and water migration
- Provides a tough, protective covering designed to withstand exposure to direct sunlight, atmospheric temperature changes and stresses expected in standard installations

ELECTRICAL SPECIFICATIONS

Number of Pairs	Average Mutual Capacitance @ 1,000 Hz nF/mile (nF/km)	Capacitance Unbalance Pair to Pair @ 1 kHz		Capacitance Unbalance Pair to Ground @ 1 kHz	
		Maximum Individual pF @ 1 kft (pF @ 1 km)	Maximum RMS pF @ 1 kft (pF @ 1 km)	Maximum Individual pF @ 1 kft (pF @ 1 km)	Maximum Average pF @ 1 kft (pF @ 1 km)
12 or less	83 ± 7 (52 ± 4)	80 (145)	-	800 (2,625)	-
Over 12	83 ± 4 (52 ± 2)	80 (145)	25 (45)	800 (2,625)	175 (574)

Conductor Size AWG (mm)	Minimum Insulation Resistance @ 68°F (20°C) gigohm-mile (gigohm-km)	Maximum Average Attenuation* 772 kHz @ 68°F (20°C) dB/kft (dB/km)	Maximum Conductor Resistance @ 68°F (20°C) Ohms/sheath mile (km)	DC Resistance Unbalance Maximum %		Dielectric Strength DC Potential - Volts	
				Average	Individual Pair	Conductor to Conductor	Conductor to Shield
19 (0.90)	1.0 (1.6)	3.2 (10.5)	45.0 (28.0)	1.5	5.0	4,500	10,000
22 (0.64)	1.0 (1.6)	4.5 (14.8)	91.0 (56.5)	1.5	5.0	3,600	10,000
24 (0.51)	1.0 (1.6)	5.6 (18.4)	144.0 (89.5)	1.5	5.0	3,000	10,000

*For cables with 12-pair or less, the maximum average attenuation may be increased by 10% over the values shown.

Minimum Near End Crosstalk (NEXT) @ 772 kHz

PSWUNEXT Mean (dB)	47
PSWUNEXT Worst Pair (dB)	42

Minimum Far End Crosstalk (FEXT) @ 772 kHz

Conductor Size (AWG)	19	22	24
PSELFEXT Mean (dB/kft)	51	49	49
PSELFEXT Worst Pair (dB/kft)	45	43	43

PART NUMBERS AND PHYSICAL CHARACTERISTICS

Part Number	Pair Count	AWG (mm)	Nominal Diameter in (mm)	Approx. Weight lbs/kft (kg/km)	Standard Length ft (m)	Approx. Shipping Weight lbs (kg)	Reel Size F x T x D in
09-031-92	25	19 (0.90)	0.81 (21)	415 (620)	5,000 (1,524)	2,320 (1,050)	58 x 25 x 20
09-034-92	50	19 (0.90)	1.07 (27)	740 (1,100)	5,000 (1,524)	4,315 (1,955)	72 x 35 x 36
09-038-92	100	19 (0.90)	1.41 (36)	1,345 (2,000)	5,000 (1,524)	7,425 (3,370)	78 x 40 x 39
09-057-92	6	22 (0.64)	0.42 (11)	95 (140)	5,000 (1,524)	540 (245)	36 x 18 x 14
09-059-92	12	22 (0.64)	0.50 (13)	150 (225)	5,000 (1,524)	860 (390)	44 x 18 x 20
09-062-92	25	22 (0.64)	0.63 (16)	245 (365)	5,000 (1,524)	1,390 (630)	46 x 25 x 20
09-065-92	50	22 (0.64)	0.80 (20)	410 (610)	5,000 (1,524)	2,295 (1,040)	58 x 25 x 20
09-069-92	100	22 (0.64)	1.05 (27)	730 (1,085)	5,000 (1,524)	4,265 (1,935)	72 x 35 x 36
09-073-92	200	22 (0.64)	1.42 (36)	1,345 (2,000)	2,500 (762)	3,650 (1,655)	62 x 30 x 24
09-075-92	300	22 (0.64)	1.70 (43)	1,945 (2,895)	1,250 (381)	2,720 (1,235)	62 x 30 x 24
09-077-92	400	22 (0.64)	1.92 (49)	2,535 (3,775)	1,250 (381)	3,455 (1,570)	62 x 30 x 24
09-081-92	600	22 (0.64)	2.32 (59)	3,710 (5,520)	1,250 (381)	5,250 (2,380)	72 x 35 x 36
09-083-92	900	22 (0.64)	2.81 (71)	5,455 (8,120)	1,250 (381)	7,615 (3,455)	84 x 40 x 42
09-092-92	6	24 (0.51)	0.39 (9.9)	80 (120)	5,000 (1,524)	465 (210)	36 x 18 x 14
09-094-92	12	24 (0.51)	0.45 (11)	110 (165)	5,000 (1,524)	615 (280)	36 x 18 x 14
09-097-92	25	24 (0.51)	0.55 (14)	180 (270)	5,000 (1,524)	1,065 (485)	46 x 25 x 20
09-100-92	50	24 (0.51)	0.69 (18)	290 (430)	5,000 (1,524)	1,615 (735)	46 x 25 x 20
09-104-92	100	24 (0.51)	0.88 (22)	500 (745)	5,000 (1,524)	2,745 (1,245)	58 x 25 x 20
09-108-92	200	24 (0.51)	1.18 (30)	905 (1,345)	2,500 (762)	2,510 (1,135)	58 x 25 x 20
09-110-92	300	24 (0.51)	1.41 (36)	1,300 (1,935)	2,500 (762)	3,540 (1,605)	62 x 30 x 24
09-112-92	400	24 (0.51)	1.59 (40)	1,680 (2,500)	2,500 (762)	4,815 (2,185)	72 x 35 x 36
09-116-92	600	24 (0.51)	1.92 (49)	2,450 (3,645)	1,250 (381)	3,350 (1,520)	62 x 30 x 24
09-118-92	900	24 (0.51)	2.29 (58)	3,555 (5,290)	1,250 (381)	5,060 (2,295)	72 x 35 x 36
09-120-92	1,200	24 (0.51)	2.62 (67)	4,660 (6,935)	1,250 (381)	6,525 (2,960)	78 x 40 x 39
09-121-92	1,500	24 (0.51)	2.91 (74)	5,755 (8,565)	1,000 (305)	6,455 (2,930)	78 x 40 x 39
09-124-92	1,800	24 (0.51)	3.17 (81)	6,855 (10,200)	1,000 (305)	7,650 (3,470)	84 x 40 x 42
09-125-92	2,100	24 (0.51)	3.45 (88)	8,015 (11,930)	1,000 (305)	9,190 (4,170)	96 x 40 x 48
09-126-92	2,400	24 (0.51)	3.64 (93)	9,035 (13,445)	750 (229)	7,950 (3,605)	96 x 40 x 48



FOR EXTREME RISK ENVIRONMENTS

For extreme direct burial or lashed aerial installations, this cable is available with the +M feature. See the "Mechanical Protection (+M) for Extreme Risk Environments" in the "Technical Information" section for more information.

SEALPIC®-F

RDUP PE-39

**SPECIFICATIONS**

Conductor	Solid annealed copper
Insulation	Solid polyolefin; color coded in accordance with industry standards
Twisted Pairs	Individual insulated conductors; twisted into pairs with varying lay lengths; specific color combinations provide pair identification
≤ 25-Pair Core	Pairs are assembled into a cylindrical core
> 25-Pair Core	Cables larger than 25-pair are assembled into units, which are then used to assemble the core; units are identifiable using color-coded binders
Filling Compound	80°C ETPR compound, completely filling the interstices between the pairs and under the core wrap
Core Wrap	Non-hygroscopic, dielectric tape applied over the core
Shield	Corrugated, copolymer coated, 8 mil aluminum tape applied longitudinally with an overlap; flooded shield interfaces
Jacket	Black, polyethylene
Jacket Marking	Identifying information includes a telephone handset, cable code, pair count, AWG, date of manufacture and sequential length markings at 2 foot intervals
Standards Compliance	ANSI/ICEA S-84-608-2011 RDUP 7 CFR 1755.390 (PE-39) RoHS-compliant

PRODUCT DESCRIPTION

SEALPIC®-F Cables are designed for low risk direct burial or duct applications. SEALPIC-F may be used aerially, but must be attached to a support strand.

APPLICATIONS

- Low risk direct burial
- Underground conduit
- Lashed aerial

FEATURES

- Twisted into pairs with varying lay lengths
- Core wrap
- Filled core
- Fully flooded shield interfaces
- Black, polyethylene jacket

BENEFITS

- Minimizes crosstalk
- Provides thermal protection
- Moisture resistant
- Inhibits corrosion and water migration
- Provides a tough, protective covering designed to withstand exposure to direct sunlight, atmospheric temperature changes and stresses expected in standard installations

ELECTRICAL SPECIFICATIONS

Number of Pairs	Average Mutual Capacitance @ 1,000 Hz nF/mile (nF/km)	Capacitance Unbalance Pair to Pair @ 1 kHz		Capacitance Unbalance Pair to Ground @ 1 kHz	
		Maximum Individual pF @ 1 kft (pF @ 1 km)	Maximum RMS pF @ 1 kft (pF @ 1 km)	Maximum Individual pF @ 1 kft (pF @ 1 km)	Maximum Average pF @ 1 kft (pF @ 1 km)
12 or less	83 ± 7 (52 ± 4)	80 (145)	-	800 (2,625)	-
Over 12	83 ± 4 (52 ± 2)	80 (145)	25 (45)	800 (2,625)	175 (574)

Conductor Size AWG (mm)	Minimum Insulation Resistance @ 68°F (20°C) gigohm-mile (gigohm-km)	Maximum Average Attenuation* 772 kHz @ 68°F (20°C) dB/kft (dB/km)	Maximum Conductor Resistance @ 68°F (20°C) Ohms/sheath mile (km)	DC Resistance Unbalance Maximum %		Dielectric Strength DC Potential - Volts	
				Average	Individual Pair	Conductor to Conductor	Conductor to Shield
19 (0.90)	1.0 (1.6)	2.8 (9.2)	45.0 (28.0)	1.5	5.0	7,000	15,000
22 (0.64)	1.0 (1.6)	4.0 (13.1)	91.0 (56.5)	1.5	5.0	5,000	15,000
24 (0.51)	1.0 (1.6)	5.0 (16.4)	144.0 (89.5)	1.5	5.0	4,000	15,000

*For cables of 12-pair or less, the maximum average attenuation may be increased by 10% over the values shown.

**Minimum Near End Crosstalk (NEXT)
@ 772 kHz**

PSWUNEXT Mean (dB)	47
PSWUNEXT Worst Pair (dB)	42

**Minimum Far End Crosstalk (FEXT)
@ 772 kHz**

Conductor Size (AWG)	19	22	24
PSELFEXT Mean (dB/kft)	51	49	49
PSELFEXT Worst Pair (dB/kft)	45	43	43

PART NUMBERS AND PHYSICAL CHARACTERISTICS

Part Number	Pair Count	AWG (mm)	Nominal Diameter in (mm)	Approx. Weight lbs/kft (kg/km)	Standard Length ft (m)	Approx. Shipping Weight lbs (kg)	Reel Size F x T x D in
04-026-21	6	19 (0.90)	0.54 (14)	140 (210)	5,000 (1,524)	810 (365)	44 x 18 x 20
04-028-21	12	19 (0.90)	0.69 (18)	235 (350)	5,000 (1,524)	1,340 (610)	46 x 25 x 20
04-031-21	25	19 (0.90)	0.92 (23)	440 (655)	5,000 (1,524)	2,570 (1,165)	65 x 30 x 32
04-034-21	50	19 (0.90)	1.22 (31)	810 (1,205)	5,000 (1,524)	4,750 (2,155)	78 x 40 x 39
04-057-21	6	22 (0.64)	0.43 (11)	85 (125)	5,000 (1,524)	490 (220)	36 x 18 x 14
04-059-21	12	22 (0.64)	0.53 (14)	135 (200)	5,000 (1,524)	785 (355)	44 x 18 x 20
04-062-21	25	22 (0.64)	0.68 (17)	240 (355)	5,000 (1,524)	1,365 (620)	46 x 25 x 20
04-065-21	50	22 (0.64)	0.89 (23)	425 (630)	5,000 (1,524)	2,370 (1,075)	58 x 25 x 20
04-069-21	100	22 (0.64)	1.19 (30)	780 (1,160)	5,000 (1,524)	4,515 (2,050)	72 x 35 x 36
04-073-21	200	22 (0.64)	1.63 (41)	1,500 (2,230)	2,500 (762)	4,365 (1,980)	72 x 35 x 36
04-075-21	300	22 (0.64)	1.96 (50)	2,205 (3,280)	2,500 (762)	6,210 (2,820)	78 x 40 x 39
04-077-21	400	22 (0.64)	2.23 (57)	2,890 (4,300)	1,250 (381)	4,225 (1,915)	72 x 35 x 36
04-081-21	600	22 (0.64)	2.72 (69)	4,295 (6,390)	1,250 (381)	6,165 (2,795)	84 x 40 x 42
04-083-21	900	22 (0.64)	3.30 (84)	6,380 (9,495)	1,250 (381)	7,975 (3,615)	96 x 40 x 48
04-092-21	6	24 (0.51)	0.38 (9.7)	60 (90)	5,000 (1,524)	365 (165)	36 x 18 x 14
04-094-21	12	24 (0.51)	0.46 (12)	95 (140)	5,000 (1,524)	585 (265)	44 x 18 x 20
04-097-21	25	24 (0.51)	0.58 (15)	165 (245)	5,000 (1,524)	990 (450)	46 x 25 x 20
04-100-21	50	24 (0.51)	0.74 (19)	285 (425)	5,000 (1,524)	1,630 (740)	52 x 25 x 20
04-104-21	100	24 (0.51)	0.98 (25)	520 (775)	5,000 (1,524)	2,970 (1,345)	65 x 30 x 32
04-108-21	200	24 (0.51)	1.32 (34)	975 (1,450)	5,000 (1,524)	5,575 (2,530)	78 x 40 x 39
04-110-21	300	24 (0.51)	1.58 (40)	1,420 (2,115)	2,500 (762)	4,165 (1,890)	72 x 35 x 36
04-112-21	400	24 (0.51)	1.79 (46)	1,850 (2,755)	2,500 (762)	5,325 (2,415)	78 x 40 x 39
04-116-21	600	24 (0.51)	2.18 (55)	2,745 (4,085)	1,250 (381)	4,045 (1,835)	72 x 35 x 36
04-118-21	900	24 (0.51)	2.63 (67)	4,050 (6,025)	1,250 (381)	5,760 (2,615)	78 x 40 x 39
04-120-21	1,200	24 (0.51)	3.00 (76)	5,325 (7,925)	1,000 (305)	6,025 (2,730)	78 x 40 x 39
04-121-21	1,500	24 (0.51)	3.35 (85)	6,625 (9,860)	1,000 (305)	7,800 (3,540)	96 x 40 x 48
04-124-21	1,800	24 (0.51)	3.73 (95)	7,870 (11,710)	1,000 (305)	9,045 (4,105)	96 x 40 x 48

**FOR EXTREME RISK ENVIRONMENTS**

For extreme direct burial or lashed aerial installations, this cable is available with the +M feature. See the "Mechanical Protection (+M) for Extreme Risk Environments" in the "Technical Information" section for more information.

CUPIC-F®

RDUP PE-39



SPECIFICATIONS

Conductor	Solid annealed copper
Insulation	Solid polyolefin; color coded in accordance with industry standards
Twisted Pairs	Individual insulated conductors; twisted into pairs with varying lay lengths; specific color combinations provide pair identification
≤ 25-Pair Core	Pairs are assembled into a cylindrical core
> 25-Pair Core	Cables larger than 25-pair are assembled into units, which are then used to assemble the core; units are identifiable using color-coded binders
Filling Compound	80°C ETPR compound, completely filling the interstices between the pairs and under the core wrap
Core Wrap	Non-hygroscopic, dielectric tape applied over the core
Shield	Corrugated, 5 mil copper tape is applied longitudinally with an overlap; shield interfaces are flooded
Jacket	Black, polyethylene
Jacket Marking	Identifying information includes a telephone handset, cable code, pair count, AWG, date of manufacture and sequential length markings at 2 foot intervals
Standards Compliance	ANSI/ICEA S-84-608-2011 RDUP 7 CFR 1755.390 (PE-39) RoHS-compliant

PRODUCT DESCRIPTION

CUPIC-F® Cables are designed for use in low risk duct or direct burial applications. CUPIC-F may be used aerially, but must be attached to a support strand.

APPLICATIONS

- Low risk direct burial
- Underground conduit
- Lashed aerial

FEATURES

- Twisted into pairs with varying lay lengths
- Core wrap
- Filled core
- Fully flooded shield interfaces
- Black, polyethylene jacket

BENEFITS

- Minimizes crosstalk
- Provides thermal protection
- Moisture resistant
- Inhibits corrosion and water migration
- Provides a tough, protective covering designed to withstand exposure to direct sunlight, atmospheric temperature changes and stresses expected in standard installations

ELECTRICAL SPECIFICATIONS

Number of Pairs	Average Mutual Capacitance @ 1,000 Hz nF/mile (nF/km)	Capacitance Unbalance Pair to Pair @ 1 kHz		Capacitance Unbalance Pair to Ground @ 1 kHz	
		Maximum Individual pF @ 1 kft (pF @ 1 km)	Maximum RMS pF @ 1 kft (pF @ 1 km)	Maximum Individual pF @ 1 kft (pF @ 1 km)	Maximum Average pF @ 1 kft (pF @ 1 km)
12 or less	83 ± 7 (52 ± 4)	80 (145)	-	800 (2,625)	-
Over 12	83 ± 4 (52 ± 2)	80 (145)	25 (45)	800 (2,625)	175 (574)

Conductor Size AWG (mm)	Minimum Insulation Resistance @ 68°F (20°C) gigohm-mile (gigohm-km)	Maximum Average Attenuation* 772 kHz @ 68°F (20°C) dB/kft (dB/km)	Maximum Conductor Resistance @ 68°F (20°C) Ohms/sheath mile (km)	DC Resistance Unbalance Maximum %		Dielectric Strength DC Potential - Volts	
				Average	Individual Pair	Conductor to Conductor	Conductor to Shield
19 (0.90)	1.0 (1.6)	2.8 (9.2)	45.0 (28.0)	1.5	5.0	7,000	15,000
22 (0.64)	1.0 (1.6)	4.0 (13.1)	91.0 (56.5)	1.5	5.0	5,000	15,000
24 (0.51)	1.0 (1.6)	5.0 (16.4)	144.0 (89.5)	1.5	5.0	4,000	15,000

*For cables of 12-pair or less, the maximum average attenuation may be increased by 10% over the values shown.

Minimum Near End Crosstalk (NEXT) @ 772 kHz

PSWUNEXT Mean (dB)	47
PSWUNEXT Worst Pair (dB)	42

Minimum Far End Crosstalk (FEXT) @ 772 kHz

Conductor Size (AWG)	19	22	24
PSELFEXT Mean (dB/kft)	51	49	49
PSELFEXT Worst Pair (dB/kft)	45	43	43

PART NUMBERS AND PHYSICAL CHARACTERISTICS

Part Number	Pair Count	AWG (mm)	Nominal Diameter in (mm)	Approx. Weight lbs/kft (kg/km)	Standard Length ft (m)	Approx. Shipping Weight lbs (kg)	Reel Size F x T x D in
04-028-04	12	19 (0.90)	0.69 (18)	255 (380)	5,000 (1,524)	1,440 (655)	46 x 25 x 20
04-031-04	25	19 (0.90)	0.92 (23)	470 (700)	5,000 (1,524)	2,720 (1,235)	65 x 30 x 32
04-034-04	50	19 (0.90)	1.22 (31)	845 (1,260)	5,000 (1,524)	4,925 (2,235)	78 x 40 x 39
04-038-04	100	19 (0.90)	1.69 (43)	1,620 (2,410)	2,500 (762)	4,750 (2,155)	78 x 40 x 39
04-057-04	6	22 (0.64)	0.43 (11)	95 (140)	5,000 (1,524)	540 (245)	36 x 18 x 14
04-059-04	12	22 (0.64)	0.53 (14)	145 (215)	5,000 (1,524)	835 (380)	44 x 18 x 20
04-062-04	25	22 (0.64)	0.68 (17)	255 (380)	5,000 (1,524)	1,440 (655)	46 x 25 x 20
04-065-04	50	22 (0.64)	0.89 (23)	450 (670)	5,000 (1,524)	2,495 (1,130)	58 x 25 x 20
04-069-04	100	22 (0.64)	1.19 (30)	815 (1,215)	5,000 (1,524)	4,690 (2,125)	72 x 35 x 36
04-073-04	200	22 (0.64)	1.63 (41)	1,550 (2,305)	2,500 (762)	4,490 (2,035)	72 x 35 x 36
04-075-04	300	22 (0.64)	1.97 (50)	2,270 (3,380)	2,500 (762)	6,375 (2,890)	78 x 40 x 39
04-077-04	400	22 (0.64)	2.23 (57)	2,960 (4,405)	1,250 (381)	4,315 (1,955)	72 x 35 x 36
04-081-04	600	22 (0.64)	2.72 (69)	4,385 (6,525)	1,250 (381)	6,280 (2,850)	84 x 40 x 42
04-092-04	6	24 (0.51)	0.38 (9.7)	70 (105)	5,000 (1,524)	415 (190)	36 x 18 x 14
04-094-04	12	24 (0.51)	0.46 (12)	110 (165)	5,000 (1,524)	660 (300)	44 x 18 x 20
04-097-04	25	24 (0.51)	0.58 (15)	180 (270)	5,000 (1,524)	1,065 (485)	46 x 25 x 20
04-100-04	50	24 (0.51)	0.74 (19)	305 (455)	5,000 (1,524)	1,730 (785)	52 x 25 x 20
04-104-04	100	24 (0.51)	0.98 (25)	550 (820)	5,000 (1,524)	3,120 (1,415)	65 x 30 x 32
04-108-04	200	24 (0.51)	1.32 (34)	1,015 (1,510)	5,000 (1,524)	5,775 (2,620)	78 x 40 x 39
04-110-04	300	24 (0.51)	1.59 (40)	1,470 (2,190)	2,500 (762)	4,290 (1,945)	72 x 35 x 36
04-112-04	400	24 (0.51)	1.79 (46)	1,905 (2,835)	2,500 (762)	5,460 (2,475)	78 x 40 x 39
04-116-04	600	24 (0.51)	2.18 (55)	2,815 (4,190)	1,250 (381)	4,135 (1,875)	72 x 35 x 36
04-118-04	900	24 (0.51)	2.63 (67)	4,135 (6,155)	1,250 (381)	5,870 (2,660)	78 x 40 x 39
04-120-04	1,200	24 (0.51)	3.00 (76)	5,420 (8,065)	1,000 (305)	6,120 (2,775)	78 x 40 x 39
04-121-04	1,500	24 (0.51)	3.35 (85)	6,730 (10,015)	1,000 (305)	7,905 (3,585)	96 x 40 x 48
04-124-04	1,800	24 (0.51)	3.63 (92)	7,990 (11,890)	1,000 (305)	9,165 (4,155)	96 x 40 x 48

**FOR EXTREME RISK ENVIRONMENTS**

For extreme direct burial or lashed aerial installations, this cable is available with the +M feature. See the "Mechanical Protection (+M) for Extreme Risk Environments" in the "Technical Information" section for more information.

GOPIC®-F

RDUP PE-39



SPECIFICATIONS

Conductor	Solid annealed copper
Insulation	Solid polyolefin; color coded in accordance with industry standards
Twisted Pairs	Individual insulated conductors; twisted into pairs with varying lay lengths; specific color combinations provide pair identification
≤ 25-Pair Core	Pairs are assembled into a cylindrical core
> 25-Pair Core	Cables larger than 25-pair are assembled into units, which are then used to assemble the core; units are identifiable using color-coded binders
Filling Compound	80°C ETPR compound, completely filling the interstices between the pairs and under the core wrap
Core Wrap	Non-hygroscopic, dielectric tape applied over the core
Shield	Corrugated, rodent resistant, copper bearing armor applied longitudinally with an overlap; flooded shield interfaces
Jacket	Black, polyethylene
Jacket Marking	Identifying information includes a telephone handset, cable code, pair count, AWG, date of manufacture and sequential length markings at 2 foot intervals
Standards Compliance	ANSI/ICEA S-84-608-2011 RDUP 7 CFR 1755.390 (PE-39) RoHS-compliant

PRODUCT DESCRIPTION

GOPIC®-F Cables are designed for use in direct burial applications where additional mechanical or rodent protection is required. GOPIC-F may be used aerially, but must be attached to a support strand.

APPLICATIONS

- Direct burial where additional mechanical protection is required or desired
- Lashed aerial where additional mechanical protection is required or desired

FEATURES

- Twisted into pairs with varying lay lengths
- Core wrap
- Filled core
- Corrugated, copper bearing armor
- Fully flooded shield interfaces
- Black, polyethylene jacket

BENEFITS

- Minimizes crosstalk
- Provides thermal protection
- Moisture resistant
- Rodent resistant
- Inhibits corrosion and water migration
- Provides a tough, protective covering designed to withstand exposure to direct sunlight, atmospheric temperature changes and stresses expected in standard installations

ELECTRICAL SPECIFICATIONS

Number of Pairs	Average Mutual Capacitance @ 1,000 Hz nF/mile (nF/km)	Capacitance Unbalance Pair to Pair @ 1 kHz		Capacitance Unbalance Pair to Ground @ 1 kHz	
		Maximum Individual pF @ 1 kft (pF @ 1 km)	Maximum RMS pF @ 1 kft (pF @ 1 km)	Maximum Individual pF @ 1 kft (pF @ 1 km)	Maximum Average pF @ 1 kft (pF @ 1 km)
12 or less	83 ± 7 (52 ± 4)	80 (145)	-	800 (2,625)	-
Over 12	83 ± 4 (52 ± 2)	80 (145)	25 (45)	800 (2,625)	175 (574)

Conductor Size AWG (mm)	Minimum Insulation Resistance @ 68°F (20°C) gigohm-mile (gigohm-km)	Maximum Average Attenuation* 772 kHz @ 68°F (20°C) dB/kft (dB/km)	Maximum Conductor Resistance @ 68°F (20°C) Ohms/sheath mile (km)	DC Resistance Unbalance Maximum %		Dielectric Strength DC Potential - Volts	
				Average	Individual Pair	Conductor to Conductor	Conductor to Shield
19 (0.90)	1.0 (1.6)	2.8 (9.2)	45.0 (28.0)	1.5	5.0	7,000	15,000
22 (0.64)	1.0 (1.6)	4.0 (13.1)	91.0 (56.5)	1.5	5.0	5,000	15,000
24 (0.51)	1.0 (1.6)	5.0 (16.4)	144.0 (89.5)	1.5	5.0	4,000	15,000

*For cables of 12-pair or less, the maximum average attenuation may be increased by 10% over the values shown.

Minimum Near End Crosstalk (NEXT) @ 772 kHz

PSWUNEXT Mean (dB)	47
PSWUNEXT Worst Pair (dB)	42

Minimum Far End Crosstalk (FEXT) @ 772 kHz

Conductor Size (AWG)	19	22	24
PSELFEXT Mean (dB/kft)	51	49	49
PSELFEXT Worst Pair (dB/kft)	45	43	43

PART NUMBERS AND PHYSICAL CHARACTERISTICS

Part Number	Pair Count	AWG (mm)	Nominal Diameter in (mm)	Approx. Weight lbs/kft (kg/km)	Standard Length ft (m)	Approx. Shipping Weight lbs (kg)	Reel Size F x T x D in
04-026-27	6	19 (0.90)	0.54 (14)	155 (230)	5,000 (1,524)	885 (400)	44 x 18 x 20
04-028-27	12	19 (0.90)	0.69 (18)	255 (380)	5,000 (1,524)	1,440 (655)	46 x 25 x 20
04-031-27	25	19 (0.90)	0.92 (23)	470 (700)	5,000 (1,524)	2,720 (1,235)	65 x 30 x 32
04-034-27	50	19 (0.90)	1.22 (31)	850 (1,265)	5,000 (1,524)	4,950 (2,245)	78 x 40 x 39
04-038-27	100	19 (0.90)	1.69 (43)	1,620 (2,410)	2,500 (762)	4,665 (2,115)	72 x 35 x 36
04-057-27	6	22 (0.64)	0.43 (11)	95 (140)	5,000 (1,524)	540 (245)	36 x 18 x 14
04-059-27	12	22 (0.64)	0.53 (14)	150 (225)	5,000 (1,524)	860 (390)	44 x 18 x 20
04-062-27	25	22 (0.64)	0.68 (17)	260 (385)	5,000 (1,524)	1,465 (665)	46 x 25 x 20
04-065-27	50	22 (0.64)	0.89 (23)	450 (670)	5,000 (1,524)	2,495 (1,130)	58 x 25 x 20
04-069-27	100	22 (0.64)	1.19 (30)	820 (1,220)	5,000 (1,524)	4,715 (2,140)	72 x 35 x 36
04-073-27	200	22 (0.64)	1.63 (41)	1,555 (2,315)	2,500 (762)	4,500 (2,040)	72 x 35 x 36
04-075-27	300	22 (0.64)	1.96 (50)	2,275 (3,385)	2,500 (762)	6,385 (2,895)	78 x 40 x 39
04-092-27	6	24 (0.51)	0.38 (9.7)	70 (105)	5,000 (1,524)	415 (190)	36 x 18 x 14
04-094-27	12	24 (0.51)	0.46 (12)	110 (165)	5,000 (1,524)	660 (300)	44 x 18 x 20
04-097-27	25	24 (0.51)	0.58 (15)	180 (270)	5,000 (1,524)	1,065 (485)	46 x 25 x 20
04-100-27	50	24 (0.51)	0.74 (19)	310 (460)	5,000 (1,524)	1,755 (795)	52 x 25 x 20
04-104-27	100	24 (0.51)	0.98 (25)	550 (820)	5,000 (1,524)	3,120 (1,415)	65 x 30 x 32
04-108-27	200	24 (0.51)	1.32 (34)	1,020 (1,520)	5,000 (1,524)	5,800 (2,630)	78 x 40 x 39
04-110-27	300	24 (0.51)	1.58 (40)	1,475 (2,195)	2,500 (762)	4,300 (1,950)	72 x 35 x 36
04-112-27	400	24 (0.51)	1.79 (46)	1,910 (2,845)	2,500 (762)	5,475 (2,485)	78 x 40 x 39
04-116-27	600	24 (0.51)	2.18 (55)	2,825 (4,205)	1,250 (381)	4,145 (1,880)	72 x 35 x 36
04-118-27	900	24 (0.51)	2.63 (67)	4,145 (6,170)	1,250 (381)	5,880 (2,665)	78 x 40 x 39
04-120-27	1,200	24 (0.51)	3.00 (76)	5,435 (8,090)	1,000 (305)	6,135 (2,780)	78 x 40 x 39
04-124-27	1,800	24 (0.51)	3.63 (92)	8,005 (11,915)	1,000 (305)	9,180 (4,165)	96 x 40 x 48



FOR EXTREME RISK ENVIRONMENTS

For extreme direct burial or lashed aerial installations, this cable is available with the +M feature. See the "Mechanical Protection (+M) for Extreme Risk Environments" in the "Technical Information" section for more information.

ALPETH

BHBA, BHAA, BKMA and BKTA



SPECIFICATIONS

Conductor	Solid annealed copper
Insulation	Solid polyolefin in distinctive colors to facilitate pair identification
≤ 25-Pair Core	Pairs are combined into a cylindrical core
> 50-Pair Core	Multiples of 25-pair groups are assembled to form the final cable core; each group is identified by color coded non-hygroscopic binders; for 1,200-pair and larger, the color code is a Mirror Image design
Core Wrap	Non-hygroscopic dielectric material protects the core and helps provide core-to-shield dielectric strength
Shield	Corrugated bare 8 mil aluminum tape is applied longitudinally over the core wrap
Jacket	Black polyethylene
Shield/Jacket Options	If extra mechanical protection is desired, an additional outer steel armor and polyethylene jacket (UM) can be requested
Jacket Marking	Manufacturer's identification, pair count, AWG, product identification, sequential footage and a telephone handset printed at 2 foot intervals
Standards Compliance	Telcordia® GR-421-CORE Issue 2 RoHS-compliant

Telcordia is a registered trademark of Ericsson Inc.

PRODUCT DESCRIPTION

ALPETH Cable is a solid insulated, single jacket air core design intended for aerial installations. In this application, the cable must be attached to a support strand (messenger). ALPETH cable is not recommended for any buried or duct application, with or without air pressure.

APPLICATIONS

- Lashed aerial

FEATURES

- Tightly controlled individual conductor dimensions
- Specially designed pair twist lays
- Core wrap
- Bare aluminum tape shield
- Polyethylene jacket

BENEFITS

- Limits resistance unbalance of paired conductors
- Minimizes crosstalk and meets the capacitance unbalance requirements
- Protects core and provides improved mechanical and electrical characteristics
- Assures good electrical contact with non-piercing bonding clamps
- Provides a tough, flexible, protective covering that withstands exposure to sunlight, atmospheric temperatures and stresses expected in standard installations

ELECTRICAL SPECIFICATIONS

Number of Pairs	Average Mutual Capacitance @ 1,000 Hz nF/mile (nF/km)	Capacitance Unbalance Pair to Pair @ 1 kHz		Capacitance Unbalance Pair to Ground @ 1 kHz	
		Maximum Individual pF @ 1 kft (pF @ 1 km)	Maximum RMS pF @ 1 kft (pF @ 1 km)	Maximum Individual pF @ 1 kft (pF @ 1 km)	Maximum Average pF @ 1 kft (pF @ 1 km)
Over 12	83 ± 4 (52 ± 2)	80 (145)	25 (45)	800 (2,625)	175 (574)

Conductor Size AWG (mm)	Minimum Insulation Resistance @ 68°F (20°C) gigohm-mile (gigohm-km)	Maximum Average Attenuation 772 kHz @ 68°F (20°C) dB/kft (dB/km)	Maximum Conductor Resistance @ 68°F (20°C) Ohms/sheath mile (km)	DC Resistance Unbalance Maximum %		Dielectric Strength DC Potential - Volts	
				Average	Individual Pair	Conductor to Conductor	Conductor to Shield
19 (0.90)	1.0 (1.6)	3.3 (10.8)	45 (28.0)	1.5	5.0	5,000	10,000
22 (0.64)	1.0 (1.6)	4.7 (15.4)	91 (56.5)	1.5	5.0	4,000	10,000
24 (0.51)	1.0 (1.6)	5.9 (19.4)	144 (89.5)	1.5	5.0	3,000	10,000
26 (0.40)	1.0 (1.6)	7.4 (24.3)	232 (144.2)	1.5	5.0	2,400	10,000

Minimum Near End Crosstalk (NEXT) @ 772 kHz

PSWUNEXT Mean (dB)	47
PSWUNEXT Worst Pair (dB)	42

Minimum Far End Crosstalk (FEXT) @ 772 kHz

Conductor Size (AWG)	19	22	24	26
PSELFEXT Mean (dB/kft)	51	49	49	47
PSELFEXT Worst Pair (dB/kft)	45	43	43	43

PART NUMBERS AND PHYSICAL CHARACTERISTICS

Part Number	Product Code	Pair Count	AWG (mm)	Nominal Diameter in (mm)	Approx. Weight lbs/kft (kg/km)	Standard Length ft (m)	Approx. Shipping Weight lbs (kg)	Steel Reel Size F x T x D in
20-031-42	BHBA	25	19 (0.90)	0.76 (19)	310 (460)	10,000 (3,048)	3,895 (1,765)	83 x 40 x 42
20-034-42	BHBA	50	19 (0.90)	1.00 (25)	570 (850)	10,000 (3,048)	6,495 (2,945)	83 x 40 x 42
20-038-42	BHBA	100	19 (0.90)	1.34 (34)	1,070 (1,590)	5,000 (1,524)	6,145 (2,785)	83 x 40 x 42
20-042-42	BHBA	200	19 (0.90)	1.85 (47)	2,075 (3,090)	2,500 (762)	5,985 (2,715)	83 x 40 x 42
20-044-42	BHBA	300	19 (0.90)	2.23 (57)	3,065 (4,560)	2,000 (610)	6,925 (3,140)	83 x 40 x 42
20-046-42	BHBA	400	19 (0.90)	2.73 (69)	4,172 (6,215)	1,260 (384)	5,997 (2,723)	83 x 40 x 42
20-062-42	BHAA	25	22 (0.64)	0.60 (15)	180 (270)	15,000 (4,572)	3,495 (1,585)	83 x 40 x 42
20-065-42	BHAA	50	22 (0.64)	0.77 (20)	315 (470)	15,000 (4,572)	5,520 (2,505)	83 x 40 x 42
20-069-42	BHAA	100	22 (0.64)	1.02 (26)	580 (865)	10,000 (3,048)	6,595 (2,990)	83 x 40 x 42
20-073-42	BHAA	200	22 (0.64)	1.38 (35)	1,090 (1,620)	5,000 (1,524)	6,245 (2,835)	83 x 40 x 42
20-075-42	BHAA	300	22 (0.64)	1.66 (42)	1,600 (2,380)	3,300 (1,006)	6,075 (2,755)	83 x 40 x 42
20-077-42	BHAA	400	22 (0.64)	1.89 (48)	2,110 (3,140)	2,500 (762)	6,070 (2,755)	83 x 40 x 42
20-081-42	BHAA	600	22 (0.64)	2.28 (58)	3,115 (4,635)	2,000 (610)	7,025 (3,185)	83 x 40 x 42
20-083-42	BHAA	900	22 (0.64)	2.76 (70)	4,625 (6,885)	1,100 (335)	5,885 (2,670)	83 x 40 x 42
20-097-42	BKMA	25	24 (0.51)	0.51 (13)	125 (185)	20,000 (6,096)	3,295 (1,495)	83 x 40 x 42
20-100-42	BKMA	50	24 (0.51)	0.64 (16)	215 (320)	20,000 (6,096)	5,095 (2,310)	83 x 40 x 42
20-104-42	BKMA	100	24 (0.51)	0.83 (21)	380 (565)	13,300 (4,054)	5,850 (2,655)	83 x 40 x 42
20-108-42	BKMA	200	24 (0.51)	1.12 (28)	710 (1,055)	8,000 (2,438)	6,475 (2,935)	83 x 40 x 42
20-110-42	BKMA	300	24 (0.51)	1.33 (34)	1,035 (1,540)	5,700 (1,737)	6,695 (3,035)	83 x 40 x 42
20-112-42	BKMA	400	24 (0.51)	1.52 (39)	1,355 (2,015)	4,400 (1,341)	6,755 (3,065)	83 x 40 x 42
20-116-42	BKMA	600	24 (0.51)	1.82 (46)	1,995 (2,970)	2,500 (762)	6,980 (3,165)	83 x 40 x 42
20-118-42	BKMA	900	24 (0.51)	2.19 (56)	2,950 (4,390)	1,500 (458)	7,285 (3,305)	83 x 40 x 42
20-120-42	BKMA	1,200	24 (0.51)	2.50 (64)	3,905 (5,810)	1,600 (488)	7,045 (3,195)	83 x 40 x 42
20-121-42	BKMA	1,500	24 (0.51)	2.79 (71)	4,860 (7,235)	1,000 (305)	6,870 (3,115)	83 x 40 x 42
20-124-42	BKMA	1,800	24 (0.51)	3.05 (78)	5,810 (8,645)	1,140 (347)	7,420 (3,365)	83 x 40 x 42
20-145-42	BKTA	300	26 (0.40)	1.07 (27)	675 (1,005)	8,000 (2,438)	6,195 (2,810)	83 x 40 x 42
20-147-42	BKTA	400	26 (0.40)	1.23 (31)	875 (1,300)	6,600 (2,012)	6,570 (2,980)	83 x 40 x 42
20-151-42	BKTA	600	26 (0.40)	1.47 (37)	1,290 (1,920)	5,000 (1,524)	7,245 (3,285)	83 x 40 x 42
20-153-42	BKTA	900	26 (0.40)	1.75 (45)	1,890 (2,815)	3,300 (1,006)	7,030 (3,190)	83 x 40 x 42
20-155-42	BKTA	1,200	26 (0.40)	2.00 (51)	2,495 (3,715)	2,200 (671)	6,285 (2,850)	83 x 40 x 42
20-156-42	BKTA	1,500	26 (0.40)	2.25 (57)	3,100 (4,615)	2,000 (610)	6,995 (3,175)	83 x 40 x 42
20-157-42	BKTA	1,800	26 (0.40)	2.45 (62)	3,695 (5,500)	1,600 (488)	6,705 (3,040)	83 x 40 x 42
20-158-42	BKTA	2,100	26 (0.40)	2.65 (67)	4,305 (6,405)	1,140 (347)	5,705 (2,585)	83 x 40 x 42

PASP

BHBH, BHAH, BKMH and BKTH



PRODUCT DESCRIPTION

PASP Cable is a solid insulated, double jacket, armored air core design intended for use in outside cable plant where a greater risk of physical damage exists. The inner jacket provides protection to the cable core in the event of severe damage to the outer protective sheath.

APPLICATIONS

- Pressurized direct buried installations in harsh environments

FEATURES

- Tightly controlled individual conductor dimensions
- Specially designed pair twist lays
- Core wrap
- Inner polyethylene jacket
- Aluminum tape shield
- Steel tape armor bonded to outer jacket
- Polyethylene jacket

BENEFITS

- Limits resistance unbalance of paired conductors
- Minimizes crosstalk and meets the capacitance unbalance requirements
- Protects the core and provides core-to-shield dielectric strength
- Provides additional protection against mechanical damage and prevents the ingress of moisture
- Assures good electrical contact with non-piercing bonding clamps
- Protects the core from mechanical damage and reduces the possibility of tape buckling during installation, ingress of water to the aluminum shield and of water along the cable between the armor and outer jacket
- Provides a tough, flexible, protective covering that withstands exposure to sunlight, atmospheric temperatures, ground chemicals and stresses expected in standard installations

SPECIFICATIONS

Conductor	Solid annealed copper
Insulation	Conductors are insulated with solid polyolefin in distinctive colors to facilitate pair identification
≤ 25-Pair Core	Pairs are combined into a cylindrical core
> 50-Pair Core	Multiples of 25-pair groups are assembled to form the final cable core; each group is identified by color coded non-hygroscopic binders; for 1,200-pair and larger, the color code is a Mirror Image design
Core Wrap	Non-hygroscopic dielectric material
Inner Jacket	Polyethylene
Shield	Corrugated bare 8 mil aluminum tape applied longitudinally over the inner jacket
Armor	Corrugated, copolymer coated, 6 mil steel tape applied over the aluminum shield; armor is bonded to the outer jacket
Outer Jacket	Black polyethylene
Jacket Marking	Manufacturer's identification, pair count, AWG, product identification, sequential footage and a telephone handset printed at 2 foot intervals
Standards Compliance	Telcordia® GR-421-CORE Issue 2 RoHS-compliant

Telcordia is a registered trademark of Ericsson Inc.

ELECTRICAL SPECIFICATIONS

Number of Pairs	Average Mutual Capacitance @ 1,000 Hz nF/mile (nF/km)	Capacitance Unbalance Pair to Pair @ 1 kHz		Capacitance Unbalance Pair to Ground @ 1 kHz	
		Maximum Individual pF @ 1 kft (pF @ 1 km)	Maximum RMS pF @ 1 kft (pF @ 1 km)	Maximum Individual pF @ 1 kft (pF @ 1 km)	Maximum Average pF @ 1 kft (pF @ 1 km)
Over 12	83 ± 4 (52 ± 2)	80 (145)	25 (45)	800 (2,625)	175 (574)

Conductor Size AWG (mm)	Minimum Insulation Resistance @ 68°F (20°C) gigohm-mile (gigohm-km)	Maximum Average Attenuation 772 kHz @ 68°F (20°C) dB/kft (dB/km)	Maximum Conductor Resistance @ 68°F (20°C) Ohms/sheath mile (km)	DC Resistance Unbalance Maximum %		Dielectric Strength DC Potential - Volts	
				Average	Individual Pair	Conductor to Conductor	Conductor to Shield
19 (0.90)	1.0 (1.6)	3.3 (10.8)	45 (28.0)	1.5	5.0	5,000	20,000
22 (0.64)	1.0 (1.6)	4.7 (15.4)	91 (56.5)	1.5	5.0	4,000	20,000
24 (0.51)	1.0 (1.6)	5.9 (19.4)	144 (89.5)	1.5	5.0	3,000	20,000
26 (0.40)	1.0 (1.6)	7.4 (24.3)	232 (144.2)	1.5	5.0	2,400	20,000

Minimum Near End Crosstalk (NEXT) @ 772 kHz

PSWUNEXT Mean (dB)	47
PSWUNEXT Worst Pair (dB)	42

Minimum Far End Crosstalk (FEXT) @ 772 kHz

Conductor Size (AWG)	19	22	24	26
PSELFEXT Mean (dB/kft)	51	49	49	47
PSELFEXT Worst Pair (dB/kft)	45	43	43	43

PART NUMBERS AND PHYSICAL CHARACTERISTICS

Part Number	Product Code	Pair Count	AWG (mm)	Nominal Diameter in (mm)	Approx. Weight lbs/kft (kg/km)	Standard Length ft (m)	Approx. Shipping Weight lbs (kg)	Steel Reel Size F x T x D in
20-031-05	BHBH	25	19 (0.90)	0.89 (23)	415 (620)	10,000 (3,048)	4,945 (2,245)	83 x 40 x 42
20-034-05	BHBH	50	19 (0.90)	1.13 (29)	705 (1,050)	5,000 (1,524)	4,320 (1,960)	83 x 40 x 42
20-038-05	BHBH	100	19 (0.90)	1.50 (38)	1,280 (1,905)	3,300 (1,006)	5,020 (2,275)	83 x 40 x 42
20-062-05	BHAH	25	22 (0.64)	0.72 (18)	260 (385)	15,000 (4,572)	4,695 (2,130)	83 x 40 x 42
20-065-05	BHAH	50	22 (0.64)	0.90 (23)	425 (630)	10,000 (3,048)	5,045 (2,290)	83 x 40 x 42
20-069-05	BHAH	100	22 (0.64)	1.15 (29)	715 (1,065)	7,500 (2,286)	6,160 (2,795)	83 x 40 x 42
20-073-05	BHAH	200	22 (0.64)	1.54 (39)	1,300 (1,935)	3,750 (1,143)	5,670 (2,570)	83 x 40 x 42
20-075-05	BHAH	300	22 (0.64)	1.83 (47)	1,865 (2,775)	3,300 (1,006)	6,950 (3,150)	83 x 40 x 42
20-077-05	BHAH	400	22 (0.64)	2.05 (52)	2,405 (3,580)	2,000 (610)	5,605 (2,540)	83 x 40 x 42
20-081-05	BHAH	600	22 (0.64)	2.48 (63)	3,515 (5,230)	1,250 (381)	5,190 (2,355)	83 x 40 x 42
20-083-05	BHAH	900	22 (0.64)	2.96 (75)	5,110 (7,605)	1,100 (335)	6,415 (2,910)	83 x 40 x 42
20-097-05	BKMH	25	24 (0.51)	0.63 (16)	195 (290)	20,000 (6,096)	4,695 (2,130)	83 x 40 x 42
20-100-05	BKMH	50	24 (0.51)	0.76 (19)	300 (445)	13,300 (4,054)	4,785 (2,170)	83 x 40 x 42
20-104-05	BKMH	100	24 (0.51)	0.97 (25)	500 (745)	10,000 (3,048)	5,795 (2,630)	83 x 40 x 42
20-108-05	BKMH	200	24 (0.51)	1.24 (32)	860 (1,280)	6,600 (2,012)	6,470 (2,935)	83 x 40 x 42
20-110-05	BKMH	300	24 (0.51)	1.49 (38)	1,240 (1,845)	4,400 (1,341)	6,250 (2,835)	83 x 40 x 42
20-112-05	BKMH	400	24 (0.51)	1.68 (43)	1,595 (2,375)	3,300 (1,006)	6,060 (2,750)	83 x 40 x 42
20-116-05	BKMH	600	24 (0.51)	1.99 (51)	2,290 (3,410)	2,500 (762)	6,520 (2,955)	83 x 40 x 42
20-118-05	BKMH	900	24 (0.51)	2.38 (61)	3,335 (4,965)	1,600 (488)	6,130 (2,780)	83 x 40 x 42
20-120-05	BKMH	1,200	24 (0.51)	2.72 (69)	4,355 (6,480)	1,100 (335)	5,585 (2,535)	83 x 40 x 42
20-121-05	BKMH	1,500	24 (0.51)	2.99 (76)	5,350 (7,960)	1,100 (335)	6,680 (3,030)	83 x 40 x 42
20-124-05	BKMH	1,800	24 (0.51)	3.25 (83)	6,340 (9,435)	800 (244)	5,865 (2,660)	83 x 40 x 42
20-145-05	BKTH	300	26 (0.40)	1.20 (31)	820 (1,220)	6,600 (2,012)	6,205 (2,815)	83 x 40 x 42
20-147-05	BKTH	400	26 (0.40)	1.40 (36)	1,075 (1,600)	5,000 (1,524)	6,170 (2,800)	83 x 40 x 42
20-151-05	BKTH	600	26 (0.40)	1.64 (42)	1,520 (2,260)	3,300 (1,006)	5,810 (2,635)	83 x 40 x 42
20-153-05	BKTH	900	26 (0.40)	1.93 (49)	2,175 (3,235)	2,600 (792)	6,450 (2,925)	83 x 40 x 42
20-155-05	BKTH	1,200	26 (0.40)	2.20 (56)	2,845 (4,235)	2,200 (671)	7,055 (3,200)	83 x 40 x 42
20-156-05	BKTH	1,500	26 (0.40)	2.45 (62)	3,490 (5,195)	1,600 (488)	6,380 (2,895)	83 x 40 x 42
20-157-05	BKTH	1,800	26 (0.40)	2.66 (68)	4,135 (6,155)	1,300 (396)	6,170 (2,800)	83 x 40 x 42
20-158-05	BKTH	2,100	26 (0.40)	2.85 (72)	4,770 (7,100)	1,140 (347)	6,235 (2,825)	83 x 40 x 42
20-159-05	BKTH	2,400	26 (0.40)	3.05 (80)	5,465 (8,141)	1,100 (335)	7,012 (3,183)	83 x 40 x 42
20-161-05	BKTH	2,700	26 (0.40)	3.18 (81)	6,015 (8,950)	1,140 (347)	7,650 (3,470)	83 x 40 x 42

Self-Support

BHAS and BKMS



PRODUCT DESCRIPTION

Self-Support Cable is a solid insulated, single jacket air core design with a built-in support member intended specifically for aerial applications. The undulated, shielded core is laid parallel to a flooded steel support member and jacketed in an integral extrusion to form a “figure 8” configuration. The supporting member is an integral part of the cable sheath yet readily available for gripping, pulling and tensioning. Installation is fast and easy using standard methods and hardware.

APPLICATIONS

- Aerial

FEATURES

- Tightly controlled individual conductor dimensions
- Specially designed pair twist lays
- Undulated core assembly
- Core wrap
- Fully flooded steel support member
- Polyethylene jacket

BENEFITS

- Limits resistance unbalance of paired conductors
- Minimizes crosstalk and meets the capacitance unbalance requirements
- Eliminates strain on the conductors and provides sufficient slack during installation
- Protects the core and helps provide core-to-shield dielectric strength
- Provides corrosion protection
- Provides tough, flexible, protective covering that withstands exposure to sunlight, atmospheric temperatures and stresses expected in standard installations

SPECIFICATIONS

Conductor	Solid annealed copper
Insulation	Solid polyolefin in distinctive colors to facilitate pair identification
≤ 25-Pair Core	Pairs are combined into a cylindrical core
> 50-Pair Core	Multiples of 25-pair groups are assembled to form the final cable core; each group is identified by color coded non-hygroscopic binders
Core Wrap	Non-hygroscopic dielectric material
Shield	Corrugated, 8 mil coated aluminum tape applied longitudinally over the core wrap
Support Member	0.25 inch, 7-strand Extra High-Strength (EHS) galvanized steel member, fully flooded, serves as the support member and is an integral part of the sheath
Jacket	Black polyethylene
Jacket Marking	Manufacturer's identification, pair count, AWG, product identification, sequential footage and a telephone handset printed at 2 foot intervals
Standards Compliance	Telcordia® GR-421-CORE Issue 2 RoHS-compliant

Telcordia is a registered trademark of Ericsson Inc.

ELECTRICAL SPECIFICATIONS

Number of Pairs	Average Mutual Capacitance @ 1,000 Hz nF/mile (nF/km)	Capacitance Unbalance Pair to Pair @ 1 kHz		Capacitance Unbalance Pair to Ground @ 1 kHz	
		Maximum Individual pF @ 1 kft (pF @ 1 km)	Maximum RMS pF @ 1 kft (pF @ 1 km)	Maximum Individual pF @ 1 kft (pF @ 1 km)	Maximum Average pF @ 1 kft (pF @ 1 km)
Over 12	83 + 4, - 5 (52 + 2, - 3)	80 (145)	25 (45)	800 (2,625)	175 (574)

Conductor Size AWG (mm)	Minimum Insulation Resistance @ 68°F (20°C) gigohm-mile (gigohm-km)	Maximum Average Attenuation 772 kHz @ 68°F (20°C) dB/kft (dB/km)	Maximum Conductor Resistance @ 68°F (20°C) Ohms/sheath mile (km)	DC Resistance Unbalance Maximum %		Dielectric Strength DC Potential - Volts	
				Average	Individual Pair	Conductor to Conductor	Conductor to Shield
22 (0.64)	1.0 (1.6)	4.7 (15.4)	91 (56.5)	1.5	5.0	4,000	10,000
24 (0.51)	1.0 (1.6)	5.9 (19.4)	144 (89.5)	1.5	5.0	3,000	10,000

Minimum Near End Crosstalk (NEXT) @ 772 kHz		Minimum Far End Crosstalk (FEXT) @ 772 kHz	
PSWUNEXT Mean (dB)	47	Conductor Size (AWG)	22
PSWUNEXT Worst Pair (dB)	42	PSELFEXT Mean (dB/kft)	49
		PSELFEXT Worst Pair (dB/kft)	43

PART NUMBERS AND PHYSICAL CHARACTERISTICS

Part Number	Product Code	Pair Count	AWG (mm)	Nominal Diameter		Approx. Weight lbs/kft (kg/km)	Standard Length ft (m)	Approx. Shipping Weight lbs (kg)	Steel Reel Size F x T x D in
				Cable only in (mm)	W/Messenger in (mm)				
20-062-43	BHAS	25	22 (0.64)	0.58 (15)	1.05 (27)	310 (461)	10,000 (3,048)	3,895 (1,766)	83 x 40 x 42
20-065-43	BHAS	50	22 (0.64)	0.74 (19)	1.20 (31)	445 (662)	7,500 (2,286)	4,135 (1,875)	83 x 40 x 42
20-069-43	BHAS	100	22 (0.64)	1.00 (25)	1.47 (37)	705 (1,049)	6,000 (1,829)	5,025 (2,279)	83 x 40 x 42
20-097-43	BKMS	25	24 (0.51)	0.49 (12)	0.96 (24)	260 (387)	13,300 (4,054)	4,255 (1,930)	83 x 40 x 42
20-100-43	BKMS	50	24 (0.51)	0.62 (16)	1.09 (28)	345 (513)	13,300 (4,054)	5,385 (2,442)	83 x 40 x 42
20-104-43	BKMS	100	24 (0.51)	0.80 (20)	1.27 (32)	515 (766)	8,000 (2,438)	4,915 (2,229)	83 x 40 x 42
20-108-43	BKMS	200	24 (0.51)	1.09 (28)	1.56 (40)	840 (1,250)	5,000 (1,524)	4,995 (2,265)	83 x 40 x 42

Reinforced Self-Support

BHAP, BKMP and BKTP

PRODUCT DESCRIPTION

Reinforced Self-Support Cable is a solid insulated, double jacket, armored, self-supporting air core design intended for aerial installations where hazards from squirrel attack, tree limb abrasion or lightning exist. The undulated, shielded, jacketed core is covered with a flooded steel armor, laid parallel to a flooded steel support member and jacketed in an integral extrusion to form a "figure 8" configuration. The steel strand member is readily available for gripping, pulling and tensioning using standard methods and hardware.

APPLICATIONS

- Aerial installations in harsh environments

FEATURES

- Tightly controlled individual conductor dimensions
- Specially designed pair twist lays
- Undulated core assembly
- Core wrap
- Inner polyethylene jacket
- Flooded steel support member
- Polyethylene jacket

BENEFITS

- Limits resistance unbalance of paired conductors
- Minimizes crosstalk and meets the capacitance unbalance requirements
- Eliminates strain on the conductors and provides sufficient slack during installation
- Protects the core and helps provide core-to-shield dielectric strength
- Provides additional protection against mechanic damage and prevents the ingress of moisture
- Provides corrosion protection
- Provides tough, flexible, protective covering that withstands exposure to sunlight, atmospheric temperatures and stresses



SPECIFICATIONS

Conductor	Solid annealed copper
Insulation	Solid polyolefin in distinctive colors to facilitate pair identification
≤ 25-Pair Core	Pairs are combined into a cylindrical core
> 50-Pair Core	Multiples of 25-pair groups are assembled to form the final cable core; each group is identified by color coded non-hygroscopic binders
Core Wrap	Non-hygroscopic dielectric material
Shield	Corrugated, 8 mil aluminum tape is applied longitudinally over the core wrap
Inner Jacket	Polyethylene helps protect the core and shield against mechanical damage and ingress of moisture
Armor	Corrugated bare 6 mil steel tape is applied longitudinally over the inner jacket and the inner and outer surfaces of the steel are flooded
Support Member	0.25 inch, 7-strand Extra High-Strength (EHS) galvanized steel member, fully flooded, serves as the support member and is an integral part of the sheath
Outer Jacket	Black polyethylene
Jacket Marking	Manufacturer's identification, pair count, AWG, product identification, sequential footage and a telephone handset printed at 2 foot intervals
Standards Compliance	Telcordia® GR-421-CORE Issue 2 RoHS-compliant

Telcordia is a registered trademark of Ericsson Inc.

ELECTRICAL SPECIFICATIONS

Number of Pairs	Average Mutual Capacitance @ 1,000 Hz nF/mile (nF/km)	Capacitance Unbalance Pair to Pair @ 1 kHz		Capacitance Unbalance Pair to Ground @ 1 kHz	
		Maximum Individual pF @ 1 kft (pF @ 1 km)	Maximum RMS pF @ 1 kft (pF @ 1 km)	Maximum Individual pF @ 1 kft (pF @ 1 km)	Maximum Average pF @ 1 kft (pF @ 1 km)
Over 12	83 + 4, - 5 (52 ± 2, - 3)	80 (145)	25 (45)	800 (2,625)	175 (574)

Conductor Size AWG (mm)	Minimum Insulation Resistance @ 68°F (20°C) gigohm-mile (gigohm-km)	Maximum Average Attenuation 772 kHz @ 68°F (20°C) dB/kft (dB/km)	Maximum Conductor Resistance @ 68°F (20°C) Ohms/sheath mile (km)	DC Resistance Unbalance Maximum %		Dielectric Strength DC Potential - Volts	
				Average	Individual Pair	Conductor to Conductor	Conductor to Shield
22 (0.64)	1.0 (1.6)	4.7 (15.4)	91 (56.5)	1.5	5.0	4,000	10,000
24 (0.51)	1.0 (1.6)	5.9 (19.4)	144 (89.5)	1.5	5.0	3,000	10,000
26 (0.40)	1.0 (1.6)	7.4 (24.3)	232 (144.2)	1.5	5.0	2,400	10,000

Minimum Near End Crosstalk (NEXT) @ 772 kHz		Minimum Far End Crosstalk (FEXT) @ 772 kHz		
PSWUNEXT Mean (dB)	47	Conductor Size (AWG)	22	26
PSWUNEXT Worst Pair (dB)	42	PSELFEXT Mean (dB/kft)	49	47
		PSELFEXT Worst Pair (dB/kft)	43	43

PART NUMBERS AND PHYSICAL CHARACTERISTICS

Part Number	Product Code	Pair Count	AWG (mm)	Nominal Diameter		Approx. Weight lbs/kft (kg/km)	Standard Length ft (m)	Approx. Shipping Weight lbs (kg)	Steel Reel Size F x T x D in
				Cable only in (mm)	W/Messenger in (mm)				
20-062-20	BHAP	25	22 (0.64)	0.87 (22)	1.33 (34)	455 (675)	10,000 (3,048)	4,200 (1,905)	83 x 40 x 42
20-065-20	BHAP	50	22 (0.64)	1.05 (27)	1.51 (38)	625 (930)	7,500 (2,286)	4,465 (2,025)	83 x 40 x 42
20-069-20	BHAP	100	22 (0.64)	1.30 (33)	1.76 (45)	940 (1,400)	5,000 (1,524)	4,475 (2,029)	83 x 40 x 42
20-097-20	BKMP	25	24 (0.51)	0.83 (21)	1.29 (33)	400 (595)	10,000 (3,048)	4,345 (1,971)	83 x 40 x 42
20-100-20	BKMP	50	24 (0.51)	0.94 (24)	1.40 (36)	510 (760)	10,000 (3,048)	5,445 (2,469)	83 x 40 x 42
20-104-20	BKMP	100	24 (0.51)	1.13 (29)	1.59 (40)	715 (1,065)	5,000 (1,524)	4,145 (1,880)	83 x 40 x 42
20-108-20	BKMP	200	24 (0.51)	1.42 (36)	1.88 (48)	1,120 (1,665)	4,000 (1,220)	4,995 (2,265)	83 x 40 x 42
20-145-20	BKTP	300	26 (0.40)	1.35 (34)	1.81 (46)	1,045 (1,555)	3,300 (1,010)	4,110 (1,864)	83 x 40 x 42

Bonded STALPETH

DCAZ, DCMZ and DCTZ



PRODUCT DESCRIPTION

Bonded STALPETH Cable is a foam skin insulated, single jacket, armored air core design intended for use in ducts to provide more efficient duct utilization than standard PIC designs.

APPLICATIONS

- Congested underground duct systems

FEATURES

- Tightly controlled individual conductor dimensions
- Specially designed pair twist lays
- Core wrap
- Aluminum tape shield
- Steel tape armor bonded to outer jacket
- Polyethylene jacket

BENEFITS

- Limits resistance unbalance of paired conductors
- Minimizes crosstalk and meets the capacitance unbalance requirements
- Protects the core and helps provide core-to-shield dielectric strength
- Assures good electrical contact with non-piercing bonding clamps
- Protects the core from mechanical damage and reduces the possibility of tape buckling during installation, ingress of water to the aluminum shield and of water along the cable between the armor and outer jacket
- Provides a tough, flexible, protective covering that withstands exposure to sunlight, atmospheric temperatures, ground chemicals and stresses expected in standard installations

SPECIFICATIONS

Conductor	Solid annealed copper
Insulation	Conductors are dual insulated with an inner layer of foamed, natural polyolefin covered by an outer layer of solid, colored polyolefin; conductor insulation is color coded in accordance with industry standard
≥ 50-Pair Core	Multiples of 25-pair groups are assembled to form the final cable core; each group is identified by color coded non-hygroscopic binders; for 1,200-pair and larger, the color code is Mirror Image design
Core Wrap	Non-hygroscopic dielectric material
Shield	Corrugated bare 8 mil aluminum tape applied longitudinally over the core wrap
Armor	Corrugated, copolymer coated, 6 mil steel tape applied over the aluminum shield and bonded to the outer jacket
Jacket	Black polyethylene
Jacket Marking	Manufacturer's identification, pair count, AWG, product identification and a telephone handset printed at 2 foot intervals; sequential footage markings are printed at alternate 2 foot intervals
Standards Compliance	Telcordia® GR-421-CORE Issue 2 RoHS-compliant

Telcordia is a registered trademark of Ericsson Inc.

ELECTRICAL SPECIFICATIONS

Number of Pairs	Average Mutual Capacitance @ 1,000 Hz nF/mile (nF/km)	Capacitance Unbalance Pair to Pair @ 1 kHz		Capacitance Unbalance Pair to Ground @ 1 kHz	
		Maximum Individual pF @ 1 kft (pF @ 1 km)	Maximum RMS pF @ 1 kft (pF @ 1 km)	Maximum Individual pF @ 1 kft (pF @ 1 km)	Maximum Average pF @ 1 kft (pF @ 1 km)
All pairs	83 ± 4 (52 ± 2)	80 (145)	25 (45)	800 (2,625)	175 (574)

Conductor Size AWG (mm)	Minimum Insulation Resistance @ 68°F (20°C) gigohm-mile (gigohm-km)	Maximum Average Attenuation 772 kHz @ 68°F (20°C) dB/kft (dB/km)	Maximum Conductor Resistance @ 68°F (20°C) Ohms/sheath mile (km)	DC Resistance Unbalance Maximum %		Dielectric Strength DC Potential - Volts	
				Average	Individual Pair	Conductor to Conductor	Conductor to Shield
22 (0.64)	1.0 (1.6)	5.0 (16.4)	91 (56.5)	1.5	5.0	1,400	5,000
24 (0.51)	1.0 (1.6)	6.3 (20.7)	144 (89.5)	1.5	5.0	1,200	5,000
26 (0.40)	1.0 (1.6)	7.9 (25.9)	232 (144.2)	1.5	5.0	1,000	5,000

Minimum Near End Crosstalk (NEXT) @ 772 kHz

PSWUNEXT Mean (dB)	47
PSWUNEXT Worst Pair (dB)	42

Minimum Far End Crosstalk (FEXT) @ 772 kHz

Conductor Size (AWG)	22	24	26
PSELFEXT Mean (dB/kft)	49	49	47
PSELFEXT Worst Pair (dB/kft)	43	43	43

PART NUMBERS AND PHYSICAL CHARACTERISTICS

Part Number	Product Code	Pair Count	AWG (mm)	Nominal Diameter in (mm)	Approx. Weight lbs/kft (kg/km)	Standard Length ft (m)	Approx. Shipping Weight lbs (kg)	Steel Reel Size F x T x D in
19-083-01	DCAZ	900	22 (0.64)	2.49 (63)	4,375 (6,510)	1,600 (488)	7,795 (3,535)	83 x 40 x 42
19-085-01	DCAZ	1,200	22 (0.64)	2.85 (72)	5,770 (8,585)	1,200 (366)	7,720 (3,500)	83 x 40 x 42
19-116-01	DCMZ	600	24 (0.51)	1.70 (43)	1,960 (2,915)	3,900 (1,189)	8,440 (3,830)	83 x 40 x 42
19-118-01	DCMZ	900	24 (0.51)	2.02 (51)	2,860 (4,255)	1,500 (458)	8,275 (3,755)	83 x 40 x 42
19-120-01	DCMZ	1,200	24 (0.51)	2.30 (58)	3,755 (5,590)	2,000 (610)	8,305 (3,765)	83 x 40 x 42
19-121-01	DCMZ	1,500	24 (0.51)	2.57 (65)	4,660 (6,935)	1,600 (488)	8,250 (3,745)	83 x 40 x 42
19-124-01	DCMZ	1,800	24 (0.51)	2.81 (71)	5,545 (8,250)	1,250 (381)	7,725 (3,505)	83 x 40 x 42
19-125-01	DCMZ	2,100	24 (0.51)	3.04 (77)	6,440 (9,585)	1,150 (351)	8,200 (3,720)	83 x 40 x 42
19-126-01	DCMZ	2,400	24 (0.51)	3.22 (82)	7,320 (10,895)	876 (267)	7,205 (3,270)	83 x 40 x 42
19-151-01	DCTZ	600	26 (0.40)	1.38 (35)	1,285 (1,910)	5,700 (1,737)	8,120 (3,685)	83 x 40 x 42
19-153-01	DCTZ	900	26 (0.40)	1.62 (41)	1,850 (2,755)	3,900 (1,189)	8,010 (3,635)	83 x 40 x 42
19-155-01	DCTZ	1,200	26 (0.40)	1.84 (47)	2,420 (3,600)	3,200 (975)	8,540 (3,875)	83 x 40 x 42
19-156-01	DCTZ	1,500	26 (0.40)	2.08 (53)	2,995 (4,455)	2,500 (762)	8,285 (3,755)	83 x 40 x 42
19-157-01	DCTZ	1,800	26 (0.40)	2.26 (57)	3,560 (5,300)	2,080 (634)	8,200 (3,720)	83 x 40 x 42
19-158-01	DCTZ	2,100	26 (0.40)	2.41 (61)	4,115 (6,125)	1,250 (381)	5,940 (2,695)	83 x 40 x 42
19-159-01	DCTZ	2,400	26 (0.40)	2.58 (66)	4,685 (6,970)	1,600 (488)	8,290 (3,760)	83 x 40 x 42
19-161-01	DCTZ	2,700	26 (0.40)	2.71 (69)	5,240 (7,800)	1,250 (381)	7,345 (3,330)	83 x 40 x 42
19-162-01	DCTZ	3,000	26 (0.40)	2.86 (73)	5,800 (8,630)	1,200 (366)	7,755 (3,520)	83 x 40 x 42
19-164-01	DCTZ	3,600	26 (0.40)	3.03 (77)	6,885 (10,245)	1,150 (351)	8,715 (3,950)	83 x 40 x 42
19-167-01	DCTZ	4,200	26 (0.40)	3.26 (83)	7,995 (11,900)	900 (274)	7,990 (3,625)	83 x 40 x 42

STEAMPETH

DKTN



PRODUCT DESCRIPTION

STEAMPETH Cable is a solid insulated, single jacket, armored air core design intended for use in underground systems where a high incidence of damage could occur if steam enters the duct. The cable is designed for application in high temperature environments up to 230°F (110°C).

APPLICATIONS

- Steam tunnels

FEATURES

- Solid polypropylene insulation
- Tightly controlled individual conductor dimensions
- Specially designed pair twist lays
- Core wrap
- Aluminum tape shield
- Steel armor bonded to the outer jacket
- Polyethylene jacket

BENEFITS

- Provides higher temperature rating
- Limits resistance unbalance of paired conductors
- Minimizes crosstalk and meets the capacitance unbalance requirements
- Protects core and helps provide core-to-shield dielectric strength
- Assures good electrical contact with non-piercing bonding clamps
- Protects the core from mechanical damage and reduces possibility of tape buckling during installation, ingress of water to the shield and seepage of water along the cable between the armor and outer jacket
- Provides a tough, flexible, protective covering that withstands exposure to sunlight, above-normal temperatures, ground chemicals and stresses expected during installation

SPECIFICATIONS

Conductor	Solid annealed copper
Insulation	Solid polypropylene insulation; standard color codes are used for pair identification
Core Assembly	Multiples of 25-pair groups are assembled to form the final cable core; each group is identified by color coded non-hygroscopic binders; for 1,200-pair and larger, color coding is Mirror Image
Core Wrap	Non-hygroscopic dielectric material
Shield	Corrugated bare 8 mil aluminum tape applied longitudinally over the core wrap
Armor	Corrugated, copolymer coated, 6 mil steel tape applied over the aluminum shield and bonded to the outer jacket
Jacket	Black, medium density polyethylene
Jacket Marking	Manufacturer's identification, pair count, AWG, product identification, a telephone handset and sequential footage markings are printed at 2 foot intervals.
Standards Compliance	Telcordia® GR-110-CORE

Telcordia is a registered trademark of Ericsson Inc.

ELECTRICAL SPECIFICATIONS

Number of Pairs	Average Mutual Capacitance @ 1,000 Hz nF/mile (nF/km)	Capacitance Unbalance Pair to Pair @ 1 kHz		Capacitance Unbalance Pair to Ground @ 1 kHz	
		Maximum Individual pF @ 1 kft (pF @ 1 km)	Maximum RMS pF @ 1 kft (pF @ 1 km)	Maximum Individual pF @ 1 kft (pF @ 1 km)	Maximum Average pF @ 1 kft (pF @ 1 km)
All pairs	83 ± 4 (52 ± 2)	80 (145)	25 (45)	800 (2,625)	175 (574)

Conductor Size AWG (mm)	Minimum Insulation Resistance @ 68°F (20°C) gigohm-mile (gigohm-km)	Maximum Average Attenuation 772 kHz @ 68°F (20°C) dB/kft (dB/km)	Maximum Conductor Resistance @ 68°F (20°C) Ohms/sheath mile (km)	DC Resistance Unbalance Maximum %		Dielectric Strength DC Potential - Volts	
				Average	Individual Pair	Conductor to Conductor	Conductor to Shield
26 (0.40)	1.0 (1.6)	7.4 (24.3)	232 (144.2)	1.5	5.0	2,400	10,000

	Minimum Near End Crosstalk (NEXT)	
	@ 150 kHz	@ 772 kHz
PSWUNEXT Mean (dB)	58	47
PSWUNEXT Worst Pair (dB)	53	42

	Minimum Far End Crosstalk	
	@ 150 kHz	@ 772 kHz
PSELFEXT Mean (dB/kft)	61	47
PSELFEXT Worst Pair (dB/kft)	57	43

PART NUMBERS AND PHYSICAL CHARACTERISTICS

Part Number	Product Code	Pair Count	AWG (mm)	Nominal Diameter in (mm)	Approx. Weight lbs/kft (kg/km)	Standard Length ft (m)	Approx. Shipping Weight lbs (kg)	Steel Reel Size F x T x D in
27-145-19	DKTN	300	26 (0.40)	1.11 (28)	750 (1,115)	8,600 (2,621)	7,245 (3,285)	83 x 40 x 42
27-151-19	DKTN	600	26 (0.40)	1.51 (38)	1,395 (2,075)	4,800 (1,463)	7,490 (3,400)	83 x 40 x 42
27-153-19	DKTN	900	26 (0.40)	1.79 (46)	2,015 (3,000)	3,300 (1,006)	7,445 (3,375)	83 x 40 x 42
27-155-19	DKTN	1,200	26 (0.40)	2.04 (52)	2,635 (3,920)	2,120 (646)	6,380 (2,895)	83 x 40 x 42
27-157-19	DKTN	1,800	26 (0.40)	2.50 (64)	3,885 (5,780)	1,650 (503)	7,205 (3,270)	83 x 40 x 42
27-159-19	DKTN	2,400	26 (0.40)	2.87 (73)	5,110 (7,605)	1,250 (381)	7,185 (3,260)	83 x 40 x 42

Power Station High Potential Filled ASP

CMAW

PRODUCT DESCRIPTION

High Potential Filled ASP Cable with solid insulation is a single jacket, filled, armored design intended for applications associated with power substations. This cable provides exceptional durability and resistance to moisture. The finished cable meets all standard electrical requirements plus a 20 kV high voltage test between the conductors and the shield.

APPLICATIONS

- Power sub stations

FEATURES

- Tightly controlled individual conductor dimensions
- Specially designed pair twist lays
- Core wrap
- Inner and outer surfaces of both aluminum tape and steel tape are flooded with an adhesive compound
- Polyethylene jacket

BENEFITS

- Limits resistance unbalance of paired conductors
- Minimizes crosstalk and meets the capacitance unbalance requirements
- Protects core and provides improved mechanical and electrical characteristics
- Provides a moisture barrier and inhibits corrosion
- Provides a tough, flexible, protective covering that withstands exposure to sunlight, above-normal temperatures, ground chemicals and stresses expected during installation



SPECIFICATIONS

Conductor	Solid annealed copper
Insulation	Color coded solid high dielectric insulation; standard color codes are used for pair identification.
25-Pair Core	Pairs are combined into a cylindrical core
≥ 50-Pair Core	Multiples of 25-pair groups are assembled to form the final cable core; each group is identified by color-coded non-hygroscopic binders
Filling Compound	Entire core assembly is filled with 80°C ETPR compound, filling the air space between the insulated conductors
Core Wrap	Dielectric tape applied over the core
Shields	Corrugated bare 8 mil aluminum tape covered by a corrugated bare 6 mil steel tape applied longitudinally over the core wrap
Jacket	Black polyethylene
Jacket Marking	Manufacturer's ID, pair count, AWG, product ID and telephone handset printed every 2 foot; sequential footage marking printed at 2 foot intervals
Standards Compliance	Telcordia® GR-421-CORE Issue 2 RoHS-compliant

Telcordia is a registered trademark of Ericsson Inc.

ELECTRICAL SPECIFICATIONS

Number of Pairs	Average Mutual Capacitance @ 1,000 Hz nF/mile (nF/km)	Capacitance Unbalance Pair to Pair @ 1 kHz		Capacitance Unbalance Pair to Ground @ 1 kHz	
		Maximum Individual pF @ 1 kft (pF @ 1 km)	Maximum RMS pF @ 1 kft (pF @ 1 km)	Maximum Individual pF @ 1 kft (pF @ 1 km)	Maximum Average pF @ 1 kft (pF @ 1 km)
All pairs	83 ± 4 (52 ± 2)	80 (145)	25 (45)	800 (2,625)	175 (574)

Conductor Size AWG (mm)	Minimum Insulation Resistance @ 68°F (20°C) gigohm-mile (gigohm-km)	Maximum Average Attenuation 772 kHz @ 68°F (20°C) dB/kft (dB/km)	Maximum Conductor Resistance @ 68°F (20°C) Ohms/sheath mile (km)	DC Resistance Unbalance Maximum %		Dielectric Strength DC Potential - Volts	
				Average	Individual Pair	Conductor to Conductor	Conductor to Shield
22 (0.64)	1.0 (1.6)	4.0 (13.1)	91 (56.5)	1.5	5.0	5,000	20,000

Minimum Near End Crosstalk (NEXT) @ 772 kHz		Minimum Far End Crosstalk (FEXT) @ 772 kHz	
PSWUNEXT Mean (dB)	47	PSELFEXT Mean (dB/kft)	49
PSWUNEXT Worst Pair (dB)	42	PSELFEXT Worst Pair (dB/kft)	43

PART NUMBERS AND PHYSICAL CHARACTERISTICS

Part Number	Pair Count	Nominal Diameter in (mm)	Approx. Weight lbs/kft (kg/km)	Standard Length ft (m)	Approx. Shipping Weight lbs (kg)	Steel Reel Size F x T x D in
21-062-48	25	0.71 (18)	285 (425)	10,000 (3,048)	3,645 (1,655)	83 x 40 x 42
21-065-48	50	0.93 (24)	495 (735)	10,000 (3,048)	5,745 (2,605)	83 x 40 x 42

Filled ALPETH

ANBA, ANAA, ANMA and ANTA



SPECIFICATIONS

Conductor	Solid annealed copper
Insulation	Conductors are dual insulated with an inner layer of foamed, natural polyolefin covered by an outer layer of solid, colored polyolefin; conductor insulation is color coded in accordance with industry standard
25-Pair Core	Pairs are combined into a cylindrical core
≥ 50-Pair Core	Multiples of 25-pair groups are assembled to form the final cable core; each group is identified by color coded non-hygroscopic binders; for 1,200-pair and larger, the color code is a Mirror Image design
Filling Compound	Entire core assembly is filled with an 80°C ETPR compound, filling the air space between the insulated conductors
Core Wrap	Dielectric tape applied over the core
Shield	Corrugated bare 8 mil aluminum tape is applied longitudinally over the core wrap; inner and outer surfaces of the aluminum shield are flooded
Jacket	Black, polyethylene
Jacket Marking	Manufacturer's identification, pair count, AWG, product identification, sequential footage and a telephone handset printed at 2 foot intervals
Standards Compliance	Telcordia® GR-421-CORE Issue 2 RoHS-compliant

Telcordia is a registered trademark of Ericsson Inc.

PRODUCT DESCRIPTION

Filled ALPETH Cable with foam skin insulation is a single jacket, filled design intended for direct burial application. An ETPR compound completely coats each insulated conductor and fills the air space between conductors. The shielding and jacketing combined with the filling and flooding compounds throughout the cable provide exceptional durability and resistance to moisture.

APPLICATIONS

- Direct burial and underground conduit

FEATURES

- Tightly controlled individual conductor dimensions
- Specially designed pair twist lays
- Core wrap
- Polyethylene jacket

BENEFITS

- Limits resistance unbalance of paired conductors
- Minimizes crosstalk and meets the capacitance unbalance requirements
- Protects core and provides improved mechanical and electrical characteristics
- Provides a tough, flexible, protective covering that withstands exposure to sunlight, atmospheric temperatures, ground chemicals and stresses expected in standard installation

ELECTRICAL SPECIFICATIONS

Number of Pairs	Average Mutual Capacitance @ 1,000 Hz nF/mile (nF/km)	Capacitance Unbalance Pair to Pair @ 1 kHz		Capacitance Unbalance Pair to Ground @ 1 kHz	
		Maximum Individual pF @ 1 kft (pF @ 1 km)	Maximum RMS pF @ 1 kft (pF @ 1 km)	Maximum Individual pF @ 1 kft (pF @ 1 km)	Maximum Average pF @ 1 kft (pF @ 1 km)
Over 12	83 ± 4 (52 ± 2)	80 (145)	25 (45)	800 (2,625)	175 (574)

Conductor Size AWG (mm)	Minimum Insulation Resistance @ 68°F (20°C) gigohm-mile (gigohm-km)	Maximum Average Attenuation 772 kHz @ 68°F (20°C) dB/kft (dB/km)	Maximum Conductor Resistance @ 68°F (20°C) Ohms/sheath mile (km)	DC Resistance Unbalance Maximum %		Dielectric Strength DC Potential - Volts	
				Average	Individual Pair	Conductor to Conductor	Conductor to Shield
19 (0.90)	1.0 (1.6)	3.2 (10.5)	45 (28.0)	1.5	5.0	4,500	10,000
22 (0.64)	1.0 (1.6)	4.5 (14.8)	91 (56.5)	1.5	5.0	3,600	10,000
24 (0.51)	1.0 (1.6)	5.6 (18.4)	144 (89.5)	1.5	5.0	3,000	10,000
26 (0.40)	1.0 (1.6)	7.0 (23.0)	232 (144.2)	1.5	5.0	2,400	10,000

Minimum Near End Crosstalk (NEXT) @ 772 kHz

PSWUNEXT Mean (dB)	47
PSWUNEXT Worst Pair (dB)	42

Minimum Far End Crosstalk (FEXT) @ 772 kHz

Conductor Size (AWG)	19	22	24	26
PSELFEXT Mean (dB/kft)	51	49	49	47
PSELFEXT Worst Pair (dB/kft)	45	43	43	43

PART NUMBERS AND PHYSICAL CHARACTERISTICS

Part Number	Product Code	Pair Count	AWG (mm)	Nominal Diameter in (mm)	Approx. Weight lbs/kft (kg/km)	Standard Length ft (m)	Approx. Shipping Weight lbs (kg)	Steel Reel Size F x T x D in
09-031-77	ANBA	25	19 (0.90)	0.78 (20)	355 (530)	10,000 (3,048)	4,345 (1,970)	83 x 40 x 42
09-034-77	ANBA	50	19 (0.90)	1.03 (26)	655 (975)	5,000 (1,524)	4,070 (1,845)	83 x 40 x 42
09-038-77	ANBA	100	19 (0.90)	1.37 (35)	1,225 (1,825)	3,300 (1,006)	4,840 (2,195)	83 x 40 x 42
09-062-77	ANAA	25	22 (0.64)	0.60 (15)	200 (300)	15,000 (4,572)	3,795 (1,720)	83 x 40 x 42
09-065-77	ANAA	50	22 (0.64)	0.77 (20)	350 (520)	15,000 (4,572)	6,045 (2,740)	83 x 40 x 42
09-069-77	ANAA	100	22 (0.64)	1.02 (26)	645 (960)	7,500 (2,286)	5,635 (2,555)	83 x 40 x 42
09-073-77	ANAA	200	22 (0.64)	1.38 (35)	1,225 (1,825)	5,000 (1,524)	6,920 (3,140)	83 x 40 x 42
09-075-77	ANAA	300	22 (0.64)	1.65 (42)	1,800 (2,680)	3,300 (1,006)	6,735 (3,055)	83 x 40 x 42
09-077-77	ANAA	400	22 (0.64)	1.88 (48)	2,365 (3,520)	2,500 (762)	6,710 (3,045)	83 x 40 x 42
09-081-77	ANAA	600	22 (0.64)	2.28 (58)	3,500 (5,210)	1,650 (503)	6,570 (2,980)	83 x 40 x 42
09-083-77	ANAA	900	22 (0.64)	2.76 (70)	5,190 (7,725)	1,000 (305)	5,985 (2,715)	83 x 40 x 42
09-097-77	ANMA	25	24 (0.51)	0.52 (13)	140 (210)	20,000 (6,096)	3,595 (1,630)	83 x 40 x 42
09-100-77	ANMA	50	24 (0.51)	0.66 (17)	240 (355)	20,000 (6,096)	5,595 (2,540)	83 x 40 x 42
09-104-77	ANMA	100	24 (0.51)	0.85 (22)	430 (640)	10,000 (3,048)	5,095 (2,310)	83 x 40 x 42
09-108-77	ANMA	200	24 (0.51)	1.14 (29)	810 (1,205)	5,000 (1,524)	4,845 (2,200)	83 x 40 x 42
09-110-77	ANMA	300	24 (0.51)	1.37 (35)	1,180 (1,755)	5,000 (1,524)	6,695 (3,035)	83 x 40 x 42
09-112-77	ANMA	400	24 (0.51)	1.55 (39)	1,545 (2,300)	4,000 (1,219)	6,975 (3,165)	83 x 40 x 42
09-116-77	ANMA	600	24 (0.51)	1.88 (48)	2,285 (3,400)	2,500 (762)	6,510 (2,950)	83 x 40 x 42
09-118-77	ANMA	900	24 (0.51)	2.25 (57)	3,345 (4,980)	1,650 (503)	6,315 (2,865)	83 x 40 x 42
09-120-77	ANMA	1,200	24 (0.51)	2.58 (66)	4,430 (6,595)	1,250 (381)	6,335 (2,870)	83 x 40 x 42
09-121-77	ANMA	1,500	24 (0.51)	2.87 (73)	5,510 (8,200)	1,000 (305)	6,305 (2,860)	83 x 40 x 42
09-124-77	ANMA	1,800	24 (0.51)	3.13 (80)	6,590 (9,805)	840 (256)	6,330 (2,870)	83 x 40 x 42
09-125-77	ANMA	2,100	24 (0.51)	3.40 (86)	7,725 (11,495)	750 (229)	6,590 (2,990)	83 x 40 x 42
09-145-77	ANTA	300	26 (0.40)	1.09 (28)	755 (1,125)	6,000 (1,829)	5,325 (2,415)	83 x 40 x 42
09-147-77	ANTA	400	26 (0.40)	1.25 (32)	995 (1,480)	5,000 (1,524)	5,770 (2,615)	83 x 40 x 42
09-151-77	ANTA	600	26 (0.40)	1.49 (38)	1,450 (2,160)	3,300 (1,006)	5,580 (2,530)	83 x 40 x 42
09-153-77	ANTA	900	26 (0.40)	1.78 (45)	2,120 (3,155)	2,500 (762)	6,095 (2,765)	83 x 40 x 42
09-155-77	ANTA	1,200	26 (0.40)	2.03 (52)	2,790 (4,150)	2,000 (610)	6,375 (2,890)	83 x 40 x 42
09-156-77	ANTA	1,500	26 (0.40)	2.28 (58)	3,490 (5,195)	1,300 (396)	5,330 (2,420)	83 x 40 x 42
09-157-77	ANTA	1,800	26 (0.40)	2.49 (63)	4,165 (6,200)	1,250 (381)	6,000 (2,720)	83 x 40 x 42
09-158-77	ANTA	2,100	26 (0.40)	2.69 (68)	4,870 (7,250)	1,200 (366)	6,640 (3,010)	83 x 40 x 42
09-159-77	ANTA	2,400	26 (0.40)	2.86 (73)	5,535 (8,235)	1,000 (305)	6,330 (2,870)	83 x 40 x 42

Filled ASP

ANBW, ANAW, ANMW and ANTW



SPECIFICATIONS

Conductor	Solid annealed copper
Insulation	Conductors are dual insulated with an inner layer of foamed, natural polyolefin covered by an outer layer of solid, colored polyolefin; conductor insulation is color coded in accordance with industry standard
25-Pair Core	Pairs are combined into a cylindrical core
≥ 50-Pair Core	Multiples of 25-pair groups are assembled to form the final cable core; each group is identified by color coded non-hygroscopic binders; for 1,200-pair and larger, the color code is a Mirror Image design
Filling Compound	Core assembly is completely filled with an 80°C ETPR compound, filling the air space between the insulated conductors
Core Wrap	Dielectric tape applied over the core
Shields	Corrugated bare 8 mil aluminum tape covered by a corrugated bare 6 mil steel tape applied longitudinally over the core wrap
Jacket	Black, polyethylene
Jacket Marking	Manufacturer's identification, pair count, AWG, product identification, sequential footage and a telephone handset printed at 2 foot intervals
Standards Compliance	Telcordia® GR-421-CORE Issue 2 RoHS-compliant

Telcordia is a registered trademark of Ericsson Inc.

PRODUCT DESCRIPTION

FILLED ASP Cable with foam skin insulation is a single jacket, armored, filled design intended for direct burial applications in high risk areas. An ETPR compound completely coats each insulated conductor and fills the air space between conductors. The shielding, armoring and jacketing combined with the filling and flooding compounds throughout the cable, provide exceptional durability and resistance to moisture.

APPLICATIONS

- Direct burial

FEATURES

- Tightly controlled individual conductor dimensions
- Specially designed pair twist lays
- Inner and outer surfaces of both aluminum tape and steel tape are flooded
- Core wrap
- Polyethylene jacket

BENEFITS

- Limits resistance unbalance of paired conductors
- Minimizes crosstalk and meets the capacitance unbalance requirements
- Provides a barrier to moisture and inhibits corrosion
- Protects core and provides improved mechanical and electrical characteristics
- Provides a tough, flexible, protective covering that withstands exposure to sunlight, atmospheric temperatures, ground chemicals and stresses expected in standard installation

ELECTRICAL SPECIFICATIONS

Number of Pairs	Average Mutual Capacitance @ 1,000 Hz nF/mile (nF/km)	Capacitance Unbalance Pair to Pair @ 1 kHz		Capacitance Unbalance Pair to Ground @ 1 kHz	
		Maximum Individual pF @ 1 kft (pF @ 1 km)	Maximum RMS pF @ 1 kft (pF @ 1 km)	Maximum Individual pF @ 1 kft (pF @ 1 km)	Maximum Average pF @ 1 kft (pF @ 1 km)
Over 12	83 ± 4 (52 ± 2)	80 (145)	25 (45)	800 (2,625)	175 (574)

Conductor Size AWG (mm)	Minimum Insulation Resistance @ 68°F (20°C) gigohm-mile (gigohm-km)	Maximum Average Attenuation 772 kHz @ 68°F (20°C) dB/kft (dB/km)	Maximum Conductor Resistance @ 68°F (20°C) Ohms/sheath mile (km)	DC Resistance Unbalance Maximum %		Dielectric Strength DC Potential - Volts	
				Average	Individual Pair	Conductor to Conductor	Conductor to Shield
19 (0.90)	1.0 (1.6)	3.2 (10.5)	45 (28.0)	1.5	5.0	4,500	10,000
22 (0.64)	1.0 (1.6)	4.5 (14.8)	91 (56.5)	1.5	5.0	3,600	10,000
24 (0.51)	1.0 (1.6)	5.6 (18.4)	144 (89.5)	1.5	5.0	3,000	10,000
26 (0.40)	1.0 (1.6)	7.0 (23.0)	232 (144.2)	1.5	5.0	2,400	10,000

Minimum Near End Crosstalk (NEXT) @ 772 kHz

PSWUNEXT Mean (dB)	47
PSWUNEXT Worst Pair (dB)	42

Minimum Far End Crosstalk (FEXT) @ 772 kHz

Conductor Size (AWG)	19	22	24	26
PSELFEXT Mean (dB/kft)	51	49	49	47
PSELFEXT Worst Pair (dB/kft)	45	43	43	43

PART NUMBERS AND PHYSICAL CHARACTERISTICS

Part Number	Product Code	Pair Count	AWG (mm)	Nominal Diameter in (mm)	Approx. Weight lbs/kft (kg/km)	Standard Length ft (m)	Approx. Shipping Weight lbs (kg)	Steel Reel Size F x T x D in
22-031-83	ANBW	25	19 (0.90)	0.81 (21)	410 (610)	10,000 (3,048)	4,895 (2,220)	83 x 40 x 42
22-034-83	ANBW	50	19 (0.90)	1.07 (27)	735 (1,095)	5,000 (1,524)	4,470 (2,030)	83 x 40 x 42
22-038-83	ANBW	100	19 (0.90)	1.41 (36)	1,340 (1,995)	5,000 (1,524)	7,495 (3,400)	83 x 40 x 42
22-042-83	ANBW	200	19 (0.90)	1.96 (50)	2,570 (3,825)	2,000 (610)	5,935 (2,690)	83 x 40 x 42
22-044-83	ANBW	300	19 (0.90)	2.35 (60)	3,740 (5,565)	1,650 (503)	6,965 (3,160)	83 x 40 x 42
22-062-83	ANAW	25	22 (0.64)	0.63 (16)	240 (355)	18,000 (5,486)	5,115 (2,320)	83 x 40 x 42
22-065-83	ANAW	50	22 (0.64)	0.80 (20)	405 (605)	15,000 (4,572)	6,870 (3,115)	83 x 40 x 42
22-069-83	ANAW	100	22 (0.64)	1.05 (27)	730 (1,085)	7,500 (2,286)	6,270 (2,845)	83 x 40 x 42
22-073-83	ANAW	200	22 (0.64)	1.42 (36)	1,340 (1,995)	5,000 (1,524)	7,495 (3,400)	83 x 40 x 42
22-075-83	ANAW	300	22 (0.64)	1.69 (43)	1,940 (2,885)	3,300 (1,006)	7,195 (3,265)	83 x 40 x 42
22-077-83	ANAW	400	22 (0.64)	1.92 (49)	2,530 (3,765)	2,500 (762)	7,120 (3,230)	83 x 40 x 42
22-081-83	ANAW	600	22 (0.64)	2.32 (59)	3,705 (5,515)	1,650 (503)	6,910 (3,135)	83 x 40 x 42
22-083-83	ANAW	900	22 (0.64)	2.81 (71)	5,445 (8,105)	1,100 (335)	6,785 (3,075)	83 x 40 x 42
22-085-83	ANAW	1,200	22 (0.64)	3.20 (81)	7,160 (10,655)	834 (254)	6,765 (3,070)	83 x 40 x 42
22-097-83	ANMW	25	24 (0.51)	0.55 (14)	175 (260)	20,000 (6,096)	4,295 (1,950)	83 x 40 x 42
22-100-83	ANMW	50	24 (0.51)	0.69 (18)	290 (430)	20,000 (6,096)	6,595 (2,990)	83 x 40 x 42
22-104-83	ANMW	100	24 (0.51)	0.88 (22)	500 (745)	13,300 (4,054)	7,445 (3,375)	83 x 40 x 42
22-108-83	ANMW	200	24 (0.51)	1.18 (30)	900 (1,340)	6,600 (2,012)	6,735 (3,055)	83 x 40 x 42
22-110-83	ANMW	300	24 (0.51)	1.41 (36)	1,295 (1,925)	5,000 (1,524)	7,270 (3,300)	83 x 40 x 42
22-112-83	ANMW	400	24 (0.51)	1.59 (40)	1,680 (2,500)	4,000 (1,219)	7,515 (3,410)	83 x 40 x 42
22-116-83	ANMW	600	24 (0.51)	1.92 (49)	2,445 (3,640)	2,500 (762)	6,910 (3,135)	83 x 40 x 42
22-118-83	ANMW	900	24 (0.51)	2.29 (58)	3,545 (5,275)	2,000 (610)	7,885 (3,575)	83 x 40 x 42
22-120-83	ANMW	1,200	24 (0.51)	2.63 (67)	4,670 (6,950)	1,250 (381)	6,635 (3,010)	83 x 40 x 42
22-121-83	ANMW	1,500	24 (0.51)	2.92 (74)	5,775 (8,595)	1,000 (305)	6,570 (2,980)	83 x 40 x 42
22-124-83	ANMW	1,800	24 (0.51)	3.18 (81)	6,880 (10,240)	950 (290)	7,330 (3,325)	83 x 40 x 42
22-125-83	ANMW	2,100	24 (0.51)	3.45 (88)	8,045 (11,975)	940 (287)	8,960 (4,065)	83 x 40 x 42
22-145-83	ANTW	300	26 (0.40)	1.13 (29)	840 (1,250)	6,000 (1,829)	5,835 (2,645)	83 x 40 x 42
22-147-83	ANTW	400	26 (0.40)	1.29 (33)	1,100 (1,635)	6,000 (1,829)	7,395 (3,355)	83 x 40 x 42
22-151-83	ANTW	600	26 (0.40)	1.53 (39)	1,580 (2,350)	4,000 (1,219)	7,115 (3,225)	83 x 40 x 42
22-153-83	ANTW	900	26 (0.40)	1.83 (47)	2,275 (3,385)	2,500 (762)	6,485 (2,940)	83 x 40 x 42
22-155-83	ANTW	1,200	26 (0.40)	2.07 (53)	2,965 (4,415)	2,000 (610)	6,725 (3,050)	83 x 40 x 42
22-156-83	ANTW	1,500	26 (0.40)	2.33 (59)	3,695 (5,500)	1,600 (488)	6,705 (3,040)	83 x 40 x 42
22-157-83	ANTW	1,800	26 (0.40)	2.54 (65)	4,400 (6,550)	1,250 (381)	6,295 (2,855)	83 x 40 x 42
22-158-83	ANTW	2,100	26 (0.40)	2.74 (70)	5,120 (7,620)	1,200 (366)	6,940 (3,150)	83 x 40 x 42
22-159-83	ANTW	2,400	26 (0.40)	2.91 (74)	5,805 (8,640)	1,000 (305)	6,600 (2,995)	83 x 40 x 42
22-161-83	ANTW	2,700	26 (0.40)	3.08 (78)	6,485 (9,650)	740 (226)	5,595 (2,535)	83 x 40 x 42
22-162-83	ANTW	3,000	26 (0.40)	3.24 (82)	7,185 (10,695)	750 (229)	6,185 (2,805)	83 x 40 x 42

Your Strategic Partner for **Communication** Product Needs



10Gain® XP
CAT 6A
CMR/CMP



2 mm
Microarray
Breakout
OFNP

COMMUNICATION
PRODUCT
HIGHLIGHTS

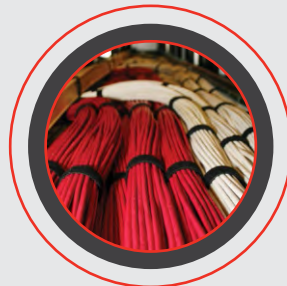

FTTA Hybrid
Assemblies

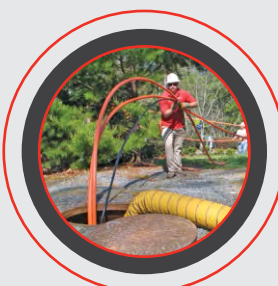

DAS Hybrid
Fiber + Copper

MARKETS

Commercial | Education | Government | Healthcare
Industrial/Manufacturing | Technology | Transportation | Utility



SUPERIOR
ESSEX

800.551.8948
SuperiorEssex.com

All information, content, data, specifications, packaging and part numbers detailed herein are subject to change. For the most up-to-date information, please visit SuperiorEssex.com. Purchase of this product is subject exclusively to the then current Superior Essex International LP Terms and Conditions of Sale for Communications and Energy Cable, Wire and Connectivity Products, which can be found on our website, SuperiorEssex.com, or provided to you upon request.

PRODUCT DESCRIPTION

T-SCREEN® Filled ASP Cable with foam skin insulation is a single jacket, armored, filled design intended for direct burial applications in high risk areas. An ETPR compound completely coats each insulated conductor and fills the air space between conductors. An internal separator screen provides two core compartments for use in TIC PCM applications. The shielding, armor and jacketing combined with the filling and flooding compounds throughout the cable, provide exceptional durability and resistance to moisture.

APPLICATIONS

- Bidirectional, T Carrier digital systems in direct buried installations

FEATURES

- Core wrap
- Internal screen
- Flooded inner and outer surfaces of both tape shields
- Polyethylene jacket

BENEFITS

- Protects core and provides improved mechanical and electrical characteristics
- Separates bidirectional conductors to transmit and receive T1 pairs
- Provides a moisture barrier and inhibits corrosion
- Provides a tough, flexible, protective covering that withstands exposure to sunlight, atmospheric temperatures, ground chemicals and stresses of standard installations



SPECIFICATIONS

Conductor	Solid annealed copper
Insulation	Conductors are dual insulated with an inner layer of foamed, natural polyolefin covered by an outer coating of solid, colored polyolefin; conductor insulation is color coded in accordance with industry standard
Core Assembly	Twisted pairs assembled and equally placed on either side of the T-SCREEN, dividing the core into two electrically isolated compartments
Core Wrap	Dielectric tape applied over the core
Screen	Coated 4-mil aluminum tape to separate the cable into two halves
Shields	Corrugated bare 8-mil aluminum tape covered by a corrugated bare 6 mil steel tape applied longitudinally over the core wrap; inner and outer surfaces of the aluminum shield and steel tape are flooded
Jacket	Black polyethylene
Jacket Marking	Manufacturer's ID, pair count, AWG, product ID, sequential footage and a telephone handset printed at 2-foot intervals
Standards Compliance	Telcordia® GR-421-CORE Issue 2 RoHS-compliant

Telcordia is a registered trademark of Ericsson Inc.

ELECTRICAL SPECIFICATIONS

Number of Pairs	Average Mutual Capacitance @ 1,000 Hz nF/mile (nF/km)	Capacitance Unbalance Pair to Pair @ 1 kHz		Capacitance Unbalance Pair to Ground @ 1 kHz	
		Maximum Individual pF @ 1 kft (pF @ 1 km)	Maximum RMS pF @ 1 kft (pF @ 1 km)	Maximum Individual pF @ 1 kft (pF @ 1 km)	Maximum Average pF @ 1 kft (pF @ 1 km)
All pairs	83 ± 4 (52 ± 2)	80 (145)	25 (45)	800 (2,625)	175 (574)

Conductor Size AWG (mm)	Minimum Insulation Resistance @ 68°F (20°C) gigohm-mile (gigohm-km)	Maximum Average Attenuation 772 kHz @ 68°F (20°C) dB/kft (dB/km)	Maximum Conductor Resistance @ 68°F (20°C) Ohms/sheath mile (km)	DC Resistance Unbalance Maximum %		Dielectric Strength DC Potential - Volts		
				Average	Individual Pair	Conductor to Conductor	Conductor to Shield	Conductor to Screen
22 (0.64)	1.0 (1.6)	4.5 (14.8)	91 (56.5)	1.5	5.0	3,600	10,000	5,000

	Minimum Near End Crosstalk (NEXT) @ 772 kHz		@ 1,600 kHz
	PSWUNEXT Mean (dB)	47	
PSWUNEXT Worst Pair (dB)	42	-	
PSNEXT Between Compartments (dB)	-	78	

	Minimum Far End Crosstalk (FEXT) @ 772 kHz	
	Conductor Size (AWG)	22
PSELFEXT Mean (dB/kft)	49	
PSELFEXT Worst Pair (dB/kft)	43	

PART NUMBERS AND PHYSICAL CHARACTERISTICS

Part Number	Product Code	Pair Count	AWG (mm)	Nominal Diameter in (mm)	Approx. Weight lbs/kft (kg/km)	Standard Length ft (m)	Approx. Shipping Weight lbs (kg)	Steel Reel Size F x T x D in
24-417-83	KNAW	28	22 (0.64)	0.69 (18)	280 (415)	10,000 (3,048)	3,595 (1,630)	83 x 40 x 42
24-440-83	KNAW	54	22 (0.64)	0.95 (24)	510 (760)	10,000 (3,048)	5,895 (2,675)	83 x 40 x 42
24-456-83	KNAW	106	22 (0.64)	1.10 (28)	785 (1,170)	7,500 (2,286)	6,685 (3,030)	83 x 40 x 42
24-440-05	KHAH (T-SCREEN Air Core Design)	54	22 (0.64)	0.98 (25)	475 (705)	7,500 (2,286)	4,360 (1,975)	83 x 40 x 42
24-456-05	KHAH (T-SCREEN Air Core Design)	106	22 (0.64)	1.20 (31)	780 (1,160)	5,000 (1,524)	4,695 (2,130)	83 x 40 x 42
24-493-05	KHAH (T-SCREEN Air Core Design)	210	22 (0.64)	1.60 (41)	1,395 (2,075)	3,300 (1,006)	5,400 (2,450)	83 x 40 x 42
24-564-05	KHAH (T-SCREEN Air Core Design)	418	22 (0.64)	2.12 (54)	2,550 (3,795)	2,000 (610)	5,895 (2,675)	83 x 40 x 42

CELFIL

BJBB, BJAB, BJMB and BJTB

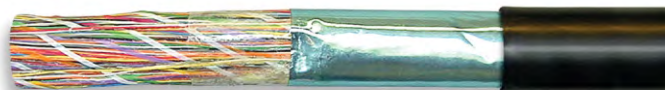

SPECIFICATIONS

Conductor	Solid annealed copper
Insulation	Dual-extruded cellular inner layer and color coded solid polyolefin skin
Twisted Pairs	Insulated conductors twisted to form pairs with varying lays
≤ 25-Pair Core	Assembled in concentric layers to form a cylindrical core
≥ 50-Pair Core	Assembled from concentrically formed units with 25-pair per unit; these may be stranded into 50-pair or 100-pair groups, which are then cabled to form the complete cylindrical core assembly
≥ 1,200-Pair Core	Color code is Mirror Image design
Filling Compound	PEPJ compound applied to cable core which completely coats each insulated conductor and fills interstices between pairs and units
Core	Non-hygroscopic core wrap applied over assembled core
Flooding Compound	Applied to fill all voids under shield
Shield	Electrically continuous 8 mil flat aluminum shielding tape, with polyolefin film fused and chemically bonded to both sides, applied longitudinally over the core and bonded to the outer jacket
Rip cord	Placed parallel to core
Jacket	Black, medium-density polyethylene
Jacket Marking	Manufacturer's identification, date of jacketing, gauge, pair count, sequential length and cable type marked at 1 meter intervals
Standards Compliance	RoHS-compliant

PRODUCT DESCRIPTION

Superior Essex CELFIL Cable with foam skin insulation is a single jacketed design for use in duct or direct burial installations.

FEATURES

- Twisted pairs with varying lays
- Non-hygroscopic core wrap applied over assembled core
- Rip cord placed parallel to core
- Black, medium-density polyethylene jacket

BENEFITS

- Minimizes crosstalk and meets capacitance unbalance limitations
- Furnishes mechanical as well as high dielectric protection between shielding and individual conductors
- Facilitates easy jacket removal
- Provides a tough, flexible protective covering that withstands exposure to sunlight, atmospheric temperatures, ground chemicals and stresses expected in standard installations

ELECTRICAL SPECIFICATIONS

Number of Pairs	Average Mutual Capacitance @ 1,000 Hz nF/mile (nF/km)	Capacitance Unbalance Pair to Pair @ 1 kHz		Capacitance Unbalance Pair to Ground @ 1 kHz	
		Maximum Individual pF @ 1 kft (pF @ 1 km)	Maximum RMS pF @ 1 kft (pF @ 1 km)	Maximum Individual pF @ 1 kft (pF @ 1 km)	Maximum Average pF @ 1 kft (pF @ 1 km)
12 or less	83 ± 7 (52 ± 4)	80 (145)	-	800 (2,625)	-
Over 12	83 ± 4 (52 ± 2)	80 (145)	25 (45)	800 (2,625)	175 (574)

Conductor Size AWG (mm)	Minimum Insulation Resistance 68°F (20°C) gigohm-mile (gigohm-km)	Maximum Average Attenuation 772 kHz @ 68°F (20°C) dB/kft (dB/km)	Maximum Conductor Resistance @ 68°F (20°C) Ohms/sheath kft (km)	DC Resistance Unbalance Maximum %		Dielectric Strength DC Potential - Volts Minimum	
				Average	Individual Pair	Conductor to Conductor	Conductor to Shield
19 (0.90)	1.0 (1.6)	3.2 (10.5)	8.5 (28.0)	1.5	5.0	4,500	10,000
22 (0.64)	1.0 (1.6)	4.5 (14.8)	17.3 (56.6)	1.5	5.0	3,600	10,000
24 (0.51)	1.0 (1.6)	5.6 (18.4)	26.1 (85.5)	1.5	5.0	3,000	10,000
26 (0.40)	1.0 (1.6)	7.0 (23.0)	44.0 (144.2)	1.5	5.0	2,400	10,000

	Minimum Near End Crosstalk (NEXT) dB/kft (dB/km)	
	@ 150 kHz	@ 772 kHz
PSWUNEXT Mean	58 (190)	47 (154)
PSWUNEXT Worst Pair	53 (174)	42 (138)

Conductor Size AWG (mm)	Minimum Far End Crosstalk dB/kft (dB/km)			
	PSELFEXT @ 150 kHz		PSELFEXT @ 772 kHz	
	Mean	Worst Pair	Mean	Worst Pair
19 (0.90)	65 (213)	59 (194)	51 (167)	45 (148)
22 (0.64)	63 (207)	57 (187)	49 (161)	43 (141)
24 (0.51)	63 (207)	57 (187)	49 (161)	43 (141)
26 (0.40)	61 (200)	57 (187)	47 (154)	43 (141)

PART NUMBERS AND PHYSICAL CHARACTERISTICS

Part Number	Product Code	Pair Count	AWG (mm)	Nominal Diameter in (mm)	Approx. Weight lbs/kft (kg/km)	Standard Length ft (m)	Approx. Shipping Weight lbs (kg)	Reel Size F x T x D in
85-026-13	BJBB	6	19 (0.90)	0.49 (12)	120 (180)	4,593 (1,400)	660 (300)	44 x 18 x 20
85-028-13	BJBB	12	19 (0.90)	0.58 (15)	190 (285)	4,593 (1,400)	1,040 (470)	46 x 25 x 20
85-031-13	BJBB	25	19 (0.90)	0.77 (20)	355 (530)	7,924 (2,415)	3,100 (1,410)	62 x 30 x 24
85-034-13	BJBB	50	19 (0.90)	1.03 (26)	655 (975)	4,593 (1,400)	3,295(1,500)	62 x 30 x 24
85-038-13	BJBB	100	19 (0.90)	1.37 (35)	1,225 (1,825)	3,002 (915)	3,965 (1,800)	62 x 30 x 24
85-042-13	BJBB	200	19 (0.90)	1.92 (49)	2,420 (3,600)	1,558 (475)	4,385 (1,990)	72 x 35 x 36
85-057-13	BJAB	6	22 (0.64)	0.38 (9.7)	70 (105)	9,186 (2,800)	750 (340)	44 x 18 x 20
85-059-13	BJAB	12	22 (0.64)	0.47 (12)	115 (170)	9,186 (2,800)	1,220 (555)	46 x 25 x 20
85-061-13	BJAB	18	22 (0.64)	0.53 (14)	155 (230)	4,593 (1,400)	820 (370)	44 x 18 x 20
85-062-13	BJAB	25	22 (0.64)	0.60 (15)	200 (300)	9,186 (2,800)	2,080 (945)	58 x 25 x 20
85-065-13	BJAB	50	22 (0.64)	0.76 (19)	350 (520)	6,004 (1,830)	2,345 (1,065)	58 x 25 x 20
85-069-13	BJAB	100	22 (0.64)	1.02 (26)	650 (965)	4,593 (1,400)	3,275 (1,485)	62 x 30 x 24
85-073-13	BJAB	200	22 (0.64)	1.37 (35)	1,225 (1,825)	2,608 (795)	3,565 (1,615)	65 x 30 x 32
85-075-13	BJAB	300	22 (0.64)	1.66 (42)	1,815 (2,700)	2,182 (665)	4,575 (2,075)	72 x 35 x 36
85-077-13	BJAB	400	22 (0.64)	1.88 (48)	2,375 (3,535)	1,952 (595)	5,335 (2,420)	78 x 40 x 39
85-081-13	BJAB	600	22 (0.64)	2.29 (58)	3,545 (5,275)	1,542 (470)	6,165 (2,795)	78 x 40 x 39
85-083-13	BJAB	900	22 (0.64)	2.75 (70)	5,225 (7,775)	854 (260)	5,075 (2,305)	72 x 35 x 36
85-085-13	BJAB	1,200	22 (0.64)	3.18 (81)	6,950 (10,364)	620 (190)	7,113 (3,226)	96 x 42 x 56
85-092-13	BJMB	6	24 (0.51)	0.35 (8.9)	60 (90)	4,593 (1,400)	320 (145)	30 x 18 x 12
85-094-13	BJMB	12	24 (0.51)	0.41 (10)	85 (125)	4,593 (1,400)	455 (205)	36 x 18 x 14
85-097-13	BJMB	25	24 (0.51)	0.52 (13)	140 (210)	4,593 (1,400)	750 (340)	44 x 18 x 20
85-100-13	BJMB	50	24 (0.51)	0.65 (17)	240 (355)	8,792 (2,680)	2,355 (1,070)	58 x 25 x 20
85-104-13	BJMB	100	24 (0.51)	0.84 (21)	430 (640)	6,578 (2,005)	3,115 (1,415)	62 x 30 x 24
85-108-13	BJMB	200	24 (0.51)	1.14 (29)	810 (1,205)	5,232 (1,595)	4,850 (2,205)	72 x 35 x 36
85-110-13	BJMB	300	24 (0.51)	1.36 (35)	1,180 (1,755)	3,724 (1,135)	5,010 (2,270)	72 x 35 x 36
85-112-13	BJMB	400	24 (0.51)	1.55 (39)	1,555 (2,315)	2,888 (880)	5,105 (2,320)	72 x 35 x 36
85-116-13	BJMB	600	24 (0.51)	1.88 (48)	2,305 (3,430)	1,838 (560)	4,850 (2,205)	72 x 35 x 36
85-118-13	BJMB	900	24 (0.51)	2.26 (57)	3,385 (5,040)	1,280 (390)	4,945 (2,250)	72 x 35 x 36
85-120-13	BJMB	1,200	24 (0.51)	2.57 (65)	4,450 (6,625)	1,280 (390)	6,395 (2,905)	78 x 40 x 39
85-121-13	BJMB	1,500	24 (0.51)	2.85 (72)	5,515 (8,210)	1,050 (320)	6,490 (2,950)	78 x 40 x 39
85-124-13	BJMB	1,800	24 (0.51)	3.11 (79)	6,575 (9,785)	688 (210)	5,225 (2,370)	78 x 40 x 39
85-145-13	BJTB	300	26 (0.40)	1.09 (28)	755 (1,125)	2,624 (800)	2,225 (1,010)	58 x 25 x 20
85-147-13	BJTB	400	26 (0.40)	1.25 (32)	995 (1,480)	2,624 (800)	2,855 (1,295)	58 x 25 x 20
85-151-13	BJTB	600	26 (0.40)	1.50 (38)	1,465 (2,180)	1,738 (530)	2,835 (1,285)	62 x 30 x 24
85-153-13	BJTB	900	26 (0.40)	1.79 (46)	2,145 (3,190)	1,722 (525)	3,980 (1,805)	62 x 30 x 24
85-155-13	BJTB	1,200	26 (0.40)	2.03 (52)	2,805 (4,175)	1,264 (385)	4,160 (1,885)	72 x 35 x 36
85-156-13	BJTB	1,500	26 (0.40)	2.29 (58)	3,515 (5,230)	1,246 (380)	4,995 (2,265)	72 x 35 x 36
85-157-13	BJTB	1,800	26 (0.40)	2.50 (64)	4,200 (6,250)	1,214 (370)	5,800 (2,630)	78 x 40 x 39
85-158-13	BJTB	2,100	26 (0.40)	2.69 (68)	4,885 (7,270)	1,182 (360)	6,475 (2,935)	78 x 40 x 39
85-159-13	BJTB	2,400	26 (0.40)	2.85 (72)	5,540 (8,245)	1,000 (305)	6,240 (2,830)	78 x 40 x 39
85-161-13	BJTB	2,700	26 (0.40)	3.01 (77)	6,200 (9,225)	1,000 (305)	6,900 (3,130)	78 x 40 x 39

Canadian ALPETH

BHBB, BHAB, BKMB and BKTB



SPECIFICATIONS	
Conductor	Solid annealed copper
Insulation	Color coded solid polyolefin
Twisted Pairs	Insulated conductors twisted to pairs with varying lays
≤ 25-Pair Core	Assembled in concentric layers to form a cylindrical core
≥ 50-Pair Core	Assembled from concentrically formed units with 25-pair per unit; these may be stranded into 50-pair or 100-pair groups, which are then cabled to form the complete cylindrical core assembly
≥ 1,200-Pair Core	Color code is Mirror Image design
Core Covering	Non-hygroscopic core wrap applied over assembled core
Shield	Electrically continuous 8 mil flat aluminum shielding tape with polyolefin film fused and chemically bonded to both sides; applied longitudinally over the core and bonded to the outer jacket
Jacket	Black, medium-density polyethylene
Jacket Marking	Manufacturer's identification, date of jacketing, gauge, pair count, sequential length and cable type marked at 1 meter intervals
Standards Compliance	RoHS-compliant

PRODUCT DESCRIPTION

Superior Essex ALPETH Cables are designed primarily for aerial use. In this application, the cable must be attached to a support strand (messenger). If the cable is to be placed in a duct, the cable must be pressurized.

FEATURES

- Twisted pairs with varying lays
- Non-hygroscopic core wrap applied over assembled core
- Black, medium-density polyethylene jacket

BENEFITS

- Minimizes crosstalk and meets capacitance unbalance limitations
- Furnishes mechanical as well as high dielectric protection between shielding and individual conductors
- Provides a tough, flexible protective covering that withstands exposure to sunlight, atmospheric temperatures, ground chemicals and stresses expected in standard installations

ELECTRICAL SPECIFICATIONS

Number of Pairs	Average Mutual Capacitance @ 1,000 Hz nF/mile (nF/km)	Capacitance Unbalance Pair to Pair @ 1 kHz		Capacitance Unbalance Pair to Ground @ 1 kHz	
		Maximum Individual pF @ 1 kft (pF @ 1 km)	Maximum RMS pF @ 1 kft (pF @ 1 km)	Maximum Individual pF @ 1 kft (pF @ 1 km)	Maximum Average pF @ 1 kft (pF @ 1 km)
12 or less	83 ± 7 (52 ± 4)	80 (145)	-	800 (2,625)	-
Over 12	83 ± 4 (52 ± 2)	80 (145)	25 (45)	800 (2,625)	175 (574)

Conductor Size AWG (mm)	Minimum Insulation Resistance @ 68°F (20°C) gigohm-mile (gigohm-km)	Maximum Average Attenuation 772 kHz @ 68°F (20°C) dB/kft (dB/km)	Maximum Conductor Resistance @ 68°F (20°C) Ohms/sheath kft (km)	DC Resistance Unbalance Maximum %		Dielectric Strength DC Potential - Volts Minimum	
				Average	Individual Pair	Conductor to Conductor	Conductor to Shield
19 (0.90)	1.0 (1.6)	3.3 (10.8)	8.5 (28.0)	1.5	5.0	5,000	10,000
22 (0.64)	1.0 (1.6)	4.7 (15.4)	17.3 (56.6)	1.5	5.0	4,000	10,000
24 (0.51)	1.0 (1.6)	5.9 (19.4)	26.1 (85.5)	1.5	5.0	3,000	10,000
26 (0.40)	1.0 (1.6)	7.4 (24.3)	44.0 (144.2)	1.5	5.0	2,400	10,000

	Minimum Near End Crosstalk (NEXT) dB/kft (dB/km)	
	@ 150 kHz	@ 772 kHz
	PSWUNEXT Mean	58 (190)
PSWUNEXT Worst Pair	53 (174)	42 (138)

Conductor Size AWG (mm)	Minimum Far End Crosstalk dB/kft (dB/km)			
	PSELFEXT @ 150 kHz		PSELFEXT @ 772 kHz	
	Mean	Worst Pair	Mean	Worst Pair
19 (0.90)	65 (213)	59 (194)	51 (167)	45 (148)
22 (0.64)	63 (207)	57 (187)	49 (161)	43 (141)
24 (0.51)	63 (207)	57 (187)	49 (161)	43 (141)
26 (0.40)	61 (200)	57 (187)	47 (154)	43 (141)

PART NUMBERS AND PHYSICAL CHARACTERISTICS

Part Number	Product Code	Pair Count	AWG (mm)	Nominal Diameter in (mm)	Approx. Weight lbs/kft (kg/km)	Standard Length ft (m)	Approx. Shipping Weight lbs (kg)	Reel Size F x T x D in
85-031-01	BHBB	25	19 (0.90)	0.74 (19)	310 (460)	4,593 (1,400)	1,625 (740)	52 x 25 x 20
85-034-01	BHBB	50	19 (0.90)	0.98 (25)	565 (840)	4,593 (1,400)	2,965 (1,345)	65 x 30 x 32
85-038-01	BHBB	100	19 (0.90)	1.31 (33)	1,060 (1,580)	3,002 (915)	3,470 (1,575)	62 x 30 x 24
85-042-01	BHBB	200	19 (0.90)	1.84 (47)	2,075 (3,090)	1,492 (455)	3,385 (1,535)	62 x 30 x 24
85-062-01	BHAB	25	22 (0.64)	0.59 (15)	180 (270)	5,724 (1,745)	1,195 (540)	46 x 25 x 20
85-065-01	BHAB	50	22 (0.64)	0.75 (19)	310 (460)	5,724 (1,745)	2,020 (915)	58 x 25 x 20
85-069-01	BHAB	100	22 (0.64)	1.00 (25)	570 (850)	4,593 (1,400)	2,905 (1,320)	62 x 30 x 24
85-073-01	BHAB	200	22 (0.64)	1.35 (34)	1,080 (1,605)	3,412 (1,040)	4,300 (1,950)	72 x 35 x 36
85-075-01	BHAB	300	22 (0.64)	1.64 (42)	1,595 (2,375)	2,182 (665)	4,095 (1,855)	72 x 35 x 36
85-077-01	BHAB	400	22 (0.64)	1.86 (47)	2,105 (3,135)	2,132 (650)	5,100 (2,315)	72 x 35 x 36
85-081-01	BHAB	600	22 (0.64)	2.27 (58)	3,135 (4,665)	1,410 (430)	5,035 (2,285)	72 x 35 x 36
85-083-01	BHAB	900	22 (0.64)	2.74 (70)	4,640 (6,905)	688 (210)	3,805 (1,725)	72 x 35 x 36
85-097-01	BKMB	25	24 (0.51)	0.50 (13)	125 (185)	4,593 (1,400)	680 (310)	44 x 18 x 20
85-100-01	BKMB	50	24 (0.51)	0.63 (16)	215 (320)	4,593 (1,400)	1,155 (525)	46 x 25 x 20
85-104-01	BKMB	100	24 (0.51)	0.81 (21)	380 (565)	4,593 (1,400)	1,950 (885)	52 x 25 x 20
85-108-01	BKMB	200	24 (0.51)	1.09 (28)	705 (1,050)	4,593 (1,400)	3,605 (1,635)	65 x 30 x 32
85-110-01	BKMB	300	24 (0.51)	1.30 (33)	1,025 (1,525)	1,838 (560)	2,085 (945)	52 x 25 x 20
85-112-01	BKMB	400	24 (0.51)	1.50 (38)	1,355 (2,015)	1,492 (455)	2,265 (1,030)	58 x 25 x 20
85-116-01	BKMB	600	24 (0.51)	1.81 (46)	2,010 (2,990)	1,264 (385)	2,830 (1,285)	62 x 30 x 24
85-118-01	BKMB	900	24 (0.51)	2.17 (55)	2,970 (4,420)	1,182 (360)	4,125 (1,870)	72 x 35 x 36
85-120-01	BKMB	1,200	24 (0.51)	2.49 (63)	3,915 (5,825)	952 (290)	4,340 (1,970)	72 x 35 x 36
85-147-01	BKTB	400	26 (0.40)	1.21 (31)	870 (1,295)	2,624 (800)	2,530 (1,145)	58 x 25 x 20
85-151-01	BKTB	600	26 (0.40)	1.45 (37)	1,290 (1,920)	2,394 (730)	3,455 (1,570)	65 x 30 x 32
85-153-01	BKTB	900	26 (0.40)	1.74 (44)	1,900 (2,830)	1,526 (465)	3,270 (1,485)	65 x 30 x 32
85-157-01	BKTB	1,800	26 (0.40)	2.43 (62)	3,705 (5,515)	1,312 (400)	5,560 (2,520)	78 x 40 x 39

SEALPAP

BHBF, BHAf, BKMF and BKTF



SPECIFICATIONS

Conductor	Solid annealed copper
Insulation	Conductors are insulated with solid polyolefin in distinctive colors to facilitate pair identification
Twisted Pairs	Insulated conductors twisted to pairs with varying lays
≤ 25-Pair Core	Pairs are combined into a cylindrical core
≥ 50-Pair Core	Multiples of 25-pair groups are assembled to form the final cable core; each group is identified by color coded non-hygroscopic binders
≥ 1,200-Pair Core	Color code is Mirror Image design
Core Wrap	Non-hygroscopic dielectric material
Inner Jacket	Polyethylene
Rip cords	Placed between the core wrap and the inner jacket and between the inner jacket and shield
Shield	Electrically continuous 8 mil flat aluminum shielding tape, with polyolefin film fused and chemically bonded to both sides, applied longitudinally over the core and bonded to the outer jacket
Outer Jacket	Black, medium-density polyethylene
Jacket Marking	Manufacturer's identification, plant location, date of jacketing, pair count, AWG, product identification, sequential length markings in meters and telephone handset
Standards Compliance	Telcordia® GR-421-CORE ANSI/ICEA S-85-625-2011 RoHS-compliant

Telcordia is a registered trademark of Ericsson Inc.

PRODUCT DESCRIPTION

Double jacketed air core cable, commonly called "SEALPAP," is a solid-insulated design intended for use in Outside Plant (OSP) where a greater risk of physical damage exists. The inner jacket provides protection to the cable core in the event of severe damage to the outer protective sheath.

FEATURES

- Twisted pairs with varying lays
- Core wrap
- Inner jacket
- Outer jacket bonded to shield

BENEFITS

- Minimizes crosstalk and meets capacitance unbalance limitations
- Protects core and helps provide core-to-shield dielectric strength
- Provides protection against mechanical damage and helps prevent the ingress of moisture
- Provides a tough, flexible protective covering that withstands exposure to sunlight, atmospheric temperatures, and stresses expected in standard installations
- Bonding provides additional moisture resistance

ELECTRICAL SPECIFICATIONS

Number of Pairs	Average Mutual Capacitance @ 1,000 Hz nF/mile (nF/km)	Capacitance Unbalance Pair to Pair @ 1 kHz		Capacitance Unbalance Pair to Ground @ 1 kHz	
		Maximum Individual pF @ 1 kft (pF @ 1 km)	Maximum RMS pF @ 1 kft (pF @ 1 km)	Maximum Individual pF @ 1 kft (pF @ 1 km)	Maximum Average pF @ 1 kft (pF @ 1 km)
12 or less	83 ± 4 (52 ± 2)	80 (145)	-	800 (2,625)	-
Over 12	83 ± 4 (52 ± 2)	80 (145)	25 (45)	800 (2,625)	175 (574)

Conductor Size AWG (mm)	Minimum Insulation Resistance @ 68°F (20°C) gigohm-mile (gigohm-km)	Maximum Average Attenuation 772 kHz @ 68°F (20°C) dB/kft (dB/km)	Maximum Conductor Resistance @ 68°F (20°C) Ohms/sheath kft (km)	DC Resistance Unbalance Maximum %		Dielectric Strength DC Potential - Volts Minimum	
				Average	Individual Pair	Conductor to Conductor	Conductor to Shield
19 (0.90)	1.0 (1.6)	3.3 (10.8)	45 (28.0)	1.5	5.0	5,000	20,000
22 (0.64)	1.0 (1.6)	4.7 (15.4)	91 (56.6)	1.5	5.0	4,000	20,000
24 (0.51)	1.0 (1.6)	5.9 (19.4)	144 (89.5)	1.5	5.0	3,000	20,000
26 (0.40)	1.0 (1.6)	7.4 (24.3)	232 (144.2)	1.5	5.0	2,400	20,000

	Minimum Near End Crosstalk (NEXT) dB/kft (dB/km)	
	@ 150 kHz	@ 772 kHz
PSWUNEXT Mean	58 (190)	47 (154)
PSWUNEXT Worst Pair	53 (174)	42 (138)

Conductor Size AWG (mm)	Minimum Far End Crosstalk dB/kft (dB/km)			
	PSELFEXT @ 150 kHz		PSELFEXT @ 772 kHz	
	Mean	Worst Pair	Mean	Worst Pair
19 (0.90)	65 (213)	59 (194)	51 (167)	45 (148)
22 (0.64)	63 (207)	57 (187)	49 (161)	43 (141)
24 (0.51)	63 (207)	57 (187)	49 (161)	43 (141)
26 (0.40)	61 (200)	57 (187)	47 (154)	43 (141)

PART NUMBERS AND PHYSICAL CHARACTERISTICS

Part Number	Product Code	Pair Count	AWG (mm)	Nominal Diameter in (mm)	Approx. Weight lbs/kft (kg/km)	Standard Length ft (m)	Approx. Shipping Weight lbs (kg)	Steel Reel Size F x T x D in
85-031-41	BHBF	25	19 (0.90)	0.84 (21)	355 (530)	9,006 (2,745)	3,990 (1,810)	83 x 40 x 42
85-034-41	BHBF	50	19 (0.90)	1.07 (27)	625 (930)	4,512 (1,375)	3,615 (1,640)	83 x 40 x 42
85-038-41	BHBF	100	19 (0.90)	1.43 (36)	1,170 (1,740)	2,986 (910)	4,290 (1,945)	83 x 40 x 42
85-042-41	BHBF	200	19 (0.90)	1.96 (50)	2,230 (3,320)	2,230 (680)	5,770 (2,615)	83 x 40 x 42
85-062-41	BHAF	25	22 (0.64)	0.68 (17)	215 (320)	5,724 (1,745)	2,025 (920)	83 x 40 x 42
85-065-41	BHAF	50	22 (0.64)	0.85 (22)	360 (535)	5,724 (1,745)	2,855 (1,295)	83 x 40 x 42
85-069-41	BHAF	100	22 (0.64)	1.09 (28)	635 (945)	4,282 (1,305)	3,515 (1,595)	83 x 40 x 42
85-073-41	BHAF	200	22 (0.64)	1.47 (37)	1,190 (1,770)	3,412 (1,040)	4,855 (2,200)	83 x 40 x 42
85-077-41	BHAF	400	22 (0.64)	1.99 (51)	2,260 (3,365)	2,132 (650)	5,615 (2,545)	83 x 40 x 42
85-081-41	BHAF	600	22 (0.64)	2.42 (62)	3,370 (5,015)	1,410 (430)	5,545 (2,515)	83 x 40 x 42
85-100-41	BKMF	50	24 (0.51)	0.72 (18)	255 (380)	6,316 (1,925)	2,405 (1,090)	83 x 40 x 42
85-104-41	BKMF	100	24 (0.51)	0.91 (23)	430 (640)	6,004 (1,830)	3,375 (1,530)	83 x 40 x 42
85-108-41	BKMF	200	24 (0.51)	1.18 (30)	770 (1,145)	2,116 (645)	2,425 (1,100)	83 x 40 x 42
85-110-41	BKMF	300	24 (0.51)	1.43 (36)	1,130 (1,680)	2,280 (695)	3,370 (1,530)	83 x 40 x 42
85-112-41	BKMF	400	24 (0.51)	1.62 (41)	1,475 (2,195)	2,280 (695)	4,160 (1,885)	83 x 40 x 42
85-116-41	BKMF	600	24 (0.51)	1.94 (49)	2,160 (3,215)	1,312 (400)	3,630 (1,645)	83 x 40 x 42
85-118-41	BKMF	900	24 (0.51)	2.33 (59)	3,190 (4,745)	1,050 (320)	4,145 (1,880)	83 x 40 x 42
85-120-41	BKMF	1,200	24 (0.51)	2.64 (67)	4,165 (6,200)	1,312 (400)	6,260 (2,840)	83 x 40 x 42
85-143-41	BKTF	200	26 (0.40)	1.00 (25)	525 (780)	4,822 (1,470)	3,325(1,510)	83 x 40 x 42
85-147-41	BKTF	400	26 (0.40)	1.33 (34)	970 (1,445)	2,394 (730)	3,115 (1,415)	83 x 40 x 42
85-151-41	BKTF	600	26 (0.40)	1.58 (40)	1,410 (2,100)	2,394 (730)	4,170 (1,890)	83 x 40 x 42
85-153-41	BKTF	900	26 (0.40)	1.87 (48)	2,045 (3,045)	1,510 (460)	3,885 (1,760)	83 x 40 x 42
85-155-41	BKTF	1,200	26 (0.40)	2.13 (54)	2,695 (4,010)	1,526 (465)	4,910 (2,225)	83 x 40 x 42

Canadian Bonded STALPETH

DCAZ, DCMZ and DCTZ



PRODUCT DESCRIPTION

Canadian Bonded STALPETH Cable is a foam-skin insulated, single jacketed, armored air core design intended for use in ducts to provide more efficient duct utilization than standard PIC designs.

APPLICATIONS

- Congested underground duct systems

FEATURES

- Tightly controlled individual conductor dimensions
- Specially designed pair twist lays
- Core wrap
- Aluminum tape shield
- Steel tape armor bonded to outer jacket
- Polyethylene jacket

BENEFITS

- Limits resistance unbalance of paired conductors
- Minimizes crosstalk and meets the capacitance unbalance requirements
- Protects the core and helps provide core-to-shield dielectric strength
- Assures good electrical contact with non-piercing bonding clamps
- Protects the core from mechanical damage and reduces the possibility of tape buckling during installation, ingress of water to the aluminum shield and of water along the cable between the armor and outer jacket
- Provides a tough, flexible, protective covering that withstands exposure to sunlight, atmospheric temperatures, ground chemicals and stresses expected in standard installations

SPECIFICATIONS

Conductor	Solid annealed copper
Insulation	Conductors are dual insulated with an inner layer of foamed, natural polyolefin covered by an outer layer of solid, colored polyolefin; conductor insulation is color coded in accordance with industry standard
≥ 50-Pair Core	Multiples of 25-pair groups are assembled to form the final cable core; each group is identified by color coded non-hygroscopic binders; for 1,200-pair and larger, the color code is Mirror Image design
Core Wrap	Non-hygroscopic dielectric material
Shield	Corrugated bare 8 mil aluminum tape applied longitudinally over the core wrap
Armor	Corrugated, copolymer coated, 6 mil steel tape applied over the aluminum shield and bonded to the outer jacket
Jacket	Black polyethylene
Jacket Marking	Manufacturer's identification, pair count, AWG, product identification and a telephone handset printed at 2 foot intervals; sequential footage markings are printed at alternate 2 foot intervals
Standards Compliance	Telcordia® GR-421-CORE Issue 2 RoHS-compliant

Telcordia is a registered trademark of Ericsson Inc.

ELECTRICAL SPECIFICATIONS

Number of Pairs	Average Mutual Capacitance @ 1,000 Hz nF/mile (nF/km)	Capacitance Unbalance Pair to Pair @ 1 kHz		Capacitance Unbalance Pair to Ground @ 1 kHz	
		Maximum Individual pF @ 1 kft (pF @ 1 km)	Maximum RMS pF @ 1 kft (pF @ 1 km)	Maximum Individual pF @ 1 kft (pF @ 1 km)	Maximum Average pF @ 1 kft (pF @ 1 km)
All pairs	83 ± 4 (52 ± 2)	80 (145)	25 (45)	800 (2,625)	175 (574)

Conductor Size AWG (mm)	Minimum Insulation Resistance @ 68°F (20°C) gigohm-mile (gigohm-km)	Maximum Average Attenuation 772 kHz @ 68°F (20°C) dB/kft (dB/km)	Maximum Conductor Resistance @ 68°F (20°C) Ohms/sheath mile (km)	DC Resistance Unbalance Maximum %		Dielectric Strength DC Potential - Volts	
				Average	Individual Pair	Conductor to Conductor	Conductor to Shield
22 (0.64)	1.0 (1.6)	5.0 (16.4)	91 (56.5)	1.5	5.0	1,400	5,000
24 (0.51)	1.0 (1.6)	6.3 (20.7)	144 (89.5)	1.5	5.0	1,200	5,000
26 (0.40)	1.0 (1.6)	7.9 (25.9)	232 (144.2)	1.5	5.0	1,000	5,000

Minimum Near End Crosstalk (NEXT) @ 772 kHz dB/kft (dB/km)	
PSWUNEXT Mean	47 (154)
PSWUNEXT Worst Pair	42 (138)

Conductor Size AWG (mm)	Minimum Far End Crosstalk PSELFEXT @ 772 kHz dB/kft (dB/km)	
	Mean	Worst Pair
22 (0.64)	49 (161)	43 (141)
24 (0.51)	49 (161)	43 (141)
26 (0.40)	47 (154)	43 (141)

PART NUMBERS AND PHYSICAL CHARACTERISTICS

Part Number	Product Code	Pair Count	AWG (mm)	Nominal Diameter in (mm)	Approx. Weight lbs/kft (kg/km)	Standard Length ft (m)	Approx. Shipping Weight lbs (kg)	Steel Reel Size F x T x D in
07-021-76	DCAZ	900	22 (0.64)	2.49 (63)	4,375 (6,510)	1,600 (488)	7,795 (3,535)	83 x 40 x 42
07-021-77	DCAZ	1,200	22 (0.64)	2.85 (72)	5,770 (8,585)	1,200 (366)	7,720 (3,500)	83 x 40 x 42
19-116-01	DCMZ	600	24 (0.51)	1.70 (43)	19,60 (2,915)	3,900 (1,189)	8,440 (3,830)	83 x 40 x 42
07-021-99	DCMZ	900	24 (0.51)	2.02 (51)	2,860 (4,255)	2,616 (797)	8,275 (3,755)	83 x 40 x 42
07-021-68	DCMZ	1,200	24 (0.51)	2.30 (58)	3,755 (5,590)	2,000 (610)	8,305 (3,765)	83 x 40 x 42
07-022-12	DCMZ	1,500	24 (0.51)	2.57 (65)	4,660 (6,935)	1,600 (488)	8,250 (3,745)	83 x 40 x 42
07-021-69	DCMZ	1,800	24 (0.51)	2.81 (71)	5,545 (8,250)	1,250 (381)	7,725 (3,505)	83 x 40 x 42
07-021-75	DCMZ	2,100	24 (0.51)	3.04 (77)	6,440 (9,585)	1,148 (350)	8,200 (3,720)	83 x 40 x 42
07-021-98	DCMZ	2,400	24 (0.51)	3.22 (82)	7,320 (10,895)	876 (267)	7,205 (3,270)	83 x 40 x 42
07-022-11	DCTZ	900	26 (0.40)	1.62 (41)	1,850 (2,755)	3,904 (1,190)	8,010 (3,635)	83 x 40 x 42
07-021-70	DCTZ	1,200	26 (0.40)	1.84 (47)	2,420 (3,600)	3,200 (975)	8,540 (3,875)	83 x 40 x 42
07-022-08	DCTZ	1,500	26 (0.40)	2.08 (53)	2,995 (4,455)	2,500 (762)	8,285 (3,755)	83 x 40 x 42
07-021-71	DCTZ	1,800	26 (0.40)	2.26 (57)	3,560 (5,300)	2,080 (634)	8,200 (3,720)	83 x 40 x 42
07-021-72	DCTZ	2,400	26 (0.40)	2.58 (66)	4,685 (6,970)	1,600 (488)	8,290 (3,760)	83 x 40 x 42
07-021-90	DCTZ	2,700	26 (0.40)	2.71 (69)	5,240 (7,800)	1,247 (380)	7,345 (3,330)	83 x 40 x 42
07-021-73	DCTZ	3,000	26 (0.40)	2.86 (73)	5,800 (8,630)	1,200 (366)	7,755 (3,520)	83 x 40 x 42
07-021-74	DCTZ	3,600	26 (0.40)	3.03 (77)	6,885 (10,245)	1,150 (351)	8,715 (3,950)	83 x 40 x 42

Canadian Integrated Messenger Wire

IM/F, IM/H and IM/G



PRODUCT DESCRIPTION

IM/F, IM/H and IM/G Aerial Service Wire in 2, 3, 6 and 12-pair is self supporting. The conductors are laid parallel to a solid extra-strength steel support wire. Both the conductors and support wire are jacketed in an integral "figure 8" configuration. This product permits fast, economical installation from aerial distribution cable terminals to building entrance protectors or network interface units on the subscriber's premises. The fully color coded core expedites splicing and terminating procedures.

SPECIFICATIONS

Conductor	Solid annealed copper
Insulation	Solid polyolefin in distinctive colors; standard color codes are used for pair identification with compounds chosen for electrical balance and permanency
Core Assembly	Tightly controlled individual conductor dimensions; in multi-pair constructions, pair twist lays are varied; twisted pairs are formed into a firm, round core
Support Member	Available in 0.083 inch (F), 0.109 inch (H), or 0.095 inch (G) solid extra-strength steel support wire
Jacket	Black, fire retardant, polyvinyl chloride jacket; steel support wire is jacketed in an integral extrusion with the core
Performance Compliance	Telcordia® GR-3163-CORE ANSI/ICEA S-89-648-2011 RoHS-compliant
NRTL Programs	UL® Listed

Telcordia is a registered trademark of Ericsson Inc. UL is a registered trademark of UL LLC.

FEATURES

- Tightly controlled individual conductor dimensions
- Varied pair twist lays
- Polyvinyl chloride jacket

BENEFITS

- Limits resistance unbalance of the twisted pairs
- Minimizes crosstalk and meets capacitance limits
- Provides a tough flexible protective covering that withstands exposure to sunlight, atmospheric temperatures and stresses encountered in standard installations



TECHNICAL GUIDELINE

Sag and Tension Technical Guidelines are available for these products. Refer to the "Resources" section on our site for more information.

ELECTRICAL SPECIFICATIONS

Average Mutual Capacitance @ 1,000 Hz		Capacitance Unbalance @ 1 kHz Maximum Individual		Minimum Near End Crosstalk (NEXT) @ 772 kHz dB/kft (dB/km)
Maximum Individual nF/mile (nF/km)	Wire Average nF/mile (nF/km)	Pair to Pair pF @ 1 kft (pF @ 1 km)	Pair to Ground pF @ 1 kft (pF @ 1 km)	
94 (58)	83 ± 7 (52 ± 4)	80 (145)	800 (2,625)	44 (144)

Conductor Size AWG (mm)	Minimum Insulation Resistance megohm-kft (megohm-km)	Maximum Average Attenuation 772 kHz @ 68°F (20°C) dB/kft (dB/km)	DC Conductor Resistance @ 68°F (20°C) Maximum Individual Ohms/mile (Ohms/km)	Resistance Unbalance Maximum % Individual Pair	Conductor to Conductor Dielectric Strength Minimum Volts DC 3 secs, no breakdown
19 (0.90)	5,000 (1,600)	3.3 (11)	45 (28.0)	5.0	5,000
22 (0.64)	5,000 (1,600)	5.1 (17)	91 (56.5)	5.0	4,000

PART NUMBERS AND PHYSICAL CHARACTERISTICS

Part Number	Support Size in	Pair Count	AWG (mm)	Dimensions		Approx. Weight lbs/kft (kg/km)	Standard Length ft (m)	Package
				Minor in (mm)	Major in (mm)			
10-921-38	IM/G 0.095	2	19 (0.90)	0.27 (6.8)	0.51 (12.9)	73 (109)	656 (200)	Coil
10-923-38	IM/G 0.095	2	19 (0.90)	0.27 (6.8)	0.51 (12.9)	73 (109)	4,921 (1,500)	Reel
10-002-34	IM/F 0.083	2	22 (0.64)	0.22 (5.7)	0.46 (11.7)	55 (82)	600 (183)	Coil
10-102-34	IM/F 0.083	2	22 (0.64)	0.22 (5.7)	0.46 (11.7)	55 (82)	5,000 (1,524)	Reel
10-503-34	IM/F 0.083	3	22 (0.64)	0.24 (6.2)	0.48 (12.3)	72 (107)	600 (183)	Coil
10-106-34	IM/F 0.083	6	22 (0.64)	0.30 (7.6)	0.53 (13.6)	80 (119)	3,500 (1,067)	Reel
10-206-34	IM/F 0.083	6	22 (0.64)	0.30 (7.6)	0.53 (13.6)	80 (119)	1,000 (305)	Reel
10-006-34	IM/F 0.083	6	22 (0.64)	0.30 (7.6)	0.53 (13.6)	80 (119)	250 (76)	Coil
10-261-38	IM/G 0.095	6	22 (0.64)	0.30 (7.6)	0.55 (13.9)	80 (119)	492 (150)	Coil
10-262-38	IM/G 0.095	6	22 (0.64)	0.30 (7.6)	0.55 (13.9)	80 (119)	2,461 (750)	Reel
10-265-38	IM/G 0.095	6	22 (0.64)	0.30 (7.6)	0.55 (13.9)	80 (119)	5,000 (1,524)	Reel
10-281-38	IM/G 0.095	12	22 (0.64)	0.38 (7.6)	0.65 (16.6)	114 (170)	410 (125)	Coil
10-284-38	IM/G 0.095	12	22 (0.64)	0.38 (7.6)	0.65 (16.6)	114 (170)	2,460 (750)	Reel
10-285-38	IM/G 0.095	12	22 (0.64)	0.38 (7.6)	0.65 (16.6)	114 (170)	8,202 (2,500)	Reel
10-102-35	IM/H 0.109	12	22 (0.64)	0.38 (7.6)	0.66 (16.7)	130 (193)	1,000 (305)	Reel
10-012-35	IM/H 0.109	12	22 (0.64)	0.38 (7.6)	0.66 (16.7)	130 (193)	250 (76)	Coil
10-212-35	IM/H 0.109	12	22 (0.64)	0.38 (7.6)	0.66 (16.7)	130 (193)	5,000 (1,524)	Reel

Contact Superior Essex for additional configurations and AWG sizes.

PRODUCT DESCRIPTION

ADP NMS is a PVC-jacketed aerial service wire with QuickCount® in meters. It is available in 2-pair and 6-pair designs. ADP NMS printed in meters is designed for use in extending telephone service to subscriber premises from the distribution cable or cable terminal. Major features include small size and light weight coupled with abrasion resistant jacket. Standard hardware and installation procedures are directly applicable to this product.



FEATURES

- Insulation of the tip conductor is marked with a stripe of the mating ring insulation color
- Tightly controlled individual conductor dimensions
- Fiberglass yarns
- Rip cord
- Weather resistant, polyvinyl chloride jacket bonded to the fiberglass strength members

BENEFITS

- Reduces the possibility of splitting pairs during installation
- Limits resistance unbalance of the twisted pairs
- Provides necessary longitudinal strength
- Facilitates jacket removal
- Protects the core from mechanical damage, degradation by sunlight and ingress of moisture
- Provides the required strength characteristics

SPECIFICATIONS

Conductor	Solid annealed copper
Insulation	Solid polyolefin; insulation of the tip conductor is marked with a stripe of the mating ring insulation color
Core Assembly	Individual conductors are carefully twisted into pairs
Strength Members	Fiberglass yarns placed parallel to the core
Rip cord	Placed parallel to the core
Jacket	Black, weather resistant, polyvinyl chloride jacket extruded over the yarns and rip cord and bonded to the fiberglass strength members
Performance Compliance	Telcordia® GR-3163-CORE RDUP PE-7 ANSI/ICEA S-89-648-2011 RoHS-compliant
NRTL Programs	UL® Listed

Telcordia is a registered trademark of Ericsson Inc. UL is a registered trademark of UL LLC.

ELECTRICAL SPECIFICATIONS

Average Mutual Capacitance @ 1,000 Hz			Capacitance Unbalance @ 1 kHz		Minimum Near End Crosstalk (NEXT) @ 772 kHz dB/kft (dB/km)
Maximum Individual nF/mile (nF/km)	Wire Average nF/mile (nF/km)	Maximum Individual Pair to Pair pF @ 1 kft (pF @ 1 km)	Resistance Unbalance Maximum % Individual Pair	Conductor to Conductor Dielectric Strength Minimum Volts DC 3 secs, no breakdown	
94 (58)	83 ± 7 (52 ± 4)	80 (145)	5.0	4,000	
Conductor Size AWG (mm)	Minimum Insulation Resistance megohm-mile (megohm-km)	DC Conductor Resistance @ 68°F (20°C)		Resistance Unbalance Maximum % Individual Pair	Conductor to Conductor Dielectric Strength Minimum Volts DC 3 secs, no breakdown
		Maximum Average Attenuation 772 kHz @ 68°F (20°C) dB/kft (dB/km)	Maximum Individual Ohms/mile (Ohms/km)		
22 (0.64)	1,000 (1,600)	5.1 (17)	91 (56.5)	5.0	4,000

PART NUMBERS AND PHYSICAL CHARACTERISTICS

Part Number	Pair Count	AWG (mm)	Dimensions		Approx. Weight lbs/kft (kg/km)	Standard Length m	Package
			Minor in (mm)	Major in (mm)			
12-015-08	2	22 (0.64)	0.18 (4.8)	0.36 (9.1)	35 (50)	150	ReelSaver™ coil
12-014-08	2	22 (0.64)	0.18 (4.8)	0.36 (9.1)	35 (50)	228	POP™ box
12-013-08	2	22 (0.64)	0.18 (4.8)	0.36 (9.1)	35 (50)	300	Coil
11-003-66	6	22 (0.64)	0.27 (7.0)	0.48 (12)	70 (105)	305	Reel
11-003-65	6	22 (0.64)	0.27 (7.0)	0.48 (12)	70 (105)	122	Coil



TECHNICAL GUIDELINE

Sag and Tension Technical Guidelines are available for these products. Refer to the "Resources" section on our site for more information.

Aerial Drop Wire

ADW



SPECIFICATIONS

Conductor	Solid annealed copper
Insulation	Individual conductors insulated with solid polyolefin in distinctive colors; 2-pair color code is Blue/White and Orange/Red and 4-pair color code is Blue/White, Orange/Red, Black/Green and Yellow/Brown
Core Assembly	Individual conductors twisted into pairs
Strength Members	Fiberglass strength members placed in the jacket parallel to the core assembly
Rip cord	Placed parallel to the core
Jacket	Sky blue grey weather-resistant PVC jacket extruded over the strength members and bonded to the fiberglass strength members
Standards Compliance	RoHS-compliant

PRODUCT DESCRIPTION

ADW is a PVC jacketed 2-pair or 4-pair aerial service wire designed for use in extending telephone service to subscriber premises from the distribution cable or cable terminal. Major features include small size and light weight coupled with abrasion resistant jacket. Standard hardware and installations procedures are directly applicable to this product.

FEATURES

- Twisted pairs with varying lays
- Fiberglass strength members
- Rip cord
- Weather-resistant PVC jacket extruded over the strength members and bonded to the fiberglass strength members

BENEFITS

- Minimizes resistance unbalance
- Provides the necessary longitudinal strength
- Facilitates jacket removal
- Protects the core from mechanical damage, degradation by sunlight and the ingress of moisture
- Provides the required strength characteristics

ELECTRICAL SPECIFICATIONS

Conductor Size AWG (mm)	Average Mutual Capacitance @ 1,000 Hz nF/mile (nF/km)	Insulation Resistance @ 60°F (16°C) megohm-mile (megohm-km)	Capacitance Unbalance @ 1 kHz Pair to Pair Maximum pF @ 1 kft (pF @ 1 km)	Conductor DC Resistance @ 20°F (-7°C) Maximum Individual Ohms/kft (Ohms/km)	Resistance Unbalance Maximum Individual Pair %	Dielectric Strength DC Potential - Volts Minimum Conductor to Conductor
22 (0.64)	113 (70)	380 (610)	80 (145)	16.8 (55)	5.0	4,000

PART NUMBERS AND PHYSICAL CHARACTERISTICS

Part Number	Pair Count	AWG (mm)	Nominal Diameter in (mm)	Approx. Weight lbs/kft (kg/km)	Standard Length ft (m)	Package
12-022-09	2	22 (0.64)	0.26 (6.6)	30 (45)	1,476 (450)	Coil
12-021-09	2	22 (0.64)	0.26 (6.6)	30 (45)	656 (200)	POP™ Box
12-041-09	4	22 (0.64)	0.33 (8.4)	55 (80)	820 (250)	Coil
12-043-09	4	22 (0.64)	0.33 (8.4)	55 (80)	328 (100)	POP Box



TECHNICAL GUIDELINE

Sag and Tension Technical Guidelines are available for these products. Refer to the "Resources" section on our site for more information.

Buried Distribution Wire

BCBD

PRODUCT DESCRIPTION

BCBD Wire with foam skin insulation is a single jacketed design for use in subscriber distribution.

FEATURES

- Varied pair twist lays
- Core wrap
- Polyethylene jacket

BENEFITS

- Minimizes crosstalk and meets capacitance unbalance limitations
- Furnishes mechanical and high dielectric protection between shielding and individual conductors
- Provides a tough, flexible protective covering that withstands exposure to sunlight, atmospheric temperatures, ground chemicals and stresses expected in standard installations



SPECIFICATIONS

Conductor	Solid annealed copper
AWG (mm)	22 (0.64)
Insulation	Dual-extruded cellular inner layer and a color coded solid outer layer of polyolefin
Core Assembly	Insulated conductors are twisted to form pairs with varying lays
Filling Compound	PEPJ compound applied to the wire core which completely coats each insulated conductor and fills the interstices between pairs
Core Wrap	Non-hygroscopic core wrap applied over the core
Flooding Compound	Applied to fill all the voids under the shield
Shield	Electrically-continuous 8 mil flat aluminum tape shield with a polyolefin film fused and chemically bonded to both sides; applied longitudinally over the core and bonded to the outer jacket
Jacket	Black medium-density polyethylene
Standards Compliance	RoHS-compliant

ELECTRICAL SPECIFICATIONS

Average Mutual Capacitance @ 1,000 Hz nF/mile (nF/km)	Capacitance Unbalance Maximum Individual	
	Pair to Pair pF @ 1 kft (pF @ 1 km)	Pair to Ground pF @ 1 kft (pF @ 1 km)
90 (56)	80 (145)	800 (2,625)

Conductor Size AWG (mm)	Minimum Insulation Resistance @ 60°F (16°C) gigohm-mile (gigohm-km)	Maximum Average Attenuation 772 kHz @ 68°F (20°C) dB/kft (dB/km)	Maximum Conductor Resistance @ 68°F (20°C) Ohms/sheath kft (km)	Resistance Unbalance Maximum % Individual Pair	Dielectric Strength DC Potential - Volts Minimum	
					Conductor to Conductor	Conductor to Shield
22 (0.64)	1.0 (1.6)	4.5 (14.8)	17.3 (56.6)	5.0	3,600	10,000

PART NUMBERS AND PHYSICAL CHARACTERISTICS

Part Number	Pair Count	AWG (mm)	Nominal Diameter in (mm)	Approx. Weight lbs/kft (kg/km)	Standard Length ft (m)	Package
85-233-06	4	22 (0.64)	0.30 (7.6)	45 (65)	4,593 (1,400)	Reel

C-Rural Wire

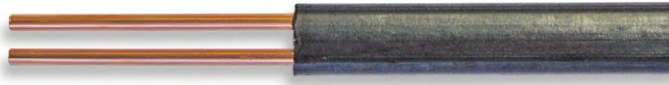

PRODUCT DESCRIPTION

C-Rural Wire is quickly and easily installed, utilizing standard hardware and installation procedures for single circuit aerial distribution rural networks.

SPECIFICATIONS

Conductor	Solid 30% conductivity copper-covered steel
Insulation	Black polyolefin compound extruded over the two conductors in parallel to form an integrated oval configuration
Standards Compliance	Telcordia® TA-TSY-000125 RoHS-compliant

Telcordia is a registered trademark of Ericsson Inc.

PART NUMBERS AND PHYSICAL CHARACTERISTICS

Part Number	AWG (mm)	Dimensions		Approx. Weight lbs/kft (kg/km)	Standard Length ft (m)	Package
		Minor in (mm)	Major in (mm)			
10-026-06	14 (1.63)	0.15 (3.8)	0.28 (7.1)	36 (54)	1,000 (305)	Coil
10-016-06	14 (1.63)	0.15 (3.8)	0.28 (7.1)	36 (54)	5,500 (1,676)	Wooden reel
10-116-06	14 (1.63)	0.15 (3.8)	0.28 (7.1)	36 (54)	22,000 (6,705)	Four 5,500' reels on a pallet



TECHNICAL GUIDELINE

Sag and Tension Technical Guidelines are available for these products. Refer to the "Resources" section on our site for more information.

PRODUCT DESCRIPTION

Multi-pair, self-supporting IMRDW Wire is used for subscriber lines in exchange plant; single-pair is often used for lateral runs from aerial plant. In both single and multi-pair types, the wire core is laid parallel to a solid steel support wire and jacketed in an integral extrusion to form a “figure 8” configuration utilizing a 0.109 inch solid, extra-high strength steel support member. The IM construction permits fast, economical installation and facilitates removal and re-use of wire.



SPECIFICATIONS

Conductor	Solid bare copper
Insulation	Polyolefin
Core Assembly	Twisted into pairs to minimize resistance unbalance; in multi-pair constructions, pair twist lays vary to minimize crosstalk and meet capacitance unbalance requirements; twisted pairs are formed into firm, round core
Core Wrap	Non-hygroscopic, dielectric wrap
Jacket	Black polyethylene
Support Wire	Single 0.109 inch solid, extra-high strength steel, jacketed in an integral extrusion with the core
Standards Compliance	RDUP PE-27 and PE-28 deactivated by RDUP ICEA S-89-648 as applicable RoHS-compliant

ELECTRICAL SPECIFICATIONS

Number of Pairs	Average Mutual Capacitance @ 1,000 Hz nF/mile (nF/km)
Maximum Individual	94 (58)
12 or less	83 ± 7 (52 ± 4)
Over 12	83 ± 4 (52 ± 2)

Conductor Size AWG (mm)	Minimum Insulation Resistance @ 68°F (20°C) megohm-mile (megohm-km)	Maximum Average Attenuation 772 kHz @ 68°F (20°C) dB/kft (dB/km)	Maximum Conductor Resistance @ 68°F (20°C) Ohms/mile (Ohms/km)	DC Resistance Unbalance Maximum % Individual Pair	Dielectric Strength Minimum Volts DC
22 (0.64)	1,000 (1,600)	5.1 (16.7)	91 (56.4)	5.0	7,200
24 (0.51)	1,000 (1,600)	6.5 (21.3)	144 (89.5)	5.0	7,200

Capacitance Unbalance @ 1,000 Hz pF @ 1 kft (pF @ 1 km)	
Maximum Pair to Pair	80 (145)

PART NUMBERS AND PHYSICAL CHARACTERISTICS

Part Number	Pair Count	AWG (mm)	Dimensions		Approx. Weight lbs/kft (kg/km)	Standard Length ft (m)	Package
			Minor in (mm)	Major in (mm)			
10-002-17	2	22 (0.64)	0.20 (5.1)	0.48 (12.2)	60 (90)	5,000 (1,524)	Reel
10-003-17	3	22 (0.64)	0.23 (5.8)	0.51 (12.9)	65 (95)	5,000 (1,524)	Reel
10-004-17	4	22 (0.64)	0.24 (6.0)	0.52 (13.2)	70 (104)	5,000 (1,524)	Reel
10-006-17	6	22 (0.64)	0.29 (7.5)	0.58 (14.8)	85 (125)	5,000 (1,524)	Reel
10-012-17	12	22 (0.64)	0.36 (9.2)	0.65 (16.5)	115 (170)	5,000 (1,524)	Reel
10-006-19	6	24 (0.51)	0.25 (6.4)	0.54 (13.7)	70 (105)	5,000 (1,524)	Reel
10-012-19	12	24 (0.51)	0.32 (8.2)	0.61 (15.4)	95 (140)	5,000 (1,524)	Reel



TECHNICAL GUIDELINE

Sag and Tension Technical Guidelines are available for these products. Refer to the “Resources” section on our site for more information.

IMRDWS



PRODUCT DESCRIPTION

IMRDWS is an aerial wire designed for use in extending communications service (voice, data, and/or video) to a subscriber premises from the distribution point. This product has additional capabilities over the standard IMRDW product because it contains a shielding screen. The conductors are wrapped within a metallic aluminum shield to insulate them from interference and thus provide high-quality digital transmission. In addition, a drain wire runs longitudinally the length of the wire to drain off Electromagnetic Interference (EMI) and Radio Frequency Interference (RFI). Without shielding and a drain wire, noise can be introduced into circuits from high voltage AC power lines, machinery with motors, x-ray systems, TV sets and AM radio stations. Shielding also lessens the chance that DSL or other high frequency transmission protocols will interfere with other signals on adjacent cables.

SPECIFICATIONS

Conductor	Solid bare copper
Insulation	Polyolefin
Core Assembly	Individual conductors carefully twisted into pairs to minimize resistance unbalance and cross-talk
Shield	3 mil foil shield with drain wire
Jacket	Black polyethylene
Rip cord	Placed parallel to the core
Support Wire	"Figure 8" configuration utilizing a 0.109 inch, solid, extra high strength, steel support wire
Standards Compliance	ICEA S-89-648 as applicable RoHS-compliant

FEATURES

- 3 mil foil shield with drain wire
- Black, polyethylene jacket
- Rip cord

BENEFITS

- Provides high-quality digital transmission medium for xDSL technologies and, when properly grounded, removes spectrum interferences
- Provides tough, flexible protective covering that withstands exposure to sunlight, atmospheric temperatures and stresses encountered in standard installations
- Facilitates jacket removal

ELECTRICAL SPECIFICATIONS

All Pairs		Average Mutual Capacitance @ 1,000 Hz nF/mile (nF/km)	
Maximum Individual		94 (58)	
Wire Average		83 ± 7 (52 ± 4)	

Conductor Size AWG (mm)	Minimum Insulation Resistance @ 68°F (20°C) megohm-mile (megohm-km)	Maximum Average Attenuation 772 kHz @ 68°F (20°C) dB/kft (dB/km)	Maximum Conductor Resistance @ 68°F (20°C) Ohms/mile (Ohms/km)	DC Resistance Unbalance Maximum % Individual Pair	Dielectric Strength Minimum Volts DC	
					Conductor to Conductor	Conductor to Shield
22 (0.64)	1,000 (1,600)	5.1 (16.7)	91 (56.4)	5.0	7,200	3,600

Crosstalk Loss dB/kft (dB/km)		Capacitance Unbalance @ 1,000 Hz pF @ 1 kft (pF @ 1 km)	
Minimum FEXT @ 150 kHz		Maximum Individual Pair to Pair	
63 (207)		80 (145)	
Minimum NEXT @ 722 kHz		Maximum Individual Pair to Ground	
44 (144)		800 (2,625)	

PART NUMBERS AND PHYSICAL CHARACTERISTICS

Part Number	Pair Count	AWG (mm)	Dimensions		Approx. Weight lbs/kft (kg/km)	Standard Length ft (m)	Package
			Minor in (mm)	Major in (mm)			
10-061-29	6	22 (0.64)	0.32 (8.1)	0.60 (15.3)	95 (142)	2,133 (650)	Reel
10-040-29	6	22 (0.64)	0.32 (8.1)	0.60 (15.3)	95 (142)	5,000 (1,524)	Reel



TECHNICAL GUIDELINE

Sag and Tension Technical Guidelines are available for these products. Refer to the "Resources" section on our site for more information.

PRODUCT DESCRIPTION

ADP NMS is a PVC-jacketed Aerial Service Wire offered in 1, 2, 3, 5 or 6-pair. It is designed for use in extending telephone service to subscriber premises from the distribution cable or cable terminal. Major features include small size and light weight coupled with abrasion resistant jacket. Standard hardware and installation procedures are directly applicable to this product. The insulation of the tip conductor is marked with a stripe of the mating ring insulation color to reduce the possibility of splitting pairs during installation. A black, weather resistant, polyvinyl chloride jacket is extruded over the strength members and rip cord to protect the core from mechanical damage, degradation by sunlight and ingress of moisture. The jacket bonds to the strength members to provide the required strength characteristics.

FEATURES

- Non-metallic or fiberglass strength members
- Rip cord

BENEFITS

- Provide necessary longitudinal strength
- Facilitates jacket removal



SPECIFICATIONS

Conductor	Solid annealed copper
Insulation	Polyolefin
Core Assembly	Individual conductors are carefully twisted into pairs in a manner designed to minimize resistance unbalance
Strength Members	Non-metallic or fiberglass strength members placed in jacket parallel to core assembly
Rip cord	Placed parallel to the core
Jacket	Weather-resistant PVC
Performance Compliance	Telcordia® GR-3163-CORE RDUP PE 7 ANSI/ICEA S-89-648-2011 RoHS-compliant
NRTL Programs	UL® Listed

Telcordia is a registered trademark of Ericsson Inc. UL is a registered trademark of UL LLC.

ELECTRICAL SPECIFICATIONS

Number of Pairs		Average Mutual Capacitance @ 1,000 Hz nF/mile (nF/km)			
Maximum Pair		94 (58)			
Maximum Average		90 (56)			

Conductor Size AWG (mm)	Minimum Insulation Resistance @ 68°F (20°C) megohm-mile (megohm-km)	Maximum Average Attenuation 772 kHz @ 68°F (20°C) dB/kft (dB/km)	Maximum Conductor Resistance @ 68°F (20°C) Ohms/mile (Ohms/km)	DC Resistance Unbalance Maximum % Individual Pair	Conductor to Conductor Dielectric Strength Volts DC 3 secs, no breakdown
22 (0.64)	1,000 (1,600)	5.1 (17)	91 (56.5)	5.0	4,000

Crosstalk Loss dB/kft (dB/km)		Capacitance Unbalance @ 1,000 Hz pF @ 1 kft (pF @ 1 km)	
Minimum NEXT @ 722 kHz		Maximum Individual Pair	
44 (144)		80 (145)	

PART NUMBERS AND PHYSICAL CHARACTERISTICS

Part Number	Pair Count	AWG (mm)	Dimensions		Approx. Weight lbs/kft (kg/km)	Standard Length ft (m)	Package
			Minor in (mm)	Major in (mm)			
12-031-08	1	22 (0.64)	0.18 (4.8)	0.36 (9.1)	34 (51)	750 (229)	POP™ box
12-004-08	2	22 (0.64)	0.18 (4.8)	0.36 (9.1)	39 (58)	750 (229)	POP box
12-010-08	2	22 (0.64)	0.18 (4.8)	0.36 (9.1)	39 (58)	1,000 (305)	Coil
12-023-08	2	22 (0.64)	0.18 (4.8)	0.36 (9.1)	39 (58)	5,000 (1,524)	Reel
12-019-08	3	22 (0.64)	0.21 (5.3)	0.39 (9.9)	45 (67)	600 (183)	POP box
12-022-08	3	22 (0.64)	0.21 (5.3)	0.39 (9.9)	45 (67)	750 (229)	Coil
12-519-08	5	22 (0.64)	0.27 (7.0)	0.48 (12.0)	76 (113)	400 (122)	POP box
12-024-08	5	22 (0.64)	0.27 (7.0)	0.48 (12.0)	76 (113)	2,500 (762)	Reel
12-025-08	5	22 (0.64)	0.27 (7.0)	0.48 (12.0)	76 (113)	1,000 (305)	Reel
12-026-08	5	22 (0.64)	0.27 (7.0)	0.48 (12.0)	76 (113)	700 (213)	IPL coil
12-006-08	6	22 (0.64)	0.27 (7.0)	0.48 (12.0)	80 (119)	400 (122)	Coil
12-007-08	6	22 (0.64)	0.27 (7.0)	0.48 (12.0)	80 (119)	2,500 (762)	Reel
12-008-08	6	22 (0.64)	0.27 (7.0)	0.48 (12.0)	80 (119)	3,500 (1,068)	Reel
12-009-08	6	22 (0.64)	0.27 (7.0)	0.48 (12.0)	80 (119)	1,000 (305)	Reel



TECHNICAL GUIDELINE

Sag and Tension Technical Guidelines are available for these products. Refer to the "Resources" section on our site for more information.

ADP NMS Compact Design

6 x 24



SPECIFICATIONS

Conductor	Solid annealed copper
Insulation	Polyolefin
Core Assembly	Individual conductors are carefully twisted into pairs in a manner designed to minimize resistance unbalance
Strength Members	Non-metallic or fiberglass strength members placed in jacket parallel to core assembly
Rip cord	Placed parallel to the core
Jacket	Weather-resistant PVC
Performance Compliance	GR-3163-CORE as applicable ANSI/ICEA S-89-648-2011 RoHS-compliant
NRTL Programs	UL® Listed

UL is a registered trademark of UL LLC.

ELECTRICAL SPECIFICATIONS

	Number of Pairs	Average Mutual Capacitance @ 1,000 Hz nF/mile (nF/km)		
	Maximum Individual	94 (58)		
	Wire Average	83 ± 7 (52 ± 4)		
Conductor Size AWG (mm)	Minimum Insulation Resistance @ 68°F (20°C) megohm-mile (megohm-km)	Maximum Average Attenuation 772 kHz @ 68°F (20°C) dB/kft (dB/km)	Maximum Conductor Resistance @ 68°F (20°C) Ohms/mile (Ohms/km)	DC Resistance Unbalance Maximum % Individual Pair
24 (0.51)	1,000 (1,600)	5.8 (19.0)	144 (89.5)	5.0
	Crosstalk Loss dB/kft (dB/km)		Capacitance Unbalance @ 1,000 Hz pF @ 1 kft (pF @ 1 km)	
Minimum FEXT @ 150 kHz	63 (207)		Maximum Individual Pair	
Minimum NEXT @ 722 kHz	44 (144)		80 (145)	

PART NUMBERS AND PHYSICAL CHARACTERISTICS

Part Number	Pair Count	AWG (mm)	Dimensions		Approx. Weight lbs/kft (kg/km)	Standard Length ft (m)	Package
			Minor in (mm)	Major in (mm)			
12-801-08	6	24 (0.51)	0.21 (5.3)	0.38 (9.7)	50 (74)	600 (183)	POP™ box
12-802-08	6	24 (0.51)	0.21 (5.3)	0.38 (9.7)	50 (74)	1,000 (305)	Reel



TECHNICAL GUIDELINE

Sag and Tension Technical Guidelines are available for these products. Refer to the "Resources" section on our site for more information.

PRODUCT DESCRIPTION

The ADP NMS 6 x 24 Compact Design features a black abrasion resistant PVC-jacket and is used to extend telephone service to subscriber premises from the distribution cable or cable terminal. The product features four fiberglass yarns that provide all the longitudinal strength necessary. Simple access procedures allow for quick and easy installation with the small standard off the shelf industry hardware. This product offers 6-pair in the size and shape of the traditional 3-pair product. Each conductor is insulated with solid polyolefin in distinctive colors. The insulation of the tip conductor is marked with a stripe of the mating ring insulation color to reduce the possibility of splitting pairs during installation. A black, weather resistant, polyvinyl chloride jacket is extruded over the strength members and rip cord to protect the core from mechanical damage. The jacket bonds to the fiber glass strength members to provide the required strength characteristics.

FEATURES

- Non-metallic or fiberglass strength members
- Rip cord

BENEFITS

- Provide necessary longitudinal strength
- Facilitates jacket removal

PRODUCT DESCRIPTION

ADP S is a PVC-jacketed, aerial service wire designed for use in extending communications service (voice, data and/or video) to a subscriber premises from the distribution cable terminal. This product has additional capabilities over the standard ADP NMS product because it contains a shielding screen. The core is wrapped within a metallic foil to provide shielding from interference and thus provide high-quality digital transmission. In addition, a drain wire runs longitudinally the length of the wire to drain off Electromagnetic Interference (EMI) and Radio Frequency Interference (RFI). Without shielding and a drain wire, noise can be introduced into circuits from high voltage AC power lines, machinery with motors, x-ray systems, TV sets and AM radio stations. Shielding also lessens the chance that DSL or other high frequency transmission protocols will interfere with other signals on adjacent cables. Each conductor is insulated with solid polyolefin in distinctive colors. The insulation of the tip conductor is marked with a stripe of the mating ring insulation color to reduce the possibility of splitting pairs during installation. A black, weather resistant, polyvinyl chloride jacket is extruded over the yarns and rip cord to protect the core from mechanical damage, degradation by sunlight and ingress of moisture. The jacket bonds to the fiberglass strength members to provide the required strength characteristics.

FEATURES

- 3 mil metallic foil shield with drain wire
- Non-metallic or fiberglass strength members
- Rip cord

BENEFITS

- Provides high-quality digital transmission medium for xDSL technologies and, when properly grounded, removes spectrum interferences
- Provide necessary longitudinal strength
- Facilitates jacket removal



SPECIFICATIONS

Conductor	Solid annealed copper
Insulation	Polyolefin
Core Assembly	Individual conductors are carefully twisted into pairs in a manner designed to minimize resistance unbalance
Shield	3 mil metallic foil shield with drain wire
Strength Members	Non-metallic or fiberglass strength members placed in jacket parallel to core assembly
Rip cord	Placed parallel to the core
Jacket	Weather-resistant PVC
Performance Compliance	Applicable sections of both GR-3163-CORE and ANSI/ICEA S-89-648-2011 RoHS-compliant
NRTL Programs	UL® Listed

UL is a registered trademark of UL LLC.

ELECTRICAL SPECIFICATIONS

		Number of Pairs		Average Mutual Capacitance @ 1,000 Hz nF/mile (nF/km)	
		Maximum Pair		94 (58)	
		Maximum Average		90 (56)	
Conductor Size AWG (mm)	Minimum Insulation Resistance @ 68°F (20°C) megohm-mile (megohm-km)	Maximum Average Attenuation 772 kHz @ 68°F (20°C) dB/kft (dB/km)	Maximum Conductor Resistance @ 68°F (20°C) Ohms/mile (Ohms/km)	DC Resistance Unbalance Maximum % Individual Pair	Conductor to Conductor Dielectric Strength Volts DC 3 secs, no breakdown
22 (0.64)	1,000 (1,600)	5.1 (17)	91 (56.5)	5.0	4,000
			Crosstalk Loss dB/kft (dB/km)	Capacitance Unbalance @ 1,000 Hz pF @ 1 kft (pF @ 1 km)	
Minimum NEXT @ 722 kHz			44 (144)	Maximum Individual Pair	80 (145)

PART NUMBERS AND PHYSICAL CHARACTERISTICS

Part Number	Pair Count	AWG (mm)	Dimensions		Approx. Weight lbs/kft (kg/km)	Standard Length ft (m)	Package
			Minor in (mm)	Major in (mm)			
12-101-07	1	22 (0.64)	0.21 (5.3)	0.39 (9.9)	37 (49)	1,000 (305)	Reel
12-301-07	3	22 (0.64)	0.27 (6.8)	0.45 (11.4)	55 (82)	1,000 (305)	Reel
12-302-07	3	22 (0.64)	0.27 (6.8)	0.45 (11.4)	55 (82)	400 (122)	POP™ box
12-303-07	3	22 (0.64)	0.27 (6.8)	0.45 (11.4)	55 (82)	750 (229)	Reel
12-304-07	3	22 (0.64)	0.27 (6.8)	0.45 (11.4)	55 (82)	750 (229)	Coil
12-305-07	3	22 (0.64)	0.27 (6.8)	0.45 (11.4)	55 (82)	500 (152)	Reel-in-a-Box
12-501-07	5	22 (0.64)	0.28 (7.1)	0.49 (12.0)	78 (116)	1,000 (305)	Reel



TECHNICAL GUIDELINE

Sag and Tension Technical Guidelines are available for these products. Refer to the “Resources” section on our site for more information.

Integrated Messenger Wire

IM/F, IM/H and IM/G



SPECIFICATIONS

Conductor	Solid annealed copper
Insulation	Polyolefin
Core Assembly	Individual conductor dimensions are tightly controlled to limit resistance unbalance of the twisted pairs; in multi-pair constructions, pair twist lays are varied to minimize crosstalk and meet capacitance limits; twisted pairs are formed into a firm, round core
Jacket	Fire retardant PVC
Performance Compliance	Telcordia® GR-3163-CORE ANSI/ICEA S-89-648-2011 RoHS-compliant
NRTL Programs	UL® Listed

Telcordia is a registered trademark of Ericsson Inc. UL is a registered trademark of UL LLC.

PRODUCT DESCRIPTION

IM/F, IM/H and IM/G aerial service wire in 2, 3, 6 and 12-pair is self supporting. The conductors are laid parallel to an (F) 0.083 inch, (H) 0.109 inch, or (G) 0.095 inch solid extra-strength steel support wire. Both the conductors and support wire are jacketed in an integral "figure 8" configuration. This product permits fast, economical installation from aerial distribution cable terminals to building entrance protectors or network interface units on the subscriber's premises. The fully color coded core expedites splicing and terminating procedures. A black, fire retardant, polyvinyl chloride jacket provides a tough flexible protective covering that withstands exposure to sunlight, atmospheric temperatures and stresses encountered in standard installations. The steel support wire is jacketed in an integral extrusion with the core.



TECHNICAL GUIDELINE

Sag and Tension Technical Guidelines are available for these products. Refer to the "Resources" section on our site for more information.

ELECTRICAL SPECIFICATIONS

Number of Pairs	Average Mutual Capacitance @ 1,000 Hz nF/mile (nF/km)				
	Maximum Pair	94 (58)			
Maximum Average	90 (56)				
Conductor Size AWG (mm)	Minimum Insulation Resistance @ 68°F (20°C) megohm-mile (megohm-km)	Maximum Average Attenuation 772 kHz @ 68°F (20°C) dB/kft (dB/km)	Maximum Conductor Resistance @ 68°F (20°C) Ohms/mile (Ohms/km)	DC Resistance Unbalance Maximum % Individual Pair	Conductor to Conductor Dielectric Strength Minimum Volts DC 3 secs, no breakdown
19 (0.90)	1,000 (1,600)	3.6 (11.8)	45 (28.0)	5.0	-
22 (0.64)	1,000 (1,600)	5.1 (17.0)	91 (56.5)	5.0	4,000
Crosstalk Loss dB/kft (dB/km)		Capacitance Unbalance @ 1,000 Hz pF @ 1 kft (pF @ 1 km)			
Minimum NEXT @ 722 kHz		44 (144)		Maximum Individual Pair to Pair 80 (145)	
				Maximum Individual Pair to Ground 800 (2,625)	

PART NUMBERS AND PHYSICAL CHARACTERISTICS

Part Number	Support Size	Pair Count	AWG (mm)	Dimensions		Approx. Weight lbs/kft (kg/km)	Standard Length ft (m)	Package
				Minor in (mm)	Major in (mm)			
10-921-38	IM/G 0.095	2	19 (0.90)	0.27 (6.8)	0.51 (12.9)	73 (109)	656 (200)	Coil
10-923-38	IM/G 0.095	2	19 (0.90)	0.27 (6.8)	0.51 (12.9)	73 (109)	4,921 (1,500)	Reel
10-002-34	IM/F 0.083	2	22 (0.64)	0.22 (5.7)	0.46 (11.7)	55 (82)	600 (183)	Coil
10-102-34	IM/F 0.083	2	22 (0.64)	0.22 (5.7)	0.46 (11.7)	55 (82)	5,000 (1,524)	Reel
10-503-34	IM/F 0.083	3	22 (0.64)	0.24 (6.2)	0.48 (12.3)	72 (107)	1,000 (305)	Coil
10-106-34	IM/F 0.083	6	22 (0.64)	0.30 (7.6)	0.53 (13.6)	80 (119)	3,500 (1,067)	Reel
10-206-34	IM/F 0.083	6	22 (0.64)	0.30 (7.6)	0.53 (13.6)	80 (119)	1,000 (305)	Reel
10-261-38	IM/G 0.095	6	22 (0.64)	0.30 (7.6)	0.55 (13.9)	80 (119)	492 (150)	Coil
10-262-38	IM/G 0.095	6	22 (0.64)	0.30 (7.6)	0.55 (13.9)	80 (119)	2,461 (750)	Reel
10-265-38	IM/G 0.095	6	22 (0.64)	0.30 (7.6)	0.55 (13.9)	80 (119)	5,000 (1,562)	Reel
10-281-38	IM/G 0.095	12	22 (0.64)	0.38 (7.6)	0.65 (16.6)	114 (170)	410 (125)	Coil
10-284-38	IM/G 0.095	12	22 (0.64)	0.38 (7.6)	0.65 (16.6)	114 (170)	2,460 (750)	Reel
10-285-38	IM/G 0.095	12	22 (0.64)	0.38 (7.6)	0.65 (16.6)	114 (170)	8,202 (2,500)	Reel
10-102-35	IM/H 0.109	12	22 (0.64)	0.38 (7.6)	0.66 (16.7)	130 (193)	1,000 (305)	Reel
10-012-35	IM/H 0.109	12	22 (0.64)	0.38 (7.6)	0.66 (16.7)	130 (193)	250 (76)	Coil
10-212-35	IM/H 0.109	12	22 (0.64)	0.38 (7.6)	0.66 (16.7)	130 (193)	5,000 (1,524)	Reel

Contact Superior Essex for additional configurations and AWG sizes.

PRODUCT DESCRIPTION

BDW A is a filled, double-jacketed buried wire intended for direct burial applications. Applications include distribution circuits and service entrance wires. BDW A is designed to withstand installation stresses. BDW A is filled with an ETPR compound, which completely coats each insulated conductor and fills the air space between conductors. BDW A is recommended for non-gopher areas. Each conductor is insulated with solid polyolefin in distinctive colors. The insulation of the tip conductor is marked with a stripe of the mating ring insulation color to reduce the possibility of splitting pairs during installation.

APPLICATIONS

- Direct burial
- Distribution circuits and service entrance wires

FEATURES

- Polyethylene inner jacket
- Polyethylene outer jacket
- Dual rip cords

BENEFITS

- Provides additional mechanical and moisture protection
- Provides tough, flexible, protective covering that withstands exposure to sunlight, atmospheric temperatures, ground chemicals and stresses expected in standard installations
- Facilitates jacket removal

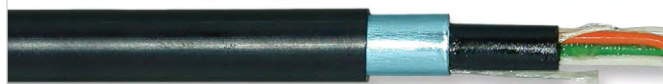

SPECIFICATIONS

Conductor	Solid annealed copper
Insulation	Polyolefin
Core Assembly	Individual conductor dimensions are tightly controlled to limit resistance unbalance of twisted pairs; pair twist lays are varied to minimize crosstalk and meet capacitance unbalance limits
Filling Compound	Wire core is completely filled with 80°C ETPR compound, filling the air spaces between insulated conductors
Inner Jacket	Polyethylene
Shield	Smooth, copolymer-coated, 8 mil aluminum tape applied longitudinally over inner jacket and bonded to outer jacket; space under the tape is flooded to eliminate all air space
Outer Jacket	Black, polyethylene
Standards Compliance	ANSI/ICEA S-86-634-2011 RoHS-compliant

ELECTRICAL SPECIFICATIONS

All Pairs		Average Mutual Capacitance @ 1,000 Hz nF/mile (nF/km)	
Maximum Individual		94 (58)	
Wire Average		83 ± 7 (52 ± 4)	

Conductor Size AWG (mm)	Minimum Insulation Resistance @ 68°F (20°C) megohm-mile (megohm-km)	Maximum Average Attenuation 772 kHz @ 68°F (20°C) dB/kft (dB/km)	Maximum Conductor Resistance @ 68°F (20°C) Ohms/mile (Ohms/km)	DC Resistance Unbalance Maximum % Individual Pair	Dielectric Strength Minimum Volts DC	
					Conductor to Conductor	Conductor to Shield
19 (0.90)	1,000 (1,600)	3.1 (10.2)	45 (28.0)	5.0	7,000	20,000
22 (0.64)	1,000 (1,600)	4.4 (14.4)	91 (56.4)	5.0	5,000	20,000
24 (0.51)	1,000 (1,600)	5.5 (18.0)	144 (89.5)	5.0	4,000	20,000

Minimum NEXT @ 722 kHz	Crosstalk Loss dB/kft (dB/km)	Capacitance Unbalance @ 1,000 Hz pF @ 1 kft (pF @ 1 km)	
		44 (144)	Maximum Individual Pair to Pair
		Maximum Individual Pair to Ground	800 (2,625)

PART NUMBERS AND PHYSICAL CHARACTERISTICS

Part Number	Pair Count	AWG (mm)	Nominal Diameter in (mm)	Approx. Weight lbs/kft (kg/km)	Standard Length ft (m)	Package
04-023-85	2	19 (0.90)	0.38 (9.7)	65 (97)	5,000 (1,524)	Reel
04-025-85	3	19 (0.90)	0.42 (11)	85 (125)	5,000 (1,524)	Reel
04-052-84	2	22 (0.64)	0.32 (8.1)	45 (65)	1,000 (305)	Reel
04-053-84	2	22 (0.64)	0.32 (8.1)	45 (65)	2,500 (762)	Reel
04-055-84	2	22 (0.64)	0.32 (8.1)	45 (65)	5,000 (1,524)	Reel
04-056-84	3	22 (0.64)	0.33 (8.4)	50 (75)	1,000 (305)	Reel
04-062-84	3	22 (0.64)	0.33 (8.4)	50 (75)	2,500 (762)	Reel
04-058-84	3	22 (0.64)	0.33 (8.4)	50 (75)	5,000 (1,524)	Reel
04-061-85	6	22 (0.64)	0.41 (10)	80 (120)	1,000 (305)	Reel
04-058-85	6	22 (0.64)	0.41 (10)	80 (120)	2,500 (762)	Reel
04-057-85	6	22 (0.64)	0.41 (10)	80 (120)	5,000 (1,524)	Reel
04-098-85	2	24 (0.51)	0.27 (6.9)	30 (45)	5,000 (1,524)	Reel
04-101-85	3	24 (0.51)	0.29 (7.4)	40 (60)	5,000 (1,524)	Reel
04-097-85	6	24 (0.51)	0.35 (8.9)	55 (80)	5,000 (1,524)	Reel

BDW G



SPECIFICATIONS

Conductor	Solid annealed copper
Insulation	Polyolefin
Core Assembly	Individual conductor dimensions are tightly controlled to limit resistance unbalance of twisted pairs; pair twist lays are varied to minimize crosstalk and meet capacitance unbalance limits
Filling Compound	Wire core is completely filled with 80°C ETPR compound, filling the air spaces between insulated conductors
Inner Jacket	Polyethylene
Shield	Corrugated, 5 mil gopher resistant armor applied longitudinally over the inner jacket and flooded
Outer Jacket	Black polyethylene
Standards Compliance	*RDUP 7 CFR 1755.860 (PE-86) ANSI/ICEA S-86-634-2011 RoHS-compliant

PRODUCT DESCRIPTION

BDW G is a filled, double-jacketed buried wire intended for direct burial applications. Applications include distribution circuits and service entrance wires. All types are designed to withstand installation stresses. They are filled with an ETPR compound, which completely coats each insulated conductor and fills the air space between conductors. BDW G also provides protection from rodents or harsh environments. Each conductor is insulated with solid polyolefin in distinctive colors. The insulation of the tip conductor is marked with a stripe of the mating ring insulation color to reduce the possibility of splitting pairs during installation.

FEATURES

- Polyethylene inner jacket
- Corrugated armor
- Polyethylene outer jacket

BENEFITS

- Provides additional mechanical and moisture protection
- Gopher resistant
- Provides excellent mechanical protection
- Provides tough, flexible, protective covering that withstands exposure to sunlight, atmospheric temperatures, ground chemicals and stresses expected in standard installations

ELECTRICAL SPECIFICATIONS

All Pairs		Average Mutual Capacitance @ 1,000 Hz nF/mile (nF/km)				
Maximum Individual		94 (58)				
Wire Average		83 ± 7 (52 ± 4)				

Conductor Size AWG (mm)	Minimum Insulation Resistance @ 68°F (20°C) megohm-mile (megohm-km)	Maximum Average Attenuation 772 kHz @ 68°F (20°C) dB/kft (dB/km)	Maximum Conductor Resistance @ 68°F (20°C) Ohms/mile (Ohms/km)	DC Resistance Unbalance Maximum % Individual Pair	Dielectric Strength Minimum Volts DC	
					Conductor to Conductor	Conductor to Shield
22 (0.64)	1,000 (1,600)	4.4 (14.4)	91 (56.4)	5.0	5,000	20,000
24 (0.51)	1,000 (1,600)	5.5 (18.0)	144 (89.5)	5.0	4,000	20,000

Minimum NEXT @ 722 kHz	Crosstalk Loss dB/kft (dB/km)	Capacitance Unbalance @ 1,000 Hz pF @ 1 kft (pF @ 1 km)	
		44 (144)	Maximum Individual Pair to Pair
		Maximum Individual Pair to Ground	800 (2,625)

PART NUMBERS AND PHYSICAL CHARACTERISTICS

Part Number	Pair Count	AWG (mm)	Nominal Diameter in (mm)	Approx. Weight lbs/kft (kg/km)	Standard Length ft (m)	Package
04-052-17	2	22 (0.64)	0.32 (8.1)	55 (80)	1,000 (305)	Reel
04-053-17	2	22 (0.64)	0.32 (8.1)	55 (80)	2,500 (762)	Reel
04-055-17	2	22 (0.64)	0.32 (8.1)	55 (80)	5,000 (1,524)	Reel
04-056-17	3	22 (0.64)	0.33 (8.4)	60 (90)	1,000 (305)	Reel
04-057-17	3	22 (0.64)	0.33 (8.4)	60 (90)	2,500 (762)	Reel
04-058-17	3	22 (0.64)	0.33 (8.4)	60 (90)	5,000 (1,524)	Reel
04-067-16*	6	22 (0.64)	0.40 (10)	90 (135)	1,000 (305)	Reel
04-062-16*	6	22 (0.64)	0.40 (10)	90 (135)	2,500 (762)	Reel
04-057-16*	6	22 (0.64)	0.40 (10)	90 (135)	5,000 (1,524)	Reel
04-094-16	2	24 (0.51)	0.27 (6.9)	40 (60)	5,000 (1,524)	Reel
04-091-16	3	24 (0.51)	0.29 (7.4)	45 (65)	5,000 (1,524)	Reel

PRODUCT DESCRIPTION

BW GDJ, available in 2, 3, 5 and 6-pair sizes, is intended for direct burial applications and is well-suited to withstand installation stresses. It is filled with an ETPR compound, which is chemically and electrically compatible with all other materials in the wire. The compound completely coats each insulated conductor and fills the air space between conductors. BW GDJ effectively combats attacks by rodents. It can be used for distribution circuits and service entrance wires. Each conductor is insulated with solid polyolefin distinctive colors. The insulation of the tip conductor is marked with a stripe of the mating ring insulation color to reduce the possibility of splitting pairs during installation. A black, polyvinyl chloride jacket is extruded over the armor to protect the core from minor mechanical damage, degradation by sunlight and the ingress of moisture.

FEATURES

- Polyethylene inner jacket
- Corrugated armor
- Armor's inner and outer surfaces are flooded
- Rip cord

BENEFITS

- Provides additional mechanical and moisture protection
- Gopher resistant
- Prevents water flow between the shield and outer jacket
- Facilitates jacket removal



SPECIFICATIONS

Conductor	Solid annealed copper
Insulation	Polyolefin
Core Assembly	Conductors are twisted into pairs in a manner designed to minimize resistance unbalance; pair twist lays are varied to minimize crosstalk
Filling Compound	Wire core is completely filled with 80°C ETPR compound, filling the air spaces between insulated conductors
Inner Jacket	Polyethylene inner jacket; outer surface flooded
Armor	Corrugated armor applied longitudinally over the inner jacket; inner and outer surfaces of the armor are flooded
Rip cord	Rip cord is applied beneath the inner jacket; a second rip cord can also be applied under the outer jacket
Jacket	Weather resistant PVC
Standards Compliance	Telcordia® GR-3163-CORE ANSI/ICEA S-86-634-2011 RoHS-compliant

Telcordia is a registered trademark of Ericsson Inc.

ELECTRICAL SPECIFICATIONS

All Pairs		Average Mutual Capacitance @ 1,000 Hz nF/mile (nF/km)					
Maximum Pair		94 (58)					
Maximum Average		90 (56)					
Conductor Size AWG (mm)	Minimum Insulation Resistance @ 68°F (20°C) megohm-mile (megohm-km)	Maximum Average Attenuation 772 kHz @ 68°F (20°C) dB/kft (dB/km)	Maximum Conductor Resistance @ 68°F (20°C) Ohms/mile (Ohms/km)	DC Resistance Unbalance Maximum % Individual Pair	Dielectric Strength Minimum Volts DC		
					Conductor to Conductor	Conductor to Shield	
19 (0.90)	1,000 (1,600)	3.1 (11)	45 (28.0)	5.0	7,000	20,000	
22 (0.64)	1,000 (1,600)	4.4 (14)	91 (56.5)	5.0	5,000	20,000	

Crosstalk Loss dB/kft (dB/km)		Capacitance Unbalance @ 1,000 Hz pF @ 1 kft (pF @ 1 km)	
Minimum NEXT @ 722 kHz	44 (144)	Maximum Individual Pair to Pair	80 (145)
		Maximum Individual Pair to Ground	800 (2,625)

PART NUMBERS AND PHYSICAL CHARACTERISTICS

Part Number	Pair Count	AWG (mm)	Nominal Diameter in (mm)	Approx. Weight lbs/kft (kg/km)	Standard Length ft (m)	Package
25-020-79	2	19 (0.90)	0.37 (9.4)	80 (119)	900 (275)	Reel
25-021-79	2	19 (0.90)	0.37 (9.4)	80 (119)	7,000 (2,135)	Reel
25-063-79	2	22 (0.64)	0.37 (9.4)	80 (119)	600 (183)	Coil
25-064-79	2	22 (0.64)	0.37 (9.4)	80 (119)	5,000 (1,524)	Reel
25-351-79	3	22 (0.64)	0.33 (8.4)	70 (104)	500 (152)	Coil
25-355-79	3	22 (0.64)	0.33 (8.4)	70 (104)	600 (183)	Reel
25-360-79	3	22 (0.64)	0.33 (8.4)	70 (104)	1,200 (366)	Reel
25-354-79	3	22 (0.64)	0.33 (8.4)	70 (104)	3,000 (915)	Reel
25-361-79	3	22 (0.64)	0.33 (8.4)	70 (104)	8,000 (2,438)	Reel
25-552-79	5	22 (0.64)	0.38 (9.0)	90 (134)	500 (152)	Coil
25-555-79	5	22 (0.64)	0.38 (9.0)	90 (134)	1,000 (305)	Reel
25-547-79	5	22 (0.64)	0.38 (9.0)	90 (134)	2,000 (610)	Reel
25-553-79	5	22 (0.64)	0.38 (9.0)	90 (134)	5,000 (1,524)	Reel
25-681-79	6	22 (0.64)	0.40 (10.0)	100 (149)	800 (244)	Reel
25-654-79	6	22 (0.64)	0.40 (10.0)	100 (149)	350 (107)	Coil
25-662-79	6	22 (0.64)	0.40 (10.0)	100 (149)	1,000 (305)	Reel
25-663-79	6	22 (0.64)	0.40 (10.0)	100 (149)	2,000 (610)	Reel
25-653-79	6	22 (0.64)	0.40 (10.0)	100 (149)	3,000 (915)	Reel
25-658-79	6	22 (0.64)	0.40 (10.0)	100 (149)	5,000 (1,524)	Reel



Off The Reel

SUPERIOR ESSEX BI-MONTHLY E-NEWSLETTER

Sign up for the Superior Essex e-newsletter and receive a comprehensive bi-monthly snapshot of the latest news from Superior Essex and around the industry, all delivered to your e-mail.

Register online today at
ce.SuperiorEssex.com/News/Newsletters



800.551.8948
SuperiorEssex.com

All information, content, data, specifications, packaging and part numbers detailed herein are subject to change. For the most up-to-date information, please visit SuperiorEssex.com. Purchase of this product is subject exclusively to the then current Superior Essex International LP Terms and Conditions of Sale for Communications and Energy Cable, Wire and Connectivity Products, which can be found on our website, SuperiorEssex.com, or provided to you upon request.

PRODUCT DESCRIPTION

The Buried Wire Aluminum Filled (BW AF) cable is designed for direct burial applications and is available in 2, 3, 5 and 6 pair sizes. It is filled with an ETPR compound which is chemically and electrically compatible with all other materials in the wire. The compound completely coats each insulated conductor and fills the space between conductors. BW AF can also be used for distribution circuits and service entrance wires. Each conductor is insulated with solid polyolefin in distinctive colors. The insulation of the tip conductor is marked with a stripe of the mating ring insulation color to reduce the possibility of splitting pairs during installation. A black, weather-resistant polyvinyl chloride jacket is extruded over the shield and rip cord to protect the core from minor mechanical damage, degradation by sunlight and ingress of moisture and water.

FEATURES

- Non-hygroscopic core wrap
- Adhesive compound floods shield's outer surface
- Rip cord

BENEFITS

- Protects the core and provides improved mechanical and electrical characteristics
- Provides a moisture barrier and inhibits corrosion
- Facilitates jacket removal



SPECIFICATIONS

Conductor	Solid annealed copper
Insulation	Polyolefin
Core Assembly	Individual conductor dimensions are tightly controlled to limit resistance unbalance of twisted pairs; pair twist lays are varied to minimize crosstalk and meet capacitance unbalance limits
Core Covering	Non-hygroscopic core wrap
Filling Compound	Wire core is completely filled with 80°C ETPR compound, filling the spaces between insulated conductors
Shield	Corrugated 6-mil (2-pair/3-pair) or 8 mil (5-pair/6-pair) bare aluminum tape longitudinally applied over the core wrap
Rip cord	Rip cord applied over shield and beneath jacket
Jacket	Weather-resistant PVC
Standards Compliance	Telcordia® GR-3163-CORE ANSI/ICEA S-86-634-2011 RoHS-compliant

Telcordia is a registered trademark of Ericsson Inc.

ELECTRICAL SPECIFICATIONS

Conductor Size AWG (mm)	Minimum Insulation Resistance @ 68°F (20°C) megohm-mile (megohm-km)	Maximum Average Attenuation 772 kHz @ 68°F (20°C) dB/kft (dB/km)	Maximum Conductor Resistance @ 68°F (20°C) Ohms/mile (Ohms/km)	DC Resistance Unbalance Maximum % Individual Pair	Dielectric Strength Minimum Volts DC	
					Conductor to Conductor	Conductor to Shield
22 (0.64)	1,000 (1,600)	4.4 (14)	91 (56.5)	5.0	5,000	15,000
All Pairs		Average Mutual Capacitance @ 1,000 Hz nF/mile (nF/km)	Crosstalk Loss dB/kft (dB/km)		Capacitance Unbalance @ 1,000 Hz pF @ 1 kft (pF @ 1 km)	
Maximum Pair	94 (58)		Minimum NEXT @ 722 kHz	44 (144)	Maximum Individual Pair to Pair	80 (145)
Maximum Average	90 (56)			Maximum Individual Pair to Ground	800 (2,625)	

PART NUMBERS AND PHYSICAL CHARACTERISTICS

Part Number	Pair Count	AWG (mm)	Nominal Diameter in (mm)	Approx. Weight lbs/kft (kg/km)	Standard Length ft (m)	Package
25-063-86	2	22 (0.64)	0.27 (6.9)	43 (64)	250 (76)	Coil
25-062-86	2	22 (0.64)	0.27 (6.9)	43 (64)	700 (214)	Coil
25-257-86	2	22 (0.64)	0.27 (6.9)	43 (64)	1,250 (381)	Coil (IPL)
25-069-86	2	22 (0.64)	0.27 (6.9)	43 (64)	1,300 (396)	Reel
25-061-86	2	22 (0.64)	0.27 (6.9)	43 (64)	1,500 (457)	Reel
25-064-86	2	22 (0.64)	0.27 (6.9)	43 (64)	3,000 (915)	Reel
25-078-86	2	22 (0.64)	0.27 (6.9)	43 (64)	8,250 (2,154)	Reel
25-351-86	3	22 (0.64)	0.30 (7.6)	53 (79)	500 (152)	Coil
25-360-86	3	22 (0.64)	0.30 (7.6)	53 (79)	1,200 (366)	Reel
25-353-86	3	22 (0.64)	0.30 (7.6)	53 (79)	3,000 (914)	Reel
25-154-86	5	22 (0.64)	0.33 (8.4)	67 (100)	500 (152)	Coil
25-554-86	5	22 (0.64)	0.33 (8.4)	67 (100)	925 (282)	Coil (IPL)
25-530-86	5	22 (0.64)	0.33 (8.4)	67 (100)	300 (92)	Reel
25-527-86	5	22 (0.64)	0.33 (8.4)	67 (100)	900 (274)	Reel
25-525-86	5	22 (0.64)	0.33 (8.4)	67 (100)	925 (282)	Reel
25-549-86	5	22 (0.64)	0.33 (8.4)	67 (100)	5,500 (1,676)	Reel
25-667-86	6	22 (0.64)	0.37 (9.4)	81 (120)	600 (182)	Coil
25-680-86	6	22 (0.64)	0.37 (9.4)	81 (120)	700 (213)	Reel
25-685-86	6	22 (0.64)	0.37 (9.4)	81 (120)	1,200 (366)	Reel
25-654-86	6	22 (0.64)	0.37 (9.4)	81 (120)	2,500 (762)	Reel
25-682-86	6	22 (0.64)	0.37 (9.4)	81 (120)	4,000 (1,219)	Reel

Non-Jacketed Tight Twist Cable Core



PRODUCT DESCRIPTION

This Non-jacketed Cable Core is designed for use on the back side of cross connect and terminal blocks located in a cross connect cabinet adjacent to the remote terminal. Without a jacket this product must always be utilized in a cabinet, enclosure or indoors. These products offer enhanced crosstalk performance in a 100 Ohm design for supporting digital subscriber line (xDSL) technologies and higher IPTV data speeds.

FEATURES

- 24 AWG solid copper conductors
- Polyolefin insulation
- Pairing tight twist (CAT 5 like twists)
- Standard telephony solid colors
- No outer jacket
- Binder strings

BENEFITS

- Ideal for terminal block stubs
- Greater crush resistance and improved transmission characteristics
- Enhanced capabilities for xDSL signals
- Easy conductor identification
- Easy routing
- Holds pair groups together

SPECIFICATIONS

Standards Compliance	RoHS-compliant
----------------------	----------------

PART NUMBERS AND PHYSICAL CHARACTERISTICS

Part Number	Pair Count	AWG (mm)	Nominal Diameter in (mm)	Approx. Weight lbs/kft (kg/km)	Standard Length ft (m)	Package
11-003-53	25	24 (0.51)	0.41 (10)	82 (122)	5,000 (1,524)	Reel
11-003-45	50	24 (0.51)	0.57 (14)	164 (244)	5,000 (1,524)	Reel
11-003-46	100	24 (0.51)	0.82 (21)	328 (488)	5,000 (1,524)	Reel

Air Pipe



PRODUCT DESCRIPTION

Air Pipe is used for supplying air pressure to underground pressurized cable systems. Air pressure is distributed off the air pipe at regular intervals and applied to pressurized cables to supplement and boost air pressure along the cable route. It is normally placed in ducts. The laminated aluminum and polyethylene construction assures water vapor will not penetrate to the pipe interior.

SPECIFICATIONS

Shield	4 mil aluminum tape formed longitudinally with bonded overlap
Jacket	Black, medium density polyethylene jacket extruded over and laminated to the aluminum shield
Fitting Size in (mm)	½ (12.7)
Standards Compliance	RoHS-compliant

PART NUMBERS AND PHYSICAL CHARACTERISTICS

Part Number	Outer Nominal Diameter in (mm)	Inner Nominal Diameter in (mm)	Approx. Weight lbs/kft (kg/km)	Package
85-019-25	0.71 (18)	0.59 (15)	56 (83)	1,980 m Reel
85-018-25	0.71 (18)	0.59 (15)	56 (83)	6,500' Reel

Bridle Wire

PRODUCT DESCRIPTION

Bridle Wire is used to extend the telephone circuit from aerial distribution cable terminals to building entrance protectors or network interface units on subscriber premises. This wire has a black PVC jacket with a rip cord for easy access to conductors.

FEATURES

- PVC jacket

BENEFITS

- Provides a tough flexible protective covering that withstands exposure to sunlight and stresses encountered in standard installations



SPECIFICATIONS

Conductor	Solid annealed copper
Insulation	Color coded, solid, polyolefin tip conductors are striped with mating color for positive identification
Jacket	PVC
Standards Compliance	RoHS-compliant

PART NUMBERS AND PHYSICAL CHARACTERISTICS

Part Number	Pair Count	AWG (mm)	Nominal Diameter in (mm)	Approx. Weight lbs/kft (kg/km)	Package
12-262-01	2	22 (0.64)	0.19 (4.8)	19 (28)	600' POP™ box
12-642-01	6	22 (0.64)	0.27 (6.9)	42 (63)	450' Coil
12-842-01	12	22 (0.64)	0.33 (8.4)	73 (109)	250' Coil

Temporary Drop Wire

TDW

PRODUCT DESCRIPTION

Safety orange colored Temporary Non-shielded Drop Wire intended to temporarily extend or replace service.



SPECIFICATIONS

Conductor	Solid bare copper
Insulation	Polyolefin
Jacket	PVC
Jacket Color	Bright Orange
Standards Compliance	RoHS-compliant

PART NUMBERS AND PHYSICAL CHARACTERISTICS

Part Number	Pair Count	AWG (mm)	Wire Color	Nominal Diameter in (mm)	Approx. Weight lbs/kft (kg/km)	Package
12-311-36	2	22 (0.64)	Red/Green, Black/Yellow	0.14 (3.6)	13 (19)	1,000' POP™ box
12-331-36	1	24 (0.51)	Red/Green	0.13 (3.3)	7 (10)	2,000' POP box
12-322-36	2*	24 (0.51)	Red/Green	0.13 (3.3)	7 (10)	2,000' POP box

*Note: 2 conductors, not a pair.

E-Block Wire

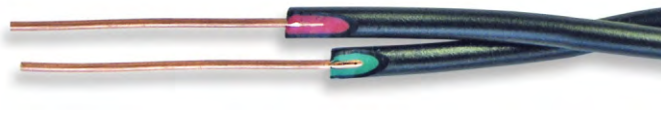

SPECIFICATIONS

Conductor	Copper covered steel
Dual Insulation	Inner layer: color coded PVC Outer layer: black PVC
Standards Compliance	TR-TSY-000127 UL® 83 VW1 RoHS-compliant

UL is a registered trademark of UL LLC.

PRODUCT DESCRIPTION

E-Block Wire is used for "ring wiring" of buildings and as a fusible link for aerial distribution. E-Block Wire is available in twisted pair and quad forms. It consists of copper clad steel conductors. Each conductor is dual insulated with a color coded inner layer of PVC and a black outer layer of PVC.

PART NUMBERS AND PHYSICAL CHARACTERISTICS

Part Number	Style	AWG (mm)	Nominal Diameter in (mm)	Approx. Weight lbs/kft (kg/km)	Standard Length ft (m)	Package
12-140-03	Pair	20 (0.13)	0.20 (5.1)	14 (20)	400 (122)	Knock-out box
12-220-03	Quad	20 (0.13)	0.24 (6.1)	32 (47)	250 (76)	Knock-out box

Ground Wire

Bare or Jacketed

PRODUCT DESCRIPTION

Ground Wire is used specifically to ground electrical devices and to maintain shield continuity at cable splices.

The wire is intended for use in accordance with Article 800.100, of the National Electrical Code.



SPECIFICATIONS

Conductor	Solid annealed copper
Insulation	Weather-resistant PVC
Performance Compliance	General Use - 300 Volt Communication RoHS-compliant
NRTL Programs	UL® Listed

UL is a registered trademark of UL LLC.

PART NUMBERS AND PHYSICAL CHARACTERISTICS

Part Number	AWG	Jacket Color	Nominal Diameter in (mm)	Approx. Weight lbs/kft (kg/km)	Package
12-001-04	6	Black	0.22 (5.6)	91 (135)	500' Plywood spool
12-101-04	6	Gray	0.22 (5.6)	91 (135)	200' Boxed coil
12-102-04	6	Gray	0.22 (5.6)	91 (135)	200' Coil
12-105-04	6	Gray	0.22 (5.6)	91 (135)	500' Coil
12-106-04	6	Gray	0.22 (5.6)	91 (135)	500' Boxed coil
12-107-04	6	Gray	0.22 (5.6)	91 (135)	600' Coil
12-104-04	6	Gray	0.22 (5.6)	91 (135)	4,000' Reel
12-018-04	6	Green	0.22 (5.6)	91 (135)	500' Reel
12-905-04	6	Bare	0.16 (4.1)	79 (118)	600' Plastic spool
12-901-04	6	Bare	0.16 (4.1)	79 (118)	200' Boxed coil
12-906-04	6	Bare	0.16 (4.1)	79 (118)	200' Coil
12-902-04	6	Bare	0.16 (4.1)	79 (118)	2,500' Plywood spool
12-903-04	6	Bare	0.16 (4.1)	79 (118)	300' Plastic spool
12-910-04	6	Bare	0.16 (4.1)	79 (118)	315' Plastic spool
12-904-04	6	Bare	0.16 (4.1)	79 (118)	4,000' Reel
12-907-04	6	Bare	0.16 (4.1)	79 (118)	500' Coil
12-908-04	6	Bare	0.16 (4.1)	79 (118)	600' Coil
12-111-04	10	Gray	0.14 (3.6)	37 (55)	200' Boxed coil
12-112-04	10	Gray	0.14 (3.6)	37 (55)	500' Boxed coil
12-011-04	10	Black	0.14 (3.6)	37 (55)	500' Knock-out box
12-012-04	10	Black	0.14 (3.6)	37 (55)	500' Spool
12-016-04	10	Green	0.14 (3.6)	37 (55)	500' Plastic spool
12-121-04	12	Gray	0.12 (3.0)	25 (37)	200' Boxed coil
12-122-04	12	Gray	0.12 (3.0)	25 (37)	300' Boxed coil
12-123-04	12	Gray	0.12 (3.0)	25 (37)	500' Plywood spool

Cross-Connect Category 5 Wire

XCW



SPECIFICATIONS

Conductor	Solid bare copper
Insulation	Flame retardant PVC insulated conductor each identified by a solid color
Performance Compliance	UL® 444 CSA C22.2 No. 214-08 RoHS-compliant
NRTL Programs	UL, c(UL) Listed CM

UL is a registered trademark of UL LLC.

PRODUCT DESCRIPTION

Cross-Connect Category 5 Wire is designed with a tighter twist to support higher data speeds and is intended for connections in cross connect cabinets.

PART NUMBERS AND PHYSICAL CHARACTERISTICS

Part Number	Pair Count	AWG (mm)	Wire Color	Nominal Diameter in (mm)	Approx. Weight lbs/kft (kg/km)	Package
02-360-23	1	22 (0.64)	White/Red	0.07 (1.8)	5 (7)	400' Spool
02-361-23	1	22 (0.64)	White/Violet	0.07 (1.8)	5 (7)	400' Spool
02-362-23	1	22 (0.64)	Violet/Blue	0.07 (1.8)	5 (7)	400' Spool
02-011-23	1	24 (0.51)	White/Blue	0.08 (2.0)	5 (7)	1,000' Spool
02-010-23	1	24 (0.51)	White/Green	0.08 (2.0)	5 (7)	1,000' Spool
02-031-23	1	24 (0.51)	Yellow/Red	0.08 (2.0)	5 (7)	1,000' Spool
02-032-23	1	24 (0.51)	Violet/Blue	0.08 (2.0)	5 (7)	1,000' Spool
02-111-23	1	24 (0.51)	White/Blue	0.08 (2.0)	5 (7)	6,000' Spool
02-131-23	1	24 (0.51)	Yellow/Red	0.08 (2.0)	5 (7)	6,000' Spool
02-050-23	1	24 (0.51)	White/Orange	0.08 (2.0)	5 (7)	1,000' Spool
02-006-23	1	24 (0.51)	White/Red	0.08 (2.0)	5 (7)	1,000' Spool
02-211-23	1	24 (0.51)	White/Blue	0.08 (2.0)	5 (7)	6,000' Spool
02-033-23	1	24 (0.51)	Yellow/Blue	0.08 (2.0)	5 (7)	1,000' Spool
02-113-23	1	24 (0.51)	Yellow/Blue	0.08 (2.0)	5 (7)	6,000' Spool
02-110-23	1	24 (0.51)	White/Green	0.08 (2.0)	5 (7)	6,000' Spool
02-132-23	1	24 (0.51)	Violet/Blue	0.08 (2.0)	5 (7)	6,000' Spool
11-005-90	1	24 (0.51)	Violet/Blue	0.08 (2.0)	5 (7)	500' Spool
02-350-23	1	24 (0.51)	White/Orange	0.08 (2.0)	5 (7)	400' Spool
02-311-23	1	24 (0.51)	White/Blue	0.08 (2.0)	5 (7)	500' Spool
02-020-23	2	24 (0.51)	White/Blue, White/Orange	0.12 (3.0)	5 (7)	1,000' Spool
02-021-23	2	24 (0.51)	Red/Blue, Red/Orange	0.12 (3.0)	5 (7)	1,000' Spool
02-022-23	2	24 (0.51)	White/Orange, White/Green	0.12 (3.0)	5 (7)	1,000' Spool
02-024-23	2	24 (0.51)	Violet/Blue, Violet/Orange	0.12 (3.0)	5 (7)	1,000' Spool

Indoor/Outdoor Cross-Connect Wire

XCW

PRODUCT DESCRIPTION

Indoor/Outdoor Cross-Connect Wire is intended for cross-connecting points in building entrance enclosures at subscriber's premises and/or in Outside Plant (OSP) enclosures. Each insulated conductor is identified by a combination of solid insulation color, except as noted.



SPECIFICATIONS

Conductor	Solid bare copper
Insulation	Semi-rigid PVC
Standards Compliance	UL® 444 CSA C22.2 No. 214-08 RoHS-compliant
NRTL Programs	UL, c(UL) Listed CM

UL is a registered trademark of UL LLC.

PART NUMBERS AND PHYSICAL CHARACTERISTICS

Part Number	Pair Count	AWG (mm)	Wire Color	Individual Nominal Diameter in (mm)	Overall Nominal Diameter in (mm)	Approx. Weight lbs/kft (kg/km)	Standard Length ft (m)	Package
02-111-13	1	22 (0.64)	White/Blue	0.036 (0.9)	0.07 (1.8)	4 (9)	1,000 (305)	Spool
02-102-13	1	22 (0.64)	Yellow/Blue	0.036 (0.9)	0.07 (1.8)	4 (9)	1,000 (305)	Spool
02-E02-13	1	22 (0.64)	Yellow/Blue	0.036 (0.9)	0.07 (1.8)	4 (9)	3,000 (915)	Spool
02-113-13	1	22 (0.64)	White/Red	0.036 (0.9)	0.07 (1.8)	4 (9)	1,000 (305)	Spool
02-114-13	1	22 (0.64)	White/Black	0.036 (0.9)	0.07 (1.8)	4 (9)	1,000 (305)	Spool
02-513-13*	1	22 (0.64)	White/Red	0.036 (0.9)	0.07 (1.8)	4 (9)	1,000 (305)	Spool
02-514-13*	1	22 (0.64)	White/Black	0.036 (0.9)	0.07 (1.8)	4 (9)	1,000 (305)	Spool
02-120-13	2	22 (0.64)	White/Blue, White/Orange	0.036 (0.9)	0.11 (2.8)	9 (20)	1,000 (305)	Spool
02-H12-13	1	22 (0.64)	White/Violet	0.036 (0.9)	0.07 (1.8)	3 (7)	400 (122)	Spool
02-G11-13	1	22 (0.64)	White/Blue	0.036 (0.9)	0.07 (1.8)	3 (7)	400 (122)	Spool
02-G50-13	1	22 (0.64)	White/Orange	0.036 (0.9)	0.07 (1.8)	3 (7)	400 (122)	Spool
02-H13-13	1	22 (0.64)	Red/White	0.036 (0.9)	0.07 (1.8)	3 (7)	400 (122)	Spool
02-G16-13	1	22 (0.64)	Violet/Blue	0.036 (0.9)	0.07 (1.8)	3 (7)	400 (122)	Spool
02-706-13*	1	24 (0.51)	White/Red	0.036 (0.9)	0.07 (1.8)	3 (7)	1,000 (305)	Spool
02-001-13	1	24 (0.51)	White/Blue	0.036 (0.9)	0.07 (1.8)	3 (7)	1,000 (305)	Spool
02-050-13	1	24 (0.51)	White/Orange	0.036 (0.9)	0.07 (1.8)	3 (7)	1,000 (305)	Spool
02-E12-13	1	24 (0.51)	White/Orange	0.036 (0.9)	0.07 (1.8)	3 (7)	1,000 (305)	Spool
02-006-13	1	24 (0.51)	White/Red	0.036 (0.9)	0.07 (1.8)	3 (7)	1,000 (305)	Spool
02-D06-13	1	24 (0.51)	White/Red	0.036 (0.9)	0.07 (1.8)	3 (7)	600 (183)	Spool
02-053-13	1	24 (0.51)	Red/Blue	0.036 (0.9)	0.07 (1.8)	3 (7)	1,000 (305)	Spool
02-004-13	1	24 (0.51)	Red/Green	0.036 (0.9)	0.07 (1.8)	3 (7)	1,000 (305)	Spool
02-005-13	1	24 (0.51)	Red/Slate	0.036 (0.9)	0.07 (1.8)	3 (7)	1,000 (305)	Spool
02-054-13	1	24 (0.51)	Red/Black	0.036 (0.9)	0.07 (1.8)	3 (7)	1,000 (305)	Spool
02-702-13*	1	24 (0.51)	Red/Black	0.036 (0.9)	0.07 (1.8)	3 (7)	1,000 (305)	Spool
02-002-13	1	24 (0.51)	Yellow/Blue	0.036 (0.9)	0.07 (1.8)	3 (7)	1,000 (305)	Spool
02-409-13	1	24 (0.51)	Blue/Black	0.036 (0.9)	0.07 (1.8)	3 (7)	3,000 (915)	Spool
02-401-13	1	24 (0.51)	White/Blue	0.036 (0.9)	0.07 (1.8)	3 (7)	3,000 (915)	Spool
02-450-13	1	24 (0.51)	White/Orange	0.036 (0.9)	0.07 (1.8)	3 (7)	3,000 (915)	Spool
02-051-13	1	24 (0.51)	White/Green	0.036 (0.9)	0.07 (1.8)	3 (7)	1,000 (305)	Spool
02-052-13	1	24 (0.51)	White/Black	0.036 (0.9)	0.07 (1.8)	3 (7)	1,000 (305)	Spool
02-006-13	1	24 (0.51)	White/Red	0.036 (0.9)	0.07 (1.8)	3 (7)	1,000 (305)	Spool
02-D02-13	1	24 (0.51)	Yellow/Blue	0.036 (0.9)	0.07 (1.8)	3 (7)	600 (183)	Spool
11-001-02	1	24 (0.51)	White/Blue	0.036 (0.9)	0.07 (1.8)	3 (7)	1,000 (305)	Spool
11-001-03	1	24 (0.51)	White/Green	0.036 (0.9)	0.07 (1.8)	3 (7)	2,000 (610)	Spool
02-222-13	2	24 (0.51)	White/Blue, White/Orange	0.036 (0.9)	0.10 (2.5)	6 (13)	1,000 (305)	Spool
02-221-13	2	24 (0.51)	Red/Blue, Red/Orange	0.036 (0.9)	0.10 (2.5)	6 (13)	1,000 (305)	Spool
02-224-13	2	24 (0.51)	Yellow/Blue, Yellow/Orange	0.036 (0.9)	0.10 (2.5)	6 (13)	1,000 (305)	Spool
02-223-13	2	24 (0.51)	White/Orange, White/Green	0.036 (0.9)	0.10 (2.5)	6 (13)	1,000 (305)	Spool
02-032-13	3	24 (0.51)	White/Blue, White/Orange, White/Green	0.036 (0.9)	0.12 (3.0)	9 (20)	1,000 (305)	Spool
02-D30-13	3	24 (0.51)	White/Blue, White/Orange, White/Green	0.036 (0.9)	0.12 (3.0)	9 (20)	600 (183)	Spool
02-041-13	4	24 (0.51)	White/Blue, White/Orange, White/Green, White/Brown	0.036 (0.9)	0.15 (3.8)	13 (29)	1,000 (305)	Spool

*Solid color (not band marked)



800.551.8948
SuperiorEssex.com

All information, content, data, specifications, packaging and part numbers detailed herein are subject to change. For the most up-to-date information, please visit SuperiorEssex.com. Purchase of this product is subject exclusively to the then current **Superior Essex International LP Terms and Conditions of Sale for Communications and Energy Cable, Wire and Connectivity Products**, which can be found on our website, SuperiorEssex.com, or provided to you upon request.

FTTP CLOSURES

Slack Storage Module (SSM).....	C-2
Fiber In-Line Splice Closure (FIC).....	C-4
Fiber Dome Splice Closure (FDC).....	C-6
FDH-288 Series Fiber Distribution Hub (FDH).....	C-8

FTTP ACCESSORIES

FIC Tray Kits/Splitters.....	C-10
FIC End Grommet Kits.....	C-11
FIC Hanger Kits.....	C-11
FDC Tray Kits/Splitters.....	C-12
FDC Pole Mount Kits.....	C-12
FDC Compression Grommet Kits.....	C-13
FDC Compression Connector Wrench.....	C-13

Slack Storage Module (SSM)

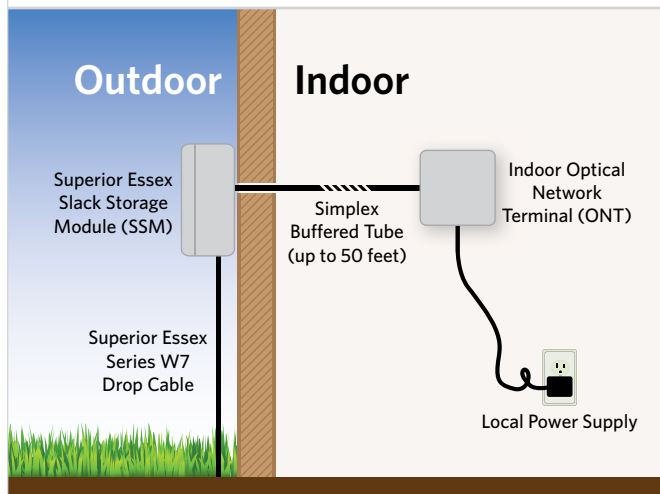

FTTP Tight Buffered Indoor/Outdoor Drop Series W7

PRODUCT AND SOLUTION DESCRIPTION

The Slack Storage Module (SSM) provides water-tight storage for up to 50 feet of excess simplex fiber cable at the side of an FTTP residence. The SSM is specifically designed for use with the Superior Essex tight buffered indoor/outdoor drop cable to provide a substantial cost savings for FTTP installations – around \$200 per connected location.*

The SSM provides protection of excess simplex fiber and convenient outdoor access to the fiber if a splice is necessary in the future.

The combination of the SSM and tight buffered drop cable enables the Optical Network Terminal (ONT) to be located inside the premises without the need for a termination or splice point on the exterior of the home. Our unique tight buffered drop cable is actually two cables in one: a rugged 300-pound rated OSP drop cable with an internal flexible OFNR rated simplex cable. By simply removing the outer PVC jacket and strength rods, this cable can be easily transitioned to indoor use without a splice point between the ONT and pedestal or terminal closure. For that reason, a splice point or termination is no longer required at the side of the home.

By locating the ONT inside the premises, the power supply can be plugged into any convenient wall outlet, eliminating the cost of running power to the ONT and the need to hire an electrician – further reducing installation costs. Another cost-savings benefit when using our tight buffered simplex cable design is having the capability to create a faster and more accurate termination to an SC connector.

**Savings are realized from elimination of electrician costs, reduced cost for indoor ONT, and reduced cost for fiber splicing.*

APPLICATIONS

- Fiber to the Home or Premises applications with indoor ONT

SYSTEM SOLUTION BENEFITS

- Only one technician is required for complete installation (no electrician required)
- Tight buffered optical fiber offers easier and faster termination than loose fiber termination or fusion splicing
- SSM provides an inexpensive way to access and store excess fiber
- Enables use of indoor-rated ONT that is less costly than outdoor-rated ONT
- Enables use of indoor backup power supply that is less costly than outdoor rated power supply

MODULE FEATURES

- Compact, easy-to-install enclosure design
- Weather-resistance enclosure with two levered latches and sealing gasket on the cover
- Drop cable grommet ports at top and bottom of enclosure
- Storage spool for 50 feet of fiber drop slack storage
- Cable tie provisions for both cable sheath and buffer jacket

MODULE BENEFITS

- Reduces initial cost of installation
- Provides superior environmental protection from rain, ice, dust and insects
- Provides flexibility and diversity in routing drop cable
- Provides optimum fiber management and generous slack storage
- Provides rigid and secure drop cable attachment

Slack Storage Module (SSM)

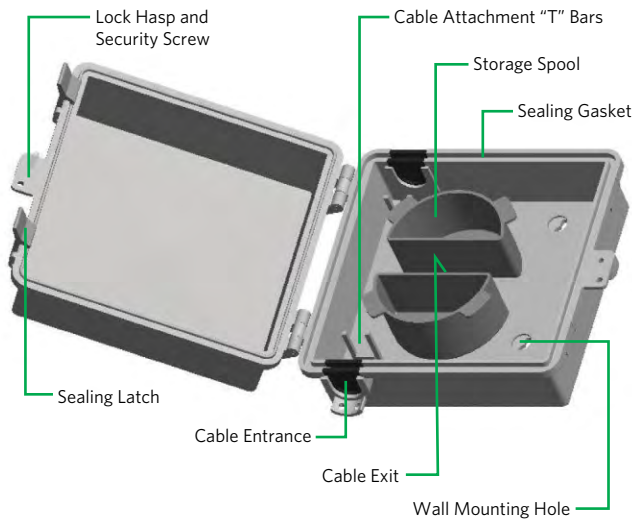

MODULE SPECIFICATIONS

Dimensions in (mm)	Height: 6.7 (170) Width: 6.7 (170) Depth: 3.6 (92)
Weight lbs (kg)	0.5 (0.23)
Material	ABS plastic
Material Color	Light grey
Material Thickness in (mm)	0.10 (2.5)
Cable Entry	Two (2) in One (1) out
Maximum I/O Drop Cable Diameter in (mm)	0.18 x 0.40 (4.6 x 10.2)
Installation	Wall
Locking Mechanism	Two (2) levered cover latches and captive pin-in-hex security screw
Standards Compliance	Designed to meet NEMA 3 rating for environmental protection

MODULE PART NUMBER

Part Number	Description
SSM-2C000	FTTP Slack Storage Module (SSM)

FTTP Tight Buffered Indoor/Outdoor Drop Series W7

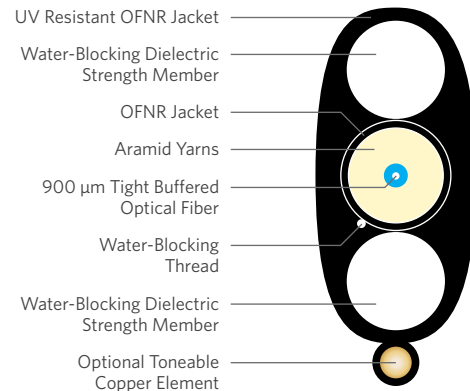

CABLE SPECIFICATIONS

Simplex OFNR Nominal Diameter in (mm)	0.11 (2.9)
Simplex OFNR Bend Radius in (mm)	Install: 2.2 (56) Long Term: 1.1 (28)
Cable Bend Radius in (mm)	Install: 3.6 (91) Long Term: 1.8 (46)
Cable Tensile Load lbs (N)	Install: 300 (1,350) Long Term: 90 (405)
Maximum Span Length at 1% Sag ft (m)	Light Loading: 350 (101) Medium Loading: 275 (84) Heavy Loading: 150 (46)
Standards Compliance	Telcordia® GR-20-CORE RoHS-compliant

Telcordia is a registered trademark of Ericsson Inc.

CABLE ENVIRONMENTAL SPECIFICATIONS

Operation/Storage	-40°C to +70°C
Installation	-10°C to +70°C

CABLE MACRO BENDING PERFORMANCE

10 Turns on 15 mm Radius Mandrel	ITU G 657 A	TeraFlex® SMF
Macro bending loss @ 1550 nm	0.25 dB Max.	≤ 0.20 dB
Macro bending loss @ 1625 nm	1.00 dB Max.	≤ 0.50 dB
1 Turn on 10 mm Radius Mandrel	ITU G 657 A	TeraFlex SMF
Macro bending loss @ 1550 nm	0.75 dB Max.	≤ 0.20 dB
Macro bending loss @ 1625 nm	1.50 dB Max.	≤ 0.20 dB

TeraFlex is an ITU G 657 A optical fiber that is completely compatible with ITU G 652 D optical fibers. TeraFlex exceeds the performance standards of ITU G 657 A as listed above.

CABLE PART NUMBERS AND PHYSICAL CHARACTERISTICS

Part Number	Description	Fiber Count	Nominal Dimensions in (mm)	Weight lbs/kft (kg/km)
W7001KU01	Universal	1	0.32 (8.2) x 0.17 (4.5)	29 (44)
W7002KU01	Universal	2	0.32 (8.2) x 0.17 (4.5)	29 (44)
W7001K101	Toneable	1	0.40 (10.2) x 0.17 (4.5)	31 (47)
W7002K101	Toneable	2	0.40 (10.2) x 0.17 (4.5)	31 (47)

Fiber In-Line Splice Closure (FIC)

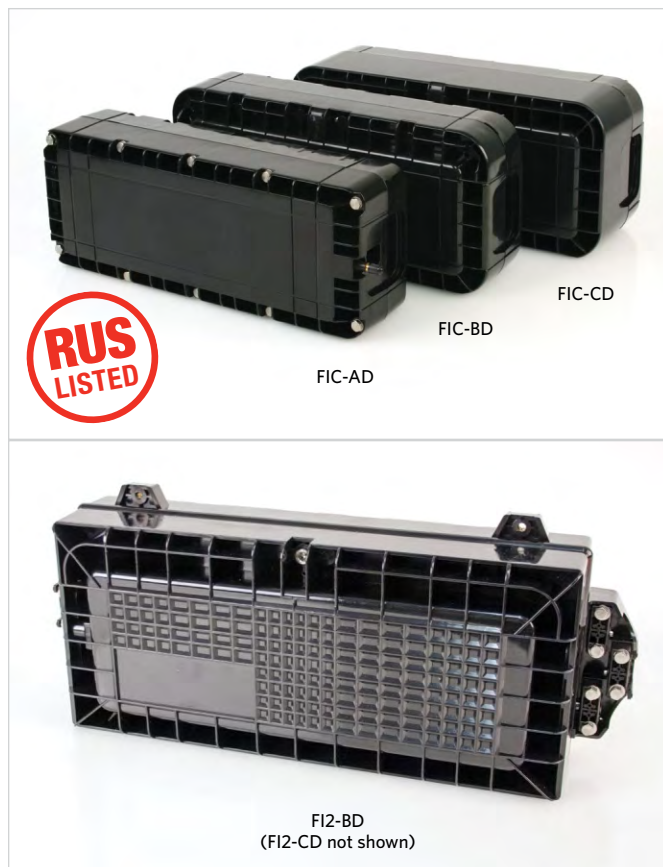

PRODUCT DESCRIPTION

The Superior Essex Fiber In-Line Splice Closure (FIC) Series is made of a rugged, environmentally-resistant, molded plastic and grommet seal, which makes these optical fiber splice closures ideal for Outside Plant (OSP) below-grade and aerial applications.

The FIC Series is available in a single-bolt/latch, “clamshell” design, as well as a multi-bolt, two-piece design. The single-bolt/latch closure is specially designed for aerial applications with provisions for strand-mounting and hanger hardware included. This closure, when opened, allows the splice trays to fold open at a 90° angle, thus creating a convenient position for splicing. The multi-bolt, two piece closure is best suited for below-grade applications, with a circumferential bolt pattern to ensure a secure, water-proof seal and a flash valve for seal verification.

The FIC Series offers two sizes of closures to accommodate splice capacities up to 192 Loose Buffer Tube (LBT) and 432 Ribbon fiber counts. A variety of port grommets are included to support in-line, branch and multiple drop cable configurations. An SC/APC adapter panel option, for use of preconnectorized drops, is available for the Type B and Type C closure models. Additional grommets, hanger hardware and splice trays are available as Closure Accessory Kits.

The FIC Series is Telcordia® Technologies GR-771-CORE compliant and RUS Listed.

APPLICATIONS

- The FIC Closure Series supports FTTP deployments where aerial or below-grade, sealed optical fiber splicing is required for in-line, branch and multiple drop cable applications.

FEATURES

- Compact design, easy to install and re-enter (Single-bolt/latch opens with ¼ inch hex Allen tool)
- Rugged, water-proof, UV-resistant closures design
- Variety of sealing grommet configurations
- For strand-mount installation, 90° hinged splice tray position for splicing
- Offered in multiple LBT fiber splice capacities
- Accommodates loose buffer tube, ribbon fiber types and splitter tray splice applications

BENEFITS

- Reduces installation and maintenance costs
- Provides superior environmental protection from water, dust, insect and rodent intrusion
- Provides flexibility by supporting a variety of cable types, sizes and routing configurations
- Allows easy access to splices and provides “work table” position for ease of splicing
- Easier selection to support the majority of fiber applications
- Provides optimum fiber cable selection flexibility, fiber management, generous slack provisioning and splitter mounting capability

SPECIFICATIONS

Material	ABS/Polycarbonate
Cable Entry Ports FIC	Two (2) 3-port grommets (installed at each end) One (1) 2-port/multi-drop port grommet (included)
Cable Entry Ports F12	Two (2) 4-port flat drop grommets (one (1) installed at each end) Four (4) single feeder port grommets (two (2) installed at each end) Two (2) 4-port round drop grommets (provided in bag as spares)
Cable Diameter Range in (mm)	0.375 - 1.0 (8 - 26)
Installation/Application	FIC-AD: Below-grade or aerial FIC-BD/FIC-CD: Aerial
All Kits Include	<ul style="list-style-type: none"> One (1), 24-fiber splice tray (FIC-TD240) <ul style="list-style-type: none"> 24 splice sleeves Four (4) transport tubes Eight (8) cable ties One (1) Velcro strap Four (4) cable hose clamps One (1) vacuum grease tube One (1) multi-drop port grommet One (1) silicone tape sheet One (1) silicone sealant tube Four (4) large cable ties
FIC-BD100 and FIC-CD100 Kits Also Include	<ul style="list-style-type: none"> Two (2) aerial strand hangers One (1) ¼ inch hex Allen tool
Standards Compliance	Telcordia® Technologies GR-771-CORE, Issue 2 Rural Utilities Service (RUS) Listed

Telcordia is a registered trademark of Ericsson Inc.



PART NUMBERS, CAPACITIES AND PHYSICAL CHARACTERISTICS

Part Number	Height in (mm)	Width in (mm)	Depth in (mm)	Weight lbs (kg)	Sealing/Locking Method	Splice Tray Capacity		Maximum Fiber Splice Capacity		Buffer Tube Storage		SC/APC Adapter Capacity
						LBT	Ribbon	LBT (24 per tray)	Ribbon (144 per tray)	LBT (8 ft per tube)	Ribbons (8 ft per ribbon)	
FIC-AD100	6.69 (170)	16.93 (430)	4.33 (110)	6.61 (3.0)	Multi-Bolt/Two-piece	4	2	96	288	8	24	-
FIC-BD100	7.48 (190)	16.93 (430)	3.94 (100)	7.50 (3.4)	Single-Bolt/Latch	4	2	96	288	8	24	-
FIC-BD10A	7.48 (190)	16.93 (430)	3.94 (100)	7.50 (3.4)	Single-Bolt/Latch	4	2	96	288	8	24	8
FIC-CD100	7.48 (190)	16.93 (430)	5.32 (135)	9.26 (4.2)	Single-Bolt/Latch	8	3	192	432	16	36	-
FIC-CD10A	7.48 (190)	16.93 (430)	5.32 (135)	9.26 (4.2)	Single-Bolt/Latch	6	3	144	432	16	36	12
F12-BD100	7.52 (191)	20.35 (517)	4.53 (115)	7.94 (3.6)	Single Bolt/Latch	4	2	96	288	8	24	-
F12-CD100	7.52 (191)	20.35 (517)	5.67 (144)	8.60 (3.9)	Single Bolt/Latch	8	3	192	432	16	36	-

ACCESSORIES*

Part Number	Description	Kit Components
FIC-TD120	Splice Tray Kit - 12 LBT or 144 Ribbon	Splice tray, 12 splice sleeves, 4 transport tubes, 8 cable ties
FIC-TD240	Splice Tray Kit - 24 LBT	Splice tray, 24 splice sleeves, 4 transport tubes, 8 cable ties
FSP-I-1x2	Splitter - 1 x 2	PLC Splitter single mode fiber input, single mode ribbon output
FSP-I-1x4	Splitter - 1 x 4	PLC Splitter single mode fiber input, single mode ribbon output
FSP-I-1x8	Splitter - 1 x 8	PLC Splitter single mode fiber input, single mode ribbon output
FSP-I-1x16	Splitter - 1 x 16	PLC Splitter single mode fiber input, single mode ribbon output
FSP-I-1x32	Splitter - 1 x 32	PLC Splitter single mode fiber input, single mode ribbon output
FIC-G3P25	End Grommet Kit - 3 ports	25 end-grommets, 25 retaining rings, 25 support bars
FIC-G4P25	End Grommet Kit - 4 ports	25 end-grommets, 25 retaining rings, 25 support bars
FIC-GCP25	End Grommet Kit - 2 ports, 16 drop ports	25 end-grommets, 25 retaining rings, 25 support bars
F12-G1P25	End Grommet Kit - feeder, 1 port	25 end grommets
F12-G4FP25	End Grommet Kit - flat drop, 4 ports	25 end grommets
F12-G4RP25	End Grommet Kit - round drop, 4 ports	25 end grommets
FIC-HA000	Aerial Hanger Kit	2 hanger arms, 2 mounting screws
FIC-PMBA1	Pole Mount Kit - Band	T-Bracket with stainless steel band
FIC-PMBO1	Pole Mount Kit - Bolt	T-Bracket with bolts

*See the "FTTP Accessories" section for more detailed information.

Fiber Dome Splice Closure (FDC)



COMPONENT CONTENTS

Item	FD2-A	FD2-B	FD2-C	FD2-D	Remarks
Dome cover	1	1	1	1	Factory installed
Closure base with gasket	1	1	1	1	Factory installed
Locking collar	1	1	1	1	Factory installed
Distribution cable entry grommets	2	4	4	4	Included
Round drop cable (7 - 9 mm) entry grommets	2	4	4	4	Included
Flat drop cable entry grommets	2	4	4	4	Factory installed
Cable ties	8	8	16	24	Included
Vacuum grease tube	1	1	2	2	Included
Silicone sealant tube	1	1	2	2	Included
Hose clamps	2	4	8	8	Included
Strength member attachment brackets	2	4	4	4	Included
Extra compression nut for feeder/drop port	1	1	1	1	Included
Loop-thru port spacers	8	8	8	8	Included
Loop-thru entry grommets	6	6	6	6	2 factory installed 4 included
Aerial hanger kit	1	1	1	1	Included
Sealing tape strips	2	2	4	4	Included
24-fiber splice tray (FDC-TD240)	1	1	-	-	Factory installed
36-fiber splice tray (FDC-TD360)	-	-	1	-	Factory installed
72-fiber splice tray (FDC-TD720)	-	-	-	1	Factory installed
Velcro splice tray strap	1	1	1	1	Included
Splice sleeves	24	24	36	72	Included
Spiral transportation tubes	4	4	6	12	Included
Outside diameter ruler	1	1	1	1	Included
Silica gel pack	1	1	1	1	Included
Alcohol tissue pack	1	1	1	1	Included

SPECIFICATIONS

Material	ABS/polycarbonate
Dome Sealing/Locking	Single-latch sealing ring with padlock hasp
Seal Verification	Flash test air valve
Standards Compliance	Telcordia® Technologies GR-771-CORE, Issue 2 Rural Utilities Service (RUS) Listed

Telcordia is a registered trademark of Ericsson Inc.

PRODUCT DESCRIPTION

The Superior Essex Fiber Dome Splice Closure (FDC) Series is made of a rugged, environmentally-resistant, molded plastic that makes this optical fiber splice closure ideal for Outside Plant (OSP) below-grade, aerial and direct buried applications.

The FDC Closure Series employs a lightweight, ribbed dome with a one-piece latch sealing ring to provide a low-cost, water-proof, impact-resistant closure for optimum fiber splice protection. The FDC is designed to support butt-end, branch and express cable configurations as well as round or flat drops. All FDC closures include a flash valve for seal verification.

The FDC Series offers four sizes of closures to accommodate splice capacities up to 576 Loose Buffer Tube (LBT) or 1,152 ribbon fiber counts. Most ancillary components necessary for installation are included with each FDC closure to simplify the installation. Additional cable grommets and splice trays are available as accessories.

The FDC Series is Telcordia® Technologies GR-771-CORE compliant.

APPLICATIONS

- FTTx deployments where aerial, below-grade and direct buried, sealed optical fiber splicing is required

FEATURES

- Lightweight, easy to install and re-enterable using a compression grommet cable sealing design with split base for express cables
- Designed to support multiple applications with one closure
- Durable, water-proof, UV-resistant compact design
- Designed for wide range of installation methods
- Variety of cable entry sizes and configurations
- Universal, hinged splice tray configuration
- Offered in four LBT fiber splice capacities: 96, 144, 288 and 576
- Includes ancillary components to support most installations

BENEFITS

- Reduces installation and maintenance costs
- Reduces the number of closures for ordering and inventory
- Provides superior environmental protection from water, dust, insect and rodent intrusion
- Supports aerial, below-grade, direct-buried and pedestal applications
- Provides flexibility for cable routing diversity and drop cables
- Accommodates splice trays from popular suppliers
- Easy selection to support majority of fiber applications
- Reduced installation costs and inventory of "small parts"

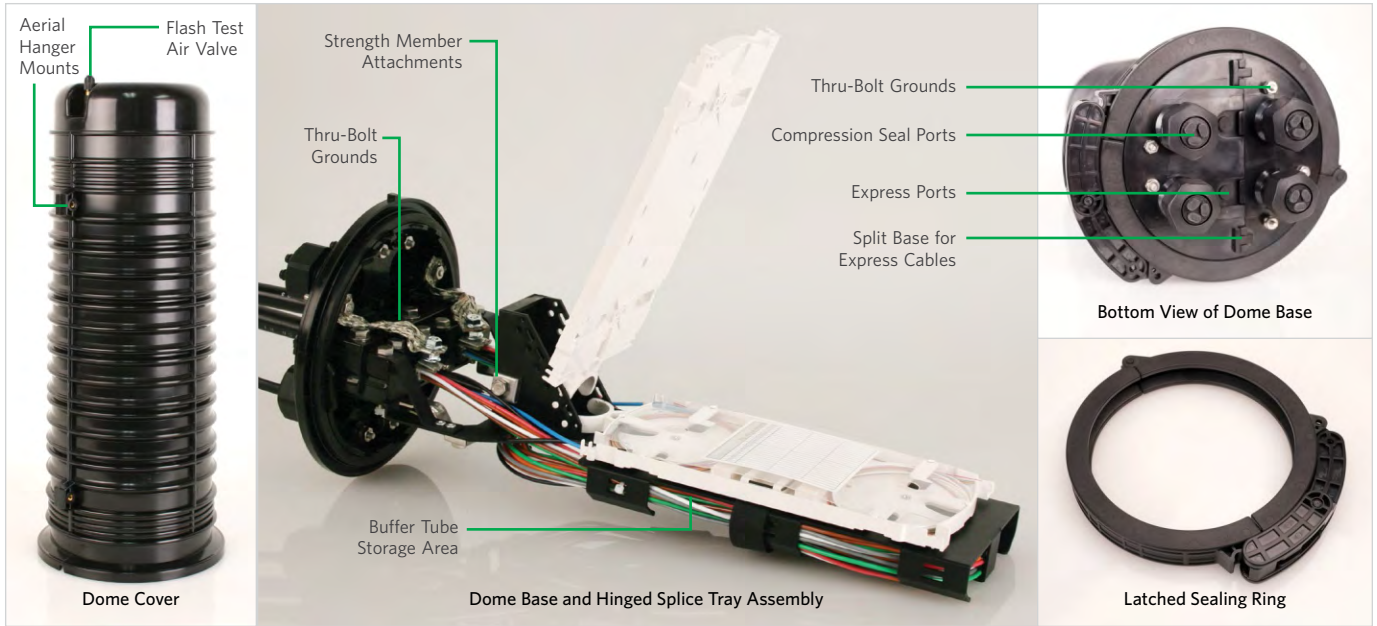

PORT AND GROUNDING SPECIFICATIONS

Part Number	Number of Round Ports ¹	Round Port Cable O.D. Range in (mm)	Number of Express Ports	Express Port Cable O.D. Range in (mm)	Maximum Round or Flat Drops	Round/Flat Drop O.D. in (mm)	Port Sealing Method	Number of Thru-Bolt Grounds
FD2-AD10F	2	0.28-0.63 (7-16)	1 Dual cable	0.39-0.79 (10-20)	6	0.36/0.18 x 0.31 (9/4.5 x 8)	Compression seal	4
FD2-BD10F	4	0.28-0.63 (7-16)	1 Dual cable	0.39-0.79 (10-20)	12	0.36/0.18 x 0.31 (9/4.5 x 8)	Compression seal	6
FD2-CD10F	4	0.28-1.00 (7-25)	1 Dual cable	0.67-1.10 (17-28)	16	0.36/0.18 x 0.31 (9/4.5 x 8)	Compression seal	6
FD2-DD10F	4	0.28-1.00 (7-25)	1 Dual cable	0.67-1.28 (17-32)	16	0.36/0.18 x 0.31 (9/4.5 x 8)	Compression seal	6

¹Round ports can be used for a single feeder cable or multiple round or flat drops.

DIMENSIONS AND FIBER/STORAGE CAPACITIES

Part Number	Height in (mm)	Diameter in (mm)	Weight lbs (kg)	Splice Tray Capacity		Fiber Splice Capacity ²		Fiber Slack Storage	
				Loose Tube	Ribbon	Loose Tube ²	Ribbon ² (144 per tray)	Loose Tubes (8 ft per tube)	Ribbons (8 ft per ribbon)
FD2-AD10F	15.2 (385)	7.0 (177)	5.5 (2.5)	4	2	96	216	8	18
FD2-BD10F	18.3 (466)	7.8 (199)	7.7 (3.5)	6	2	144	216	12	18
FD2-CD10F	20.9 (532)	9.7 (246)	13.2 (6.0)	8	6	288	864	24	72
FD2-DD10F	26.9 (682)	9.7 (246)	17.6 (8.0)	8	8	576	1,152	48	96

²Refer to the "Port and Grounding Specifications" table above to verify compatibility of the Cable O.D. with the Fiber Splice Capacity prior to closure selection.

ACCESSORIES

Part Number	Description	FDC Compatibility	Kit Components
FDC-TE144	Splice Tray Kit - 144 Ribbon	All	Splice tray, 12 ribbon splice sleeves, 4 transport tubes, 8 cable ties
FDC-TD240	Splice Tray Kit - 24 LBT	All	Splice tray, 24 splice sleeves, 4 transport tubes, 8 cable ties
FDC-TD360	Splice Tray Kit - 36 LBT	Type C	Splice tray, 36 splice sleeves, 6 transport tubes, 16 cable ties
FDC-TD720	Splice Tray Kit - 72 LBT	Type D	Splice tray, 72 splice sleeves, 12 transport tubes, 24 cable ties
FSP-D-1x2	Splitter - 1 x 2	All	PLC Splitter single mode fiber input, single mode ribbon output
FSP-D-1x4	Splitter - 1 x 4	All	PLC Splitter single mode fiber input, single mode ribbon output
FSP-D-1x8	Splitter - 1 x 8	All	PLC Splitter single mode fiber input, single mode ribbon output
FSP-D-1x16	Splitter - 1 x 16	All	PLC Splitter single mode fiber input, single mode ribbon output
FSP-D-1x32	Splitter - 1 x 32	All	PLC Splitter single mode fiber input, single mode ribbon output
FD2-APLMT	Pole Mount Kit	Type A	Mounting bracket, 2 lag screws, 2 lock washers
FD2-BPLMT	Pole Mount Kit	Type B	Mounting bracket, 2 lag screws, 2 lock washers
FD2-CPLMT	Pole Mount Kit	Type C, Type D	Mounting bracket, 3 lag screws, 3 lock washers
FD2-GDR07	End Grommet Kit - 3 round drop ports (7 mm)	Type A, Type B	25 grommets
FD2-GDR09	End Grommet Kit - 2 round drop ports (9 mm)	Type A, Type B	25 grommets
FD2-GDF08	End Grommet Kit - 3 flat drop ports (4.5 x 8 mm)	Type A, Type B	25 grommets
FD2-GFR12	End Grommet Kit - 1 round port (9-12 mm)	Type A, Type B	25 grommets
FD2-GFR16	End Grommet Kit - 1 round port (13-16 mm)	Type A, Type B	25 grommets
FD2-CFR20	End Grommet Kit - 1 round port (20 mm)	Type C, Type D	25 grommets
FD2-CFR25	End Grommet Kit - 1 round port (25 mm)	Type C, Type D	25 grommets
FD2-CDR07	End Grommet Kit - 4 round ports (7-9 mm)	Type C, Type D	25 grommets
FD2-CDF08	End Grommet Kit - 4 flat drop ports (4.5 x 8 mm)	Type C, Type D	25 grommets
FD2-CTOOL	Compression Connector Wrench	All	1 wrench

FDH-288 Series Fiber Distribution Hub (FDH)



FDH SPECIFICATIONS

Distribution Fiber Capacities	72, 144, 216 or 288 fiber adapters
Mounting Configurations	Pad or vault
Dimensions H x W x D in (mm)	Vault-mount: 43.7 x 26.4 x 15.8 (1,110 x 671 x 401) Pad-mount: 49.2 x 26.4 x 15.8 (1,250 x 671 x 401)
Weight lbs (kg)	80 (36.36)
Adapter Type	SC/APC
Fiber Type	Loose buffer tube or ribbon
Maximum Number of Splitter Input Fibers	12
Splitter Module Capacity	12
Parking Lot Capacity	72 adapters
Color	Beige
Standards Compliance	Telcordia® Technologies GR-3125-CORE, Issue 1

Telcordia is a registered trademark of Ericsson Inc.

SPLITTER MODULE SPECIFICATIONS

Splitter Ratio ¹	Insertion Loss		Return Loss dB	Directivity dB	PDL dB	Band Pass nm	Operating Temp. °C
	Max. ² dB	Uniformity dB					
1 x 4	≤ 7.6	≤ 0.6	≥ 55	≥ 55	≤ 0.2	1260 to 1650	-40 to 85
1 x 8	≤ 11.0	≤ 0.8	≥ 55	≥ 55	≤ 0.3	1260 to 1650	-40 to 85
1 x 16	≤ 13.7	≤ 1.0	≥ 55	≥ 55	≤ 0.3	1260 to 1650	-40 to 85
1 x 32	≤ 16.9	≤ 1.3	≥ 55	≥ 55	≤ 0.3	1260 to 1650	-40 to 85

¹All splitter modules comply with ITU-T G.652 and G.657.A recommendations

²Does not include connector loss

PART NUMBERS

Part Number	Description
FDH-AA000	FDH weather-proof cabinet, pad mount, 72 SC/APC adapters ³
FDH-BA000	FDH weather-proof cabinet, pad mount, 144 SC/APC adapters ³
FDH-CA000	FDH weather-proof cabinet, pad mount, 216 SC/APC adapters ³
FDH-DA000	FDH weather-proof cabinet, pad mount, 288 SC/APC adapters ³
FDH-SMD14	Splitter Module - 1 x 4
FDH-SMD18	Splitter Module - 1 x 8
FDH-SM116	Splitter Module - 1 x 16
FDH-SM132	Splitter Module - 1 x 32

³Preconnectorized cable or in-hub splicing capable; splice trays not included.

PRODUCT DESCRIPTION

The Superior Essex FDH-288 Series Fiber Distribution Hub (FDH) is designed to provide a local convergence point in an Outside Plant (OSP) environment. The FDH-288 houses optical splitters that propagate optical signal from the Central Office (CO) to the distribution cable network that serves fiber to the customer's premises. Its compact and modular design offers a cost-effective fiber distribution solution with ease of installation. This modular approach enables the service provider to incrementally grow fiber distribution capacity as their subscriber penetration rate increases. SC adapter distribution panels are available in 72-port increments, thus providing 72, 144, 216 and 288 fiber capacity configurations. The service provider can purchase additional SC adapter panels after the initial installation to increase fiber distribution capacity on a "pay-as-you-grow" basis, offering a more cost-effective means of managing deployment costs.

PRODUCT HIGHLIGHTS

- Powder-coated, aluminum, non-corrosive construction with 3-point door lock system
- Single-entry door conducive to pad and vault mounting
- Internal self-locking, swinging panel for SC adapter and parking lot receptacles
- Centrally located, 12-position splitter module shelf
- Splitter modules available in 1 x 4, 1 x 8, 1 x 16 or 1 x 32 ratios
- Each cabinet supports in-hub splicing or preconnectorized terminations for feeder and distribution cables
- Telcordia® GR-3125, Issue 1 compliant

APPLICATIONS

- The FDH-288 provides a connectorized path between passive optical splitters fed from the CO and distribution optical fiber cables that transport the optic signal to the customer's premises for voice, data and video services. The FDH-288 facilitates rapid service provisioning and reconfiguration, thus improving installation efficiencies in the field.

FEATURES

- Modular SC adapter distribution panels
- Small, compact weather-proof enclosure
- Enhanced bend radius control, slack storage and fiber routing
- Secure, single-entry door with pad lock hasp

BENEFITS

- Offers cost-effective, "pay-as-you-grow" deployment
- Offers an aesthetically-pleasing package for OSP deployment
- Provides optimal fiber management, protection and performance
- Offers flexibility for pad or vault mounting options



Self-Locking, Swinging Adapter Panel Assembly



Fiber Management and Bend Radius Control

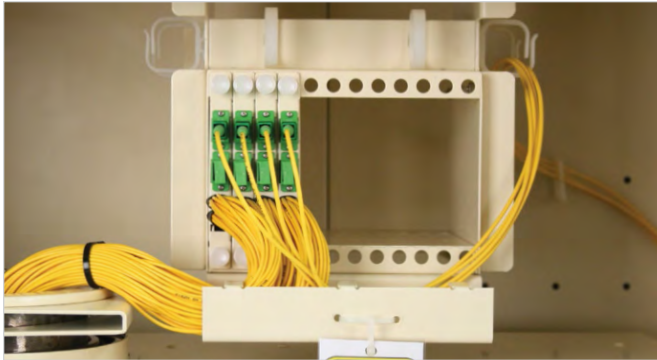

Conveniently-Located Splitter Module Shelf



Slide-Out, In-Hub Splicing Option

ACCESSORIES

Part Number	Description	Kit Components
FIC-TD120	Splice Tray Kit - 12 LBT or 144 Ribbon	Splice tray, 12 splice sleeves, 4 transport tubes, 8 cable ties
FIC-TD240	Splice Tray Kit - 24 LBT	Splice tray, 24 splice sleeves, 4 transport tubes, 8 cable ties
FDH-SCA72	72-SC Adapter Panel (SC/APC)	3 panels of 24 SC/APC adapters with mounting screws
FDP-xy1A0 ¹	Preconnectorized feeder or distribution cable	100 ft cable assembly with labeled SC/APC connectors

FEEDER / DISTRIBUTION CABLE SIZE

	Feeder Cable Size (number of fibers)			Distribution Cable Size (number of fibers)			
	12	24	48	72	144	216	288
¹ Replace "x" with:	A	B	C	D	E	F	G

CABLE TYPE (FEEDER AND DISTRIBUTION)

	Single Armor Loose Tube	Dielectric Loose Tube	Armored Ribbon	Dielectric Ribbon
¹ Replace "y" with:	A	B	C	D



OLDCASTLE ENCLOSURES AND LIDS²

Part Number	Description	Depth in (mm)	Dimensions		Material	Rated
			L x W in (mm)			
30486010	Below-grade vault	18 (457)	48 x 30	(1,219 x 762)	Polymer concrete	T15
30486011	Below-grade vault	24 (610)	48 x 30	(1,219 x 762)	Polymer concrete	T15
30486012	Below-grade vault	30 (762)	48 x 30	(1,219 x 762)	Polymer concrete	T15
30486013	Below-grade vault	36 (914)	48 x 30	(1,219 x 762)	Polymer concrete	T15
30487622	Blank lid-half	3 (76)	24 x 30	(610 x 762)	Polymer concrete	T15
30487055	Cut-out lid-half for FDH-288	3 (76)	24 x 30	(610 x 762)	Polymer concrete	-

²Oldcastle enclosures and lids must be ordered from Oldcastle Enclosure Solutions at 1.800.735.5566

FIC Tray Kits/Splitters

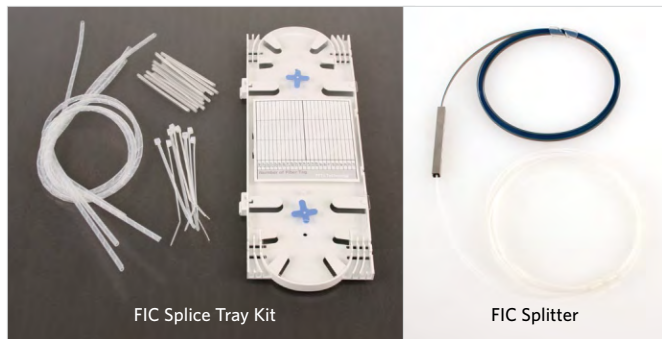

FIC Splice Tray Kit

FIC Splitter

PRODUCT DESCRIPTION

The FIC splice tray kit is used to organize and splice fibers.

The FIC splitter is used to split one or two fibers into 2, 4, 8, 16, or 32 channels.

PART NUMBERS AND KIT COMPONENTS

Part Number	Description	Fiber Capacity	Kit Components
FIC-TD120	FIC Splice Tray Kit	12 Loose Buffer Tube or 144 Ribbon	<ul style="list-style-type: none"> One (1) splice tray, cover and assignment label 12 ribbon splicing sleeves Four (4) spiral transportation tubes Eight (8) cable ties
FIC-TD240	FIC Splice Tray Kit	24 Loose Buffer Tube	<ul style="list-style-type: none"> One (1) splice tray, cover and assignment label 24 splicing sleeves Four (4) spiral transportation tubes Eight (8) cable ties
FSP-I-1x2	FIC Splitter 1 x 2	1 in, 2 out	PLC Splitter single mode fiber input, single mode ribbon output
FSP-I-1x4	FIC Splitter 1 x 4	1 in, 4 out	PLC Splitter single mode fiber input, single mode ribbon output
FSP-I-1x8	FIC Splitter 1 x 8	1 in, 8 out	PLC Splitter single mode fiber input, single mode ribbon output
FSP-I-1x16	FIC Splitter 1 x 16	1 in, 16 out	PLC Splitter single mode fiber input, single mode ribbon output
FSP-I-1x32	FIC Splitter 1 x 32	1 in, 32 out	PLC Splitter single mode fiber input, single mode ribbon output

FIC End Grommet Kits

PRODUCT DESCRIPTION

The FIC end grommet kit is used to seal cable entry for drop and branch cables. Each cable port accommodates a cable from 9 mm to 26 mm in diameter. Each drop port accommodates a cable from 3 mm to 9 mm in diameter.



PART NUMBERS AND KIT COMPONENTS

Part Number	Description	Port Capacity	Kit Components
FIC-G3P25	FIC End Grommet Kit	3 cable ports	<ul style="list-style-type: none"> 25 end-grommets 25 two-piece, oval retaining rings 25 metal support bars
FIC-G4P25	FIC End Grommet Kit	4 cable ports	<ul style="list-style-type: none"> 25 end-grommets 25 two-piece, oval retaining rings 25 metal support bars
FIC-GCP25	FIC End Grommet Kit	2 cable ports and 16 drop ports	<ul style="list-style-type: none"> 25 end-grommets 25 two-piece, oval retaining rings 25 metal support bars
FI2-G1P25	FI2 End Grommet Kit	1 feeder port	<ul style="list-style-type: none"> 25 end grommets
FI2-G4FP25	FI2 End Grommet Kit	4 flat drop ports	<ul style="list-style-type: none"> 25 end grommets
FI2-G4RP25	FI2 End Grommet Kit	4 round drop ports	<ul style="list-style-type: none"> 25 end grommets

FIC Hanger Kits

PRODUCT DESCRIPTION

The FIC aerial hanger kit is used to strand-mount and support all Fiber In-Line Closures (FIC) on a 3/4 inch Messenger cable. Each hanger arm provides additional holes to accommodate most universal hanging brackets and hardware. Each kit will support one (1) in-line closure.

The FIC pole mount kit is used to attach an In-Line Closure (FIC and FI2) to a pole using either a stainless steel band or bolts.

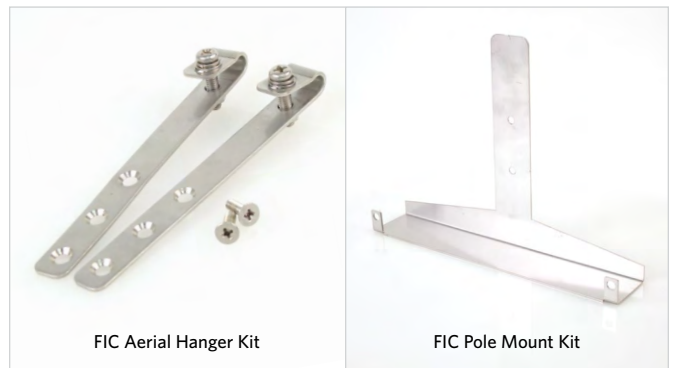

PART NUMBERS AND KIT COMPONENTS

Part Number	Description	Kit Components
FIC-HA000	Aerial Hanger Kit	<ul style="list-style-type: none"> Two (2), 6 inch hanger arms with fasteners Two (2) Phillips-head mounting screws
FIC-PMBA1	Pole Mount Kit - Band	<ul style="list-style-type: none"> T-Bracket with stainless steel band
FIC-PMBO1	Pole Mount Kit - Bolt	<ul style="list-style-type: none"> T-Bracket with bolts

FDC Tray Kits/Splitters



PRODUCT DESCRIPTION

The FDC splice tray kit is used to organize and splice fibers.

The FDC splitter is used to split one or two fibers into 2, 4, 8, 16, or 32 channels.

PART NUMBERS AND KIT COMPONENTS

Part Number	Description	Fiber Capacity	Kit Components
FDC-TE144	FDC Splice Tray Kit	144 Ribbon	<ul style="list-style-type: none"> One (1) hinged-splice tray, cover and assignment label 12 ribbon splicing sleeves Four (4) spiral transportation tubes Eight (8) cable ties
FDC-TD240	FDC Splice Tray Kit	24 Loose Buffer Tube	<ul style="list-style-type: none"> One (1) hinged-splice tray, cover and assignment label 24 splicing sleeves Four (4) spiral transportation tubes Eight (8) cable ties
FDC-TD360	FDC Splice Tray Kit	36 Loose Buffer Tube	<ul style="list-style-type: none"> One (1) hinged-splice tray, cover and assignment label 36 splicing sleeves Six (6) spiral transportation tubes 16 cable ties
FDC-TD720	FDC Splice Tray Kit	72 Loose Buffer Tube	<ul style="list-style-type: none"> One (1) hinged-splice tray, cover and assignment label 72 splicing sleeves 12 spiral transportation tubes 24 cable ties
FSP-D-1x2	FDC Splitter 1 x 2	1 in, 2 out	PLC Splitter single mode fiber input, single mode ribbon output
FSP-D-1x4	FDC Splitter 1 x 4	1 in, 4 out	PLC Splitter single mode fiber input, single mode ribbon output
FSP-D-1x8	FDC Splitter 1 x 8	1 in, 8 out	PLC Splitter single mode fiber input, single mode ribbon output
FSP-D-1x16	FDC Splitter 1 x 16	1 in, 16 out	PLC Splitter single mode fiber input, single mode ribbon output
FSP-D-1x32	FDC Splitter 1 x 32	1 in, 32 out	PLC Splitter single mode fiber input, single mode ribbon output

FDC Pole Mount Kits



PRODUCT DESCRIPTION

For fiber deployment in excessive snow regions or where additional security is required, the FDC Pole Mount Kit offers an alternative to aerial, below-grade or direct-buried deployment, to provide easy access and additional security. Each kit contains a pole mount bracket and associated hardware, to install any of the FDC Dome Closures to a wood pole.

PART NUMBERS AND KIT COMPONENTS

Part Number	FDC Compatibility	Kit Components
FD2-APLMT	Type A	<ul style="list-style-type: none"> One (1) galvanized mounting bracket Two (2) 3/8 inch x 3 inch galvanized lag screws Two (2) 3/8 inch galvanized lock washers
FD2-BPLMT	Type B	<ul style="list-style-type: none"> One (1) galvanized mounting bracket Two (2) 3/8 inch x 3 inch galvanized lag screws Two (2) 3/8 inch galvanized lock washers
FD2-CPLMT	Type C, Type D	<ul style="list-style-type: none"> One (1) painted mounting bracket Three (3) 3/8 inch x 3 inch galvanized lag screws Three (3) 3/8 inch galvanized lock washers

FDC Compression Grommet Kits

PRODUCT DESCRIPTION

The FDC compression grommet kit is used to seal cable entry for drop and branch cables. Cable grommets accommodate a cable from 9 mm to 25 mm in diameter. Drop grommets accommodate a round or flat drop cable from 7 mm to 9 mm.



PART NUMBERS AND KIT COMPONENTS

Part Number	FDC Compatibility	Number of Ports	Kit Components
FD2-GDR07	Type A, Type B	3 round drop ports (7 mm)	25 grommets
FD2-GDR09	Type A, Type B	2 round drop ports (9 mm)	25 grommets
FD2-GDF08	Type A, Type B	3 flat drop ports (4.5 x 8 mm)	25 grommets
FD2-GFR12	Type A, Type B	1 round port (9-12 mm)	25 grommets
FD2-GFR16	Type A, Type B	1 round port (13-16 mm)	25 grommets
FD2-CFR20	Type C, Type D	1 round port (20 mm)	25 grommets
FD2-CFR25	Type C, Type D	1 round port (25 mm)	25 grommets
FD2-CDR07	Type C, Type D	4 round ports (7-9 mm)	25 grommets
FD2-CDF08	Type C, Type D	4 flat drop ports (4.5 x 8 mm)	25 grommets

FDC Compression Connector Wrench

PRODUCT DESCRIPTION

The FDC compression connector wrench is used to secure the lock nut of the compression connector on all four types of the FD2 closure.



PART NUMBERS AND KIT COMPONENTS

Part Number	Kit Components
FD2-CTOOL	1 wrench



800.551.8948
SuperiorEssex.com

All information, content, data, specifications, packaging and part numbers detailed herein are subject to change. For the most up-to-date information, please visit SuperiorEssex.com. Purchase of this product is subject exclusively to the then current **Superior Essex International LP Terms and Conditions of Sale for Communications and Energy Cable, Wire and Connectivity Products**, which can be found on our website, SuperiorEssex.com, or provided to you upon request.

RF FEEDER CABLE AND JUMPERS

LHF Series Low Loss High Flexible Foam Dielectric FeederD-2
LHF Series (Ultimate High Performance)
Ultimate Low Loss High Flexible Foam Dielectric FeederD-4
HFSC Series Super Flexible Foam Dielectric FeederD-5
Fiber-to-the-Antenna (FTTA)D-6
RF Jumper CableD-7

RF CONNECTORS

DIN Series for LHFD-8
DIN Series for HFSCD-9
N Series for LHFD-10
N Series for HFSCD-11

IN-BUILDING WIRELESS CABLE AND JUMPERS

DAS Hybrid Fiber + CopperD-12
DAS Hybrid, Interlock Armored Fiber + CopperD-13
LHF Riser Low Loss High Flexible Foam Dielectric FeederD-14
LHF Plenum Low Loss High Flexible Air Dielectric FeederD-15
HFSC Riser Super Flexible Foam Dielectric FeederD-16
HFSC Plenum Super Flexible Air Dielectric FeederD-17
HFAC Riser Low Loss High Flexible Foam Dielectric FeederD-18
HFAC Plenum Low Loss High Flexible Air Dielectric FeederD-19
DAS Riser Jumper CableD-20
DAS Plenum Jumper CableD-21

IN-BUILDING WIRELESS CONNECTORS

DIN Series for LHFD-22
DIN Series for HFSCD-23
DIN Series for HFACD-24
N Series for LHFD-25
N Series for HFSCD-26
N Series for HFACD-27

WIRELESS ACCESSORIES

Cable Preparation ToolsD-28
Cushion and Boot Assembly KitD-29
Universal Weatherproofing KitD-30
Hoisting Grip Lace-Up and Pre-LacedD-31
Clip-On Grounding KitD-32
Universal Snap-in Hanger KitD-33
Stackable Snap-in Hanger KitD-34
Standard Hanger KitD-35
λ/4 Wave Surge ArrestorD-36
Gas Tube Surge ArrestorD-37
Round Adapter KitD-38
Stand-Off Adapter KitD-39
Three-Way Stand-Off Adapter KitD-40
Angle Adapter KitD-40
Ground Bus Bar KitD-41
Weather Proofing ShellD-42
Anti-Theft Hardware KitD-43

LHF Series

Low Loss High Flexible Foam Dielectric Feeder



LHF-12D



LHF-33D

PRODUCT DESCRIPTION

LHF Series cables are low loss 50 Ohm cables featuring a foamed polyethylene dielectric, annularly corrugated copper shield and polyethylene jacket.

FEATURES

- Low attenuation
- Low passive intermodulation
- Easy connectorization
- Factory tested and inspected
- Rugged and durable

BENEFITS

- Suitable for long cable runs
- Outperforms the industry requirements for low passive intermodulation
- Full line of high-quality low intermodulation DIN and N connectors and cable preparation tools minimize installation time and expenses
- 100% of all RF cables are inspected and tested to meet or exceed industry specifications including passive intermodulation
- High-quality materials result in rugged cables that are able to withstand extreme environments without corrosion

SPECIFICATIONS

Inner Conductor	LHF-12D: Copper-clad aluminum wire LHF-33D: Smooth copper tube
Dielectric	Foamed polyethylene
Outer Conductor	Annularly corrugated copper tube
Jacket	Black polyethylene
Recommended Operating Temperature °F (°C)	-40 to +185 (-40 to +80)

PART NUMBERS AND PHYSICAL CHARACTERISTICS

Part Number	Cable Size in (mm)	Nominal Diameter in (mm)				Minimum Bend Radius in (mm)	Approx. Weight lbs/kft (kg/km)	Flat Plate Crush Resistance lbs/in (kg/mm)	Maximum Pulling Force lbs (kg)
		Inner Conductor	Dielectric	Outer Conductor	Jacket				
LHF-12D	½ (12)	0.20 (5.0)	0.49 (12.5)	0.56 (14.2)	0.65 (16.4)	4.92 (125)	163 (244)	112 (2.0)	249 (113)
LHF-33D	1¼ (33)	0.54 (13.7)	1.32 (33.6)	1.43 (36.4)	1.55 (39.4)	14.96 (380)	613 (915)	134 (2.4)	572 (260)

ELECTRICAL SPECIFICATIONS

Part Number	Cable Size in (mm)	Conductor DC Resistance Ohms/kft (Ohms/km)		Insulation Resistance mΩ km	Dielectric Strength for 1 minute DC Potential - Volts	Velocity of Propagation %	Peak Power Rating kW	Maximum Operating Frequency GHz	Characteristic Impedance Ohms	Typical Return Loss dB
		Inner	Outer							
LHF-12D	½ (12)	0.5 (1.6)	0.6 (1.9)	10,000	4,000	89	40	8.8	50	28
LHF-33D	1¼ (33)	0.3 (1.1)	0.3 (1.0)	10,000	10,000	89	200	3.3	50 ± 1	28

Frequency MHz	Attenuation at 20°C dB/100 ft (dB/100 m)		Average Power Rating at Ambient 40°C Inner Conductor 100°C kW	
	LHF-12D	LHF-33D	LHF-12D	LHF-33D
30	0.35 (1.14)	0.13 (0.42)	6.10	21.30
100	0.65 (2.12)	0.24 (0.49)	3.32	11.50
150	0.79 (2.60)	0.30 (0.98)	2.71	9.32
450	1.40 (4.58)	0.54 (1.77)	1.55	5.23
824	1.92 (6.31)	0.76 (2.49)	1.13	3.78
894	2.00 (6.55)	0.80 (2.61)	1.09	3.61
960	2.08 (6.84)	0.83 (2.72)	1.05	3.48
1,000	2.13 (7.00)	0.85 (2.79)	1.03	3.40
1,700	2.84 (9.32)	1.17 (3.84)	0.78	2.53
1,800	2.93 (9.61)	1.21 (3.97)	0.76	2.45
2,000	3.11 (10.19)	1.30 (4.25)	0.71	2.31
2,400	3.38 (11.10)	1.44 (4.73)	0.65	2.09
2,700	3.81 (12.53)	1.56 (5.11)	0.61	1.95
3,000	3.95 (12.96)	1.66 (5.43)	0.58	1.84

Frequency MHz	VSWR	
	LHF-12D	LHF-33D
800-960	1.15	1.15
1,700-2,200	1.15	1.15

Standard Conditions: VSWR 1.0, Ambient Temperature 20°C/Attenuation is typical value.

Multiple Coax Solutions for a High Performing DAS

Three coaxial cable solutions for Distributed Antenna Systems

LHF
Copper Shielded
Lowest Loss
Performance

HFSC
Copper Shielded
Highest Flexibility
Flexibility

HFAC
Aluminum Shielded
Lowest Cost
Value

PLENUM
ETL UL 910 RATED CMP

LHF-12DP

HFSC-12DP

HFAC-12DP

RISER
ETL UL 1666 RATED CMR

LHF-12DR

HFSC-12DR

HFAC-12DR

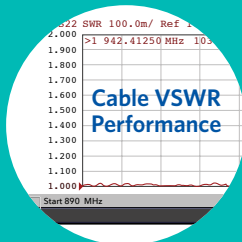

Industry-Leading Electricals

- Low attenuation across 30 MHz to 4,000 MHz
- Low Voltage Standing Wave Ratio (VSWR) <1.25 dB guaranteed across frequency bands (<1.1 dB typical)
- Low Passive Intermodulation (PIM) < -155 dBc



Superior Construction

- Precision-welded, solid annular outer conductor eliminates intermodulation
- Continuous dielectric spine provides homogenous support of outer conductor and maintains electrical performance in tight bends



Industry's Highest Safety Ratings

- Industry's highest rating of UL[®] 444 for in-building fire safety
- Plenum cables are ETL certified CMP using UL 910
- Riser cable is ETL certified CMR using UL1666

UL is a registered trademark of UL LLC.

LHF Series (Ultimate High Performance)

Ultimate Low Loss High Flexible Foam Dielectric Feeder

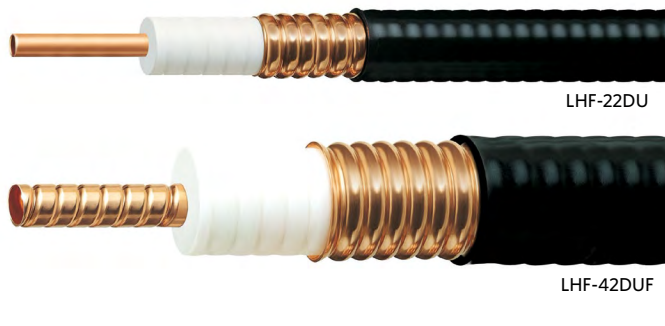

PRODUCT DESCRIPTION

LHF Ultimate High Performance Series cables are low loss 50 Ohm cables featuring a copper tube center conductor, foamed polyethylene dielectric and annularly corrugated copper metallic shield. Ultimate High Performance cables are designed to offer the low attenuation and high propagation velocity required by modern 3G and 4G networks.

FEATURES

- Low attenuation and high propagation velocity
- Low passive intermodulation
- Easy connectorization
- Factory tested and inspected
- Rugged and durable

BENEFITS

- Highly efficient signal transfer over long cable runs
- Outperforms the industry requirements for low passive intermodulation
- Full line of high-quality low intermodulation DIN and N connectors and cable preparation tools minimize installation time and expenses
- 100% of all RF cables are inspected and tested to meet or exceed industry specifications including passive intermodulation
- High-quality materials result in rugged cables that are able to withstand extreme environments without corrosion

SPECIFICATIONS

Inner Conductor	LHF-22DU: Smooth copper tube LHF-42DU: Corrugated copper tube
Dielectric	Foamed polyethylene
Outer Conductor	Annularly corrugated copper tube
Jacket	Black polyethylene
Recommended Operating Temperature °F (°C)	-40 to +185 (-40 to +80)

PART NUMBERS AND PHYSICAL CHARACTERISTICS

Part Number	Cable Size in (mm)	Nominal Diameter in (mm)				Minimum Bend Radius in (mm)	Approx. Weight lbs/kft (kg/km)	Flat Plate Crush Resistance lbs/in (kg/mm)	Maximum Pulling Force lbs (kg)
		Inner Conductor	Dielectric	Outer Conductor	Jacket				
LHF-22DU	7/8 (22)	0.37 (9.5)	0.91 (23.1)	1.00 (25.3)	1.11 (28.2)	9.84 (250)	316 (470)	100 (1.8)	323 (147)
LHF-42DUF	1 1/8 (42)	0.71 (18.1)	1.72 (43.6)	1.83 (46.6)	1.97 (50.0)	19.69 (500)	710 (1,059)	90 (1.6)	398 (181)

ELECTRICAL SPECIFICATIONS

Part Number	Cable Size in (mm)	Conductor DC Resistance Ohms/kft (Ohms/km)		Insulation Resistance mΩ km	Dielectric Strength for 1 minute DC Potential - Volts	Velocity of Propagation %	Peak Power Rating kW	Maximum Operating Frequency GHz	Characteristic Impedance Ohms	Typical Return Loss dB
		Inner	Outer							
LHF-22DU	7/8 (22)	0.6 (1.9)	0.6 (1.9)	10,000	6,000	91 ± 3	0.92	5.0	50 ± 1	28
LHF-42DUF	1 1/8 (42)	0.4 (1.6)	0.2 (0.7)	10,000	11,000	92 ± 3	2.77	2.5	50 ± 1	28

Frequency MHz	Attenuation at 20°C dB/100 ft (dB/100 m)		Average Power Rating at Ambient 40°C Inner Conductor 100°C kW	
	LHF-22D	LHF-42D	LHF-22DU	LHF-42DUF
450	0.73 (2.42)	0.43 (1.43)	-	-
700	0.93 (3.06)	0.55 (1.82)	-	-
824	1.02 (3.35)	0.61 (2.00)	2.49	3.60
894	1.07 (3.50)	0.64 (2.09)	2.38	3.44
960	1.11 (3.64)	0.66 (2.18)	-	-
1,700	1.52 (4.99)	0.92 (3.02)	1.67	2.38
1,800	-	-	1.61	2.30
2,000	1.66 (5.47)	1.01 (3.33)	1.54	2.16
2,400	1.85 (6.07)	1.13 (3.71)	-	-
3,000	2.10 (6.89)	-	-	-

Frequency MHz	VSWR	
	LHF-22DU	LHF-42DU
800-960	1.13	1.13
1,700-2,200	1.13	1.13

Standard Conditions: VSWR 1.0, Ambient Temperature 20°C/Attenuation is typical value.

PRODUCT DESCRIPTION

HFSC Series cables are super flexible lightweight coaxial cables featuring a copper clad aluminum conductor, foamed polyethylene dielectric and corrugated copper metallic shield. This helically corrugated cable has the highest number of corrugations per inch and the lowest minimum bending radius, making it well-suited for jumper cable and installations where bending and tight spaces require a more flexible cable.

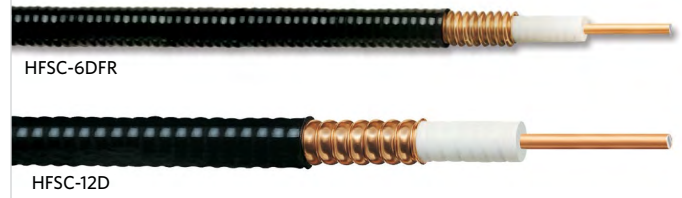

FEATURES

- Light weight and flexible
- Low passive intermodulation
- Easy connectorization
- Factory tested and inspected
- Rugged and durable
- Flame retardant zero halogen

BENEFITS

- Easy to transport and install
- Outperforms the industry requirements for low passive intermodulation
- Full line of high-quality low intermodulation DIN and N connectors and cable preparation tools minimize installation time and expense
- 100% of all RF cables are inspected and tested to meet or exceed industry specifications including passive intermodulation
- High-quality materials result in rugged cables that are able to withstand extreme environments without corrosion
- Standard ¼ inch cable meets IEC 754-1, 332, 383 and ASTM E 662

SPECIFICATIONS

Inner Conductor	Copper-clad aluminum wire
Dielectric	Foamed polyethylene
Outer Conductor	Helically corrugated copper tube
Jacket	HFSC-6DFR: Flame Retardant, Low Smoke Zero Halogen (LSZH) HFSC-12D: Black polyethylene
Recommended Operating Temperature °F (°C)	HFSC-6DFR: -22 to +176 (-30 to +80) HFSC-12D: -40 to +185 (-40 to +80)

PART NUMBERS AND PHYSICAL CHARACTERISTICS

Part Number	Cable Size in (mm)	Nominal Diameter in (mm)				Minimum Bend Radius in (mm)	Approx. Weight lbs/kft (kg/km)	Flat Plate Crush Resistance lbs/in (kg/mm)	Maximum Pulling Force lbs (kg)
		Inner Conductor	Dielectric	Outer Conductor	Jacket				
HFSC-6DFR	¼ (6)	0.07 (1.9)	0.19 (4.7)	0.25 (6.4)	0.31 (8.0)	0.98 (25)	54 (80)	161.44 (1.86)	150 (68)
HFSC-12D	½ (12)	0.14 (3.6)	0.35 (8.9)	0.48 (12.2)	0.54 (13.6)	1.26 (32)	135 (201)	147.60 (1.7)	143 (65)

ELECTRICAL SPECIFICATIONS

Part Number	Cable Size in (mm)	Conductor DC Resistance Ohms/kft (Ohms/km)		Insulation Resistance mΩ km	Dielectric Strength for 1 minute DC Potential - Volts	Velocity of Propagation %	Peak Power Rating kW	Maximum Operating Frequency GHz	Characteristic Impedance Ohms	Typical Return Loss dB
		Inner	Outer							
HFSC-6DFR	¼ (6)	2.99 (9.80)	1.98 (6.50)	10,000	1,600	81	6.4	20.4	50	28
HFSC-12D	½ (12)	0.87 (2.85)	0.99 (3.25)	10,000	2,500	81	15.6	10.0	50	28

Frequency MHz	Attenuation at 20°C dB/100 ft (dB/100 m)		Average Power Rating at Ambient 40°C Inner Conductor 100°C kW	
	HFSC-6DFR	HFSC-12D	HFSC-6DFR	HFSC-12D
	30	0.96 (3.15)	0.55 (1.80)	2.08
100	1.77 (5.82)	1.01 (3.33)	1.13	2.62
150	2.19 (7.17)	1.25 (4.10)	0.92	2.12
450	3.87 (12.70)	2.22 (7.29)	0.52	1.19
824	5.36 (17.60)	3.08 (10.10)	0.38	0.85
894	5.61 (18.40)	3.20 (10.50)	0.36	0.82
960	5.82 (19.10)	3.35 (11.00)	0.35	0.79
1,000	5.94 (19.50)	3.41 (11.20)	0.34	0.77
1,700	7.96 (26.10)	4.57 (15.00)	0.26	0.57
1,800	8.20 (26.90)	4.72 (15.50)	0.25	0.55
2,000	8.69 (28.50)	5.00 (16.40)	0.24	0.52
2,400	9.63 (31.60)	5.55 (18.20)	0.22	0.47
3,000	10.91 (35.80)	6.31 (20.70)	0.19	0.41
4,000	12.86 (42.20)	7.44 (24.40)	0.16	0.35
6,000	16.28 (53.40)	9.45 (31.00)	0.13	0.27
10,000	22.13 (72.60)	12.89 (42.30)	0.10	0.20

Frequency MHz	VSWR	
	HFSC-6DFR	HFSC-12D
800-960	1.15	1.15
1,700-2,200	1.15	1.15

Standard Conditions: VSWR 1.0, Ambient Temperature 20°C/Attenuation is typical value.

Fiber-to-the-Antenna (FTTA)

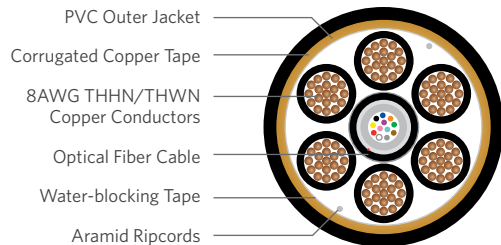

FIBER COMPONENT SPECIFICATIONS

Tight Buffer	Tight Buffered Low Smoke Zero Halogen (LSZH), Riser Available in 2-fiber up to 12-fiber
Loose Tube	Stranded Loose Tube Indoor/Outdoor OFNR, Series 13 Available in 12-fiber up to 288-fiber
Central Tube	Single Loose Tube Indoor/Outdoor OFNR, Series 53 Available in 2-fiber up to 96-fiber
Performance Compliance	Telcordia® GR-20-CORE

Telcordia is a registered trademark of Ericsson Inc.

POWER COMPONENT SPECIFICATIONS

Conductor	Annealed stranded copper (19 strands)
AWG	Available in 8 AWG
Insulation	Polyvinyl Chloride (PVC) covered with colored Nylon (THHN/THWN-2)
Temperature Ratings	Rated at 90°C for dry locations Rated at 75°C for wet locations
Performance Compliance	ASTM B8 or ASTM B-787 UL® 83
Other Compliance	Sunlight Resistant RoHS-compliant

ENVIRONMENTAL SPECIFICATIONS

Operation/Storage	-40°C to +70°C
Installation	-10°C to +65°C

PART NUMBERS AND PHYSICAL CHARACTERISTICS

Part Number	Conductor Count	AWG (mm)	Fiber Component	Fiber Count	Nominal Diameter in (mm)	Approx. Weight lbs/kft (kg/km)	Maximum Tensile Load		Minimum Bend Radius	
							Install lbs (N)	Long Term lbs (N)	Install in (mm)	Long Term in (mm)
53012K01Q	-	-	Central tube	12	0.37 (9.5)	52 (78)	600 (2,700)	200 (890)	7.4 (188)	3.7 (94)
53024K01Q	-	-	Central tube	24	0.37 (9.5)	53 (79)	600 (2,700)	200 (890)	7.4 (188)	3.7 (94)
53048J01Q	-	-	Central tube	48	0.37 (9.5)	54 (80)	600 (2,700)	200 (890)	7.4 (188)	3.7 (94)
GM012K221	6	8 (3.26)	Tight buffer	12	0.86 (21.8)	568 (847)	600 (2,700)	200 (890)	17.2 (236)	8.6 (218)
GM012K111	6	8 (3.26)	Central tube	12	0.87 (22.0)	568 (847)	600 (2,700)	200 (890)	17.4 (440)	8.7 (220)
GM012K011	6	8 (3.26)	Loose tube	12	0.95 (24.1)	614 (915)	600 (2,700)	200 (890)	19.0 (482)	9.5 (241)

Part numbers listed are TeraFlex® Bend Resistant single mode optical fiber only. Other fiber types available. See "Optical Fiber Specifications" in the "Technical Information" section for detailed fiber type specifications.

PRODUCT DESCRIPTION

Fiber-to-the-Antenna (FTTA) cables are designed to address the movement of electronics from the ground hut to the cell tower, allowing significant improvement in available bandwidth. Superior Essex offers two types of cable for this application: optical fiber and hybrid (containing both optical fibers and copper power conductors). Optical fiber cables are available with PFM™ gel; hybrid cables are available with either PFM gel components or tight buffered components. Each of the options provide a solution to the challenges of temperature changes, wind shear and vertical applications. The hybrid offering also has a copper shield option for lightning protection and a PVC jacket to increase the coefficient friction between the outer jacket and tower clamps.

APPLICATIONS

- Fiber-to-the-Antenna
- Fiber-to-the-Remote Radio Head

FEATURES

- PFM gel or tight buffer
- Hybrid designs
- Shield options
- Jacketing options
- Range of fibers
- Optional signaling component available

BENEFITS

- Proven performance in tower applications
- Reduces required number of cables
- Customer preference for lightning protection
- Customer preference for jacketing material
- Addresses multiple provider/capacity requirements
- Offers system feedback

PRODUCT DESCRIPTION

Jumper cables offer outstanding electrical performance along with high durability for tight routing and superior environmental sealing for long life reliability.

Available in 3/8 inch and 1/2 inch diameters, jumper cables are used in areas that require extremely small bending radius, such as between main feeders and antennas or between main feeders and RF equipment.

FEATURES/BENEFITS

- High pull-off strength
- Excellent VSWR performance
- Low and stable intermodulation
- Weatherproof



SPECIFICATIONS

Compatible Cable Type	HFSC-12D
Compatible Cable Size in (mm)	1/2 (12)
Minimum Bend Radius in (mm)	1.26 (32)
Typical VSWR	1.08 over Cellular, PCS and 3G-band
Intermodulation (PIM) dBc	< -158
Recommended Operating Temperature °F (°C)	-40 to +185 (-40 to +80)

PART NUMBERS AND PHYSICAL CHARACTERISTICS

Part Number	Interface Type		Standard Length ft (m)	Unit of Measure
	End 1	End 2		
J12-1DMDM	DIN Male, Straight	DIN Male, Straight	3.3 (1)	Each
J12-1NMNM	N Male, Straight	N Male, Straight	3.3 (1)	Each
J12-2DMDM	DIN Male, Straight	DIN Male, Straight	6.6 (2)	Each
J12-2NMNM	N Male, Straight	N Male, Straight	6.6 (2)	Each
J12-3DMDM	DIN Male, Straight	DIN Male, Straight	9.8 (3)	Each
J12-3NMNM	N Male, Straight	N Male, Straight	9.8 (3)	Each
J12-3NMNMR	N Male, Straight	N Male, Right Angle	9.8 (3)	Each
J12-4DMDM	DIN Male, Straight	DIN Male, Straight	13.1 (4)	Each
J12-4NMNM	N Male, Straight	N Male, Straight	13.1 (4)	Each
J12-5DMDM	DIN Male, Straight	DIN Male, Straight	16.4 (5)	Each
J12-5DMDMDF	DIN Male, Straight	DIN Female, Straight	16.4 (5)	Each
J12-5NMNM	N Male, Straight	N Male, Straight	16.4 (5)	Each
J12-6NMNMR	N Male, Straight	N Male, Right Angle	19.7 (6)	Each

EXPLANATION OF PART NUMBERS

J12-2DMDMR				
Product Category	Compatible Cable Size	Jumper Length	Connector for End 1	Connector for End 2
J = Jumper Cable	12 = 1/2 inch (12 mm)	1 = 1 meter 2 = 2 meters 3 = 3 meters 4 = 4 meters 5 = 5 meters 6 = 6 meters	DM = DIN Male straight DMR = DIN Male Right angle DF = DIN Female straight DFR = DIN Female Right angle NM = N Male straight NMR = N Male Right angle NF = N Female NFR = N Female Right angle	DM = DIN Male straight DMR = DIN Male Right angle DF = DIN Female straight DFR = DIN Female Right angle NM = N Male straight NMR = N Male Right angle NF = N Female NFR = N Female Right angle

DIN Series for LHF



½ inch (12 mm)



¾ inch (22 mm)



1¼ inch (33 mm)



1⅝ inch (42 mm)

SPECIFICATIONS

Bodies, Cap (Coupling Nut) Material	Brass/silver plated or Su Co (Alloy of Cu/Sn/Zn) plated
Back Nut Material	Brass/nickel plated
Pin Material	Male: Brass/silver plated or Su Co (Alloy of Cu/Sn/Zn) plated Female: Beryllium - copper/silver plated or Su Co (Alloy of Cu/Sn/Zn) plated
Insulator Material	Plated PTFE (Teflon®)
Gasket Material	Silicon rubber
Recommended Coupling Nut Torque Nm	25-30
Coupling Nut Retention Force Nm	1,000
Contact Captivation N	200
Mating Durability	500 times

Teflon is a registered trademark of E. I. du Pont de Nemours and Company or its affiliates.

PRODUCT DESCRIPTION

This DIN Series is compatible with the LHF Feeder Series. The connectors are manufactured from an alloy material of copper, tin and zinc to produce a highly polished, precise, and strong connector. This alloy combination allows a better operating temperature range and improved environmental performance.

FEATURES/BENEFITS

- Two-piece design is the industry standard
- Simple 6-step user friendly installation process
- Ordinary tools needed; available in a common installers tool bag
- Connector can be disassembled and re-used
- Offers stable connections

ELECTRICAL SPECIFICATIONS

Impedance Ω	50
Maximum Frequency Range GHz	7.5
VSWR (Mating) straight (right angle)	1 GHz: 1.08 (1.12) 2 GHz: 1.10 (1.15)
Maximum Insertion Loss dB @ 3 GHz	0.2
Intermodulation (PIM) dBc	< -155
Dielectric Withstanding Voltage kV rms @ 50 Hz	4.0
Working Voltage kV rms @ 50 Hz	2.7
Insulation Resistance GΩ	10
Contact Resistance mΩ	Inner: 0.4 Outer: 1.5

ENVIRONMENTAL SPECIFICATIONS

Temperature Range °F (°C)	-49 to +185 (-45 to +85)
Corrosion (Salt Spray Test)	IEC-68-2-11-Ka
Vibration	CECC 22000 Part 4.6.3
Waterproof	IP68

PART NUMBERS AND PHYSICAL CHARACTERISTICS

Part Number	DIN Interface Type		Compatible Cable Size in (mm)	Length in (mm)	Diameter in (mm)	Weight oz (g)
	Gender	Straight or Angle				
CLH-12DF	Female	Straight	½ (12)	2.65 (67.4)	0.86 (21.8)	5.3 (150)
CLH-12DFR	Female	Right Angle	½ (12)	-	-	-
CLH-12DM	Male	Straight	½ (12)	2.57 (65.4)	0.86 (21.8)	6.5 (183)
CLH-12DMR	Male	Right Angle	½ (12)	-	-	-
CLH-22DF	Female	Straight	¾ (22)	2.62 (66.5)	1.39 (35.2)	7.4 (210)
CLH-22DM	Male	Straight	¾ (22)	2.81 (71.5)	1.39 (35.2)	8.1 (230)
CLH-33DF	Female	Straight	1¼ (33)	3.50 (88.9)	1.87 (47.6)	19.8 (560)
CLH-33DM	Male	Straight	1¼ (33)	3.76 (95.4)	1.87 (47.6)	19.8 (560)
CLH-42DF	Female	Straight	1⅝ (42)	3.92 (99.5)	2.35 (59.6)	35.3 (1,000)
CLH-42DM	Male	Straight	1⅝ (42)	4.21 (107.0)	2.35 (59.6)	37.7 (1,070)



TECHNICAL GUIDELINE

Installation guidelines are available for these connectors. Refer to the "Resources" section on our site for the Technical Guideline, "DIN Connectors and N Connectors Installation Guidelines," for more information.

PRODUCT DESCRIPTION

This DIN Series is compatible with the HFSC Feeder Series. The connectors are manufactured from an alloy material of copper, tin and zinc to produce a highly polished, precise, and strong connector. This alloy combination allows a better operating temperature range and improved environmental performance.

FEATURES/BENEFITS

- Two-piece design is the industry standard
- Connector can be disassembled and re-used
- Excellent VSWR
- Low PIMD
- Fast and easy to install
- Waterproof (IP68)
- RoHS-compliant



½ inch (12 mm)

ELECTRICAL SPECIFICATIONS

Impedance Ω	50
Maximum Frequency Range GHz	7.5
VSWR (Mating) straight (right angle)	1 GHz: 1.08 (1.12) 2 GHz: 1.10 (1.15)
Maximum Insertion Loss dB @ 3 GHz	0.2
Intermodulation (PIM) dBc	< -155
Dielectric Withstanding Voltage kV rms @ 50 Hz	4.0
Working Voltage kV rms @ 50 Hz	2.7
Insulation Resistance GΩ	10
Contact Resistance mΩ	Inner: 0.4 Outer: 1.5

ENVIRONMENTAL SPECIFICATIONS

Temperature Range °F (°C)	-49 to +185 (-45 to +85)
Corrosion (Salt Spray Test)	IEC-68-2-11-Ka
Vibration	CECC 22000 Part 4.6.3
Waterproof	IP68

SPECIFICATIONS

Bodies, Cap (Coupling Nut) Material	Brass/silver plated or Su Co (Alloy of Cu/Sn/Zn) plated
Back Nut Material	Brass/nickel plated
Pin Material	Male: Brass/silver plated or Su Co (Alloy of Cu/Sn/Zn) plated Female: Beryllium - copper/silver plated or Su Co (Alloy of Cu/Sn/Zn) plated
Insulator Material	Plated PTFE (Teflon®)
Gasket Material	Silicon rubber
Recommended Coupling Nut Torque Nm	25-30
Coupling Nut Retention Force Nm	1,000
Contact Captivation N	200
Mating Durability	500 times

Teflon is a registered trademark of E. I. du Pont de Nemours and Company or its affiliates.

PART NUMBERS AND PHYSICAL CHARACTERISTICS

Part Number	DIN Interface Type		Compatible Cable Size in (mm)	Length in (mm)	Diameter in (mm)	Weight oz (g)
	Gender	Straight or Angle				
CHFS-6DF	Female	Straight	¼ (6)	2.00 (50.9)	0.72 (18.5)	4.23 (120)
CHFS-6DM	Male	Straight	¼ (6)	2.02 (51.3)	0.72 (18.5)	4.59 (130)
CHFS-6DMR	Male	Right Angle	¼ (6)	2.21 (56.2)	0.72 (18.5)	7.05 (200)
CHFS-12DF	Female	Straight	½ (12)	2.65 (67.4)	0.86 (21.8)	5.3 (150)
CHFS12DFR	Female	Right Angle	½ (12)	-	-	-
CHFS-12DM	Male	Straight	½ (12)	2.57 (65.4)	0.86 (21.8)	6.5 (183)
CHFS12DMR	Male	Right Angle	½ (12)	-	-	-



TECHNICAL GUIDELINE

Installation guidelines are available for these connectors. Refer to the "Resources" section on our site for the Technical Guideline, "DIN Connectors and N Connectors Installation Guidelines," for more information.

N Series for LHF



½ inch (12 mm)



¾ inch (22 mm)



1¼ inch (33 mm)



1½ inch (42 mm)

SPECIFICATIONS

Bodies, Cap (Coupling Nut) Material	Brass/silver plated or Su Co (Alloy of Cu/Sn/Zn) plated
Back Nut Material	Brass/nickel plated
Pin Material	Male: Brass/silver plated or Su Co (Alloy of Cu/Sn/Zn) plated Female: Beryllium - copper/silver plated or Su Co (Alloy of Cu/Sn/Zn) plated
Insulator Material	Plated PTFE (Teflon®)
Gasket Material	Silicon rubber
Recommended Coupling Nut Torque Nm	25-30
Coupling Nut Retention Force Nm	1,000
Contact Captivation N	200
Mating Durability	500 times

Teflon is a registered trademark of E. I. du Pont de Nemours and Company or its affiliates.

PRODUCT DESCRIPTION

This N Series is compatible with the LHF Feeder Series. The connectors are manufactured from an alloy material of copper, tin and zinc to produce a highly polished, precise, and strong connector. This alloy combination allows a better operating temperature range and improved environmental performance.

FEATURES/BENEFITS

- Two-piece design is the industry standard
- Simple 6-step user friendly installation process
- Ordinary tools needed; available in a common installers tool bag
- Connector can be disassembled and re-used
- Offers stable connections

ELECTRICAL SPECIFICATIONS

Impedance Ω	50
Maximum Frequency Range GHz	7.5
VSWR (Mating) straight (right angle)	1 GHz: 1.08 (1.12) 2 GHz: 1.10 (1.15)
Maximum Insertion Loss dB @ 3 GHz	0.2
Intermodulation (PIM) dBc	< -155
Dielectric Withstanding Voltage kV rms @ 50 Hz	4.0
Working Voltage kV rms @ 50 Hz	2.7
Insulation Resistance GΩ	10
Contact Resistance mΩ	Inner: 0.4 Outer: 1.5

ENVIRONMENTAL SPECIFICATIONS

Temperature Range °F (°C)	-40 to +185 (-40 to +85)
Corrosion (Salt Spray Test)	IEC-68-2-11-Ka
Vibration	CECC 22000 Part 4.6.3
Waterproof	IP68

PART NUMBERS AND PHYSICAL CHARACTERISTICS

Part Number	N Interface Type		Compatible Cable Size in (mm)	Length in (mm)	Diameter in (mm)	Weight oz (g)
	Gender	Straight or Angle				
CLH-12NF	Female	Straight	½ (12)	2.75 (69.8)	0.86 (21.8)	4.1 (115)
CLH-12NFR	Female	Right Angle	½ (12)	-	-	-
CLH-12NM	Male	Straight	½ (12)	2.75 (69.8)	0.86 (21.8)	4.2 (120)
CLH-12NMR	Male	Right Angle	½ (12)	-	-	-
CLH-22NF	Female	Straight	¾ (22)	2.75 (69.9)	1.39 (35.2)	7.6 (215)
CLH-22NM	Male	Straight	¾ (22)	2.86 (72.7)	1.39 (35.2)	7.6 (215)
CLH-33NF	Female	Straight	1¼ (33)	3.76 (95.5)	1.87 (47.6)	19.8 (560)
CLH-33NM	Male	Straight	1¼ (33)	3.86 (98.0)	1.87 (47.6)	19.8 (560)
CLH-42NF	Female	Straight	1½ (42)	41.3 (105.0)	2.35 (59.6)	35.3 (1,000)
CLH-42NM	Male	Straight	1½ (42)	4.25 (108.0)	2.35 (59.6)	37.7 (1,070)



TECHNICAL GUIDELINE

Installation guidelines are available for these connectors. Refer to the "Resources" section on our site for the Technical Guideline, "DIN Connectors and N Connectors Installation Guidelines," for more information.

N Series for HFSC

PRODUCT DESCRIPTION

This N Series is compatible with the HFSC Feeder Series. The connectors are manufactured from an alloy material of copper, tin and zinc to produce a highly polished, precise, and strong connector. This alloy combination allows a better operating temperature range and improved environmental performance.

FEATURES/BENEFITS

- Two-piece design is the industry standard
- Connector can be disassembled and re-used
- Excellent VSWR
- Low PIMD
- Fast and easy to install
- Waterproof (IP68)
- RoHS-compliant



½ inch (12 mm)

ELECTRICAL SPECIFICATIONS

Impedance Ω	50
Maximum Frequency Range GHz	7.5
VSWR (Mating) straight (right angle)	1 GHz: 1.08 (1.12) 2 GHz: 1.10 (1.15)
Maximum Insertion Loss dB @ 3 GHz	0.2
Intermodulation (PIM) dBc	< -155
Dielectric Withstanding Voltage kV rms @ 50 Hz	4.0
Working Voltage kV rms @ 50 Hz	2.7
Insulation Resistance GΩ	10
Contact Resistance mΩ	Inner: 0.4 Outer: 1.5

ENVIRONMENTAL SPECIFICATIONS

Temperature Range °F (°C)	-40 to +185 (-40 to +85)
Corrosion (Salt Spray Test)	IEC-68-2-11-Ka
Vibration	CECC 22000 Part 4.6.3
Waterproof	IP68

SPECIFICATIONS

Bodies, Cap (Coupling Nut) Material	Brass/silver plated or Su Co (Alloy of Cu/Sn/Zn) plated
Back Nut Material	Brass/nickel plated
Pin Material	Male: Brass/silver plated or Su Co (Alloy of Cu/Sn/Zn) plated Female: Beryllium - copper/silver plated or Su Co (Alloy of Cu/Sn/Zn) plated
Insulator Material	Plated PTFE (Teflon®)
Gasket Material	Silicon rubber
Recommended Coupling Nut Torque Nm	25-30
Coupling Nut Retention Force Nm	1,000
Contact Captivation N	200
Mating Durability	500 times

Teflon is a registered trademark of E. I. du Pont de Nemours and Company or its affiliates.

PART NUMBERS AND PHYSICAL CHARACTERISTICS

Part Number	N Interface Type		Compatible Cable Size in (mm)	Length in (mm)	Diameter in (mm)	Weight oz (g)
	Gender	Straight or Angle				
CHFS-6NF	Female	Straight	¼ (6)	2.16 (54.9)	0.72 (18.5)	3.35 (95)
CHFS-6NM	Male	Straight	¼ (6)	2.20 (56.0)	0.72 (18.5)	3.52 (100)
CHFS-6NMR	Male	Right Angle	¼ (6)	2.21 (56.2)	0.72 (18.5)	7.05 (200)
CHFS-12NF	Female	Straight	½ (12)	2.75 (69.8)	0.86 (21.8)	4.1 (115)
CHFS12NFR	Female	Right Angle	½ (12)	-	-	-
CHFS-12NM	Male	Straight	½ (12)	2.75 (69.8)	0.86 (21.8)	4.2 (120)
CHFS12NMR	Male	Right Angle	½ (12)	-	-	-



TECHNICAL GUIDELINE

Installation guidelines are available for these connectors. Refer to the "Resources" section on our site for the Technical Guideline, "DIN Connectors and N Connectors Installation Guidelines," for more information.

DAS Hybrid

Fiber + Copper

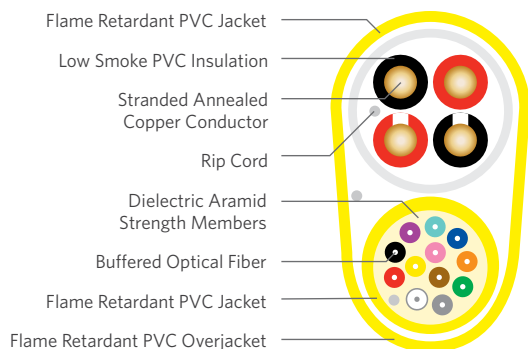

PRODUCT DESCRIPTION

A jacketed multi-strand optical fiber cable and a jacketed multi-conductor copper cable are covered with an overjacket to form a single hybrid cable. The optical fiber cable contains 12 flexible 900 μm tight buffered single mode fibers for voice and data communications. The non-shielded copper cable contains four 12 AWG conductors ideal for carrying power, control signals and video.

Hybrid cables are intended for applications that utilize centralized DC power and comply with NEC Article 725 for Class 2 power limited circuits. A hybrid cable reduces installation time and labor by allowing both fiber and copper cables to be pulled as a single cable, eliminating the need for two separate pulls. Labor costs are further minimized because the cable can be pulled by a telecom installer instead of an electrician.

APPLICATIONS

- Distributed Antenna Systems (DAS)
- CCTV
- Wi-Fi

FEATURES

- Two cables covered with an overjacket to form a single cable
- Overjacket design plus rip cord
- NEC Class 2 power limited circuit
- UL® 13 CL2P plenum rated
- 900 μm tight buffered
- Large 12 AWG copper wires
- QuickCount® marking system in feet and meters

BENEFITS

- One pull eliminates the time and labor cost for a second pull
- Easy to separate and route fiber and copper to different termination points
- Installation doesn't have to be done by an electrician
- Cable can be installed throughout a building, including air carrying plenum space, without being enclosed in a raceway
- Easy connectorization in the field
- For long cable runs
- Provides remaining length of cable on reel, resulting in less scrap

COPPER COMPONENT SPECIFICATIONS

Configuration	Stranded bare copper with uniquely colored insulation, jacketed, non-shielded
Conductor Count	4 conductors
Conductor	Fully annealed, stranded bare copper
Conductor Type	19 x 0.185"
AWG (mm)	12 (2.05)
Insulation	Low smoke PVC
Insulation Colors	Conductor 1: Black Conductor 2: Red Conductor 3: Black with white stripe Conductor 4: Red with white stripe
Jacket	White, Flame Retardant (FR) PVC
Performance Compliance	NEC Article 725 NEC Article 800 NFPA 262
NRTL Programs	UL Listed CL3P

OPTICAL FIBER COMPONENT SPECIFICATIONS

Configuration	Flexible 900 μm tight buffered fibers, dielectric aramid yarns and overall jacket
Fiber Count	12
Fiber Type	Single mode TeraFlex® Bend Resistant G.657.A1
Maximum Tensile Loading lbs (N)	Install: 100 (400) Long Term: 30 (130)
Jacket	Yellow, FR PVC
Performance Compliance	UL 1651 CSA C22.2 No. 232 NFPA 262 Telcordia® GR-409-CORE, Issue 2 ANSI/ICEA S-83-596 ANSI/TIA-568-C.3
NRTL Programs	UL, c(UL) Listed OFNP

Telcordia is a registered trademark of Ericsson Inc. UL is a registered trademark of UL LLC.

COMPOSITE SPECIFICATIONS

Jacket	Yellow, FR PVC
Performance Compliance	NEC Article 725 ANSI/ICEA S-83-596 RoHS-compliant (RoHS 2 Directive 2011/65/EU)
NRTL Programs	UL Listed CL2P

ENVIRONMENTAL SPECIFICATIONS

Storage/Shipping	-40°C to +65°C
Operation	0°C to +75°C

PART NUMBERS AND PHYSICAL CHARACTERISTICS

Part Number	Copper Component Nominal Diameter in (mm)	Fiber Component Nominal Diameter in (mm)	Overall Nominal Diameter in (mm)		Approx. Weight lbs/kft	Maximum Tensile Loading		Minimum Bend Radius	
			Minor in (mm)	Major in (mm)		Install lbs	Long Term lbs	Install in (mm)	Long Term in (mm)
F4C2-012U13-6991-CE5	0.29 (7.31)	0.24 (6.2)	0.38 (9.66)	0.62 (15.76)	160	150	45	7.6 (193)	3.8 (96)

DAS Hybrid, Interlock Armored

Fiber + Copper

PRODUCT DESCRIPTION

A jacketed multi-strand optical fiber cable and a jacketed multi-conductor copper cable are covered with an overjacket to form a single hybrid cable. The optical fiber cable contains 12 flexible 900 μm tight buffered single mode fibers for voice and data communications. The non-shielded copper cable contains four 12 AWG conductors ideal for carrying power, control signals and video.

Hybrid cables are intended for applications that utilize centralized DC power and comply with NEC Article 725 for Class 2 power limited circuits. A hybrid cable reduces installation time and labor by allowing both fiber and copper cables to be pulled as a single cable, eliminating the need for two separate pulls. Labor costs are further minimized because the cable can be pulled by a telecom installer instead of an electrician.

APPLICATIONS

- Distributed Antenna Systems (DAS)
- CCTV
- Wi-Fi

FEATURES

- Two cables covered with an overjacket to form a single cable
- Overjacket design plus rip cord
- NEC Class 2 power limited circuit
- UL® 13 CL2P plenum rated
- 900 μm tight buffered
- Large 12 AWG copper wires
- QuickCount® marking system in feet and meters

BENEFITS

- One pull eliminates the time and labor cost for a second pull
- Easy to separate and route fiber and copper to different termination points
- Installation doesn't have to be done by an electrician
- Cable can be installed throughout a building, including air carrying plenum space, without being enclosed in a raceway
- Easy connectorization in the field
- For long cable runs
- Provides remaining length of cable on reel, resulting in less scrap

COMPOSITE SPECIFICATIONS

Jacket	Yellow, FR PVC
Armor	Flexible heavy duty interlocking aluminum tape helically applied over the jacketed fiber and copper cables
Performance Compliance	NEC Article 725 ANSI/ICEA S-83-596 RoHS-compliant (RoHS 2 Directive 2011/65/EU)
NRTL Programs	UL Listed CL2P

ENVIRONMENTAL SPECIFICATIONS

Storage/Shipping	-40°C to +70°C
Operation	0°C to +70°C
Installation	0°C to +60°C

PART NUMBERS AND PHYSICAL CHARACTERISTICS

Part Number	Copper Component Nominal Diameter in (mm)	Fiber Component Nominal Diameter in (mm)	Overall Nominal Diameter in (mm)	Approx. Weight lbs/kft	Maximum Tensile Loading		Minimum Bend Radius	
					Install lbs	Long Term lbs	Install in (mm)	Long Term in (mm)
F2C2-012U13-6991-CE5	0.29 (7.31)	0.24 (6.2)	0.87 (22.0)	315	150	45	17.3 (440)	8.7 (220)

UL is a registered trademark of UL LLC. Telcordia is a registered trademark of Ericsson Inc.

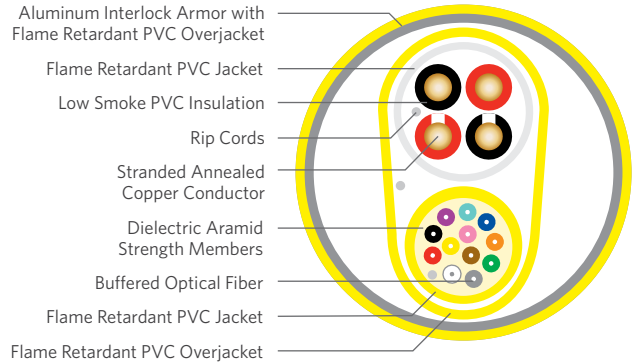

COPPER COMPONENT SPECIFICATIONS

Configuration	Stranded bare copper with uniquely colored insulation, jacketed, non-shielded
Conductor Count	4 conductors
Conductor	Fully annealed, stranded bare copper
Conductor Type	19 x 0.185"
AWG (mm)	12 (2.05)
Insulation	Low smoke PVC
Insulation Colors	Conductor 1: Black Conductor 2: Red Conductor 3: Black with white stripe Conductor 4: Red with white stripe
Jacket	White, Flame Retardant (FR) PVC
Performance Compliance	NEC Article 725 NEC Article 800 NFPA 262
NRTL Programs	UL Listed CL3P

OPTICAL FIBER COMPONENT SPECIFICATIONS

Configuration	Flexible 900 μm tight buffered fibers, dielectric aramid yarns and overall jacket
Fiber Count	12
Fiber Type	Single mode TeraFlex® Bend Resistant G.657.A1
Maximum Tensile Loading lbs (N)	Install: 100 (400) Long Term: 30 (130)
Jacket	Yellow, FR PVC
Performance Compliance	UL 1651 CSA C22.2 No. 232 NFPA 262 Telcordia® GR-409-CORE, Issue 2 ANSI/ICEA S-83-596 ANSI/TIA-568-C.3
NRTL Programs	UL, c(UL) Listed OFNP

Telcordia is a registered trademark of Ericsson Inc. UL is a registered trademark of UL LLC.

LHF Riser

Low Loss High Flexible Foam Dielectric Feeder

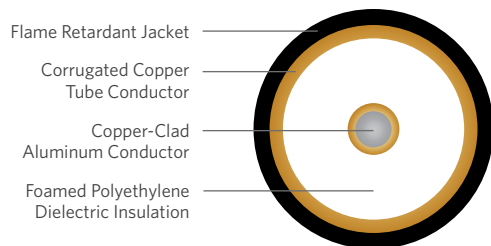

Flame Retardant Jacket
Corrugated Copper Tube Conductor
Copper-Clad Aluminum Conductor
Foamed Polyethylene Dielectric Insulation

SPECIFICATIONS

Inner Conductor Material	Copper-clad aluminum
Dielectric Material	Foamed polyethylene
Outer Conductor Material	Corrugated copper tube
Jacket Material	Black, flame retardant PE
Recommended Operating Temperature °F (°C)	-22 to +167 (-30 to +75)

PRODUCT DESCRIPTION

LHF-12DR is a ½ inch, 50 Ohm Riser Rated RF coaxial cable that enables mobile communications inside buildings. Installed to eliminate dead zones and spotty coverage, this cable functions as the backbone cable of in-building DAS wireless systems. With its riser (CMR) rating, this coaxial cable offers flexibility and high crush resistance in a ½ inch size. Designed for high performance, its copper clad aluminum inner conductor, foamed PE dielectric insulation, corrugated copper outer conductor, and its black outer riser rated jacket exceed the requirements of all in-building DAS active systems.

APPLICATIONS

- In-building Wireless
- Distributed Antenna System (DAS)

FEATURES

- Lowest attenuation
- Low passive intermodulation
- Non-halogenated, fire retardant, black polyethylene jacket
- ETL Certified CMR (UL® 1666)/CATVR (UL 1581)
- Full range of easy to install connectors and an automated cable prep tool

BENEFITS

- Highly efficient signal transfer
- Outperforms the industry requirements for low PIM
- Rugged and durable jacket slows the spread of flame without releasing toxic smoke
- Suitable for vertical cable runs in a shaft or that penetrate more than one floor within a building
- Shortens installation time and expenses

RELATED PRODUCTS

- Connectors CLH-12xx
- Cable prep tool T-LHF12DR

PART NUMBERS AND PHYSICAL CHARACTERISTICS

Part Number	Cable Size in (mm)	Nominal Diameter in (mm)				Minimum Bend Radius in (mm)	Approx. Weight lbs/kft (kg/km)	Flat Plate Crush Resistance lbs/in (kg/mm)	Maximum Pulling Force lbs (kg)
		Inner Conductor	Dielectric	Outer Conductor	Jacket				
LHF-12DR	½ (12)	0.19 (5.0)	0.49 (12.5)	0.55 (14.1)	0.64 (16.3)	4.90 (125)	165 (256)	112 (2.0)	249 (113)

ELECTRICAL SPECIFICATIONS

Part Number	Cable Size in (mm)	Conductor DC Resistance Ohms/kft (Ohms/km)		Minimum Insulation Resistance mΩ km	Dielectric Strength for 1 minute DC Potential - Volts	Velocity of Propagation %	Peak Power Rating kW	Maximum Operating Frequency GHz	Characteristic Impedance Ohms	Typical Return Loss dB
		Inner	Outer							
LHF-12DR	½ (12)	0.50 (1.6)	0.85 (2.8)	10,000	4,000	89	40	8.8	50 ± 1	23

Frequency MHz	Nominal Attenuation* dB/100 ft (dB/100 m)	Average Power Rating at Ambient 40°C Inner Conductor 100°C kW
30	0.35 (1.14)	6.10
100	0.65 (2.12)	3.32
150	0.79 (2.60)	2.71
450	1.40 (4.58)	1.55
824	1.92 (6.31)	1.13
890	2.00 (6.55)	1.09
960	2.08 (6.84)	1.05
1,000	2.13 (7.00)	1.03
1,700	2.84 (9.32)	0.78
1,800	2.93 (9.61)	0.76
2,000	3.11 (10.19)	0.71
2,400	3.38 (11.10)	0.65
3,000	3.95 (12.96)	0.58
4,000	-	0.50

Frequency MHz	VSWR
806-960	≤ 1.15
1,700-2,155	≤ 1.15

*The attenuation may rise by 0.2%/°C with rising temperature. Maximum attenuation shall not exceed 105% of nominal value. Standard Conditions: VSWR 1.0, Ambient Temperature 20°C/Attenuation is typical value. UL is a registered trademark of UL LLC.

LHF Plenum

Low Loss High Flexible Air Dielectric Feeder

PRODUCT DESCRIPTION

LHF-12DP is a ½ inch, low loss 50 Ohm Plenum Rated RF coaxial cable that is installed in the plenum space of a building as part of an in-building DAS system to eliminate dead zones and spotty coverage. Designed with a copper clad aluminum center conductor, air dielectric center structure, helically corrugated copper tube outer conductor, and Plenum Rated outer jacket, the LHF-12DP is a high performing cable with low loss attenuation.

APPLICATIONS

- In-building Wireless
- Distributed Antenna System (DAS)

FEATURES

- Lowest attenuation
- Low passive intermodulation
- High-quality, white PVDF jacket
- ETL Certified CMP (UL® 444)
- Full range of easy to install connectors and an automated cable prep tool

BENEFITS

- Highly efficient signal transfer
- Outperforms the industry requirements for low PIM
- Flame retardant and low smoke; blends with background for optimal building aesthetics
- Safe to use throughout a building, including air carrying plenum space
- Shortens installation time and expenses

RELATED PRODUCTS

- Connectors CLHP-12xx
- Cable prep tool T-LHFA12DP

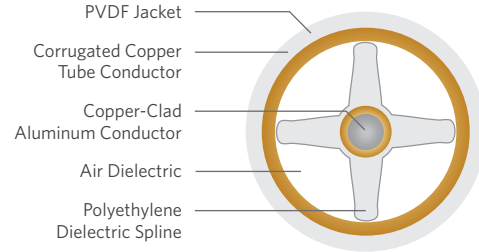

SPECIFICATIONS

Inner Conductor Material	Copper-clad aluminum
Dielectric Material	Polyethylene
Outer Conductor Material	Corrugated copper tube
Jacket Material	White, PVDF
Recommended Operating Temperature °F (°C)	-4 to +167 (-20 to +75)

PART NUMBERS AND PHYSICAL CHARACTERISTICS

Part Number	Cable Size in (mm)	Nominal Diameter in (mm)				Minimum Bend Radius in (mm)	Approx. Weight lbs/kft (kg/km)	Flat Plate Crush Resistance lbs/in (kg/mm)	Maximum Pulling Force lbs (kg)
		Inner Conductor	Dielectric	Outer Conductor	Jacket				
LHF-12DP	½ (12)	0.19 (4.8)	0.47 (12.0)	0.54 (13.8)	0.58 (14.8)	5.91 (150)	139 (207)	58 (1.05)	249 (113)

ELECTRICAL SPECIFICATIONS

Part Number	Cable Size in (mm)	Conductor DC Resistance Ohms/kft (Ohms/km)		Minimum Insulation Resistance mΩ km	Dielectric Strength for 1 minute DC Potential - Volts	Velocity of Propagation %	Peak Power Rating kW	Maximum Operating Frequency GHz	Characteristic Impedance Ohms	Typical Return Loss dB
		Inner	Outer							
LHF-12DP	½ (12)	0.50 (1.6)	0.85 (2.8)	10,000	4,000	88	40	8.8	50 ± 2	19

Frequency MHz	Nominal Attenuation* dB/100 ft (dB/100 m)	Average Power Rating at Ambient 40 °C Inner Conductor 100 °C kW
		30
100	0.65 (2.14)	2.54
150	0.80 (2.64)	2.06
450	1.43 (4.68)	1.15
824	1.97 (6.46)	0.83
890	2.05 (6.73)	0.80
960	2.14 (7.02)	0.77
1,000	2.18 (7.17)	0.75
1,700	2.92 (9.58)	0.56
1,800	3.01 (9.89)	0.54
2,000	3.19 (10.48)	0.51
2,400	3.53 (11.60)	0.46
3,000	4.07 (13.37)	0.40

Frequency MHz	VSWR
806-960	≤ 1.25
1,700-2,155	≤ 1.25

*The attenuation may rise by 0.2%/°C with rising temperature. Maximum attenuation shall not exceed 105% of nominal value. Standard Conditions: VSWR 1.0, Ambient Temperature 20°C/Attenuation is typical value. UL is a registered trademark of UL LLC.

HFSC Riser

Super Flexible Foam Dielectric Feeder

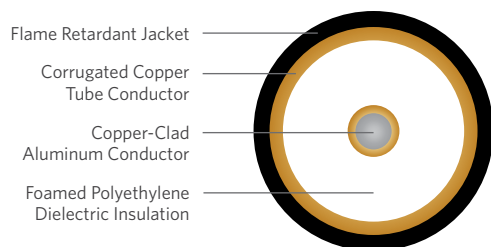

PRODUCT DESCRIPTION

HFSC-12DR is a ½ inch, 50 Ohm Riser Rated RF coaxial cable that enables mobile communications inside buildings. Installed to eliminate dead zones and spotty coverage, this cable functions as the backbone cable of in-building DAS wireless systems. With its riser (CMR) rating, this coaxial cable offers flexibility and high crush resistance in a ½ inch size. Designed for high performance, its copper clad aluminum inner conductor, foamed PE dielectric insulation, corrugated copper outer conductor and its black outer riser rated jacket exceed the requirements of all in-building DAS active systems.

APPLICATIONS

- In-building Wireless
- Distributed Antenna System (DAS)

FEATURES

- Low minimum bending radius and bending moment
- Low attenuation
- Low passive intermodulation
- Non-halogenated, fire retardant, black polyethylene jacket
- ETL Certified CMR (UL® 1666)/CATVR (UL 1581)
- Full range of easy to install connectors and an automated cable prep tool

BENEFITS

- Super flexible cable is ideally suited for installations where multiple bends are required
- Highly efficient signal transfer
- Outperforms the industry requirements for low PIM
- Rugged and durable jacket slows the spread of flame without releasing toxic smoke
- Suitable for vertical cable runs in a shaft or that penetrate more than one floor within a building
- Shortens installation time and expenses

RELATED PRODUCTS

- Connectors CHFS-12xx
- Cable prep tool T-HFSC12DR
- Jumpers JR12xxxx

SPECIFICATIONS

Inner Conductor Material	Copper-clad aluminum
Dielectric Material	Foamed polyethylene
Outer Conductor Material	Corrugated copper tube
Jacket Material	Black, flame retardant PE
Recommended Operating Temperature °F (°C)	-22 to +167 (-30 to +75)

PART NUMBERS AND PHYSICAL CHARACTERISTICS

Part Number	Cable Size in (mm)	Nominal Diameter in (mm)				Minimum Bend Radius in (mm)	Approx. Weight lbs/kft (kg/km)	Flat Plate Crush Resistance lbs/in (kg/mm)	Maximum Pulling Force lbs (kg)
		Inner Conductor	Dielectric	Outer Conductor	Jacket				
HFSC-12DR	½ (12)	0.14 (3.6)	0.35 (8.9)	0.48 (12.2)	0.55 (13.9)	1.26 (32)	137 (204)	95 (1.7)	143 (65)

ELECTRICAL SPECIFICATIONS

Part Number	Cable Size in (mm)	Conductor DC Resistance Ohms/kft (Ohms/km)		Minimum Insulation Resistance mΩ km	Dielectric Strength for 1 minute DC Potential – Volts	Velocity of Propagation %	Peak Power Rating kW	Maximum Operating Frequency GHz	Characteristic Impedance Ohms	Typical Return Loss dB
		Inner	Outer							
HFSC-12DR	½ (12)	0.87 (2.85)	1.14 (3.75)	10,000	2,500	81	15.6	10.0	50 ± 2	23

Frequency MHz	Nominal Attenuation* dB/100 ft (dB/100 m)	Average Power Rating at Ambient 40°C Inner Conductor 100°C
		kW
30	0.55 (1.80)	4.87
100	1.02 (3.33)	2.62
150	1.25 (4.10)	2.12
450	2.20 (7.29)	1.19
824	3.08 (10.10)	0.85
890	3.20 (10.50)	0.82
960	3.35 (11.00)	0.79
1,000	3.41 (11.20)	0.77
1,700	4.57 (15.00)	0.57
1,800	4.72 (15.50)	0.55
2,000	5.00 (16.40)	0.52
2,400	5.55 (18.20)	0.47
3,000	6.31 (20.70)	0.41

Frequency MHz	VSWR
806-960	≤ 1.15
1,700-2,155	≤ 1.15

*The attenuation may rise by 0.2%/°C with rising temperature. Maximum attenuation shall not exceed 105% of nominal value. Standard Conditions: VSWR 1.0, Ambient Temperature 20°C/Attenuation is typical value. UL is a registered trademark of UL LLC.

HFSC Plenum

Super Flexible Air Dielectric Feeder

PRODUCT DESCRIPTION

HFSC-12DP is a ½ inch, 50 ohm Plenum Rated RF coaxial cable that enables mobile communications inside buildings. Installed to eliminate dead zones and spotty coverage, this cable is normally installed in the plenum space on runs to ceiling antennas spaced through DAS wireless systems. With its Plenum (CMP) rating, this coaxial cable offers crush resistance in a ½ inch Super Flexible construction. Designed for high performance, its copper clad aluminum inner conductor, air dielectric center support, helically corrugated copper tube outer conductor and its white outer plenum rated jacket exceeds the RF requirements of all in-building DAS active systems.

APPLICATIONS

- In-building Wireless
- Distributed Antenna System (DAS)

FEATURES

- Low minimum bending radius and bending moment
- Low attenuation
- Low passive intermodulation
- High-quality, white PVDF jacket
- ETL Certified CMP (UL® 444)
- Full range of easy to install connectors and an automated cable prep tool

BENEFITS

- Super flexible cable is ideally suited for installations where multiple bends are required
- Highly efficient signal transfer
- Outperforms the industry requirements for low PIM
- Flame retardant and low smoke; blends with background for optimal building aesthetics
- Safe to use throughout a building including air carrying plenum space
- Shortens installation time and expenses

RELATED PRODUCTS

- Connectors CHFSP12xx
- Cable prep tool T-HFSC12DP
- Jumpers JP12xxxxx

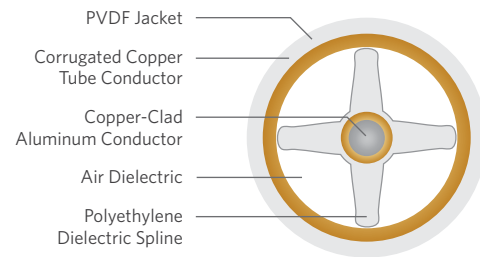

SPECIFICATIONS

Inner Conductor Material	Copper-clad aluminum
Dielectric Material	Polyethylene
Outer Conductor Material	Corrugated copper tube
Jacket Material	White, PVDF
Recommended Operating Temperature °F (°C)	-4 to +167 (-20 to +75)

PART NUMBERS AND PHYSICAL CHARACTERISTICS

Part Number	Cable Size in (mm)	Nominal Diameter in (mm)				Minimum Bend Radius in (mm)	Approx. Weight lbs/kft (kg/km)	Flat Plate Crush Resistance lbs/in (kg/mm)	Maximum Pulling Force (kg)
		Inner Conductor	Dielectric	Outer Conductor	Jacket				
HFSC-12DP	½ (12)	0.14 (3.6)	0.35 (8.9)	0.48 (12.2)	0.52 (13.2)	1.26 (32)	131 (195)	95 (1.7)	143 (65)

ELECTRICAL SPECIFICATIONS

Part Number	Cable Size in (mm)	Conductor DC Resistance Ohms/kft (Ohms/km)		Insulation Resistance mΩ km	Dielectric Strength for 1 minute DC Potential - Volts	Velocity of Propagation %	Peak Power Rating kW	Maximum Operating Frequency GHz	Characteristic Impedance Ohms	Typical Return Loss dB
		Inner	Outer							
HFSC-12DP	½ (12)	0.86 (2.85)	1.14 (3.75)	10,000	2,500	81	15.6	10.0	50 ± 2	23

Frequency MHz	Attenuation at 20 °C dB/100 ft (dB/100 m)		Average Power Rating at Ambient 40 °C Inner Conductor 100 °C kW	
	HFSC-12DP	HFSC-12DP	HFSC-12DP	HFSC-12DP
30	0.55 (1.80)		3.23	
100	1.01 (3.33)		1.73	
150	1.25 (4.10)		1.40	
450	2.22 (7.29)		0.78	
824	3.08 (10.10)		0.56	
894	3.20 (10.50)		0.54	
960	3.35 (11.00)		0.51	
1,000	3.41 (11.20)		0.50	
1,700	4.57 (15.00)		0.37	
1,800	4.72 (15.50)		0.36	
2,000	5.00 (16.40)		0.34	
2,400	5.55 (18.20)		0.30	
3,000	6.31 (20.70)		0.27	

Frequency MHz	VSWR
806-960	≤ 1.25
1,700-2,155	≤ 1.25

Standard Conditions: VSWR 1.0, Ambient Temperature 20°C/Attenuation is typical value. UL is a registered trademark of UL LLC.

HFAC Riser

Low Loss High Flexible Foam Dielectric Feeder

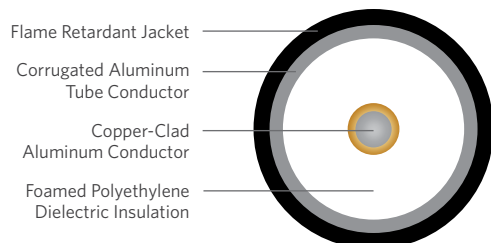

Flame Retardant Jacket
Corrugated Aluminum
Tube Conductor
Copper-Clad
Aluminum Conductor
Foamed Polyethylene
Dielectric Insulation

PRODUCT DESCRIPTION

HFAC-12DR is a ½ inch, 50 Ohm Riser Rated RF Coaxial Cable that enables mobile communications inside buildings. Installed to eliminate dead zones and spotty coverage, this cable functions as the backbone cable of in-building, DAS wireless systems. With its riser (CMR) rating, this coaxial cable offers flexibility and high crush resistance in a ½ inch size. Designed for high performance, its copper clad aluminum inner conductor, foamed PE dielectric insulation, corrugated aluminum outer conductor and its black outer riser rated jacket exceed the requirements of all in-building DAS active systems.

APPLICATIONS

- In-building Wireless
- Distributed Antenna System (DAS)

FEATURES

- Low attenuation
- Low passive intermodulation
- Non-halogenated, fire retardant, black polyethylene Jacket
- ETL Certified CMR(UL® 1666)/CATVR (UL 1581)
- Full range of easy to install connectors and an automated cable prep tool

BENEFITS

- Highly efficient signal transfer
- Outperforms the industry requirements for low PIM
- Rugged and durable jacket slows the spread of flame without releasing toxic smoke
- Suitable for vertical cable runs in a shaft or that penetrate more than one floor within a building
- Shortens installation time and expenses

SPECIFICATIONS

Inner Conductor Material	Copper-clad aluminum
Dielectric Material	Foamed polyethylene
Outer Conductor Material	Corrugated aluminum tube
Jacket Material	Black, flame retardant PE
Recommended Operating Temperature °F (°C)	-22 to +167 (-30 to +75)

PART NUMBERS AND PHYSICAL CHARACTERISTICS

Part Number	Cable Size in (mm)	Nominal Diameter in (mm)				Minimum Bend Radius in (mm)	Approx. Weight lbs/kft (kg/km)	Flat Plate Crush Resistance lbs/in (kg/mm)	Maximum Pulling Force lbs (kg)
		Inner Conductor	Dielectric	Outer Conductor	Jacket				
HFAC-12DR	½ (12)	0.19 (4.8)	0.47 (12.0)	0.54 (13.8)	0.63 (15.9)	4.92 (125)	60 (198)	84 (1.5)	174 (79)

ELECTRICAL SPECIFICATIONS

Part Number	Cable Size in (mm)	Conductor DC Resistance Ohms/kft (Ohms/km)		Minimum Insulation Resistance mΩ km	Dielectric Strength for 1 minute DC Potential - Volts	Velocity of Propagation %	Peak Power Rating kW	Maximum Operating Frequency GHz	Characteristic Impedance Ohms	Typical Return Loss dB
		Inner	Outer							
HFAC-12DR	½ (12)	0.50 (1.6)	0.67 (2.2)	10,000	4,000	88	40	8.8	50 ± 1	21

Frequency MHz	Nominal Attenuation* dB/100 ft (dB/100 m)	Average Power Rating at Ambient 40 °C Inner Conductor 100 °C kW
30	0.39 (1.29)	5.95
100	0.72 (2.37)	3.24
150	0.89 (2.92)	2.63
450	1.57 (5.14)	1.50
824	2.15 (7.06)	1.09
890	2.24 (7.35)	1.05
960	2.33 (7.65)	1.01
1,000	2.38 (7.82)	0.99
1,700	3.16 (10.38)	0.75
1,800	3.26 (10.70)	0.73
2,000	3.45 (11.33)	0.69
2,400	3.81 (12.51)	0.62
3,000	4.32 (14.17)	0.55

Frequency MHz	VSWR
806-960	≤ 1.20
1,700-2,155	≤ 1.20

*The attenuation may rise by 0.2%/°C with rising temperature. Maximum attenuation shall not exceed 110% of nominal value. Standard Conditions: VSWR 1.0, Ambient Temperature 20°C/Attenuation is typical value. UL is a registered trademark of UL LLC.

RELATED PRODUCTS

- Connectors CHFA-12xx
- Cable prep tool T-HFA12DR

HFAC Plenum

Low Loss High Flexible Air Dielectric Feeder

PRODUCT DESCRIPTION

HFAC-12DP is a ½ inch, low loss 50 Ohm Plenum Rated RF coaxial cable that is installed in the plenum space of a building as part of an in-building DAS system to eliminate dead zones and spotty coverage. Designed with a copper clad aluminum center conductor, air dielectric center structure, helically corrugated aluminum tube outer conductor, and Plenum Rated outer jacket, the HFAC-12DP is a high performing cable with low loss attenuation.

APPLICATIONS

- In-building Wireless
- Distributed Antenna System (DAS)

FEATURES

- Low attenuation
- Low passive intermodulation
- High-quality, white PVDF jacket
- ETL Certified CMP (UL® 444)
- Full range of easy to install connectors and an automated cable prep tool

BENEFITS

- Highly efficient signal transfer
- Outperforms the industry requirements for low PIM
- Flame retardant and low smoke; blends with background for optimal building aesthetics
- Safe to use throughout a building including air carrying plenum space
- Shortens installation time and expenses

RELATED PRODUCTS

- Connectors CHFAP-12xx
- Cable prep tool T-LHFA12DP

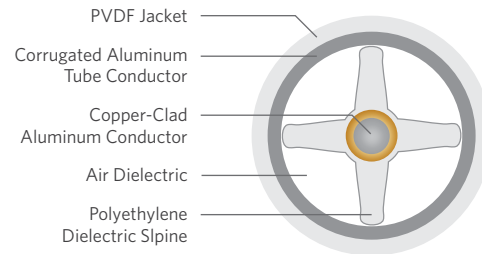

SPECIFICATIONS

Inner Conductor Material	Copper-clad aluminum
Dielectric Material	Polyethylene
Outer Conductor Material	Corrugated aluminum tube
Jacket Material	White, PVDF
Recommended Operating Temperature °F (°C)	-4 to +167 (-20 to +75)

PART NUMBERS AND PHYSICAL CHARACTERISTICS

Part Number	Cable Size in (mm)	Nominal Diameter in (mm)				Minimum Bend Radius in (mm)	Approx. Weight lbs/kft (kg/km)	Flat Plate Crush Resistance lbs/in (kg/mm)	Maximum Pulling Force lbs (kg)
		Inner Conductor	Dielectric	Outer Conductor	Jacket				
HFAC-12DP	½ (12)	0.19 (4.8)	0.47 (12.0)	0.54 (13.8)	0.58 (14.8)	5.91 (150)	111 (166)	39 (0.7)	174 (79)

ELECTRICAL SPECIFICATIONS

Part Number	Cable Size in (mm)	Conductor DC Resistance Ohms/kft (Ohms/km)		Minimum Insulation Resistance mΩ km	Dielectric Strength for 1 minute DC Potential - Volts	Velocity of Propagation %	Peak Power Rating kW	Maximum Operating Frequency GHz	Characteristic Impedance Ohms	Typical Return Loss dB
		Inner	Outer							
HFAC-12DP	½ (12)	0.50 (1.6)	0.67 (2.2)	10,000	4,000	88	40	8.8	50 ± 2	19

Frequency MHz	Nominal Attenuation* dB/100 ft (dB/100 m)	Average Power Rating at Ambient 40 °C Inner Conductor 100 °C
		kW
30	0.40 (1.32)	4.46
100	0.73 (2.41)	2.41
150	0.90 (2.97)	1.95
450	1.59 (5.22)	1.10
824	2.19 (7.19)	0.79
890	2.28 (7.49)	0.76
960	2.38 (7.81)	0.73
1,000	2.43 (7.98)	0.71
1,700	3.25 (10.66)	0.53
1,800	3.36 (11.03)	0.52
2,000	3.63 (11.90)	0.49
2,400	3.93 (12.90)	0.44
3,000	4.44 (14.57)	0.39

Frequency MHz	VSWR
806-960	≤ 1.25
1,700-2,155	≤ 1.25

*The attenuation may rise by 0.2%/°C with rising temperature.
Maximum attenuation shall not exceed 110% of nominal value.
Standard Conditions: VSWR 1.0, Ambient Temperature 20°C/Attenuation is typical value.
UL is a registered trademark of UL LLC.

DAS Riser Jumper Cable



PRODUCT DESCRIPTION

Jumper cables offer outstanding electrical performance and reliability, high durability for tight routing, and superior environmental sealing for sustained longevity.

Available in ½ inch diameters, jumper cables are used in areas that require an extremely small bending radius between main feeders and antennas or between main feeders and RF equipment.

FEATURES/BENEFITS

- High pull-off strength
- Excellent VSWR performance
- Low and stable passive intermodulation
- Weatherproof

SPECIFICATIONS

Compatible Cable Type	HFSC-12DR
Compatible Cable Size in (mm)	½ (12)
Minimum Bend Radius in (mm)	1.38 (35)
Typical VSWR	1.08 over Cellular, PCS and 3G-band
Intermodulation (PIM) dBc	< -158

PART NUMBERS AND PHYSICAL CHARACTERISTICS

Part Number	Interface Type		Standard Length ft (m)	Unit of Measure
	End 1	End 2		
JR121NMNM	N Male Straight	N Male Straight	3.2 (1)	Each
JR122NMNM	N Male Straight	N Male Straight	6.6 (2)	Each
JR123NMNM	N Male Straight	N Male Straight	9.8 (3)	Each
JR121NMNF	N Male Straight	N Female Straight	3.2 (1)	Each
JR122NMNF	N Male Straight	N Female Straight	6.6 (2)	Each
JR123NMNF	N Male Straight	N Female Straight	9.8 (3)	Each
JR121NMFN	N Female Straight	N Female Straight	3.2 (1)	Each
JR122NMFN	N Female Straight	N Female Straight	6.6 (2)	Each
JR123NMFN	N Female Straight	N Female Straight	9.8 (3)	Each
JR121NMRF	N Male Straight	N Male Right Angle	3.2 (1)	Each
JR122NMRF	N Male Straight	N Male Right Angle	6.6 (2)	Each
JR123NMRF	N Male Straight	N Male Right Angle	9.8 (3)	Each
JR121NMFN	N Male Straight	N Female Right Angle	3.2 (1)	Each
JR122NMFN	N Male Straight	N Female Right Angle	6.6 (2)	Each
JR123NMFN	N Male Straight	N Female Right Angle	9.8 (3)	Each
JR121NFRF	N Female Straight	N Female Right Angle	3.2 (1)	Each
JR122NFRF	N Female Straight	N Female Right Angle	6.6 (2)	Each
JR123NFRF	N Female Straight	N Female Right Angle	9.8 (3)	Each

EXPLANATION OF PART NUMBERS

JR122NMNM

Product Category	Fire Safety Listing	Compatible Cable Size	Jumper Length	Connector for End 1	Connector for End 2
J = Jumper Cable	R = Riser Rating P = Plenum Rating	12 = ½ inch (12 mm)	1 = 1 meter 2 = 2 meters 3 = 3 meters	NM = N Male straight RM = N Right angle Male NF = N Female RF = N Right angle Female	NM = N Male straight RM = N Right angle Male NF = N Female RF = N Right angle Female

DAS Plenum Jumper Cable

PRODUCT DESCRIPTION

Jumper cables offer outstanding electrical performance and reliability, high durability for tight routing, and superior environmental sealing for sustained longevity.

Available in ½ inch diameters, jumper cables are used in areas that require an extremely small bending radius between main feeders and antennas or between main feeders and RF equipment.

FEATURES/BENEFITS

- High pull-off strength
- Excellent VSWR performance
- Low and stable passive intermodulation
- Weatherproof



SPECIFICATIONS

Compatible Cable Type	HFSC-12DP
Compatible Cable Size in (mm)	½ (12)
Minimum Bend Radius in (mm)	1.38 (35)
Typical VSWR	1.08 over Cellular, PCS and 3G-band
Intermodulation (PIM) dBc	< -158

PART NUMBERS AND PHYSICAL CHARACTERISTICS

Part Number	Interface Type		Standard Length ft (m)	Unit of Measure
	End 1	End 2		
JP121NMNM	N Male Straight	N Male Straight	3.2 (1)	Each
JP122NMNM	N Male Straight	N Male Straight	6.6 (2)	Each
JP123NMNM	N Male Straight	N Male Straight	9.8 (3)	Each
JP121NMNF	N Male Straight	N Female Straight	3.2 (1)	Each
JP122NMNF	N Male Straight	N Female Straight	6.6 (2)	Each
JP123NMNF	N Male Straight	N Female Straight	9.8 (3)	Each
JP121NFNF	N Female Straight	N Female Straight	3.2 (1)	Each
JP122NFNF	N Female Straight	N Female Straight	6.6 (2)	Each
JP123NFNF	N Female Straight	N Female Straight	9.8 (3)	Each
JP121NMRRM	N Male Straight	N Male Right Angle	3.2 (1)	Each
JP122NMRRM	N Male Straight	N Male Right Angle	6.6 (2)	Each
JP123NMRRM	N Male Straight	N Male Right Angle	9.8 (3)	Each
JP121NMRF	N Male Straight	N Female Right Angle	3.2 (1)	Each
JP122NMRF	N Male Straight	N Female Right Angle	6.6 (2)	Each
JP123NMRF	N Male Straight	N Female Right Angle	9.8 (3)	Each
JP121NFRF	N Female Straight	N Female Right Angle	3.2 (1)	Each
JP122NFRF	N Female Straight	N Female Right Angle	6.6 (2)	Each
JP123NFRF	N Female Straight	N Female Right Angle	9.8 (3)	Each

EXPLANATION OF PART NUMBERS

JR122NMNM

Product Category	Fire Safety Listing	Compatible Cable Size	Jumper Length	Connector for End 1	Connector for End 2
J = Jumper Cable	R = Riser Rating P = Plenum Rating	12 = ½ inch (12 mm)	1 = 1 meter 2 = 2 meters 3 = 3 meters	NM = N Male straight RM = N Right angle Male NF = N Female RF = N Right angle Female	NM = N Male straight RM = N Right angle Male NF = N Female RF = N Right angle Female

DIN Series for LHF



SPECIFICATIONS

Bodies, Cap (Coupling Nut) Material	Brass/silver plated or Su Co (Alloy of Cu/Sn/Zn) plated
Back Nut Material	Brass/nickel plated
Pin Material	Male: Brass/silver plated or Su Co (Alloy of Cu/Sn/Zn) plated Female: Beryllium - copper/silver plated or Su Co (Alloy of Cu/Sn/Zn) plated
Insulator Material	Plated PTFE (Teflon®)
Gasket Material	Silicon rubber

Teflon is a registered trademark of E. I. du Pont de Nemours and Company or its affiliates.

ELECTRICAL SPECIFICATIONS

Impedance Ω	50
Maximum Frequency Range GHz	7.5
VSWR (Mating) straight (right angle)	1 GHz: 1.08 (1.12) 2 GHz: 1.10 (1.15)
Maximum Insertion Loss dB @ 3 GHz	-0.2
Intermodulation (PIM) dBc	< -155
Dielectric Withstanding Voltage kV rms @ 50 Hz	4.0
Working Voltage kV rms @ 50 Hz	2.7
Insulation Resistance GΩ	10
Contact Resistance mΩ	Inner: ≤ 1.5 Outer: ≤ 1.5

PRODUCT DESCRIPTION

This DIN Series is compatible with the LHF In-Building Series. The connectors are manufactured from an alloy material of copper, tin and zinc to produce a highly polished, precise, and strong connector. This alloy combination allows a better operating temperature range and improved environmental performance.

FEATURES/BENEFITS

- Two-piece design is the industry standard
- Simple, user-friendly installation process
- Connector can be disassembled and re-used
- Offers stable, low PIM connections

ENVIRONMENTAL SPECIFICATIONS

Temperature Range °F (°C)	-49 to +185 (-45 to +85)
Corrosion (Salt Spray Test)	IEC-68-2-11-Ka
Vibration	CECC 22000 Part 4.6.3
Waterproof	IP68

PART NUMBERS AND PHYSICAL CHARACTERISTICS

Part Number	Compatible Cable Type	Compatible Cable Size in (mm)	DIN Interface Type		Length in (mm)	Diameter in (mm)	Weight oz (g)
			Gender	Straight or Angle			
CLH-12DF	LHF Riser	½ (12)	Female	Straight	2.65 (67.4)	0.86 (21.8)	5.3 (150)
CLH-12DM	LHF Riser	½ (12)	Male	Straight	2.57 (65.4)	0.86 (21.8)	6.5 (183)
CLH-12DMR	LHF Riser	½ (12)	Male	Right Angle	-	-	-
CLHP-12DF	LHF Plenum	½ (12)	Female	Straight	2.26 (57.4)	0.86 (21.8)	5.3 (150)
CLHP-12DM	LHF Plenum	½ (12)	Male	Straight	2.18 (55.4)	0.86 (21.8)	5.3 (150)
CLHP12DMR	LHF Plenum	½ (12)	Male	Right Angle	-	-	-



TECHNICAL GUIDELINE

Installation guidelines are available for these connectors. Refer to the "Resources" section on our site for the Technical Guideline, "DIN Connectors and N Connectors Installation Guidelines," for more information.

PRODUCT DESCRIPTION

This DIN Series is compatible with the HFSC In-Building Series. The connectors are manufactured from an alloy material of copper, tin and zinc to produce a highly polished, precise, and strong connector. This alloy combination allows a better operating temperature range and improved environmental performance.

FEATURES/BENEFITS

- Two-piece design is the industry standard
- Simple, user-friendly installation process
- Ordinary tools needed; available in a common installers tool bag
- Connector can be disassembled and re-used
- Offers stable, low PIM connections



SPECIFICATIONS

Bodies, Cap (Coupling Nut) Material	Brass/silver plated or Su Co (Alloy of Cu/Sn/Zn) plated
Back Nut Material	Brass/nickel plated
Pin Material	Male: Brass/silver plated or Su Co (Alloy of Cu/Sn/Zn) plated Female: Beryllium - copper/silver plated or Su Co (Alloy of Cu/Sn/Zn) plated
Insulator Material	Plated PTFE (Teflon®)
Gasket Material	Silicon rubber

Teflon is a registered trademark of E. I. du Pont de Nemours and Company or its affiliates.

ELECTRICAL SPECIFICATIONS

Impedance Ω	50
Maximum Frequency Range GHz	7.5
VSWR (Mating) straight (right angle)	1 GHz: 1.08 (1.12) 2 GHz: 1.10 (1.15)
Maximum Insertion Loss dB @ 3 GHz	-0.2
Intermodulation (PIM) dBc	< -155
Dielectric Withstanding Voltage kV rms @ 50 Hz	4.0
Working Voltage kV rms @ 50 Hz	2.7
Insulation Resistance GΩ	10
Contact Resistance mΩ	Inner: 0.4 Outer: 1.5

ENVIRONMENTAL SPECIFICATIONS

Temperature Range °F (°C)	-49 to +185 (-45 to +85)
Corrosion (Salt Spray Test)	IEC-68-2-11-Ka
Vibration	CECC 22000 Part 4.6.3
Waterproof	IP68

PART NUMBERS AND PHYSICAL CHARACTERISTICS

Part Number	Compatible Cable Type	Compatible Cable Size in (mm)	DIN Interface Type		Length in (mm)	Diameter in (mm)	Weight oz (g)
			Gender	Straight or Angle			
CHFS-12DF	HFSC Riser	½ (12)	Female	Straight	2.65 (67.4)	0.86 (21.8)	5.3 (150)
CHFS-12DM	HFSC Riser	½ (12)	Male	Straight	2.57 (65.4)	0.86 (21.8)	6.5 (183)
CHFS12DMR	HFSC Riser	½ (12)	Male	Right Angle	-	-	-
CHFSP12DF	HFSC Plenum	½ (12)	Female	Straight	2.21 (56.2)	0.92 (23.4)	5.3 (150)
CHFSP12DM	HFSC Plenum	½ (12)	Male	Straight	2.25 (57.3)	0.92 (23.4)	6.5 (183)
CHFSP12DMR	HFSC Plenum	½ (12)	Male	Right Angle	-	-	-



TECHNICAL GUIDELINE

Installation guidelines are available for these connectors. Refer to the "Resources" section on our site for the Technical Guideline, "DIN Connectors and N Connectors Installation Guidelines," for more information.

DIN Series for HFAC



SPECIFICATIONS

Bodies, Cap (Coupling Nut) Material	Brass/silver plated or Su Co (Alloy of Cu/Sn/Zn) plated
Back Nut Material	Brass/nickel plated
Pin Material	Male: Brass/silver plated or Su Co (Alloy of Cu/Sn/Zn) plated Female: Beryllium - copper/silver plated or Su Co (Alloy of Cu/Sn/Zn) plated
Insulator Material	Plated PTFE (Teflon®)
Gasket Material	Silicon rubber

Teflon is a registered trademark of E. I. du Pont de Nemours and Company or its affiliates.

ELECTRICAL SPECIFICATIONS

Impedance Ω	50
Maximum Frequency Range GHz	7.5
VSWR (Mating) straight (right angle)	1 GHz: 1.08 (1.12) 2 GHz: 1.10 (1.15)
Maximum Insertion Loss dB @ 3 GHz	-0.2
Intermodulation (PIM) dBc	< -155
Dielectric Withstanding Voltage kV rms @ 50 Hz	4.0
Working Voltage kV rms @ 50 Hz	2.7
Insulation Resistance GΩ	10
Contact Resistance mΩ	Inner: 0.4 Outer: 1.5

PRODUCT DESCRIPTION

This DIN Series is compatible with the HFAC In-Building Series. The connectors are manufactured from an alloy material of copper, tin and zinc to produce a highly polished, precise, and strong connector. This alloy combination allows a better operating temperature range and improved environmental performance.

FEATURES/BENEFITS

- Two-piece design is the industry standard
- Simple, user-friendly installation process
- Ordinary tools needed; available in a common installers tool bag
- Connector can be disassembled and re-used
- Offers stable, low PIM connections

ENVIRONMENTAL SPECIFICATIONS

Temperature Range °F (°C)	-49 to +185 (-45 to +85)
Corrosion (Salt Spray Test)	IEC-68-2-11-Ka
Vibration	CECC 22000 Part 4.6.3
Waterproof	IP68

PART NUMBERS AND PHYSICAL CHARACTERISTICS

Part Number	Compatible Cable Type	Compatible Cable Size in (mm)	DIN Interface Type		Length in (mm)	Diameter in (mm)	Weight oz (g)
			Gender	Straight or Angle			
CHFA-12DF	HFAC Riser	½ (12)	Female	Straight	2.65 (67.4)	0.86 (21.8)	5.3 (150)
CHFA-12DM	HFAC Riser	½ (12)	Male	Straight	2.57 (65.4)	0.86 (21.8)	6.5 (183)
CHFA12DMR	HFAC Riser	½ (12)	Male	Right Angle	-	-	-
CHFAP12DF	HFAC Plenum	½ (12)	Female	Straight	2.26 (57.4)	0.86 (21.8)	5.3 (150)
CHFAP12DM	HFAC Plenum	½ (12)	Male	Straight	2.18 (55.4)	0.86 (21.8)	5.3 (150)
CHFAP12DMR	HFAC Plenum	½ (12)	Male	Right Angle	-	-	-



TECHNICAL GUIDELINE

Installation guidelines are available for these connectors. Refer to the "Resources" section on our site for the Technical Guideline, "DIN Connectors and N Connectors Installation Guidelines," for more information.

PRODUCT DESCRIPTION

This N Series connector is compatible with the LHF Series In-building Cable. The connectors are manufactured from an alloy material of copper, tin and zinc to produce a highly polished, strong connector. This alloy combination allows for a better operating temperature range and improved environmental performance.

FEATURES/BENEFITS

- Two-piece design is the industry standard
- Simple user friendly installation process
- Connector can be disassembled and re-used
- Offers stable, low PIM connections

ELECTRICAL SPECIFICATIONS

Impedance Ω	50
Maximum Frequency Range GHz	7.5
VSWR @ 700-2,200 MHz straight (right angle)	1.08 (1.15)
Maximum Insertion Loss dB @ 700-2,200 MHz straight (right angle)	0.1 (0.15)
Intermodulation (PIM) dBc	-155
Dielectric Withstanding Voltage kV rms @ 50 Hz	4.0
Working Voltage kV rms @ 50 Hz	2.7
Peak Power kW	10
Insulation Resistance MΩ	≥ 5,000
Contact Resistance mΩ	Inner: ≤ 1.0 Outer: ≤ 1.0

ENVIRONMENTAL SPECIFICATIONS

Temperature Range °F (°C)	-40 to +185 (-40 to +85)
Corrosion (Salt Spray Test)	IEC-68-2-11-Ka
Vibration	CECC 22000 Part 4.6.3
Waterproof	IP68



SPECIFICATIONS

Bodies, Cap (Coupling Nut) Material	Brass/silver plated or Su Co (Alloy of Cu/Sn/Zn) plated
Back Nut Material	Brass/nickel plated
Pin Material	Male: Brass/silver plated or Su Co (Alloy of Cu/Sn/Zn) plated Female: Beryllium - copper/silver plated or Su Co (Alloy of Cu/Sn/Zn) plated
Insulator Material	Plated PTFE (Teflon®)
Gasket Material	Silicon rubber
Recommended Coupling Nut Torque Nm	0.68-1.13
Coupling Nut Retention Force Nm	1,000
Contact Captivation N	200
Mating Durability	500 times

Teflon is a registered trademark of E. I. du Pont de Nemours and Company or its affiliates.

PART NUMBERS AND PHYSICAL CHARACTERISTICS

Part Number	Compatible Cable Type	Compatible Cable Size in (mm)	N Interface Type		Length in (mm)	Diameter in (mm)	Weight oz (g)
			Gender	Straight or Angle			
CLH-12NF	LHF Riser	½ (12)	Female	Straight	2.75 (69.8)	0.86 (21.8)	4.1 (115)
CLH-12NFR	LHF Riser	½ (12)	Female	Right Angle	-	-	-
CLH-12NM	LHF Riser	½ (12)	Male	Straight	2.75 (69.8)	0.86 (21.8)	4.2 (120)
CLH-12NMR	LHF Riser	½ (12)	Male	Right Angle	-	-	-
CLHP-12NF	LHF Plenum	½ (12)	Female	Straight	2.75 (69.8)	0.86 (21.8)	4.1 (115)
CLHP12NFR	LHF Plenum	½ (12)	Female	Right Angle	-	-	-
CLHP12NM	LHF Plenum	½ (12)	Male	Straight	2.75 (69.8)	0.86 (21.8)	4.2 (120)
CLHP12NMR	LHF Plenum	½ (12)	Male	Right Angle	-	-	-



TECHNICAL GUIDELINE

Installation guidelines are available for these connectors. Refer to the "Resources" section on our site for an instructional video or the Technical Guideline, "DIN Connectors and N Connectors Installation Guidelines," for more information.

N Series for HFSC



PRODUCT DESCRIPTION

This N Series connector is compatible with the HFSC Series In-building Cable. The connectors are manufactured from an alloy material of copper, tin and zinc to produce a highly polished, strong connector. This alloy combination allows for a better operating temperature range and improved environmental performance.

FEATURES/BENEFITS

- Two-piece design is the industry standard
- Simple user-friendly installation process
- Connector can be disassembled and re-used
- Offers stable, low PIM connections

ELECTRICAL SPECIFICATIONS

Impedance Ω	50
Maximum Frequency Range GHz	7.5
VSWR @ 700–2,200 MHz straight (right angle)	1.08 (1.10)
Maximum Insertion Loss dB @ @ 700–2,200 MHz straight (right angle)	0.1 (0.15)
Intermodulation (PIM) dBc	-155
Dielectric Withstanding Voltage kV rms @ 50 Hz	4.0
Working Voltage kV rms @ 50 Hz	2.7
Peak Power kW	10
Insulation Resistance M Ω	$\geq 5,000$
Contact Resistance m Ω	Inner: 1.0 Outer: 1.0

ENVIRONMENTAL SPECIFICATIONS

Temperature Range °F (°C)	-40 to +185 (-40 to +85)
Corrosion (Salt Spray Test)	IEC-68-2-11-Ka
Vibration	CECC 22000 Part 4.6.3
Waterproof	IP68

SPECIFICATIONS

Bodies, Cap (Coupling Nut) Material	Brass/silver plated or Su Co (Alloy of Cu/Sn/Zn) plated
Back Nut Material	Brass/nickel plated
Pin Material	Male: Brass/silver plated or Su Co (Alloy of Cu/Sn/Zn) plated Female: Beryllium - copper/silver plated or Su Co (Alloy of Cu/Sn/Zn) plated
Insulator Material	Plated PTFE (Teflon®)
Gasket Material	Silicon rubber
Recommended Coupling Nut Torque Nm	25–30
Coupling Nut Retention Force Nm	1,000
Contact Captivation N	200
Mating Durability	500 times

Teflon is a registered trademark of E. I. du Pont de Nemours and Company or its affiliates.

PART NUMBERS AND PHYSICAL CHARACTERISTICS

Part Number	Compatible Cable Type	Compatible Cable Size in (mm)	N Interface Type		Length in (mm)	Diameter in (mm)	Weight oz (g)
			Gender	Straight or Angle			
CHFS-12NF	HFSC Riser	½ (12)	Female	Straight	2.75 (69.8)	0.86 (21.8)	4.1 (115)
CHFS12NFR	HFSC Riser	½ (12)	Female	Right Angle	-	-	-
CHFS-12NM	HFSC Riser	½ (12)	Male	Straight	2.75 (69.8)	0.86 (21.8)	4.2 (120)
CHFS12NMR	HFSC Riser	½ (12)	Male	Right Angle	-	-	-
CHFSP12NF	HFSC Plenum	½ (12)	Female	Straight	2.75 (69.8)	0.86 (21.8)	4.1 (115)
CHFSP12NFR	HFSC Plenum	½ (12)	Female	Right Angle	-	-	-
CHFSP12NM	HFSC Plenum	½ (12)	Male	Straight	2.75 (69.8)	0.86 (21.8)	4.2 (120)
CHFSP12NMR	HFSC Plenum	½ (12)	Male	Right Angle	-	-	-



TECHNICAL GUIDELINE

Installation guidelines are available for these connectors. Refer to the "Resources" section on our site for an instructional video or the Technical Guideline, "DIN Connectors and N Connectors Installation Guidelines," for more information.

N Series for HFAC

PRODUCT DESCRIPTION

This N Series connector is compatible with the HFAC Series In-building Cable. The connectors are manufactured from an alloy material of copper, tin and zinc to produce a highly polished, strong connector. This alloy combination allows for a better operating temperature range and improved environmental performance.

FEATURES/BENEFITS

- Two-piece design is the industry standard
- Simple user-friendly installation process
- Connector can be disassembled and re-used
- Offers stable, low PIM connections

ELECTRICAL SPECIFICATIONS

Impedance Ω	50
Maximum Frequency Range GHz	7.5
VSWR @ 700-2,200 MHz straight (right angle)	1.08 (1.10)
Maximum Insertion Loss dB @ 700-2,200 MHz straight (right angle)	0.1 (0.15)
Intermodulation (PIM) dBc	-155
Dielectric Withstanding Voltage kV rms @ 50 Hz	4.0
Working Voltage kV rms @ 50 Hz	2.7
Peak Power kW	10
Insulation Resistance GΩ	≥ 5,000
Contact Resistance mΩ	Inner: ≤ 1.0 Outer: ≤ 1.0

ENVIRONMENTAL SPECIFICATIONS

Temperature Range °F (°C)	-40 to +185 (-40 to +85)
Corrosion (Salt Spray Test)	IEC-68-2-11-Ka
Vibration	CECC 22000 Part 4.6.3
Waterproof	IP68



SPECIFICATIONS

Bodies, Cap (Coupling Nut) Material	Brass/silver plated or Su Co (Alloy of Cu/Sn/Zn) plated
Back Nut Material	Brass/nickel plated
Pin Material	Male: Brass/silver plated or Su Co (Alloy of Cu/Sn/Zn) plated Female: Beryllium - copper/silver plated or Su Co (Alloy of Cu/Sn/Zn) plated
Insulator Material	Plated PTFE (Teflon®)
Gasket Material	Silicon rubber
Recommended Coupling Nut Torque Nm	0.68-1.13
Coupling Nut Retention Force Nm	1,000
Contact Captivation N	200
Mating Durability	500 times

Teflon is a registered trademark of E. I. du Pont de Nemours and Company or its affiliates.

PART NUMBERS AND PHYSICAL CHARACTERISTICS

Part Number	Compatible Cable Type	Compatible Cable Size in (mm)	N Interface Type		Length in (mm)	Diameter in (mm)	Weight oz (g)
			Gender	Straight or Angle			
CHFA-12NF	HFAC Riser	½ (12)	Female	Straight	2.75 (69.8)	0.86 (21.8)	4.1 (115)
CHFA12NFR	HFAC Riser	½ (12)	Female	Right Angle	-	-	-
CHFA-12NM	HFAC Riser	½ (12)	Male	Straight	2.75 (69.8)	0.86 (21.8)	4.2 (120)
CHFA12NMR	HFAC Riser	½ (12)	Male	Right Angle	-	-	-
CHFAP12NF	HFAC Plenum	½ (12)	Female	Straight	2.75 (69.8)	0.86 (21.8)	4.1 (115)
CHFAP12NFR	HFAC Plenum	½ (12)	Female	Right Angle	-	-	-
CHFAP12NM	HFAC Plenum	½ (12)	Male	Straight	2.75 (69.8)	0.86 (21.8)	4.2 (120)
CHAP12NMR	HFAC Plenum	½ (12)	Male	Right Angle	-	-	-



TECHNICAL GUIDELINE

Installation guidelines are available for these connectors. Refer to the "Resources" section on our site for an instructional video or the Technical Guideline, "DIN Connectors and N Connectors Installation Guidelines," for more information.

Cable Preparation Tools



Manual Cutting Tools



Automated Cutting Tool

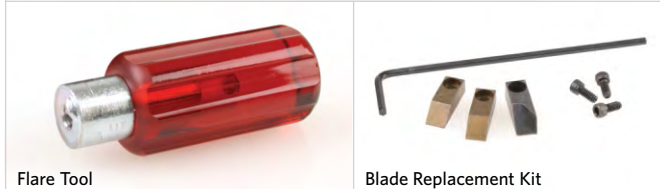

Flare Tool

Blade Replacement Kit

PRODUCT DESCRIPTION

Connector termination is one of the most important factors affecting Radio Frequency (RF) transmission line operation. Cable cutting tools are offered in sizes ranging from ½ to 1½ inches (12 to 42 mm). These precision tools are designed to cut the jacket and outer conductor quickly and easily.

Cutting tools make accurate cuts in the cable at exact distance requirements for easy connector assembly. The automated cable cutting tools fit standard cordless 18V drills. Blade replacement kits are available to extend the useful life of the automated cutting tools.

The foam separator and flare tool removes foam dielectric from riser cable and flares the top of the outer conductor over top of riser and plenum connectors.

FEATURES/BENEFITS

- Accurate termination
- Easy handling

CUTTING TOOLS

Part Number	Tool Type	Capability	Compatible Cable Size in (mm)	Compatible Cable Type	Unit of Measure
L-CT-12D	Manual	Cuts jacket and outer conductor	½ (12)	LHF Feeder, HFAC Feeder	Each
L-CT-12DS	Manual	Cuts inner/outer jackets	½ (12)	HFSC Feeder	Each
L-CT-22D	Manual	Cuts jacket, inner/outer conductors and dielectric	7/8 (22)	LHF Feeder	Each
T-LHFA12DP	Automated	Cuts jacket, outer conductor and dielectric	½ (12)	LHF-12DP, HFAC-12DP	Each
T-HFSC12DP	Automated	Cuts jacket, outer conductor and dielectric	½ (12)	HFSC-12DP	Each
T-LHF12DR	Automated	Cuts jacket, outer conductor and dielectric	½ (12)	LHF-12DR	Each
T-HFAC12DR	Automated	Cuts jacket, outer conductor and dielectric	½ (12)	HFAC-12DR	Each
T-HFSC12DR	Automated	Cuts jacket, outer conductor and dielectric	½ (12)	HFSC-12DR	Each

FLARE TOOLS

Part Number	Description	Compatible Cable Size in (mm)	Compatible Cable Type	Unit of Measure
TF-LHFA12	Foam separator and flare tool	½ (12)	LHF-12DP, LHF-12DR, HFAC-12DP, HFAC-12DR	Each
TF-HFSC12	Foam separator and flare tool	½ (12)	HFSC-12DP, HFSC-12DR	Each
L-FT-42D	T-handle flare tool	1½ (42)	LHF-42D, LHF-42DU, LHF-42DUF	Each

BLADE REPLACEMENT KITS

Part Number	Description	Compatible Tools	Each Kit Includes	Unit of Measure
TBK-HFSC12	Blade replacement kit for HFSC automated tools	T-HFSC12DP, T-HFSC12DR	<ul style="list-style-type: none"> • Three (3) replacement blades • Three (3) set screws • One (1) Allen wrench 	Kit
TBK-LHFA12	Blade replacement kit for LHF and HFAC automated tools	T-LHFA12DP, T-LHF12DR, T-HFAC12DR	<ul style="list-style-type: none"> • Four (4) replacement blades • Four (4) set screws • One (1) Allen wrench 	Kit

Cushion and Boot Assembly Kit

PRODUCT DESCRIPTION

These innovative boot assembly kits feature a boot assembly and standard cushion insert in one convenient package. The unique boot assembly features a split, one-piece design that dramatically reduces installation time and difficulty. Boot assembly kits are designed to be fitted onto EP-series entry panels in wall/roof feed-thru applications.

APPLICATION

- Entry solutions

FEATURES/BENEFITS

- One-piece design simplifies installation



SPECIFICATIONS

Size	Versions for coax
Design	Compression boot kit for aluminum entry panels
Mounts to	4 inch (102 mm) entry panels
Material	EPDM rubber
Each Kit Includes	<ul style="list-style-type: none"> One (1), 4 inch (101.6 mm) pre-molded grooved boot One (1) cushion insert with appropriately sized hole(s) for corrugated coax or flexible coax One (1), #80 round member hose clamp One (1), #64 round member hose clamp One (1) installation instruction sheet
Not Included (Order Separately)	4 inch (102 mm) entry panel

PART NUMBERS AND PHYSICAL CHARACTERISTICS

Part Number	Compatible Cable Size in (mm)	Compatible Cable Type	Number of Holes	Weight lbs (kg)	Unit of Measure
LBA-12-1A	½ (12)	Corrugated Coax	1	1.6 (0.7)	Kit
LBA-12-2A	½ (12)	Corrugated Coax	2	1.6 (0.7)	Kit
LBA-12-3A	½ (12)	Corrugated Coax	3	1.6 (0.7)	Kit
LBA-12-4A	½ (12)	Corrugated Coax	4	1.6 (0.7)	Kit
LBA-12-5A	½ (12)	Corrugated Coax	5	1.6 (0.7)	Kit
LBA-22-1A	⅞ (22)	Corrugated Coax	1	1.6 (0.7)	Kit
LBA-22-2A	⅞ (22)	Corrugated Coax	2	1.6 (0.7)	Kit
LBA-22-3A	⅞ (22)	Corrugated Coax	3	1.6 (0.7)	Kit
LBA-22-4A	⅞ (22)	Corrugated Coax	4	1.6 (0.7)	Kit
LBA-33-1A	1¼ (33)	Corrugated Coax	1	1.6 (0.7)	Kit
LBA-42-1A	1⅝ (42)	Corrugated Coax	1	1.6 (0.7)	Kit
LBA-57-1A	2¼ (57)	Corrugated Coax	1	1.6 (0.7)	Kit

Universal Weatherproofing Kit



PRODUCT DESCRIPTION

Universal weatherproofing kits include mastic and electrical tapes to provide a multi-layer, long-term environmental seal over multiple connections.

APPLICATION

- Coax protection

FEATURES/BENEFITS

- Multi-connection protection
- Tape kit for multi-layer wrap

SPECIFICATIONS

Material	Butyl and vinyl tape
Each Kit Includes	<ul style="list-style-type: none"> ▪ Five (5) rolls of butyl mastic tape 3.75 inches x 2 feet (95 mm x 0.6 m) ▪ Two (2) rolls of electrical tape 0.75 inch x 44 feet (19 mm x 13 m) ▪ One (1) roll of electrical tape 2 inch x 20 feet (51 mm x 6 m) ▪ One (1) installation instruction sheet

PART NUMBERS AND PHYSICAL CHARACTERISTICS

Part Number	Weight lbs (kg)	Unit of Measure
L-WK-U	3.4 (1.5)	Kit

PRODUCT DESCRIPTION

Hoisting grips provide an effective means for hoisting coax and elliptical waveguide into position. Grips can be used to provide additional support once in place. The lace-up design allows the hoisting grip to be attached even when the run has been connectorized, and it facilitates easy positioning at 200 feet (61 m) increments on long coax runs.

Pre-laced hoisting grips feature a closed-mesh design which simplifies installation over traditional split, lace-up style grips. The unique design allows the pre-laced hoisting grip to slip over an unterminated end of a coax cable. The grip securely tightens when pulled, providing an effective means to hoist coax into position, while providing additional support for the coax once in place.

Hoisting grip kits include a self-locking clip and sealing tape, giving additional support both during and after installation.

APPLICATION

- Coax
- Coax support

FEATURES/BENEFITS

- Lace-up installation at any point on coax
- Pre-laced to simplify installation
- Mesh grip with single eye support



SPECIFICATIONS

Compatible Cable Type	Corrugated coax
Compatible Cable Size in (mm)	Fits ½ (12) to 1½ (42) corrugated coax
Material	Tinned bronze
Each Includes	<ul style="list-style-type: none"> • One (1) mesh grip • One (1) self-locking clip • Installation instructions

PART NUMBERS AND PHYSICAL CHARACTERISTICS

Part Number	Hoisting Grip Model	Compatible Cable Size in (mm)	Weight lbs (kg)	Unit of Measure
L-HG-12	Lace-Up	½ (12)	0.3 (0.1)	Each
L-HG-22	Lace-Up	⅞ (22)	0.6 (0.3)	Each
L-HG-33	Lace-Up	1¼ (33)	0.6 (0.3)	Each
L-HG-42	Lace-Up	1⅝ (42)	1.3 (0.6)	Each
L-HG-12L	Pre-Laced	½ (12)	0.4 (0.2)	Each
L-HG-22L	Pre-Laced	⅞ (22)	0.5 (0.2)	Each
L-HG-33L	Pre-Laced	1¼ (33)	0.5 (0.2)	Each
L-HG-42L	Pre-Laced	1⅝ (42)	0.5 (0.2)	Each

Clip-On Grounding Kit



SPECIFICATIONS

Compatible Cable Type	Corrugated coax
Compatible Cable Size in (mm)	Fits ½ (12) to 1¾ (42)
Mounts to	Coax outer conductor
Material	Copper strap
Each Kit Includes	<ul style="list-style-type: none"> • One (1) 6 AWG, 7-strand copper ground lead measuring 4.92 feet (1.5 m) long • One (1) roll of electrical tape 2 inch x 20 feet (51 mm x 6 m) • One (1) roll of butyl mastic tape 3.75 inch x 2 feet (95 mm x 0.6 m) • Necessary hardware for ground bar attachment • One (1) 2-hole universal lug compatible with ½ inch (12 mm) coax

PRODUCT DESCRIPTION

Clip-on ground kits, as part of an advanced coax grounding solution, provide easy installation coupled with dependable protection of your coaxial cable system. The unique clip design and pre-formed strap allows the clip-on ground kits to slip easily over the outer conductor of the coax and firmly latch into place. The latch mechanism has been optimized to provide a secure fit, maximizing performance by ensuring proper contact surface area and pressure. The innovative design of the clip-on ground kits greatly simplifies installation, and minimizes installation time over traditional coiled and bolt-on grounding kits. This design also eliminates the danger of over tightening, which reduces the chance of costly errors in the field. The clip-on ground kits comply with MIL-STD-188-124A, protecting coax from the damaging effects of lightning current in excess of 200 kA. Each kit includes a 6 AWG 7-strand copper ground lead. All bus bar attachment hardware is included along with required mastic and electric tape for weatherproofing each kit.

APPLICATION

- Coax protection

FEATURES/BENEFITS

- Easy-to-install clip design
- One-piece style with three lead/lug options

PART NUMBERS AND PHYSICAL CHARACTERISTICS

Part Number	Compatible Cable Size in (mm)	Weight lbs (kg)	Unit of Measure
L-GK-C12	½ (12)	1.4 (0.6)	Kit
L-GK-C22	⅞ (22)	1.4 (0.6)	Kit
L-GK-C33	1¼ (33)	1.4 (0.6)	Kit
L-GK-C42	1¾ (42)	1.5 (0.7)	Kit

*Note: 0.375 inch (10 mm) two-hole lugs are universal to accommodate 0.75 inch to 1 inch (19 mm to 25 mm) spacing requirements. Versions of these kits are available with 0.25 inch (6 mm) two-hole lugs or with your choice of lug pre-attached.

Universal Snap-in Hanger Kit

PRODUCT DESCRIPTION

The next-generation Universal Snap-in Hangers incorporate numerous innovative design features that ensure secure, dependable support and simplified installation for your coaxial cable system. The unique internal coax fingers securely grip the coax, yet float freely within the hanger to ensure flexibility during installation. The tension and thickness of steel has been optimized to minimize stiffness and allow easy insertion into a 3/4 inch (19 mm) mounting hole. The advanced snap-in fingers are specifically designed to eliminate inadvertent pop-out. The unique curved finger-tips provide a powerful barrier to pop-out and offer additional security when faced with excessive galvanizing or rounded edges. The Universal Snap-in Hangers internal ribbing and dog-eared internal fingers provide a firm grip to resist coax slippage. The stainless steel construction guarantees exceptional integrity in highly corrosive environments and extreme weather conditions.

APPLICATION

- Coax support

FEATURES

- One-piece hanger solution

BENEFITS

- Simplified coax installation



SPECIFICATIONS

Compatible Cable Type	Corrugated coax
Compatible Cable Size in (mm)	½ (12) to 2¼ (58)
Mounts to in (mm)	¾ (19) holes
Material	Stainless steel
Each Kit Includes	<ul style="list-style-type: none"> 10 appropriately sized snap-in hangers One (1) installation instruction sheet
Not Included (Order Separately)	Brackets

PART NUMBERS AND PHYSICAL CHARACTERISTICS

Part Number	Compatible Cable Size in (mm)	Weight lbs (kg)	Unit of Measure
L-SH-U12	½ (12)	0.7 (0.3)	Kit
L-SH-U22	¾ (22)	1.2 (0.5)	Kit
L-SH-U33	1¼ (33)	1.3 (0.6)	Kit
L-SH-U42	1¾ (42)	1.5 (0.7)	Kit

Stackable Snap-in Hanger Kit

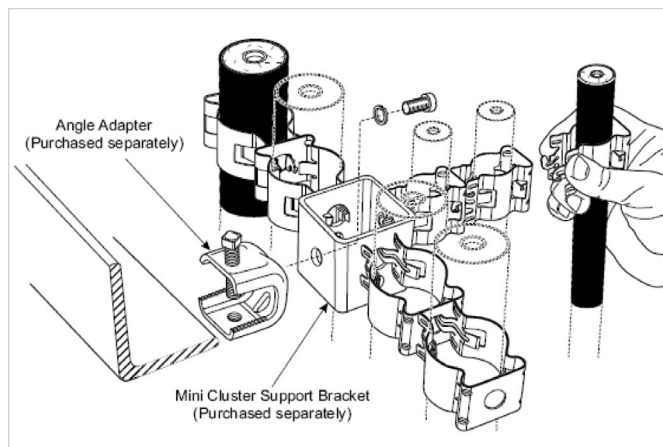

PRODUCT DESCRIPTION

The self contained design of the Stackable Snap-in Hanger eliminates the need for mounting hardware, while also providing a compact solution for supporting coaxial cable. The hanger can be stacked up to three runs high when using $\frac{3}{8}$ " , $\frac{1}{2}$ " and $\frac{7}{8}$ " coaxial cable, or two runs high when using $1\frac{1}{4}$ " and $1\frac{1}{2}$ " coaxial cable.

Each hanger accommodates one run of coaxial cable. The advanced design of the retention tabs gives the hanger the ability to absorb vibration, making the hanger resistant to pop-out. This unique design also reduces movement in the runs of coaxial cable, therefore reducing stress on the connections. Manufactured from stainless steel, this product ensures long term integrity in extreme environments including mountain tops, coastal and industrial applications.

APPLICATION

- Coax support

FEATURES

- One-piece hanger solution

BENEFITS

- Eliminates the need for mounting hardware for a simplified coax installation

SPECIFICATIONS

Compatible Cable Type	Corrugated coax
Compatible Cable Size in (mm)	$\frac{3}{8}$ (9.5) to $1\frac{1}{2}$ (42)
Material	Stainless steel
Each Kit Includes	<ul style="list-style-type: none"> 10 appropriately sized stackable snap-in hangers One (1) installation instruction sheet
Not Included (Order Separately)	Brackets

PART NUMBERS AND PHYSICAL CHARACTERISTICS

Part Number	Compatible Cable Size in (mm)	Stack Height	Weight lbs (kg)	Unit of Measure
SSHAK3812*	$\frac{3}{8}$ (9.5)	3 Runs	3.1 (1.4)	Kit
L-SH-S12	$\frac{1}{2}$ (12)	3 Runs	0.7 (0.3)	Kit
L-SH-S22	$\frac{7}{8}$ (22)	3 Runs	1.2 (0.5)	Kit
L-SH-S33	$1\frac{1}{4}$ (33)	2 Runs	1.3 (0.6)	Kit
L-SH-S42	$1\frac{1}{2}$ (42)	2 Runs	1.5 (0.7)	Kit

*Includes grommet.

Standard Hanger Kit

PRODUCT DESCRIPTION

The Standard Hangers provide a dependable solution for supporting single runs of coaxial cable in wireless systems. The pre-formed design greatly simplifies installation, allowing the coax to be quickly slipped into the Standard Hanger and then secured using the included captivated bolt. Corrosion-resistant stainless steel construction ensures long term integrity in extreme weather applications. Integrated cable grippers bite into the coax jacketing, to provide additional support in heavy wind and ice-loading conditions.

APPLICATION

- Coax support

FEATURES

- Pre-formed bolt-on single run hanger

BENEFITS

- Reduces installation time



SPECIFICATIONS

Compatible Cable Type	Corrugated coax
Compatible Cable Size in (mm)	Fits ½ (12) to 1½ (42)
Mounts to in (mm)	¾ (9.5) hardware
Material	Stainless steel
Each Kit Includes	<ul style="list-style-type: none"> 10 appropriately sized stainless steel hangers without hardware 10 captive ¼ inch (6.4 mm) slotted hex head bolts One (1) installation instruction sheet
Not Included (Order Separately)	Brackets

PART NUMBERS AND PHYSICAL CHARACTERISTICS

Part Number	Compatible Cable Size in (mm)	Weight lbs (kg)	Unit of Measure
LBHS12NH	½ (12)	0.8 (0.4)	Kit
LBHS22NH	¾ (22)	1.1 (0.5)	Kit
LBHS33NH	1¼ (33)	1.3 (0.6)	Kit
LBHS42NH	1½ (42)	1.8 (0.8)	Kit

$\lambda/4$ Wave Surge Arrestor



PRODUCT DESCRIPTION

Surge arrestors provide excellent lightning protection and outstanding RF performance. All designs have low return loss, low insertion loss and low intermodulation.

FEATURES/BENEFITS

- Outstanding RF performance
- Completely weatherproof
- Available with Type N or DIN interface
- Maintenance-free operation ($\lambda/4$ wave shorting stubs)

SPECIFICATIONS

Outer Conductor Material	Brass/silver or Su Co plated
Inner Conductor Material	Be Cu (Female)/silver or Su Co plated
Other Metal Parts Materials	Brass/nickel plated
Temperature Range °C	-40 to +100
Moisture Resistance	Waterproof
Frequency Band MHz	700-2,700

ELECTRICAL SPECIFICATIONS

Impedance (Nominal) Ω	50
VSWR	< 1.1
Insertion Loss dB	< 0.1
Intermodulation (PIM) dBc	-155
Max. Impulse Spark-Over Voltage	> 600

PART NUMBERS AND PHYSICAL CHARACTERISTICS

Part Number	Surge Arrestor Model	Frequency Band MHz	Interface Type	Unit of Measure
ATNMNF700	$\lambda/4$ wave	700-2,700	N Male/N Female	Each
ATDMDF700	$\lambda/4$ wave	700-2,700	DIN Male/DIN Female	Each
AT-NMNF-W	$\lambda/4$ wave	800-2,700	N Male/N Female	Each
AT-DMDF-W	$\lambda/4$ wave	800-2,700	DIN Male/DIN Female	Each

Gas Tube Surge Arrestor

PRODUCT DESCRIPTION

A surge arrester is a gas discharge tube type for lightning strike protection, used most widely with $\lambda/4$ stub type systems. The surge arrester allows for replaceable gas discharge tubes between the internal and outer conductor. When activated, this unit discharges electron pulse energy instantaneously.

FEATURES/BENEFITS

- Outstanding Broadband RF performance (up to 2,700 MHz)
- DC pass capability
- High tensional internal conductor structure
- Waterproof
- Available with 0.4375 in (11.1 mm) DIN type

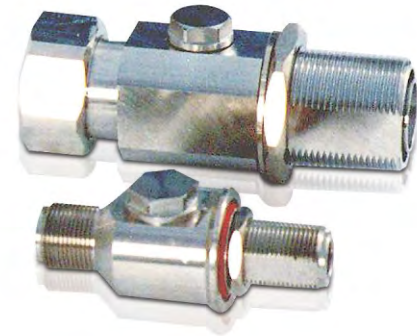

SPECIFICATIONS

Outer Conductor Material	Brass / Silver or Su Co Plated
Inner Conductor Material	Be Cu (Female) / Silver or Su Co Plated
Other Metal Parts Materials	Brass / Nickel Plated
Temperature Range °C	-40 to +100
Moisture Resistance	Waterproof
Maximum Frequency Range MHz	2,700

ELECTRICAL SPECIFICATIONS

Impedance (Nominal) Ω	50
VSWR	< 1.1
Insertion Loss dB	< 0.1
Max. Impulse Spark-Over Voltage	> 600

PART NUMBERS AND PHYSICAL CHARACTERISTICS

Part Number	Surge Arrester Model	Interface Type	Unit of Measure
AGDMDF02	Gas Tube	DIN Male/DIN Female	Each
AG-NFNF	Gas Tube	N Female/N Female	Each

Round Adapter Kit



PRODUCT DESCRIPTION

The Round Adapter Kit provides an easy method for supporting transmission lines to small diameter pipes or poles. The round adapter kit contains ten adjustable hose clamps.

APPLICATION

- Coax hanger support

SPECIFICATIONS

Compatible Pipe/Pole Diameter in (mm)	Fits 1 (25.4) to 4 (101.6)
Material	Stainless steel
Each Kit Includes	<ul style="list-style-type: none"> 10 adjustable hose clamps One (1) installation instruction sheet
Not Included (Order Separately)	Hanger Kits Brackets

PART NUMBERS AND PHYSICAL CHARACTERISTICS

Part Number	Adjustable Diameter in (mm)	Height in (mm)	Weight lbs (kg)	Unit of Measure
RM-A100	1 to 2 (25.4 to 50.8)	0.5 (12.7)	0.8 (0.4)	Kit
RM-A300	3 to 4 (76.2 to 101.6)	0.5 (12.7)	1.2 (0.5)	Kit

Stand-Off Adapter Kit

PRODUCT DESCRIPTION

Stand-Off Adapter Kits enable hangers to be mounted to 1.5 inch (31.8 mm) or larger round adapters. The stand-off adapter is available in stainless steel to provide excellent corrosion resistance and ensure long term integrity in extreme weather applications.

APPLICATION

- Coax hanger support

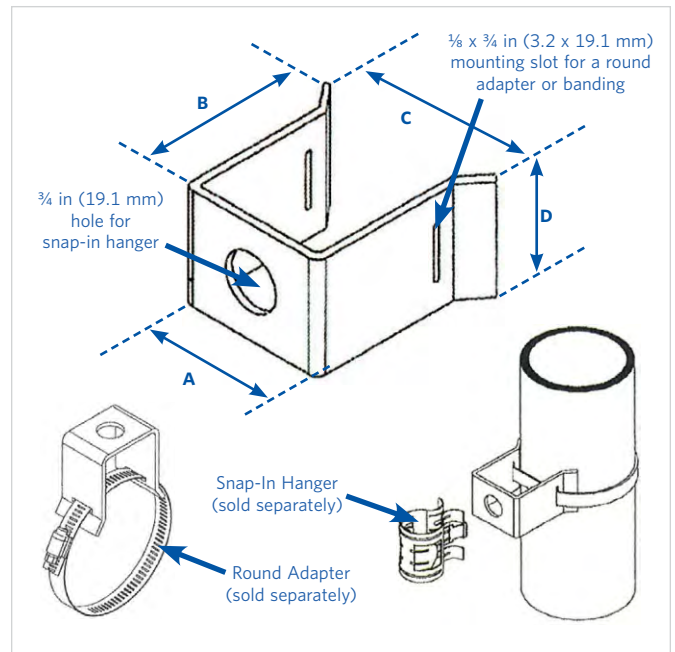

SPECIFICATIONS

Size in (mm)	A = 1.75 (44.5) B = 2.25 (57.2) C = 2.375 (60.3) D = 1.50 (38.1)
Mounts to	Round adapters 1.5 to 4.5 inch (38.1 to 114.3 mm)
Material	Stainless steel
Each Kit Includes	<ul style="list-style-type: none"> 10 stand-off adapters One (1) installation instruction sheet
Not Included (Order Separately)	Round Adapter Kit Snap-In Hanger Kit

PART NUMBERS AND PHYSICAL CHARACTERISTICS

Part Number	Compatible Round Adapter Size in (mm)	Unit of Measure
SA-SS200	1.5 to 3.5 (38.1 to 88.9)	Kit
SA-SS300	2 to 4.5 (50.8 to 114.3)	Kit

Three-Way Stand-Off Adapter Kit

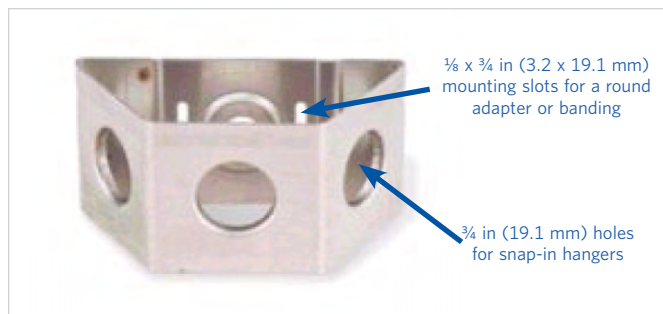

SPECIFICATIONS

Mounts to	Round adapters
Material	Stainless steel
Each Kit Includes	<ul style="list-style-type: none"> • 10 three-way stand-off adapters • One (1) installation instruction sheet
Not Included (Order Separately)	Round Adapter Kit Snap-In Hanger Kit

PART NUMBERS AND PHYSICAL CHARACTERISTICS

Part Number	Outside Length in (mm)	Outside Width in (mm)	Unit of Measure
L-SA-38	7.6 (19.3)	3.8 (98.0)	Kit

Angle Adapter Kit



SPECIFICATIONS

Compatible Solid Angle Member Thickness in (mm)	Fits up to 7/8 inch (22.2 mm)
Material	Stainless steel
Each Kit Includes	<ul style="list-style-type: none"> • 10 stainless steel angle adapters • 10 captive 3/8 inch (9.5 mm) set bolts • One (1) installation instruction sheet
Not Included (Order Separately)	Hanger Kits

PART NUMBERS AND PHYSICAL CHARACTERISTICS

Part Number	Unit of Measure
AA-SL	Kit

PRODUCT DESCRIPTION

The Three-Way Stand-Off Adapter Kit enables hangers to be mounted to round adapters. Each adapter accommodates up to three (3) snap-in hangers for supporting coaxial cable runs. The three-way stand-off adapter is available in stainless steel to provide excellent corrosion resistance and ensure long term integrity in extreme weather applications.

APPLICATION

- Coax hanger support

PRODUCT DESCRIPTION

The Angle Adapter Kit allows the installer to easily secure hangers to solid angle members or in areas where mounting holes are not easily accessible. The stainless steel bolt locks the angle adapter to standard tower members or to mounting surfaces less than 7/8 inch (22.2 mm) thick. The toothed jaw effectively secures large volumes of coax in heavy wind and ice-loading conditions.

Three (3), 3/8 inch (9.5 mm) tapped holes enable the angle adapter to accommodate hanger types which utilize 3/8 inch (9.5 mm) mounting hardware. Angle adapter kits include 10 angle adapters and 10 set bolts.

APPLICATION

- Coax hanger support

Ground Bus Bar Kit

PRODUCT DESCRIPTION

The Ground Bus Bar Kit provides a single, versatile solution to create a central ground point at your site. The ground bus bars are manufactured from ¼ inch (6.3 mm) thick solid, tinned copper, and they incorporate 26 pairs of 7/16 inch (11.1 mm) holes and 26 pairs of ¾ inch (6.4 mm) holes. By slotting one hole in each pair of 7/16 inch holes, the ground bus bar accommodates any lug hole spacing from ¾ inch (19.1 mm) to 1 inch (25.4 mm). Six (6) pairs of 7/16 inch holes are incorporated for lug connections to the ground system.

APPLICATION

- Coax protection

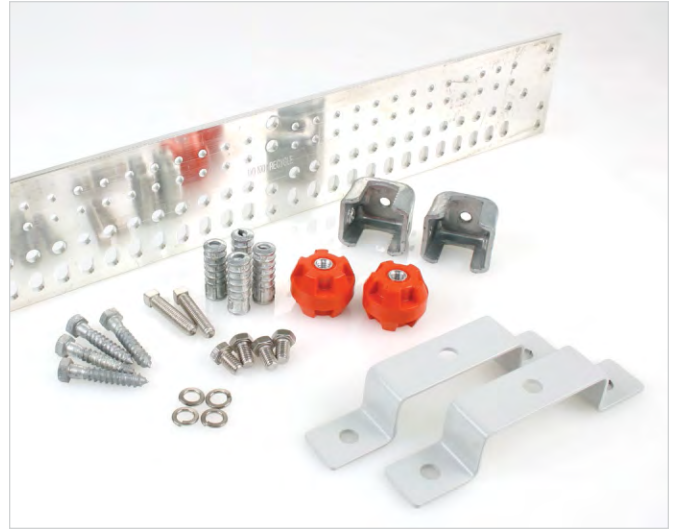

SPECIFICATIONS

Material

Bus bar: solid, tinned copper
 Mounting hardware: stainless steel
 Mounting brackets: galvanized steel

Each Kit Includes

- One (1) universal ground bar
 ¼ inch x 24 inch (6.4 mm x 0.6 m)
- One (1) mounting hardware set
- One (1) mounting bracket set
- One (1) installation instruction sheet

PART NUMBERS AND PHYSICAL CHARACTERISTICS

Part Number	Thickness in (mm)	Height in (mm)	Width in (mm)	Weight lbs (kg)	Unit of Measure
GB0424TU	0.25 (6.3)	4 (102)	24 (610)	8 (3.6)	Kit

Weather Proofing Shell



PRODUCT DESCRIPTION

The Weather Proofing Shell seals and protects connector joints from the environment. The shell also provides easy and fast installation of weather proofing on connector joints. The weather proofing shell is reusable.

APPLICATION

- Coax/connector protection

SPECIFICATIONS

Material	Long glass PP and silicon rubber
Temperature Range °F (°C)	-40 to +140 (-40 to +60)
Standards Compliance	UV Resistant UL® and CL IP 68 IEC60529 ANSI C91191 RoHS-compliant

UL is a registered trademark of UL LLC.

PART NUMBERS AND PHYSICAL CHARACTERISTICS

Part Number	Connector Joint Compatibility	Unit of Measure
WPSANT12D	Antenna to ½ inch (12 mm) DIN Connector	Each
WPS12158D	½ inch (12 mm) to 1½ inch (42 mm) DIN Connector	Each

Anti-Theft Hardware Kit

PRODUCT DESCRIPTION

The Anti-Theft Hardware Kit is used to prevent removal of parts easily when bolted. The kit includes four (4) anti-theft bolts and a star head allen key.

APPLICATION

- Coax protection



SPECIFICATIONS

Bolt Material	Stainless steel
Each Kit Includes	<ul style="list-style-type: none"> ▪ Four (4) anti-theft bolts measuring 3/4 inch x 1 inch (19.1 mm x 25.4 mm) ▪ One (1) star head allen key ▪ One (1) installation instruction sheet

PART NUMBERS AND PHYSICAL CHARACTERISTICS

Part Number	Unit of Measure
WATS-38	Kit



800.551.8948
SuperiorEssex.com

All information, content, data, specifications, packaging and part numbers detailed herein are subject to change. For the most up-to-date information, please visit SuperiorEssex.com. Purchase of this product is subject exclusively to the then current **Superior Essex International LP Terms and Conditions of Sale for Communications and Energy Cable, Wire and Connectivity Products**, which can be found on our website, SuperiorEssex.com, or provided to you upon request.

- Metric ConversionsX-2
- American Wire Gauge SizesX-2
- Optical Fiber TypesX-3
- Optical Fiber SpecificationsX-4
- Optical Fiber CableX-6
- Canadian Central Office CableX-6
- OSP Copper CableX-7
- Mechanical Protection (+M) for Extreme Risk EnvironmentsX-8
- Copper Wire and CableX-9
- Fire Alarm/Security Control CableX-10
- Premises Cable Conduit Fill Quick ReferenceX-11
- PackagingX-12
- Terms and Conditions of SaleX-18
- Part Number IndexX-19

Metric Conversions

Superior Essex uses the U.S. customary system of weights and measures as well as the metric equivalents. If you need help calculating these figures, please consult the conversion charts below.

INTO METRIC CONVERSIONS			
	If You Know	Multiply By	To Get
Length	milli-inch (mil)	25.40	microns (µm)
	inches (in)	25.40	millimeters (mm)
	inches (in)	2.54	centimeters (cm)
	feet (ft)	304.8	meters (m)
	yards (yd)	0.91	meters (m)
	miles (mi)	1.61	kilometers (km)
Area	sq. inches (in ²)	6.45	sq. centimeters (cm ²)
	sq. feet (ft ²)	0.09	sq. meters (m ²)
	sq. yards (yd ²)	0.84	sq. meters (m ²)
	sq. miles (mi ²)	2.59	sq. kilometers (km ²)
	acres	0.40	hectares (ha)
Mass (Weight)	ounces (oz)	28.35	grams (g)
	pounds (lbs)	0.45	kilograms (kg)
	short tons	0.91	tons (t)
Temperature	Fahrenheit (°F)	Subtract 32, then multiply by 0.56	Celsius (°C)
Mass per Length	pounds per 1,000 feet (lbs/kft)	1.49	kilograms per kilometers (kg/km)
	pounds force (lbf)	4.45	newtons (N)
Force	foot-pounds (ft-lbs)	1.36	newtons-meters (N-m)
	pounds force per inches (lbf/in)	1.75	newtons per centimeters (N/cm)
	pounds per sq. inches (PSI)	6.89	kiloPascals (kPa)

OUT OF METRIC CONVERSIONS			
	If You Know	Multiply By	To Get
Length	microns (µm)	0.04	milli-inch (mil)
	millimeters (mm)	0.04	inches (in)
	centimeters (cm)	0.39	inches (in)
	meters (m)	3.28	feet (ft)
	meters (m)	1.09	yards (yd)
	kilometers (km)	3,280.84	feet (ft)
	kilometers (km)	0.62	miles (mi)
Area	sq. centimeters (cm ²)	0.16	sq. inches (in ²)
	sq. meters (m ²)	1.20	sq. yards (yd ²)
	sq. kilometers (km ²)	0.39	sq. miles (mi ²)
	hectares (ha)	2.47	acres
Weight	grams (g)	0.04	ounces (oz)
	kilograms (kg)	2.20	pounds (lbs)
	tons (t)	1.10	short tons
Temperature	Celsius (°C)	Multiply by 1.80, then add 32	Fahrenheit (°F)
Weight per Unit Length	kilograms per kilometers (kg/km)	0.67	pounds per 1,000 feet (lbs/kft)
	newtons (N)	0.22	pounds force (lbf)
Force	newtons-meters (N-m)	0.74	foot-pounds (ft-lbs)
	newtons per centimeters (N/cm)	0.57	pounds force per inches (lbf/in)
	kilo Pascals (kPa)	0.15	pounds per sq. inches (PSI)

American Wire Gauge Sizes

The table below shows various data for copper and aluminum stranded conductors.

AMERICAN WIRE GAUGE (AWG) SIZES								
AWG/ kcmil	Stranding ²	Diameter		Copper DC Resistance @ 20°C		Aluminum DC Resistance @ 20°C		
		in	mm	(Ω/kft)	(Ω/km)	(Ω/kft)	(Ω/km)	
1,000	61	1.117	28.372	0.0106	0.0348	0.0173	0.0568	
750	61	0.968	24.587	0.0141	0.0462	0.0231	0.0758	
600	61	0.866	21.996	0.0177	0.0581	0.0289	0.0948	
500	37	0.789	20.041	0.0212	0.0695	0.0035	0.1140	
400	37	0.706	17.932	0.0264	0.0866	0.0434	0.1420	
350	37	0.661	16.789	0.0302	0.0991	0.0495	0.1620	
300	37	0.611	15.519	0.0353	0.1160	0.0578	0.1870	
250	19	0.558	14.173	0.0423	0.1390	0.0694	0.2280	
0000 (4/0)	19	0.512	13.005	0.0500	0.1640	0.0820	0.2690	
000 (3/0)	19	0.456	11.582	0.0630	0.2070	0.1030	0.3380	
00 (2/0)	19	0.405	10.287	0.7950	0.2610	0.1300	0.4270	
0 (1/0)	19	0.362	9.195	0.1000	0.3280	0.1640	0.5380	
1	7	0.322	8.179	0.1270	0.5220	0.2070	0.6790	
2	7	0.283	7.188	0.1590	0.6590	0.2610	0.8560	
4	7	0.225	5.715	0.2530	1.0500	0.4160	1.3600	
6	19	0.178	4.521	0.4030	1.3200	0.6610	2.1700	
8 ¹	7	0.142	3.607	0.6400	2.1000	1.0500	3.4400	
10	7	0.126	3.200	1.0200	3.3500	1.6700	5.4800	
12	7	0.113	2.870	1.6300	5.3500	2.6700	8.7600	
14	7	0.071	1.803	2.5800	8.4600	4.2200	13.8000	
16	7	0.0576	1.463	4.1000	13.4000	6.7100	22.0000	
18	7	0.0456	1.158	6.5400	21.4000	10.7000	35.1000	
20	7	0.0363	0.922	10.3000	33.8000	16.9000	55.4000	
22	7	0.0288	0.732	16.4000	53.8000	-	-	
24	-	0.0228	0.579	26.1000	85.6000	-	-	
25	-	0.0179	0.455	106.2000	32.3700	-	-	
26	-	0.0159	0.405	133.9000	40.8100	-	-	
27	-	0.0142	0.361	168.9000	51.4700	-	-	
28	-	0.0126	0.321	212.9000	64.9000	-	-	

¹8AWG, Combination Unilay-Stranded, Per ASTM B787

²24AWG through 1000kcmil, Reverse Concentric Compressed Class B, ASTM B8

SINGLE MODE OPTICAL FIBER

Single mode fiber (SMF) is used primarily for intermediate and long distance Outside Plant (OSP) applications that have distances between connections of up to 80 km (50 mi). It is the exceptional information carrying capacity and low-loss properties of this fiber that make it ideal for these demanding applications.

The core, or light-carrying region of the fiber, is approximately 8.3 μm in diameter. This narrows the transmission pathway allowing for only a single path, or mode, for each pulse of light traveling down the core of the fiber. The light transmission technology is laser-based for all single mode communications applications. By combining the extremely high bandwidth properties of SMF with high precision laser-based transceivers, equipment and network systems designers can create networks capable of sending simultaneous voice and data transmission well beyond 10 Gbps over many miles.

Superior Essex offers many types of single mode optical fibers for communications applications. Based on the application, Superior Essex can recommend the following SMF types.

Standard SMF offered by Superior Essex is an excellent choice for patch cords, local area network (LAN), wide area network (WAN) and metropolitan area networks (MAN). This fiber has operating wavelengths centered at 1310 nm and 1550 nm. Refer to the table on page X-4 for performance information.

Reduced Water Peak (RWP) SMF, which has been designed to have low attenuation at 1383 nm, is becoming the most commonly recommended optical fiber for all types of network applications. Standard optical fiber displays an attenuation increase at or about 1383 nm. This wavelength is known as the water-peak region and is where light is strongly absorbed by naturally occurring water-like end groups in the glass, causing high attenuation or signal loss. Specifically, hydroxyl end groups, which make up half of a water molecule, are always present at some level within the glass core and cause increased attenuation over this wavelength region. Superior Essex RWP SMF reduces this effect and allows all the wavelengths between 1300 nm and 1550 nm to be usable. This optical fiber is therefore, not only an excellent choice for traditional applications, but also for more advanced systems such as coarse wavelength division multiplexing (CWDM) and dense wavelength division multiplexing (DWDM) technologies. RWP SMF is the standard single mode optical fiber for all Superior Essex premises cables. Refer to the table on page X-4 for performance information.

Zero Water Peak SMF offers further reductions to the attenuation at 1383 nm. Attenuation improvement at 1383 nm is usually 0.03 to 0.04 dB per km. Refer to the table on page X-4 for performance information.

Non-Zero Dispersion Shifted (NZDS) fiber is used for very high data rates over very long distances (> 30 km). Because of core/cladding modifications, this fiber is more expensive than standard SMF. The advantage of NZDS is that it allows for longer distances between repeaters and therefore lowers the overall system cost for long distance networks. Refer to the table on page X-4 for performance information.

TeraFlex® bend resistant optical fiber is a SMF that complies with ITU-T G.652.D and G.657.A. The bend sensitivity of this optical fiber has been improved so that it can be coiled into a 20 mm diameter loop with ≤ 0.5 dB incurred loss at 1625 nm and ≤ 0.2 dB incurred loss at 1550 nm – five times better bending performance than leading RWP optical fibers. TeraFlex offers excellent Polarized Mode Dispersion (PMD) of ≤ 0.1 ps/ $\sqrt{\text{km}}$ per individual fiber. TeraFlex is an ideal choice for FTTP applications where small enclosures are normal and space is at a premium.

MULTIMODE OPTICAL FIBER

Multimode fiber (MMF) is identified by the physical size of the core as measured in microns (μm) and the applications for which it is typically used. MMF, the most common types having 62.5/125 μm and 50/125 μm core/cladding dimensions, are used for data communications links with the local area network (LAN). The term “multimode” refers to the way the light travels down the optical fiber. For each pulse of light launched into the optical fiber by light source (transceiver), the light signal energy travels within the optical fiber core along multiple paths, or modes. These modes travel at different speeds, resulting in the pulse of light spreading out. This effect limits the bandwidth and distances that can be supported by MMF. For this reason, MMF is used in short distance LAN applications usually less than 2 km (6,560 ft) between connections. Typical network applications include building-to-building and communications closet-to-closet backbones, intelligent highway systems and fiber-to-the-desk. MMF is the choice for these short distance applications cables because of the large core size, which allows for inexpensive connectivity, greater durability and the use of low-cost light sources.

Typically, a light emitting diode (LED), operating at a nominal wavelength of 850 nm, is used as the light source for MMF cable applications. The use of LED-based transceivers, MMF cables and inexpensive MMF connector systems have provided network designers with a relatively low-cost, high-bandwidth technology for campus-like networks. Recent technology breakthroughs in optical fiber transceiver technology have led to a new light source that extends the distance and increases the signal carrying capacity of MMF. This next-generation light source uses a vertical cavity surface emitting laser, or VCSEL (pronounced “vicsel”).

The use of VCSEL transceivers, when compared to traditional LED-based transmission systems, allows for greater distances for traditional applications such as 100 Mbps and for higher bandwidth applications such as 1 Gigabit Ethernet (1 GbE) and 10 Gigabit Ethernet (10 GbE). The VCSEL source transmits light through the center region of the optical fiber core. This has created the requirement for laser-optimized MMF. One of the most popular emerging applications for VCSEL-based LAN application is 10 GbE. By using laser-optimized optical fibers, network engineers can improve transmission performance over greater distances.

TeraGain® optical fibers are available in 62.5/125 μm and 50/125 μm fiber types. These optical fibers have been designed to provide greater data rate and distance support compared to other manufacturers’ optical fiber cables. In particular, the bandwidths of TeraGain optical fibers are greater than the standard MMF offered by other manufacturers and exceed the requirements specified in TIA-568. TeraGain optical fibers can be used with either LED or laser (VCSEL) transmission equipment. Refer to the table on page X-5 for specific performance information.

TeraGain 10G 50/125 multimode fibers are specifically optimized for 850 nm lasers (or VCSELs) that are the heart of the new 10 GbE systems specified in TIA-568. These optical fibers exceed industry specifications for both bandwidth and for differential modal dispersion. TeraGain 10G optical fibers support 10 GbE applications in three ranges: 150, 300 and 550 meters. These ranges allow engineers to cost effectively design the right optical fiber for their application requirements. Superior Essex offers TeraGain 10G/150 as its standard 50 μm MMF in all its premises optical fiber cables. Refer to the table on page X-5 for specific performance information.

Like the TeraGain 10G 50/125 multimode fibers, TeraFlex 10G multimode fibers are specifically optimized for 850 nm lasers (or VCSELs) but with the added benefit of Macrobend Resistance. These optical fibers exceed industry specifications for not only bandwidth and differential modal dispersion, but for minimum bend radii allowing use where tight bend radii are encountered. This is especially important for applications, like 40 GbE and 100 GbE, where channel margins are tight. TeraFlex 10G optical fibers support 10 GbE applications in three ranges: 150 (OM2+), 300 (OM3) and 550 (OM4) meters. Refer to the table on page X-5 for specific performance information.

Optical Fiber Specifications

Single Mode

Single Mode Fiber Types	Reduced	Zero	TeraFlex® Bend Resistant			NZDS
	Water Peak	Water Peak	G.657.A1	G.657.A2	G.657.B3	
	9-Digit Part Number Designator	2	K	J	L	
16-Digit Part Number Designator	10	17	13	14	15	19

Parameter	Test Method/Standard	Units	Wavelength	Cable Type									
Maximum Attenuation	ANSI/TIA-455-78-B-2002	dB/km	1310 nm	Tight Buffer	0.70	0.70	0.70	0.70	0.70	-			
				Loose Tube	0.35	0.35	0.35	0.35	0.35	-			
				1383 nm	Tight Buffer	0.70	0.70	0.70	0.70	0.70	-		
					Loose Tube	0.35	0.31	0.35	0.35	0.35	-		
				1490 nm	Tight Buffer	0.70	0.70	0.70	0.70	0.70	0.70		
					Loose Tube	0.25	0.25	0.25	0.25	0.25	0.30		
			1550 nm	Tight Buffer	0.70	0.70	0.70	0.70	0.70	0.70			
				Loose Tube	0.25	0.25	0.25	0.25	0.25	0.30			
			Typical Attenuation	ANSI/TIA-455-78-B-2002	dB/km	1310 nm	Tight Buffer	0.41	0.41	0.41	0.41	0.41	-
							Loose Tube	0.34	0.34	0.34	0.34	0.34	-
						1383 nm	Tight Buffer	0.41	0.41	0.41	0.41	0.41	-
							Loose Tube	0.33	0.31	0.31	0.31	0.31	-
1550 nm	Tight Buffer	0.41				0.41	0.41	0.41	0.41	0.41			
	Loose Tube	0.19				0.19	0.19	0.19	0.19	0.25			

Parameter	Test Method/Standard	Units	Conditions						
Nominal Group Refractive Index	-	-	1310 nm	1.467	1.467	1.467	1.467	1.467	1.467
			1550 nm	1.468	1.468	1.468	1.468	1.468	1.468
Maximum Individual Fiber Polarization Mode Dispersion	ANSI/TIA/EIA-455-113-96	ps/vkm	-	0.2	0.2	0.2	0.2	0.2	0.2
Cable Cutoff Wavelength	ANSI/TIA-455-80-C-2003	nm	-	1260	1260	1260	1260	1260	1260
Zero Chromatic Dispersion Wavelength	ANSI/TIA-455-175-B-2003	nm	-	1300-1324	1300-1324	1300-1324	1304-1324	1304-1324	N/A
Typical Chromatic Dispersion Slope	ANSI/TIA-455-175-B-2003	ps/nm ² -km	-	0.087	0.087	0.087	0.087	0.087	0.047
Proof Strength	ANSI/TIA/EIA-455-31-C-2005	kpsi	On-line	100	100	100	100	100	100
			Off-line	0.69	0.69	0.69	0.69	0.69	0.69
Mode Field Diameter	ANSI/TIA-455-191-B-2003	µm	1310 nm	8.8-9.6	8.8-9.6	8.8-9.6	8.2-9.2	8.2-9.2	N/A
			1550 nm	9.9-10.9	9.9-10.9	9.9-10.9	9.1-10.1	9.1-10.1	7.8-10.0
Maximum Macrobend Attenuation Increase	ANSI/TIA-455-62-B-2003	dB	1310 nm	0.05	0.05	0.01	0.01	0.01	0.05
			100 turns on 50 mm mandrel	-	-	-	0.40	0.40	-
			1550 nm	-	-	-	-	-	-
			1 turn on 15 mm mandrel	-	-	-	0.10	0.10	-
Cladding Diameter	ANSI/TIA-455-176-A-2003	µm	-	125.0 ± 0.9	125.0 ± 0.9	125.0 ± 0.7	125.0 ± 0.7	125.0 ± 0.7	125.0 ± 0.7
Coating Diameter	ANSI/TIA-455-176-A-2003	micron	-	250 ± 10	250 ± 10	250 ± 10	250 ± 10	250 ± 10	250 ± 10
Maximum Core/Clad Concentricity Error	ANSI/TIA-455-176-A-2003	µm	-	0.5	0.5	0.5	0.5	0.5	0.5
Max. Cladding Non-Circularity	ANSI/TIA-455-176-A-2003	%	-	1	1	1	0.7	0.7	0.7
Maximum Coating/Cladding Concentricity Error	ANSI/TIA-455-176-A-2003	µm	-	12	12	12	12	12	12

Guaranteed Supportable Ethernet Distances	Data Rate	Protocol	Units	Wavelength	Maximum Transmission Distances					
	1 Gbps	1000BASE-LH, 1000BASE-LH-LX	km	1310 nm	10	10	10	10	10	10
km			1550 nm	70	70	70	70	70	70	
10GBASE-LR		km	1310 nm	25	25	25	25	25	25	
10 Gbps	10GBASE-ER	km	1550 nm	40	40	40	40	40	40	
		km	1550 nm	80	80	80	80	80	80	
40 Gbps	40GBASE-LR4	km	1550 nm	10	10	10	10	10	10	
		km	1550 nm	10	10	10	10	10	10	
100 Gbps	100GBASE-LR4	km	1550 nm	10	10	10	10	10	10	
		km	1550 nm	40	40	40	40	40	40	

Fiber Channel Link Distances	Throughput Per Direction	Speed Name	Units	Wavelength	Maximum Link Distance					
	100 MBps	1GFC	meters	1310 nm	10,000	10,000	10,000	10,000	10,000	10,000
200 MBps	2GFC	meters	1310 nm	10,000	10,000	10,000	10,000	10,000	10,000	
400 MBps	4GFC	meters	1310 nm	10,000	10,000	10,000	10,000	10,000	10,000	
800 MBps	8GFC	meters	1310 nm	10,000	10,000	10,000	10,000	10,000	10,000	
1200 MBps	10GFC	meters	1310 nm	10,000	10,000	10,000	10,000	10,000	10,000	
1600 MBps	16GFC	meters	1310 nm	10,000	10,000	10,000	10,000	10,000	10,000	

Standards	ISO/IEC	Tight Buffer	11801: OS1	11801: OS1	11801: OS1	11801: OS1	11801: OS1	-
		Loose Tube	24702: OS2	24702: OS2	24702: OS2	24702: OS2	24702: OS2	-
	Telcordia	GR-20-CORE						
	ITU-T		G.652.D	G.652.D	G.652.D	G.652.D	G.652.D	G.655.C, E
			G.657.A1	G.657.A1	G.657.A2	G.657.A2	G.657.B3	G.656
	TIA-492	CAAB	CAAB	CAAB	CAAB	CAAB	CAAB	N/A
	IEC 60793-2-50 Type		B1.3	B1.3	B1.3	B1.3	B1.3	-
	ANSI/ICEA	Tight Buffer	S-83-596					
		Loose Tube	S-87-640					
RUS	Loose Tube	PE-90						

Optical Fiber Specifications

Multimode

TABLE OF CONTENTS

PREMISES CABLE

OSP CABLE

WIRELESS

TECH INFO

INDEX

Multimode Fiber Types					TeraGain® 62.5/125	TeraGain 50/125	TeraGain Laser Optimized 50/125			TeraFlex® Bend Resistant Laser Optimized 50/125			
					10G/150	10G/300	10G/550	10G/150	10G/300	10G/550	10G/150	10G/300	10G/550
9-Digit Part Number Designator					6	5	A	B	F	M	N	P	
16-Digit Part Number Designator					23	21	27	29	31	28	30	32	

Cable Performance	Parameter	Test Method/Standard	Units	Wavelength	Cable Type								
	Maximum Attenuation	TIA/EIA-455-78	dB/km	850 nm	Tight Buffer/ Loose Tube	3.5	3.5	3.5	3.5	3.5	3.5	3.5	3.5
		TIA/EIA-455-78	dB/km	1300 nm	Tight Buffer/ Loose Tube	1.5	1.5	1.5	1.5	1.5	1.5	1.5	1.5
	Typical Attenuation	TIA/EIA-455-78	dB/km	850 nm	Tight Buffer/ Loose Tube	3.0	3.0	3.0	3.0	3.0	3.0	3.0	3.0
TIA/EIA-455-78		dB/km	1300 nm	Tight Buffer/ Loose Tube	2.7	2.2	2.2	2.2	2.2	2.2	2.2	2.2	

Fiber Performance	Parameter	Test Method/Standard	Units	Conditions												
	Numerical Aperture	ANSI/TIA-455-177-B-2003	-	-	0.275 ± 0.015	0.200 ± 0.015	0.200 ± 0.015	0.200 ± 0.015	0.200 ± 0.015	0.200 ± 0.015	0.200 ± 0.015	0.200 ± 0.015	0.200 ± 0.015	0.200 ± 0.015		
	Nominal Group Refractive Index	OTDR	-	850 nm	1.496	1.483	1.483	1.483	1.483	1.483	1.483	1.483	1.483	1.483		
			-	1300 nm	1.491	1.479	1.479	1.479	1.479	1.479	1.479	1.479	1.479	1.479		
	Macrobend Attenuation Change	ANSI/TIA-455-62-B-2003	dB	100 turns on 75 mm Mandrel	850 nm	≤ 0.5	≤ 0.5	≤ 0.5	≤ 0.5	≤ 0.5	≤ 0.5	≤ 0.5	≤ 0.5	≤ 0.5		
					1300 nm	≤ 0.5	≤ 0.5	≤ 0.5	≤ 0.5	≤ 0.5	≤ 0.5	≤ 0.5	≤ 0.5	≤ 0.5		
					2 turns on 30 mm Mandrel	850 nm	-	-	-	-	-	-	≤ 0.1	≤ 0.1	≤ 0.1	≤ 0.1
						1300 nm	-	-	-	-	-	-	≤ 0.3	≤ 0.3	≤ 0.3	≤ 0.3
	Proof Strength	TIA/EIA-455-31	kpsi	On-line	100	100	100	100	100	100	100	100	100	100		
					GPa	0.69	0.69	0.69	0.69	0.69	0.69	0.69	0.69	0.69	0.69	
	Cladding Diameter	ANSI/TIA-455-176-A-2003	micron	-	125 ± 2	125 ± 2	125 ± 2	125 ± 2	125 ± 2	125 ± 2	125 ± 2	125 ± 2	125 ± 2	125 ± 2		
	Coating Diameter	ANSI/TIA-455-176-A-2003	micron	-	250 ± 10	250 ± 10	250 ± 10	250 ± 10	250 ± 10	250 ± 10	250 ± 10	250 ± 10	250 ± 10	250 ± 10		
	Core/Clad Concentricity Error	ANSI/TIA-455-176-A-2003	microns	-	1.5	1.5	1.5	1.5	1.5	1.5	1.5	1.5	1.5	1.5		
	Cladding Non-Circularity	ANSI/TIA-455-176-A-2003	%	-	1.5%	1.5%	1.5%	1.5%	1.5%	1.5%	1.5%	1.5%	1.5%	1.5%		
	Coating/Clad Concentricity Error	ANSI/TIA-455-176-A-2003	microns	-	12 µm	12 µm	12 µm	12 µm	12 µm	12 µm	12 µm	12 µm	12 µm	12 µm		
	Minimum Bandwidth: Overfilled Launch	TIA/EIA-455-124-2000	MHz-km	850 nm	220	500	700	1,500	3,500	700	1,500	3,500				
1300 nm				600	500	500	500	500	500	500	500					
Minimum Bandwidth: Laser Effective Modal Bandwidth	TIA-455-220-A	MHz-km	850 nm	N/A	N/A	950	2,000	4,700	950	2,000	4,700					
			1300 nm	N/A	N/A	500	500	500	500	500	500	500				

Guaranteed Supportable Ethernet Distances	Data Rate	Protocol	Units	Wavelength	Maximum Transmission Distances								
	10 Mbps	10BASE-FL	meters	850 nm	1,250	1,250	1,250	1,250	1,250	1,250	1,250	1,250	1,250
	100 Mbps	100BASE-SX	meters	850 nm	500	750	1,000	1,000	1,000	1,000	1,000	1,000	1,000
		100BASE-FX	meters	1300 nm	2,000	2,000	2,000	2,000	2,000	2,000	2,000	2,000	2,000
	1 Gbps	1000BASE-SX	meters	850 nm	300	750	1,000	1,000	1,040	1,000	1,000	1,040	1,040
		1000BASE-LX	meters	1300 nm	600*	600*	600	600	600	600	600	600	600
	10 Gbps	10GBASE-SR	meters	850 nm	35	82	150	300	550	150	300	550	550
		10GBASE-LRM	meters	1300 nm	300	300	300	300	300	300	300	300	300
	40 Gbps	40GBASE-SR4	meters	850 nm	-	-	-	100	125	-	100	125	125
	100 Gbps	100GBASE-SR10	meters	850 nm	-	-	-	100	125	-	100	125	125

*Mode conditioning patch cord required

Fiber Channel Link Distances	Throughput Per Direction	Speed Name	Units	Wavelength	Maximum Link Distance								
	100 MBps	1GFC	meters	850 nm	300	500	500	860	*	500	860	*	*
	200 MBps	2GFC	meters	850 nm	150	300	300	500	*	300	500	*	*
	400 MBps	4GFC	meters	850 nm	50	150	150	380	400	150	380	400	400
	800 MBps	8GFC	meters	850 nm	21	50	50	150	190	50	150	190	190
	1200 MBps	10GFC	meters	850 nm	33	82	82	300	*	82	300	*	*
	1600 MBps	16GFC	meters	850 nm	15	35	35	100	125	35	100	125	125

*The link distance on OM4 fiber has not been defined for these speeds.

Standards	ISO/IEC 11801	OM1	OM2	OM2	OM3	OM4	OM2	OM3	OM4		
	Telcordia	GR-20-CORE									
	ITU-T	G.651.1									
	TIA-492	AAAA-A	AAAB	AAAB	AAAC-A	AAAD	AAAB-A	AAAC-B	AAAD		
	IEC 60793-2-10 Type	A1b	A1a.1	A1a.1	A1a.2	A1a.3	A1a.1	A1a.2	A1a.3		
	ANSI/ICEA	Tight Buffer	S-83-596								
		Loose Tube	S-87-640								

Optical Fiber Cable

ANSI/TIA/EIA-598-B STANDARD COLORS

Fiber/Unit Number	Fiber Color
1	Blue
2	Orange
3	Green
4	Brown
5	Slate
6	White
7	Red
8	Black
9	Yellow
10	Violet
11	Rose
12	Aqua
13 and higher	The color code is repeated, Black stripe or dash is added, according to the ANSI/TIA/EIA-598-B specifications

STANDARD JACKET COLORS

Cable Type	Standard Jacket Color
Single Mode Premises	Yellow
Standard Multimode Premises	Orange
Laser-Optimized 50 µm Premises	Aqua
Indoor/Outdoor	Black
Hybrid Standard Multimode Premises	Orange
Hybrid Laser-Optimized 50 µm Premises	Aqua
Outside Plant (OSP)	Black*

Custom jacket colors also available

*One extruded color stripe is available. Standard stripe colors are Orange, Green, Yellow and Blue (other colors available upon request).

OSP FLOODING COMPOUND AND JACKET MARKING OPTIONS

	Flooding Compound	Jacket Marking	Part No. Designator (Last Digit in Part No.)
Standard	Dry (SAP) Block	Feet	1
	Dry (SAP) Block	Meters	2
	Flooding Compound	Feet	3
	Flooding Compound	Meters	4
Options	Special Print Dry (SAP) Block	Feet	5
	Special Print Dry (SAP) Block	Meters	6
	Special Print Flooding Compound	Feet	7
	Special Print Flooding Compound	Meters	8

OSP CENTRAL MEMBERS/STRENGTH MEMBERS OPTIONS

	Central Member/Strength Member
Standard	Dielectric / Dielectric
Options	Standard loose tube cables are available with a steel center member
	Single tube cables are available with steel strength members embedded in the outer jacket

ADDITIONAL OSP OPTIONS

- Special protection jacket
- Rodent and fuel protection
- Nylon outer jacket

Contact your Superior Essex sales representative for further information.

Canadian Central Office Cable

The distinctive Canadian insulation color-coding utilizes colored ink in a systematic pattern of dots/dashes/bands. These marks provide positive identification of each conductor and each pair within a unit. Cable cores may contain both pairs and single conductors. And, some cables may contain "spare" pairs. Each insulated conductor shall be marked with 1 or 2 dots/dashes/bands in accordance with the table below.

INSULATION COLOR CODES

Pair Number	Conductor #1		Conductor #2	
	Solid Color	Single Band Color	Solid Color	Double Band Color
1	Blue	White	Blue	White
2	Orange	White	Orange	White
3	Green	White	Green	White
4	Brown	White	Brown	White
5	Slate	White	Slate	White
6	Blue	Red	Blue	Red
7	Orange	Red	Orange	Red
8	Green	Red	Green	Red
9	Brown	Red	Brown	Red
10	Slate	Red	Slate	Red
11	Blue	Black	Blue	Black
12	Orange	Black	Orange	Black
13	Green	Black	Green	Black
14	Brown	Black	Brown	Black
15	Slate	Black	Slate	Black
16	Blue	Yellow	Blue	Yellow
17	Orange	Yellow	Orange	Yellow
18	Green	Yellow	Green	Yellow
19	Brown	Yellow	Brown	Yellow
20	Slate	Yellow	Slate	Yellow
21	Blue	Violet	Blue	Violet
22	Orange	Violet	Orange	Violet
23	Green	Violet	Green	Violet
24	Brown	Violet	Brown	Violet
25	Slate	Violet	Slate	Violet

SPARE PAIR INSULATION COLOR CODES

Spare Pair Number	Conductor #1		Conductor #2	
	Solid Color	Single Band Color	Solid Color	Double Band Color
1	White	Black	White	Black
2	White	Yellow	White	Yellow
3	Red	White	Red	White
4	Red	Yellow	Red	Yellow
5	Red	Black	Red	Black

SPARE SINGLE INSULATION COLOR CODES

Spare Single Number	Single Conductor	
	Solid Color	Triple Band Color
1	White	Black
2	White	Yellow
3	Red	White
4	Red	Yellow

For pairs numbering 1 through 25, the pair identification colors are outlined below. In cable constructions containing more than 25-pair, the colors are repeated as necessary. Color coded binders are used to identify 25-pair groups of color coded pairs.

PAIR IDENTIFICATION COLORS		
Pair Number	Tip Color	Ring Color
1	White	Blue
2	White	Orange
3	White	Green
4	White	Brown
5	White	Slate
6	Red	Blue
7	Red	Orange
8	Red	Green
9	Red	Brown
10	Red	Slate
11	Black	Blue
12	Black	Orange
13	Black	Green
14	Black	Brown
15	Black	Slate
16	Yellow	Blue
17	Yellow	Orange
18	Yellow	Green
19	Yellow	Brown
20	Yellow	Slate
21	Violet	Blue
22	Violet	Orange
23	Violet	Green
24	Violet	Brown
25	Violet	Slate

For cables through 600-pair, 25-pair groups are identified by their binder colors in the same sequence as the pair identification is accomplished. Group 1 has White-Blue binders, Group 2 has White-Orange binders, etc. In this manner, each pair is uniquely identified. In cables having 25-pair or less, binders are normally not used. However, if specified, the binders will be Group 1, White-Blue. For cables of 100-pair or less, the use of the White binder is optional.

GROUPS OF PAIRS BINDER IDENTIFICATION COLORS			
Group Number	Group Pair Counts	Binder Colors	
1	1-25	White	Blue
2	26-50	White	Orange
3	51-75	White	Green
4	76-100	White	Brown
5	100-125	White	Slate
6	126-150	Red	Blue
7	151-175	Red	Orange
8	176-200	Red	Green
9	201-225	Red	Brown
10	226-250	Red	Slate
11	251-275	Black	Blue
12	276-300	Black	Orange
13	301-325	Black	Green
14	326-350	Black	Brown
15	351-375	Black	Slate
16	376-400	Yellow	Blue
17	401-425	Yellow	Orange
18	426-450	Yellow	Green
19	451-475	Yellow	Brown
20	476-500	Yellow	Slate
21	501-525	Violet	Blue
22	526-550	Violet	Orange
23	551-575	Violet	Green
24	576-600	Violet	Brown

It is desirable for manufacturing purposes to combine four 25-pair groups into "super units" when cables have 900-pair or more.

SUPER-UNITS BINDER IDENTIFICATION COLORS		
Pair Number	Group Number	Binder Color
1-600	1-24	White
601-1,200*	25-48	Red
1,201-1,800*	49-72	Black
1,801-2,400*	73-96	Yellow
2,401-3,000*	97-120	Violet
3,001-3,600*	121-144	Blue
3,601-4,200*	145-168	Orange

*The above information is based on the Full Count binder color coding used in RDUP copper cable designs having 1,200-pair or more.



TECHNICAL GUIDELINE

Binder color coding information and core lay-up diagrams are available on our site. Refer to the "Resources" section on our site for the Technical Guideline, "OSP Copper Core Lay-up Diagrams: Full Count or Mirror Image," for more information.

Mechanical Protection (+M) for Extreme Risk Environments

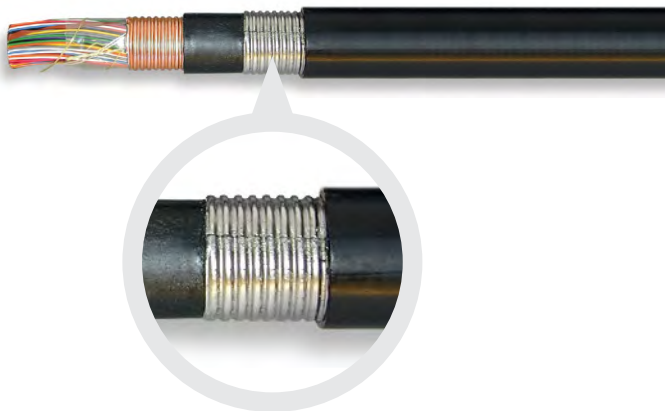

PRODUCT DESCRIPTION

Superior Essex standard OSP cable offering with the +M feature is designed for extreme direct burial or lashed aerial installations. Extreme environments can include locations difficult to access, those with rocky or unstable terrain, rodent infested locations and shallow water crossings. Mechanical protection (+M) armoring is suitable for environments where additional mechanical protection is warranted or desired.

Weight and diameters are increased when +M is added to protect standard cables. Approximate weights and diameters can be provided by contacting your Superior Essex Inside or Outside Sales Representative (please specify the standard OSP cable desired).

In most instances, +M protected cables will be supplied in standard ship lengths corresponding to the standard OSP cable selected. Special lengths require Superior Essex approval before manufacturing. Also, reel sizes can be provided upon request.

SPECIFICATIONS

Basic Cable	Mechanical Protection (+M) may be applied over any OSP Air core or Filled core copper cable
+M Armor	An electrically continuous 0.006 inch corrugated steel armor is applied directly over a basic cable providing additional mechanical protection in extreme environments; the sheath interfaces are fully flooded as the steel armor is applied longitudinally with an overlap, encasing the basic cable
Overall Jacket	A black, polyethylene jacket designed to provide a tough protective covering is applied overall; the polyethylene contains antioxidant(s) for long-term stability and furnace black to prevent damage from ultraviolet exposure
Jacket Marking	Identifying information includes a telephone handset, cable code, pair count, AWG, date of manufacture and sequential length markings at 2 foot intervals
Temperature Rating	See temperature rating for underlying cable

APPLICATIONS

- Direct burial where additional mechanical protection is required or desired
- Lashed aerial where additional mechanical protection is required or desired
- GOPIC®-F+M and CASPIC®-F+M cable designs can be used for submersion under water in short shallow rivers, ponds or lakes not exceeding 30 feet deep

NEC FIRE RESISTANCE RATINGS

Article 800 of the National Electrical Code (NEC), also known as NFPA 70, covers requirements for low-voltage communications cables. The NEC requires that cables used in premises, both commercial and residential, be “listed for the purpose” by a Nationally Recognized Test Laboratory (NRTL, pronounced “nurtle”). Other countries have similar requirements. UL (Underwriters Laboratories Inc.) is the most recognized listing agency in the US. UL 444 is the overall specification used to identify the requirements for listed communications cables.

Many of the fire resistance test procedures called out in UL 444 are written by UL. However, other laboratories, such as ITS (Intertek Testing Services) and CSA (Canadian Standards Association), can also provide listing compliance to the NEC.

Five levels of fire resistance are specified. These are outlined below, from most stringent to least. The ratings are hierarchical, i.e., from a fire resistance standpoint, a higher rating can be substituted for any lower rating, but not vice versa.

NEC Designation	CSA Equivalent	Common Term	Test	Comments
CMP	FT6	Communications Plenum	NFPA 262	<ul style="list-style-type: none"> Cable must have resistance to flame spread and reduced smoke generating properties Cable is approved for placement in air handling ducts and chambers (plenums) without the use of fireproof conduit Purpose of the rating is to lessen the transmission of fire and visible smoke to unaffected parts of the building Toxic or corrosive elements of the smoke are not measured Equivalent to Canadian FT6 rating
CMR	N/A	Communications Riser	UL 1666	<ul style="list-style-type: none"> Cable must not transmit flame from one floor to another when placed vertically in a building shaft (riser) Equivalent to Canadian FT4 rating
CMG	FT4	Communications General Use	CSA C22.2 No. 0.3-M (Vertical Tray)	<ul style="list-style-type: none"> Cable may not transmit flame for more than 4 feet, 11 inches Cable shall not penetrate floors or ceilings (i.e. cable may only be used within a single floor) Designation was added as a part of the harmonization efforts between U.S. and Canadian standards
CM	N/A	Communications General Purpose	UL 1581 (Vertical Tray)	<ul style="list-style-type: none"> Cable may not transmit flame for more than 4 feet, 11 inches Cable shall not penetrate floors or ceilings (i.e. cable may only be used within a single floor)
CMX	FT1	Communications Limited Purpose	UL 1581 VW-1 (Vertical Wire)	<ul style="list-style-type: none"> Cable meets the least stringent flame spread requirements of all ratings For residential use, but can only be installed in one and two-family (duplex) housing units Often rated with optional UL requirements for outdoor use*

*These “outdoor” requirements are limited to some cold temperature properties and UV resistance. They do not qualify a cable to be substituted for an Outside Plant (OSP) cable. For example, they have no protection against the intrusion of water, which can destroy a cable’s transmission properties and physically degrade a cable as well. The purpose of the “outdoor” rating is to ensure the cable can withstand outdoor exposure in the short run between the Network Interface Unit and the point of entry into the interior of the home.

BALANCED TWISTED PAIR TRANSMISSION CATEGORIES

In response to growing demand for data applications, premises cable performance has evolved such that several categories of transmission performance for balanced twisted pair cables have been developed. These

categories are detailed below. The categories are hierarchical, i.e., a higher category can be substituted for any lower category, but not vice versa.

Category	Maximum Bandwidth	Common Applications	Specifications	Comments
CAT 6A	500 MHz	10GBASE-T (IEEE 802.3an)	ANSI/TIA-568-C.2 ANSI/ICEA S-90-661	<ul style="list-style-type: none"> Designed for reduced alien crosstalk
CAT 6	250 MHz	1000BASE-T		<ul style="list-style-type: none"> Doubles the bandwidth of CAT 5e and vastly improves signal-to-noise margins
CAT 5e	100 MHz	1000BASE-T		<ul style="list-style-type: none"> Characterized by tightly twisted pairs to reduce crosstalk loss Proposed FCC minimum category requirement effective 2020
CAT 5	100 MHz	100BASE-T 100 Mbps TPDDI 622 Mbps ATM		<ul style="list-style-type: none"> No longer recognized as an appropriate medium for commercial networking installations (replaced by CAT 5e or higher)
CAT 3	16 MHz	10BASE-T Analog Voice Telecom Closet Wiring		<ul style="list-style-type: none"> Minimum allowed by the FCC for horizontal cable in commercial and residential voice and data applications Market trend is to abandon CAT 3 in favor of installing CAT 5e or higher for both data and voice

Fire Alarm/Security Control Cable

DISTANCE THE CABLE WILL RUN

Voltage drop should be calculated or refer to equipment manufacturer's recommendations. Knowing the cable run will help identify the right gauge size cable to select. A larger gauge size is suitable for longer runs.

NON-POWER LIMITED OR POWER LIMITED

The difference between power limited cables and non-power limited cables are specified in specific sections of the NEC.

- **Non-Power Limited Cable** is a fire alarm circuit powered by a source that complies with NEC sections 760-21 and 760-23. Non-power limited fire alarm cables have been designed for installations where fire alarm cables are permitted to occupy the same enclosure, or race way as other Class 1 Circuits, or 600V cables.
- **Power Limited Cable** is a fire alarm circuit powered by a source that complies with section 760-41. Power limited fire alarm cables are rated for 300V. Superior Essex offers only power limited fire alarm and power limited security control cables.

SHIELDED OR NON-SHIELDED

Is the system microprocessor based and therefore sensitive to EMI and RFI? If the system is computer based, a **shielded** cable will protect the circuits from this outside interference and keep the signal constant. If interference is not a concern, then a **non-shielded** cable is a cost effective solution.

- **EMI** (Electro Magnetic Interference): EMI can come from electrostatic sparks or spiking from motors, neon or fluorescent lighting ballasts or any other sources that cause noise. Shielded cables should be considered for installations in areas near dimmer panels and light switches, in parallel runs, near neon or fluorescent lights and near power cables.
- **RFI** (Radio Frequency Interference): Some frequencies used for radio communications can become coupled onto conductors to produce RFI.

SIMPLIFYING PRODUCT SELECTION

Superior Essex designed its Fire Alarm and Security Control cables to have multiple NEC and UL listings. A single cable design satisfies several listing categories and can be deployed if one listing category is called out by the customer. As an example, the Fire Alarm cable jacket is marked with three listings: FPLR, CL3R and CMR. This covers UL 1424 for the FPLR rating, UL 13 for the CL3R rating and UL 444 for the CMR rating.

When the customer specification calls for any one of the three specifications, this product is properly listed for that application. This simplifies product selection and helps with ordering stock and installation. Superior Essex has combined General Use (FPL) and Riser (FPLR) into one category called Riser.

Superior Essex Category	NEC/UL Listing	Suitable Applications	Substitutions
Non-Plenum or Riser	FPLR and FPL	Vertical runs in a shaft or from floor to floor and general purpose use	CM, CMR, CL3R
Plenum	FPLP	Ducts, plenums and other space used for environmental air	CMP, CL3P

Power Limited Cable Type	Listing	Bare Copper Standards			NEC and UL Standards				Miscellaneous Standards		
		ASTM B-3 (Solid Copper)	ASTM B-3 and B-8 (Stranded Copper)	UL 1424 Fire Alarm NEC Article 760	UL 13 Security NEC Article 725 (150 Volts)	UL 444 NEC Article 800 (300 Volts)	UL 1666 NFPA 262	California State Fire Marshall	Sunlight Resistant	RoHS-Compliant	
Fire Alarm, Non-Shielded and Shielded	Riser	✓		✓	✓	✓	✓	✓	✓	✓	
	Plenum	✓		✓	✓	✓		✓		✓	
Security Control, Non-Shielded and Shielded	Riser	✓	✓	✓	✓	✓	✓	✓	✓	✓	
	Plenum	✓	✓	✓	✓	✓		✓		✓	

INSULATION COLORS

Fire Alarm Conductor Number	Insulation Color
1	Black
2	Red
3	Brown
4	Blue
5	Orange
6	Yellow
7	Violet
8	Gray

Security Control Conductor Number	Insulation Color
1	Black
2	Red
3	White
4	Green
5	Brown
6	Blue
7	Orange
8	Yellow
9	Violet
10	Gray
11	Pink
12	Tan

CABLE SELECTION FOR VIDEO APPLICATIONS

Closed circuit security cameras use baseband frequencies, typically under 5 MHz. These applications are best suited for the bare copper center conductors of the Superior Essex RG-59 coaxial cable, which also features 95% copper braiding. RG-59 coaxial cable is specifically designed for applications operating below 1 GHz, but will also support higher frequency applications at shorter distances than RG-6 coaxial cable.

Many video and RF applications use frequencies above 1 GHz. RG-6 coaxial cable is often the preferred cable choice for applications such as CATV transmission. In such cases, the decision is whether to use 60% or 80% braid/shield or a quad shield design. The quad shield design is slightly more expensive than the 60% and 80% shield designs, but offers superior interference protection than the 60% and 80% braid versions.

It is becoming more common however, for copper category (CAT) twisted pair cables, like CAT 5e and 6, to be used for Closed Circuit over Twisted Pair (CCTP) systems. Digitally formatted signals provide dramatically better pictures and better sound quality. Digital Signal Processed (DSP) cameras fed by copper twisted CAT 5e and 6 cables, typically have more control setting options, plus digital video recorders (DVRs) options. Both DSP cameras and DVRs can typically be connected with coax products, but you should consult the camera manufacturer for its recommendation before making a cable selection.

Premises Cable Conduit Fill Quick Reference

This information is intended as a guideline. Because conduit sizes may vary by manufacturer, please verify all dimensions prior to using this reference chart. This guideline is based on National Electrical Code (USA) recommendations for conduit fill of runs with no more than two 90°

bends. For assistance in calculating conduit fill, refer to the "Resources" area of our site for the Technical Guideline, "How to Calculate Conduit Fill." Use only approved lubricants.

Conduit Trade Size Designator* English (Metric)	½ (16)	¾ (21)	1 (27)	1¼ (35)	1½ (41)	2 (53)	2½ (63)	3 (78)	3½ (91)	4 (103)	5 (129)
Conduit Internal Diameter in (mm)	0.62 (15.7)	0.82 (20.9)	1.05 (26.6)	1.38 (35.1)	1.61 (40.9)	2.07 (52.5)	2.47 (62.7)	3.07 (77.9)	3.55 (90.1)	4.03 (102.3)	5.05 (128.2)
Conduit Cross-Sectional Area in² (mm²)	0.30 (195)	0.53 (345)	0.87 (559)	1.51 (973)	2.05 (1,322)	3.39 (2,177)	482 (3,106)	745 (4,794)	996 (6,413)	12.83 (8,268)	20.15 (12,984)
Cable Nominal Diameter in (mm)	Number of Cables at Maximum Recommended Conduit Fill (1 Cable @ 53% Maximum, 2 Cables @ 31% Maximum, 3 or More Cables @ 40% Maximum)										
	15	26	44	76	103	171	262	376	504	649	1020
0.10 (2.5)	9	15	26	45	61	101	155	223	298	384	603
0.13 (3.3)	6	11	19	33	46	76	116	167	224	288	453
0.15 (3.8)	4	8	13	23	32	52	80	116	155	200	314
0.18 (4.6)	3	6	11	19	25	42	65	94	126	162	255
0.20 (5.1)	3	6	10	17	23	38	59	85	114	147	231
0.21 (5.3)	3	5	9	15	21	35	54	77	104	134	210
0.22 (5.6)	2	5	8	14	19	32	49	71	95	122	192
0.23 (5.8)	2	4	7	13	18	29	45	65	87	112	177
0.24 (6.1)	1	4	7	12	16	27	41	60	80	103	163
0.25 (6.4)	1	3	6	11	15	25	38	55	74	96	150
0.26 (6.6)	1	3	6	10	14	23	35	51	69	89	139
0.27 (6.9)	1	3	5	9	13	21	33	48	64	82	130
0.28 (7.1)	1	3	5	9	12	20	31	44	59	77	121
0.29 (7.4)	1	2	4	8	11	19	29	41	56	72	113
0.30 (7.6)	1	2	4	7	10	17	27	39	52	67	106
0.31 (7.9)	1	2	4	7	10	16	25	36	49	63	99
0.32 (8.1)	1	1	3	6	9	15	24	34	46	59	93
0.33 (8.4)	1	1	3	6	8	14	22	32	43	56	88
0.34 (8.6)	1	1	3	6	8	13	21	30	41	53	83
0.35 (8.9)	1	1	2	4	6	10	16	23	31	40	63
0.40 (10.2)	1	1	1	3	5	8	12	18	24	32	50
0.45 (11.4)	0	1	1	3	4	6	10	15	20	25	40
0.50 (12.7)	0	1	1	1	3	5	8	12	16	21	33
0.55 (14.0)	0	0	1	1	2	4	7	10	14	18	28
0.60 (15.2)	0	0	1	1	1	4	6	8	11	15	24
0.65 (16.5)	0	0	1	1	1	3	5	7	10	13	20
0.70 (17.8)	0	0	1	1	1	3	4	6	8	11	18
0.75 (19.1)	0	0	0	1	1	2	4	5	7	10	15
0.80 (20.3)	0	0	0	1	1	1	3	5	6	8	14
0.85 (21.6)	0	0	0	1	1	1	3	4	6	8	12
0.90 (22.9)	0	0	0	1	1	1	2	4	5	7	11
0.95 (24.1)	0	0	0	1	1	1	2	3	5	7	11
1.00 (25.4)	0	0	0	1	1	1	2	3	5	6	10

*Identifier only; not an actual dimension

Packaging

Descriptions



Steel Reel

Long lengths of cable are placed onto Steel Reels. An advantage of this reel is that it is environmentally-friendly and recycled for years of service.



BrakeBox® Dual Brake System

This package is dual purpose. In this design the cable is placed onto a plastic spool, which is placed into a box. The brake allows for back-tension and over-spin control. The spool may be taken from the box for installation or may be left in the box where the cable pays out through a slotted opening.



Wood/Plywood Reel

Reels may be made of plywood or wood. Superior Essex wooden reels can be recycled an average of five times before retirement (see Web site for further details).



POP™ Box

In this package, the cable is coiled into a box. The product pays out through a tube opening in the box. This design does not allow for the cable to be removed as a unit from the box.



Spool

Wire is wound onto a spool. The spool is placed inside a box for protection during shipment. Spools are smaller than wood or steel reels.



Reel-in-a-Box

This package is dual purpose. In this design the cable is placed onto a plastic spool, which is placed into a box. The spool may be taken from the box for installation or may be left in the box where the cable pays out through a slotted opening.



Ribbed Spool

Cable is wound onto a black, ribbed, plastic recyclable spool. The spool is robust and easy to handle. Spools are smaller than wood or steel reels.



Knock-out Box

Cable is coiled and fastened within a box. Knock out boxes can be identified by a perforated "knock-out" that is removed, allowing access to the cable.



Parallel Cone

This package is designed to fit into the General Machine Products (GMP) cast aluminum wire dispensing system (GMP units 80470 or 80471). When placed onto the GMP dispenser, the jumper or distribution frame wire pays out smoothly. GMP dispensers are most common in central offices.



Coils

Coils refer to lengths of cable wrapped into a shape (usually a circle) and fastened with one or more ties. Coils can be protected by a shrink wrap. Multiple coils may be placed inside a box or on a pallet for shipping, and may be secured by stretch-wrap. Coils can be custom configured to fit a customer's unique cable and wire feeding systems.

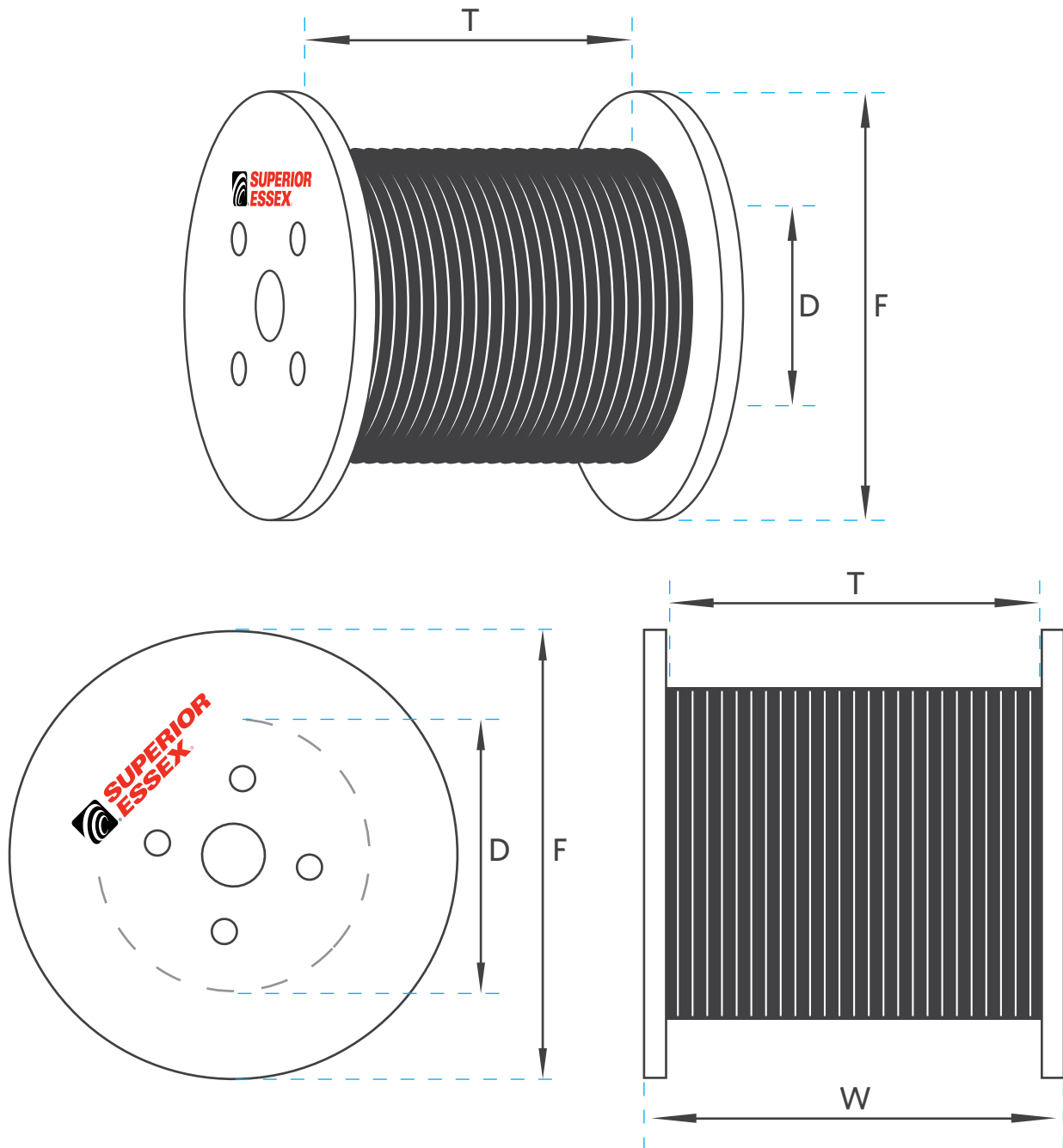

Flange x Traverse x Drum (F x T x D)

F = Flange Diameter

T = Traverse (inside width between flanges)

D = Drum Diameter

W = Overall Width (includes flanges)

Packaging

Premises Fiber Reels

PREMISES FIBER REEL DIMENSIONS						
Reel Type	Plastic			Plywood		
Flange (F) in	12	12	14	16	24	30
Traverse (T) in	6	9	9	15	18	18
Drum (D) in	5	5	5	8	12	12
Overall Width (W) in	7.125	10.125	10.375	15.75	19.375	19.375
Reel Weight lbs	2	2	2	5	17	28
PREMISES FIBER REEL CAPACITIES						
Cable Nominal Diameter in (mm)	Cable Length ft (m)			Cable Length ft (m)		
0.075 (1.91)	2,561 (781)	3,856 (1,175)	7,319 (2,231)	12,836 (3,912)		
0.100 (2.54)	1,441 (439)	2,169 (661)	4,172 (1,272)	7,434 (2,266)	28,571 (8,709)	
0.125 (3.18)	917 (280)	1,383 (422)	2,665 (812)	4,753 (1,449)	18,270 (5,569)	37,970 (11,573)
0.150 (3.81)	637 (194)	961 (293)	1,749 (533)	3,198 (975)	12,283 (3,744)	25,836 (7,875)
0.175 (4.45)	429 (131)	646 (197)	1,321 (403)	2,314 (705)	8,874 (2,705)	19,346 (5,897)
0.200 (5.08)	329 (100)	495 (151)	982 (299)	1,853 (565)	7,123 (2,171)	14,802 (4,512)
0.225 (5.72)	247 (75)	374 (114)	807 (246)	1,290 (393)	5,318 (1,621)	11,630 (3,545)
0.250 (6.35)	227 (69)	343 (105)	661 (202)	1,183 (361)	4,551 (1,387)	9,459 (2,883)
0.275 (6.99)	169 (51)**	255 (77)**	539 (164)**	934 (285)	3,584 (1,093)	7,623 (2,323)
0.300 (7.62)	157 (47)**	238 (72)**	434 (132)**	723 (220)	3,058 (932)	6,433 (1,961)
0.325 (8.26)	112 (34)**	170 (51)**	344 (104)**	678 (207)	2,604 (794)	5,396 (1,645)
0.350 (8.89)	105 (32)**	160 (48)**	327 (99)**	513 (156)	2,208 (673)	4,813 (1,467)
0.375 (9.53)	100 (30)**	151 (46)**	254 (77)**	485 (148)	1,861 (567)	3,987 (1,215)
0.400 (10.16)	67 (20)**	101 (30)**	242 (73)**	460 (140)	1,770 (540)	3,537 (1,078)
0.425 (10.80)	64 (19)**	96 (29)**	183 (55)**	336 (102)**	1,482 (452)	3,131 (954)
0.450 (11.43)	61 (18)**	92 (28)**	176 (53)**	320 (97)**	1,226 (374)	2,763 (842)
0.475 (12.07)	58 (17)**	88 (26)**	169 (51)**	306 (93)**	1,175 (358)	2,428 (740)
0.500 (12.70)	56 (17)**	85 (25)**	163 (49)**	293 (89)**	1,130 (344)	2,348 (716)
0.525 (13.34)	*	*	*	200 (60)**	922 (281)	2,056 (627)
0.550 (13.97)	*	*	*	193 (58)**	889 (271)	1,789 (545)
0.575 (14.61)	*	*	*	186 (56)**	710 (216)	1,737 (530)
0.600 (15.24)	*	*	*	179 (54)**	687 (209)	1,501 (458)
0.625 (15.88)	*	*	*	173 (52)**	665 (203)	1,461 (445)
0.650 (16.51)	*	*	*	168 (51)**	645 (196)**	1,251 (381)**
0.675 (17.15)	*	*	*	*	500 (152)**	1,220 (371)**
0.700 (17.78)	*	*	*	*	486 (148)**	1,191 (363)**
0.725 (18.42)	*	*	*	*	473 (144)**	1,009 (307)**
0.750 (19.05)	*	*	*	*	460 (140)**	986 (300)**
0.775 (19.69)	*	*	*	*	449 (136)**	965 (294)**
0.800 (20.32)	*	*	*	*	438 (133)**	805 (245)**
0.825 (20.96)	*	*	*	*	324 (98)**	789 (240)**
0.850 (21.59)	*	*	*	*	317 (96)**	773 (235)**
0.875 (22.23)	*	*	*	*	309 (94)**	759 (231)**
0.900 (22.86)	*	*	*	*	303 (92)**	621 (189)**
0.925 (23.50)	*	*	*	*	296 (90)**	610 (185)**
0.950 (24.13)	*	*	*	*	290 (88)**	599 (182)**
0.975 (24.77)	*	*	*	*	284 (86)**	589 (179)**
1.000 (25.40)	*	*	*	*	279 (85)**	579 (176)**

*Drum diameter is less than 10 times cable diameter (minimum bend radius). **Drum diameter is less than 20 times cable diameter (recommended bend radius). This chart pertains to round cable only, and may be further limited by the design of the cable.

OSP FIBER WOOD REEL DIMENSIONS							
Flange (F) in	30	36	48	60	72	84	96
Traverse (T) in	18	30	32	36	36	42	42
Drum (D) in	12	17	23	29.5	37.5	42	48
Overall Width (W) in	20	32	34	39	39	45	45
Reel Weight lbs	59	104	184	416	596	900	1,100

OSP FIBER WOOD REEL CAPACITIES							
Cable Nominal Diameter in (mm)	Cable Length ft (m)						
0.35 (8.89)	5,015 (1,529)	11,293 (3,442)	23,685 (7,219)	41,668 (12,700)			
0.40 (10.16)	3,686 (1,123)	8,411 (2,564)	17,893 (5,454)	32,687 (9,963)	46,454 (14,159)		
0.45 (11.43)	2,879 (878)	6,640 (2,024)	14,038 (4,279)	25,425 (7,750)	35,596 (10,850)		
0.50 (12.70)	2,447 (746)	5,667 (1,727)	11,578 (3,529)	20,477 (6,241)	29,187 (8,896)		
0.55 (13.97)	1,864 (568)	4,397 (1,340)	9,501 (2,896)	17,252 (5,259)	23,795 (7,253)	40,579 (12,369)	
0.60 (15.24)	1,564 (477)	3,726 (1,136)	7,728 (2,356)	14,487 (4,416)	20,240 (6,169)	33,839 (10,314)	45,134 (13,757)
0.65 (16.51)	1,304 (397)**	3,143 (958)	6,749 (2,057)	12,091 (3,685)	17,160 (5,230)	29,324 (8,938)	38,085 (11,608)
0.70 (17.78)	1,242 (378)**	2,635 (803)	5,889 (1,795)	10,003 (3,049)	14,469 (4,410)	25,357 (7,729)	33,321 (10,156)
0.75 (19.05)	1,028 (313)**	2,508 (764)	5,126 (1,562)	8,842 (2,695)	12,927 (3,940)	21,847 (6,659)	29,096 (8,869)
0.80 (20.32)	839 (255)**	2,089 (637)	4,445 (1,355)	7,806 (2,379)	11,549 (3,520)	18,723 (5,707)	25,327 (7,720)
0.85 (21.59)	806 (245)**	1,717 (523)	3,836 (1,169)	6,875 (2,095)	9,580 (2,920)	16,929 (5,160)	21,947 (6,689)
0.90 (22.86)	647 (197)**	1,647 (502)**	3,288 (1,002)	6,034 (1,839)	8,501 (2,591)	15,303 (4,664)	19,987 (6,092)
0.95 (24.13)	624 (190)**	1,333 (406)**	3,165 (965)	5,273 (1,607)	8,172 (2,491)	13,821 (4,213)	18,201 (5,548)
1.00 (25.40)	603 (183)**	1,284 (391)**	2,694 (821)	5,083 (1,549)	7,246 (2,208)	12,466 (3,800)	16,564 (5,049)
1.05 (26.67)	474 (144)**	1,240 (377)**	2,603 (793)	4,424 (1,348)	6,399 (1,951)	11,223 (3,421)	14,128 (4,306)
1.10 (27.94)	459 (139)**	983 (299)**	2,194 (669)	4,280 (1,305)	5,625 (1,714)	10,078 (3,072)	13,673 (4,168)
1.15 (29.21)	445 (135)**	951 (289)**	2,126 (648)	3,702 (1,128)	5,444 (1,659)	9,022 (2,750)	12,390 (3,777)
1.20 (30.48)	338 (103)**	922 (281)**	1,769 (539)**	3,591 (1,095)	4,762 (1,451)	8,048 (2,453)	11,202 (3,414)
1.25 (31.75)	*	895 (272)**	1,717 (523)**	3,081 (939)	4,621 (1,408)	7,818 (2,383)	10,100 (3,078)
1.30 (33.02)	*	688 (209)**	1,670 (509)**	2,995 (913)	4,016 (1,224)	6,948 (2,118)	9,075 (2,766)
1.35 (34.29)	*	669 (203)**	1,366 (416)**	2,542 (775)	3,905 (1,190)	6,764 (2,062)	8,835 (2,693)
1.40 (35.56)	*	651 (198)**	1,330 (405)**	2,476 (755)	3,366 (1,026)	5,984 (1,824)	7,913 (2,412)
1.45 (36.83)	*	634 (193)**	1,297 (395)**	2,415 (736)	3,279 (999)	5,836 (1,779)	7,719 (2,353)
1.50 (38.10)	*	619 (188)**	1,266 (385)**	2,022 (616)**	3,198 (975)	5,132 (1,564)	6,885 (2,099)

*Drum diameter is less than 10 times cable diameter (minimum bend radius). **Drum diameter is less than 20 times cable diameter (recommended bend radius). This chart pertains to round cable only, and may be further limited by the design of the cable.

Packaging

OSP Fiber/Copper Steel Reels

OSP FIBER/COPPER STEEL REEL DIMENSIONS

Reel Number	413	414	415	416	417	419	420	487
Flange (F) in	48	50	56	66	78	78	83	96
Traverse (T) in	18	25.4	25.4	25.4	25.4	30	39.8	44.5
Drum (D) in	30	30	30	36	42	42	42	42
Overall Width (W) in	24	31.375	31.375	31.625	32.375	37	46.75	52.875
Reel Weight lbs	216	250	282	360	566	610	782	1,400

OSP FIBER/COPPER STEEL REEL CAPACITIES

Cable Nominal Diameter in (mm)	Cable Length ft (m)							
0.35 (8.89)	9,866 (3,007)	15,649 (4,770)	23,894 (7,283)	27,367 (8,341)				
0.40 (10.16)	7,288 (2,221)	12,535 (3,821)	18,169 (5,538)	25,756 (7,850)	38,265 (11,663)			
0.45 (11.43)	5,701 (1,733)	9,374 (2,857)	14,342 (4,371)	19,931 (6,075)	29,604 (9,023)	35,013 (10,672)		
0.50 (12.70)	4,814 (1,467)	8,006 (2,440)	11,878 (3,620)	16,777 (5,114)	24,441 (7,450)	28,911 (8,812)		
0.55 (13.97)	3,706 (1,130)	6,312 (1,924)	9,807 (2,989)	13,382 (4,079)	20,099 (6,126)	23,778 (7,248)	37,297 (11,368)	
0.60 (15.24)	3,109 (948)	5,382 (1,640)	8,043 (2,452)	11,178 (3,407)	16,402 (4,999)	19,408 (5,916)	30,984 (9,444)	
0.65 (16.51)	2,598 (792)	4,581 (1,396)	6,528 (1,990)	9,897 (3,017)	13,961 (4,255)	16,523 (5,036)	26,766 (8,158)	
0.70 (17.78)	2,442 (744)	3,885 (1,184)	5,691 (1,735)	8,196 (2,498)	11,831 (3,606)	14,003 (4,268)	23,064 (7,030)	38,432 (11,714)
0.75 (19.05)	2,035 (620)	3,276 (999)	4,953 (1,510)	7,293 (2,223)	10,594 (3,229)	12,541 (3,822)	19,792 (6,033)	33,928 (10,341)
0.80 (20.32)	1,677 (511)	3,109 (948)	4,297 (1,310)	6,388 (1,947)	9,490 (2,893)	11,236 (3,425)	17,889 (5,453)	29,885 (9,109)
0.85 (21.59)	1,594 (486)	2,607 (795)	3,711 (1,131)	5,625 (1,715)	7,934 (2,418)	9,395 (2,864)	15,223 (4,640)	26,239 (7,998)
0.90 (22.86)	1,297 (395)	2,160 (658)	3,553 (1,083)	4,938 (1,505)	7,070 (2,155)	8,373 (2,552)	13,718 (4,181)	22,938 (6,992)
0.95 (24.13)	1,239 (378)	2,066 (630)	3,056 (931)	4,317 (1,316)	6,286 (1,916)	7,446 (2,270)	12,349 (3,764)	21,040 (6,413)
1.00 (25.40)	1,187 (362)	1,982 (604)	2,940 (896)	4,152 (1,266)	6,049 (1,844)	7,167 (2,185)	11,098 (3,383)	19,295 (5,881)
1.05 (26.67)	949 (289)	1,622 (494)	2,512 (766)	3,617 (1,102)	5,373 (1,638)	6,366 (1,931)	9,951 (3,033)	16,682 (5,085)
1.10 (27.94)	912 (278)	1,561 (476)	2,425 (739)	3,129 (954)	4,753 (1,449)	5,633 (1,717)	8,897 (2,712)	15,234 (4,643)
1.15 (29.21)	878 (268)	1,251 (381)	2,052 (625)	3,024 (922)	4,184 (1,275)	4,959 (1,512)	8,619 (2,627)	13,891 (4,234)
1.20 (30.48)	683 (208)	1,208 (368)	1,987 (606)	2,597 (792)	4,051 (1,235)	4,803 (1,464)	7,687 (2,343)	12,642 (3,853)
1.25 (31.75)	660 (201)	1,167 (356)	1,660 (506)	2,517 (767)	3,549 (1,082)	4,208 (1,283)	6,826 (2,081)	12,314 (3,753)
1.30 (33.02)	638 (194)	1,130 (344)	1,611 (491)	2,442 (744)	3,445 (1,050)	4,085 (1,245)	6,636 (2,023)	11,191 (3,411)
1.35 (34.29)	617 (188)	881 (269)	1,565 (477)	2,078 (633)	2,998 (914)	3,556 (1,084)	5,866 (1,788)	10,142 (3,091)
1.40 (35.56)	598 (182)	854 (260)	1,287 (392)	2,020 (616)	2,916 (889)	3,460 (1,055)	5,715 (1,742)	9,162 (2,793)
1.45 (36.83)	447 (136)	830 (253)	1,252 (382)	1,697 (517)	2,840 (866)	3,369 (1,027)	5,022 (1,531)	8,955 (2,729)
1.50 (38.10)	434 (132)	807 (246)	1,220 (372)	1,652 (504)	2,452 (747)	2,910 (887)	4,901 (1,494)	8,063 (2,458)
1.55 (39.37)	421 (128)	785 (239)	1,189 (362)	1,610 (491)	2,392 (729)	2,838 (865)	4,276 (1,303)	7,893 (2,406)
1.60 (40.64)	410 (125)	765 (233)	956 (292)	1,571 (479)	2,335 (712)	2,771 (845)	4,178 (1,273)	7,079 (2,158)
1.65 (41.91)	399 (122)	571 (174)	933 (284)	1,298 (396)	1,995 (608)	2,368 (722)	4,086 (1,245)	6,938 (2,115)
1.70 (43.18)	389 (119)	557 (170)	912 (278)	1,268 (386)	1,950 (594)	2,315 (706)	3,534 (1,077)	6,192 (1,887)
1.75 (44.45)	379 (116)	543 (166)	892 (272)	1,239 (378)	1,907 (581)	2,265 (690)	3,460 (1,055)	6,076 (1,852)
1.80 (45.72)	264 (80)	530 (162)	872 (266)	1,212 (369)	1,608 (490)	1,910 (582)	3,390 (1,033)	5,391 (1,643)
1.85 (46.99)	258 (79)	518 (158)	680 (207)	1,187 (362)	1,574 (480)	1,870 (570)	3,324 (1,013)	5,295 (1,614)
1.90 (48.26)	252 (77)	507 (155)	665 (203)	958 (292)	1,542 (470)	1,832 (558)	2,844 (867)	5,203 (1,586)
1.95 (49.53)	246 (75)	496 (151)	652 (199)	939 (286)	1,511 (461)	1,796 (547)	2,790 (850)	4,586 (1,398)
2.00 (50.80)	240 (73)	485 (148)	639 (195)	920 (280)	1,482 (452)	1,761 (537)	2,739 (835)	4,510 (1,375)
2.05 (52.07)	235 (72)	338 (103)	626 (191)	902 (275)	1,228 (374)	1,460 (445)	2,691 (820)	4,437 (1,352)
2.10 (53.34)	230 (70)	331 (101)	615 (187)	885 (270)	1,205 (367)	1,432 (436)	2,269 (692)	3,879 (1,182)
2.15 (54.61)	225 (69)	324 (99)	604 (184)	869 (265)	1,183 (361)	1,407 (429)	2,230 (680)	3,819 (1,164)
2.20 (55.88)	221 (67)	318 (97)	593 (181)	699 (213)	1,162 (354)	1,382 (421)	2,193 (668)	3,761 (1,146)
2.25 (57.15)	216 (66)	311 (95)	441 (134)	685 (209)	1,142 (348)	1,358 (414)	2,160 (658)	3,706 (1,129)
2.30 (58.42)	212 (65)	306 (93)	433 (132)	656 (200)	924 (282)	1,099 (335)	2,123 (647)	3,207 (977)
2.35 (59.69)	130 (40)	300 (91)	425 (130)	644 (196)	908 (277)	1,081 (329)	1,758 (536)	3,161 (963)
2.40 (60.96)	128 (39)	295 (90)	418 (127)	634 (193)	893 (272)	1,063 (324)	1,731 (528)	3,117 (950)
2.45 (62.23)	125 (38)	289 (88)	411 (125)	623 (190)	879 (268)	1,046 (319)	1,705 (520)	3,075 (937)
2.50 (63.50)	123 (37)	285 (87)	405 (123)	613 (187)	865 (264)	1,030 (314)	1,679 (512)	3,035 (925)
2.55 (64.77)	*	*	*	604 (184)	852 (260)	1,014 (309)	1,655 (504)	2,594 (791)
2.60 (66.04)	*	*	*	595 (181)	839 (256)	999 (304)	1,632 (497)	2,560 (780)
2.65 (67.31)	*	*	*	443 (135)	826 (252)	984 (300)	1,319 (402)	2,528 (771)
2.70 (68.58)	*	*	*	437 (133)	647 (197)	771 (235)	1,300 (396)	2,497 (761)
2.75 (69.85)	*	*	*	430 (131)	638 (194)	760 (232)	1,282 (391)	2,466 (752)
2.80 (71.12)	*	*	*	424 (129)	628 (191)	749 (228)	1,265 (386)	2,076 (633)
2.85 (72.39)	*	*	*	418 (127)	619 (189)	738 (225)	1,248 (380)	2,051 (625)
2.90 (73.66)	*	*	*	412 (126)	611 (186)	728 (222)	1,232 (376)	2,027 (618)
2.95 (74.93)	*	*	*	406 (124)	602 (183)	718 (219)	1,217 (371)	2,004 (611)
3.00 (76.20)	*	*	*	400 (122)	594 (181)	709 (216)	1,202 (366)	1,981 (604)
3.05 (77.47)	*	*	*	*	587 (179)	700 (213)	1,187 (362)	1,959 (597)
3.10 (78.74)	*	*	*	*	579 (176)	691 (211)	927 (283)	1,938 (591)
3.15 (80.01)	*	*	*	*	572 (174)	682 (208)	916 (279)	1,600 (488)
3.20 (81.28)	*	*	*	*	565 (172)	674 (205)	905 (276)	1,582 (482)
3.25 (82.55)	*	*	*	*	421 (128)	503 (153)	894 (272)	1,565 (477)
3.30 (83.82)	*	*	*	*	416 (127)	497 (151)	884 (269)	1,549 (472)
3.35 (85.09)	*	*	*	*	411 (125)	491 (150)	874 (266)	1,533 (467)
3.40 (86.36)	*	*	*	*	406 (124)	485 (148)	864 (263)	1,518 (463)
3.45 (87.63)	*	*	*	*	401 (122)	479 (146)	855 (261)	1,503 (458)
3.50 (88.90)	*	*	*	*	396 (121)	473 (144)	846 (258)	1,489 (454)

*Drum diameter is less than 12 times the cable diameter (minimum bend radius).

This chart applies to round cable only. Chart shows maximum calculated capacity. Actual available cable lengths may be less than capacity. Capacity is based on 2 inch clearance.

OSP COPPER WOOD REEL DIMENSIONS												
Flange (F) in	30	36	44	46	52	58	62	65	72	78	84	96
Traverse (T) in	18	18	18	25	25	25	30	30	36	40	40	40
Drum (D) in	12	14	20	20	20	20	24	32	36	39	42	48
Overall Width (W) in	21	21	21	28	29	29	34	35	41	45	46	46
Reel Weight lbs	46	64	108	165	203	245	288	368	614	699	797	1,175

OSP COPPER WOOD REEL CAPACITIES												
Cable O.D. in (mm)	Cable Length ft (m)											
0.40 (10.16)	3,723 (1,135)	5,844 (1,781)	8,738 (2,663)	13,498 (4,114)	19,316 (5,888)	25,088 (7,647)	33,422 (10,187)	32,580 (9,930)				
0.45 (11.43)	2,908 (886)	4,757 (1,450)	6,802 (2,073)	10,654 (3,247)	15,170 (4,624)	19,545 (5,957)	26,054 (7,941)	25,720 (7,839)	37,698 (11,490)			
0.50 (12.70)	2,472 (753)	3,848 (1,173)	5,576 (1,700)	8,838 (2,694)	12,337 (3,760)	16,303 (4,969)	21,714 (6,618)	21,006 (6,403)	31,148 (9,494)			
0.55 (13.97)	1,883 (574)	3,078 (938)	4,541 (1,384)	7,297 (2,224)	9,930 (3,027)	12,887 (3,928)	17,191 (5,240)	17,033 (5,192)	25,619 (7,809)	32,856 (10,015)	39,025 (11,895)	
0.60 (15.24)	1,580 (482)	2,664 (812)	3,658 (1,115)	5,975 (1,821)	8,378 (2,554)	11,105 (3,385)	14,804 (4,512)	14,431 (4,399)	20,898 (6,370)	28,333 (8,636)	32,542 (9,919)	
0.65 (16.51)	1,317 (401)	2,078 (633)	3,177 (968)	4,834 (1,473)	7,023 (2,141)	9,535 (2,906)	12,710 (3,874)	12,174 (3,711)	17,794 (5,424)	23,225 (7,079)	28,199 (8,595)	36,623 (11,163)
0.70 (17.78)	1,254 (382)	1,774 (541)	2,754 (839)	4,218 (1,286)	6,269 (1,911)	8,142 (2,482)	10,858 (3,310)	10,202 (3,110)	15,077 (4,595)	20,946 (6,384)	24,383 (7,432)	32,041 (9,766)
0.75 (19.05)	1,038 (316)	1,698 (518)	2,379 (725)	3,670 (1,119)	5,183 (1,580)	6,902 (2,104)	9,214 (2,808)	9,087 (2,770)	13,514 (4,119)	17,895 (5,454)	21,007 (6,403)	27,978 (8,528)
0.80 (20.32)	847 (258)**	1,445 (440)	2,046 (624)	3,181 (970)	4,598 (1,401)	6,221 (1,896)	8,299 (2,530)	8,090 (2,466)	12,116 (3,693)	15,185 (4,628)	18,003 (5,487)	24,353 (7,423)
0.85 (21.59)	814 (248)**	1,218 (371)	1,748 (533)	2,743 (836)	4,069 (1,240)	5,601 (1,707)	7,469 (2,277)	7,193 (2,192)	10,118 (3,084)	13,652 (4,161)	16,277 (4,961)	21,102 (6,432)
0.90 (22.86)	654 (199)**	1,174 (358)**	1,679 (512)	2,639 (804)	3,589 (1,094)	4,653 (1,418)	6,220 (1,896)	6,381 (1,945)	9,018 (2,749)	12,263 (3,738)	14,713 (4,485)	19,217 (5,857)
0.95 (24.13)	630 (192)**	980 (299)**	1,425 (434)	2,264 (690)	3,151 (960)	4,153 (1,266)	5,554 (1,693)	5,645 (1,721)	8,020 (2,444)	10,999 (3,352)	13,289 (4,050)	17,499 (5,334)
1.00 (25.40)	609 (186)**	948 (289)**	1,374 (419)	2,187 (667)	3,053 (931)	4,034 (1,230)	5,383 (1,641)	4,974 (1,516)	7,733 (2,357)	9,845 (3,001)	11,985 (3,653)	15,925 (4,854)
1.05 (26.67)	*	781 (238)**	1,155 (352)	1,861 (567)	2,670 (814)	3,593 (1,095)	4,797 (1,462)	4,361 (1,329)	6,866 (2,093)	8,787 (2,678)	10,789 (3,288)	13,583 (4,140)
1.10 (27.94)	*	758 (231)**	1,118 (341)	1,804 (550)	2,318 (707)	3,186 (971)	4,258 (1,298)	4,219 (1,286)	6,071 (1,850)	7,816 (2,382)	9,689 (2,953)	13,145 (4,007)
1.15 (29.21)	*	612 (187)**	927 (283)	1,519 (463)	2,255 (687)	2,810 (856)	3,761 (1,146)	3,682 (1,122)	5,342 (1,628)	7,573 (2,308)	8,674 (2,644)	11,911 (3,630)
1.20 (30.48)	*	*	899 (274)	1,476 (450)	1,944 (593)	2,743 (836)	3,664 (1,117)	3,571 (1,088)	5,181 (1,579)	6,715 (2,047)	7,736 (2,358)	10,769 (3,282)
1.25 (31.75)	*	*	873 (266)	1,225 (373)	1,895 (578)	2,406 (733)	3,219 (981)	3,096 (944)	4,534 (1,382)	6,523 (1,988)	7,515 (2,291)	9,708 (2,959)
1.30 (33.02)	*	*	712 (217)	1,193 (364)	1,618 (493)	2,352 (717)	3,143 (958)	3,010 (917)	4,408 (1,344)	5,759 (1,755)	6,679 (2,036)	8,723 (2,659)
1.35 (34.29)	*	*	693 (211)**	1,162 (354)**	1,580 (482)**	2,049 (625)**	2,743 (836)	2,588 (789)	3,832 (1,168)	5,052 (1,540)	6,502 (1,982)	8,492 (2,588)
1.40 (35.56)	*	*	675 (206)**	948 (289)**	1,545 (471)**	2,007 (612)**	2,683 (818)	2,520 (768)	3,732 (1,138)	4,921 (1,500)	5,751 (1,753)	7,606 (2,318)
1.45 (36.83)	*	*	537 (164)**	925 (282)**	1,304 (397)**	1,733 (528)**	2,323 (708)	2,458 (749)	3,640 (1,109)	4,799 (1,463)	5,609 (1,710)	7,419 (2,261)
1.50 (38.10)	*	*	524 (160)**	904 (276)**	1,276 (389)**	1,699 (518)**	2,274 (693)	2,091 (637)	3,138 (956)	4,182 (1,275)	4,932 (1,503)	6,618 (2,017)
1.55 (39.37)	*	*	511 (156)**	884 (269)**	1,250 (381)**	1,453 (443)**	1,950 (594)	2,041 (622)	3,064 (934)	4,085 (1,245)	4,818 (1,469)	6,465 (1,971)
1.60 (40.64)	*	*	500 (152)**	703 (214)**	1,039 (317)**	1,426 (435)**	1,911 (582)	1,995 (608)	2,995 (913)	3,528 (1,075)	4,205 (1,282)	5,737 (1,749)
1.65 (41.91)	*	*	489 (149)**	688 (210)**	1,019 (311)**	1,400 (427)**	1,875 (572)**	1,674 (510)	2,554 (778)	3,450 (1,052)	4,113 (1,254)	5,612 (1,711)
1.70 (43.18)	*	*	*	*	*	*	1,841 (561)**	1,638 (499)	2,499 (762)	3,376 (1,029)	4,026 (1,227)	4,949 (1,508)
1.75 (44.45)	*	*	*	*	*	*	1,559 (475)**	1,603 (489)	2,447 (746)	3,307 (1,008)	3,483 (1,062)	4,846 (1,477)
1.80 (45.72)	*	*	*	*	*	*	1,531 (467)**	1,571 (479)	2,058 (627)	2,825 (861)	3,412 (1,040)	4,750 (1,448)
1.85 (46.99)	*	*	*	*	*	*	1,505 (459)**	1,295 (395)	2,017 (615)	2,770 (844)	3,345 (1,020)	4,157 (1,267)
1.90 (48.26)	*	*	*	*	*	*	1,255 (383)**	1,269 (387)	1,978 (603)	2,717 (828)	3,282 (1,000)	4,078 (1,243)
1.95 (49.53)	*	*	*	*	*	*	1,235 (376)**	1,245 (379)	1,941 (592)	2,289 (698)	2,808 (856)	4,003 (1,220)
2.00 (50.80)	*	*	*	*	*	*	1,215 (370)**	1,222 (372)	1,906 (581)	2,246 (685)	2,757 (840)	3,931 (1,198)
2.05 (52.07)	*	*	*	*	*	*	*	1,201 (366)	1,574 (480)	2,206 (672)	2,708 (825)	3,410 (1,039)
2.10 (53.34)	*	*	*	*	*	*	*	966 (294)	1,546 (471)	2,168 (661)	2,661 (811)	3,350 (1,021)
2.15 (54.61)	*	*	*	*	*	*	*	949 (289)**	1,520 (463)	2,131 (650)	2,245 (684)	3,294 (1,004)
2.20 (55.88)	*	*	*	*	*	*	*	933 (284)**	1,494 (455)	1,763 (537)	2,207 (673)	3,240 (988)
2.25 (57.15)	*	*	*	*	*	*	*	917 (280)**	1,470 (448)	1,734 (529)	2,171 (662)	2,778 (847)
2.30 (58.42)	*	*	*	*	*	*	*	902 (275)**	1,185 (361)	1,706 (520)	2,137 (651)	2,734 (833)
2.35 (59.69)	*	*	*	*	*	*	*	888 (271)**	1,166 (355)	1,679 (512)	2,104 (641)	2,692 (821)
2.40 (60.96)	*	*	*	*	*	*	*	875 (267)**	1,148 (350)	1,653 (504)	1,742 (531)	2,651 (808)
2.45 (62.23)	*	*	*	*	*	*	*	680 (207)**	1,130 (344)**	1,629 (497)	1,716 (523)	2,241 (683)
2.50 (63.50)	*	*	*	*	*	*	*	670 (204)**	1,114 (340)**	1,605 (489)	1,690 (515)	2,207 (673)
2.55 (64.77)	*	*	*	*	*	*	*	660 (201)**	1,097 (334)**	1,295 (395)	1,666 (508)	2,176 (663)
2.60 (66.04)	*	*	*	*	*	*	*	650 (198)**	1,082 (330)**	1,277 (389)	1,642 (500)	2,145 (654)
2.65 (67.31)	*	*	*	*	*	*	*	641 (195)**	1,067 (325)**	1,259 (384)**	1,619 (493)	2,115 (645)
2.70 (68.58)	*	*	*	*	*	*	*	*	832 (254)**	1,241 (378)**	1,598 (487)	2,087 (636)
2.75 (69.85)	*	*	*	*	*	*	*	*	820 (250)**	1,224 (373)**	1,291 (393)	2,059 (628)
2.80 (71.12)	*	*	*	*	*	*	*	*	809 (247)**	1,208 (368)**	1,273 (388)	1,708 (521)
2.85 (72.39)	*	*	*	*	*	*	*	*	798 (243)**	1,193 (364)**	1,257 (383)**	1,685 (514)
2.90 (73.66)	*	*	*	*	*	*	*	*	788 (240)**	1,178 (359)**	1,240 (378)**	1,664 (507)
2.95 (74.93)	*	*	*	*	*	*	*	*	777 (237)**	919 (280)**	1,225 (373)**	1,643 (501)
3.00 (76.20)	*	*	*	*	*	*	*	*	768 (234)**	907 (276)**	1,210 (369)**	1,623 (495)
3.05 (77.47)	*	*	*	*	*	*	*	*	*	896 (273)**	1,195 (364)**	1,603 (489)
3.10 (78.74)	*	*	*	*	*	*	*	*	*	885 (270)**	1,181 (360)**	1,584 (483)
3.15 (80.01)	*	*	*	*	*	*	*	*	*	874 (266)**	1,167 (356)**	1,282 (391)
3.20 (81.28)	*	*	*	*	*	*	*	*	*	864 (263)**	911 (278)**	1,267 (386)
3.25 (82.55)	*	*	*	*	*	*	*	*	*	854 (260)**	900 (274)**	1,252 (382)**
3.30 (83.82)	*	*	*	*	*	*	*	*	*	*	890 (271)**	1,238 (377)**
3.35 (85.09)	*	*	*	*	*	*	*	*	*	*	880 (268)**	1,224 (373)**
3.40 (86.36)	*	*	*	*	*	*	*	*	*	*	870 (265)**	1,210 (369)**
3.45 (87.63)	*	*	*	*	*	*	*	*	*	*	860 (262)**	1,197 (365)**
3.50 (88.90)	*	*	*	*	*	*	*	*	*	*	851 (259)**	1,184 (361)**
3.55 (90.17)	*	*	*	*	*	*	*	*	*	*	*	1,172 (357)**
3.60 (91.44)	*	*	*	*	*	*	*	*	*	*	*	1,160 (354)**
3.65 (92.71)	*	*	*	*	*	*	*	*	*	*	*	1,148 (350)**

*Drum diameter is less than 12 times the cable diameter (minimum bend radius). **Drum diameter is less than 15 times the cable diameter (recommended bend radius). This chart applies to round cable only. Chart shows maximum calculated capacity. Actual available cable lengths may be less than capacity. Capacity is based on 2 inch clearance.

Terms and Conditions of Sale

For Communication and Energy Cable, Wire and Connectivity Products

1. GENERAL

These Terms and Conditions of Sale (the "Terms") govern Buyer's purchase of any communication and energy cable, wire and connectivity products (the "Products") from Superior Essex International LP ("Seller"). Buyer's purchase of the Products is limited to the terms and conditions contained herein. If these Terms are first tendered to Buyer before Buyer tenders a purchase order or similar document to Seller, these Terms are in lieu of any terms later submitted by Buyer and Seller rejects all additional or different terms and conditions of Buyer, whether confirmatory or otherwise. If Seller tenders these terms after the tender by Buyer of other terms, whether as part of a purchase order or otherwise, then Seller's acceptance of any offer by Buyer associated with Buyer's terms is expressly conditioned upon Buyer's acceptance of these Terms exclusively and to the exclusion of any proffered Buyer terms or conditions, regardless of whether these Terms contain any terms additional to, or different from, any terms proffered by Buyer. Buyer's performance, or acceptance of, or payment for, any products from Seller will constitute Buyer's acceptance of these Terms exclusively. If there is an executed written sales agreement or quotation in effect between the parties (a "Sales Agreement"), these Terms form a part thereof. Waiver by Seller of any breach, remedy or provision of these Terms shall not be construed to be a waiver of any succeeding breach or any other provision or legal remedy of Seller. The section headings of these Terms are for ease of reference only and shall not be admissible in any action to alter, modify or interpret the contents of any section hereof. The International Convention on the Sale of Goods shall have no application to any sales of Products hereunder.

2. PRICE, CHARGES AND PAYMENT

Orders are not binding upon Seller until accepted by Seller in its sole discretion. No order submitted by Buyer shall be deemed accepted by Seller unless and until either confirmed in writing by Seller or by delivery of the Product specified in the order, and then only on these Terms. Seller may modify Buyer's order where necessary as follows: (a) substituting the latest or correct part number or part description for the part number or part description set forth on the order; (b) substituting Seller's prices in effect as applicable to the order; (c) substituting an estimated delivery schedule which is reasonable (considering Seller's stock availability and lead time); and (d) correcting any stenographical or typographical error. The price of any Product sold to Buyer shall be Seller's price in effect at time of order entry. Prices for energy cable products will be adjusted at the time of shipment to reflect the closing COMEX metal price on the date prior to the ship date. Seller's current ancillary charges apply as applicable to the order such as parallel, cut, wood lagging, gas pressure, pulling eye and lift gate charges.

Fees for and relating to the Products are subject to adjustment in the event there are cost increases created by circumstances such as, but not limited to, changes in government energy policies, fuel and energy increases, metal premium or metal processing charges, chemical or material price increases, material and supply shortages, transportation and shipping costs. Any accepted order requiring special manufacturing processes, inspection, specified weight, packaging, test results, certification, etc., is subject to additional charges.

Unless otherwise agreed to by Seller in writing, Buyer agrees to pay all amounts due to Seller within thirty (30) days from the date of invoice. Overdue payments shall bear interest and service charges from the due date until paid at a rate of 1.5% (015) per month or the maximum legal rate, whichever is less, and any collection costs of Seller. FAILURE TO PAY ANY AMOUNT WHEN DUE VOIDS ALL WARRANTIES.

Credit is extended at the sole discretion of Seller. If credit has been extended, the amount of credit may be changed or credit withdrawn by Seller at any time, in its sole discretion. If a cash discount is stipulated, it is subject to Buyer's entire account being current. Any discounts given to Buyer by Seller in relation to the price of the Products are conditional upon payment for the Products being made strictly in accordance with the Sales Agreement and these Terms and to Buyer's entire account for all products purchased from Seller being current.

3. DELIVERY, TITLE, RISK OF LOSS, AND SHIPPING OF PRODUCTS

Title to and risk of loss of the Products shall pass to Buyer upon tender of such Products to Buyer at Seller's factory or a common carrier. Unless otherwise agreed by Seller in writing, shipping terms shall be Ex Works (Incoterms 2010) Seller's factory or warehouse. Seller's weights shall govern provisional and final settlement. Any shipping date provided by Seller is the Seller's best estimate and will not operate to bind Seller to ship or make deliveries on such date. All shipments shall be subject to Seller's then current shipment terms, including its Freight Policies, Freight Damage Policies, and minimum order values.

Buyer must thoroughly inspect the Products at the time of receipt for signs of damage, discrepancies or a shortage. Inspections of the Products at the time of delivery shall be commenced in the presence of the carrier's driver and Buyer shall note on the freight bill any shortages, discrepancies or damages of any Product received on the carrier's receipt. If concealed loss or damage is discovered, Buyer must report it to the carrier within 15 days from the date of receipt.

4. LIMITED WARRANTIES AND DISCLAIMERS

Seller warrants to Buyer that at the time of delivery the Products will conform substantially to Seller's specifications identified in the applicable Product Data Sheets ("Specifications"). As Buyer's sole and exclusive remedy and Seller's entire liability for any breach of the foregoing warranty, Seller will, at its sole option and expense, either refund the purchase price paid, repair or replace the Product which fails to meet this warranty upon return of the nonconforming Product; provided, Buyer notifies Seller of noncompliance in writing:

- (i) for Fiber to the Premises Closure Products ("FTTP"), within ten (10) years of delivery for external plastic and metal parts of the closure and within one (1) year of delivery for internal fiber splice, attachment and management components; and
- (ii) for all other Products, within one (1) year of delivery of such Product.

Transportation charges to and from Seller's location for the return of all nonconforming Products to Seller and their re-shipment to Buyer and the risk of loss thereof will be borne by Seller. Buyer shall use Seller's designated carrier for all re-shipments. These warranties do not apply to any Product that was not properly stored or handled by the Buyer, that was repaired or altered or was otherwise subject to abuse, neglect or improper use by Buyer or a third party, or that has any stage of processing performed on it which causes the defect. EXCEPT WITH RESPECT TO THE SPECIFIC WARRANTIES SET FORTH IN THIS SECTION 4 OF THESE TERMS, SELLER MAKES NO OTHER WARRANTIES WHATSOEVER, EXPRESS OR IMPLIED, REGARDING THE PRODUCTS OR PERFORMANCE OF ITS OBLIGATIONS HEREUNDER, AND SPECIFICALLY DISCLAIMS ANY WARRANTIES OF MERCHANTABILITY OR FITNESS FOR A PARTICULAR PURPOSE. Without limitation, under no circumstances shall Seller be liable for any costs associated with reworking, re-manufacturing or scrapping goods in which defective Product supplied by Seller was incorporated, for any costs associated with production stoppages, machinery breakdown or recall campaigns, or for any troubleshooting, administrative or engineering charges.

5. CLAIMS OF PATENT INFRINGEMENT

Seller shall conduct, at its own expense, the entire defense of any claim, suit, action or other proceedings ("Claim") brought against Buyer by a third party alleging that any Product manufactured by Seller infringes upon any United States patent of any third party, provided, however: (i) Seller receives prompt written notice of the Claim; (ii) Seller has full control of the defense and all related settlement negotiations; (iii) the Products are made according to a specification or design furnished by Seller, or if a process patent is involved, the process performed by the Products are recommended in writing by Seller; and (iv) Buyer provides Seller with all necessary assistance, information and authority to perform the defense and negotiate settlement thereof. Provided all four of the foregoing conditions are met, Seller shall, at its own expense, either settle said Claim or shall pay all damages (excluding incidental, consequential, statutory, or punitive damages) and costs awarded by the court therein. If the use or resale of such Products is finally enjoined, Seller shall, at Seller's option, procure for Buyer the right to use or resell the Products, replace them with equivalent non-infringing Products, modify them so they become non-infringing but equivalent, or remove them and refund the purchase price (less a reasonable allowance for use, damage or obsolescence). Buyer shall indemnify and hold Seller harmless from all Claims based upon (i) the use of a Product customized for Buyer based on Buyer's ideas, specifications or designs, (ii) the performance of a process performed by the Products not recommended in writing by Seller, or (iii) the use or sale of the Products delivered hereunder in combination with other products not delivered to Buyer by Seller.

6. EXCUSABLE PERFORMANCE

Seller is excused from performing any of its obligations under these Terms, any order or Sales Agreement if its performance is prevented, hindered or delayed by delays of suppliers, acts of God, nature, governments or their agencies, terrorism, war or

sabotage, compliance in good faith with any applicable foreign or domestic governmental regulation or order (whether or not it proves to be invalid), fires, riots, inability to supply or obtain products, materials, raw materials, supplies, fuel or utilities from normal sources of supply, labor disputes, work stoppages, lockouts, delays in transportation, earthquakes, floods, storms or other severe weather conditions, power shortages or power failures or any other events or circumstances beyond Seller's reasonable control (an "Event"). To the extent an Event delays Seller's performance, such performance shall be extended for as many days beyond the due date until the delay concludes; provided, however, if Seller is unable to perform any of its obligations under any order due to an Event for more than thirty (30) days, it may in its sole option terminate, without liability or penalty, any Sales Agreement, order or obligation in whole or in part. It is expressly understood that the Seller has available a limited source for the materials used by Seller in the manufacture of the Products. If there is an interference, limitation or cessation of any material from Seller's source of supply for any reason, Buyer agrees to relieve the Seller temporarily, proportionately, or permanently of liability under these Terms or any Sales Agreement or order, depending upon whether the interruption of the source of supply is a temporary interruption, a reduced delivery of materials, or a permanent cessation of supply. In the event there is a Product shortage pursuant to this section, Seller may ration and distribute such Products as it deems appropriate.

7. TAXES AND EXPORTS

Any and all taxes (not including any U.S. income or excess profit taxes attributable to Seller) which may be imposed by any taxing authority, arising from the sale, delivery or use of the Products and for which Seller may be held responsible for collection or payment, either on its own behalf or that of Buyer, shall be paid by Buyer to Seller upon Seller's demand. Export orders are subject to applicable export regulations and requirements. Buyer disclaims in favor of Seller any right or interest in, the drawback of duty, taxes or surcharges paid on imported material contained in the Products.

8. FINANCIAL RESPONSIBILITY OF BUYER

Buyer's solvency is a condition of Seller's performance and Seller may, at any time, in its sole discretion for credit reasons (including a good faith belief that a current or future payment is or may be impaired) or because of Buyer's breach of this or any other agreement with Seller, suspend or change credit terms, fix a limit on credit, require progress payments, demand payment in full of any outstanding balance, withhold shipments, demand COD or request other assurances of payment, cancel or terminate any order or agreement or repossess all Products previously delivered, which Products shall become the absolute property of Seller subject to credit therefore. Buyer grants to Seller a security interest in Products delivered hereunder to secure Buyer's obligations under these Terms and any Sales Agreement and grants to Seller the right to execute, deliver, and/or file any financing statement or do any other thing reasonably necessary to perfect Seller's security interest. Notwithstanding any other provision of these Terms, Seller reserves the right in its absolute discretion from time to time to require payment in full of the price of the Products before delivery of all or any of the Products.

Seller may terminate any order or Sales Agreement by written notice to Buyer if (i) a receiver or trustee is appointed for any of Buyer's property; (ii) Buyer is adjudicated or voluntarily becomes bankrupt or a debtor under any bankruptcy, dissolution or reorganization laws or similar law; (iii) Buyer becomes insolvent or makes an assignment for the benefit of creditors; (iv) an execution is issued pursuant to a judgment rendered against Buyer; or (v) Buyer is unable or refuses to make payment to Seller. If any order or Sales Agreement is terminated by Seller pursuant to this section, Seller shall be relieved of any further obligation to Buyer and Buyer shall reimburse Seller for its termination costs and expenses and a reasonable allowance for profit.

In addition to any right of set off or recoupment provided by law, Buyer agrees that all its accounts with Seller will be administered on a net settlement basis and that Seller may set off debits and credits, including Seller's attorney fees and costs of enforcement, against any of Buyer's accounts regardless of the basis for such debits and credits and without advance notice. In this section, "Seller" includes Seller's parent, subsidiaries and affiliates, and "Buyer" includes Buyer's parent, subsidiaries and affiliates.

9. CANCELLATIONS AND RETURNS

All orders accepted by Seller are non-cancelable unless (i) such order is cancelled in writing thirty (30) days prior to the scheduled ship date and (ii) the Products ordered were not manufactured as special or customized items. A cancellation fee of 10% of the quoted price shall apply. If paid for, cancelled Products may be returned for credit only. Return of any Product must be authorized by Seller. Seller will provide Buyer a Return Material Authorization number which must be shown on the returned Product and associated shipping documents. Standard stock items are returnable at invoice price less a 20% restocking charge, freight prepaid by Buyer to the plant of manufacture or Seller's designated location. Non-stock items and/or special items are not subject to return. All material must be returned to Seller undamaged and in the original packaging.

10. CHANGES — PROCESS, MATERIAL AND PRODUCT DESIGN

Seller continually develops and uses new processes, materials and product designs in an effort to improve its Products, while maintaining conformity to the Specifications. If Buyer's applications of the Products rely upon any performance, dimensional or constant criteria other than as required by the applicable Specifications, Buyer must conduct regular testing or evaluation of those specific Products. Seller makes no warranty or representation of any nature that any material shipped conforms to any material of like product description as may have previously been delivered to Buyer.

11. LIMITATION OF LIABILITY

IN NO EVENT WILL SELLER BE LIABLE TO BUYER FOR ANY INDIRECT, INCIDENTAL, SPECIAL, PUNITIVE, DELAY, OR CONSEQUENTIAL DAMAGES, INCLUDING WITHOUT LIMITATION, LOSS OF DIRECT OR INDIRECT PROFITS, REVENUE, OR USE, WHETHER ARISING IN CONTRACT, TORT, OR OTHERWISE, EVEN IF BUYER OR ANY OTHER PARTY HAS BEEN ADVISED OF THE POSSIBILITY OF SUCH DAMAGES. IN NO EVENT WILL SELLER'S AGGREGATE LIABILITY TO BUYER EXCEED ALL AMOUNTS ACTUALLY PAID BY BUYER TO SELLER. THESE LIMITATIONS SHALL APPLY NOTWITHSTANDING ANY FAILURE OF ESSENTIAL PURPOSE OF THE LIMITED REMEDY SET FORTH IN SECTION 4.

12. CONFIDENTIALITY

Buyer will not disclose to third persons any proprietary or confidential information of Seller concerning its business and operations, including without limitation, pricing information, for a period of five (5) years from the date such confidential information was learned or for confidential information meeting the definition of "trade secret" under applicable law, until such information is no longer a "trade secret." The obligations of confidentiality in this Section 12 do not apply to Confidential Information to the extent that the Confidential Information becomes readily ascertainable by proper means by the public other than through breach of this Section 12 by Buyer.

13. CHOICE OF LAW

These Terms and all accepted orders shall be construed in accordance with the laws of the State of Georgia, United States of America without regard to its conflict of law principles. Buyer agrees that any and all disputes with Seller, including contract and tort claims, shall be resolved in the state and federal courts situated in Georgia, and that these courts shall have the exclusive jurisdiction over all such disputes and Buyer consents to the personal jurisdiction in these courts. Any action brought by Buyer against Seller shall be within one (1) year after the cause of action arises or it shall be deemed forever waived.

14. ADDITIONAL TERMS

The provisions of these Terms and the Sales Agreement, if any, constitute the entire agreement between Buyer and Seller with respect to the matter contained herein and supersedes any prior oral or written communications, understanding, representations, proposals or agreements with respect to such subject matter. Seller may revise these Terms from time to time. These Terms may not be amended or modified by the Buyer except upon the execution of a written agreement signed by both parties indicating an intent to modify these Terms. Neither Buyer nor Seller may assign any of its rights or obligations hereunder or under any order; provided, however, that Seller shall be permitted to assign any of its rights or obligations under these Terms, Sales Agreement or any order in connection with the sale or transfer of all or substantially all of its business, whether by merger, reorganization, consolidation, transfer of assets, transfer of equity interests, or otherwise. If any provision of these Terms or a Sales Agreement is invalid, unenforceable or in conflict with any law, such provision shall be deemed severed from these Terms and/or the Sales Agreement and the validity of the remainder of these Terms and/or the Sales Agreement shall not be affected thereby. The provisions of these Terms that by their nature are reasonably intended by the parties to survive the expiration or termination of the Terms or any accepted order, including without limitation sections 4, 5, 11, 12, 13 and this section 14, shall survive the expiration or termination of the Terms or any accepted order.

Part Number Index

Part Number	Page	Part Number	Page	Part Number	Page	Part Number	Page	Part Number	Page
01-026-38	B-71	02-118-03	A-102	04-057-85	B-119	07-021-70	B-107	09-110-77	B-95
01-028-38	B-71	02-120-03	A-102	04-058-17	B-120	07-021-71	B-107	09-110-92	B-77
01-028-40	B-69	02-120-13	B-129	04-058-84	B-119	07-021-72	B-107	09-112-02	B-75
01-031-38	B-71	02-121-03	A-102	04-058-85	B-119	07-021-73	B-107	09-112-77	B-95
01-031-40	B-69	02-124-03	A-102	04-059-04	B-81	07-021-74	B-107	09-112-92	B-77
01-034-38	B-71	02-125-03	A-102	04-059-21	B-79	07-021-75	B-107	09-116-02	B-75
01-034-40	B-69	02-126-03	A-102	04-059-27	B-83	07-021-76	B-107	09-116-77	B-95
01-038-38	B-71	02-131-23	B-128	04-061-85	B-119	07-021-77	B-107	09-116-92	B-77
01-038-40	B-69	02-132-23	B-128	04-062-04	B-81	07-021-90	B-107	09-118-02	B-75
01-057-38	B-71	02-211-23	B-128	04-062-16*	B-120	07-021-98	B-107	09-118-77	B-95
01-059-38	B-71	02-221-13	B-129	04-062-21	B-79	07-021-99	B-107	09-118-92	B-77
01-059-40	B-69	02-222-13	B-129	04-062-27	B-83	07-022-08	B-107	09-120-02	B-75
01-062-38	B-71	02-223-13	B-129	04-062-84	B-119	07-022-11	B-107	09-120-77	B-95
01-062-40	B-69	02-224-13	B-129	04-065-04	B-81	07-022-12	B-107	09-120-92	B-77
01-065-38	B-71	02-311-23	B-128	04-065-21	B-79	09-026-02	B-75	09-121-02	B-75
01-065-40	B-69	02-350-23	B-128	04-065-27	B-83	09-028-02	B-75	09-121-77	B-95
01-069-38	B-71	02-360-23	B-128	04-067-16*	B-120	09-031-02	B-75	09-121-92	B-77
01-069-40	B-69	02-361-23	B-128	04-069-04	B-81	09-031-77	B-95	09-124-02	B-75
01-073-38	B-71	02-362-23	B-128	04-069-21	B-79	09-031-92	B-77	09-124-77	B-95
01-073-40	B-69	02-401-13	B-129	04-069-27	B-83	09-034-02	B-75	09-124-92	B-77
01-075-40	B-69	02-409-13	B-129	04-073-04	B-81	09-034-77	B-95	09-125-02	B-75
01-077-40	B-69	02-431-10	A-134	04-073-21	B-79	09-034-92	B-77	09-125-77	B-95
01-092-38	B-71	02-450-13	B-129	04-073-27	B-83	09-038-02	B-75	09-125-92	B-77
01-094-38	B-71	02-513-13*	B-129	04-075-04	B-81	09-038-77	B-95	09-126-02	B-75
01-094-40	B-69	02-514-13*	B-129	04-075-21	B-79	09-038-92	B-77	09-126-92	B-77
01-097-38	B-71	02-702-13*	B-129	04-075-27	B-83	09-057-02	B-75	09-145-77	B-95
01-097-40	B-69	02-706-13*	B-129	04-077-04	B-81	09-057-05	B-75	09-147-77	B-95
01-100-38	B-71	02-813-10	A-134	04-077-21	B-79	09-057-92	B-77	09-151-02	B-75
01-100-40	B-69	02-815-10	A-134	04-081-04	B-81	09-059-02	B-75	09-151-77	B-95
01-104-38	B-71	02-820-10	A-134	04-081-21	B-79	09-059-05	B-73	09-153-02	B-75
01-104-40	B-69	02-832-10	A-134	04-083-21	B-79	09-059-92	B-77	09-153-77	B-95
01-108-38	B-71	02-840-10	A-134	04-091-16	B-120	09-062-02	B-75	09-155-02	B-75
01-108-40	B-69	02-841-10	A-134	04-092-04	B-81	09-062-05	B-73	09-155-77	B-95
01-110-40	B-69	02-D02-13	B-129	04-092-21	B-79	09-062-77	B-95	09-156-02	B-75
01-112-40	B-69	02-D06-13	B-129	04-092-27	B-83	09-062-92	B-77	09-156-77	B-95
01-116-40	B-69	02-D30-13	B-129	04-094-04	B-81	09-065-02	B-75	09-157-02	B-75
01-118-40	B-69	02-E02-13	B-129	04-094-16	B-120	09-065-05	B-73	09-157-77	B-95
01-120-40	B-69	02-E12-13	B-129	04-094-21	B-79	09-065-77	B-95	09-158-77	B-95
01-121-40	B-69	02-G11-13	B-129	04-094-27	B-83	09-065-92	B-77	09-159-02	B-75
01-124-40	B-69	02-G16-13	B-129	04-097-04	B-81	09-069-02	B-75	09-159-77	B-95
02-001-13	B-129	02-G50-13	B-129	04-097-21	B-79	09-069-77	B-95	09-164-02	B-75
02-002-13	B-129	02-H12-13	B-129	04-097-27	B-83	09-069-92	B-77	10-002-17	B-113
02-004-13	B-129	02-H13-13	B-129	04-097-31	A-97	09-073-02	B-75	10-002-34	B-108
02-005-13	B-129	04-001-54	A-93	04-097-37	A-97	09-073-77	B-95	10-002-34	B-118
02-006-13	B-129	04-001-55	A-94	04-097-85	B-119	09-073-92	B-77	10-003-17	B-113
02-006-13	B-129	04-001-58	A-92	04-098-85	B-119	09-075-02	B-75	10-004-17	B-113
02-006-23	B-128	04-001-62	A-95	04-100-04	B-81	09-075-77	B-95	10-006-17	B-113
02-010-23	B-128	04-001-63	A-95	04-100-21	B-79	09-075-92	B-77	10-006-19	B-113
02-011-23	B-128	04-001-64	A-93	04-100-27	B-83	09-077-02	B-75	10-006-34	B-108
02-020-23	B-128	04-001-65	A-94	04-100-31	A-97	09-077-77	B-95	10-012-17	B-113
02-021-23	B-128	04-001-68	A-92	04-100-37	A-97	09-077-92	B-77	10-012-19	B-113
02-022-23	B-128	04-001-A2	A-95	04-101-85	B-119	09-081-02	B-75	10-012-35	B-108
02-024-23	B-128	04-001-A3	A-95	04-104-04	B-81	09-081-77	B-95	10-012-35	B-118
02-031-23	B-128	04-001-A4	A-93	04-104-21	B-79	09-081-92	B-77	10-016-06	B-112
02-032-13	B-129	04-001-A5	A-94	04-104-27	B-83	09-083-02	B-75	10-026-06	B-112
02-032-23	B-128	04-023-85	B-119	04-104-31	A-97	09-083-77	B-95	10-040-29	B-114
02-033-23	B-128	04-025-85	B-119	04-104-37	A-97	09-083-92	B-77	10-061-29	B-114
02-041-13	B-129	04-026-21	B-79	04-108-04	B-81	09-085-02	B-75	10-102-34	B-108
02-050-13	B-129	04-026-27	B-83	04-108-21	B-79	09-087-02	B-75	10-102-34	B-118
02-050-23	B-128	04-028-04	B-81	04-108-27	B-83	09-087-02	B-75	10-102-35	B-108
02-051-13	B-129	04-028-21	B-79	04-110-04	B-81	09-092-05	B-73	10-102-35	B-118
02-052-13	B-129	04-028-27	B-83	04-110-21	B-79	09-092-92	B-77	10-106-34	B-108
02-053-13	B-129	04-031-04	B-81	04-110-27	B-83	09-094-02	B-75	10-106-34	B-118
02-054-13	B-129	04-031-21	B-79	04-112-04	B-81	09-094-05	B-73	10-116-06	B-112
02-097-03	A-102	04-031-27	B-83	04-112-21	B-79	09-094-92	B-77	10-206-34	B-108
02-097-61	A-134	04-034-04	B-81	04-112-27	B-83	09-097-02	B-75	10-206-34	B-118
02-098-61	A-134	04-034-21	B-79	04-116-04	B-81	09-097-05	B-73	10-212-35	B-108
02-100-03	A-102	04-034-27	B-83	04-116-21	B-79	09-097-77	B-95	10-212-35	B-118
02-100-61	A-134	04-038-04	B-81	04-116-27	B-83	09-097-92	B-77	10-261-38	B-108
02-102-13	B-129	04-038-27	B-83	04-118-04	B-81	09-100-02	B-75	10-261-38	B-118
02-104-03	A-102	04-052-17	B-120	04-118-21	B-79	09-100-05	B-73	10-262-38	B-108
02-104-61	A-134	04-052-84	B-119	04-118-27	B-83	09-100-77	B-95	10-262-38	B-118
02-106-03	A-102	04-053-17	B-120	04-120-04	B-81	09-100-92	B-77	10-265-38	B-108
02-108-03	A-102	04-053-84	B-119	04-120-21	B-79	09-104-02	B-75	10-265-38	B-118
02-110-03	A-102	04-055-17	B-120	04-120-27	B-83	09-104-05	B-73	10-265-38	B-108
02-110-23	B-128	04-055-84	B-119	04-121-04	B-81	09-104-77	B-95	10-281-38	B-108
02-111-13	B-129	04-056-17	B-120	04-121-21	B-79	09-104-92	B-77	10-281-38	B-118
02-111-23	B-128	04-056-84	B-119	04-124-04	B-81	09-108-02	B-75	10-284-38	B-108
02-112-03	A-102	04-057-04	B-81	04-124-21	B-79	09-108-05	B-73	10-285-38	B-108
02-113-13	B-129	04-057-16*	B-120	04-124-27	B-83	09-108-77	B-95	10-285-38	B-118
02-113-23	B-128	04-057-17	B-120	04-A01-55	A-96	09-108-92	B-77	10-503-34	B-108
02-114-13	B-129	04-057-21	B-79	07-021-68	B-107	09-110-02	B-75	10-503-34	B-118
02-116-03	A-102	04-057-27	B-83	07-021-69	B-107	09-110-05	B-73	10-921-38	B-108

Part Number Index

Part Number	Page	Part Number	Page	Part Number	Page	Part Number	Page	Part Number	Page
10-921-38	B-118	12-001-04	B-127	12-112-13	A-135	12-907-04	B-127	19-156-01	B-91
10-923-38	B-108	12-001-11	A-135	12-121-04	B-127	12-908-04	B-127	19-157-01	B-91
10-923-38	B-118	12-001-12	A-135	12-122-04	B-127	12-910-04	B-127	19-158-01	B-91
11-001-02	B-129	12-001-13	A-135	12-123-04	B-127	13006Dx0y	B-33	19-159-01	B-91
11-001-03	B-129	12-002-11	A-135	12-140-03	B-126	13006xx0y	B-34	19-161-01	B-91
11-002-87 ³	A-101	12-003-12	A-135	12144xD0y	B-4	13012Dx0y	B-33	19-162-01	B-91
11-002-88 ³	A-101	12-003-13	A-135	12144xDMy	B-16	13012xx0y	B-34	19-164-01	B-91
11-002-89 ³	A-101	12-004-08	B-115	12144xx0y	B-10	13024Dx0y	B-33	19-167-01	B-91
11-003-12 ³	A-101	12-004-11	A-135	12144xxMy	B-20	13024xx0y	B-34	1A006xDMy	B-17
11-003-13 ³	A-101	12-004-12	A-135	12192xx0y	B-10	13036Dx0y	B-33	1A006xx0y	B-11
11-003-30	B-61	12-005-12	A-135	12-201-15	A-136	13036xx0y	B-34	1A006xxMy	B-21
11-003-45	B-124	12-005-13	A-135	12-202-15	A-136	13048Dx0y	B-33	1A012xD0y	B-5
11-003-46	B-124	12-006-08	B-115	12-202-37 ¹	A-101	13048xx0y	B-34	1A012xDMy	B-17
11-003-53	B-124	12006xx0y	B-10	12-203-15	A-136	13072Dx0y	B-33	1A012xx0y	B-11
11-003-65	B-109	12-007-08	B-115	12-203-37 ¹	A-101	13072xx0y	B-34	1A012xxMy	B-21
11-003-66	B-109	12-008-08	B-115	12-204-15	A-136	13096Dx0y	B-33	1A024xD0y	B-5
11-003-91 ³	A-101	12-009-08	B-115	12-204-37 ¹	A-101	13096xx0y	B-34	1A024xDMy	B-17
11-003-92 ³	A-101	12-010-08	B-115	12-205-15	A-136	13144Dx0y	B-33	1A024xx0y	B-11
11-005-90	B-128	12-011-04	B-127	12-206-15	A-136	13144xx0y	B-34	1A024xxMy	B-21
11006xN0y	B-32	12-012-04	B-127	12-206-32 ²	A-101	13216Dx0y	B-33	1A036xD0y	B-5
11006xx0y	B-8	12012xD0y	B-4	12-207-15	A-136	13216xx0y	B-34	1A036xDMy	B-17
11012KDky	B-22	12012xDMy	B-16	12-208-15	A-136	13288Dx0y	B-33	1A036xx0y	B-11
11012KDLy	B-22	12012xx0y	B-10	12-209-15	A-136	13288xx0y	B-34	1A036xxMy	B-21
11012xD0y	B-2	12012xxMy	B-20	12-210-15	A-136	18-041-36	A-99	1A048xD0y	B-5
11012xDMy	B-14	12-013-08	B-109	12-211-15	A-136	18-042-13	A-99	1A048xDMy	B-17
11012xN0y	B-32	12-014-08	B-109	12-212-32 ²	A-101	18-042-33	A-99	1A048xx0y	B-11
11012xx0y	B-8	12-015-08	B-109	12-213-32 ²	A-101	18-141-13	A-99	1A048xxMy	B-21
11012xxMy	B-18	12-016-04	B-127	12-214-37 ¹	A-101	18-141-33	A-99	1A072xD0y	B-5
11018xx0y	B-8	12-018-04	B-127	12-216-15	A-136	18-141-36	A-99	1A072xDMy	B-17
11024C02Q	B-66	12018xx0y	B-10	12216xD0y	B-4	18-241-13	A-99	1A072xx0y	B-11
11024D01Q	B-66	12-019-08	B-115	12216xDMy	B-16	18-241-23	A-99	1A072xxMy	B-21
11024xD0y	B-2	12-021-09	B-110	12216xx0y	B-10	18-241-26	A-99	1A096xD0y	B-5
11024xDMy	B-14	12-022-08	B-115	12216xxMy	B-20	18-241-33	A-99	1A096xDMy	B-17
11024xN0y	B-32	12-022-09	B-110	12-217-T5	A-137	18-241-36	A-99	1A096xx0y	B-11
11024xx0y	B-8	12-023-08	B-115	12-218-T5	A-137	18-241-43	A-99	1A096xxMy	B-21
11024xxMy	B-18	12-024-08	B-115	12-220-03	B-126	18-241-46	A-99	1A120xDMy	B-17
11036xD0y	B-2	12024D02Q	B-66	12-262-01	B-125	18-241-56	A-99	1A120xxMy	B-21
11036xN0y	B-32	12024xD0y	B-4	12288xD0y	B-4	18-341-13	A-99	1A144xD0y	B-5
11036xx0y	B-8	12024xDMy	B-16	12288xDMy	B-16	18-341-33	A-99	1A144xx0y	B-11
11048xD0y	B-2	12024xx0y	B-10	12288xx0y	B-10	18-341-36	A-99	1A216xD0y	B-5
11048xDMy	B-14	12024xxMy	B-20	12288xxMy	B-20	18-341-46	A-99	1A216xx0y	B-11
11048xN0y	B-32	12-025-08	B-115	12-301-07	B-117	18-475-13	A-99	1A288xD0y	B-5
11048xx0y	B-8	12-026-08	B-115	12-302-07	B-117	18-475-33	A-99	1A288xx0y	B-11
11048xxMy	B-18	12-031-08	B-115	12-303-07	B-117	18-475-36	A-99	1C006xx0y	B-13
11060KDky	B-22	12-031-12	A-135	12-303-13	A-135	18-475-46	A-99	1C012xD0y	B-7
11060KDLy	B-22	12-032-13	A-135	12-303-62 ^{3*}	A-101	18-499-13	A-99	1C012xx0y	B-13
11060xD0y	B-2	12-033-13	A-135	12-304-07	B-117	18-499-33	A-99	1C024xD0y	B-7
11060xx0y	B-8	12-034-13	A-135	12-304-13	A-135	18-499-36	A-99	1C024xx0y	B-13
11072KDky	B-22	12-035-13	A-135	12-305-07	B-117	18-499-46	A-99	1C036xD0y	B-7
11072KDLy	B-22	12036xD0y	B-4	12-305-13	A-135	18-579-13	A-99	1C036xx0y	B-13
11072xD0y	B-2	12036xx0y	B-10	12-311-13	A-135	18-579-33	A-99	1C048xD0y	B-7
11072xDMy	B-14	12-041-09	B-110	12-311-36	B-125	18-579-36	A-99	1C048xx0y	B-13
11072xN0y	B-32	12-043-09	B-110	12-313-13	A-135	18-599-13	A-99	1C072xD0y	B-7
11072xx0y	B-8	12048xD0y	B-4	12-318-13	A-135	18-599-33	A-99	1C072xx0y	B-13
11072xxMy	B-18	12048xDMy	B-16	12-322-36	B-125	18-599-36	A-99	1C096xD0y	B-7
11096KDky	B-22	12048xx0y	B-10	12-331-36	B-125	18-789-13	A-99	1C096xx0y	B-13
11096KDLy	B-22	12048xxMy	B-20	12-401-15	A-136	18-789-33	A-99	1C144xD0y	B-7
11096xD0y	B-2	12072xD0y	B-4	12-402-15	A-136	18-799-36	A-99	1C144xx0y	B-13
11096xDMy	B-14	12072xDMy	B-16	12-402-37 ¹	A-101	18-799-46	A-99	1D006xx0y	B-12
11096xN0y	B-32	12072xx0y	B-10	12-403-13	A-135	18-872-13	A-99	1D012xx0y	B-12
11096xx0y	B-8	12072xxMy	B-20	12-403-37 ¹	A-101	18-872-33	A-99	1D024xD0y	B-6
11096xxMy	B-18	12096xD0y	B-4	12-404-37 ¹	A-101	18-872-46	A-99	1D024xx0y	B-12
11144KDky	B-22	12096xDMy	B-16	12-406-13	A-135	18-A99-33	A-99	1D036xD0y	B-6
11144KDLy	B-22	12096xx0y	B-10	12-412-32 ²	A-101	18-A99-36	A-99	1D036xx0y	B-12
11144xD0y	B-2	12096xxMy	B-20	12-414-32 ²	A-101	18-B99-33	A-99	1D048xD0y	B-6
11144xDMy	B-14	12-101-04	B-127	12-414-52 ²	A-101	18-B99-36	A-99	1D048xx0y	B-12
11144xN0y	B-32	12-101-07	B-117	12-415-52 ²	A-101	18-B99-46	A-99	1D072xD0y	B-6
11144xx0y	B-8	12-101-13	A-135	12-416-52 ²	A-101	18-C99-33	A-99	1D072xx0y	B-12
11144xxMy	B-18	12-102-04	B-127	12-417-52 ²	A-101	18-C99-36	A-99	1D096xD0y	B-6
11216KDky	B-22	12-102-13	A-135	12-501-07	B-117	18-D99-33	A-99	1D096xx0y	B-12
11216KDLy	B-22	12-103-13	A-135	12-501-13	A-135	19-083-01	B-91	1D0y2xD0y	B-6
11216xD0y	B-2	12-104-04	B-127	12-519-08	B-115	19-085-01	B-91	1D144xD0y	B-6
11216xDMy	B-14	12-104-13	A-135	12-642-01	B-125	19-116-01	B-107	1D144xx0y	B-12
11216xN0y	B-32	12-105-04	B-127	12-801-08	B-116	19-116-01	B-91	1D216xD0y	B-6
11216xx0y	B-8	12-105-13	A-135	12-802-08	B-116	19-118-01	B-91	1D216xx0y	B-12
11216xxMy	B-18	12-106-04	B-127	12-805-62 ^{3*}	A-101	19-120-01	B-91	1D288xx0y	B-12
11288KDky	B-22	12-106-13	A-135	12-842-01	B-125	19-121-01	B-91	1F0063111	B-23
11288KDLy	B-22	12-107-04	B-127	12-901-04	B-127	19-124-01	B-91	1F0063121	B-24
11288xD0y	B-2	12-107-13	A-135	12-902-04	B-127	19-125-01	B-91	1F006314L	B-25
11288xDMy	B-14	12-108-13	A-135	12-903-04	B-127	19-126-01	B-91	1F012314L	B-25
11288xN0y	B-32	12-109-13	A-135	12-904-04	B-127	19-151-01	B-91	1F0123T11	B-23
11288xx0y	B-8	12-111-04	B-127	12-905-04	B-127	19-153-01	B-91	1F0123T21	B-24
11288xxMy	B-18	12-112-04	B-127	12-906-04	B-127	19-155-01	B-91	1F024314L	B-25

Part Number	Page	Part Number	Page	Part Number	Page	Part Number	Page	Part Number	Page
1F0243T11	B-23	20-069-05	B-87	22-110-83	B-97	27-155-19	B-92	2F-A3x-44	A-121
1F0243T21	B-24	20-069-20	B-89	22-112-83	B-97	27-157-19	B-92	2F-A4x-31	A-119
1F0483111	B-23	20-069-42	B-85	22-116-83	B-97	27-159-19	B-92	2F-A4x-32	A-121
1F0483121	B-24	20-069-43	B-88	22-118-83	B-97	2F-11x-91	A-113	2F-A4x-43	A-119
1F048314L	B-25	20-073-05	B-87	22-120-83	B-97	2F-11x-92	A-115	2F-A4x-44	A-121
1F0723111	B-23	20-073-42	B-85	22-121-83	B-97	2F-11x-93	A-113	2F-A5x-31	A-119
1F0723121	B-24	20-075-05	B-87	22-124-83	B-97	2F-11x-94	A-115	2F-A5x-32	A-121
1F0963111	B-23	20-075-42	B-85	22-125-83	B-97	2F-12x-91	A-113	2F-A5x-43	A-119
1F0963121	B-24	20-077-05	B-87	22-145-83	B-97	2F-12x-92	A-115	2F-A5x-44	A-121
1F096314L	B-25	20-077-42	B-85	22-147-83	B-97	2F-12x-93	A-113	2F-A6x-31	A-119
1F1443111	B-23	20-081-05	B-87	22-151-83	B-97	2F-12x-94	A-115	2F-A6x-32	A-121
1F1443121	B-24	20-081-42	B-85	22-153-83	B-97	2F-13x-91	A-113	2F-A6x-43	A-119
1F144314L	B-25	20-083-05	B-87	22-155-83	B-97	2F-13x-92	A-115	2F-A6x-44	A-121
1F2163111	B-23	20-083-42	B-85	22-156-83	B-97	2F-13x-93	A-113	2F-A7x-31	A-119
1F2163121	B-24	20-097-05	B-87	22-157-83	B-97	2F-13x-94	A-115	2F-A7x-32	A-121
1F2883111	B-23	20-097-20	B-89	22-158-83	B-97	2F-14x-91	A-113	2F-A7x-43	A-119
1F2883121	B-24	20-097-42	B-85	22-159-83	B-97	2F-14x-92	A-115	2F-A7x-44	A-121
1F288314L	B-25	20-097-43	B-88	22-161-83	B-97	2F-14x-93	A-113	2F-B1x-31	A-119
1G006xDMy	B-15	20-100-05	B-87	22-162-83	B-97	2F-14x-94	A-115	2F-B1x-32	A-121
1G006xx0y	B-9	20-100-20	B-89	24018x101	A-25	2F-15x-93	A-113	2F-B1x-43	A-119
1G006xxMy	B-19	20-100-42	B-85	24018xG01	A-25	2F-21x-91	A-113	2F-B1x-44	A-121
1G012xD0y	B-3	20-100-43	B-88	24024x101	A-25	2F-21x-92	A-115	2F-B2x-31	A-119
1G012xDMy	B-15	20-104-05	B-87	24024xG01	A-25	2F-21x-93	A-113	2F-B2x-32	A-121
1G012xx0y	B-9	20-104-20	B-89	24030x101	A-25	2F-21x-94	A-115	2F-B2x-43	A-119
1G012xxMy	B-19	20-104-42	B-85	24030xG01	A-25	2F-22x-91	A-113	2F-B2x-44	A-121
1G024xD0y	B-3	20-104-43	B-88	24036x101	A-25	2F-22x-92	A-115	2F-B3x-31	A-119
1G024xDMy	B-15	20-108-05	B-87	24036xG01	A-25	2F-22x-93	A-113	2F-B3x-32	A-121
1G024xx0y	B-9	20-108-20	B-89	24048x101	A-25	2F-22x-94	A-115	2F-B3x-43	A-119
1G024xxMy	B-19	20-108-42	B-85	24048xG01	A-25	2F-23x-91	A-113	2F-B3x-44	A-121
1G036xD0y	B-3	20-108-43	B-88	24060x101	A-25	2F-23x-92	A-115	2F-C1x-31	A-119
1G036xDMy	B-15	20-110-05	B-87	24060xG01	A-25	2F-23x-93	A-113	2F-C1x-32	A-121
1G036xx0y	B-9	20-110-42	B-85	24072x101	A-25	2F-23x-94	A-115	2F-C1x-43	A-119
1G036xxMy	B-19	20-112-05	B-87	24072xG01	A-25	2F-31x-91	A-113	2F-C1x-44	A-121
1G048xD0y	B-3	20-112-42	B-85	24-417-83	B-99	2F-31x-92	A-115	2F-C2x-31	A-119
1G048xDMy	B-15	20-116-05	B-87	24-440-05	B-99	2F-31x-93	A-113	2F-C2x-32	A-121
1G048xx0y	B-9	20-116-42	B-85	24-440-83	B-99	2F-31x-94	A-115	2F-C2x-43	A-119
1G048xxMy	B-19	20-118-05	B-87	24-456-05	B-99	2F-32x-91	A-113	2F-C2x-44	A-121
1G072xD0y	B-3	20-118-42	B-85	24-456-83	B-99	2F-32x-92	A-115	2F-C3x-31	A-119
1G072xDMy	B-15	20-120-05	B-87	24-493-05	B-99	2F-32x-93	A-113	2F-C3x-32	A-121
1G072xx0y	B-9	20-120-42	B-85	24-564-05	B-99	2F-32x-94	A-115	2F-C3x-43	A-119
1G072xxMy	B-19	20-121-05	B-87	25-020-79	B-121	2F-33x-91	A-113	2F-C3x-44	A-121
1G096xD0y	B-3	20-121-42	B-85	25-021-79	B-121	2F-33x-92	A-115	2F-C4x-31	A-119
1G096xDMy	B-15	20-124-05	B-87	25-061-86	B-123	2F-33x-93	A-113	2F-C4x-32	A-121
1G096xx0y	B-9	20-124-42	B-85	25-062-86	B-123	2F-33x-94	A-115	2F-C4x-43	A-119
1G096xxMy	B-19	20-145-05	B-87	25-063-79	B-121	2F-41x-91	A-113	2F-C4x-44	A-121
1G120xDMy	B-15	20-145-20	B-89	25-063-86	B-123	2F-41x-92	A-115	2F-C5x-31	A-119
1G120xx0y	B-9	20-145-42	B-85	25-064-79	B-121	2F-41x-93	A-113	2F-C5x-32	A-121
1G144xD0y	B-3	20-147-05	B-87	25-064-86	B-123	2F-41x-94	A-115	2F-C5x-43	A-119
1G144xx0y	B-9	20-147-42	B-85	25-069-86	B-123	2F-42x-91	A-113	2F-C5x-44	A-121
1G216xD0y	B-3	20-151-05	B-87	25-078-86	B-123	2F-42x-94	A-115	2F-C6x-31	A-119
1G216xx0y	B-9	20-151-42	B-85	25-154-86	B-123	2F-51x-31	A-119	2F-C7x-32	A-121
1G288xD0y	B-3	20-153-05	B-87	25-257-86	B-123	2F-51x-32	A-121	2F-C7x-33	A-121
1G288xx0y	B-9	20-153-42	B-85	25-351-79	B-121	2F-51x-43	A-119	2F-C7x-43	A-119
1H006xx0y	B-39	20-155-05	B-87	25-351-86	B-123	2F-51x-44	A-121	2F-C7x-44	A-121
1H012xx0y	B-39	20-155-42	B-85	25-353-86	B-123	2F-51x-91	A-113	2F-D1x-31	A-119
1H024xx0y	B-39	20-156-05	B-87	25-354-79	B-121	2F-51x-92	A-115	2F-D1x-32	A-121
1H036xx0y	B-39	20-156-42	B-85	25-355-79	B-121	2F-51x-93	A-113	2F-D1x-43	A-119
1H048xx0y	B-39	20-157-05	B-87	25-360-79	B-121	2F-51x-94	A-115	2F-D1x-44	A-121
1H072xx0y	B-39	20-157-42	B-85	25-360-86	B-123	2F-52x-31	A-119	2F-D2x-31	A-119
1H096xx0y	B-39	20-158-05	B-87	25-361-79	B-121	2F-52x-32	A-121	2F-D2x-32	A-121
1H144xx0y	B-39	20-158-42	B-85	25-525-86	B-123	2F-52x-43	A-119	2F-D2x-43	A-119
1H216xx0y	B-39	20-159-05	B-87	25-527-86	B-123	2F-52x-44	A-121	2F-D2x-44	A-121
1N012xx0y	B-40	20-161-05	B-87	25-530-86	B-123	2F-52x-91	A-113	2F-D3x-31	A-119
1N024xx0y	B-40	21-062-48	B-93	25-547-79	B-121	2F-52x-92	A-115	2F-D3x-32	A-121
1N036xx0y	B-40	21-065-48	B-93	25-549-86	B-123	2F-52x-93	A-113	2F-D3x-43	A-119
1N048xx0y	B-40	22-031-83	B-97	25-552-79	B-121	2F-52x-94	A-115	2F-D3x-44	A-121
20-031-05	B-87	22-034-83	B-97	25-553-79	B-121	2F-53x-31	A-119	2F-E1x-31	A-119
20-031-42	B-85	22-038-83	B-97	25-554-86	B-123	2F-53x-43	A-119	2F-E1x-32	A-121
20-034-05	B-87	22-042-83	B-97	25-555-79	B-121	2F-53x-91	A-113	2F-E1x-43	A-119
20-034-42	B-85	22-044-83	B-97	25-653-79	B-121	2F-53x-92	A-115	2F-E1x-44	A-121
20-038-05	B-87	22-062-83	B-97	25-654-79	B-121	2F-53x-93	A-113	2F-E2x-31	A-119
20-038-42	B-85	22-065-83	B-97	25-654-86	B-123	2F-53x-94	A-115	2F-E2x-32	A-121
20-042-42	B-85	22-069-83	B-97	25-658-79	B-121	2F-A1x-31	A-119	2F-E2x-43	A-119
20-044-42	B-85	22-073-83	B-97	25-662-79	B-121	2F-A1x-32	A-121	2F-E2x-44	A-121
20-046-42	B-85	22-075-83	B-97	25-663-79	B-121	2F-A1x-43	A-119	2F-E3x-31	A-119
20-062-05	B-87	22-077-83	B-97	25-667-86	B-123	2F-A1x-44	A-121	2F-E3x-32	A-121
20-062-20	B-89	22-081-83	B-97	25-680-86	B-123	2F-A2x-31	A-119	2F-E3x-43	A-119
20-062-42	B-85	22-083-83	B-97	25-681-79	B-121	2F-A2x-32	A-121	2F-E3x-44	A-121
20-062-43	B-88	22-085-83	B-97	25-682-86	B-123	2F-A2x-43	A-119	2F-F1x-31	A-119
20-065-05	B-87	22-097-83	B-97	25-685-86	B-123	2F-A2x-44	A-121	2F-F1x-32	A-121
20-065-20	B-89	22-100-83	B-97	27-145-19	B-92	2F-A3x-31	A-119	2F-F1x-43	A-119
20-065-42	B-85	22-104-83	B-97	27-151-19	B-92	2F-A3x-32	A-121	2F-F1x-44	A-121
20-065-43	B-88	22-108-83	B-97	27-153-19	B-92	2F-A3x-43	A-119	2F-F2x-31	A-119

All information, content, data, specifications, packaging and part numbers detailed herein are subject to change. For the most up-to-date information, please visit SuperiorEssex.com. Purchase of this product is subject exclusively to the then current Superior Essex International LP Terms and Conditions of Sale for Communications and Energy Cable, Wire and Connectivity Products, which can be found on our website, SuperiorEssex.com, or provided to you upon request.

Part Number Index

Part Number	Page	Part Number	Page	Part Number	Page	Part Number	Page	Part Number	Page
2F-F2x-43	A-119	44024HGG1	A-31	53012K01Q	D-6	55-G99-23	A-131	6H-272-xA	A-40
2F-F2x-44	A-121	44024HKA1	A-31	53012xx0y	B-38	55-G99-26	A-131	6H-272-xB	A-40
33001x101	A-3	44024x101	A-19	53024K01Q	D-6	55-H99-26	A-131	6R001x101	B-51
33001yG01	A-3	44024xK01	A-17	53024xx0y	B-38	55-H99-47	A-132	6R002x101	B-51
33002x1zz	A-3	44024yG01	A-19	53036xx0y	B-38	55-K99-26	A-131	6R002x1BB	B-51
33002yGzz	A-3	44024yK01	A-17	53048J01Q	D-6	55-L99-26	A-131	6R002x1RG	B-51
33004x1zz	A-3	44030x101	A-19	53048xx0y	B-38	55-N99-46	A-132	6R004x1BB	B-51
33004yGzz	A-3	44030yG01	A-19	53072xx0y	B-38	55-N99-47	A-132	6R004x1RG	B-51
34001x101	A-3	44036HGA1	A-31	53096xx0y	B-38	55-P99-23	A-131	6R012x1BB	B-51
34001yG01	A-3	44036HGC1	A-31	54-246-xA	A-50	55-P99-26	A-131	6R012x1RG	B-51
34002x1zz	A-3	44036x101	A-19	54-246-xB	A-50	55-P99-46	A-132	6S001x101	B-50
34002yGzz	A-3	44036xG01	A-19	54-272-xA	A-50	55-Q99-26	A-131	6S002x101	B-50
34004x1zz	A-3	44036yE01	A-19	54-272-xB	A-50	55-R99-26	A-131	6S002x1BB	B-50
34004yGzz	A-3	44036yG01	A-19	55-021-23	A-131	55-R99-47	A-132	6S002x1RG	B-50
43006x1zz	A-17	44048HGA1	A-31	55-241-23	A-131	55-S99-23	A-131	6S004x1BB	B-50
43006yGzz	A-17	44048HGC1	A-31	55-341-23	A-131	55-U99-23	A-131	6S004x1RG	B-50
43008HGA1	A-31	44048x101	A-19	55-399-25	A-124	55-V99-24	A-124	6S012x1BB	B-50
43008x1zz	A-17	44048yG01	A-19	55-399-26	A-131	55-W99-24	A-124	6S012x1RG	B-50
43008yGzz	A-17	44060HGA1	A-31	55-399-38	A-127	55-Y99-47	A-132	6S-220-xA	A-44
43012HGA1	A-31	44060HGC1	A-31	55-399-43	A-133	56-201-55	A-91	6S-220-xB	A-44
43012yGzz	A-17	44060x101	A-19	55-399-46	A-132	56-201-58	A-91	6S-220-xP	A-46
43018HGA1	A-31	44060yG01	A-19	55-499-20	A-125	56-201-5A	A-90	6T001x101	B-49
43018x101	A-19	44072HGA1	A-31	55-499-23	A-131	56-201-5B	A-90	6T002x101	B-49
43018yG01	A-19	44072HGC1	A-31	55-499-25	A-124	56-201-65	A-91	6T002x1BB	B-49
43018K01*	A-17	44072x101	A-19	55-499-38	A-127	56-201-68	A-91	6T002x1RG	B-49
43018yG01	A-19	44072yG01	A-19	55-499-43	A-133	56-201-6A	A-90	6T004x1BB	B-49
43018yK01	A-17	44096x101	A-19	55-599-21*	A-126	56-201-6B	A-90	6T004x1RG	B-49
43024HGA1	A-31	44144x101	A-19	55-599-25	A-124	56-201-75	A-91	6T006x1BB	B-49
43024HGB1	A-31	44144yG01	A-19	55-599-38	A-127	56-201-7A	A-90	6T006x1RG	B-49
43024HK1Q	A-31	51002xx0y	B-41	55-599-43	A-133	56-201-7B	A-90	6T012x1BB	B-49
43024HKB1	A-31	51004xx0y	B-41	55-599-47	A-132	56-202-25	A-91	6T012x1RG	B-49
43024x101	A-19	51006xx0y	B-26	55-599-23	A-131	56-202-28	A-91	6T-246-xA	A-56
43024xK01*	A-17	51006xx0y	B-41	55-699-38	A-127	56-202-2A	A-90	6T-246-xB	A-56
43024yG01	A-19	51008xx0y	B-41	55-699-43	A-133	56-202-2B	A-90	6T-272-xA	A-56
43024yK01	A-17	51012xx0y	B-26	55-699-46	A-132	56-202-35	A-91	6T-272-xB	A-56
43030x101	A-19	51012xx0y	B-41	55-779-19	A-128	56-202-38	A-91	6U001x101	B-48
43030yG01	A-19	51024xx0y	B-26	55-789-19	A-128	56-202-3A	A-90	6U002x101	B-48
43036HGA1	A-31	51036xx0y	B-26	55-799-19	A-128	56-202-3B	A-90	6U002x1BB	B-48
43036HGB1	A-31	51048xx0y	B-26	55-799-20	A-125	56-202-45	A-91	6U002x1RG	B-48
43036HGC1	A-31	51072xx0y	B-26	55-799-21*	A-126	56-202-4A	A-91	6U004x1BB	B-48
43036x101	A-19	51096xx0y	B-26	55-799-23	A-131	56-202-4A	A-90	6U004x1RG	B-48
43036xE01	A-19	51-240-E1	A-78	55-799-24	A-124	56-202-4B	A-90	6U006x1BB	B-48
43036yE01	A-19	51-240-x1	A-80	55-799-26	A-131	57001x23Q	B-44	6U006x1RG	B-48
43036yG01	A-19	51-240-xG	A-77	55-799-38	A-127	57002x23Q	B-44	6U012x1RG	B-48
43048HGB1	A-31	51-240-xL	A-76	55-799-43	A-133	57002x23Q	B-44	70-065-24	B-65
43048HGC1	A-31	51-347-x5	A-86	55-899-20	A-125	57004x23Q	B-44	70-065-48	B-65
43048HGD1	A-31	51-372-x5	A-86	55-899-21*	A-126	57006x23Q	B-44	70-067-36	B-65
43048x101	A-19	51-478-45	A-87	55-899-23	A-131	57008x23Q	B-44	70-067-72	B-65
43048yG01	A-19	51-478-48	A-87	55-899-23	A-131	57012x23Q	B-44	70-069-48	B-65
43060HGA1	A-31	51-499-EL	A-88	55-899-38	A-127	5F-220-E1	A-82	70-069-72	B-65
43060HGC1	A-31	51-xxx-y5	A-74	55-899-43	A-133	5F-220-x1	A-84	70-071-72	B-65
43060x101	A-19	51-xxx-y8	A-74	55-999-20	A-125	5F-220-x5	A-70	70-071-96	B-65
43060yG01	A-19	52001xx0y	B-45	55-999-25	A-124	5F-220-x8	A-70	70-073-96	B-65
43072HGA1	A-31	52002xS0y	B-42	55-999-38	A-127	5V0063061	B-64	70-425-18	B-65
43072HGC1	A-31	52002xU0y	B-43	55-999-43	A-133	5V0063121	B-64	70-425-36	B-65
43072x101	A-19	52002xx0y	B-27	55-A99-20	A-125	5V0123121	B-64	71-055-02	B-63
43072yG01	A-19	52002xx0y	B-45	55-A99-21*	A-126	5V0123251	B-64	71-202-12	B-62
43084x101	A-19	52004xS0y	B-42	55-A99-23	A-131	5V0183181	B-64	71-402-02	B-63
43084yG01	A-19	52004xU0y	B-43	55-A99-25	A-124	5V0243251	B-64	72002xx2S	B-47
43096HGA1	A-31	52004xx0y	B-27	55-A99-26	A-131	5W002301Q	B-62	72002xx2y	B-46
43096x101	A-19	52004xx0y	B-45	55-A99-38	A-127	5W002302Q	B-62	72002xx3S	B-47
43096yG01	A-19	52006xS0y	B-42	55-A99-43	A-133	5W002303Q	B-62	72002xx3y	B-46
43144x101	A-19	52006xU0y	B-43	55-B99-20	A-125	5W004301Q	B-62	72002xx6S	B-47
43144yG01	A-19	52006xx0y	B-27	55-B99-21*	A-126	66-240-xA	A-52	72002xx6y	B-46
44006x1zz	A-17	52006xx0y	B-45	55-B99-23	A-131	66-240-xB	A-52	72004xx2S	B-47
44006yGzz	A-17	52008xS0y	B-42	55-B99-24	A-124	66-246-xA	A-52	72004xx2y	B-46
44008HGA1	A-31	52008xU0y	B-43	55-B99-25	A-124	66-246-xB	A-52	72004xx3S	B-47
44008HGB1	A-31	52008xx0y	B-45	55-B99-26	A-131	66-246-xM	A-54	72004xx3y	B-46
44008x1zz	A-17	52012xS0y	B-42	55-B99-38	A-127	66-246-xP	A-62	72004xx6S	B-47
44008yGzz	A-17	52012xU0y	B-43	55-D99-25	A-124	66-272-xA	A-52	72004xx6y	B-46
44012HGA1	A-31	52012xx0y	B-27	55-E99-20	A-125	66-272-xB	A-52	72006xx2S	B-47
44012HGC1	A-31	52012xx0y	B-45	55-E99-21*	A-126	66-272-xP	A-62	72006xx2y	B-46
44012HKA1	A-31	52024xx0y	B-27	55-E99-23	A-131	6A-246-xB	A-42	72006xx3S	B-47
44012x1zz	A-17	52036xx0y	B-27	55-E99-24	A-124	6A-272-xA	A-42	72006xx3y	B-46
44012yGzz	A-17	52048xx0y	B-27	55-E99-25	A-124	6A-272-xB	A-42	72006xx6S	B-47
44018HGA1	A-31	52072xx0y	B-27	55-E99-25	A-124	6F-246-xA	A-48	72006xx6y	B-46
44018x101	A-19	52096xx0y	B-27	55-E99-26	A-132	6F-246-xB	A-48	72012xx6S	B-47
44018yG01	A-19	52-200-x5	A-68	55-E99-46	A-132	6F-272-xA	A-48	72012xx6y	B-46
44018yK01*	A-17	52-200-x8	A-68	55-F31-23	A-131	6F-272-xB	A-48	72-312-01	A-39
44018yG01	A-19	52-200-x5	A-68	55-F99-21	A-126	6F-273-xA	A-48	72-421-03	A-39
44018yK01	A-17	52-241-x8	A-68	55-F99-26	A-131	6F-273-xB	A-48	72-512-01	A-38
44024HGC1	A-31	53006xx0y	B-38	55-F99-26	A-131	6H-246-xA	A-40	72-621-03	A-38
44024HGD1	A-31			55-F99-43	A-133	6H-246-xB	A-40	77-246-E1	A-64

Part Number	Page	Part Number	Page	Part Number	Page	Part Number	Page	Part Number	Page
77-246-x1	A-66	85-112-13	B-101	CHFS12NMR	D-26	F1012xx0y	B-28	FE11-216xxx-E99y	B-23
77-272-xG	A-60	85-112-41	B-105	CHFS-12NM	D-11	F1024xx0y	B-28	FE11-288xxx-E99y	B-23
77-xxx-yA	A-58	85-116-01	B-103	CHFS-12NM	D-26	F1036xx0y	B-28	FE12-006xxx-E99y	B-24
77-xxx-yB	A-58	85-116-13	B-101	CHFS-6DF	D-9	F1048xx0y	B-28	FE12-012xxx-E99y	B-24
78-107-91	A-108	85-116-41	B-105	CHFS-6DMR	D-9	F1072xx0y	B-28	FE12-024xxx-E99y	B-24
78-107-9P	A-108	85-118-01	B-103	CHFS-6DM	D-9	F1096xx0y	B-28	FE12-048xxx-E99y	B-24
78-11A-9R	A-107	85-118-13	B-101	CHFS-6NF	D-11	F2006xxSy	B-29	FE12-072xxx-E99y	B-24
78-147-91	A-104	85-118-41	B-105	CHFS-6NMR	D-11	F2012xxSy	B-29	FE12-096xxx-E99y	B-24
78-147-9P	A-104	85-120-01	B-103	CHFS-6DM	D-11	F2024xxSy	B-29	FE12-144xxx-E99y	B-24
78-148-91	A-104	85-120-13	B-101	CHFS12DF	D-23	F2036xxSy	B-29	FE12-216xxx-E99y	B-24
78-14C-91	A-104	85-120-41	B-105	CHFS12DMR	D-23	F2048xxSy	B-29	FE12-288xxx-E99y	B-24
78-16C-91	A-106	85-121-13	B-101	CHFS12DM	D-23	F2072xxSy	B-29	FE14-006U10-E991	B-25
78-558-91	A-110	85-124-13	B-101	CHFS12NFR	D-26	F2096xxSy	B-29	FE14-012U10-E991	B-25
78-55C-91	A-110	85-143-41	B-105	CHFS12NF	D-26	F2C2-012U13-6991-CE5	D-13	FE14-024U10-E991	B-25
79-107-91	A-108	85-145-13	B-101	CHFS12NMR	D-26	F356-012Uxx-y991	A-21	FE14-048U10-E991	B-25
79-107-9P	A-108	85-147-01	B-103	CHFS12NM	D-26	F356-024Uxx-y991	A-21	FE14-096U10-E991	B-25
79-11A-9R	A-107	85-147-13	B-101	CLH-12DFR	D-8	F356-048Uxx-y991	A-21	FE14-144U10-E991	B-25
79-11B-9R	A-107	85-147-41	B-105	CLH-12DF	D-22	F356-060Uxx-y991	A-21	FE14-288U10-E991	B-25
79-147-91	A-104	85-151-01	B-103	CLH-12DF	D-8	F356-072Uxx-y991	A-21	FH10-006xxx-E99y	B-36
79-147-9P	A-104	85-151-13	B-101	CLH-12DMR	D-22	F356-084Uxx-y991	A-21	FH10-012xxx-E99y	B-36
79-148-91	A-104	85-151-41	B-105	CLH-12DMR	D-8	F356-096Uxx-y991	A-21	FH10-024xxx-E99y	B-36
79-558-91	A-110	85-153-01	B-103	CLH-12DM	D-22	F356-144Uxx-y991	A-21	FH10-036xxx-E99y	B-36
7A-421-03	A-39	85-153-13	B-101	CLH-12DM	D-8	F356-216Uxx-y991	A-21	FH10-048xxx-E99y	B-36
7A-621-03	A-38	85-153-41	B-105	CLH-12NFR	D-10	F356-288Uxx-y991	A-21	FH10-060xxx-E99y	B-36
85-018-25	B-124	85-155-13	B-101	CLH-12NFR	D-25	F360-002Uxx-Eyy1	A-13	FH10-072xxx-E99y	B-36
85-019-25	B-124	85-155-41	B-105	CLH-12NF	D-10	F360-004Uxx-Eyy1	A-13	FH10-096xxx-E99y	B-36
85-026-13	B-101	85-156-13	B-101	CLH-12NF	D-25	F360-006Uxx-Eyy1	A-13	FH10-144xxx-E99y	B-36
85-028-13	B-101	85-157-01	B-103	CLH-12NMR	D-10	F360-008Uxx-Eyy1	A-13	FH10-216xxx-E99y	B-36
85-031-01	B-103	85-157-13	B-101	CLH-12NM	D-25	F360-012Uxx-Eyy1	A-13	FH10-288xxx-E99y	B-36
85-031-13	B-101	85-158-13	B-101	CLH-12NM	D-10	F456-012Uxx-y991	A-21	FH26-006xxx-E99y	B-37
85-031-41	B-105	85-159-13	B-101	CLH-12NM	D-25	F456-024Uxx-y991	A-21	FH26-012xxx-E99y	B-37
85-034-01	B-103	85-161-13	B-101	CLH-22DF	D-8	F456-048Uxx-y991	A-21	FH26-024xxx-E99y	B-37
85-034-13	B-101	85-233-06	B-111	CLH-22DM	D-8	F456-060Uxx-y991	A-21	FH26-036xxx-E99y	B-37
85-034-41	B-105	86-57D-A1	A-111	CLH-22NF	D-10	F456-072Uxx-y991	A-21	FH26-048xxx-E99y	B-37
85-038-01	B-103	A3001x101	A-3	CLH-22NM	D-10	F456-084Uxx-y991	A-21	FH26-060xxx-E99y	B-37
85-038-13	B-101	A3001yG01	A-3	CLH-33DF	A-3	F456-096Uxx-y991	A-21	FH26-072xxx-E99y	B-37
85-038-41	B-105	A4001x101	A-3	CLH-33DM	D-8	F456-144Uxx-y991	A-21	FH26-096xxx-E99y	B-37
85-042-01	B-103	A4001yG01	A-3	CLH-33NF	D-10	F456-216Uxx-y991	A-21	FH26-144xxx-E99y	B-37
85-042-13	B-101	AA-SL	D-40	CLH-33NM	D-10	F456-288Uxx-y991	A-21	FH26-216xxx-E99y	B-37
85-042-41	B-105	AC-A1x-55	A-123	CLH-42DF	D-8	F460-002Uxx-Eyy1	A-13	FH26-288xxx-E99y	B-37
85-057-13	B-101	AC-A1x-68	A-123	CLH-42DM	D-8	F460-004Uxx-Eyy1	A-13	FI2-BD100	C-5
85-059-13	B-101	AC-A2x-55	A-123	CLH-42NF	D-10	F460-006Uxx-Eyy1	A-13	FI2-CD100	C-5
85-061-13	B-101	AC-A2x-68	A-123	CLH-42NM	D-10	F460-008Uxx-Eyy1	A-13	FI2-G1P25	C-11
85-062-01	B-103	AGDMDF02	D-37	CLHP-12DF	D-22	F460-012Uxx-Eyy1	A-13	FI2-G4FP25	C-11
85-062-13	B-101	AG-NFNF	D-37	CLHP12DMR	D-22	F4C2-012U13-6991-CE5	D-12	FI2-G4RP25	C-11
85-062-41	B-105	ATDMDF700	D-36	CLHP-12DM	D-22	FD2-AD10F	C-7	FIC-AD100	C-5
85-065-01	B-103	AT-DMDF-W	D-36	CLHP12NFR	D-25	FD2-APLMT	C-12	FIC-BD100	C-5
85-065-13	B-101	ATNMNF700	D-36	CLHP-12NF	D-25	FD2-BD10F	C-7	FIC-BD10A	C-5
85-065-41	B-105	AT-NMNF-W	D-36	CLHP12NMR	D-25	FD2-BPLMT	C-12	FIC-CD100	C-5
85-069-01	B-103	B3002x101	A-3	CLHP12NM	D-25	FD2-CD10F	C-7	FIC-CD10A	C-5
85-069-13	B-101	B3002yG01	A-3	CLH-209S5	A-37	FD2-CDF08	C-13	FIC-G3P25	C-11
85-069-41	B-105	B4002x101	A-3	D1-3169S5	A-37	FD2-CDR07	C-13	FIC-G4P25	C-11
85-073-01	B-103	B4002yG01	A-3	D1-5009S5	A-37	FD2-CFR20	C-13	FIC-GCP25	C-11
85-073-13	B-101	C3002x101	A-3	D1-6169S5	A-37	FD2-CFR25	C-13	FIC-HA000	C-11
85-073-41	B-105	C3002yG01	A-3	D1-A009S5	A-37	FD2-CPLMT	C-12	FIC-PMBA1	C-11
85-075-01	B-103	C4002x101	A-3	D1-B169S5	A-37	FD2-CTOOL	C-7	FIC-PMBO1	C-11
85-075-13	B-101	C4002yG01	A-3	D1-D009S5	A-37	FD2-DD10F	C-13	FIC-TD120	C-10
85-077-01	B-103	CHAP12NMR	D-27	D1-E169S5	A-37	FD2-GDF08	C-13	FIC-TD240	C-10
85-077-13	B-101	CHFA-12DF	D-24	D1-J009S5	A-37	FD2-GDR07	C-13	FM006x1Sy	B-30
85-077-41	B-105	CHFA12DMR	D-24	D1-K169S5	A-37	FD2-GDR09	C-13	FM012x1Sy	B-30
85-081-01	B-103	CHFA-12DM	D-24	D1-M009S5	A-37	FD2-GFR12	C-13	FM024x1Sy	B-30
85-081-13	B-101	CHFA12NFR	D-27	D1-N169S5	A-37	FD2-GFR16	C-13	FM036x1Sy	B-30
85-081-41	B-105	CHFA-12NF	D-27	D1-5009S5	A-37	FDC-TD240	C-12	FM048x1Sy	B-30
85-083-01	B-103	CHFA12NMR	D-27	D1-T169S5	A-37	FDC-TD360	C-12	FM072x1Sy	B-30
85-083-13	B-101	CHFA-12NM	D-27	D1-V009S5	A-37	FDC-TD720	C-12	FM096x1Sy	B-30
85-085-13	B-101	CHFAP12DF	D-24	D1-W169S5	A-37	FDC-TE144	C-12	FSP-D-1x16	C-12
85-092-13	B-101	CHFAP12DMR	D-24	D3001L3yy	A-22	FDH-AA000	C-8	FSP-D-1x2	C-12
85-094-13	B-101	CHFAP12DM	D-24	D3001L5yy	A-22	FDH-BA000	C-8	FSP-D-1x32	C-12
85-097-01	B-103	CHFAP12NFR	D-27	D3-2009SA	A-36	FDH-CA000	C-8	FSP-D-1x4	C-12
85-097-13	B-101	CHFAP12NF	D-27	D3-5009SA	A-36	FDH-DA000	C-8	FSP-D-1x8	C-12
85-100-01	B-103	CHFAP12NM	D-27	D3-A009SA	A-36	FDH-SCA72	C-9	FSP-I-1x16	C-10
85-100-13	B-101	CHFS12DFR	D-9	D3-B169SA	A-36	FDH-SM116	C-8	FSP-I-1x2	C-10
85-100-41	B-105	CHFS-12DF	D-23	D3-D009SA	A-36	FDH-SM132	C-8	FSP-I-1x32	C-10
85-104-01	B-103	CHFS-12DF	D-9	D3-E169SA	A-36	FDH-SMD14	C-8	FSP-I-1x4	C-10
85-104-13	B-101	CHFS12DMR	D-23	D3-J009SA	A-36	FDH-SMD18	C-8	FSP-I-1x8	C-10
85-104-41	B-105	CHFS12DMR	D-9	D3-K169SA	A-36	FDP-xy1A0 ¹	C-9	GB0424TU	D-41
85-108-01	B-103	CHFS-12DM	D-23	D3-M009SA	A-36	FE11-006xxx-E99y	B-23	GM012K011	D-6
85-108-13	B-101	CHFS-12DM	D-9	D3-N169SA	A-36	FE11-012xxx-E99y	B-23	GM012K111	D-6
85-108-41	B-105	CHFS12NFR	D-11	D3-5009SA	A-36	FE11-024xxx-E99y	B-23	GM012K221	D-6
85-110-01	B-103	CHFS12NFR	D-26	D3-T169SA	A-36	FE11-048xxx-E99y	B-23	HFAC-12DP	D-19
85-110-13	B-101	CHFS-12NF	D-11	D3-V009SA	A-36	FE11-072xxx-E99y	B-23	HFAC-12DR	D-18
85-110-41	B-105	CHFS-12NF	D-26	D5001L5yy	A-23	FE11-096xxx-E99y	B-23	HFSC-12DP	D-17
85-112-01	B-103	CHFS12NMR	D-11	F1006xx0y	B-28	FE11-144xxx-E99y	B-23	HFSC-12DR	D-16

Part Number Index

Part Number	Page	Part Number	Page	Part Number	Page	Part Number	Page	Part Number	Page
HFSC-12D	D-5	K2F-229-91	A-117	L4024xPB1	A-11	P4006xx01	A-5	T-HFAC12DR	D-28
HFSC-6DFR	D-5	K2F-229-92	A-117	L4024xVB1	A-7	P4008xx01	A-5	T-HFSC12DP	D-28
HZ0063021	B-36	K2F-239-91	A-117	L4036x201	A-35	P4012xx01	A-5	T-HFSC12DR	D-28
HZ0063121	B-37	K2F-239-92	A-117	L4036x401	A-33	P4024xxA1	A-5	T-LHF12DR	D-28
HZ0123021	B-36	K2F-319-91	A-117	L4036xPB1	A-11	P4024xxB1	A-9	T-LHFA12DP	D-28
HZ0123121	B-37	K2F-319-92	A-117	L4036xVB1	A-7	P4024xxC1	A-5	V4002xx01	A-5
HZ0243021	B-36	K2F-329-91	A-117	L4048x201	A-35	P4036xxB1	A-9	V4004xx01	A-5
HZ0243121	B-37	K2F-329-92	A-117	L4048x401	A-33	P4048xx01	A-9	V4006xx01	A-5
HZ0363021	B-36	K2F-339-91	A-117	L4036xV01	A-11	P4072xx01	A-9	V4008xx01	A-5
HZ0363121	B-37	K2F-339-92	A-117	L4048xV01	A-7	P4096xx01	A-9	V4012xx01	A-5
HZ0483021	B-36	K2F-419-91	A-117	L4072x201	A-35	P4144xx01	A-9	V4024xxB1	A-6
HZ0483121	B-37	K2F-419-92	A-117	L4072x401	A-33	PW52-H46-y5	A-72	V4036xxB1	A-6
HZ0603021	B-36	K2F-429-91	A-117	L4072xP01	A-11	PW52-H46-y8	A-72	V4048xx01	A-6
HZ0603121	B-37	K2F-519-91	A-117	L4072xV01	A-7	PW52-H72-y5	A-72	V4072xx01	A-6
HZ0723021	B-36	K2F-519-92	A-117	L4096xV01	A-11	PW52-H72-y8	A-72	V4096xx01	A-6
HZ0723121	B-37	K2F-529-91	A-117	L4096xV01	A-7	R1012x10y	B-58	V4144xx01	A-6
HZ0963021	B-36	K2F-529-92	A-117	L4144xP01	A-11	R1012xD0y	B-54	W3002xyyy	A-27
HZ1443021	B-36	K2F-539-91	A-117	L4144xV01	A-7	R1024xD0y	B-54	W3004xyyy	A-27
HZ1443121	B-37	K2F-539-92	A-117	L4-199-xA	A-89	R1048x10y	B-58	W3006xyyy	A-27
HZ2163021	B-36	K4-199-xA	A-89	L4-299-yA	A-89	R1048xD0y	B-54	W3008xyyy	A-27
HZ2163121	B-37	K4-299-yA	A-89	LBA-12-1A	D-29	R1072x10y	B-58	W3012HGB1	A-31
HZ2883021	B-36	K8-A99-33	A-89	LBA-12-2A	D-29	R1072xD0y	B-54	W3012HGD1	A-31
HZ2883121	B-37	KC-919-45	A-104	LBA-12-3A	D-29	R1096x10y	B-58	W3012xyyy	A-27
HZ9603121	B-37	KC-919-E5	A-104	LBA-12-4A	D-29	R1096xD0y	B-54	W3018HGA1	A-31
J12-1DMDM	D-7	KC-919-x5	A-89	LBA-12-5A	D-29	R1144x10y	B-58	W3018xx01	A-27
J12-1NMMN	D-7	L2-199-x5	A-89	LBA-22-1A	D-29	R1144xD0y	B-54	W3024HGA1	A-31
J12-2DMDM	D-7	L2-299-y5	A-89	LBA-22-2A	D-29	R1216x10y	B-58	W3024HGC1	A-31
J12-2NMMN	D-7	L3002x301	A-33	LBA-22-3A	D-29	R1216xD0y	B-54	W3024HGE1	A-31
J12-3DMDM	D-7	L3002xW01	A-35	LBA-22-4A	D-29	R1288x10y	B-58	W3024xx01	A-27
J12-3NMMNR	D-7	L3004x301	A-33	LBA-33-1A	D-29	R1288xD0y	B-54	W3030xx01	A-27
J12-3NMMN	D-7	L3004xW01	A-35	LBA-42-1A	D-29	R1360xD0y	B-54	W3036HGA1	A-31
J12-4DMDM	D-7	L3006x10y	B-35	LBA-57-1A	D-29	R1432x10y	B-58	W3036HGC1	A-31
J12-4NMMN	D-7	L3006x401	A-33	LBHS12NH	D-35	R1432xD0y	B-54	W3036HGE1	A-31
J12-5DMDM	D-7	L3006xW01	A-35	LBHS22NH	D-35	R1576x101	B-58	W3036xx01	A-27
J12-5DMDM	D-7	L3008x401	A-33	LBHS33NH	D-35	R1864x101	B-58	W3048HGB1	A-31
J12-5NMMN	D-7	L3008xW01	A-35	LBHS42NH	D-35	R2012x15y	B-59	W3048HGC1	A-31
J12-6NMMNR	D-7	L3012x10y	B-35	L-CT-12DS	D-28	R2012xD5y	B-55	W3048HGE1	A-31
JP121NFNF	D-21	L3012x401	A-33	L-CT-12D	D-28	R2024x15y	B-59	W3048xx01	A-27
JP121NFRF	D-21	L3012xW01	A-35	L-CT-22D	D-28	R2024xD5y	B-55	W3060HGA1	A-28
JP121NMNF	D-21	L3018x401	A-33	L-FT-42D	D-28	R2036x15y	B-59	W3060xx01	A-27
JP121NMNM	D-21	L3018xK1Q	A-33	L-GK-C12	D-32	R2048x15y	B-59	W3072HGA1	A-31
JP121NMRF	D-21	L3018xW01	A-35	L-GK-C22	D-32	R2048xD5y	B-55	W3072HGC1	A-31
JP121NMRRM	D-21	L3024x10y	B-35	L-GK-C33	D-32	R2072x15y	B-59	W3072xx01	A-27
JP122NFNF	D-21	L3024x401	A-33	L-GK-C42	D-32	R2072xD5y	B-55	W3084xx01	A-27
JP122NFRF	D-21	L3024xK1Q	A-33	LHF-12DP	D-15	R2096x15y	B-59	W3096HGA1	A-31
JP122NMNF	D-21	L3024xPB1	A-11	LHF-12DR	D-14	R2096xD5y	B-55	W3096HGB1	A-31
JP122NMNM	D-21	L3024xW01	A-35	LHF-12D	D-2	R2144x15y	B-59	W3096xx01	A-27
JP122NMRF	D-21	L3036x401	A-33	LHF-22DU	D-4	R2144xD5y	B-55	W3144HGC1	A-28
JP122NMRRM	D-21	L3036xPB1	A-11	LHF-33D	D-2	R2192x15y	B-59	W3144xx01	A-27
JP123NFNF	D-21	L3036xW01	A-35	LHF-42DUF	D-4	R2192xD5y	B-55	W4002xyyy	A-29
JP123NFRF	D-21	L3048x10y	B-35	LHG-12L	D-31	R2216x15y	B-59	W4004xyyy	A-29
JP123NMNF	D-21	L3048x401	A-33	LHG-12	D-31	R2216xD5y	B-55	W4006xyyy	A-29
JP123NMNM	D-21	L3048xP01	A-11	LHG-22L	D-31	R2288x15y	B-59	W4008xyyy	A-29
JP123NMRF	D-21	L3048xW01	A-35	LHG-22	D-31	R2288xD5y	B-55	W4012xyyy	A-29
JP123NMRRM	D-21	L3072x10y	B-35	LHG-33L	D-31	R2360x15y	B-59	W4024xx01	A-29
JR121NFNF	D-20	L3072x401	A-33	LHG-33	D-31	R2360xD5y	B-55	W7001x10y	B-53
JR121NFRF	D-20	L3072xP01	A-11	LHG-42L	D-31	R2432x15y	B-59	W7001xU0y	B-52
JR121NMNF	D-20	L3072xW01	A-35	LHG-42	D-31	R2432xD5y	B-55	W7002x10y	B-53
JR121NMNM	D-20	L3096x10y	B-35	L-SA-38	D-40	RM060x15y	B-31	W7002xU0y	B-52
JR121NMRF	D-20	L3096x401	A-33	L-SH-S12	D-34	RM072x15y	B-31	WATS-38	D-43
JR121NMRRM	D-20	L3096xP01	A-11	L-SH-S22	D-34	RM096x15y	B-31	WPS12158D	D-42
JR122NFNF	D-20	L3096xW01	A-35	L-SH-S33	D-34	RM144x15y	B-31	WPSANT12D	D-42
JR122NFRF	D-20	L3144x10y	B-35	L-SH-S42	D-34	RM192x15y	B-31		
JR122NMNF	D-20	L3144x401	A-33	L-SH-U12	D-33	RM216x15y	B-31		
JR122NMNM	D-20	L3144xP01	A-11	L-SH-U22	D-33	RM-A100	D-38		
JR122NMRF	D-20	L3144xW01	A-35	L-SH-U33	D-33	RM-A300	D-38		
JR122NMRRM	D-20	L4-001-68	A-92	L-SH-U42	D-33	S2360x10y	B-57		
JR123NFNF	D-20	L4002x301	A-33	L-WK-U	D-30	S2432x10y	B-57		
JR123NFRF	D-20	L4002xW01	A-35	MR0723011	B-60	S2576x10y	B-57		
JR123NMNF	D-20	L4004x301	A-33	P3002xx01	A-5	S2720x10y	B-57		
JR123NMNM	D-20	L4004xW01	A-35	P3004xx01	A-5	S2864x10y	B-57		
JR123NMRF	D-20	L4006x401	A-33	P3006xx01	A-5	S2A08x10y	B-57		
JR123NMRRM	D-20	L4006xW01	A-35	P3008xx01	A-5	SA-SS200	D-39		
K2-199-x5	A-89	L4008x401	A-33	P3012xx01	A-5	SA-SS300	D-39		
K2-299-y5	A-89	L4008xW01	A-35	P3024xxA1	A-5	SSHAK3812*	D-34		
K2F-119-91	A-117	L4012x401	A-33	P3024xxB1	A-9	SSM-2C000	C-3		
K2F-119-92	A-117	L4012xW01	A-35	P3036xxB1	A-9	T30063201	A-14		
K2F-129-91	A-117	L4018x201	A-35	P3048xx01	A-9	T30123201	A-14		
K2F-129-92	A-117	L4018x401	A-33	P3072xx01	A-9	T30243201	A-14		
K2F-139-91	A-117	L4018xK1Q	A-33	P3096xx01	A-9	TBK-HFSC12	D-28		
K2F-139-92	A-117	L4024x201	A-35	P3144xx01	A-9	TBK-LHFA12	D-28		
K2F-219-91	A-117	L4024x401	A-33	P4002xx01	A-5	TF-HFSC12	D-28		
K2F-219-92	A-117	L4024xK1Q	A-33	P4004xx01	A-5	TF-LHFA12	D-28		

**MADE
IN THE USA**



Corporate Headquarters | Atlanta, GA



Product Development Center | Kennesaw, GA



Brownwood Communications Plant | Brownwood, TX



Hoisington Communications Plant | Hoisington, KS



6120 Powers Ferry Road, Suite 150
Atlanta, Georgia 30339

P 770.657.6000
T 800.551.8948
F 877.291.7919

SuperiorEssex.com

Superior Essex makes every effort to ensure the accuracy of the information contained in this catalogue at the time of publication. Specifications, packaging and part numbers detailed within are subject to change. For the most up-to-date information, please contact Superior Essex at 800.551.8948 or visit SuperiorEssex.com. © 2015 Superior Essex, Inc.