

---

# WattBox Online Double Conversion Uninterruptible Power Supply

---

## Installation and User Guide

### WB-UPS-OL-1000-8, WB-UPS-OL-1500-8, WB-UPS-OL-2000-8

 **Note:** For safety reasons, the UPS ships with the battery disconnected. Follow the below steps to connect the battery wires before installation.

1. Lift the front panel from the left to remove it.

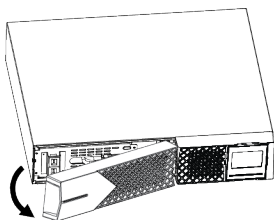

2. Connect the battery cables.

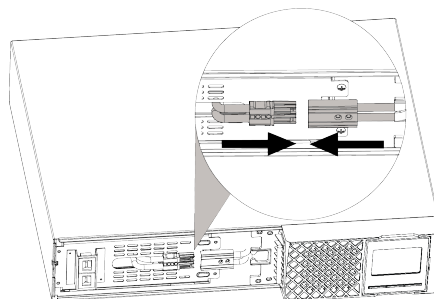

3. Put the front panel back on the UPS.

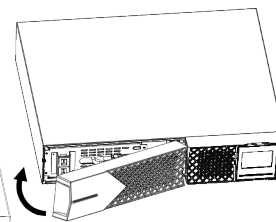

## Package contents

- (1) UPS
- (1) Documentation QR card
- (1) Detachable power cord
- (1) USB cable
- (4) Rack mounting brackets
- (8) Rack mounting screws

---

# Safety warnings

---

Save these instructions - This manual contains important instructions for installation and maintenance of the UPS and batteries

Comply with all warnings and operating instructions in this manual. Do not operate this UPS before reading through all the safety information and operating instructions carefully.

## Transportation

Only transport the UPS in the original package to protect against shock and impact.

## Preparation

- Condensation may occur if the UPS is moved directly from a cold to warm environment. The UPS must be absolutely dry before being installed. Allow at least two hours for the UPS to acclimate to the environment.
- Do not install the UPS near water or in moist environments.
- Do not install the UPS where it could be exposed to direct sunlight or near a heater.
- Do not block the ventilation holes in the UPS housing.

## Installation

- Do not connect appliances or devices that would overload the UPS (e.g. laser printers).
- Place cables in a way that no one can step on or trip over them.
- Do not connect domestic appliances, like hair dryers, to the UPS.

- Connect the UPS to a grounded, shockproof outlet that is easily accessible and close to the UPS.
- Only use UL-marked power cables to connect loads to the UPS.
- Verify that the sum of the leakage current of the UPS and connected devices does not exceed 3.5mA.
- The UPS is rated for a maximum ambient temperature of 40°C (104°F).
-  **Caution:** The unit is heavy. Lifting the unit requires a minimum of two people.
- Batteries must have a minimum case flame rating of V-2 as defined in the Standard for the Protection of Information Technology Equipment, ANSI/NFAP 75. Batteries with an HB case flame rating are not intended for use in a computer room (US installations only).

## Operation

- Do not disconnect the mains cable from the UPS or the building wiring outlet (shockproof socket outlet) during operation. Doing so cancels the protective earthing of the UPS and of the all connected equipment.
- The UPS features its own, internal current source (batteries). The UPS output sockets or output terminals may be electrically live even if the UPS is not connected to the building wiring outlet.
- In order to fully disconnect the UPS, press the **OFF/Enter** button to disconnect the mains.
- Prevent fluids or other foreign objects from entering the UPS.

- The EPO and USB circuits are an IEC 60950-1 safety extra low voltage (SELV) circuit. This circuit must be separated from any hazardous voltage circuits by reinforced insulation.

## Maintenance, service and faults

- The UPS operates with hazardous voltages. Repairs may only be carried out by qualified maintenance personnel.
-  **Caution:** Risk of electric shock. Even after the unit is disconnected from the mains (building wiring outlet), components inside the UPS are still connected to the battery and electrically live and dangerous.
- Before providing any kind of service or maintenance, disconnect the batteries and verify that no current is present and no hazardous voltage exists in the terminals of high capability capacitors such as BUS-capacitors.
- To avoid electrical shock, turn off the unit and unplug it from the AC power source before servicing the battery
- Only qualified service representatives may replace batteries and supervise operations.

 **Caution:** Risk of electric shock. The battery circuit is not isolated from the input voltage. Hazardous voltages may occur between the battery terminals and the ground. Before touching, verify that no voltage is present!

 **Caution:** Do not dispose of batteries in a fire. The batteries may explode.



**Caution:** Do not open or mutilate batteries. Released electrolyte is harmful to the skin and eyes.

**Take the following precautions when working with batteries:**

1. Remove watches, rings, or other metal objects.
2. Use tools with insulated handles.
3. Wear rubber gloves and boots.
4. Do not lay tools or metal parts on top of batteries.
5. Disconnect the charging source prior to connecting or disconnecting battery terminals.
6. Determine if the battery is inadvertently grounded. If inadvertently grounded, remove the source from the ground. Contact with any part of a grounded battery can result in electrical shock. The likelihood of such shock can be reduced if such grounds are removed during installation and maintenance.

When changing batteries, install the same number and type of batteries or battery packs.

Do not dismantle the UPS.



**Caution:** Changes or modifications not expressly approved by the party responsible for compliance could void the user's authority to operate the equipment.

---

## Back Panels

WB-UPS-OL-1000-8 & WB-UPS-OL-1500-8

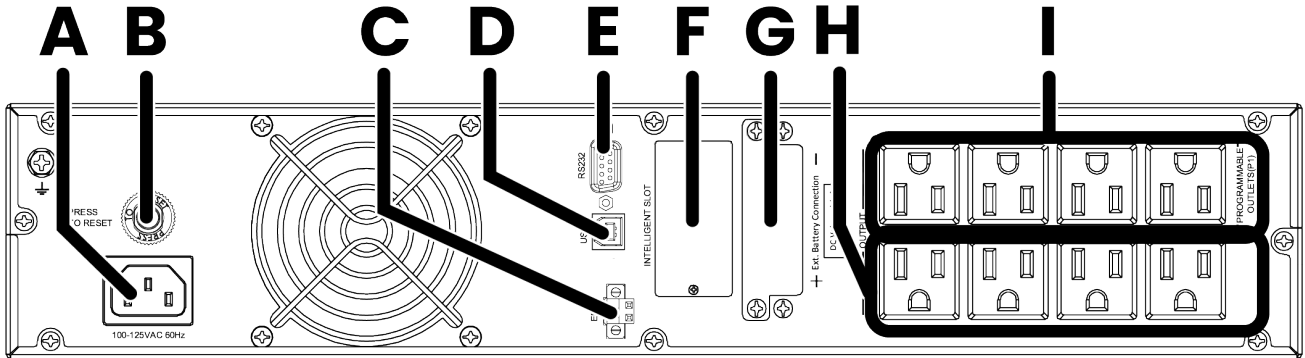

- A. **AC input** – 3 prong C14 power cord input to connect to the mains power.
- B. **Circuit breaker** – Press to reset the circuit if it's tripped.
- C. **Emergency power off function connector (EPO)** – Two-pin terminal for turning the UPS on (pins connected) and off (pins separated). Leave the jumper in place if this feature is not being used.
- D. **USB port** – For connecting to a PC to monitor the UPS.
- E. **RS-232 Communication Port** – For connecting an automation system or a computer to control and monitor UPS operation with management software.
- F. **SNMP intelligent slot** – Remove the cover to install an optional UPS SNMP card (not included).
- G. **External battery pack connection** – To connect one or more External Battery Packs (not included).
- H. **Always on outlets** – Critical load outlets that remain on until the UPS battery is depleted.

- I. **Programmable outlets** – Protected, non-critical load outlets that can be programmed to turn off when the battery level reduces to a set percentage using the PC Utility Software.

## WB-UPS-OL-2000-8

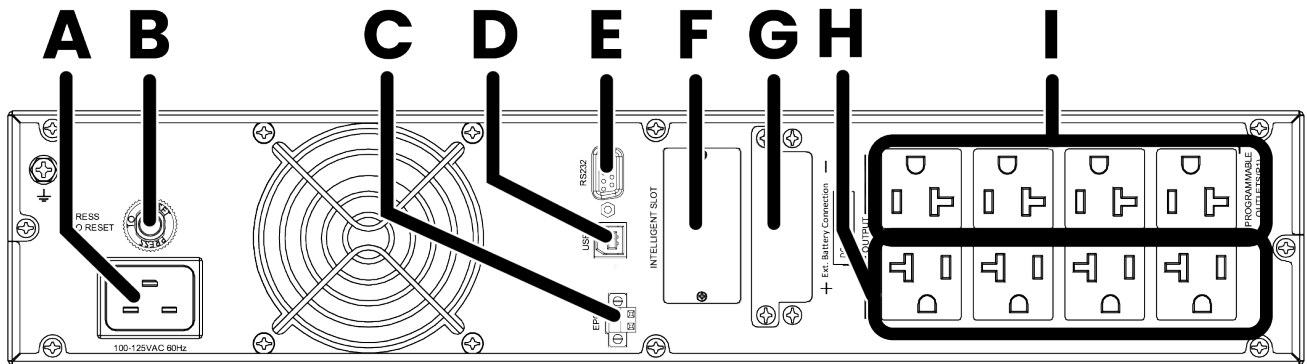

- A. **AC input** – 3 prong IEC power cord input to connect to the mains power.
- B. **Circuit breaker** – Press to reset the circuit if it's tripped.
- C. **Emergency power off function connector (EPO)** – Two-pin terminal for turning the UPS on (pins connected) and off (pins separated). Leave the jumper in place if this feature is not being used.
- D. **USB port** – For connecting to a PC to monitor the UPS.
- E. **RS-232 Communication Port** – For connecting an automation system or a computer to control and monitor UPS operation with management software.
- F. **SNMP intelligent slot** – Remove the cover to install an optional UPS SNMP card (not included).
- G. **External battery pack connection** – To connect one or more External Battery Packs (not included).
- H. **Always on outlets** – Critical load outlets that remain on until the UPS battery is depleted.

- A. **Programmable outlets** – Protected, non-critical load outlets that can be programmed to turn off when the battery level reduces to a set percentage using the PC Utility Software.

---

## Battery pack anatomy

Front

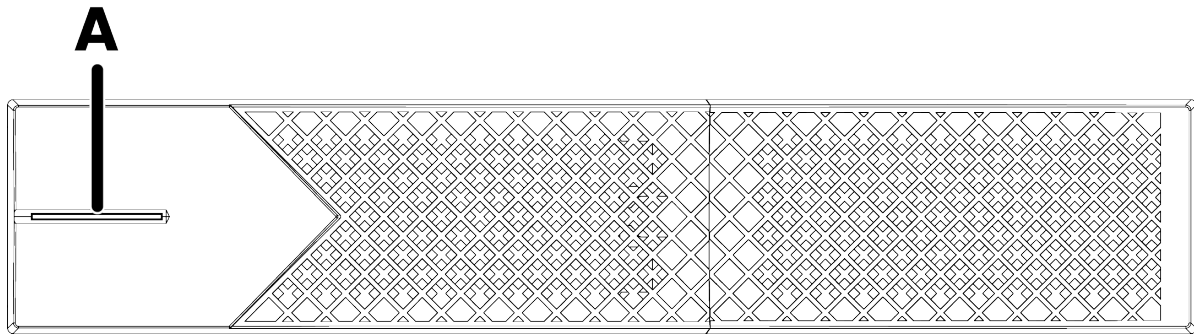

- A. **LED** – Illuminates after the Extended Battery Pack is connected to the UPS, the breaker on the back is flipped, and the unit detects power.



## WB-UPS-EBP-18AH24V back panel

Compatible with the WB-OVRC-OLUPS-1000-1

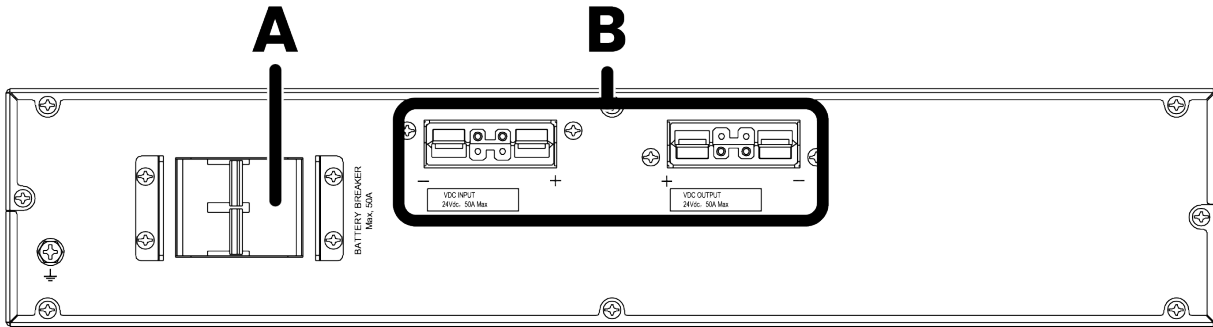

- A. **Battery breakers** — To cut the power output from the battery pack and protect the UPS from overcurrent conditions.
- B. **Battery connector** — To connect to a WattBox Double Conversion UPS and daisy-chain additional battery packs.

## WB-UPS-EBP-18AH48V back panel

Compatible with the WB-OVRC-OLUPS-1500-1 and WB-OVRC-OLUPS-2000-1

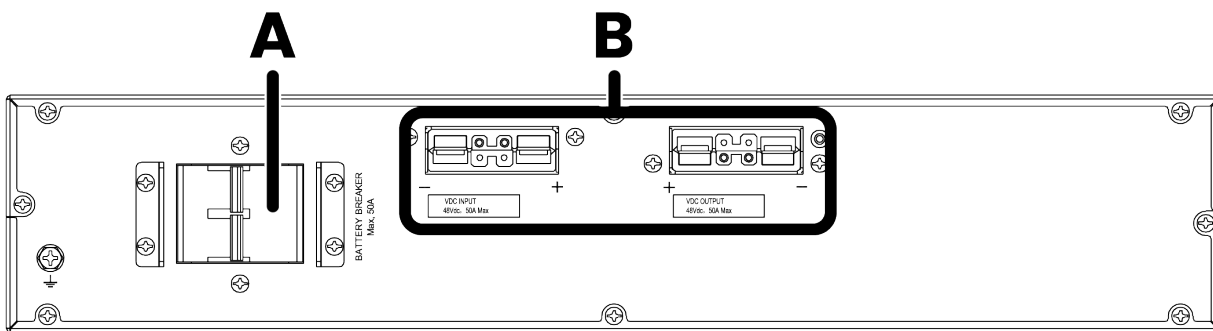

- A. **Battery breakers** — To cut the power output from the battery pack and protect the UPS from overcurrent conditions.

- B. **Battery connector** – To connect to a WattBox Double Conversion UPS and daisy-chain additional battery packs.

---

# Installation

---

Inspect the UPS for damages. Follow these location guidelines:

- Place the UPS on a flat, clean surface and away from vibration, dust, humidity, high temperature, flammable liquids, gases, and corrosive and conductive contaminants.
- Install the UPS indoors in a clean environment, away from windows and doors.
- The UPS operates normally at an altitude of 3,000 m (1.86 miles) or lower for the UPS to operate normally with a full load.

## Rack-mount installation

1. Install the included rack ears on the UPS.

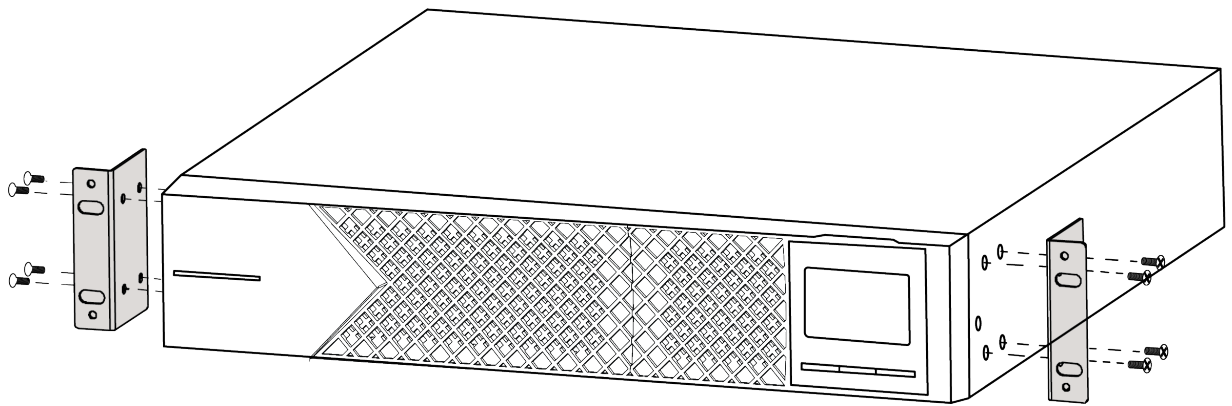

2. Mount it in the rack using standard rack screws.

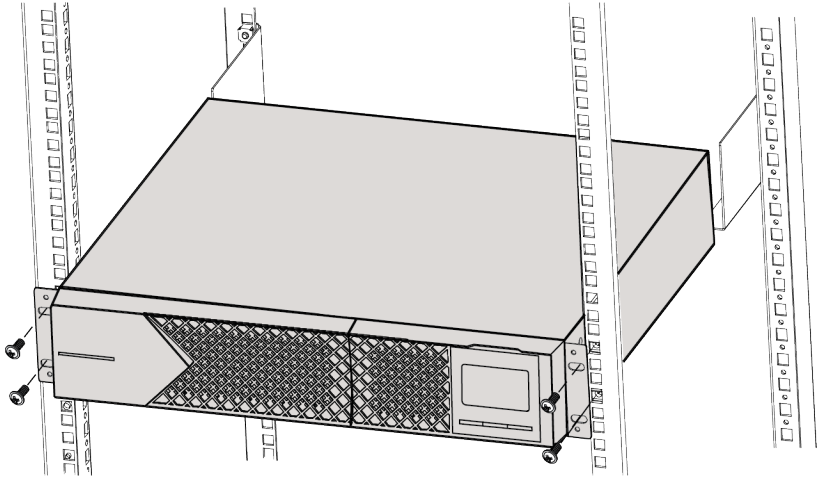

 **Pro Tip:** Mount the UPS at the bottom of the rack so it does not tip over.

---

## External Battery Pack compatibility

The WB-OVRC-OLUPS-1000-1 is only compatible with the External Battery Pack (WB-UPS-EBP-18AH24V).

The WB-OVRC-OLUPS-1500-1 and WB-OVRC-OLUPS-2000-1 are only compatible with the External Battery Pack (WB-UPS-EBP-18AH48V).

## External Battery Pack installation

1. Use a Phillips screwdriver to remove the cover of the **Ext Battery Connection** port on the back of the UPS.

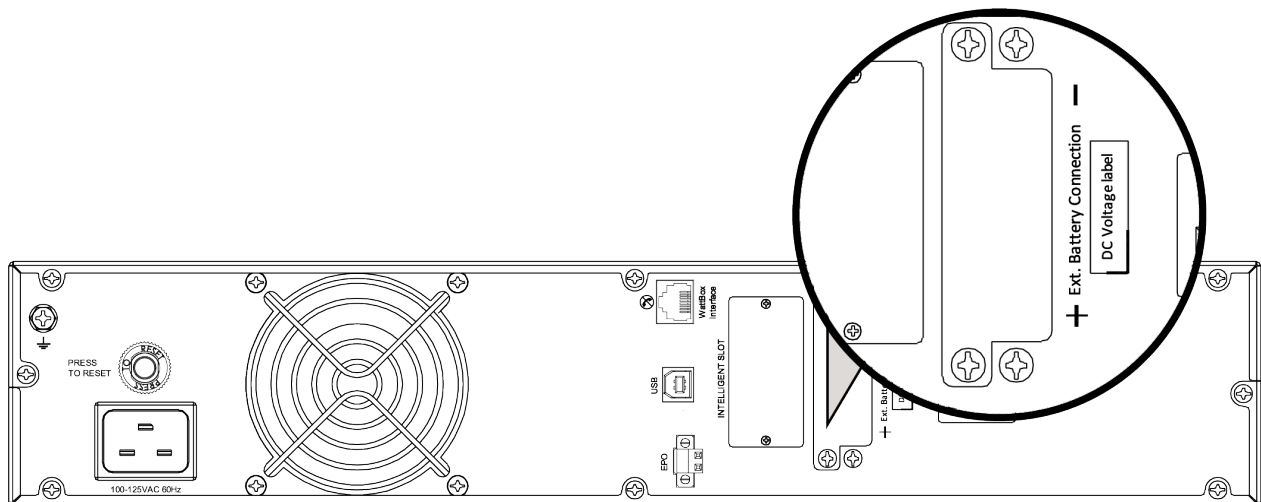

2. Plug the cable connector into the **Ext Battery Connection** port of the UPS and the battery pack(s).

 **Note:** A maximum of five Extended Battery Packs can be daisy-chained off of one UPS. Connect multiple battery packs in series by connecting the second battery connection port of the first battery pack to the first battery connection port of the second battery pack.

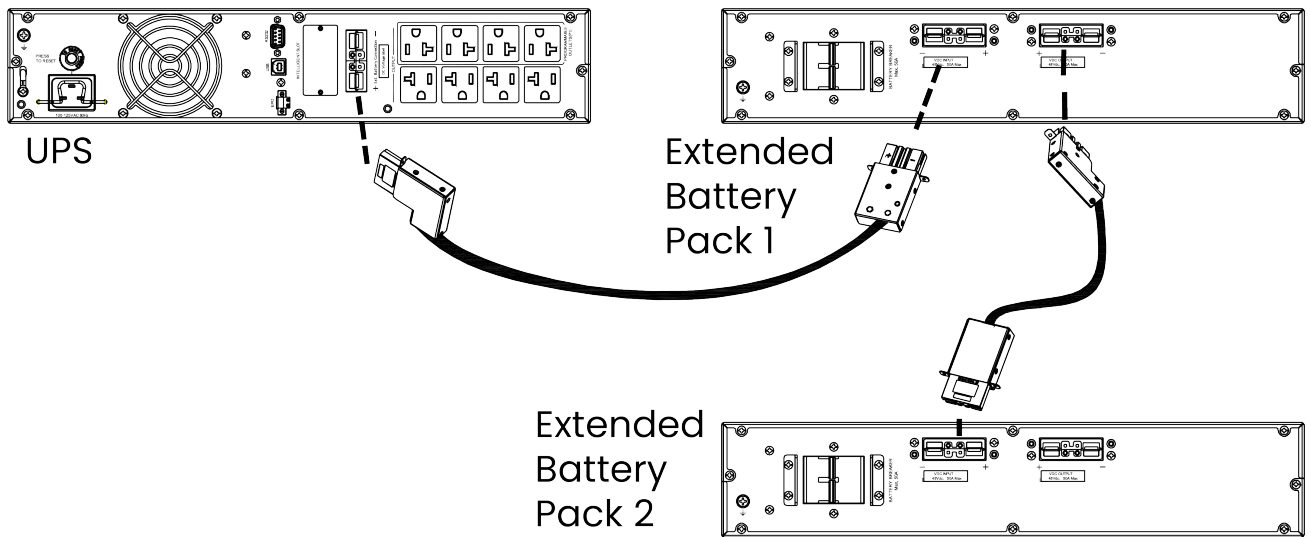

3. Secure the connector housings to the unit and the battery pack(s) with screws.

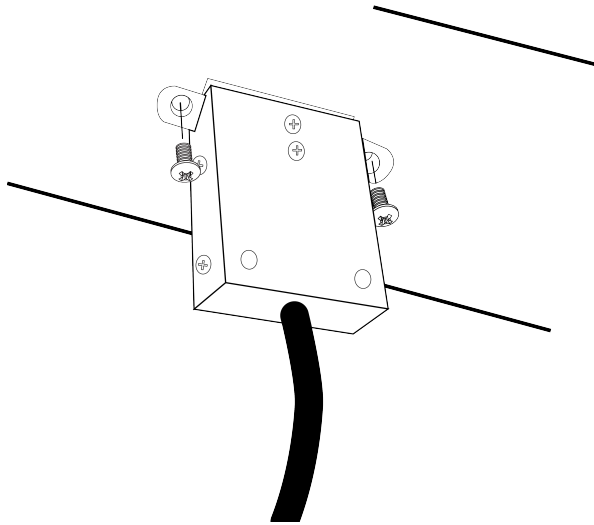

4. On the back of each Extended Battery Pack, set the breaker to **On**.



**Note:** The UPS auto-detects the Extended Battery Packs. The safe recharge rate is automatically configured based on the number of Extended Battery Packs detected.

---

## Disable or enable the Emergency Power Off (EPO) function

The EPO feature uses a simple open/closed circuit that, when opened, causes the UPS to immediately shut off power to all outlets.

By default, the UPS is delivered with Pin 1 and Pin 2 closed (a metal plate is connected to Pin 1 and Pin 2) for normal operation. To activate the EPO function, remove the two screws on the EPO port to remove the metal plate connecting the pins.

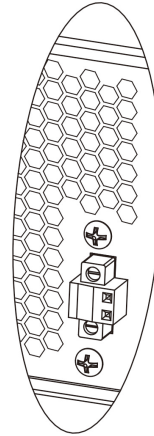

### EPO Reset

To restore normal operation after engaging EPO, the UPS must be turned off and back on using the front panel LCD buttons.



**Note:** Configure the EPO function logic through the LCD. Refer to [program 16 in UPS settings](#) for details.





---

## UPS input connection

Plug the UPS into a two-pole, three-wire, grounded receptacle only. Avoid using extension cords.

For 100/110/115/120/125/127VAC models, the power cord attaches to the UPS input plug (NEMA 5-15P for 1K and 1.5K models).

 **Note:** If the Site Wiring Fault indicator () lights up in LCD panel, the UPS is plugged into an improperly wired power outlet. Refer to the "Troubleshooting" on [page 37](#) section for more information.

---

## Turning on the UPS

Press the **ON/Mute** button for two seconds to power on the UPS.

 **Note:** The battery fully charges during the first five hours of normal operation. Do not expect full battery capability during this initial charge period.

---

## Adding the UPS to OvrC

---

OvrC-enabled WattBox UPSes are specifically designed for WattBox IP power conditioners with a UPS link port.

1. Connect an Ethernet cable between the UPS Link ports on the WattBox PDU and UPS.
2. Connect the power cable from the outlet of the UPS to the power inlet of the WattBox.
3. Navigate to the connected PDU in OvrC to view the UPS battery health, total load, and configure UPS settings.

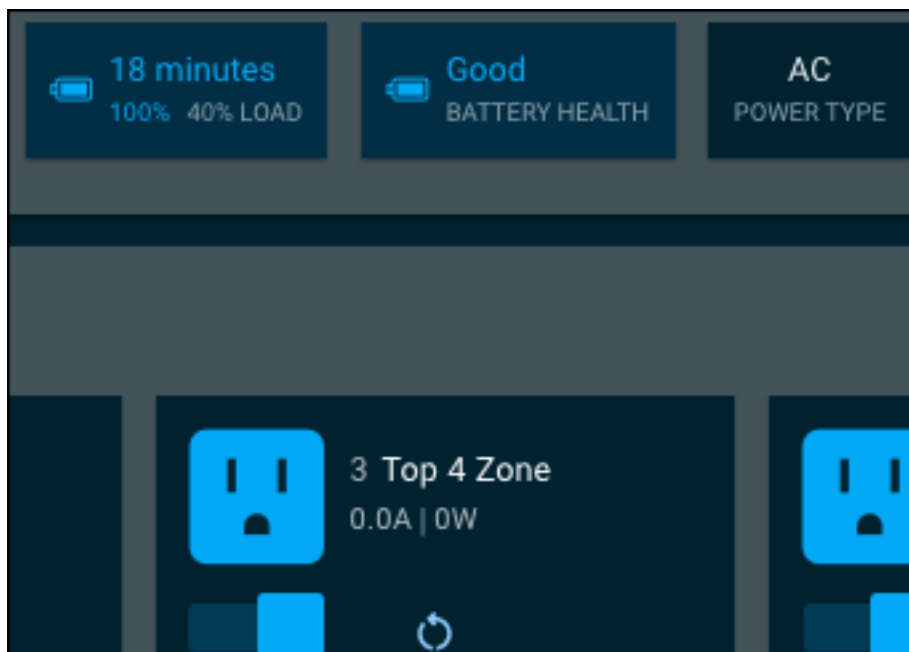

# Front panel & button operations

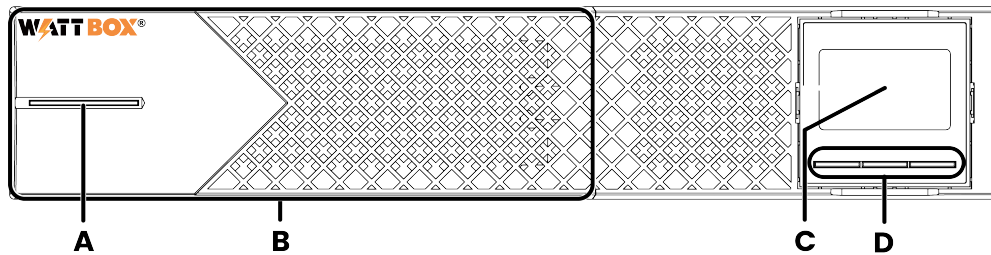

- A. **Power LED** – Illuminates solid blue when the UPS is powered on.
- B. **Removable battery cover** – Lift from the left side to access the internal batteries.
- C. **LCD display** – Used for monitoring and configuring the UPS.
- D. **Control and navigational buttons** – Used to control the UPS and navigate the LCD menus. The functions are described in the table below.

Button	Functions
ON/Mute	<b>Turn on the UPS</b> – Press and hold the ON/Mute button for at least 2 seconds to turn on the UPS.
	<b>Mute the alarm</b> – After the UPS switches to battery mode, press and hold the ON/Mute button for at least 3 seconds to disable or enable the alarm. This does not work for <b>faults or warnings</b> .
	<b>Up key</b> – Press this button to display the previous option when navigating settings.
	<b>Switch to UPS self-test mode</b> – Press and hold the ON/Mute button for 3 seconds to enter UPS self-testing while in AC mode, ECO mode, or Converter mode. The self test verifies the UPS subsystems are working properly.

 **Pro Tip:** Let the battery fully charge before running a self-test.

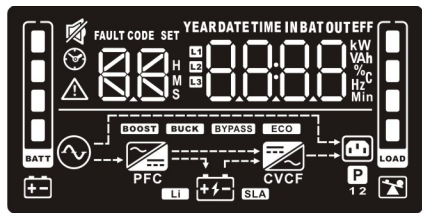

<b>OFF/Enter</b>	<p><b>Turn off the UPS</b> – Press and hold this button for at least 2 seconds put the UPS in Standby mode or <b>Bypass mode</b>, if enabled.</p>
	<p><b>Confirm selection</b> – Press this button to confirm your selection.</p>
<b>Select</b>	<p><b>Switch the LCD display</b> – Press this button to change the LCD display between input voltage, input frequency, input current, battery voltage, battery current, battery capacity, ambient temperature, output voltage, output frequency, load current and load percent, and External Battery Pack number.</p>
	<p><b>Setting mode</b> – Press and hold the Select button for 3 seconds to open the Settings menu from Standby or Bypass mode</p>
	<p><b>Down key</b> – Press this button to display the next option when navigating settings.</p>
<b>ON/Mute + Select simultaneously</b>	<p><b>Switch to Bypass mode</b> – When the main power is normal, press and hold the ON/Mute and Select buttons simultaneously for 3 seconds enter to Bypass mode. This does not work if the input voltage is out of an acceptable range.</p>
	<p><b>Exit the setting menu or return to the upper menu</b> – While navigating the Setting menu, press the ON/Mute and Select buttons simultaneously to return to the previous menu. If it's already at the top Settings menu, this exists the Settings menu.</p>

# Reading the LCD panel



Display	Function
<b>Backup time information</b>	
	Displays the estimated battery backup time. H: hours, M: minute, S: second.
<b>Configuration and fault information</b>	
	Displays the configurable "UPS Settings" on page 25.
	Displays the "Fault reference codes" on page 33 codes.
<b>Mute operation</b>	
	Indicates that the UPS alarm is disabled.
<b>Input, Battery, Temperature, Output &amp; Load information</b>	
	Displays the input voltage, input frequency, input current, battery voltage, battery current, battery capacity, ambient temperature, output voltage, output frequency, load current and load percentage.  k: kilo, W: watt, V: voltage, A: ampere, %: percent, °C: centigrade degree, Hz: frequency











## Load information

	Displays the load level by 0-24%, 25-49%, 50-74% and 75-100%.
	Indicates the UPS is overloaded.



## Programmable outlets information

	Indicates that the programmable outlets are working.
---	--

## Mode operation information

	Indicates the UPS is connected to the mains power.
	Indicates the battery is working.
	Indicates the the UPS is charging.
	Indicates the bypass circuit is working.
	Indicates ECO mode is enabled.
	Indicates the AC to DC circuit is working.
	Indicates the PFC circuit is working.
	Indicates the inverter circuit is working.
	Indicates the UPS is in Converter mode.
	Indicates the UPS output is working.

## Battery information

	Displays the battery level by 0-24%, 25-49%, 50-74%, and 75-100%.
	Indicates low battery.

## LCD display wordings index

Abbreviation	Display content	Meaning
ENA	ENR	Enable
DIS	di S	Disable
ESC	ESC	Escape
HLS	HLS	High loss
LLS	LLS	Low loss
AO	AO	Active open
AC	AC	Active close
EAT	EAT	Estimated autonomy time
RAT	RAT	Running autonomy time
SD	Sd	Shutdown
OK	OK	OK
ON	ON	ON
BL	BL	Battery low
OL	OL	Overload
OI	OI	Over input current
NC	NC	Battery No Connect

OC	OC	Over charged
SF	SF	Site wiring fault
EP	EP	EPO
TP	TP	Temperature
CH	CH	Charger
BF	BF	Battery fault
BV	bV	Bypass out of range
FU	FU	Bypass frequency unstable
BR	BR	Battery replace
EE	EE	EEPROM error
BP	BP	Battery packs



# UPS Settings

Press and hold the **Select** button for 3 seconds to open the Settings menu from Standby or Bypass mode.

Each UPS setting is assigned an index number, displayed on the left of the LCD Panel. The configurable value or option is displayed on the right.

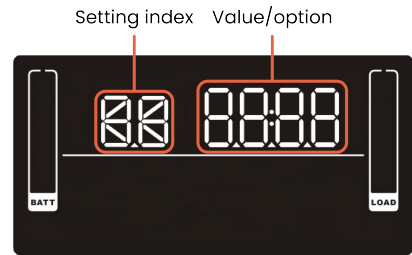

Use the **On/Mute** button to move **up**, the **Select** button to move **down**, and press **Off/Enter** to confirm your selections. Press the **ON/Mute** and **Select** buttons simultaneously to return to the previous menu.

## 01: Output voltage setting



The output voltage is configurable to one of the following values:

- 100VAC
- 110VAC
- 115VAC
- 120VAC (Default)
- 125VAC
- 127VAC (not applicable to U.S. voltage)

## 02: Frequency Converter enable/disable



Enable or disable Converter mode.

- CF ENA: Enable
- CF DIS: Disable (Default)

## 03: Output frequency setting



Set the frequency for for Battery mode to 50 or 60Hz.

- BAT 50 (50Hz)
- BAT 60 (60Hz)

Frequency options for Converter mode:

- CF 50 (50Hz)
- CF 60 (60Hz)

## 04: ECO enable/disable

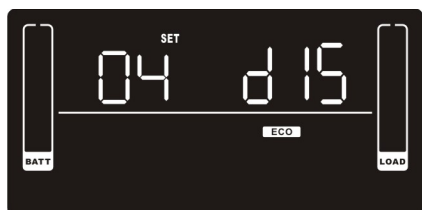

Enable or disable ECO function.

- ENA: Enable
- DIS: Disable (Default)

## 05: ECO voltage range setting

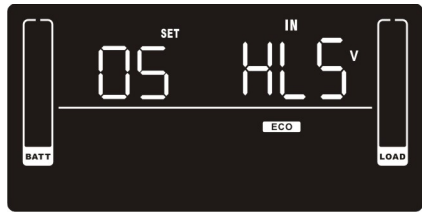

Select the acceptable high voltage and low voltage point for ECO mode.

### **HLS: High loss voltage**

Set the voltage between +3V and +12V of the nominal voltage. (Default: +6V)

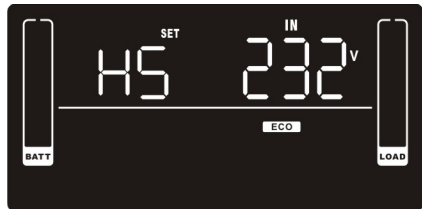

### **LLS: Low loss voltage**

Set the voltage between -3V and -12V of the nominal voltage. (Default: -6V)

## 06: Bypass enable/disable when UPS is off

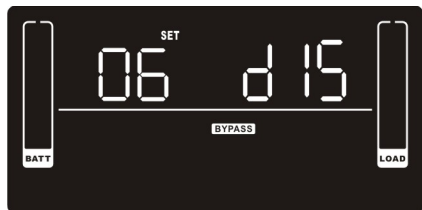

Enable or disable the Bypass function.

- ENA: Enable
- DIS: Disable (Default)

## 07: Bypass voltage range setting

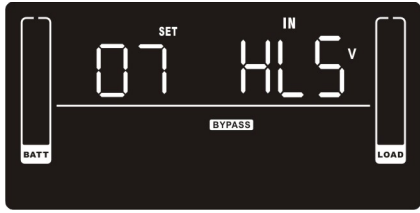

Set the acceptable high voltage point and acceptable low voltage point for Bypass mode.

### **HLS: Bypass high voltage point**

Set the high voltage point in parameter between 120VAC and 140VAC. (Default: 132VAC)

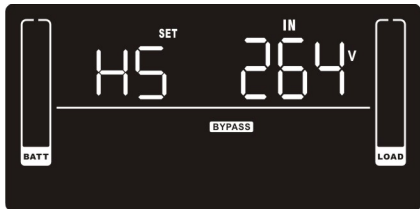

### **LLS: Bypass low voltage point**

Set the low voltage point between 85VAC and 115VAC. (Default: 85VAC)

## 08: Bypass frequency range setting

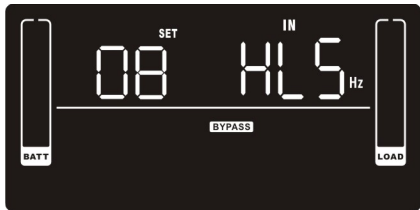

Set the acceptable high frequency point and acceptable low frequency point for Bypass mode.

### **HLS: Bypass high frequency point**

For 50Hz output frequency models: Set the frequency high loss point between 51H and 55HZ(Default: 53.0Hz)

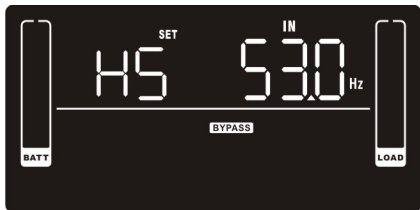

For 60Hz output frequency models: Set the frequency high loss point between 61Hz and 65Hz(Default: 63.0Hz)

### **LLS: Bypass low Frequency point**

For 50Hz output frequency models: Set the frequency low loss point between 45H and 49HZ(Default: 47.0Hz)

For 60Hz output frequency models: Set the frequency low loss point between 55H and 59Hz(Default: 57.0Hz)

## 09: Programmable outlets enable/disable

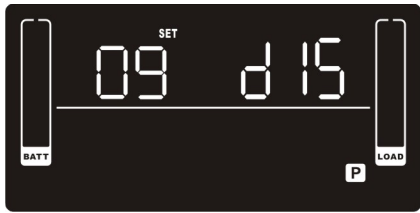

Enable or disable programmable outlets. For UPS models ending with "8."

- ENA: Programmable outlets enable
- DIS: Programmable outlets disable (Default)

## 10: Programmable outlets setting



Set the amount of time, in minutes, for the programmable outlets to receive battery backup power. Configurable between 0-999. (Default: 999) For UPS models ending with "8."



**Note:** When set to 0, the backup time is 10 seconds.

## 11: Autonomy limitation setting



Set the amount of time, in minutes, for the always-on outlets to receive battery backup power, or disable the limitation. Configurable between 0-999. For UPS models ending with "8."

DIS: Disable the autonomy limitation and the backup time depends on battery capacity. (Default)



**Note:** When set to 0, the backup time is 10 seconds.

## 14: Charger boost voltage setting



Set the charger boost voltage between 2.25 V/cell to 2.40V/cell. (Default: 2.36V/cell)

## 15: Charger float voltage setting



Set the charger float voltage between 2.20 V/cell to 2.33V/cell. (Default: 2.28V/cell)

## 16: EPO logic setting



Set the Emergency Power Off (EPO) control logic.

- AO: Active Open (Default). Activates EPO with Pin 1 and Pin 2 in open status.
- AC: Active Close. Activates with Pin 1 and Pin 2 in close status.

## 17: Site fault detection enable/disable



Enable or disable site fault detection to be alerted if the UPS detects an issue from the mains.

- ENA: Enable (Default for 120 models)
- DIS: Disable

## 18: Display setting for autonomy time



Select how the battery autonomy time is displayed.

- EAT: If EAT is selected, it displays the remaining autonomy time. (Default)
- RAT: If RAT is selected, it displays the accumulated autonomy time so far.



## 00: Exit setting

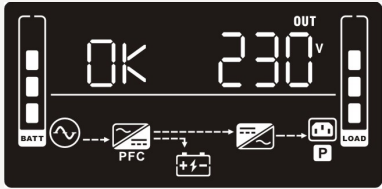
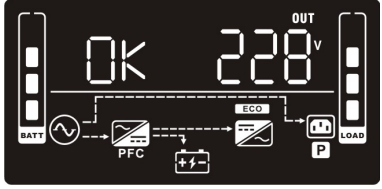

Exits the Settings menu.

## Operating modes

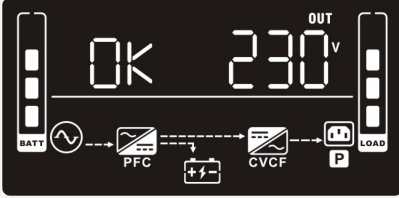
Operating mode	Description	LCD display
<b>Online mode</b>	When the input voltage is within the acceptable range, the UPS provides stable AC power to connected devices and charges the battery.	
<b>ECO mode</b>	When the input voltage is within regulation range, the UPS bypasses voltage to output to conserve energy. The UPS does charge the battery in this mode.	

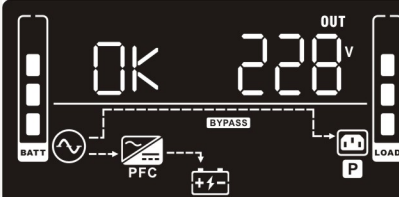
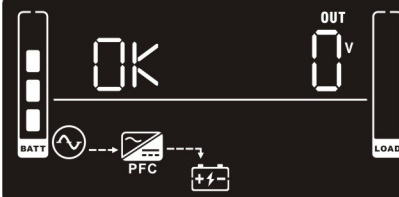
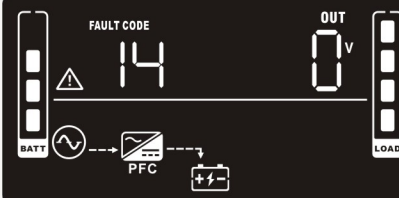
<p><b>Frequency Converter mode</b></p>	<p>When the input frequency is within 40 Hz to 70 Hz, the UPS sets the output frequency to a constant 50 Hz or 60 Hz. The UPS does charge the battery in this mode.</p>	
<p><b>Battery mode</b></p>	<p>When the input voltage is beyond the acceptable range or there's no power from the mains, the UPS provides backup power from the batteries and an alarm beeps every 5 seconds.</p>	
<p><b>Bypass mode</b></p>	<p>When the input voltage is within the acceptable range, but the UPS is overloaded, it enters Bypass mode. Bypass mode can also be set using the front panel. The alarm beeps every 10 seconds in Bypass mode.</p>	
<p><b>Standby mode</b></p>	<p>The UPS is powered off and not supplying power, but is still charging the batteries.</p>	
<p><b>Fault mode</b></p>	<p>When a fault occurs, an Error icon and fault code are displayed. See "<a href="#">Fault reference codes</a>" on the facing page for more information.</p>	

## Alarms

<p><b>Battery Mode</b></p>	<p>Beeps every 5 seconds</p>
----------------------------	------------------------------

















<b>Low Battery</b>	Beeps every 2 seconds
<b>Overload</b>	Beeps every second
<b>Fault</b>	Continuously beeps
<b>Bypass Mode</b>	Beeps every 10 seconds

Faults and warnings

## Fault reference codes

<b>Fault event</b>	<b>Fault code</b>	<b>Icon</b>	<b>Fault event</b>	<b>Fault code</b>	<b>Icon</b>
Bus start fail	01	x	Battery voltage too high	27	x
Bus over	02	x	Battery voltage too low	28	x
Bus under	03	x	Charger output short	2A	x
Inverter soft start fail	11	x	Over temperature	41	x
Inverter voltage high	12	x	Overload	43	
Inverter voltage Low	13	x	Charger failure	45	x
Inverter output short	14	x	Over input current	49	x

## Warning indicator references

Warning	Icon (flashing)	Code	Alarm
Low Battery		BL	Beeps every 2 seconds
Overload		OL	Beeps every second
Over input current		OI	Beeps 2 beep every 10 seconds
Battery is not connected		NC	Beeps every 2 seconds
Over Charge		OC	Beeps every 2 seconds
Site fault detection		SF	Beeps every 2 seconds
EPO enable		EP	Beeps every 2 seconds
Over temperature		EP	Beeps every 2 seconds
Charger failure		CH	Beeps every 2 seconds
Battery fault		BF	Beeps every 2 seconds and the UPS powers off
Out of bypass voltage range		bV	Beeps every 2 seconds
Bypass frequency unstable		FU	Beeps every 2 seconds
Battery replacement		bR	Beeps every 2 seconds
EEPROM error		EE	Beeps every 2 seconds



**Note:** Site fault detection can be enabled/disabled using the display or monitoring software.

## Monitoring software

To monitor the UPS status and schedule shutdown and start ups, connect the UPS to a PC running the monitoring software. Follow these steps to install the software:

1. Use the supplied RS-232 or USB cable to connect the UPS to the PC. If using an SNMP card (sold separately), power off the UPS before installing it.

USB port

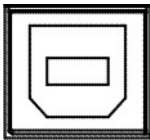

RS-232

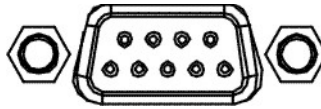

SNMP Intelligent slot

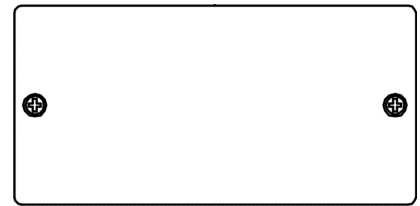

2. Download the software from **this link** (link incoming).
3. Follow the on-screen instructions to install the software. Installation requires the PC to restart.
4. After your computer restarts, the monitoring software appears as an orange plug icon in the system tray, near the clock.

---

## Storage and Maintenance

The UPS does not have user-serviceable parts. If the battery life has been exceeded (~ 3-5 years at 25°C ambient temperature) , the batteries must be replaced by your installer.



Deliver the spent battery to a recycling facility.









### Storage





Charge the UPS 5 hours before storing the UPS covered in a cool, dry location. During storage, recharge the battery in accordance with the following table:

<b>Storage Temperature</b>	<b>Recharge Frequency</b>	<b>Charging Duration</b>
-25°C - 40°C	Every 3 months	1-2 hours
40°C - 45°C	Every 2 months	1-2 hours

# Troubleshooting

Use this table for troubleshooting help.

Symptom	Possible cause	Remedy
<b>Alarm is sounding even though the mains is normal.</b>	The AC input power is not connected well.	Check if input power cord firmly connected to the mains.
	The AC input is connected to the UPS output.	Plug AC input power cord to AC input correctly.
 and the  warning icon are flashing on the display, and the alarm is sounding every 2 seconds.	EPO function is activated.	Set the circuit in closed position to disable EPO function.
 ,  and the  warning icon are flashing on the display, and the alarm is sounding every 2 seconds.	Line and neutral conductors of UPS input are reversed.	Rotate mains power socket by 180° and then connect to UPS.
 ,  and the  warning icon are flashing on the display, and the alarm is sounding every 2 seconds.	The external or internal battery is incorrectly connected.	Check if all batteries are connected well.
<b>Fault code 27 is on the display, and the alarm is continuously</b>	Battery voltage is too high or the charger is fault.	Contact your dealer.

<p><b>sounding.</b></p> <p><b>Fault code 28 is on the display, and the alarm is continuously sounding.</b></p>	<p>Battery voltage is too low or the charger is fault.</p>	<p>Contact your dealer.</p>
<p>,  and the  warning is flashing on the display, and the alarm is sounding every second.</p> <p><b>Fault code 49 is on the display, and the alarm is continuously sounding.</b></p>	<p>UPS is overloaded. Devices connected to the UPS are fed directly by the electrical network via the Bypass.</p> <p>After repetitive overloads, the UPS is locked in the Bypass mode. Connected devices are fed directly by the mains.</p>	<p>Remove excess loads from UPS output.</p> <p>Remove excess loads from UPS output first. Then shut down the UPS and restart it.</p>
<p><b>Fault code 49 is on the display, and the alarm is continuously sounding.</b></p>	<p>UPS is over input current.</p>	<p>Remove excess loads from UPS output.</p>
<p><b>Fault code 43 and  is flashing on the display, and the alarm is continuously sounding.</b></p>	<p>The UPS shut down automatically because of overload at the UPS output.</p>	<p>Remove excess loads from UPS output and restart it.</p>
<p><b>Fault code 14 is on the display, and the alarm is continuously sounding.</b></p>	<p>The UPS shut down automatically because short circuit occurs on the UPS output.</p>	<p>Check output wiring and if connected devices are in short circuit status.</p>

<p><b>Fault codes 01, 02, 03, 11, 12, 13 and 41 are on the display, and the alarm is continuously sounding.</b></p>	<p>A UPS internal fault has occurred. There are two possible results:</p> <p>1. The load is still supplied, but directly from AC power via bypass.</p>	<p>Contact your dealer</p>
<p><b>Battery backup time is shorter than nominal value.</b></p>	<p>Batteries are not fully charged</p>	<p>Charge the batteries for at least 5 hours and then check capacity. If the problem still persists, consult your dealer.</p>
<p><b>Fault code 2A is on the display, and the alarm is continuously sounding.</b></p>	<p>The short circuit occurs on the charger output.</p>	<p>Check if battery wiring of connected external pack is in short circuit status.</p>
<p><b>Fault code 45 is on the display, and the alarm is continuously sounding.</b></p>	<p>The charger does not have output and battery voltage is less than 10V/PC.</p>	<p>Contact your dealer.</p>

# Specifications

<b>Model (RT UL model)</b>	WB-UPS-OL- 1000-8	WB-UPS-OL- 1500-8	WB-UPS-OL- 2000-8
<b>Capacity*</b>	1000VA/1000W	1500VA/1500W	2000VA/2000W
<b>Input</b>			
<b>Voltage Range</b>	<b>Low Line Transfer</b>	80VAC/70VAC/60VAC/55VAC ± 5 % ( based on load percentage 100% - 80 % / 80 % - 70 % / 70 - 60 % / 60 % - 0)	
	<b>Low Line Comeback</b>	87VAC/77VAC/67VAC/62VAC ± 5 %	
	<b>High Line Transfer</b>	150 VAC ± 5 %	
	<b>High Line Comeback</b>	145 VAC ± 5 %	
<b>Frequency Range</b>	40Hz ~ 70 Hz		
<b>Phase</b>	Single phase with ground		
<b>Power Factor</b>	≥ 0.99 @ full load		
<b>THDI</b>	≤ 5% @ 160-265VAC or 80-140VAC THDU < 1.6% @ input and full linear load condition		
<b>Output</b>			
<b>Output voltage</b>	100/110/115/120/125/127 VAC**		
<b>AC Voltage Regulation</b>	± 1% (Batt. Mode)		
<b>Frequency Range (Synchronized Range)</b>	47 ~ 53 Hz or 57 ~ 63 Hz		
<b>Frequency Range</b>	50 Hz ± 0.1 Hz or 60Hz ± 0.1 Hz (Batt. Mode)		
<b>Current Crest Ratio</b>	3:1		



<b>Harmonic Distortion</b>		$\leq 2\%$ THD (Linear Load) ; $4\%$ THD (Non-linear Load)		
<b>Transfer Time</b>	<b>AC Mode to Batt. Mode</b>	Zero		
	<b>Inverter to Bypass</b>	< 4 ms		
<b>Waveform (Batt. Mode)</b>		Pure Sinewave		
<b>Efficiency</b>				
<b>AC Mode</b>		$\geq 89\%$ @ full charged battery	$\geq 91\%$ @ full charged battery	
<b>ECO Mode</b>		$\geq 96\%$ @ full charged battery		
<b>Battery Mode</b>		$\geq 88\%$	$\geq 90\%$	
<b>Battery</b>				
<b>Battery Type</b>		12V/9AH	12V/9AH	
<b>Numbers</b>		2	4	
<b>Recharge Time</b>		3 hours recover to 95% capacity for internal battery@ 2A charging current		
<b>Charging Current</b>		Default: 2A, Max: 8A adjustable		
<b>Charging Voltage</b>		27.4 VDC $\pm 1\%$	54.7 VDC $\pm 1\%$	
<b>Physical</b>				
<b>Dimension, D X W X H (mm)</b>		410 x 438 x 88	510 x 438 x 88	
<b>Net Weight (kgs)</b>	<b>With battery</b>	11.6	19.5	19.5
	<b>Without battery</b>	6.6	9.4	9.4
<b>Environmental</b>				
<b>Operation Humidity</b>		20-95 % RH @ 0- 40°C (non-condensing)		
<b>Noise Level</b>		Less than 50dBA @ 1 Meter (With fan speed control)		

<b>Management</b>	
<b>Smart RS-232 or USB</b>	Supports Windows® 2000/2003/XP/Vista/2008/7/8/10, Linux, Unix and MAC
<b>Optional SNMP</b>	Power management from SNMP manager and web browser

\* Derate capacity to 90% of capacity when the output voltage is adjusted to 100VAC, 200VAC or 208VAC.

\*\*For 120VAC system, the output power ratings are different based on different input voltage. Please check output power rating table for the details. (127 is not applicable to U.S. voltage)

\*\*\* Product specifications are subject to change without further notice.

## Output Power Rating Table

Model	Input rating	Output rating
WB-UPS-OL-1000-8	100-125VAC, 50/60Hz, 12A, 1Ø	100/110/115/120/125VAC, 50/60Hz, 1000VA/1000W, 1Ø, 10/9.1/8.7/8.3/8A
WB-UPS-OL-1500-8	100-125VAC, 50/60Hz, 12A, 1Ø	100/110/115/120/125VAC, 50/60Hz, 1Ø 1500VA/1430W,12A (@125VAC input) ; 1500VA/1300W,12.5A (@120VAC input) ; 1500VA/1270W,13A (@115VAC input) ; 1500VA/1200W,13.6A (@110VAC input) ; 1350VA/1040W,13.5A (@100VAC input)
WB-UPS-OL-2000-8	100-125VAC, 50/60Hz, 16A, 1Ø	100/110/115/120/125VAC, 50/60Hz, 1Ø 2000VA/1930W,16A (@125VAC input) ; 2000VA/1850W,16.7A (@120VAC input) ; 2000VA/1740W,17.4A (@115VAC input) ; 2000VA/1640W,18.2A (@110VAC input) ; 1800VA/1500W,18A (@100VAC input)

## Runtime Chart (internal battery)

<b>Model &amp; battery size</b>	WB-UPS-OL-1000-8 (9Ah x 2)	WB-UPS-OL-1500-8 (9Ah x 4)	WB-UPS-OL-2000-8 (9Ah x 4)
<b>Battery load percentage</b>	<b>Estimated runtime</b>		
<b>100.00%</b>	2 minutes 25 seconds	4 minutes 51 seconds	2 minutes 26 seconds
<b>90.00%</b>	3 minutes 11 seconds	5 minutes 50 seconds	3 minutes 11 seconds
<b>80.00%</b>	4 minutes 8 seconds	7 minutes 16 seconds	4 minutes 40 seconds
<b>70.00%</b>	5 minutes 19 seconds	9 minutes 50 seconds	5 minutes 19 seconds
<b>60.00%</b>	6 minutes 56 seconds	11 minutes 26 seconds	7 minutes 40 seconds
<b>50.00%</b>	9 minutes 26 seconds	14 minutes 46 seconds	9 minutes 34 seconds
<b>40.00%</b>	12 minutes 55 seconds	19 minutes 57 seconds	13 minutes 12 seconds
<b>30.00%</b>	18 minutes 31 seconds	28 minutes 39 seconds	19 minutes 17 seconds
<b>20.00%</b>	29 minutes 54 seconds	41 minutes 12 seconds	31 minutes 40 seconds
<b>10.00%</b>	63 minutes 40 seconds	91 minutes 19 seconds	68 minutes 23 seconds

---

## Battery Pack Specification

	<b>WB-UPS-EBP-18AH24V</b>	<b>WB-UPS-EBP-18AH48V</b>
<b>Used with UPS Models</b>	WB-UPS-OL-1000-8	WB-UPS-OL-1500-8 WB-UPS-OL-2000-8
<b>Battery Type</b>	12V 9Ah	12V 9Ah
<b>Battery Numbers</b>	4	8
<b>Dimensions (DxWxH) mm</b>	380 x 438 x 88	480 x 438 x 88
<b>Net Weight(kgs)</b>	17.1	29



**Note:** Battery pack should be used with corresponding UPS.

## Technical Support

For chat and telephone, visit [snpl.co/techsupport](https://snpl.co/techsupport) • Email:

[TechSupport@SnapOne.com](mailto:TechSupport@SnapOne.com). Visit [snpl.co/tc](https://snpl.co/tc) for discussions, instructional videos, news, and more.

## Warranty and Legal Notices

Find details of the product's Limited Warranty and other resources such as regulatory notices and patent and safety information, at [snapone.com/legal](https://snapone.com/legal) or request a paper copy from Customer Service at **866.424.4489**.

Copyright©2024, Snap One, LLC. All rights reserved. Snap One and its respective logos are registered trademarks or trademarks of Snap One, LLC (formerly known as Wirepath Home Systems, LLC), in the United States and/or other countries. 4Store, 4Sight, Control4, Control4 My Home, SnapAV, Araknis Networks, BakPak, Binary, Dragonfly, Episode, Luma, Mockupancy, Nearus, NEEO, Optiview, OvrC, Pakedge, Sense, Strong, Strong Evolve, Strong VersaBox, SunBriteDS, SunBriteTV, Triad, Truvision, Visualint, WattBox, Wirepath, and Wirepath ONE are also registered trademarks or trademarks of Snap One, LLC. Other names and brands may be claimed as the property of their respective owners. Snap One makes no claim that the information contained herein covers all installation scenarios and contingencies, or product use risks. Information within this specification subject to change without notice.

241029

200-01035 QUICK START GUIDE, WB-UPS-OL-A