

14.56

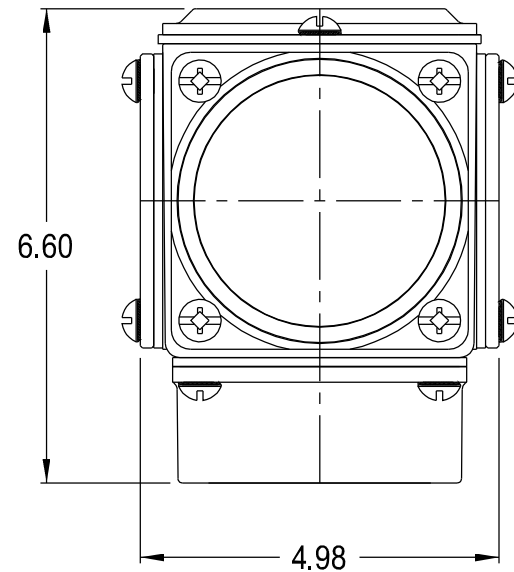

6.60

4.98