

MicroScanner™ Series

Cable Verifiers

Users Manual

LIMITED WARRANTY AND LIMITATION OF LIABILITY

Each Fluke Networks product is warranted to be free from defects in material and workmanship under normal use and service unless stated otherwise herein. The warranty period for the mainframe and wiremap adapter is one year and begins on the date of purchase. Parts, accessories, product repairs and services are warranted for 90 days, unless otherwise stated. Ni-Cad, Ni-MH and Li-Ion batteries, cables or other peripherals are all considered parts or accessories. The warranty extends only to the original buyer or end user customer of a Fluke Networks authorized reseller, and does not apply to any product which, in Fluke Networks' opinion, has been misused, abused, altered, neglected, contaminated, or damaged by accident or abnormal conditions of operation or handling. Fluke Networks warrants that software will operate substantially in accordance with its functional specifications for 90 days and that it has been properly recorded on non-defective media. Fluke Networks does not warrant that software will be error free or operate without interruption.

Fluke Networks authorized resellers shall extend this warranty on new and unused products to end-user customers only but have no authority to extend a greater or different warranty on behalf of Fluke Networks. Warranty support is available only if product is purchased through a Fluke Networks authorized sales outlet or Buyer has paid the applicable international price. To the extent permitted by law, Fluke Networks reserves the right to invoice Buyer for repair/replacement when a product purchased in one country is submitted for repair in another country.

For a list of authorized resellers, visit www.flukenetworks.com/wheretobuy.

Fluke Networks warranty obligation is limited, at Fluke Networks option, to refund of the purchase price, free of charge repair, or replacement of a defective product which is returned to a Fluke Networks authorized service center within the warranty period.

To obtain warranty service, contact your nearest Fluke Networks authorized service center to obtain return authorization information, then send the product to that service center, with a description of the difficulty, postage and insurance prepaid (FOB destination). Fluke Networks assumes no risk for damage in transit. Following warranty repair, the product will be returned to Buyer, transportation prepaid (FOB destination). If Fluke Networks determines that failure was caused by neglect, misuse, contamination, alteration, accident or abnormal condition of operation or handling, or normal wear and tear of mechanical components, Fluke Networks will provide an estimate of repair costs and obtain authorization before commencing the work. Following repair, the product will be returned to the Buyer transportation prepaid and the Buyer will be billed for the repair and return transportation charges (FOB Shipping point).

THIS WARRANTY IS BUYER'S SOLE AND EXCLUSIVE REMEDY AND IS IN LIEU OF ALL OTHER WARRANTIES, EXPRESS OR IMPLIED, INCLUDING BUT NOT LIMITED TO ANY IMPLIED WARRANTY OF MERCHANTABILITY OR FITNESS FOR A PARTICULAR PURPOSE. FLUKE NETWORKS SHALL NOT BE LIABLE FOR ANY SPECIAL, INDIRECT, INCIDENTAL OR CONSEQUENTIAL DAMAGES OR LOSSES, INCLUDING LOSS OF DATA, ARISING FROM ANY CAUSE OR THEORY.

Since some countries or states do not allow limitation of the term of an implied warranty, or exclusion or limitation of incidental or consequential damages, the limitations and exclusions of this warranty may not apply to every buyer. If any provision of this Warranty is held invalid or unenforceable by a court or other decision-maker of competent jurisdiction, such holding will not affect the validity or enforceability of any other provision.

4/15-MS

Fluke Networks
PO Box 777
Everett, WA 98206-0777
USA

Contents

Title	Page
Introduction	1
Registration	2
Contacting Fluke Networks	2
Symbols	2
 Safety Information	4
MicroScanner PoE Features	7
MicroScanner PoE Display Features	9
MicroScanner ² Features	11
MicroScanner ² Display Features	13
Auto Shutoff	14
Changing the Length Units	14
Using the Wiremap Adapter and Remote ID Locators	15
Testing Twisted Pair Cabling	16
Open on Twisted Pair Cabling	17

MicroScanner Series Cable Verifiers

Users Manual

Typical Causes of Opens	17
Short on Twisted Pair Cabling	18
Typical Causes of Shorts	18
Crossed Wires	19
Crossed Pairs	19
Typical Causes of Crossed Pairs	19
Split Pair	20
Telephone Voltages Detected	21
Bridge Tap Detected	23
Ethernet Port Detected	25
Viewing Details for a Wire Pair	27
Using Multiple Remote ID Locators	29
Connecting to Telephone Networks Wired in Star Topologies	31
Connecting to Telephone Networks Wired in Bus Topologies	33
Testing Coaxial Cabling (MicroScanner ²)	35
Results for a Good Coaxial Cable	36
Open on Coaxial Cabling	36
Short on Coaxial Cabling	37
Unknown Termination on Coaxial Cabling	37
Detecting Power Over Ethernet	38

MicroScanner ²	38
MicroScanner PoE	39
Using the Toner	46
Toning in IntelliTone Mode (optional IntelliTone probe required)	46
Analog Toner Mode (optional tone probe required)	49
Using the SmartTone Function	50
Using the IntelliTone Cable Map Function (optional IP200 probe required)	51
Calibrating Length Measurements	52
Setting the NVP to a Specified Value	53
Determining a Cable's Actual NVP	53
Maintenance	54
Cleaning	54
Battery Life, Status, and Replacement	54
Checking the Tester's Version, Serial Number, and MAC Address	55
Learn More	55
If Something Seems Wrong with the Tester	56
Options and Accessories	57
Specifications	57
Environmental Specifications	57
General Specifications	58

MicroScanner Series Cable Verifiers

Users Manual

Test Modes	59
Performance Specifications	59
Regulatory Information	61

Figures

Figure		Page
1.	High Voltage Display Examples.....	6
2.	MicroScanner PoE Features	7
3.	MicroScanner PoE Display Features.....	9
4.	MicroScanner ² Features	11
5.	MicroScanner ² Display Features	13
6.	Connecting a Remote ID Locator in a Confined Area or to an RJ11 Jack.....	15
7.	Connecting to Twisted Pair Network Cabling	16
8.	Open on Twisted Pair Cabling	17
9.	Short on Twisted Pair Cabling	18
10.	Crossed Wires	19
11.	Crossed Pairs	20
12.	Split Pair	21
13.	Telephone Voltages Detected	22
14.	Bridge Tap Detected	24

MicroScanner Series Cable Verifiers Users Manual

15.	Active Ethernet Port Detected.....	25
16.	Inactive Ethernet Port Detected	26
17.	Details for a Short (MicroScanner ² screen shown)	27
18.	Details for Terminated and Open Wire Pairs.....	28
19.	Using Multiple Remote ID Locators (MicroScanner PoE shown)	30
20.	Connecting to a Telephone Network Wired in a Star Topology	32
21.	Connecting to a Telephone Network Wired in a Bus Topology.....	34
22.	Connecting to Coaxial Cabling (MicroScanner ²).....	35
23.	Coaxial Results (MicroScanner ²)	36
24.	Open on Coaxial Cabling (MicroScanner ²).....	36
25.	Short on Coaxial Cabling (MicroScanner ²)	37
26.	Unknown Termination on Coaxial Cabling (MicroScanner ²).....	37
27.	MicroScanner ² PoE Display	38
28.	PoE from a Source that Provides Only Single-Signature PoE (MicroScanner PoE)	40
29.	PoE from a Dual-Signature PoE Source (MicroScanner PoE).....	41
30.	Detail Screens for Classes 5 and 4 PoE from a Dual Signature Source (MicroScanner PoE).....	42
31.	PoE Port that Shows 0.0 W.....	44
32.	Passive Power (MicroScanner PoE)	45
33.	IntelliTone Toner Mode Display	47
34.	Using the Toner in IntelliTone Mode	48

35.	Analog Toner Mode Display	49
36.	Using the Toner with the IP200 IntelliTone Cable Map Function	52
37.	Replacing the Tester's Batteries	55

MicroScanner™ Series Cable Verifiers

Introduction

The MicroScanner² and MicroScanner PoE Cable Verifiers are hand-held test instrument that let you verify and troubleshoot the wiring of twisted pair and coaxial cables and detect network services.

The testers do the following:

- Measure length up to 1000 ft (305 m).
- Detects opens, shorts, and split pairs on twisted pair cabling. The MicroScanner² also detects faults on coaxial cabling.
- Displays wiremap, cable length, proportional distance to opens, and the remote ID number all on one screen.
- Detects Ethernet ports on twisted pair cabling and reports the port speed.
- Detects PoE (Power over Ethernet) and telephone voltages on twisted pair cabling.
- IntelliTone™ function works with an optional Fluke Networks IntelliTone probe to help you locate and isolate cables behind walls, at patch panels, or in bundles. The analog toner works with standard analog probes and includes the SmartTone™ function for positive identification of cables in bundles.

Registration

Registering your product with Fluke Networks gives you access to valuable information on product updates, troubleshooting tips, and other support services. To register, fill out the online registration form on the Fluke Networks website at www.flukenetworks.com/register.

Contacting Fluke Networks

 www.flukenetworks.com/support

 info@flukenetworks.com

 1-800-283-5853, +1-425-446-5500

 **Fluke Networks**
6920 Seaway Boulevard, MS 143F
Everett WA 98203 USA

Fluke Networks operates in more than 50 countries worldwide. For more contact information, go to our website.

Symbols

Table 1 describes the symbols used on the tester and in this manual.

Table 1. Symbols





	Warning or Caution: risk of damage or destruction to equipment or software. See explanations in the manual. On the tester's display this symbol indicates a cable fault or voltage on the cable.
	Warning: Risk of electric shock.
	See the user documentation
	This product complies with the WEEE Directive marking requirements. The affixed label indicates that you must not discard this electrical/electronic product in domestic household waste. Product Category: With reference to the equipment types in the WEEE Directive Annex I, this product is classed as category 9 "Monitoring and Control Instrumentation" product. Do not dispose of this product as unsorted municipal waste. To return unwanted products, contact the manufacturer's web site shown on the product or your local sales office or distributor.
	This equipment not for connection to public communications networks, such as active telephone systems.

Table 1. Symbols (continued)

	Conformance Europeene. Conforms to the requirements of the European Union and the European Free Trade Association (EFTA).
	Conforms to relevant Australian standards.
	40 year Environment Friendly Use Period (EFUP) under China Regulation - Administrative Measure on the Control of Pollution Caused by Electronic Information Products. This is the period of time before any of the identified hazardous substances are likely to leak out, causing possible harm to health and the environment.
	EMC approval for Korea. Class A Equipment (Industrial Broadcasting & Communication Equipment). This product meets requirements for industrial (Class A) electromagnetic wave equipment and the seller or user should take notice of it. This equipment is intended for use in business environments and is not to be used in homes.

⚠ Safety Information

⚠ Warning ⚠

To avoid possible fire, electric shock, or personal injury:

- Read all safety information before you use the Product.
- Carefully read all instructions.
- Do not open the case. You cannot repair or replace parts in the case.
- Do not modify the Product.
- Use only replacement parts that are approved by Fluke Networks.
- Do not touch voltages > 30 V AC rms, 42 V AC peak, or 60 V DC.
- The tester is not intended to be connected to active telephone inputs, systems, or equipment, including ISDN devices. Exposure to the voltages applied by these interfaces may damage the tester and create a potential shock hazard. The tester shows a warning symbol (⚠) when it detects high voltage. Figures 1 and 13 show

examples of this display. Disconnect the tester if it detects high voltage.

- Do not use the Product around explosive gas, vapor, or in damp or wet environments.
- Use this Product indoors only.
- Do not connect the Product to voltages that are higher than the maximum voltage rating for the Product.
- For Products that have multiple connectors for different types of tests on copper cabling, disconnect unused test leads from the connectors before you do a test.
- Use the Product only as specified, or the protection supplied by the Product can be compromised.
- Do not use and disable the Product if it is damaged.
- Do not use the Product if it operates incorrectly.
- Batteries contain hazardous chemicals that can cause burns or explode. If exposure to chemicals occurs, clean with water and get medical aid.
- Remove the batteries if the Product is not used for an extended period of time, or if stored in

temperatures above 50 °C. If the batteries are not removed, battery leakage can damage the Product.

- The battery door must be closed and locked before you operate the Product.
- Repair the Product before use if the battery leaks.
- Replace the batteries when the low battery indicator shows to prevent incorrect measurements. (see "Battery Life, Status, and Replacement" on page 54)
- Turn off the Product and disconnect all test leads, patch cords, and cables before you replace the battery.
- Be sure that the battery polarity is correct to prevent battery leakage.
- Do not disassemble or crush battery cells and battery packs.
- Do not operate the Product with covers removed or the case open. Hazardous voltage exposure is possible.
- Remove the input signals before you clean the Product.

- Have an approved technician repair the Product.
- Do not put metal objects into connectors.
- Before using the optional IntelliTone probe, read the safety information in the probe's documentation.

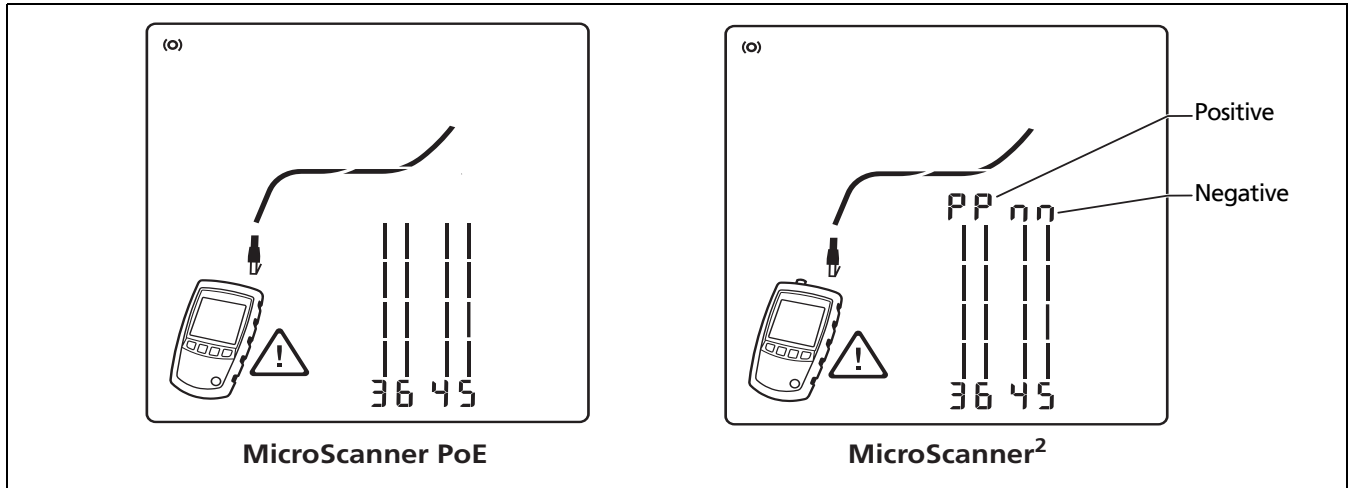

Figure 1. High Voltage Display Examples

MicroScanner PoE Features

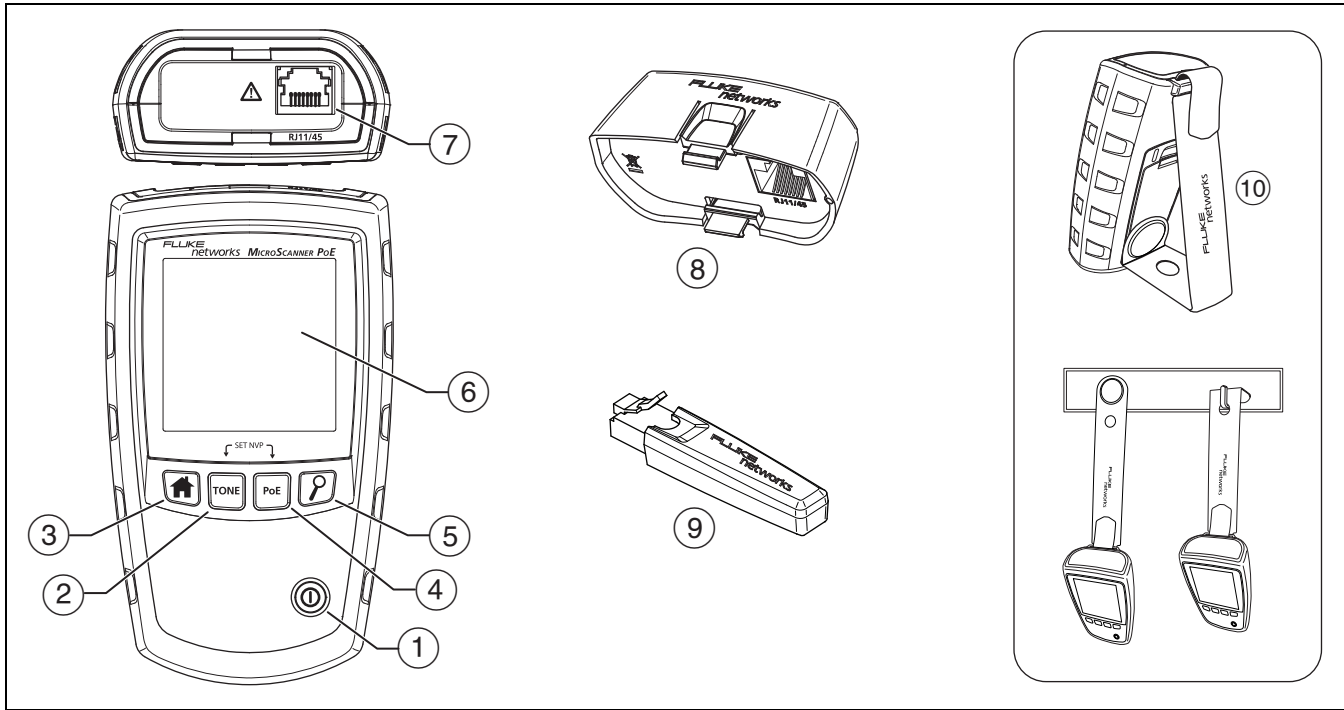











Figure 2. MicroScanner PoE Features

EGK32.EPS

- ① On/off key.
- ② : Turns on the toner.
- ③ : Starts the cable test.
- ④ : Starts the Power over Ethernet test.
- ⑤ : Scrolls through screens and changes settings. In toner mode, this key cycles through the IntelliTone and analog toner songs.
For additional modes, hold down keys while turning the tester on:
 -  + : Lets you calibrate length measurements and select meters or feet as the length unit. See pages 14 and 52.
 -  + : Activates a demonstration mode where the tester shows examples of test result screens.

Note

Auto shutoff is disabled in demonstration mode.

 -  + : Displays the version and serial number screens.
- ⑥ LCD display with backlight.
- ⑦ Modular jack for connecting to telephone and twisted pair network cable. The jack accepts 8-pin modular (RJ45) and 6-pin modular (RJ11) connectors.
- ⑧ Wiremap adapter with 8-pin modular jack. See page 15.
- ⑨ Optional remote ID locator with 8-pin modular jack. See page 15.
- ⑩ Magnetic hanging strap. Attach and use the strap as shown.

MicroScanner PoE Display Features

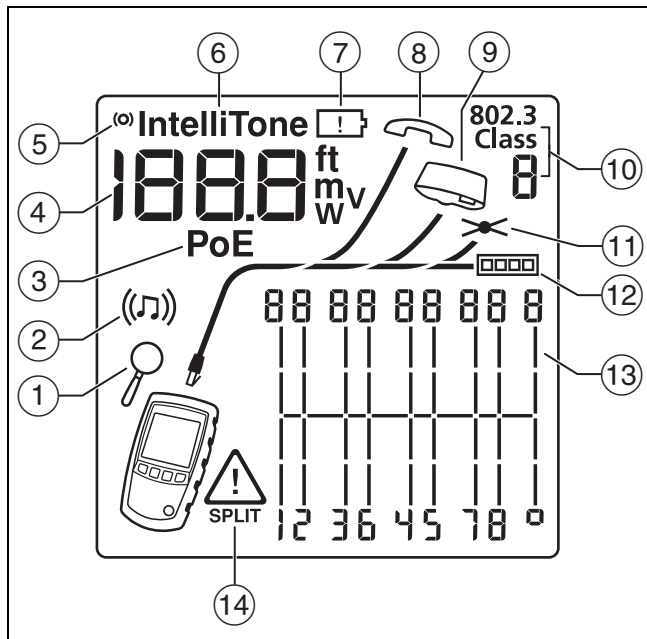

EGK31.EPS

Figure 3. MicroScanner PoE Display Features

- ① Detail screen indicator. See page 27.
- ② Tone mode indicator. See page 46.
- ③ Power over Ethernet mode indicator. See page 38.
- ④ Numeric display with feet/meters indicator. MicroScanner PoE also shows watts or volts when it detects 802.3 compliant (W) or passive (V) PoE. See page 39.
- ⑤ Test activity indicator, which is animated when a test is running.
- ⑥ IntelliTone appears when the toner is in IntelliTone mode. See pages 46 and 51.
- ⑦ Low battery indicator. See page 54.
- ⑧ Telephone voltage indicator. See page 22.
- ⑨ Indicates a wiremap adapter or remote ID locator is connected to the far end of the cable.
- ⑩ The 7-segment display shows the number of the ID locator connected to the far end of the cable. A $\bar{1}$ shows for the wiremap adapter.

802.3 Class and the 7-segment display show the maximum class of PoE available (802.3 classes 0 through 8). See page 39.

- ⑪ Indicates a short on the cable. See pages 18 and 37.
- ⑫ Ethernet port indicator. See page 25.
- ⑬ Wiremap diagram. For opens, the number of segments lit for the wire pair indicates the approximate distance to the fault. The rightmost segments indicate the shield. See pages 17 through 21.
- ⑭ The  indicates a fault or high voltage on the cable. **SPLIT** appears when the fault is a split pair. See page 21.

MicroScanner² Features

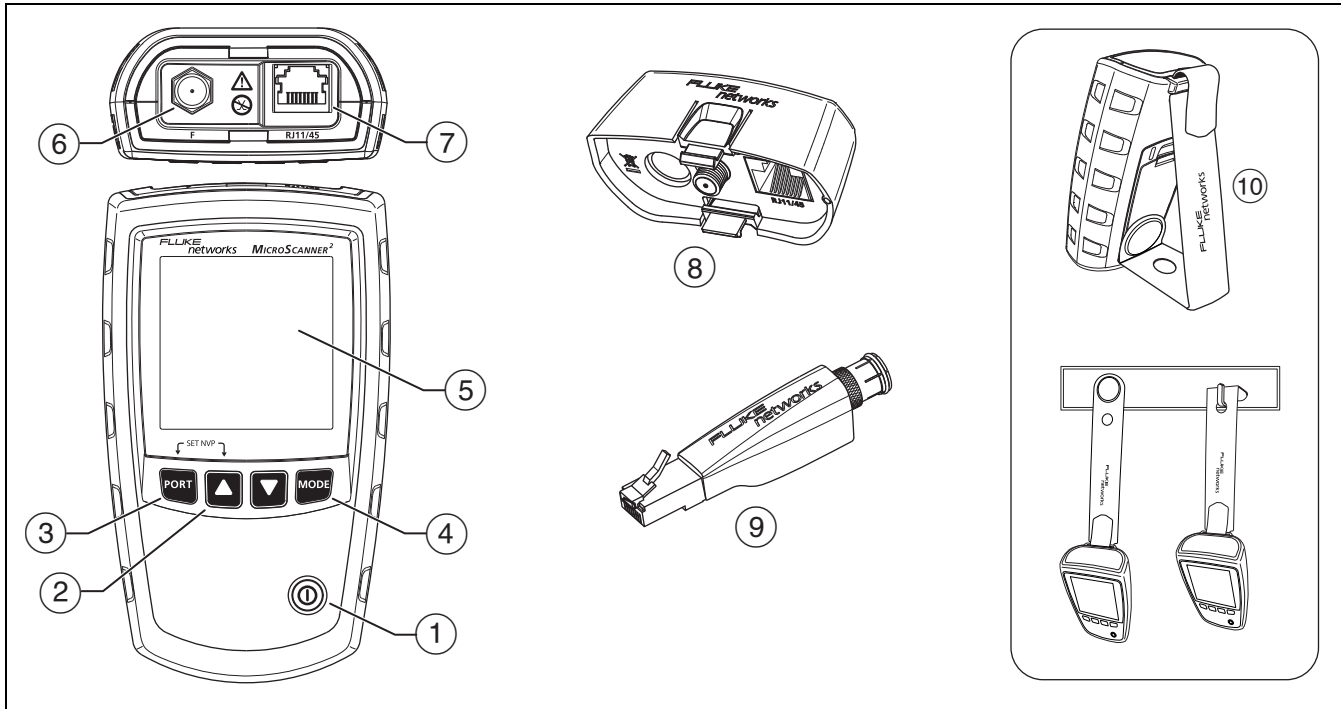











Figure 4. MicroScanner² Features

EGK01.EPS

- ① On/off key.
- ②  ,  : Scrolls through screens and changes settings. In toner mode, these keys cycle through the IntelliTone and analog toner songs.
- ③  : Selects the RJ45 or coaxial connector as the active port.
- ④  : Cycles through the cable test, toner, and PoE detect modes.
For additional modes, hold down keys while turning the tester on:
 -  +  : Lets you calibrate length measurements and select meters or feet as the length unit. See pages 14 and 52.
 -  +  : Activates a demonstration mode where the tester shows examples of test result screens.

Note

Auto shutoff is disabled in demonstration mode.

 -  +  : Displays the version and serial number screens.
- ⑤ LCD display with backlight.
- ⑥ F-connector for connecting to 75 Ω coaxial cable.
- ⑦ Modular jack for connecting to telephone and twisted pair network cable. The jack accepts 8-pin modular (RJ45) and 6-pin modular (RJ11) connectors.
- ⑧ Wiremap adapter with F-connector and 8-pin modular jack. See page 15.
- ⑨ Optional remote ID locator with F-connector and 8-pin modular jack. See page 15.
- ⑩ Magnetic hanging strap. Attach and use the strap as shown.

MicroScanner² Display Features

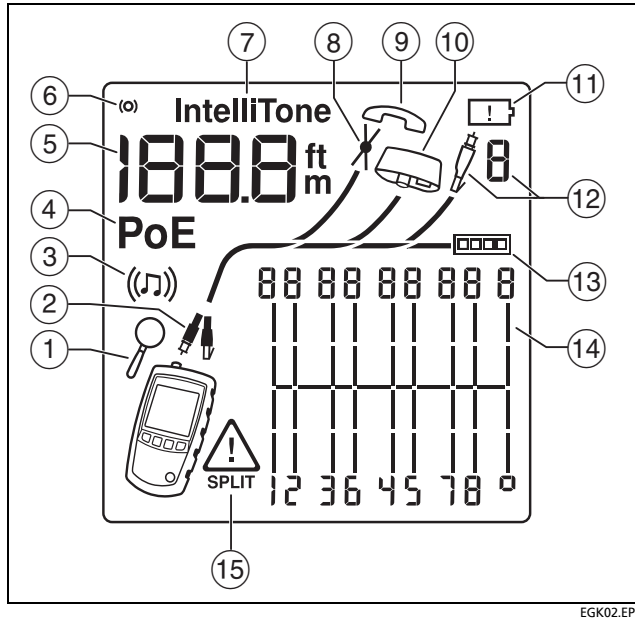



Figure 5. MicroScanner² Display Features

- ① Detail screen indicator. See page 27.
- ② Indicates which port is active, the RJ45 port (📶) or the coaxial port (📡).
- ③ Tone mode indicator. See page 46.
- ④ Power over Ethernet mode indicator. See page 38.
- ⑤ Numeric display with feet/meters indicator.
- ⑥ Test activity indicator, which is animated when a test is running.
- ⑦ IntelliTone appears when the toner is in IntelliTone mode. See pages 46 and 51.
- ⑧ Indicates a short on the cable. See pages 18 and 37.
- ⑨ Telephone voltage indicator. See page 22.
- ⑩ Indicates a wiremap adapter is connected to the far end of the cable.
- ⑪ Low battery indicator. See page 54.
- ⑫ Indicates an ID locator is connected to the far end of the cable and shows the locator's number.
- ⑬ Ethernet port indicator. See page 25.

- ⑭ Wiremap diagram. For opens, the number of segments lit for the wire pair indicates the approximate distance to the fault. The rightmost segments indicate the shield. See pages 17 through 21.
- ⑮ The  indicates a fault or high voltage on the cable. **SPLIT** appears when the fault is a split pair. See page 21.







Auto Shutoff

The tester turns off after 10 minutes if no keys are pressed and nothing changes at the tester's connectors.

Note

Auto shutoff is disabled in toner and demonstration modes.

Changing the Length Units

- 1 Hold down  and  or  and  while turning on the tester.
- 2 Press  or  to switch between meters and feet.
- 3 Turn the tester off then on to return to testing mode.

Using the Wiremap Adapter and Remote ID Locators

Terminating twisted pair cabling with the standard wiremap adapter or optional remote ID locators lets the tester detect all types of wiremap faults. Without this termination, the tester cannot detect crossed wires or crossed pairs. For a wire pair with one wire open, termination is required to detect which wire is open. Without termination, the tester shows both wires as open.

Using multiple remote ID locators helps you identify connections at patch panels. The tester shows the number of the locator connected to the far end of the cabling, as shown on page 30.

To connect a remote ID locator to a modular (RJ) jack in a confined area or to a 4-pin modular jack (RJ11), use the optional universal adapter and a patch cord, as shown in Figure 6.

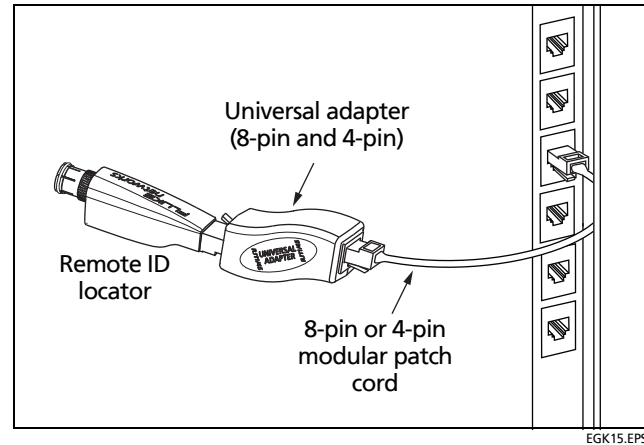

Figure 6. Connecting a Remote ID Locator in a Confined Area or to an RJ11 Jack

Testing Twisted Pair Cabling

- 1 Turn on the tester.

MicroScanner²: If the tester is already on and in coaxial test mode (🔌), press **PORT** to switch to twisted pair test mode (🔌).

- 2 Connect the tester and wiremap adapter or ID locator to the cabling as shown in Figures 7 through 21.

The test runs continuously until you change modes or turn the tester off.

Notes

You can measure length without connecting a far end adapter; however, an adapter is required for a complete wiremap test.

If the PoE indicator appears, set the tester to PoE mode. See page 38.

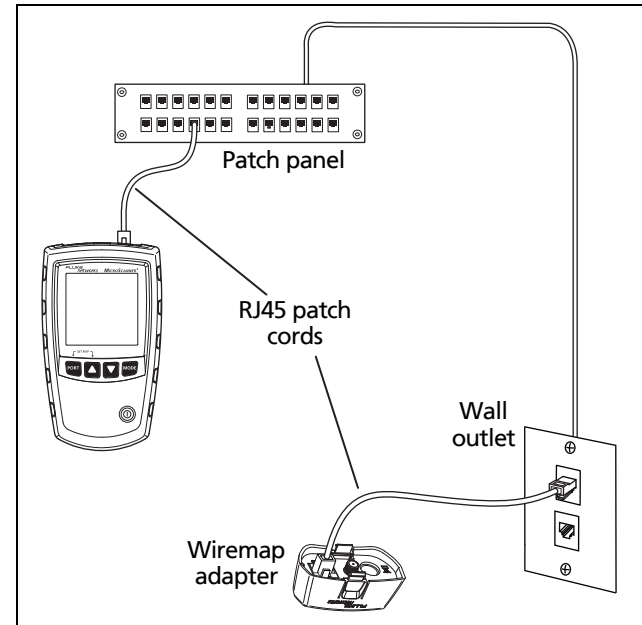

EGK03.EPS

Figure 7. Connecting to Twisted Pair Network Cabling

Open on Twisted Pair Cabling

Figure 8 shows an open on wire 4.

Notes

If only one wire in a pair is open and a wiremap adapter or remote ID locator is not connected, both wires are shown as open.

The warning icon (⚠) does not appear if both wires in a pair are open because open pairs are normal for some cabling applications.

The three segments shown for the wire pair length indicate the open is approximately 3/4 the distance to the end of the cabling. The cable length is 75.4 m.

To see the distance to the open, use ▲ ▼ or Ⓟ to view detailed results for the wire pair. See page 27.

Typical Causes of Opens

- Wires connected to wrong pins at connector or punchdown blocks
- Faulty connections
- Damaged connector
- Damaged cable
- Wrong application for cable

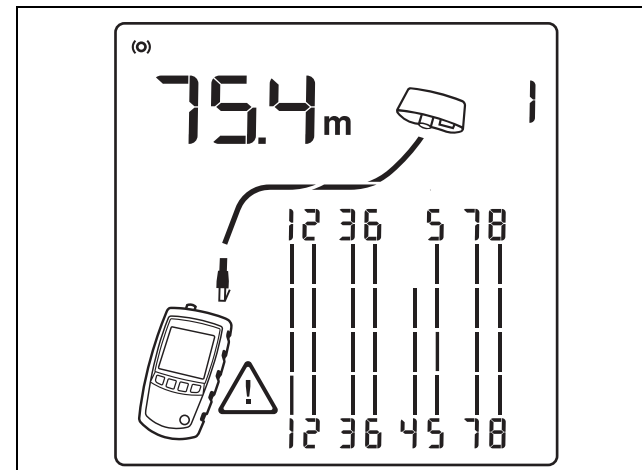

Figure 8. Open on Twisted Pair Cabling

Short on Twisted Pair Cabling

Figure 9 shows a short between wires 5 and 6. The shorted wires flash to indicate the fault. The cable length is 75.4 m.

Note

When there is a short, the far-end adapter and the mapping of the unshorted wires are not shown.

Typical Causes of Shorts

- Damaged connector.
- Damaged cable.
- Conductive material stuck between pins at connector.
- Improper connector termination.
- Wrong application for cable.

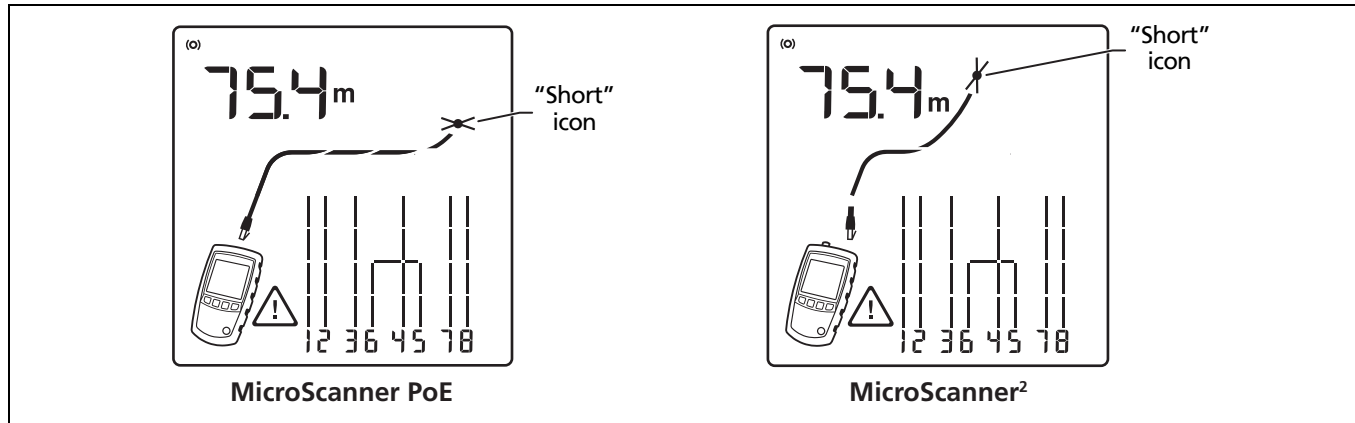

Figure 9. Short on Twisted Pair Cabling

EKG06.EPS

Crossed Wires

Figure 10 shows that wires 3 and 4 are crossed. The the pin numbers flash to indicate the fault. Cable length is 53.9 m. The cable is shielded.

Detection of crossed wires requires a far-end adapter.

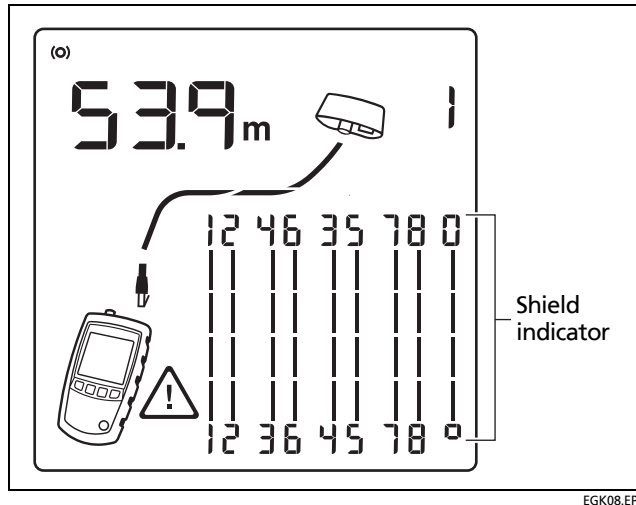

Figure 10. Crossed Wires

Crossed Pairs

Figure 11 shows that pairs 1,2 and 3,6 are crossed. The pin numbers flash to indicate the fault. This crossed pair is likely caused by mixing 568A and 568B cabling.

Detection of crossed pairs requires a far-end adapter.

Typical Causes of Crossed Pairs

- Wires connected to wrong pins at connector or punchdown block.
- Mix of 568A and 568B wiring standards (12 and 36 crossed).
- Crossover cables used where not needed (12 and 36 crossed).

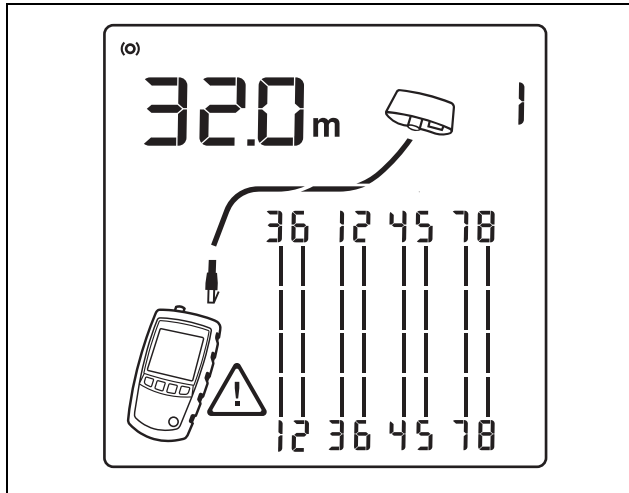

Figure 11. Crossed Pairs

EGK09.EPS

Split Pair

Figure 12 shows a split pair on 3,6 and 4,5. The split pair flashes to indicate the fault. The cable length is 75.4 m.

In a split pair, continuity from end to end is correct, but is made with wires from different pairs. Split pairs cause excessive crosstalk that interferes with network operation.

Note

Cables with untwisted pairs, such as telephone cords, typically show split pairs due to excessive crosstalk.

Telephone Voltages Detected

Figure 13 shows that telephone voltage is detected on pair 4,5.

Length is not shown because the voltage interferes with length measurements.

⚠ Warning ⚠

The tester is not intended to be connected to active telephone inputs, systems, or equipment, including ISDN devices. Prolonged exposure to the voltages applied by these interfaces may damage the tester. Disconnect the tester if it detects high voltage.

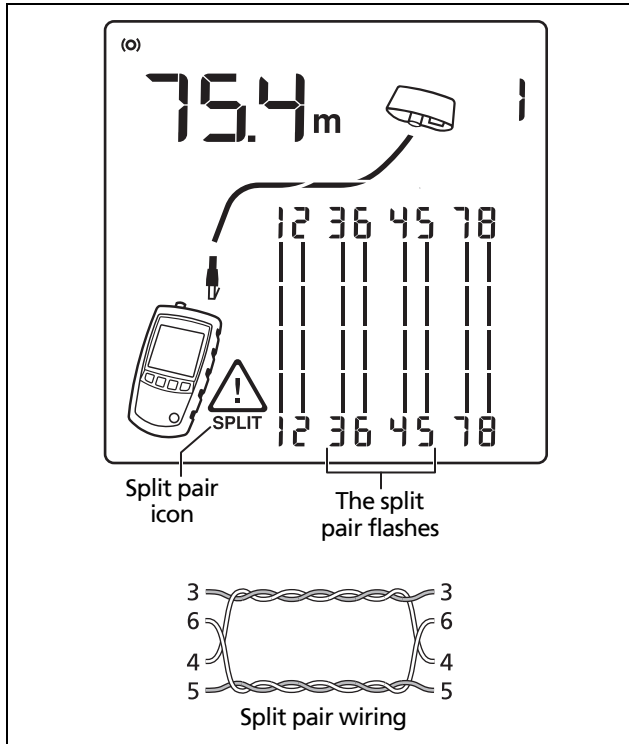

EGK10.EPS

Figure 12. Split Pair

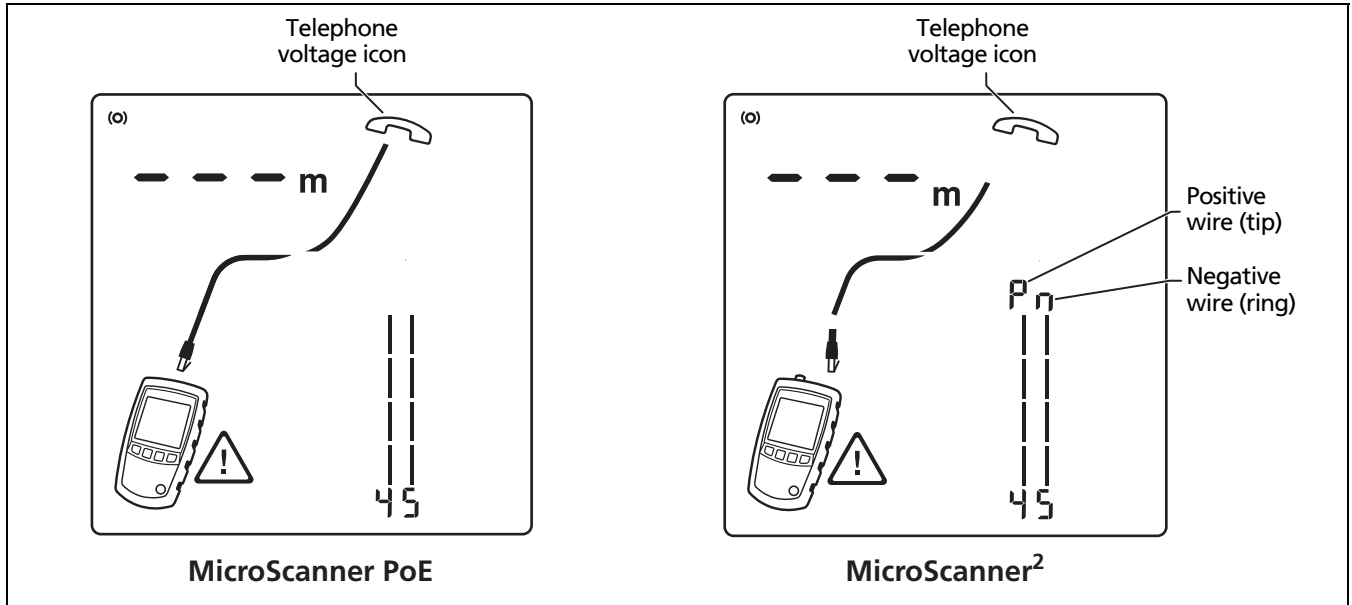

Figure 13. Telephone Voltages Detected

EGK11.EPS

Bridge Tap Detected

Figure 14 shows a bridge tap detected at about 53.2 m. Only the first bridge tap detected is reported. The distance to a bridge tap is approximate because multiple reflections from the bridge tap interfere with length measurements.

Note

Bridge taps more than 328 ft (100 m) from the tester or taps less than 16 ft (5 m) long may not be detected.

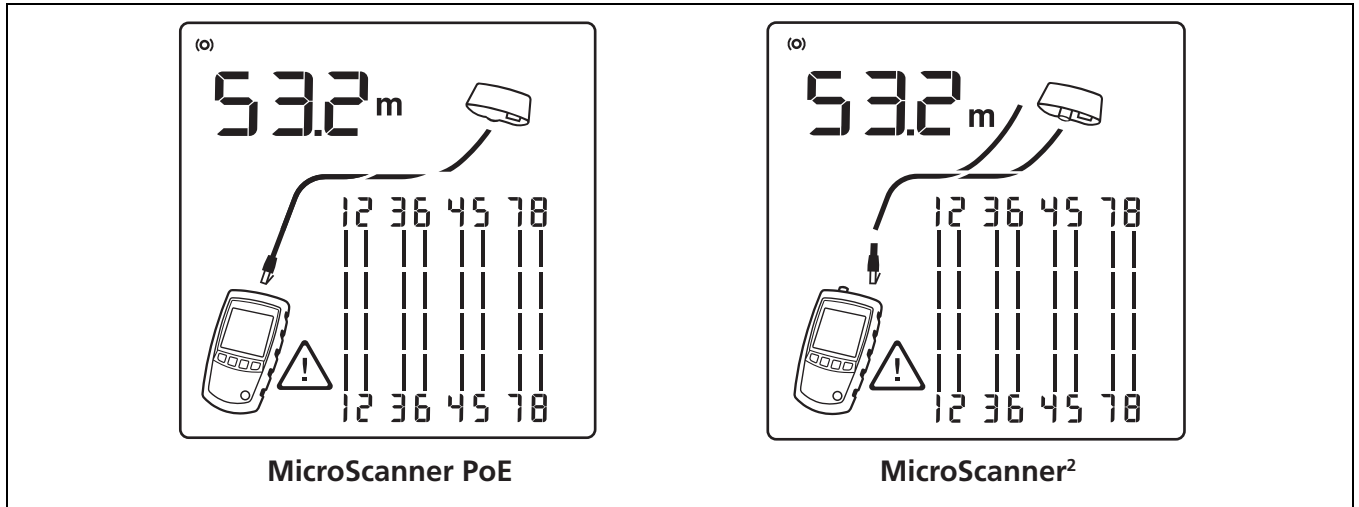

Figure 14. Bridge Tap Detected

EGK12.EPS

Ethernet Port Detected

The tester can detect active and inactive Ethernet ports, as shown in Figures 15 and 16.

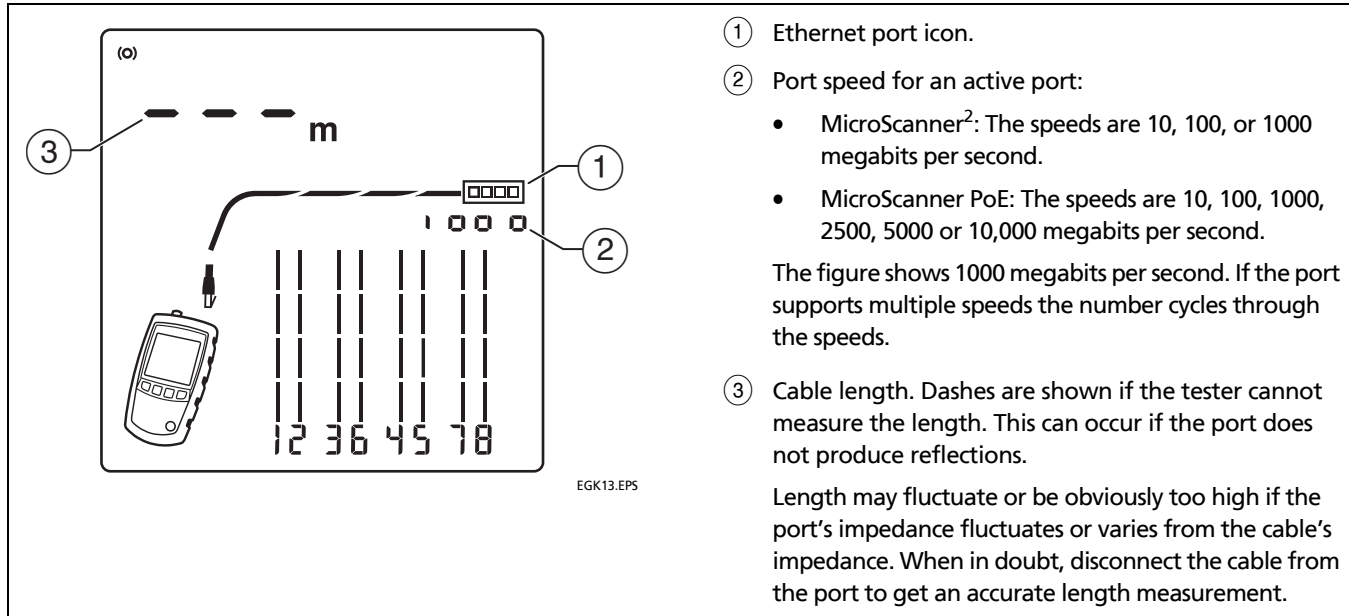
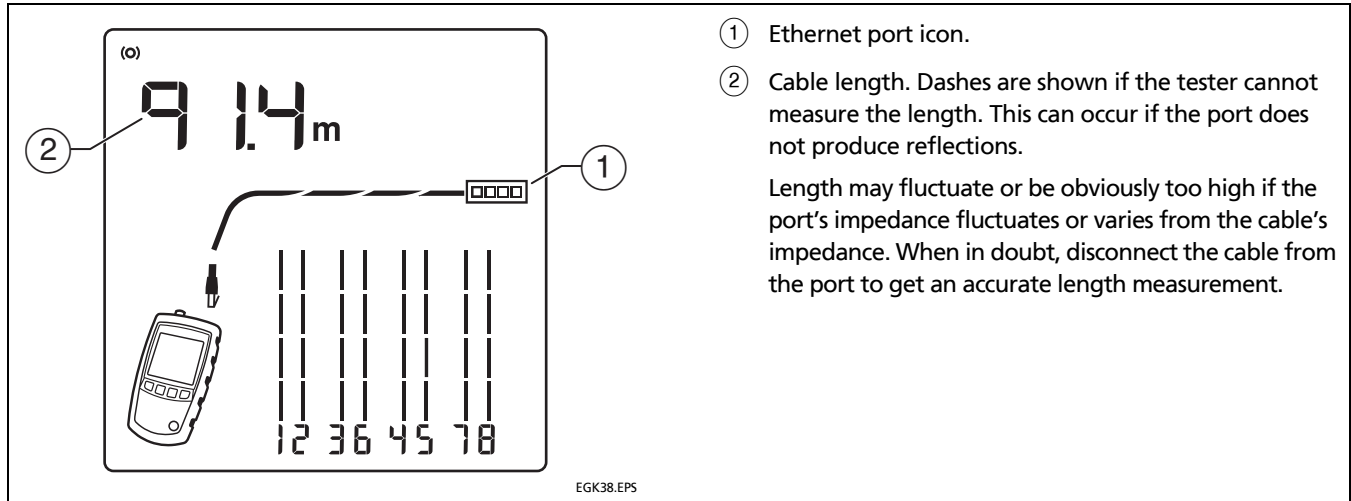

Figure 15. Active Ethernet Port Detected



- ① Ethernet port icon.
- ② Cable length. Dashes are shown if the tester cannot measure the length. This can occur if the port does not produce reflections.

Length may fluctuate or be obviously too high if the port's impedance fluctuates or varies from the cable's impedance. When in doubt, disconnect the cable from the port to get an accurate length measurement.

Figure 16. Inactive Ethernet Port Detected

Viewing Details for a Wire Pair

To see details for each wire pair, use ▲ ▼ or ⓘ to move through the screens.

In this mode, the tester continuously tests only the wire pair you are viewing.

Figures 17 and 18 show examples of these screens.

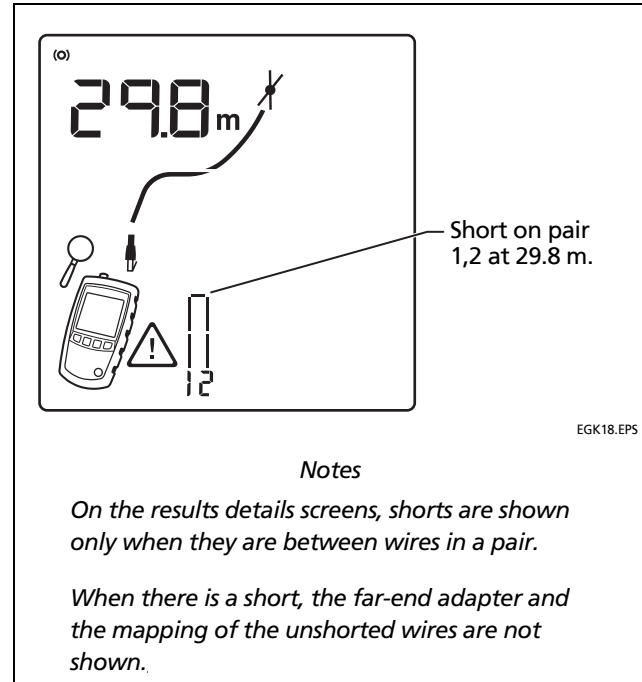

**Figure 17. Details for a Short
(MicroScanner² screen shown)**

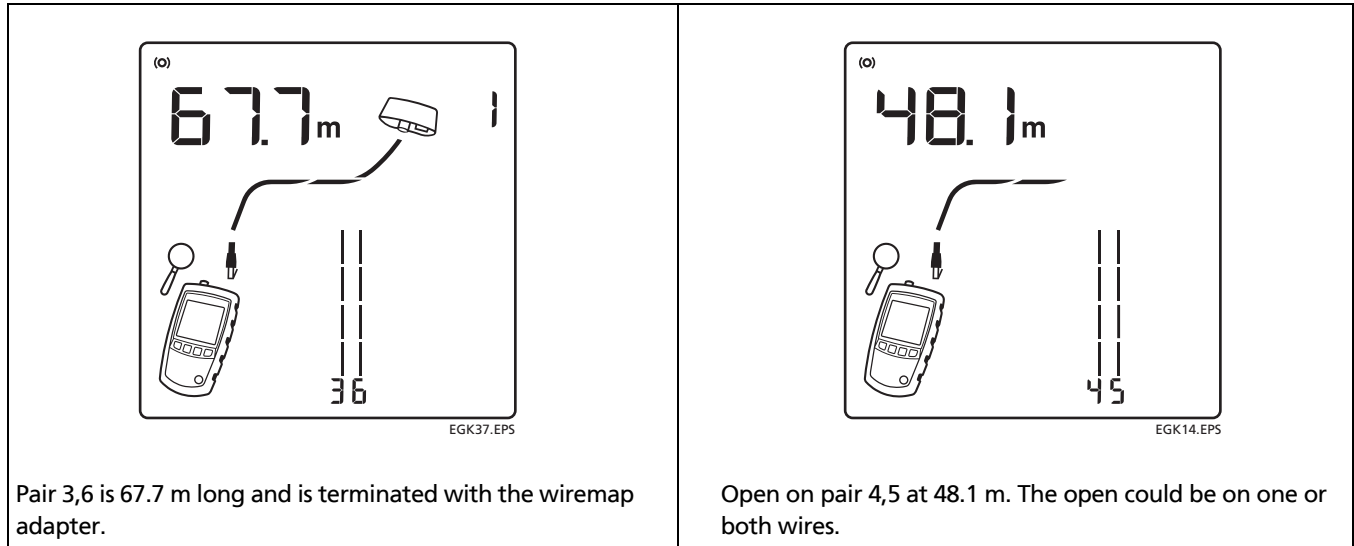

Figure 18. Details for Terminated and Open Wire Pairs

Using Multiple Remote ID Locators

Using multiple remote ID locators helps you identify multiple network connections at a patch panel, as shown in Figure 19.

The display in Figure 19 shows that the tester is connected to the cable terminated with remote ID locator number 3.

The MicroScanner² display shows an ID locator icon (🔗) near the ID locator's number.

Caution

Do not use multiple far end adapters in star or bus topologies. Doing so causes incorrect wiremap results.

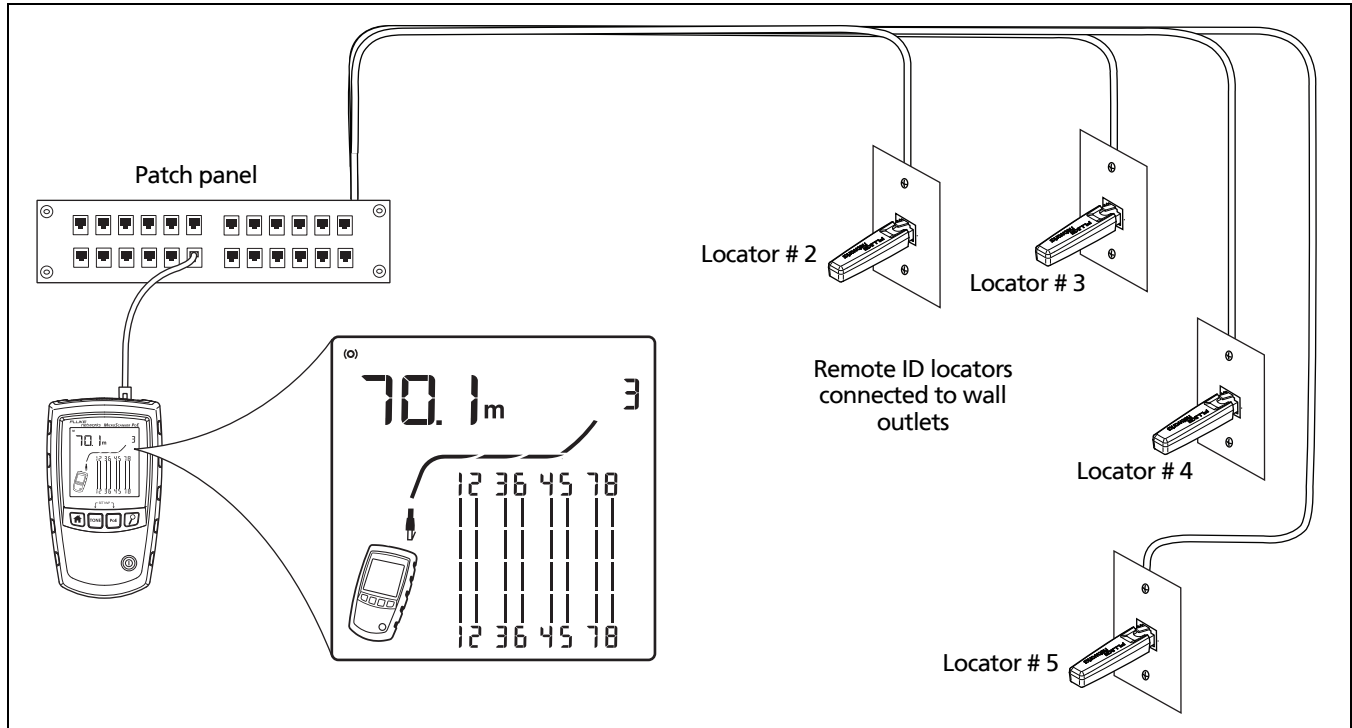

Figure 19. Using Multiple Remote ID Locators (MicroScanner PoE shown)

EGK04.EPS

Connecting to Telephone Networks Wired in Star Topologies

Telephone cables wired in a star topology (Figure 20) are connected together at a bridge tap at the distribution center. The bridge tap connects each wire to all other wires of the same number.

The tester detects bridge taps and measures the distance to the bridge tap. To measure the length of each cable connected to the bridge tap, connect the wiremap adapter or remote ID locator to the bridge tap and the tester to the wall outlet.

The tester cannot measure length past the bridge tap because reflections from the bridge tap connections interfere with measurements.

If you connect the tester to the bridge tap, the tester measures the length only to the bridge tap, which is only the patch cord length.

Caution

Do not use multiple far end adapters in star or bus topologies. Doing so causes incorrect wiremap results.

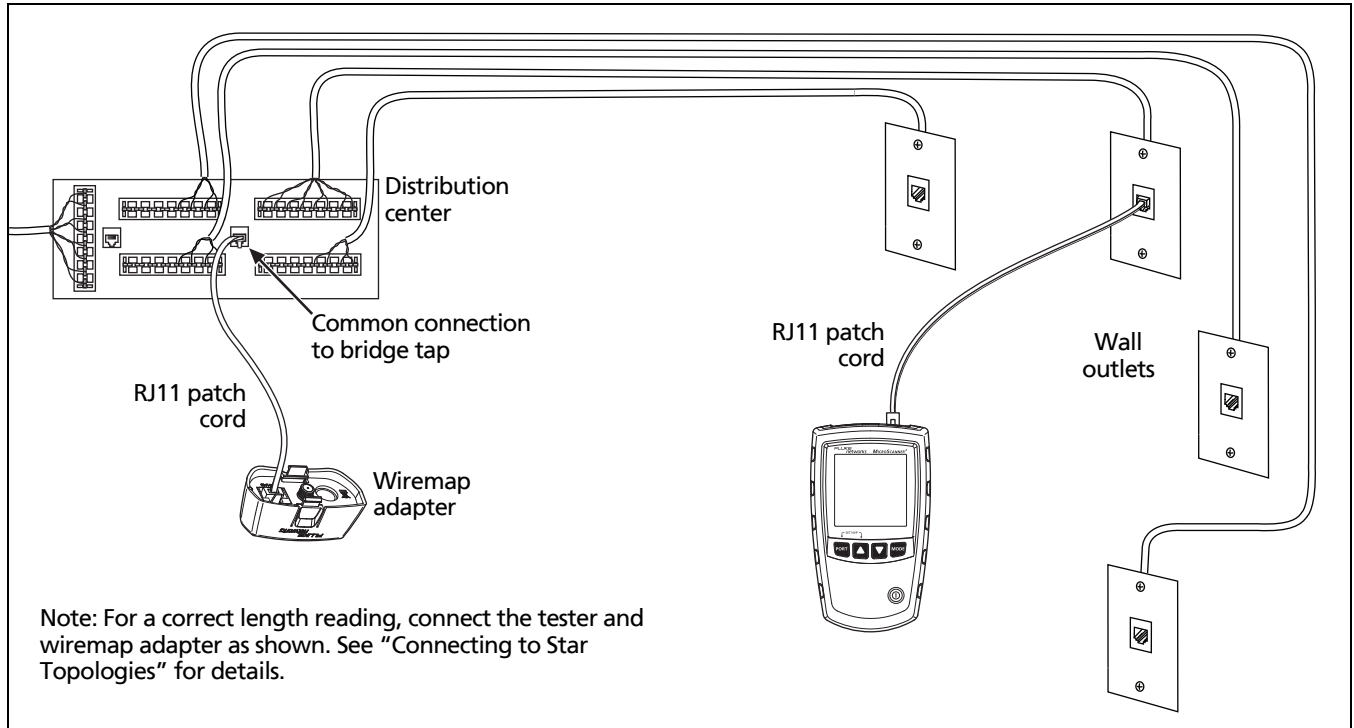

EGK16.EPS

Figure 20. Connecting to a Telephone Network Wired in a Star Topology

Connecting to Telephone Networks Wired in Bus Topologies

Telephone cables wired in a bus topology (Figure 21) connect the wall outlets in series. In this topology, you measure the length from the last outlet to the wiremap adapter.

If you connect to an outlet in the middle of the series, the tester reports a bridge tap. The length reported is the length to the outlet, which is the patch cord length. The tester cannot measure length past the outlet because reflections from the cables on either side interfere with measurements.

If you are unsure which outlet is the last in the bus, do the following:

- 1 Connect the wiremap adapter or ID locator to the beginning of the bus at the distribution center.
- 2 Connect the tester to an outlet and run the twisted pair cable test.

If the tester reports a bridge tap, move to another outlet. The last outlet will not show a bridge tap, and will show the length to the distribution center.

Caution

Do not use multiple far end adapters in star or bus topologies. Doing so causes incorrect wiremap results.

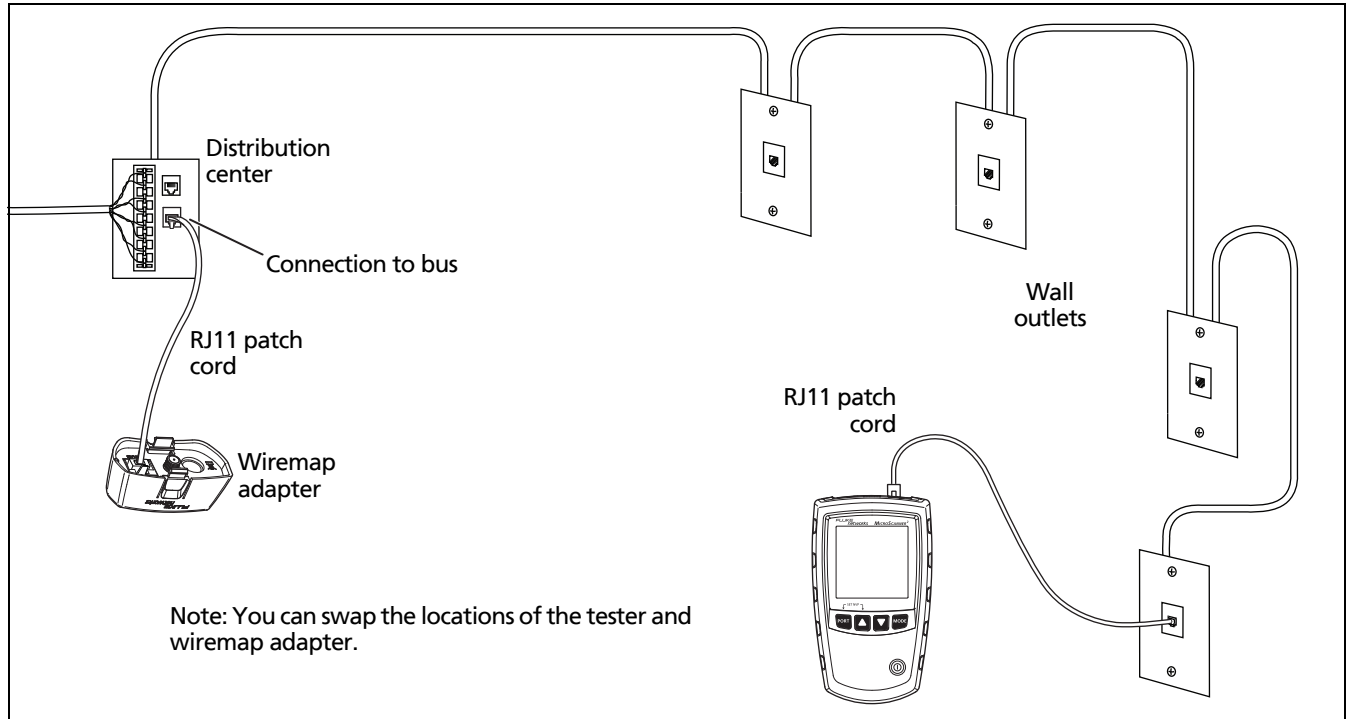

EGK17.EPS

Figure 21. Connecting to a Telephone Network Wired in a Bus Topology

Testing Coaxial Cabling (MicroScanner²)

- 1 Turn on the tester.
- 2 MicroScanner²: Press **PORT** to switch to coaxial test mode (🔌).
- 3 Connect the tester and wiremap adapter or ID locator to the cabling as shown in Figure 22.

For cabling not terminated with an F-connector, use an adapter or hybrid patch cord to connect to the cabling.

The test runs continuously until you change modes or turn the tester off.

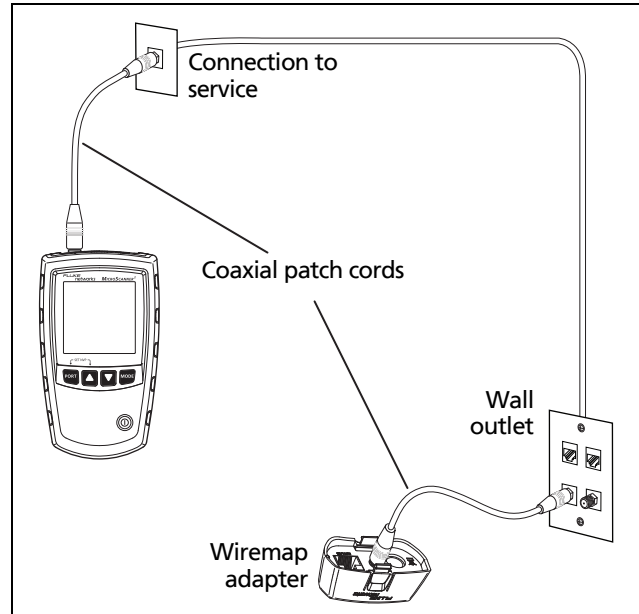

EGK19.EPS

Figure 22. Connecting to Coaxial Cabling (MicroScanner²)

Results for a Good Coaxial Cable

Figure 23 shows a good coaxial cable 38.4 m long and terminated with remote ID number 3.

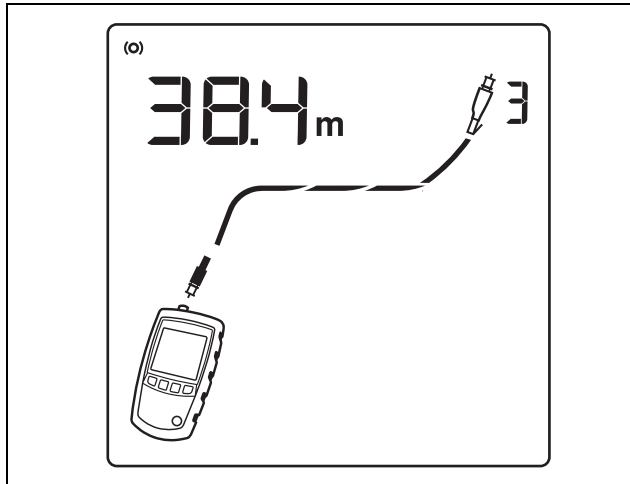

EGK20.EPS

Figure 23. Coaxial Results (MicroScanner²)

Open on Coaxial Cabling

Figure 24 shows an open 12.1 m from the tester.

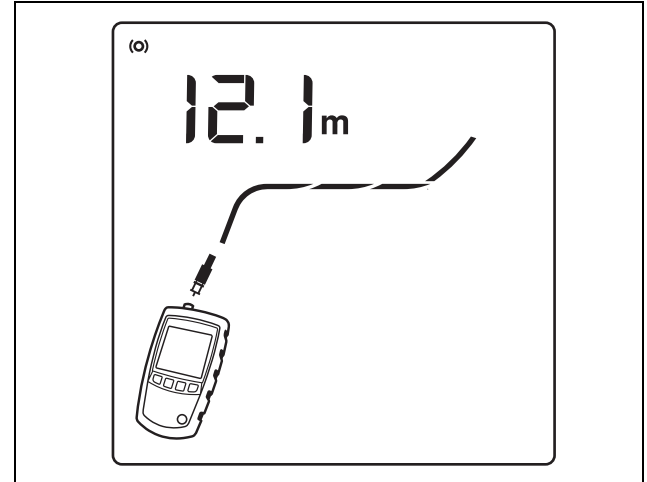

EGK21.EPS

Figure 24. Open on Coaxial Cabling (MicroScanner²)

Short on Coaxial Cabling

Figure 25 shows a short 12.1 m from the tester.

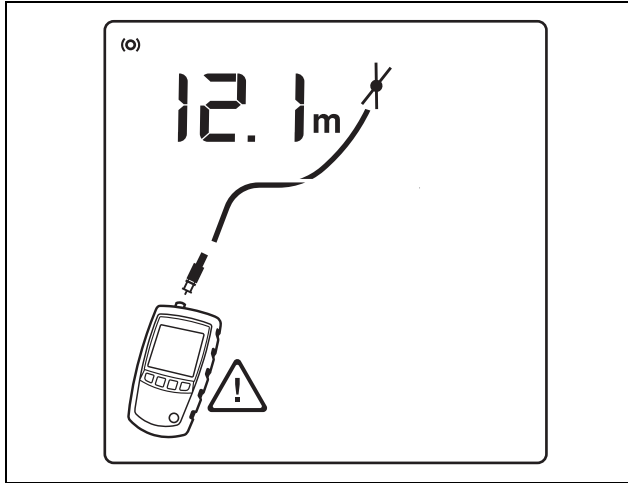

EGK22.EPS

Figure 25. Short on Coaxial Cabling (MicroScanner²)

Unknown Termination on Coaxial Cabling

Figure 26 shows a cable connected to a device at the far end, such as a television, CATV service, VCR, DVD player, satellite dish, splitter, or antenna. Dashes shown for length mean the tester cannot measure length because the device does not produce reflections.

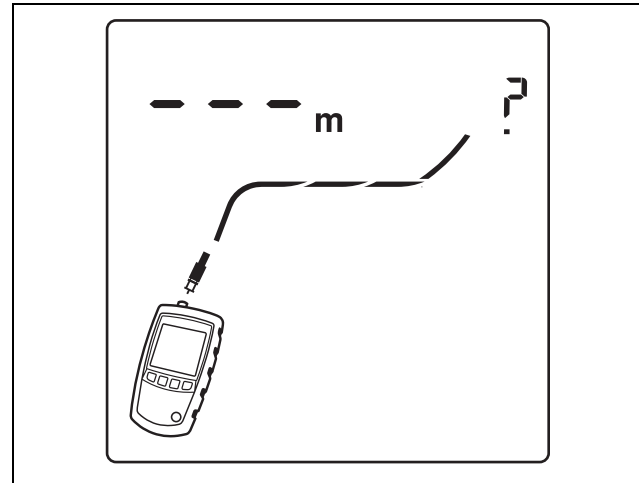

EGK23.EPS

Figure 26. Unknown Termination on Coaxial Cabling (MicroScanner²)

Detecting Power Over Ethernet

To select PoE mode, press **MODE** or **PoE** until **PoE** appears on the display.

In PoE mode, the tester solicits PoE on pairs 1,2-3,6 and 4,5-7,8. The tester may activate a PoE source and will not be damaged by PoE.

In twisted pair test mode, a flashing **PoE** mode indicator means that PoE may be available. To verify the presence of a PoE source, switch the tester to PoE mode.

Note

The tester will not detect PoE schemes that are not compliant with the IEEE 802.3af standard, such as Cisco® Inline Power.

MicroScanner²

The MicroScanner² tester solicits and detects PoE voltage from 802.3af sources. If PoE is detected, **PoE** appears above the powered pairs. The **PoE** may blink as the PoE source turns the power on and off.

Figure 27 shows the MicroScanner² display when the tester detects PoE on pairs 4,5 and 7,8.

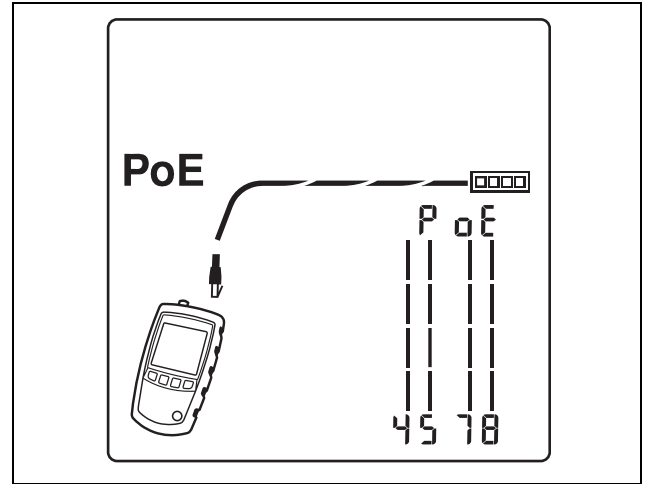

EGK30.EPS

Figure 27. MicroScanner² PoE Display

MicroScanner PoE

To select PoE mode, press .



The display shows     (searching) while the tester looks for PoE.

MicroScanner PoE uses the 802.3af, at, and bt standards at the hardware layer to negotiate and report PoE available from active sources. It can use the link layer with LLDP (Link Layer Discovery Protocol) for Type 2 sources only.

Notes

PoE sources do not always meet the wattage specification for their class.

The tester will verify the maximum power available if the source's port is configured to respond to requests at the hardware layer only. If a source's port is configured to respond only to LLDP requests for high power levels (Classes 5-8), the tester cannot verify the maximum power available from that source.

Older 802.3af and 802.3at sources will sometimes continue to supply power when you switch between the tester's PoE and cable test screens. If this occurs,   (not off) shows on the PoE screen. If you see this message, disconnect then reconnect the cable to the tester. The tester will negotiate with the source and show valid PoE test results again.

Single- and Dual-Signature Sources

For single- and dual-signature sources, the MicroScanner PoE tester shows the maximum class of power available and the standard wattage for that class. See Figures 28 through 30. Table 2 on page 43 shows wattages and other information for the PoE classes.

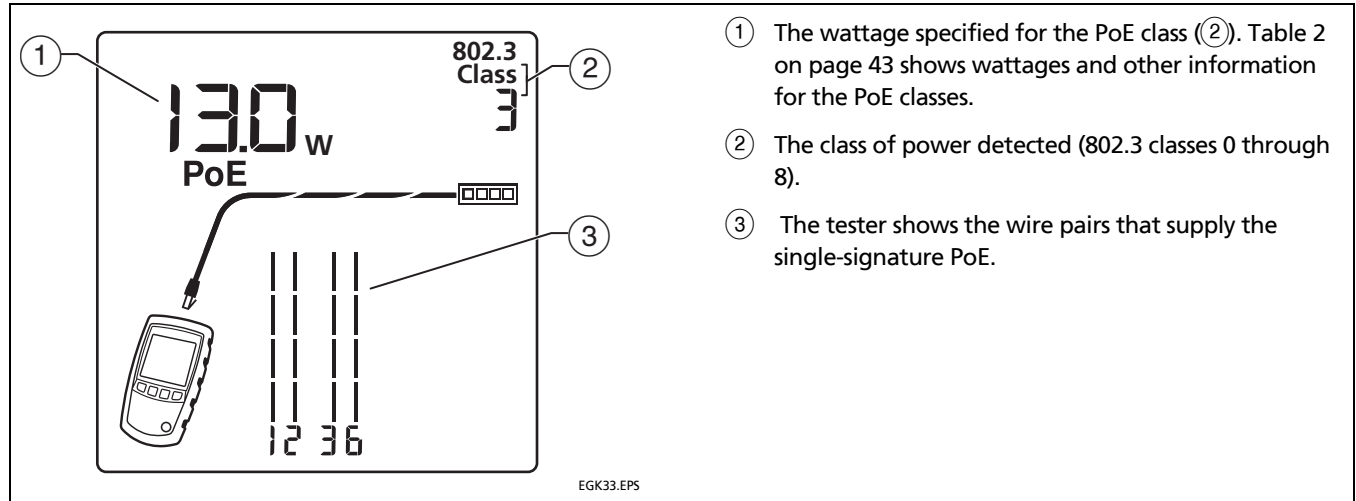

- ① The wattage specified for the PoE class (②). Table 2 on page 43 shows wattages and other information for the PoE classes.
- ② The class of power detected (802.3 classes 0 through 8).
- ③ The tester shows the wire pairs that supply the single-signature PoE.

Figure 28. PoE from a Source that Provides Only Single-Signature PoE (MicroScanner PoE)

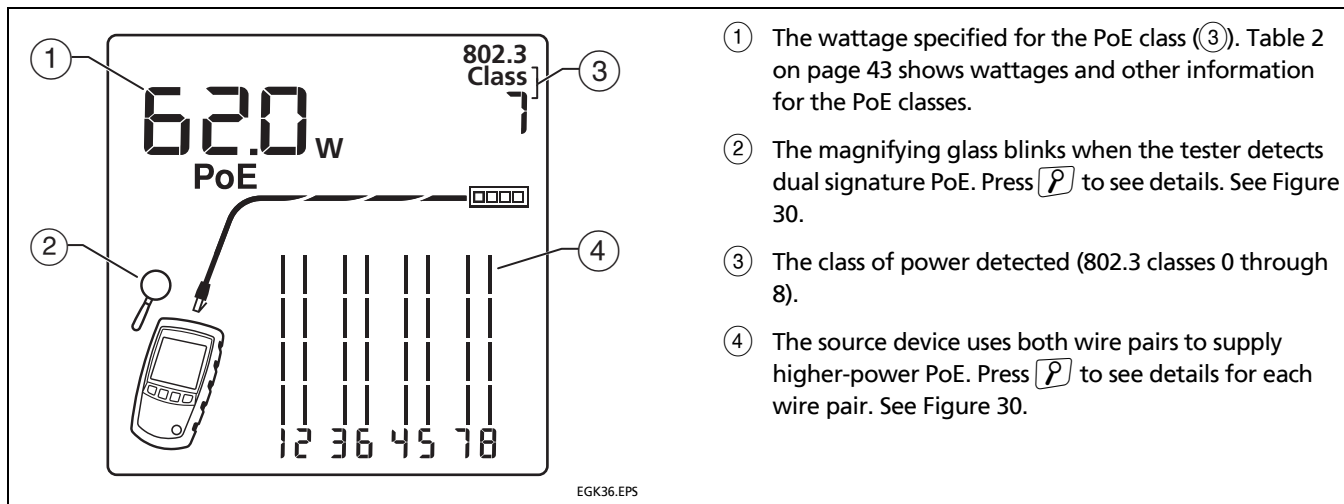



Figure 29. PoE from a Dual-Signature PoE Source (MicroScanner PoE)

- ① The wattage specified for the PoE class (③). Table 2 on page 43 shows wattages and other information for the PoE classes.
- ② The magnifying glass blinks when the tester detects dual signature PoE. Press  to see details. See Figure 30.
- ③ The class of power detected (802.3 classes 0 through 8).
- ④ The source device uses both wire pairs to supply higher-power PoE. Press  to see details for each wire pair. See Figure 30.

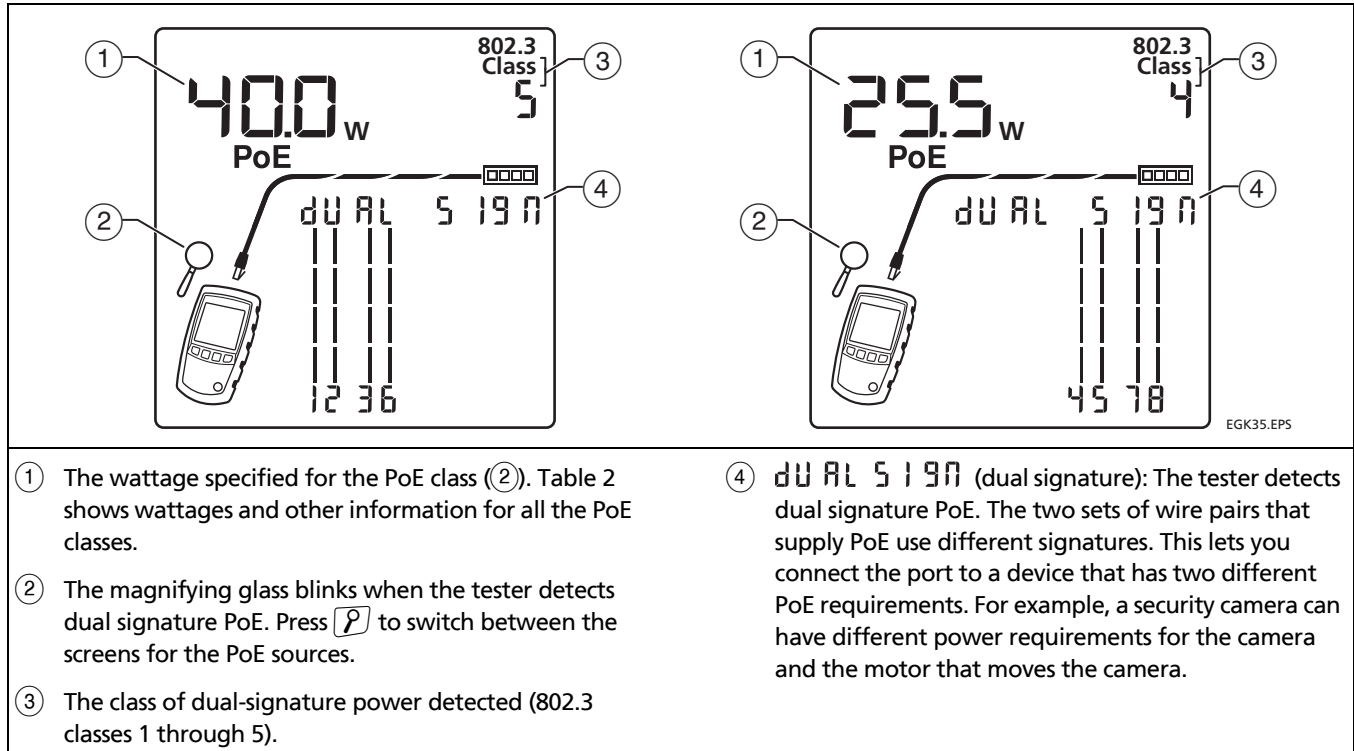

Figure 30. Detail Screens for Classes 5 and 4 PoE from a Dual Signature Source (MicroScanner PoE)

Table 2. PoE Classes

Class Number¹	Input Power to Powered Device (watts)¹	Output Power from Power Sourcing Equipment (watts)	Powered Device Type	IEEE Standard²
0	13	14	1	802.3af (2-pair PoE)
1	3.84	4	1	
2	6.49	6.7	1	
3	13	14	1	
4	25.5	30	2	802.3at (PoE+)
5	40	45	3	802.3bt (4-pair PoE, 4PPoE, PoE++)
6	51	60	3	
7	62	75	4	802.3bt (higher-power PoE)
8	71.3	90	4	

1. These class numbers and wattages are shown on the MicroScanner PoE display. Actual wattage can vary and depends on the length of cabling and the cable type.

2. The tester can identify two non-standard types of PoE—PoH (Power over HDBaseT™) and UPoE (Universal Power over Ethernet)—when those sources supply 30 W or less over two pairs.

If the Display Shows 0.0 W

If a PoE source does not supply power to a port, the MicroScanner PoE tester shows **0.0 W** and **PoE** flashes on the display. See Figure 31.

Note

*If the display shows **0.0 W**, and you quickly connect the tester to another port, the display might continue to show **0.0 W** for a few seconds until the tester shows results for the new port.*

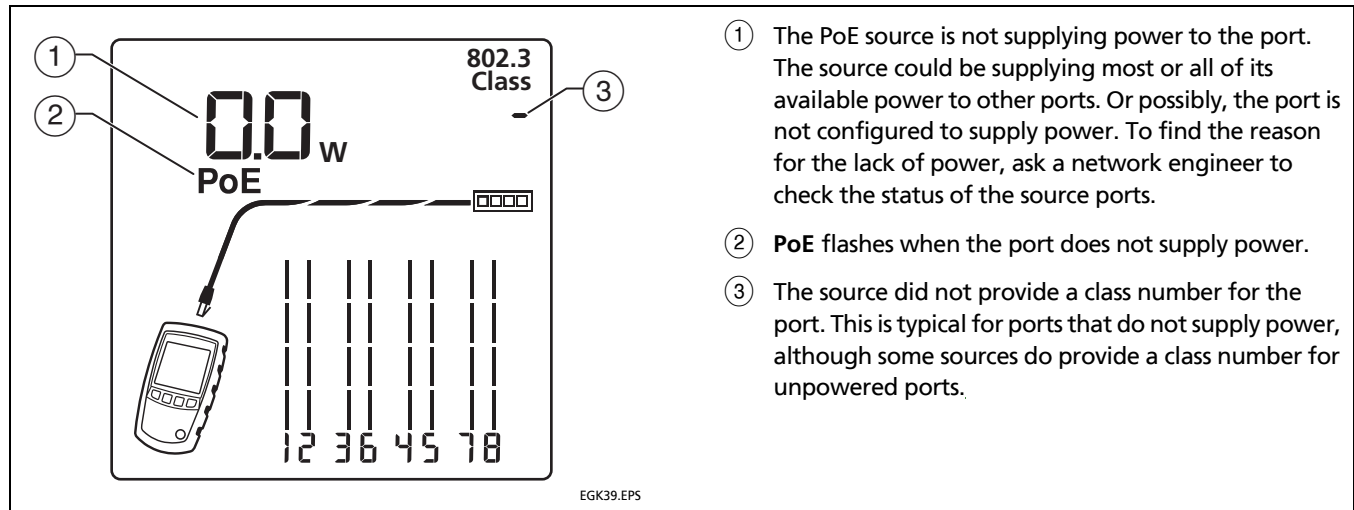

- ① The PoE source is not supplying power to the port. The source could be supplying most or all of its available power to other ports. Or possibly, the port is not configured to supply power. To find the reason for the lack of power, ask a network engineer to check the status of the source ports.
- ② **PoE** flashes when the port does not supply power.
- ③ The source did not provide a class number for the port. This is typical for ports that do not supply power, although some sources do provide a class number for unpowered ports.

Figure 31. PoE Port that Shows 0.0 W

Passive Sources

For passive sources, the MicroScanner PoE tester shows the voltage it measures on the powered pairs, as shown in Figure 32.

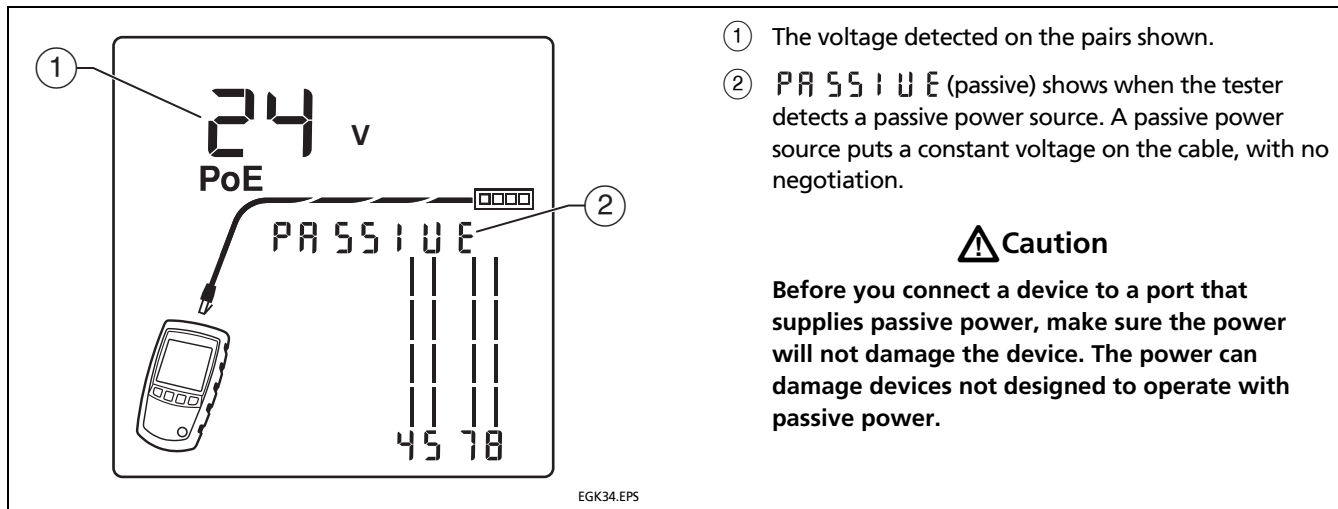

- ① The voltage detected on the pairs shown.
- ② **PASSIVE** (passive) shows when the tester detects a passive power source. A passive power source puts a constant voltage on the cable, with no negotiation.

⚠ Caution

Before you connect a device to a port that supplies passive power, make sure the power will not damage the device. The power can damage devices not designed to operate with passive power.

Figure 32. Passive Power (MicroScanner PoE)

Using the Toner

You can use the tester with an optional tone probe to locate cables in bundles, at patch panels, or behind walls.









Use the tester's IntelliTone™ mode with an optional Fluke Networks IP100 or IP200 tone probe. The digital IntelliTone signal is easier to detect at a distance than analog tones, and its frequency and encoding eliminate cable misidentification due to signal bleed and radiated or ambient noise.





The tester has two IntelliTone songs and four analog songs.

The tester's analog tone mode is compatible with most tone probes.

The analog tone mode features the SmartTone™ function for positive identification of cables in bundles (page 50).

Toning in IntelliTone Mode (optional IntelliTone probe required)

- 1 MicroScanner²: Press  to select twisted pair () or coaxial () cable.
- 2 Press  or  until , **IntelliTone** and a scrolling pattern of 1s and 0s appear on the display (, , and  in Figure 33).

To change the IntelliTone song, press , , or . The display shows the song number (). The tester has two IntelliTone songs.

- 3 Connect the tester to the cable (Figure 34).
- 4 Turn the probe's rotary switch to  (locate).
- 5 Use the probe to find the general location of the tone at a cable rack, patch panel, or behind a wall, as shown in Figure 34. The **SYNC** LED lights up green when the probe is receiving the IntelliTone signal.

The probe's LEDs light up from 1 to 8 as the signal strength increases. The higher the number, the stronger the signal.

-continued-

MicroScanner Series Cable Verifiers

Users Manual

Note

If you cannot locate the IntelliTone signal on 2-conductor cables, the cable may be shorted. Use the tester to check for shorts. See pages 16 and 18.

- 6 Turn the probe's rotary switch to  (isolate).
- 7 Use the probe to isolate the tone source in the cable bundle or at the patch panel. The **SYNC** LED lights up green when the probe is receiving the IntelliTone signal.

The probe's LEDs light up from 1 to 8 as the signal strength increases. The higher the number, the stronger the signal.

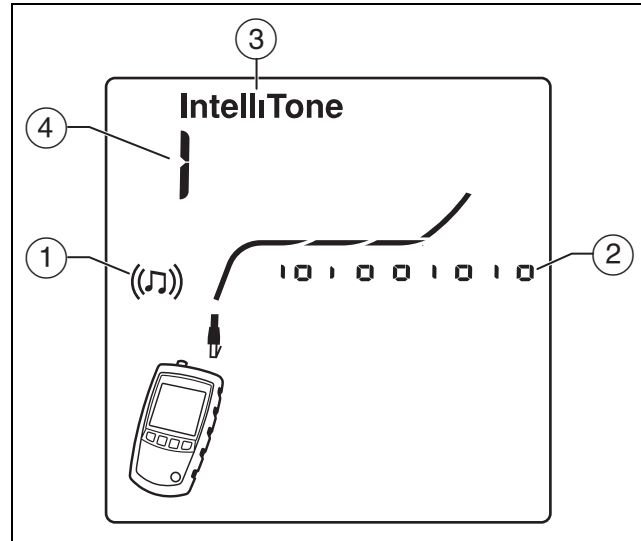

EGK07.EPS

Figure 33. IntelliTone Toner Mode Display

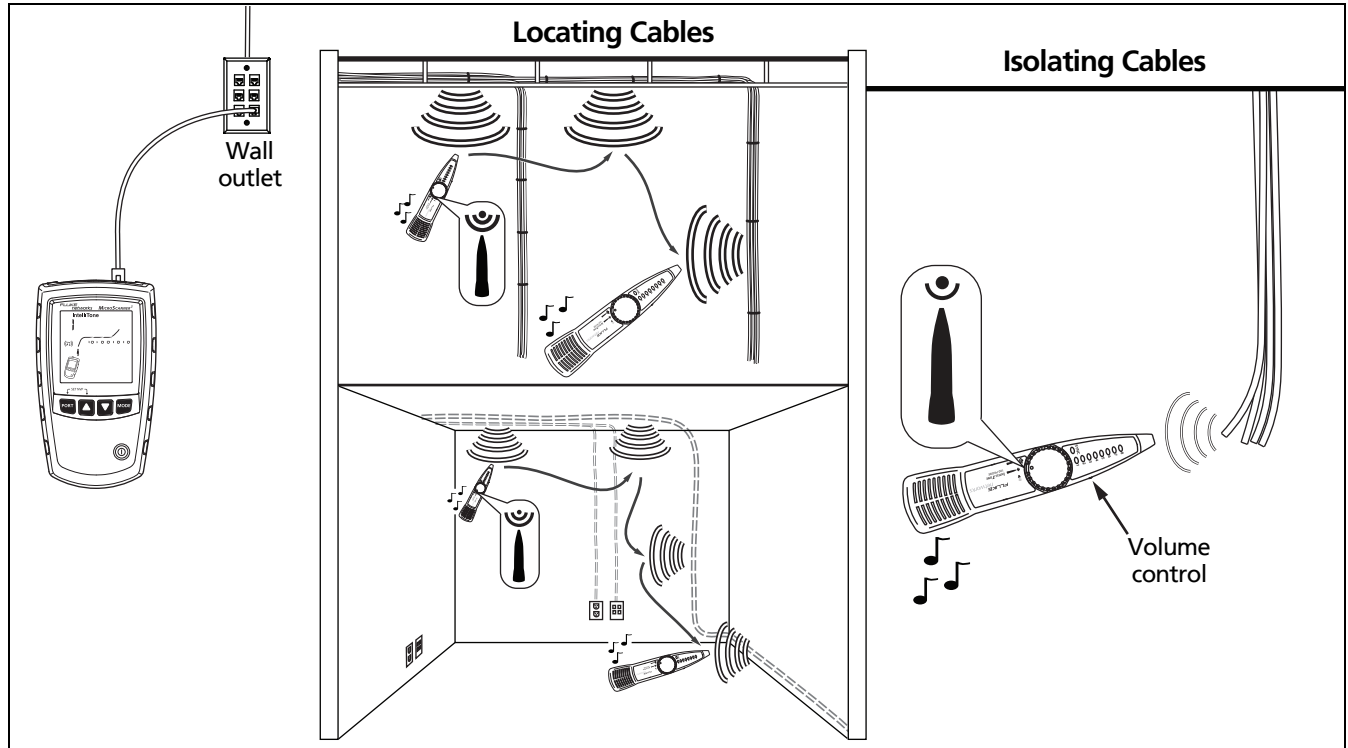

Figure 34. Using the Toner in IntelliTone Mode

EGK24.EPS

Analog Toner Mode (optional tone probe required)

Refer to Figure 35.

- 1 Turn on the tester, then connect the tester to the cable.
- 2 MicroScanner²: Press **PORT** to select twisted pair or coaxial cable.
- 3 Press **MODE** or **TONE** until **((♪))** appears on the display (1); then press **▼** or **⌂** to select an analog tone. The display shows a scrolling sinewave in analog toner mode (2).
- 4 To change songs, press **▼** or **⌂**. The display shows the song number (3). The analog toner has four songs.
- 5 Use the probe to search for the cable.

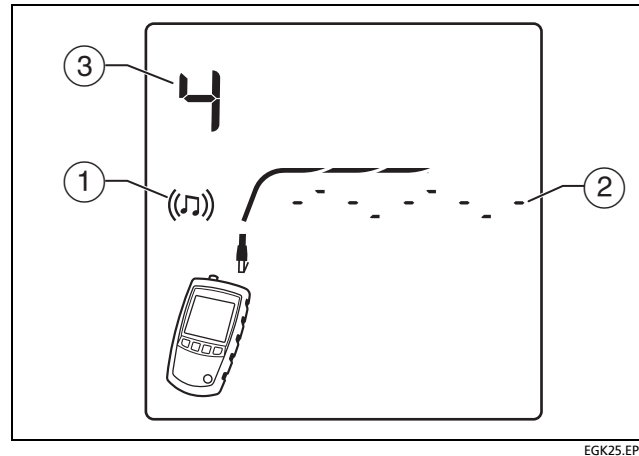







Figure 35. Analog Toner Mode Display

Using the SmartTone Function

Use the SmartTone™ function when you have trouble locating a cable. This function changes the toner's song when you short a wire pair in the cable connected to the tester. SmartTone works with the IntelliTone probe and with analog probes.

Note

Use the SmartTone function only on dry pairs of wires that are unterminated at both ends. Do not use this function on powered wires.

- 1 Turn on the tester, then connect the tester to the cable.
- 2 MicroScanner²: Press  to select twisted pair or coaxial cabling.
- 3 Press  or  until  appears on the display.
- 4 Press  or  to select the analog toner mode (**IntelliTone** disappears from the display).
- 5 At the far end of the cabling, place the probe near the ends of the cables.
- 6 Momentarily short a wire pair in a cable (twisted pair) or short the conductor and shield in a cable (coaxial). If the song changes when you release the short, you have found the cable connected to the tester.

Using the IntelliTone Cable Map Function (optional IP200 probe required)

The tester's IntelliTone function works with an optional IP200 probe's cable map function to verify wiring at the far end of the cabling. The probe's cable map function identifies the most common wiring faults on twisted pair cabling: shorts, opens, and crossed pairs.

- 1 Press **PORT** to select twisted pair cabling (🔌).
- 2 Turn the probe's rotary switch to **CABLE MAP**.
- 3 Connect the tester and probe to the cabling as shown in Figure 36.

- 4 Press **▼** or **Ⓟ** until ((J)) appears on the display. IntelliTone mode is indicated by **IntelliTone** and a scrolling pattern of 1s and 0s on the display. See Figure 36.
- 5 The probe's LEDs light in sequence to indicate the cable's wiring. See the probe's documentation for details.

Note

*Normally, the probe's **SYNC LED** lights to indicate reception of the IntelliTone signal. You may change the LED's function to indicate shield continuity. See the probe's documentation for details.*

Calibrating Length Measurements

The tester uses an NVP value (nominal velocity of propagation) and the signal delay through the cable to calculate length. The tester's default NVP values are usually accurate enough to verify length; however, you can increase the accuracy of length measurements by adjusting the NVP to a specified or actual value.

The default NVP values are 70 % for twisted pair cable and 82 % for coaxial cable (MicroScanner²).

Note

NVP values can vary among cable types, lots, and manufacturers. In most cases, these differences are minor and may be disregarded.

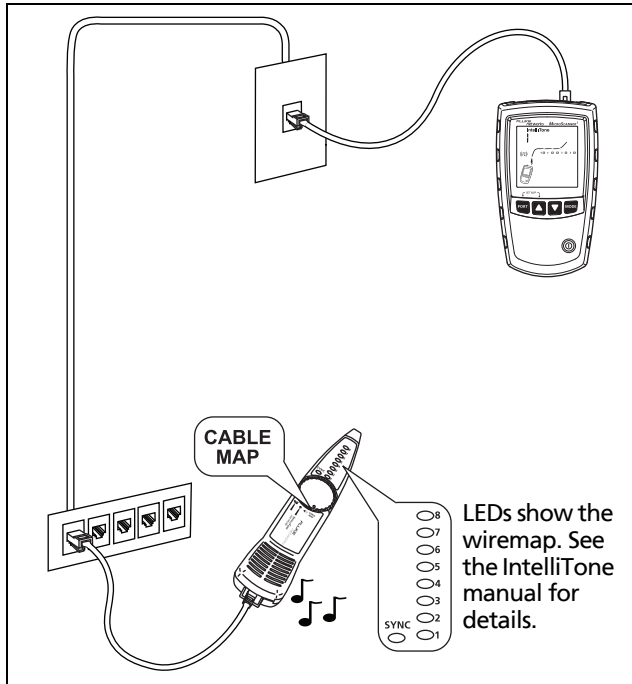









EGK26.EPS

Figure 36. Using the Toner with the IP200 IntelliTone Cable Map Function

Setting the NVP to a Specified Value







To enter the NVP value specified by the manufacturer:

- 1 Turn on the tester while holding down the  and  or  and  keys.
- 2 MicroScanner²: To set the NVP for the coaxial port () , press .
- 3 Use  and  or  to set the NVP value.
- 4 To save the setting and exit NVP mode, turn the tester off then on again.

Determining a Cable's Actual NVP

You can determine a cable's actual NVP by adjusting the measured length to match a known length of cable.

To determine a cable's NVP:

- 1 Turn on the tester while holding down the  and  or  and  keys.
- 2 MicroScanner²: To set the NVP for the coaxial port () , press .





- 3 Connect a known length of the cable to be tested to the tester's twisted pair or coaxial connector.

Notes

The cable must be at least 49 ft (15 m) long. If the cable is too short, "---" appears for the length.

For the best accuracy, use a cable between 49 ft (15 m) and 98 ft (30 m) long.

The cable must not be connected to anything.

- 4 To switch between meters and feet, press  or .
- 5 Use  and  or  to change the NVP until the measured length matches the actual length of the cable.
- 6 To save the setting and exit NVP mode, turn the tester off then on again.

Maintenance

Warning

To avoid possible fire, electric shock, personal injury, or damage to the tester:

- Do not open the case. No user-serviceable parts are inside.
- Replacing electrical parts yourself will void the tester's warranty and might compromise its safety features.
- Use only specified replacement parts for user-replaceable items.
- Use only Fluke Networks authorized service centers.

Cleaning

Clean the display with glass cleaner and a soft, lint-free cloth. Clean the case with a soft cloth dampened with water or water and a mild soap.

Caution

To avoid damaging the display or the case, do not use solvents or abrasive cleansers.

Battery Life, Status, and Replacement

Warning

To avoid possible electric shock or personal injury:

- Turn off the tester and disconnect all test leads before replacing the battery.
- Use only the correct type of batteries, properly installed in the case, to power the tester.

Typical battery life:

- MicroScanner PoE: approximately 15 hours of typical use.
- MicroScanner²: approximately 20 hours of typical use.

Replace the tester's batteries when the low battery indicator () appears. See Figure 37.

MicroScanner Series Cable Verifiers Users Manual

You can use the following types of AA (IEC LR6) batteries in the tester:

- Alkaline
- Lithium
- Rechargeable nickel-metal hydride (NiMH)
- Rechargeable nickel-cadmium batteries (NiCD)

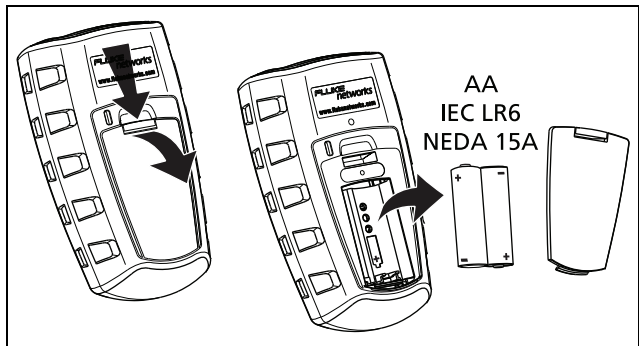

EGK28.EPS

Figure 37. Replacing the Tester's Batteries

Checking the Tester's Version, Serial Number, and MAC Address

Turn the tester on while holding down the and or and keys.

Use and or to scroll through the screens:

- **SOF**: Software version
- **Sr**: Serial number
- **FAC**: Factory test date
- **MicroScanner PoE: 17AC 1, 17AC 2**: The first and second half of the tester's MAC address.

To exit this mode, turn the tester off.

Learn More

The Fluke Networks Knowledge Base answers common questions about Fluke Networks products and provides articles on cable testing techniques and technology.

To access the Knowledge Base, log on to www.flukenetworks.com, then click **SUPPORT > Knowledge Base**.

If Something Seems Wrong with the Tester

If something seems wrong with the tester, refer to Table 3.

If Table 3 does not help you solve a problem with the tester, contact Fluke Networks for additional help. If possible, have the tester's version and serial number.

For warranty information, refer to the warranty at the beginning of this manual. If the warranty has lapsed, contact Fluke Networks for repair prices.

Table 3. Problems with the Tester

Symptom	Action
The keypad does not respond.	Press and hold  until the tester turns off; then turn the tester on again.
The tester will not turn on.	Replace the batteries, verifying that they are installed correctly. See Figure 37 on page 55.
Length measurements are incorrect.	Check the NVP value. See "Calibrating Length Measurements" on page 52.

Options and Accessories

For the latest list of options and accessories visit the Fluke Networks website at www.flukenetworks.com.

Specifications

Specifications apply at 23 °C (73 °F), unless otherwise noted.

Environmental Specifications

Operating temperature	32 °F to 113 °F (0 °C to 45 °C)
Storage temperature	-4 °F to +140 °F (-20 °C to +60 °C)
Operating relative humidity (% RH without condensation)	90 % (50 °F to 95 °F; 10 °C to 35 °C) 75 % (95 °F to 113 °F; 35 °C to 45 °C)
Shock and Vibration	Random, 2 g, 5 Hz-500 Hz (Class 2) 1 m drop test with and without wiremap adapter attached
Safety	IEC 61010-1 3 rd Edition
Altitude	4,000 m; Storage: 12,000 m
EMC	IEC 61326-1

General Specifications

Test connectors	Shielded 8-pin modular jack accepts 8-pin modular (RJ45) and 4-pin modular (RJ11) plugs. MicroScanner ² : F-connector for coaxial cable.
Maximum input voltage	60 V
Power	Battery type: 2 AA (NEDA 15A, IEC LR6) alkaline batteries Battery life: <ul style="list-style-type: none"> • MicroScanner²: 20 hours of typical use • MicroScanner PoE: 15 hours of typical use Other compatible battery types: 2 AA photo lithium, NIMH, NICAD
Dimensions and weight (with batteries installed and wiremap adapter attached)	3 in x 6.4 in x 1.4 in (7.6 cm x 16.3 cm x 3.6 cm) MicroScanner ² : 13 oz (363 g) MicroScanner PoE: 8.7 oz (247 g)
Display	Monochrome LCD with backlight

Test Modes

Cable test	Measures length, verifies wiremap, identifies remote ID locators, and detects Ethernet ports. Shows results on one screen.
Tone	Generates Intellitone™ and normal analog toning signals
PoE	MicroScanner ² : Solicits and detects the presence of 802.3af compatible PoE (Power over Ethernet) devices. MicroScanner PoE: Solicits and detects the presence of 802.3af, at, and bt (single and dual). Shows the class of power reported by the switch and the wattage specified for the class. Uses 802.3 Link Layer Discovery Protocol (LLDP) when necessary to determine the switch's power.

Performance Specifications

Cable types tested	Twisted pair: UTP, FTP, SSTP Coaxial (MicroScanner²): 75 Ω, 50 Ω, 93 Ω
Length test	Range: 460 m (1500 ft) Resolution: 0.3 m (1 ft) Typical accuracy: ± 4% or 0.6 m (2 ft) whichever is greater. NVP uncertainty is an additional error. Calibration: User-settable NVP for twisted pair and coax (MicroScanner ²). Can determine actual NVP with known length of cable.

Wiremap test	Detects single-wire faults, shorts, miswires, split pairs, and up to seven far-end adapter IDs. The wiremap is drawn with proportional length to visually indicate the approximate location of faults.
Ethernet port detection	MicroScanner ² : Detects the advertised speed of 802.3 Ethernet ports with speeds of 10 Mbps, 100 Mbps, and 1 Gbps. MicroScanner PoE: Detects the advertised speed of 802.3 Ethernet ports with speeds of 10 Mbps, 100 Mbps, 1 Gbps, 2.5 Gbps, 5 Gbps, and 10 Gbps.
LLDP negotiation	MicroScanner PoE uses LLDP on 10/100 Mbps Ethernet networks to discover and negotiate PoE when necessary.
Tone generator	Supports toning and cable mapping with a Fluke Networks digital IntelliTone™ probe. Generates four tones compatible with typical analog probes. SmartTone™ feature gives positive identification of cables in bundles when using an IntelliTone or an analog probe.

Regulatory Information

This equipment generates, uses, and can radiate radio frequency energy, and, if not installed and used in accordance with the manual, may cause interference to radio communications. It has been tested and found to comply with the limits for a Class A digital device pursuant to Part 15, Subpart J of the FCC rules, which are designed to provide reasonable protection against such interference when operated in a commercial environment. Operation of the equipment in a residential area is likely to cause interference, in which case the user, at his own expense, will be required to take whatever measures may be required to correct the interference.

