

Legrand Wireless Lighting Installation in existing three-way circuits

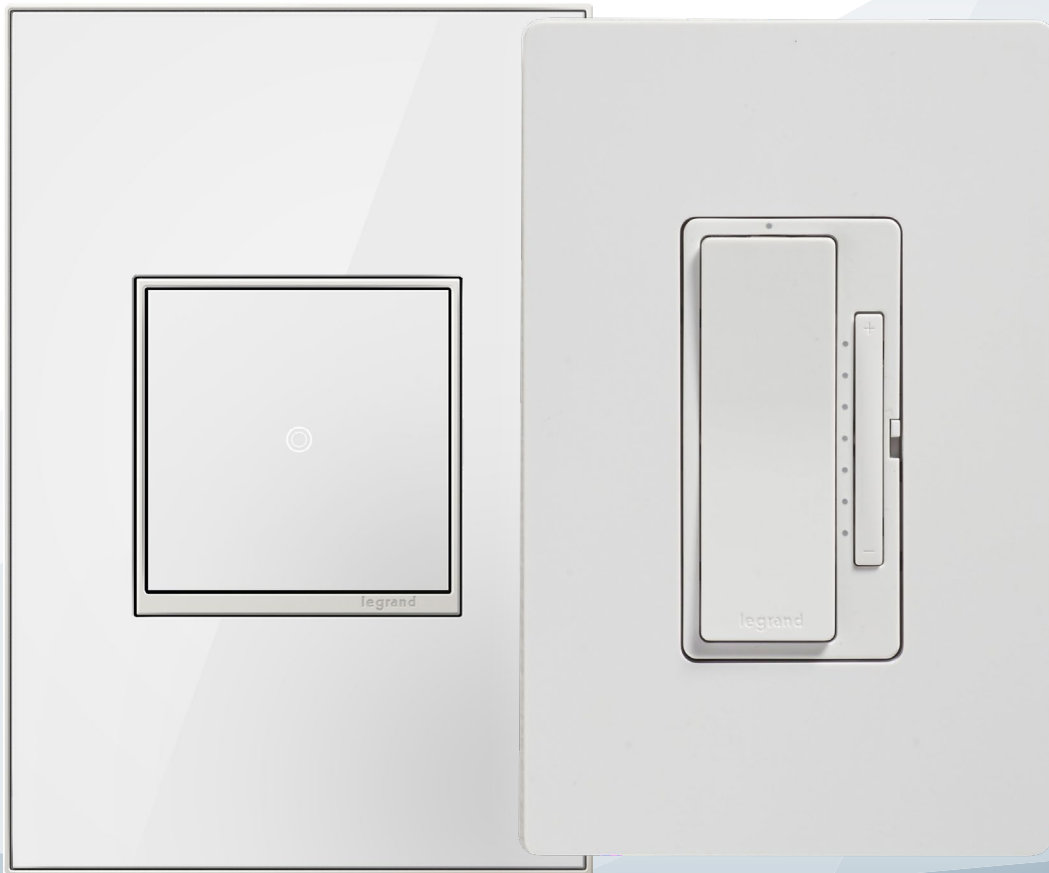

WARNING:

PLEASE READ THIS ENTIRE GUIDE BEFORE BEGINNING INSTALLATION OF YOUR RF LIGHTING OR REMOVAL OF YOUR OLD SWITCH. INCORRECT INSTALLATION CAN CAUSE SERIOUS INJURY AND POTENTIAL DAMAGE TO YOUR RF LIGHTING SYSTEM OR YOUR HOME.

Before you Start

Review this guide in its entirety before beginning device installation. Please be advised that nothing found in this guide can anticipate your situation or has been reviewed by people with the expertise required or knowledge of your specific project, environment, electronics, electrical products or equipment to provide you with complete, accurate or reliable information. This guide does not constitute, guarantee or provide, expressly or implicitly, nor does it replace, professional advice.

ALWAYS READ AND FOLLOW INSTRUCTION MANUALS AND SAFETY WARNINGS PROVIDED BY THE MANUFACTURER OF THE PRODUCT YOU ARE USING.

Any advice or guidance provided in this guide is for informational purposes only. If you are in any way unsure about completing any aspect of this, **DO NOT** undertake the work yourself and consult a qualified electrical contractor to undertake the project for you.

NOTE: THIS GUIDE IS NOT INTENDED FOR WI-FI SMART LIGHTING PRODUCTS THAT UTILIZE TRADITIONAL 3-WAY WIRING. PLEASE SEE THEIR INSTALLATION GUIDES FOR 3-WAY WIRING OF THOSE PRODUCTS.



WARNING: INCORRECT INSTALLATION COULD RESULT IN DEATH, SERIOUS INJURY, AND/OR DAMAGE TO YOUR HOME OR DEVICES.



WARNING: INSTALL IN ACCORDANCE WITH ALL NATIONAL AND ELECTRICAL CODES.

To reduce the risk of injury and/or overheating and damage to other equipment:

- For dry, indoor use only.
- Do not use to power medical equipment.
- Not suitable as a disconnecting means.
- Do not use with loads exceeding the device load rating (see product installation sheet).
- Connect the smart device to a 120 VAC, 60 Hz power source ONLY.
- Remote devices do NOT connect to any lighting loads. It is powered by your electrical wiring and uses a wireless connection to control paired devices.
- Always use copper wire to install the smart remote dimmer.
- Install in a non-metallic electrical box to protect wireless signal strength.
- Visit the Legrand website at www.legrand.us/radiant/smart-lighting.aspx to learn more about your smart device.

What you Need

REQUIRED:

- Phillips-head screwdriver
- Flat blade screwdriver
- Non-contact voltage tester

YOU MAY ALSO NEED:

- Pliers, wire cutter, wire stripper, electrical tape, flashlight, wiring leads (included), and wire nuts (included)
- **NOTE:** Do NOT use a power screwdriver or other power tool to install the device as it may lead to over-tightening. Over-tightening screws can damage the device and cause a mechanical malfunction.

These instructions are meant to supplement the installation sheets provided in your product's original packaging. Please read all documents completely before beginning. The remote 3-way wiring instructions detailed in this document are applicable for remote products from the following collections only:

- **radiant Smart Lighting**
- **radiant RF Lighting Control**
- **radiant Apple HomeKit Lighting**
- **Adorne Wireless Lighting**

This document does NOT apply to the follow products:

- **radiant WWRL50 Smart Wi-Fi Tru-Universal Dimmer***
- **radiant WWRL10 Smart Wi-Fi Switch****

*The WWRL50 works with Legrand HMR Multi-location remotes for 3 way dimming.

**The WWRL10 switch works with any mechanical 3-way switch

WARRANTY DISCLAIMER

USE OF THIS GUIDE IS AT YOUR SOLE RISK. ALL MATERIALS, INFORMATION, PRODUCTS AND SERVICES ARE PROVIDED "AS IS," WITH NO WARRANTIES OR GUARANTEES WHATSOEVER. LEGRAND, NORTH AMERICA ("LNA") EXPRESSLY DISCLAIMS TO THE FULLEST EXTENT PERMITTED BY LAW ALL EXPRESS, IMPLIED, STATUTORY, AND OTHER WARRANTIES, GUARANTEES, OR REPRESENTATIONS, INCLUDING, WITHOUT LIMITATION, THE WARRANTIES OF MERCHANTABILITY, FITNESS FOR A PARTICULAR PURPOSE, AND NON-INFRINGEMENT OF PROPRIETARY AND INTELLECTUAL PROPERTY RIGHTS.

SOME JURISDICTIONS DO NOT ALLOW THE EXCLUSION OF WARRANTIES, SO THE ABOVE EXCLUSIONS MAY NOT APPLY TO YOU.

LIMITATION OF LIABILITY

IN NO EVENT WILL LNA BE LIABLE TO ANY PARTY FOR ANY DIRECT, INDIRECT, INCIDENTAL, SPECIAL, EXEMPLARY OR CONSEQUENTIAL DAMAGES OF ANY TYPE WHATSOEVER RELATED TO OR ARISING FROM THIS GUIDE OR ANY USE OF THIS GUIDE, OR OF ANY SITE OR RESOURCE LINKED TO, REFERENCED, OR ACCESSED THROUGH THIS GUIDE, INCLUDING, WITHOUT LIMITATION, ANY LOST PROFITS, BUSINESS INTERRUPTION, LOSS OF PROPERTY, COST OF REMOVAL, INSTALLATION OR REINSTALLATION, EVEN IF LNA IS EXPRESSLY ADVISED OF THE POSSIBILITY OF SUCH DAMAGES. THIS EXCLUSION AND WAIVER OF LIABILITY APPLIES TO ALL CAUSES OF ACTION, WHETHER BASED ON CONTRACT, WARRANTY, TORT, OR ANY OTHER LEGAL THEORIES.

Step 1

Prepare existing devices.

⚠️ Switch power off at the panel.

Remove both switch plates.

Pull devices from their boxes.

Use a non-contact voltage tester to verify all wires have no power. (Follow the instructions provided with the tester.)

Disconnect wires and **CAP ENDS**.

Step 2

Identify the existing wiring.

Determine which circuits are connected by identifying the wires in each box. Use the diagrams below as a guide.

If your circuits are not Type A, B or C below, stop immediately and contact licensed electrician for assistance.

Step 3

Prepare accordingly.

Once you have determined the wiring type that you have, follow the steps that correspond with that Circuit Type (A, B, or C). If you are unsure, stop immediately and contact a licensed electrician for assistance.

Note: It may be helpful to label your boxes while working to easily identify the Load and Supply

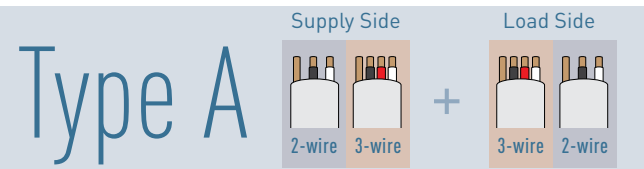

Type A
This circuit has power coming to one of the switch boxes first. It carries power from the panel through both boxes before connecting to the load. It can be identified by both boxes containing a single 2-wire and a single 3-wire. The load will have a single 2-wire feeding it.

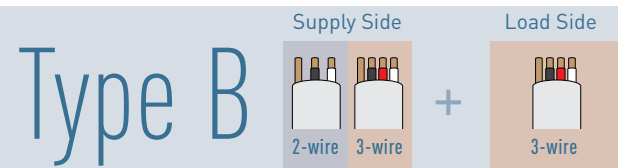
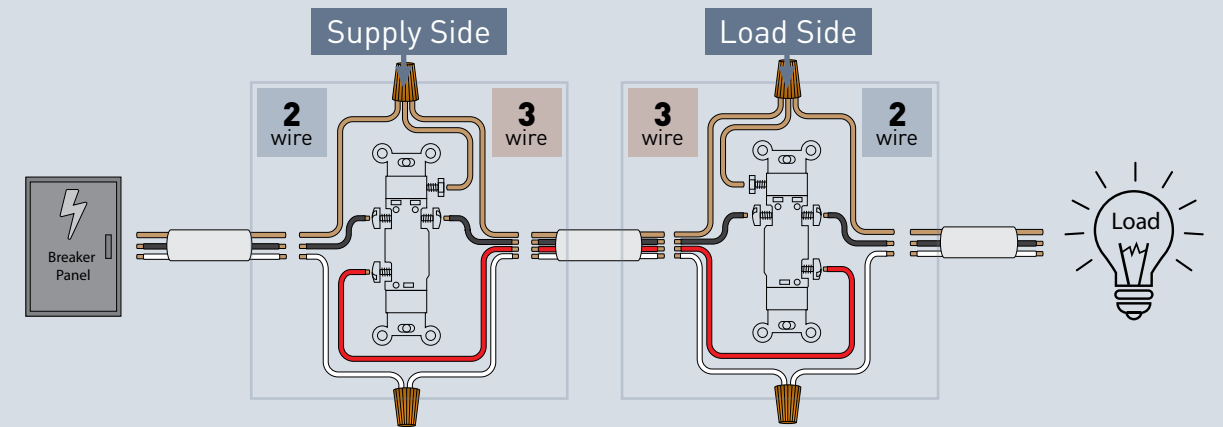

Type B
This circuit has power coming to one of the switch boxes. It carries power through the load to the other box. It can be identified by one box containing a single 2-wire and a single 3-wire. The other box will have a single 3-wire, while the load will have two 3-wires.

NOTE: For this wiring you will need to locate the light fixture that is directly connected to the circuit as shown.

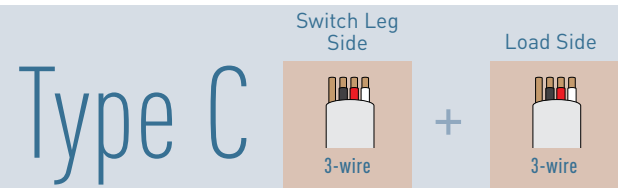
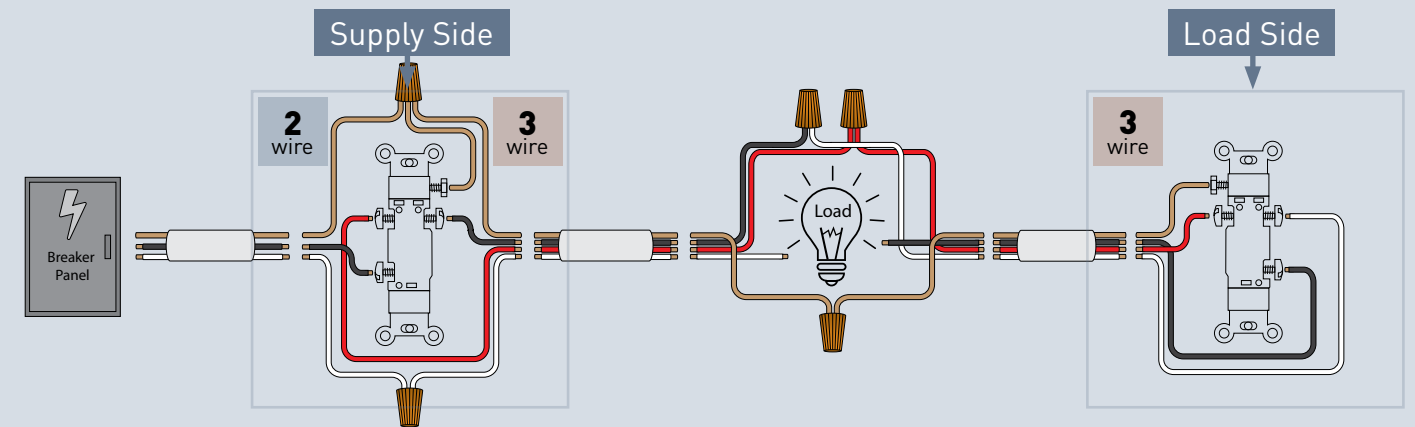

Type C
This circuit has power coming to the load first. It can be identified by two boxes with a single 3-wire in each. The load will have two 3-wires, one to each box and a 2-wire coming in from the panel.

NOTE: For this wiring you will need to locate the light fixture that is directly connected to the circuit as shown.

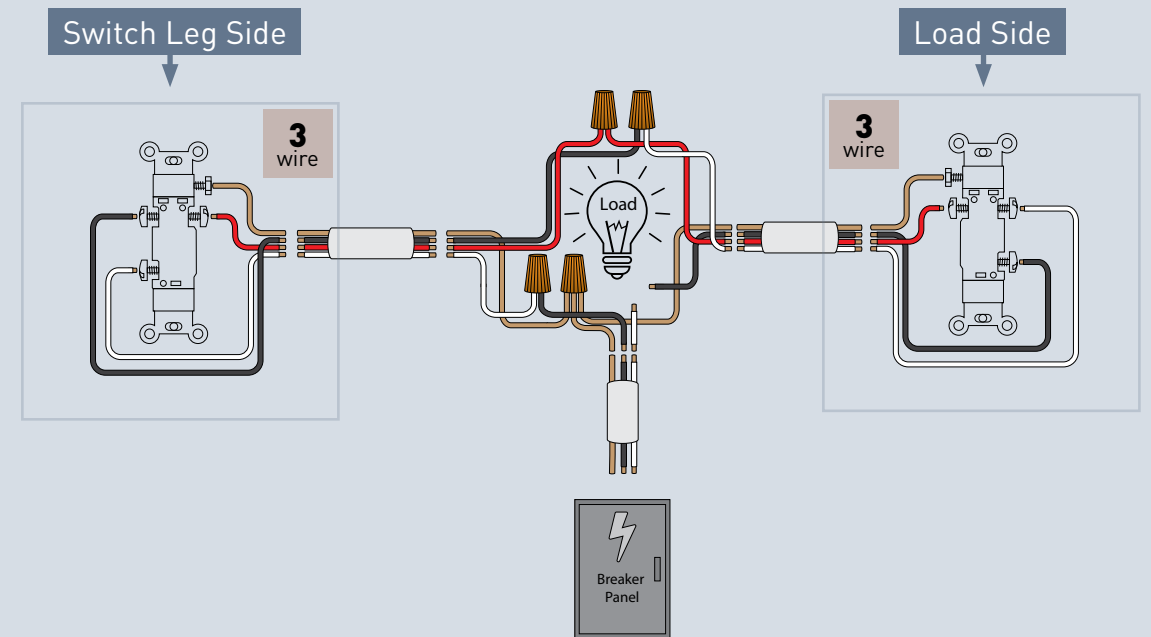

Key

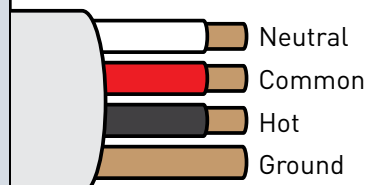

Type A

Step A1

Locate the **HOT** and **LOAD** sides of the circuit.

Switch power **ON** at the panel.

Use a non-contact voltage tester to locate and **LABEL** the **HOT** wire. Make sure to check both switch locations. (Follow the instructions provided with the tester.)

⚠ Switch power **OFF** at the panel.

The device with the **HOT** wire is the **SUPPLY** side of the circuit. **This is where the Remote will be installed.**

The remaining device is the **LOAD** side. **This will be where the Master will be installed.**

Step A2

Connect your new switches or dimmers.

⚠ Switch power **OFF** at the panel.

Use a non-contact voltage tester to verify that all wires have no power. (Follow the instructions provided with the tester.)

Wire your new Legrand devices per the diagram below by first connecting Remote to the supply side using the instructions included. (Remember, the device with the **HOT** wire is the **SUPPLY** side of the circuit.)

Next, connect Master to the **LOAD** side using the included instructions.

Step A3

Finish installation and setup.

Install wall plates.

Switch power **ON** at the panel.

Verify control from the Master Switch.

Complete setup of remote device(s) per device instructions.

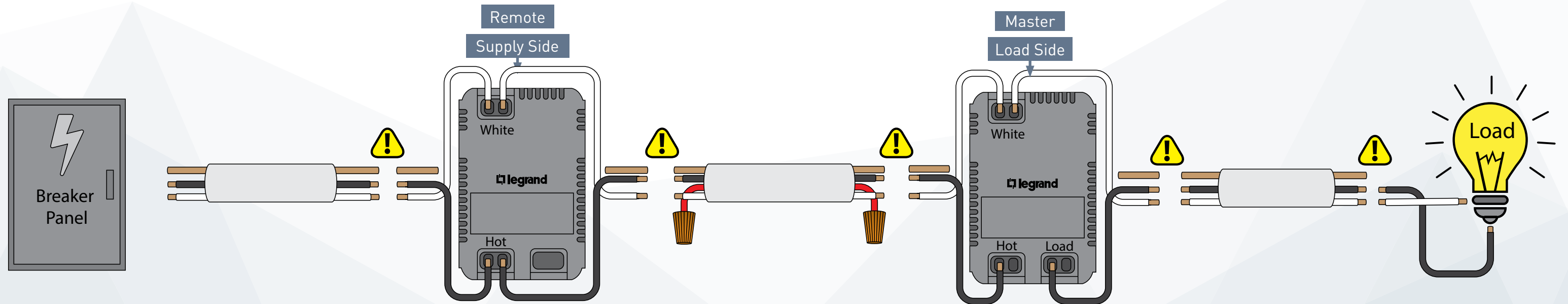

Key

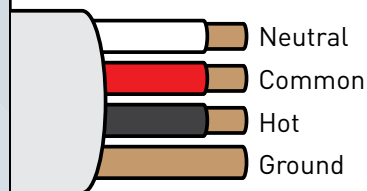

⚠ Always properly ground your devices according to device instructions.

Type B

Step B1

Locate the **HOT** and **LOAD** sides of the circuit.

⚠️ Ensure power is **OFF** at the panel.

Locate the box with both a 2-wire and a 3-wire.

This is the **SUPPLY** side of the circuit.

The remaining box is the **LOAD** side.

Step B2

Connect your new switches or dimmers.

Wire your new Legrand devices per the diagram below by first connecting Remote to the supply side using the included instructions.

Next, connect Master to the **LOAD** side using the included instructions.

Rewire the light fixture per the diagram shown below.

Step B3

Finish installation and setup.

Install wall plates.

Switch power **ON** at the panel.

Verify control from the Master Switch.

Complete setup of remote device(s) per device instructions.

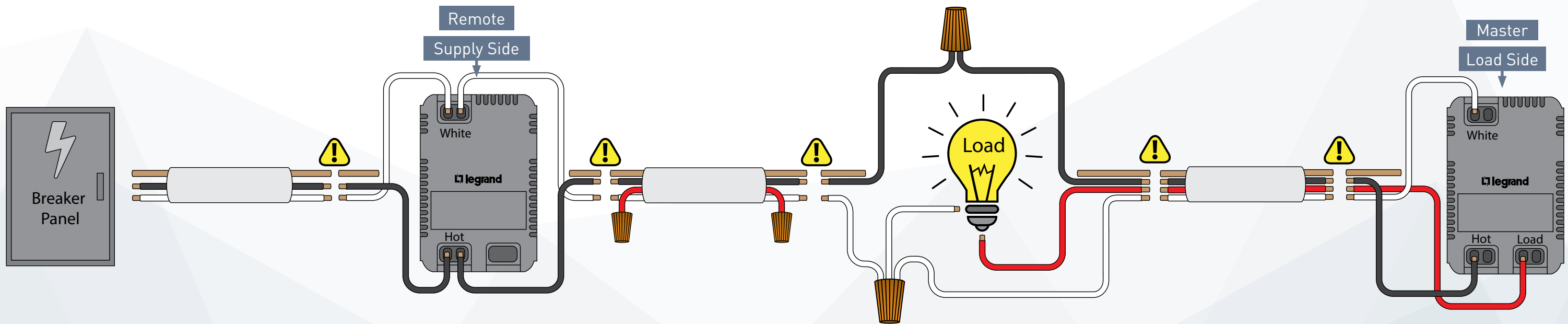

Key

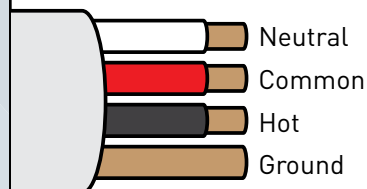

⚠️ Always properly ground your devices according to device instructions.

Type C

Step C1

Locate the **HOT** and **LOAD** sides of the circuit.

⚠️ Ensure power is **OFF** at the panel.

Locate the box with both a 2-wire and a 3-wire.

This is the LEG side of the circuit.

The remaining box is the LOAD side.

Step C2

Connect your new switches or dimmers.

Wire your new Legrand devices per the diagram below by first connecting Remote to the supply side using the included instructions.

Next, connect Master to the LOAD side using the included instructions.

Rewire the light fixture per the diagram shown below.

Step C3

Finish installation and setup.

Install wall plates.

Switch power **ON** at the panel.

Verify control from the Master Switch.

Complete setup of remote device(s) per device instructions.

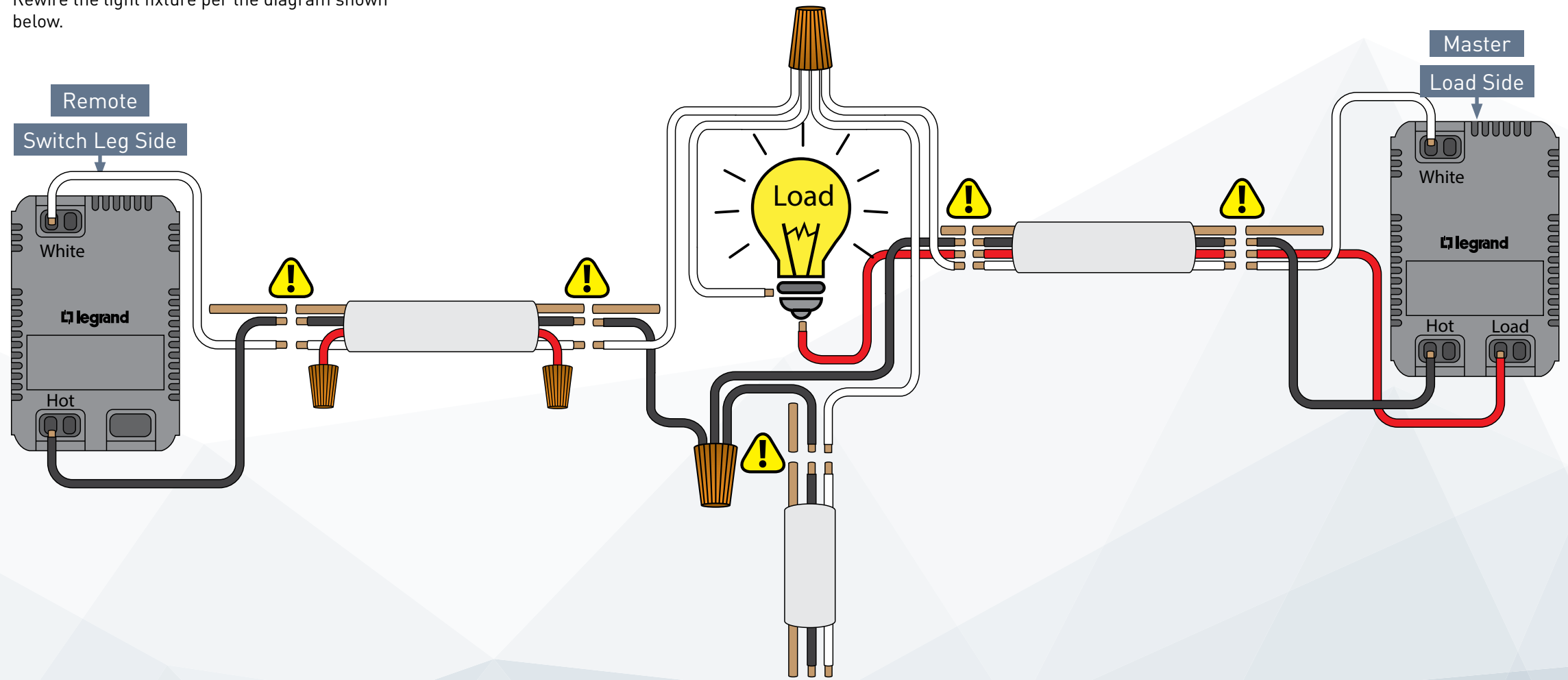

Key

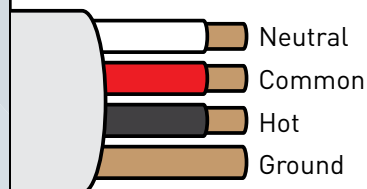

⚠️ Always properly ground your devices according to device instructions.

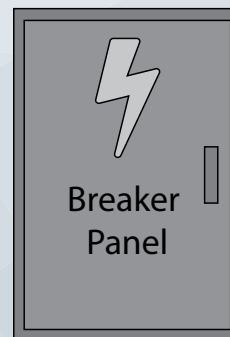

TRANSFORM YOUR SPACES WITH LEGRAND



From the world leader in electrical switches and outlets -
<http://www.legrand.us/3wayinstallationinstructions>

designed to be better™



Legrand, North America

60 Woodlawn Street
West Hartford, CT 06110
1.877.BY.LEGRAND (295.3472)
www.legrand.us

570 Applewood Crescent
Vaughan, Ontario L4K 4B4
905.738.9195
www.legrand.ca