



## MSK-1 | MSK-1G | MSK-1SM PRODUCT SPECIFICATIONS

|  |  |
|--|--|
| System Type                              | Direct drive for sound masking   |
| Impedance (nominal) <sup>1</sup>         | 8 ohm  |
| Sensitivity dB @ 2.83V/1M                | 69 dB10  |
| Sensitivity dB @ 1W/1M <sup>2</sup>      | 69 dB10  |
| Frequency Response (- 3 dB) <sup>3</sup> | 80 Hz - 10 kHz   |
| Frequency Response (-10 dB) <sup>3</sup> | 70 Hz - 15 kHz   |
| Max. Program Power <sup>4</sup>          | 50 w   |
| Max. Continuous Power RMS <sup>5</sup>   | 30 w   |
| Max. Power SPL @ 1 M <sup>6</sup>        | 86 dB (drywall)  |
| Coverage Angle (-6 dB @ 2 kHz)           | 120°   |
| Coverage Angle (-6 dB @ 10 kHz)          | 120°   |
| Transducer                               | SolidDrive SD-1s   |
| Enclosure Material                       | Titanium adonized aluminum   |
| Grille                                   | N/A  |
| Inputs                                   | Plenum rated wire lead with screw connector block  |
| Colors                                   | Titanium   |
| Height                                   | 51.3 mm (2.02 in)  |
| Diameter                                 | 58.4 mm (2.30 in)  |
| Weight                                   | 0.5 kg (1.2 lb)  |
| Shipping Weight                          | 0.9 kg (2.0 lb)  |
| Accessories                              |  |
| Optional                                 | Drywall EQ, Glass EQ, Wood EQ, Pre-Construction Bracket, SD1 Wall Bracket, 20 Watt Transformer, Heat Sink Fins |
| Packaging                                | 1 per box  |
| Regulatory - CE                          | Approved   |
| Regulatory - UL                          | UL 1480A & 2043 approved   |
| RoHS                                     | Approved   |

Notes:

- <sup>1</sup> Impedance listed per IEC 60268-5
- <sup>2</sup> 1w1m sensitivity determined using nominal impedance
- <sup>3</sup> Frequency response measured in half or full space as dictated by speaker mounting configuration
- <sup>4</sup> Max program power is 3 dB above max continuous power
- <sup>5</sup> Continuous power rating EIA-426-B test
- <sup>6</sup> Max output based on max continuous power
- <sup>10</sup> Equivalent to conventional in-wall @ 4m

### Description

The MSK-1 by SolidDrive is an economical hidden planar-source sound transducer designed for sound masking on drywall, glass and wood. Featuring a rugged aluminum enclosure with neodymium magnets, the MSK-1 uses technology similar to our patented SD1 transducers to transfer acoustic energy to the substrate. The result is extremely wide and even audio coverage and acoustical uniformity in the listening space.

### Key Features

- Hidden planar-source audio technology evenly distributes sound masking signals throughout the listening space.
- Broad and even coverage of up to 15 feet per unit in a drywall installation means a few units cover a large area.
- Proprietary behind-surface mounting technologies ensure maximum visual appeal.
- 86 Max SPL (drywall) and 120° dispersion pattern across the upper registers of the frequency spectrum.
- Drywall optional accessories: self-leveling, constant tension pre-construction bracket to ensure proper alignment & wall contact.
- Optional accessories include passive EQ module for drywall, glass and wood; 20 Watt metal junction box for 25, 70.7 & 100 Volt applications (AC-JB20-XFMR) and Heat Sink Fins.
- SolidDrives operate in a virtually friction-free environment and are engineered for infinite life. SolidDrives come with an industry-leading 7-year warranty.

### Commercial Applications

MSK-1 by SolidDrive technology allows for high quality sound through drywall surfaces in either in-wall or in-ceiling installations. Applications include any sound masking installation in ceilings or walls that requires a hidden speaker solution. With planar-source technology, the location of the SolidDrive on the surface has no impact on the quality or uniformity of the delivered sound field and each unit provides coverage over a large area. For improved bass response, SolidDrive IW200 (dual 8 inch) or IW210 (dual 10 inch) subwoofers can be included. An optional 20 Watt transformer is supplied in a junction box and is available for 25, 70.7 or 100 Volt applications.

### SoundTube®

13720 W. 109th St.  
Lenexa, KS 66215  
Phone: 913.663.5600  
Fax: 913.663.3200  
Toll Free: 855.663.5600  
www.soundtube.com

All SoundTube speakers come with a 7-year limited warranty.

## SolidDrive EQ Modules

The surface material plays a key role in the system's sound performance. To ensure an optimal listening experience, the MSK-1 system can be equalized with the optional SolidDrive Passive Equalization Module (Not UL approved). The PEM increases the system's sound performance with a passive equalizer network specifically engineered for sheetrock. One module is used with each SolidDrive.

## Patented Technologies

The MSE Audio Group constantly develop new technologies which enhance audio product performance. MSE Audio innovations are protected by multiple U.S. and international patents. The MSE Audio Group actively defends its patents in order to protect SoundTube resellers and end-users.

## Technical Data and Specification Tools

### Technical Data

MSE Audio strives to provide complete and effective technical information and data to dealers, engineers and designers. All data are available from MSE Audio or [www.mseaudio.com](http://www.mseaudio.com).

Technical data and downloads include:  
Tech Sheets – Technical information and architectural specs for system engineers

### Independent Data Acquisition and Verification

All data for MSE Audio speakers are collected and verified by an independent third party testing laboratory. All data are collected and analyzed according to ASTM, ISO and AES standards using EASERA, TEF and MLSSA. Full balloon data including both phase and magnitude are compiled into a variety of formats including EASE 4.x, GLL and CLF.

## Architectural Specifications

The loudspeaker shall consist of a full-range transducer constructed with neodymium magnets in an anodized titanium enclosure. Performance specifications are dependent upon substrate type and size. Typical production unit specifications are as follows: Useable frequency response shall extend from 70 Hz – 15 kHz (-10 dB, ½ space, no external equalization). Measured sensitivity (2.83 Volt input, 1 meter) shall be at least 69.0 dB (drywall tested). The speaker shall have a nominal impedance of 8 Ohms and rated power capacity shall be at least 30 Watts RMS. The max. SPL shall be 86.0 dB (drywall tested). Installation for the SolidDrive shall include galvanized steel pre-construction bracket for drywall. Overall cabinet dimensions for the Private Sound shall be no more than 52.8mm (2.08 in) in height by 88.9 mm (3.50 in) in diameter. The SD-1s shall weigh no more than 0.50 kg or 1.2 Lbs. SolidDrive models shall come with plenum rated speaker wire with screw connector block

Frequency Response – Typical Dry-wall SolidDrive Response

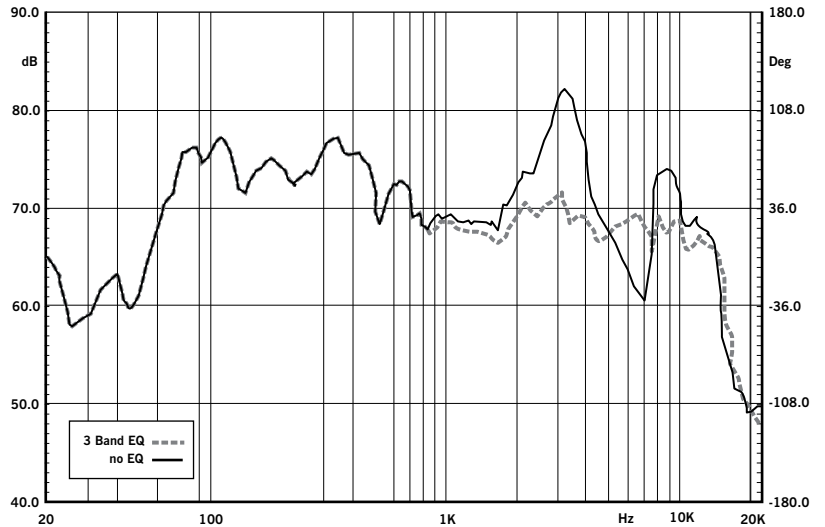

Frequency Response – Typical Wood Table-Top SolidDrive Response

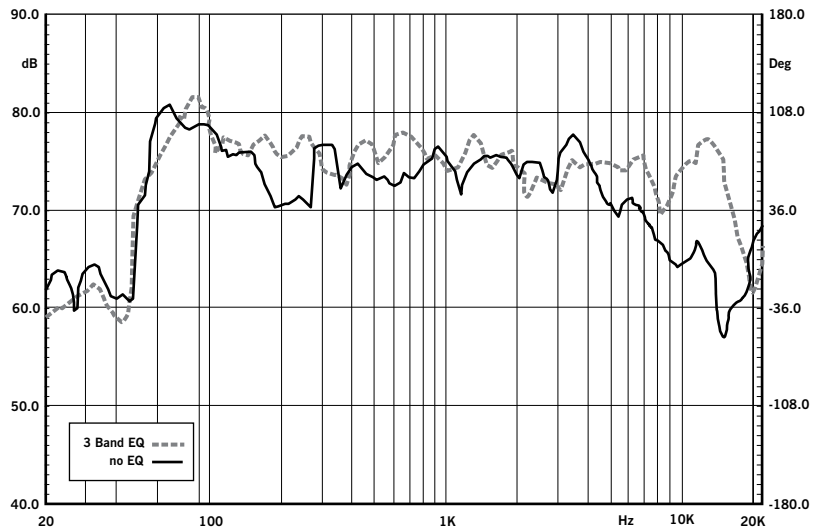

Frequency Response – Typical Glass SolidDrive Response

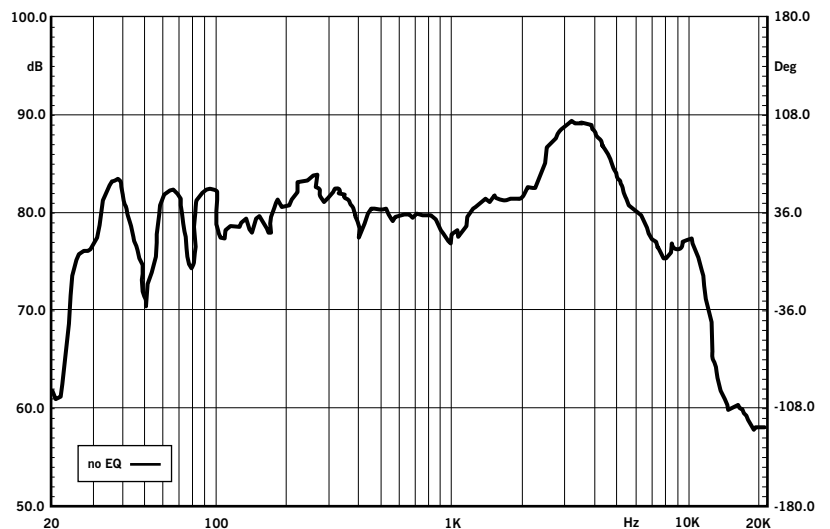

**Directivity Index (DI) - Off Axis Response On 4x8' Drywall Panel Outdoors in 4' Direction Referenced to 0deg @2m**

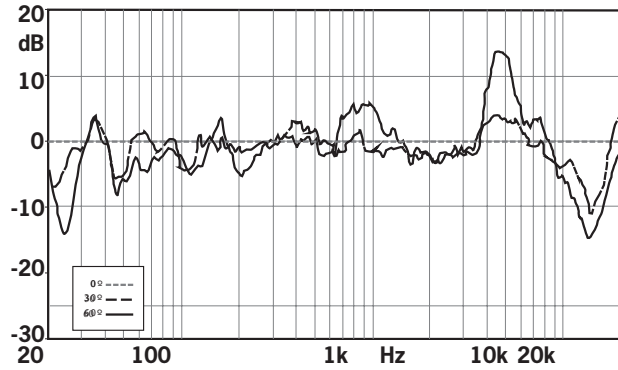

**Dry-Wall Passive EQ**

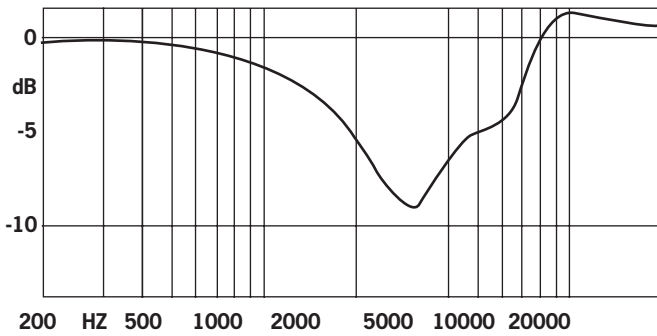

**Glass Passive EQ**

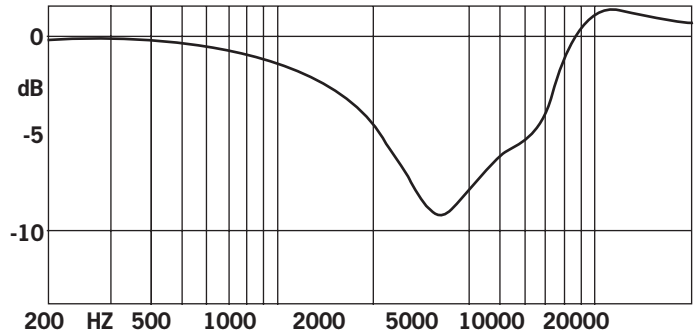

**Wood/Desktop Passive EQ**

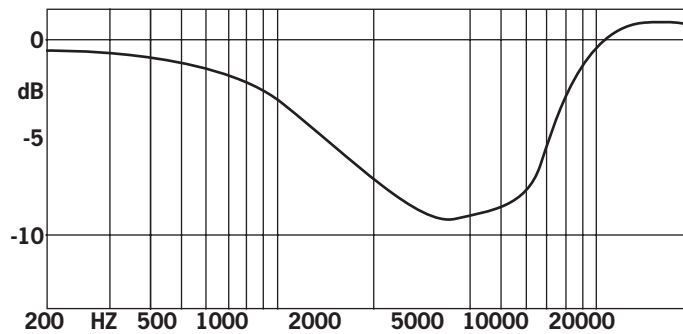

## Mechanical Drawings

---

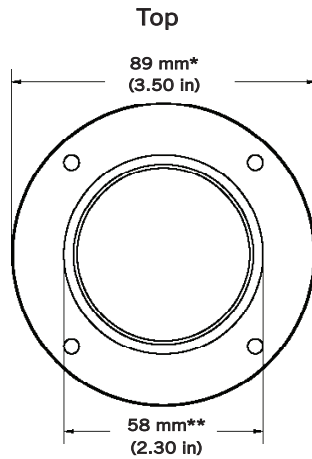

\*MSK-1 drywall and MSK-1sm  
\*\*MSK-1g

## Mounting Options

---

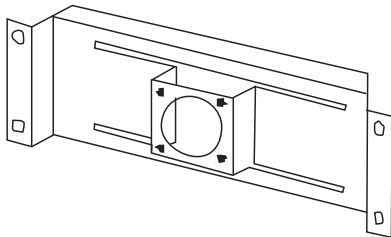

**In-wall mount**  
used with MSK-1

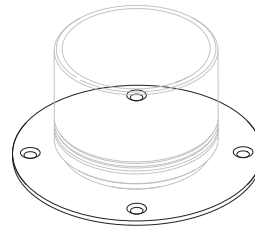

**Surface mount** - mounts screws from back  
used with MSK-1sm

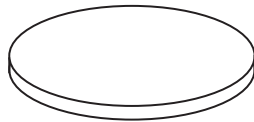

**Double sided VHB pad**  
included with MSK-1g