

INSTALLATION GUIDE

 **legrand**[®]

CABLOFIL WIRE MESH TRAY
CHEMIN DE CÂBLES EN TREILLIS MÉTALLIQUE
BANDEJA DE MALLA DE ALAMBRE CABLOFIL

Cablofil, the inventor of wire mesh cable tray is a revolutionary cable management system that provides exceptional strength combined with the flexibility to adapt easily to field requirements. Installation is easier since wire mesh requires fewer parts and the FAS system allows splice, bracket and accessory connections without hardware!

Cablofil, l'inventeur du chemin de câbles en treillis métallique, offre un système de gestion de câblage révolutionnaire d'une robustesse exceptionnelle à laquelle s'ajoute la souplesse d'une adaptation aisée aux exigences d'une installation particulière. La pose est plus facile dans la mesure où le treillis métallique demande moins de pièces et où le système FAS permet les raccordements par jonction de fils, sur consoles et par adaptateurs !

Cablofil, el inventor de bandejas portacables de malla de alambre es un sistema revolucionario de gestión de cables que proporciona una fuerza excepcional combinada con la flexibilidad para adaptarse fácilmente a los requisitos de la planta. ¡La instalación es más sencilla ya que la malla de alambre requiere menos piezas y el sistema FAS permite hacer conexiones de empalme, soporte y accesorios sin tornillería!

8
00388 00082
7

WARNING! DO NOT USE AS A WALKWAY LADDER OR SUPPORT FOR PERSONNEL. USE ONLY AS A MECHANICAL SUPPORT FOR CABLES, TUBING AND RACEWAYS.

AVERTISSEMENT! CEÇI N'EST PAS UNE PASSERELLE NI UNE ÉCHELLE. NI UN APPUI POUR LE PERSONNEL. UTILISER UNIQUEMENT POUR SUPPORTER DES CABLES, TUYAUX ET DES CANALISATIONS.

PRECAUCIÓN: NO SE USE COMO ANDADOR, ESCALERA O PARA APOYO DE PERSONAL. SU USO ES ÚNICAMENTE COMO SOPORTE MECÁNICO PARA CABLES Y CANALIZACIONES.

legrand®

Cablofil

CABLE TRAY

AS TO ITS SUITABILITY AS AN EQUIPMENT GROUNDING CONDUCTOR ONLY 24WA

Suitable for use as Grounding Conductor: Appropriate comme conducteur de mise à la terre.

Minimal Cross Sectional Area: 125 Sq. mm. (0.20 sq. in. /po².) Section minimale Rated Load/1.8m Span=37kg/m(8ft Span = 25lbs/ft) ANCE Load Rating: 6A

UL CLASSIFIED

ANCE

MAS

NEC Article 92

Code 000921

CF105/300 EZ

CE

Cable Tray Label (as shown above) lists product information in accordance with NEMA VE-1, Section 6, which lists warning "DO NOT USE as a walkway ladder or support for personnel. Use only as a mechanical support for cables, tubing and raceways."

L'étiquette du chemin de câble (voir ci-dessus) fournit les informations produit conformément à l'article NEMA VE-1, Section 6, qui stipule l'avertissement suivant : "NE PAS UTILISER en tant que passerelle avec échelle ou chemin d'accès pour le personnel. Exclusivement réservé au support mécanique de câbles, de tuyauteries et de canalisations.

La etiqueta de la bandeja de cables (como se muestra más arriba) presenta información del producto de acuerdo con NEMA VE-1, sección 6, que indica la advertencia "NO USAR como pasillo, escalera o apoyo para el personal. Utilícela únicamente como apoyo mecánico para cables, tubos y conductos eléctricos."

INDEX

SOMMAIRE / ÍNDICE

INSTRUCTIONS / INSTRUCTIONS / INSTRUCCIONES

FINISHES FINITIONS / ACABADOS	4-5
HOW TO CUT CABLE TRAY COUPE D'UN CHEMIN DE CÂBLES / CÓMO CORTAR BANDEJAS PORTACABLES	6-7
HOW TO SPLICE CABLE TRAY JONCTION DE CHEMINS DE CÂBLES / CÓMO EMPALMAR BANDEJAS PORTACABLES	8-9
INSTALLATION EXAMPLES EXEMPLES D'INSTALLATIONS / EJEMPLOS DE INSTALACIÓN	10
T JUNCTIONS: RAD T 90 KIT JONCTIONS EN TÉ : KIT RAD T 90 / UNIONES EN T: JUEGO RAD T 90	11
T JUNCTIONS: RAD T 90 12 KIT JONCTIONS EN TÉ : KIT RAD T 90 12 / UNIONES EN T: JUEGO RAD T 90 12	12
T JUNCTIONS: EZ T 90 KIT JONCTIONS EN TÉ : EZ T 90 KIT / UNIONES EN T: JUEGO EZ T 90	13
90° BENDS: RAD T 90 KIT COUDE À 90° : KIT RAD T 90 / CODOS DE 90°: JUEGO RAD T 90	14
90° BENDS: EZ T 90 KIT COUDE À 90° : KIT EZ T 90 / CODOS DE 90°: JUEGO EZ T 90	15
Y JUNCTIONS JONCTIONS EN Y / UNIONES EN Y	16
90° JUNCTIONS JONCTIONS À 90° / UNIONES DE 90°	17
SWEEPS - SWK COURBES À GRAND RAYON - SWK / CURVAS - SWK	18
CABLOBEND CABLOBEND / CABLOBEND	19
PROPER USE OF FAS TABS - WIRE MESH TRAY PROPER USE OF FAS TABS / PROPER USE OF FAS TABS	19
HOW TO USE FS41 HOW TO USE FS41 / HOW TO USE FS41	19
INSERTS INSERTS / INSERTS	20
COVERS COVERS / COVERS	20
DIVIDERS (COT) DIVIDERS (COT) / DIVIDERS (COT)	20
REDUCTIONS RÉTRÉCISSEMENTS / REDUCCIONES	21
CHANGING LEVELS CHANGEMENT DE NIVEAU / CAMBIO DE NIVELES	21
BONDING AND GROUNDING MISE À LA TERRE / CONEXIONES A TIERRA	22
LOADING CHARGE / CARGA	23
SUPPORT SPACING ESPACEMENT DES SUPPORTS / DISTANCIA ENTRE SOPORTES	23-25

PRODUCTS / PRODUITS / PRODUCTOS

TRAY CHEMIN / BANDEJAS	26
TRAY COVERS COUVRE-CHEMINS / CUBIERTAS DE BANDEJAS	26
SPLICING JONCTION / EMPALMES	27
ACCESSORIES ACCESSOIRES / ACCESORIOS	27-28
WALL MOUNTINGS MONTAGES MURAUX / MONTAJES DE PARED	28-29
CEILING MOUNTINGS MONTAGES AU PLAFOND / MONTAJES DE TECHO	29-30
UNDER FLOOR MOUNTINGS MONTAGES SOUS PLANCHER / MONTAJES DE DEBAJO DEL PISO	30-31
OTHER MOUNTING AUTRE MONTAGE / OTROS MONTAJES	31-32

Pour plus de détails, visiter www.legrand.us/cablofil

Para obtener información adicional visite www.legrand.us/cablofil

FINISHES

FINITIONS / ACABADOS

Legrand/Cablofil wire cable tray and accessories are available in a variety of finishes to meet any industry need, from decorative to extreme environments. Use this chart to help you determine the best finish for your application and its availability.

Standard finish is EZ, electroplated zinc. (indoor applications) Stock finishes available include (EZ), electroplated zinc, (316L), 316 stainless steel, (GC), Hot dipped galvanized, (BL) Black powder coat paint.

Le chemin de câbles en treillis métallique et les accessoires Legrand/Cablofil sont disponibles dans diverses finitions pour répondre à tous les besoins de l'industrie en termes de décoration ou de conditions d'utilisation difficiles. Se reporter au tableau pour déterminer plus facilement la finition la mieux adaptée à l'application et sa disponibilité.

La finition standard est EZ, zinc argenté. (applications intérieures) Parmi les finitions courantes disponibles figurent (EZ) zinc argenté, (316L) acier inoxydable 316, (GC) galvanisée par immersion à chaud, (BL) peinture noire par poudrage électrostatique.

SYMBOL SYMBOLE SÍMBOLO	MATERIAL MATIÈRE MATERIAL	FINISH & STANDARD FINITION MATIÈRE ET NORME ACABADO DE MATERIAL Y ESTÁNDAR
PG	Carbon Steel Acier au carbone Acero al carbón ASTM A653	Pre-Galvanized / Pré-galvanisée / Pregalvanizado: Continuous Galvanization Before Fabrication Galvanisation continue avant fabrication Galvanización continua antes de la fabricación ASTM A 653
EZ	Carbon Steel Acier au carbone Acero al carbono ASTM A510 Grade / Nuance / Grado 1008	Electrozinc / Zingué par électrolyse / Electrozinc: Electrozinc plating Zingage par électrolyse Zinc electrodepositado ASTM B 633
GC	Carbon Steel Acier au carbone Acero al carbono Steel ASTM A510 Grade / Nuance / Grado 1008	Hot Dipped Galvanized / Galvanisée par immersion à chaud / Galvanizado en caliente: After Fabrication Après fabrication Después de la fabricación ASTM A 123
DC	Carbon Steel Acier au carbone Acero al carbon ASTM A510 Grade / Nuance / Grado 1008	Dacromet / Dacromet / Dacromet: Zinc and Aluminum Protection Equivalent to Hot Dip Galvanization Protection zinc et aluminium équivalente à la galvanisation par immersion à chaud Protección de zinc y aluminio equivalente a la galvanización e caliente ASTM F 1136
304L	Stainless Steel Acier inoxydable Acero inoxidable AISI Type / Type / Tipo 304L	Stainless Steel 304L / Acier inoxydable 304L / Acero inoxidable 304L: Cleaned and Passivated Nettoyé et passivé Limpio y pasivado ASTM A 380
316L	Stainless Steel Acier inoxydable Acero inoxidable AISI Type / Type / Tipo 316L	Stainless Steel 316L / Acier inoxydable 316L / Acero inoxidable 316L: Cleaned and Passivated Nettoyé et passivé Limpio y pasivado ASTM A 380
BL	Carbon Steel Acier au carbone Acero al carbono ASTM A510 Grade / Nuance / Grado 1008	Black Painted / Peinte en noir / Pintado de negro: Black Powder Coated Poudrage noir Pintura en polvo negra ASTM D 3451
PE	Carbon Steel Acier au carbone Acero la carbono ASTM A510 Grade / Nuance / Grado 1008	Custom Painted / Peinte spécialement / Pintura especial: Custom Color Powder Coated Poudrage couleur spéciale Pintura en polvo de color especial ASTM D 3451

● **recommended**
recommandée
recomendado

● **possible**
possible
posible

Se dispone de bandejas portacables de alambre y accesorios Legrand/ Cablofil en una variedad de acabados para cumplir con cualquier necesidad de la industria, desde entornos decorativos a extremos. Use esta tabla para ayudar a determinar el mejor acabado para su aplicación y disponibilidad.

El acabado estándar es EZ, zinc electrodepositado. (aplicaciones interiores)
Entre los acabados disponibles se incluyen (EZ), zinc electrodepositado, (316L), acero inoxidable 316, (GC), galvanizado en caliente, (BL) pintura en polvo negra.

	Interior installations Installations intérieures Instalaciones interiores	Exterior installations Installations extérieures Instalaciones exteriores	Petroleum Plants, Chemical Plants Industrie pétrolière Industrie chimique Refinerías de petróleo Plantas químicas	Marine/salt, Weak sulphurous environments Entornos marinos/salados, sulfurosos débiles	Acidic, alkaline environments Environnements acides, alcalins Entornos ácidos, alcalinos	Food Production, Wash-down, Clean rooms Production alimentaire, Lavage à grande eau, Salles blanches Producción de alimentos, lavado, salas de limpieza	Halogen environments Environnements halogénés Entornos de halógeno
	●						
	●						
		●	●	●	●		
		●	●	●	●		
		●	●	●	●	●	●
		●	●	●	●	●	●
	●						
	●						

For a more detailed explanation of finish standards and compatibility, visit www.legrand.us/cablofil.

Pour une explication plus détaillée des normes et de la compatibilité des finitions, visiter www.legrand.us/cablofil.

Para obtener una explicación detallada de las normas y compatibilidad de acabado, visite www.legrand.us/cablofil.

Pour plus de détails, visiter www.legrand.us/cablofil

Para obtener información adicional visite www.legrand.us/cablofil

HOW TO CUT CABLOFIL CABLE TRAY

COUPE D'UN CHEMIN DE CÂBLES CABLOFIL

CÓMO CORTAR BANDEJAS PORTACABLES CABLOFIL

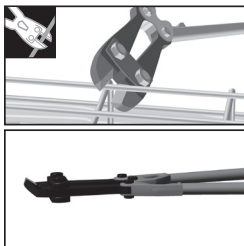

	LENGTH LONGUEUR LONGITUD	WEIGHT POIDS PESO			
	INCHES POUCES PULGADAS	MM	LBS	KG/1	
COUPFIL	24.8"	630	9.5	4.3	559 507

- Always use side action bolt cutters.
- Angle all cuts away from the new end.
- Cut each wire with one clean cut – eliminating any grinding or touch-up.
- Toujours utiliser des coupe-boulons de côté.
- Effectuer toutes les coupes en biais par rapport à la nouvelle extrémité.
- Couper chaque tige du treillis en effectuant une seule coupe nette pour éliminer tout meulage ou retouche.
- Use siempre cortapernos de acción lateral.
- Haga todos los cortes alejándose del nuevo extremo.
- Corte cada alambre haciendo un corte limpio, eliminando rectificaciones o retoques.

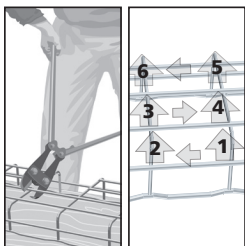
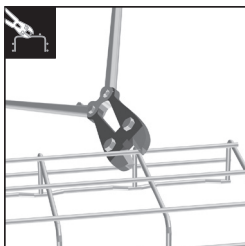

- Cut the bottom wires first, in order as shown, from the underside of the tray.
- Rest the lower jaw of the cutters against the cradle wire and cut at an angle away from the new end.
- Couper d'abord les tiges inférieures, dans l'ordre indiqué, du dessous du chemin.
- Faire reposer la lame inférieure du coupe-boulon contre la tige berceau et couper en biais par rapport à la nouvelle extrémité.
- Corte primero los alambres inferiores, en orden según se muestra, desde el lado de abajo de la bandeja.
- Apoye la mordaza inferior de los cortadores contra el alambre del asiento y corte en ángulo alejándose del nuevo extremo.

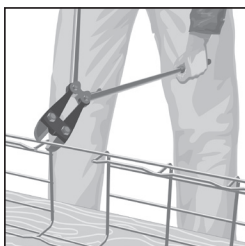
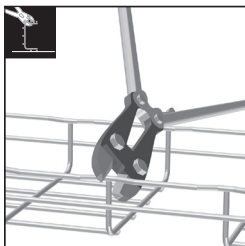

- Cut the side wires next, starting with the top wire.
- Make sure the finished cut is safe and ready for installation.
- Couper ensuite les tiges latérales en commençant par la tige supérieure.
- Veiller à ce que la coupe finie soit sûre et prête à l'installation.
- Corte a continuación los alambres laterales, empezando por el alambre superior.
- Asegúrese de que el corte acabado sea seguro y esté listo para su instalación.



INSTALLATION
VIDEO

USING A POWER CUTTER TO CUT CABLOFIL - CABLOCUT

UN OUTIL ÉLECTRIQUE CONÇU POUR COUPER LES CHEMINS DE CÂBLES CABLOFIL : CABLOCUT
 EMPLEO DE CORTADORA ELÉCTRICA PARA CORTAR CABLOFIL — CABLOCUT

Cablocut reduces jobsite labor and results in a better, safer cut. Use cutting instructions from page 6 to properly cut Cablofil tray.

Cablocut réduit la charge de travail sur le chantier et produit une coupe plus nette et plus sécuritaire. Observer les instructions de coupe à la page 6 afin de couper correctement les chemins de câbles Cablofil.

Cablocut reduce las horas de mano de obra y produce mejores cortes y más seguros. Utilice las instrucciones de corte de la página 6 para cortar debidamente su portacables Cablofil.

- Small head size permits cuts close to welds
- 300 cuts between charges
- Cuts steel or stainless wire mesh tray up to 6mm in diameter
- Multifunction illumination/battery charge indicator LED
- Uses Makita 18 V/1.5 Ah Lithium-ion battery

- Tête de petite dimension qui permet de couper près des soudures
- Autonomie de 300 coupes entre les charges
- Coupe les chemins de câbles en fils d'acier ou d'acier inoxydable allant jusqu'à 6 mm de diamètre
- Lampe multifonction/indicateur de charge de la batterie à DEL
- Alimenté par une batterie Makita au lithium-ion de 18 V/1,5 Ah

- *El pequeño tamaño de la cabeza permite cortar cerca de las soldaduras*
- *300 cortes entre cargas*
- *Corta portacables de mallas de acero o acero inoxidable de hasta 6 mm de diámetro*
- *LED de iluminación de funciones múltiples/indicador de carga de batería*
- *Usa una batería de iones de litio Makita de 18 V/1.5 Ah*



	ITEM ARTICLE ARTÍCULO	DESCRIPTION DESCRIPTION DESCRIPCIÓN
945064	Cablocut* C cablocut* Cablocut*	Cutter, Case, Spare Blades Coupe-fit, coffre, lame supplémentaire Cortador, estuche, hojas de repuesto
945065	Cablocut Blades Lames Cablocut Hojas Cablocut	Spare Blades Lame supplémentaire Hojas de repuesto
945066	Cablocut Battery* Batterie Cablocut* Batería Cablocut*	18 V Li-Ion Battery 1.5/A/HR Batterie au lithium-ion de 18 V/1,5 Ah Batería de iones de litio de 18 V/1.5 AH
945067	Cablocut Charger* Chargeur Cablocut* Cargador Cablocut*	120 VAC Quick Charger Chargeur rapide de 120 VCA Cargador rápido de 120 VCA

*Battery and Charger sold and shipped separately.

*Batterie et chargeur vendus et expédiés séparément.

*La batería y el cargador se venden y envían por separado.

SHEARING ACTION RESULTS IN CLEAN EDGE

PRODUIT UN CISAILLAGE QUI DONNE DES COUPES NETTES

LA ACCIÓN DE CIZALLADURA PRODUCE UN BORDE LIMPIO

CABLOCUT RESULTS

CABLOCUT
RÉSULTATS

CABLOCUT
RESULTADOS

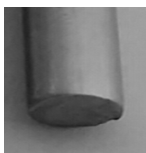

OLD TOOLS, ELECTRIC OR MANUAL

ANCIENS OUTILS,
ÉLECTRIQUES OU MANUELS

HERRAMIENTAS MÁS VIEJAS,
ELÉCTRICAS O MANUALES

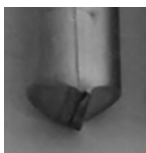

ACCESSORIES



CASE KK50L
COFFRE KK50L
ESTUCHE KK50L



RAL1 BATTERY*
BATTERIE RAL1
BATERÍA RAL1
18 V / 1.5 AH / LI-ION





CHARGER LGL1*
CHARGEUR LGL1
CARGADOR LGL1
20V QUICK CHARGER

HOW TO SPLICE CABLOFIL CABLE TRAY - EDRN

JONCTION DE CHEMIN DE CÂBLES CABLOFIL - EDRN

CÓMO EMPALMAR BANDEJAS PORTACABLES CABLOFIL - EDRN

SPLICING GUIDELINES / CONSIGNES DE JONCTION / GUÍAS DE EMPALME

CF30 - CF54 CF105 - CF150	2" → 8" (50 mm)	12" (300 mm)	18" → 24" (450 → 600 mm)
 <p>EDRN splices needed on side wires Jonctions EDRN nécessaires sur les fils de treillis latéraux Se necesitan empalmes EDRN en alambres laterales</p>	2x EDRN	2x EDRN	2x EDRN
 <p>EDRN splices needed on bottom of tray Jonctions EDRN nécessaires sur le bas du chemin Se necesitan empalmes EDRN en la parte inferior de la bandeja</p>	-	1x EDRN	2x EDRN

INSTRUCTIONS / INSTRUCTIONS / INSTRUCCIONES

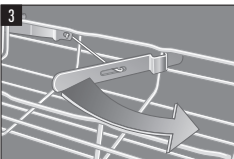
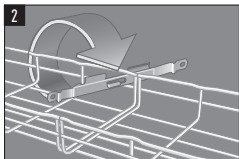
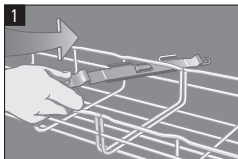

Always place splicing between top two siderail wires as shown



INSTALLATION VIDEO

HOW TO SPLICE CABLOFIL CABLE TRAY - SWK

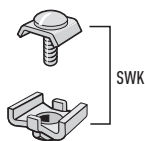
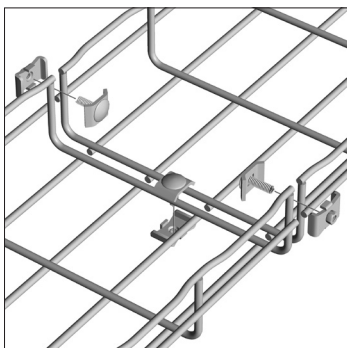

JONCTION DE CHEMIN DE CÂBLES CABLOFIL - SWK

CÓMO EMPALMAR BANDEJAS PORTACABLES CABLOFIL - SWK



INSTALLATION VIDEO

- Use SWK to splice any two sections of Cablofil tray between the top two siderail wires as shown.
- Swaged nut allows clamp to be stationary while nut is tightened.
- Consult chart below for correct number of SWK sets needed for each width of tray.
- Utiliser un SWK pour joindre deux sections quelconques de chemin Cablofil.
- L'écrou estampé permet à la bride de rester immobile pendant le serrage de l'écrou.
- Consulter le tableau ci-dessous pour le nombre correct d'ensembles SWK nécessaires pour chaque largeur de chemin.
- Use SWK para empalmar dos secciones cualquiera de bandejas Cablofil.
- La tuerca recalada permite que la abrazadera permanezca fija mientras se aprieta la tuerca.
- Consulte en el cuadro de abajo el número correcto de conjuntos SWK necesarios para cada ancho de bandeja.

CF30 - CF54 CF105 - CF150	2" (50 mm)	4" → 8" (100 → 200 mm)	12" → 24" (300 → 600 mm)
 <p>SWK attachment sets needed for side wires Ensembles de fixation SWK nécessaires pour les fils de treillis latéraux Conjuntos de sujeción SWK necesarios para los alambres laterales</p>	2x SWK	2x SWK	2x SWK
 <p>SWK attachment sets needed for bottom wires Ensembles de fixation SWK nécessaires pour le fil de treillis inférieur Conjuntos de sujeción SWK necesarios para los alambres inferiores</p>	-	1x SWK	2x SWK

DIRECTIONAL CHANGE HARDWARE

MATÉRIEL POUR DÉVIATIONS

TORNILLERÍA DE CAMBIOS DIRECCIONALES

90 DEGREE BENDS / COUDES À 90° / CODOS DE 90°

TRAY WIDTH LARGEUR CHEMIN ANCHO DE LA BANDEJA	SWK (SWEEP) (COURBE GRAND RAYON) (CURVA)		RAD T 90 RADT9012		EZ T 90	
	QTY. REQUIRED QTÉ. NÉCESSAIRE CANT. REQUERIDA	CUT INSTRUT. INSTRUCT. COUPE INSTRUCT. CORTE	QTY. REQUIRED QTÉ. NÉCESSAIRE CANT. REQUERIDA	CUT INSTRUT. INSTRUCT. COUPE INSTRUCT. CORTE	QTY. REQUIRED QTÉ. NÉCESSAIRE CANT. REQUERIDA	CUT INSTRUT. INSTRUCT. COUPE INSTRUCT. CORTE
2"	2	p. 18	-	-	1 kit	p. 15
4"	2	p. 18	1 kit	p. 14	1 kit	p. 15
6"	4	p. 18	1 kit	p. 14	1 kit	p. 15
8"	4	p. 18	1 kit	p. 14	1 kit	p. 15
12"	6	p. 18	1 kit	p. 14	1 kit	p. 15
18"	8	p. 18	1 kit	p. 14	1 kit	p. 15
20"	9	p. 18	1 kit	p. 14	1 kit	p. 15
24"	11	p. 18	1 kit	p. 14	1 kit	p. 15

HORIZONTAL TEE / TÉ HORIZONTAL / TE HORIZONTAL

TRAY WIDTH LARGEUR CHEMIN ANCHO DE LA BANDEJA	RAD T 90 / RAD T 90 12		EZ T 90		Y JUNCTION JONCTIONS EN Y UNIÓN EN Y	
	QTY. REQUIRED QTÉ. NÉCESSAIRE CANT. REQUERIDA	CUT INSTRUT. INSTRUCT. COUPE INSTRUCT. CORTE	QTY. REQUIRED QTÉ. NÉCESSAIRE CANT. REQUERIDA	CUT INSTRUT. INSTRUCT. COUPE INSTRUCT. CORTE	QTY. REQUIRED QTÉ. NÉCESSAIRE CANT. REQUERIDA	CUT INSTRUT. INSTRUCT. COUPE INSTRUCT. CORTE
2"	-	-	1 kit	p. 13	-	-
4"	1 kit	p. 11 / p. 12	1 kit	p. 13	p. 16	p. 16
6"	1 kit	p. 11 / p. 12	1 kit	p. 13	p. 16	p. 16
8"	1 kit	p. 11 / p. 12	1 kit	p. 13	p. 16	p. 16
12"	1 kit	p. 11 / p. 12	1 kit	p. 13	p. 16	p. 16
18"	1 kit	p. 11 / p. 12	1 kit	p. 13	p. 16	p. 16
20"	1 kit	p. 11 / p. 12	1 kit	p. 13	-	-
24"	1 kit	p. 11 / p. 12	1 kit	p. 13	-	-



INSTALLATION
VIDEO

INSTALLATION EXAMPLES

EXEMPLES D'INSTALLATIONS / EJEMPLOS DE INSTALACIÓN



EXTERIOR INSTALLATION

INSTALLATION EXTÉRIEURE

INSTALACIÓN EXTERIOR

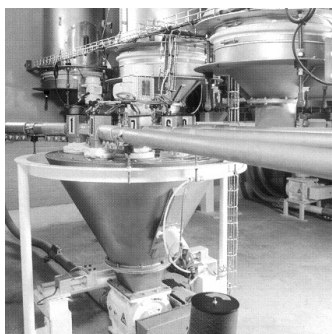

FOOD PROCESSING

TRAITEMENT DES ALIMENTS

*PROCESAMIENTO DE
ALIMENTOS*



UNDERFLOOR INSTALLATION

INSTALLATION SOUS
PLANCHER

*INSTALACIÓN DEBAJO
DE PISOS*



INTERIOR INSTALLATION

INSTALLATION INTÉRIEURE

INSTALACIÓN INTERIOR



INDUSTRIAL PLANT

USINE

PLANTA INDUSTRIAL

T JUNCTIONS: RAD T 90 KIT

JONCTIONS EN TÉ : KIT RAD T 90 / UNIONES EN T: JUEGO RAD T 90

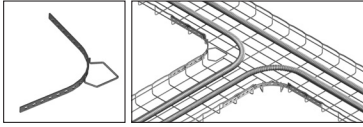

One RAD T 90 KIT will make one T Junction.

Un seul kit RAD T 90 permet d'effectuer une jonction en té.

Un JUEGO EZ T 90 formará una unión en T.

4" (100 mm)

1

2

x2

6" (150 mm)

1

2

x2

8" (200 mm)

1

2

x2

12" (300 mm)

1

2

x2

18-20" (450-500 mm)

1

2

x2

24" (600 mm)

1

2

x2



INSTALLATION VIDEO

T JUNCTIONS: RAD T 90 12 KIT

JONCTIONS EN TÉ : KIT RAD T 90 12 / UNIONES EN T: JUEGO RAD T 90 12

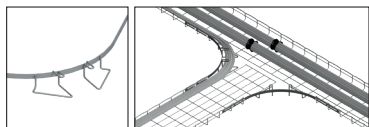

One RAD T 90 12 KIT will make one T Junction.

Un seul kit RAD T 90 12 permet d'effectuer une jonction en té.

Un JUEGO EZ T 90 12 formará una unión en T.

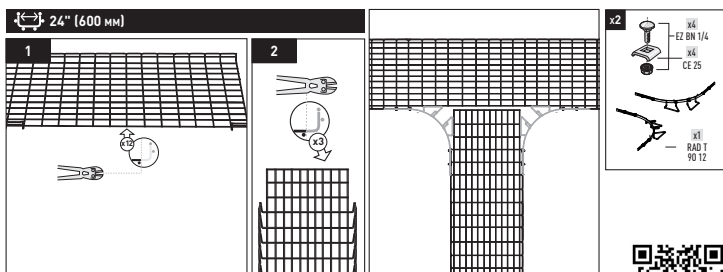
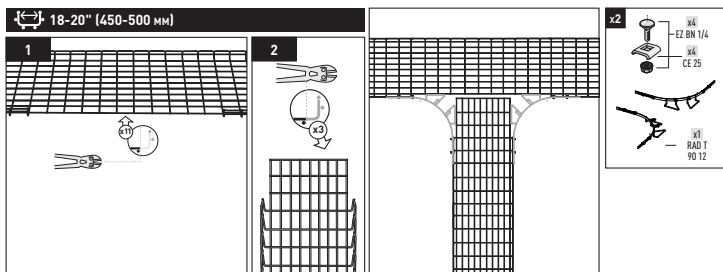
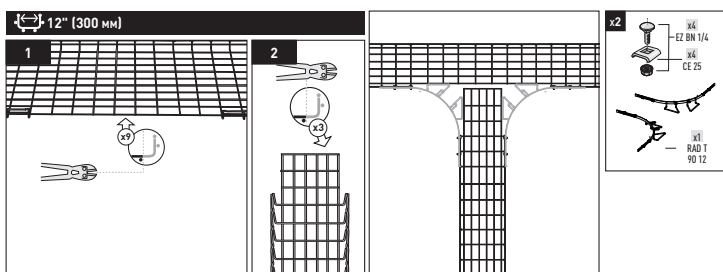
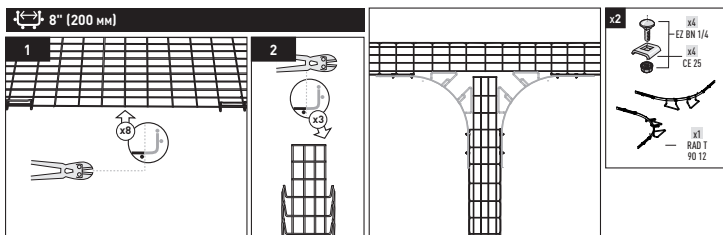
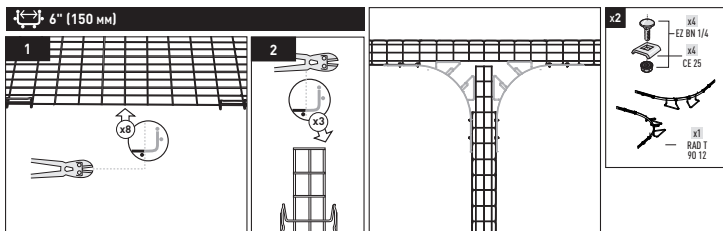
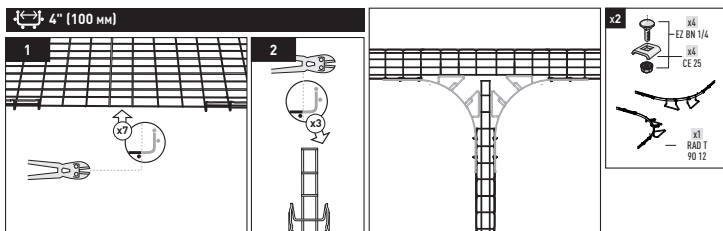

INSTALLATION
VIDEO

T JUNCTIONS: EZ T 90 KIT

JONCTIONS EN TÉ : KIT EZ T 90 / UNIONES EN T: JUEGO EZ T 90

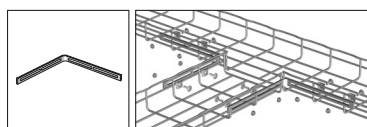

One EZ T 90 KIT will make one T Junction.

Un seul kit EZ T 90 permet d'effectuer une jonction en té.

Un JUEGO EZ T 90 formará una unión en T.

<p>2" (50 MM)</p>		<p>x2</p> <ul style="list-style-type: none"> x4 EZ BN 1/4 x4 CE 25 x1 EZ T 90
<p>4" (100 MM)</p>		<p>x2</p> <ul style="list-style-type: none"> x4 EZ BN 1/4 x4 CE 25 x1 EZ T 90
<p>6" (150 MM)</p>		<p>x2</p> <ul style="list-style-type: none"> x4 EZ BN 1/4 x4 CE 25 x1 EZ T 90
<p>8" (200 MM)</p>		<p>x2</p> <ul style="list-style-type: none"> x4 EZ BN 1/4 x4 CE 25 x1 EZ T 90
<p>12" (300 MM)</p>		<p>x2</p> <ul style="list-style-type: none"> x4 EZ BN 1/4 x4 CE 25 x1 EZ T 90
<p>18-20" (450-500 MM)</p>		<p>x2</p> <ul style="list-style-type: none"> x4 EZ BN 1/4 x4 CE 25 x1 EZ T 90
<p>24" (600 MM)</p>		<p>x2</p> <ul style="list-style-type: none"> x4 EZ BN 1/4 x4 CE 25 x1 EZ T 90



INSTALLATION VIDEO

90° BENDS: RAD T 90 KIT

COUDES À 90° : KIT RAD T 90 / CODOS DE 90°: JUEGO RAD T 90



INSTALLATION VIDEO

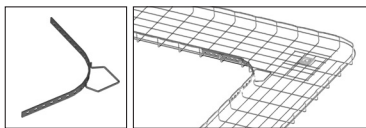

One RAD T 90 KIT will make two 90° Bends.

Un seul kit RAD T 90 permet d'effectuer deux coudes à 90°.

One RAD T 90 KIT formará dos codos de 90°.

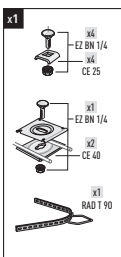
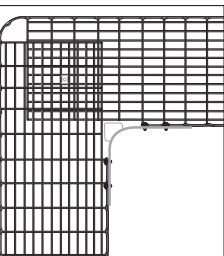
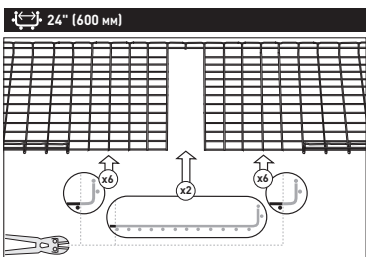
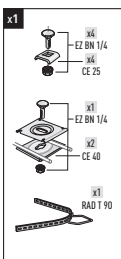
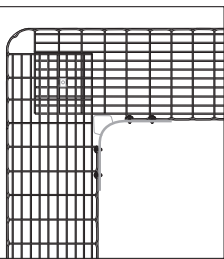
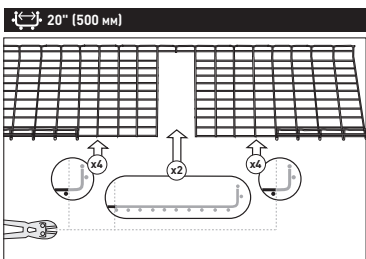
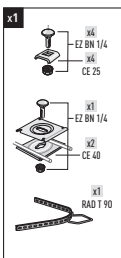
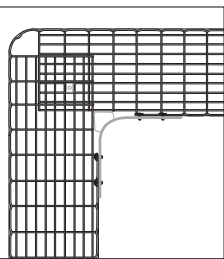
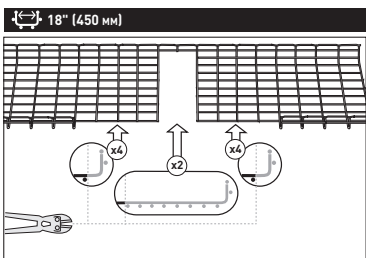
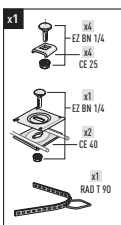
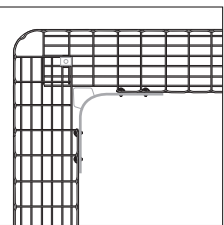
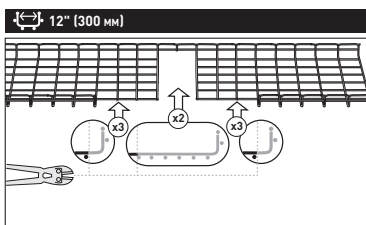
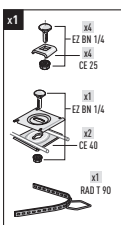
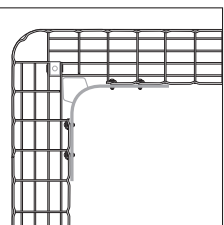
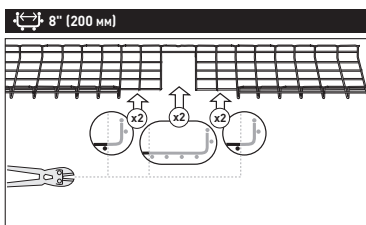
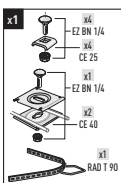
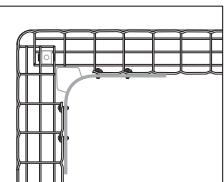
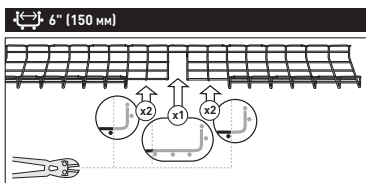
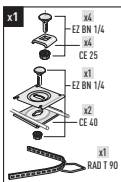
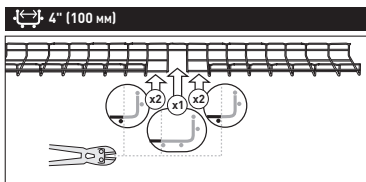

90° BENDS: EZ T 90 KIT

COUDES À 90° : KIT EZ T 90 / CODOS DE 90°: JUEGO EZ T 90

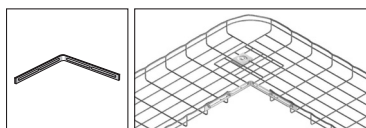

One EZ T 90 KIT will make two 90° Bends.

Un seul KIT EZ T 90 permet d'effectuer deux coudes à 90°.

Un JUEGO EZ T 90 formará dos codos de 90°.

<p>2" (50 MM)</p>		<p>x1 EZ T 90</p> <p>x4 EZ BN 1/4</p> <p>x4 CE 25</p>
<p>4" (100 MM)</p>		<p>x1 EZ T 90</p> <p>x4 EZ BN 1/4</p> <p>x4 CE 25</p> <p>x1 EZ BN 1/4</p> <p>x2 CE 40</p>
<p>6" (150 MM)</p>		<p>x1 EZ T 90</p> <p>x4 EZ BN 1/4</p> <p>x4 CE 25</p> <p>x1 EZ BN 1/4</p> <p>x2 CE 40</p>
<p>8" (200 MM)</p>		<p>x1 EZ T 90</p> <p>x4 EZ BN 1/4</p> <p>x4 CE 25</p> <p>x1 EZ BN 1/4</p> <p>x2 CE 40</p>
<p>12" (300 MM)</p>		<p>x1 EZ T 90</p> <p>x4 EZ BN 1/4</p> <p>x4 CE 25</p> <p>x1 EZ BN 1/4</p> <p>x2 CE 40</p>
<p>18" (450 MM)</p>		<p>x1 EZ T 90</p> <p>x4 EZ BN 1/4</p> <p>x4 CE 25</p> <p>x1 EZ BN 1/4</p> <p>x2 CE 40</p>
<p>20" (500 MM)</p>		<p>x1 EZ T 90</p> <p>x4 EZ BN 1/4</p> <p>x4 CE 25</p> <p>x1 EZ BN 1/4</p> <p>x2 CE 40</p>
<p>24" (600 MM)</p>		<p>x1 EZ T 90</p> <p>x4 EZ BN 1/4</p> <p>x4 CE 25</p> <p>x1 EZ BN 1/4</p> <p>x2 CE 40</p>

Pour plus de détails, visiter www.legrand.us/cablofil

Para obtener información adicional visite www.legrand.us/cablofil

Y JUNCTIONS

JONCTIONS EN Y / UNIONES EN Y

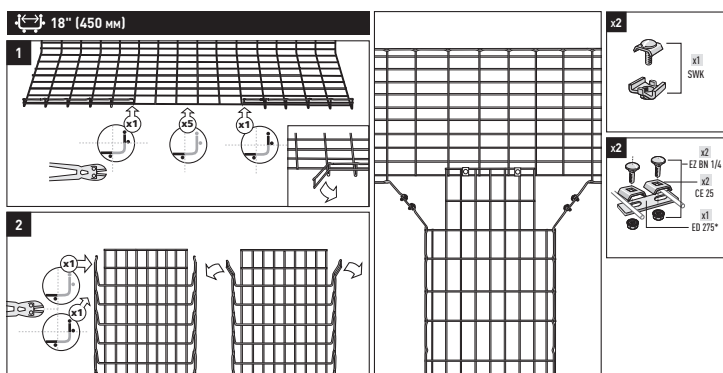
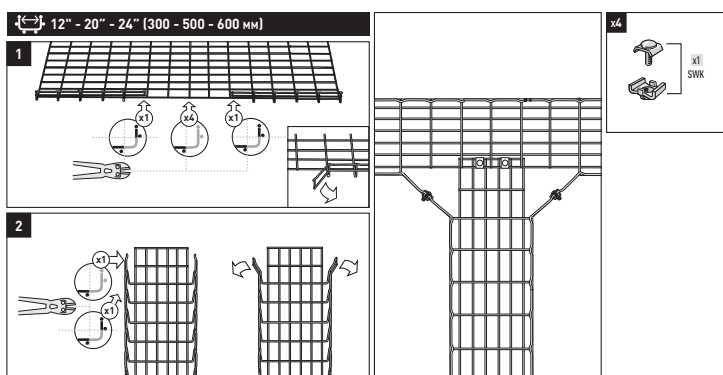
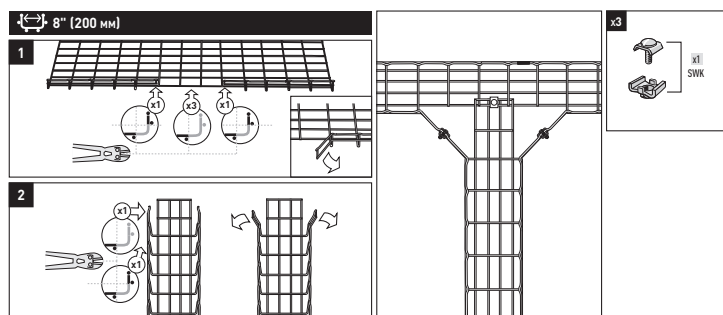
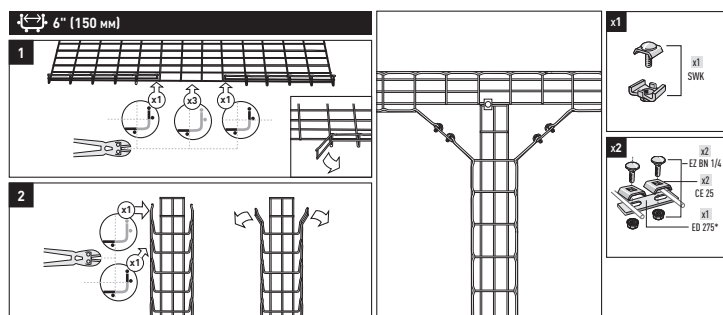
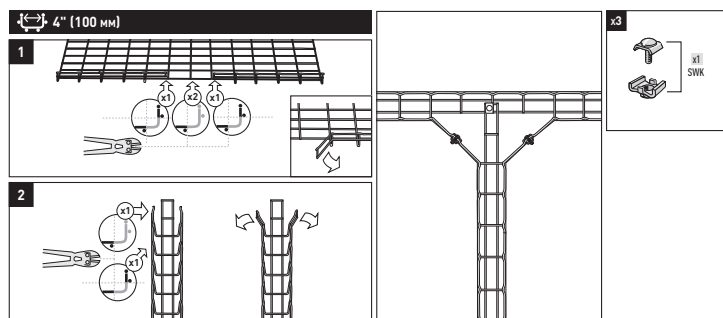

*Use bolt cutters to fabricate this part from ED 275.

*Utiliser un coupe-boulon pour fabriquer cette pièce à partir d'un ED 275.

*Use bolt cutters to fabricate this part from ED 275.

90° JUNCTIONS

JONCTIONS À ANGLE DROIT / UNIONES DE 90°

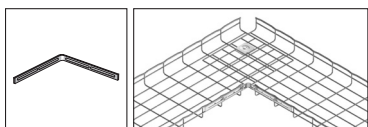

One EZ T 90 KIT will make two 90° Junctions.

Un seul KIT EZ T 90 permet d'effectuer deux jonctions à angle droit.

Un JUEGO EZ T 90 formará dos uniones de 90°.

4" (100 MM)	6" (150 MM)	8" (200 MM)	12" (300 MM)	18" (450 MM)	20" (500 MM)	24" (600 MM)

OTHER THAN 90° JUNCTIONS

JONCTIONS AUTRES QU'À ANGLE DROIT / OTRAS UNIONES QUE NO SEAN DE 90°



Pour plus de détails, visiter www.legrand.us/cablofil

Para obtener información adicional visite www.legrand.us/cablofil

SWEEPS: SWK & EZ BN 1/4 / CE25 / ED275

COURBES À GRAND RAYON : SWK ET EZ BN 1/4/CE25/ED275 / CURVAS: SWK Y EZ BN 1/4/CE25/ED275

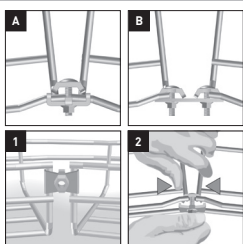

Sweeps can be formed easily on site by cutting some of the side and bottom wires. Use the SWK method to secure desired curve. Always place bolt heads to inside of tray to prevent frayed wires.

Il est possible de former aisément des courbes à grand rayon sur place en coupant certains des fils de treillis latéraux et inférieurs. Utiliser la méthode SWK pour obtenir la courbe souhaitée. Toujours placer la tête des boulons à l'intérieur du chemin pour empêcher un éraillage des fils de treillis.

Las curvas pueden formarse fácilmente en la obra cortando algunos de los alambres laterales e inferiores. Use el método SWK para asegurar la curva deseada. Coloque siempre las cabezas de los pernos en el interior de la bandeja para impedir que se desgasten los alambres.

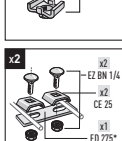
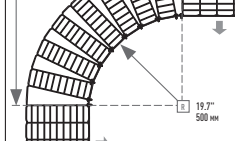
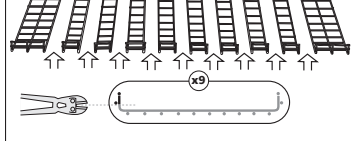
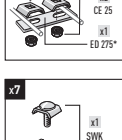
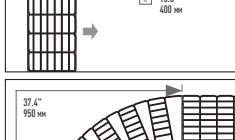
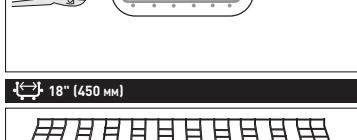
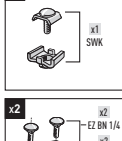
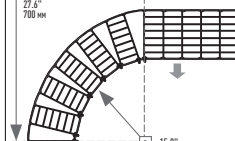
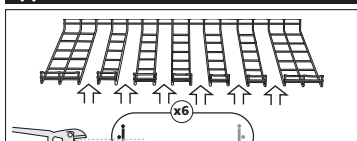
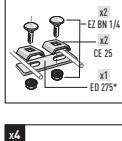
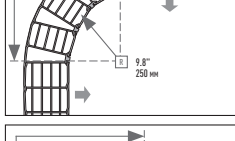
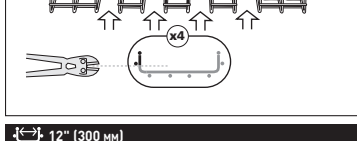
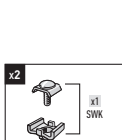
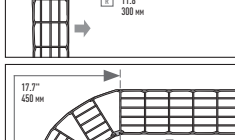
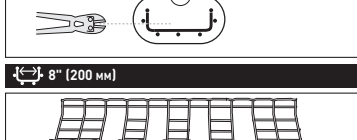
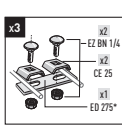
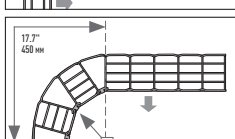
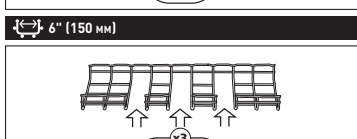
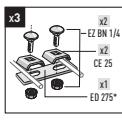
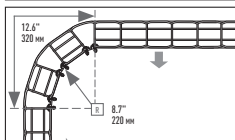
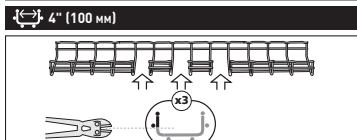
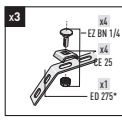
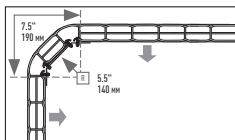
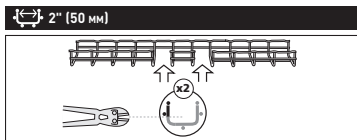

*Use bolt cutters to cut to fit.

*Utiliser des coupe-boulons pour couper de façon à ajuster.

*Use los cortapernos para cortar a la medida.

CABLOBEND

CABLOBEND / CABLOBEND

Making a Horizontal 90 Bend:

1. Evaluate the below diagram and chart to determine which provides the best fit
2. Modify the Cablobend by bending individual sections for best fit
3. Lock in unbent sections with bend clips to improve fitting rigidity
4. Splice Cablobend to adjacent tray straight sections with UL listed SWKs



HORIZONTAL BEND 90 DEGREE (TIGHT AS POSSIBLE)				
Tray Width	No. of Sections	≈ Radius (I)	≈ Radius (O)	Angle
6"	4	6"	12"	90°
8"	4	7"	15"	90°
12"	5	11"	23"	90°
18"	6	3"	28"	90°
24"	8	20"	44"	90°

Larger radius and smaller siderail tray gaps can easily be developed using more bend segments than shown above.

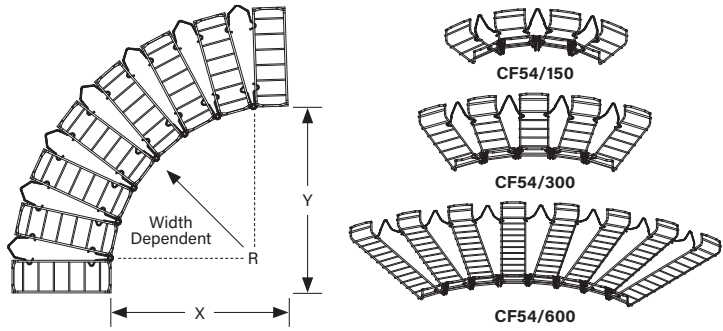

With Cablobend, you have the freedom to flexibly create the bends and drops that you need. No more cutting to make most bends.

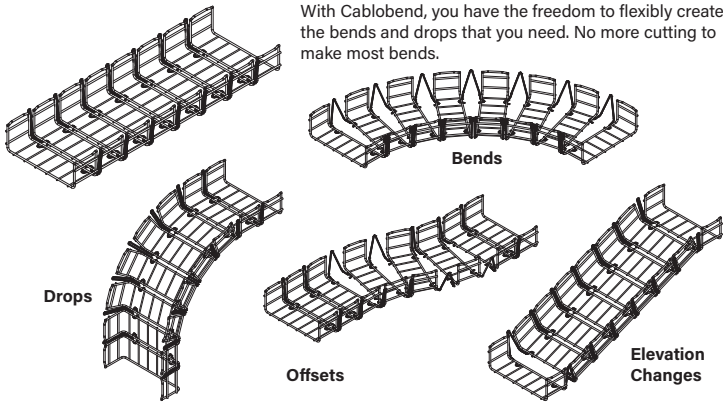

PROPER USE OF FAS TABS - WIRE MESH TRAY

PROPER USE OF FAS TABS / PROPER USE OF FAS TABS

FAS tabs speed up installation times and because no additional attachment hardware is required, they also reduce costs. Follow these steps for proper installation:

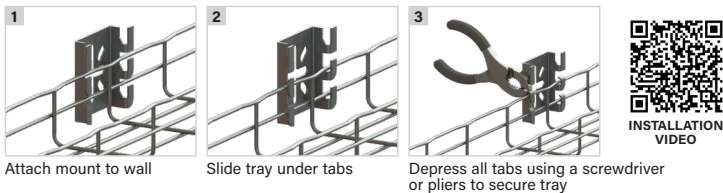
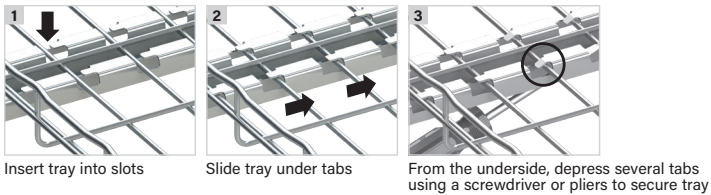

HOW TO USE FS41 / HOW TO USE FS41 / HOW TO USE FS41

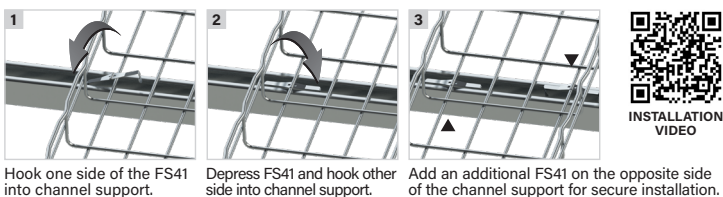

Pour plus de détails, visiter www.legrand.us/cablofil

Para obtener información adicional visite www.legrand.us/cablofil

INSERTS

INSERTS / INSERTS

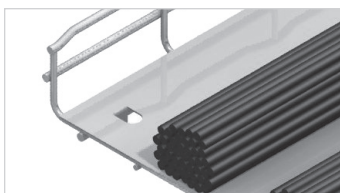
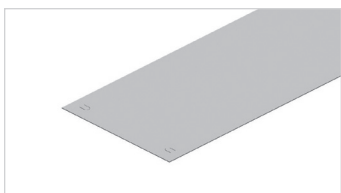

Insert designed to fit between bottom splice points. Some gaps may occur.

COVERS

COVERS / COVERS

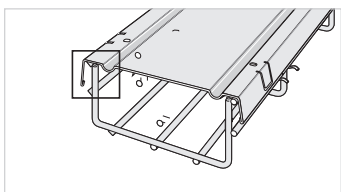

- Use built-in tabs for permanent attachment to tray.
- Use CLIP F02 for installations where cover (CVN) is removed frequently.



INSTALLATION VIDEO

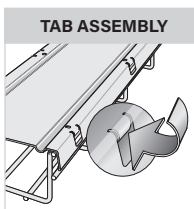

TAB ASSEMBLY

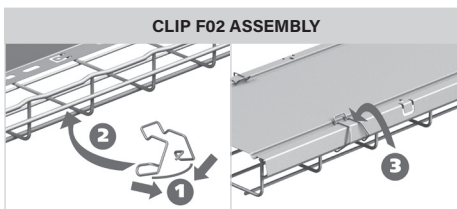

CLIP F02 ASSEMBLY

DIVIDERS (COT)

DIVIDERS (COT) / DIVIDERS (COT)

COT 54/COT 105 MOUNTING

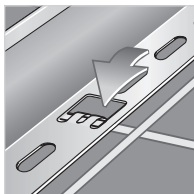

COT 150 MOUNTING

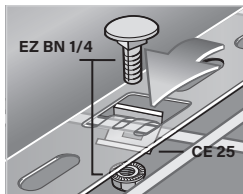

COT J



- For cable separation within a single tray.
- Field fabricate with tin snips for changes in levels.
- COT54: Attach to tray with fold-over tabs.
- COT105: Attach to tray with fold-over tabs or with included hardware
- COT 150 Requires EZ BN 1/4 and CE 25 to attach to tray (included).
- COT 150 does not have tabs.
- COT J improves electrical continuity and strengthens dividers.
- COT J can be removed with a screwdriver and is reusable.



INSTALLATION VIDEO

REDUCTIONS RÉTRÉCISSEMENTS / REDUCCIONES



INSTALLATION VIDEO

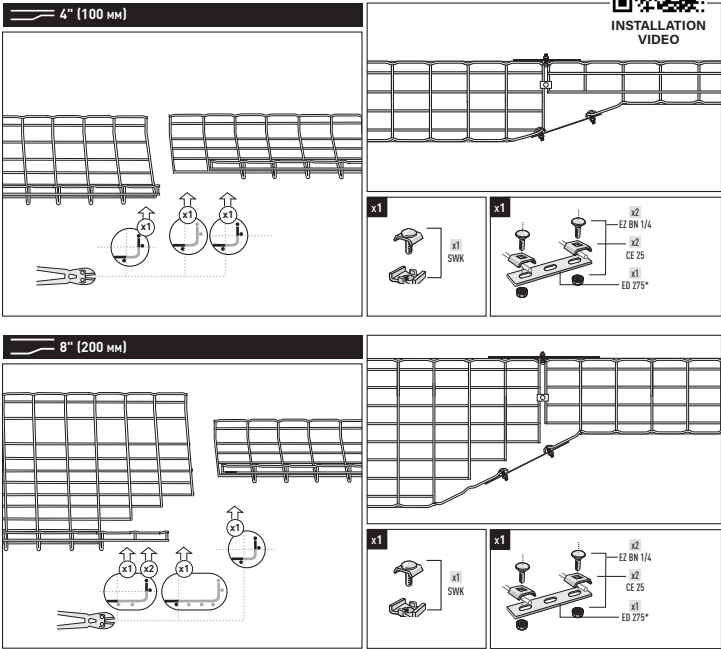

CHANGING LEVELS CHANGEMENT DE NIVEAU / CAMBIO DE NIVELES

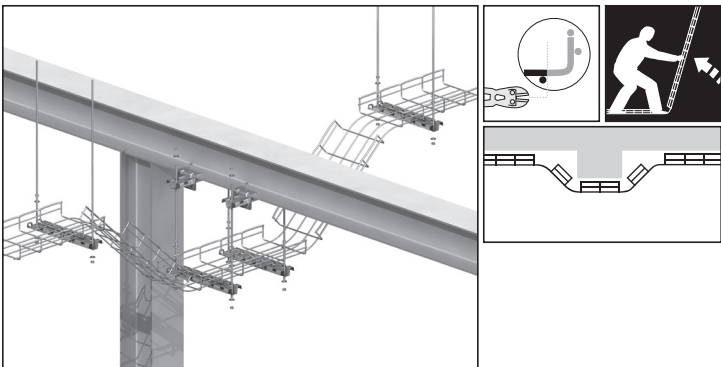

To avoid obstructions or change levels, cut the side wires as shown and bend Cablofil cable tray to the angles needed.

Pour éviter les obstacles ou changer de niveau, couper les fils de treillis latéraux comme indiqué et recourber le chemin de câbles Cablofil aux angles nécessaires.

Para evitar obstrucciones o cambiar de nivel, corte los alambres laterales según se muestra y doble la bandeja portacables Cablofil a los ángulos necesarios.



INSTALLATION VIDEO

CUTTING AND BENDING COUPE ET CINTRAGE / CORTES Y DOBLADOS

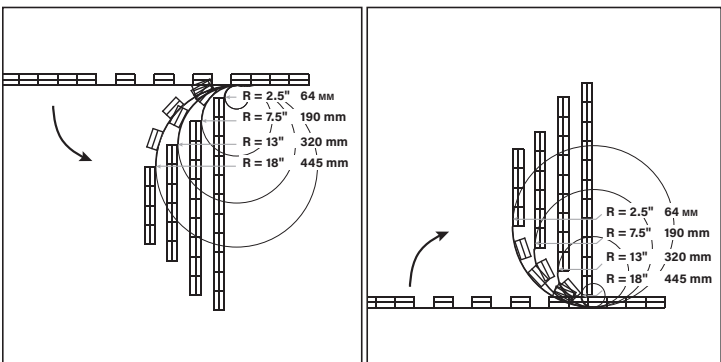



Per NEC 392, the national electrical code section for cable tray, all cable tray systems must be properly BONDED, per section 259.96. To meet this requirement, Cablofil recommends that ULclassified splices are used to joins sections and that the cable tray be bonded to building steel or the facility grounding system every 50'-60'. By bonding the tray every 50'-60', the tray will maintain a low potential to ground which reduces EMI and provides a continuous path for stray currents. Steel trapeze type hangers clamped securely to building steel usually provide a solid bond. Cablofil standard splices (SWK, EDRN, EZBN, EZT90, RADT90) are designed to have less than 1 milliohm of resistance between connections and provide bonding between sections. These splices have been tested by UL as part of the cable tray grounding system. Painted Cablofil wire mesh tray requires the outer mask of the conductive surface be removed at each end of the tray prior to installing the (SWK) splice. This (SWK) splice provides a UL Classified Bonding continuity between painted tray sections. All cable tray needs to be electrically continuous per NEC 250.96. Standard Cablofil splices provide continuity per 250.96. Cutting and removal of cable tray sections still allow continuity per 250.96 and only affects the rare use of cable tray as the EGC. Use of cable tray as an EGC is rare since UL requires all multiconductor cables to contain an integral EGC and single conductor cables are only used in a few industrial applications.

Conformément à la spécification NEC 392, la section du Code national de l'électricité qui traite des chemins de câbles, tous ceux-ci doivent être correctement MIS À LA TERRE comme indiqué dans la section 259.96. Afin de respecter cette spécification, Cablofil recommande d'utiliser des jonctions agréées UL pour joindre des sections et de mettre le chemin de câbles à la terre en le reliant à l'armature métallique du bâtiment ou à l'installation de mise à la terre des locaux tous les 15 à 18 m (50 à 60 pi). Si on procède ainsi, le chemin maintient un faible potentiel à la terre qui réduit la perturbation électromagnétique et offre une voie continue aux courants vagabonds. Des tirants en acier de type trapézoïdal fixés solidement à l'armature en acier du bâtiment assurent généralement une mise à la terre sûre. Les jonctions standard de Cablofil (SWK, EDRN, EZBN, EZT90, RADT90) sont conçues pour avoir une résistance inférieure à 1 milliohm entre connexions et assurent une liaison électrique entre les sections. Ces jonctions ont été testées par les UL en tant qu'éléments de l'installation de mise à la terre du chemin de câbles. Les chemins de câbles en treillis métallique peints de Cablofil exigent la dépose du masque extérieur de la surface conductrice à chaque extrémité du chemin avant la mise en place de la jonction (SWK). Cette jonction (SWK) assure une continuité de masse agréée par les UL entre les sections d'un chemin peint. Tous les chemins de câbles doivent assurer une continuité électrique conformément à la spécification NEC 250.96. Les jonctions standard Cablofil assurent une telle continuité. La coupe et le retrait de sections de chemin de câble n'éliminent pas la continuité exigée par la spécification 250.96 et n'affectent que la rare utilisation d'un chemin de câbles comme PE. Une telle utilisation est rare dans la mesure où les UL exigent que tous les câbles multipolaires comportent un PE intégré et où les câbles unipolaires ne sont employés que dans quelques applications industrielles.

Según NEC 392, la sección de código de eléctrico nacional para bandejas portacables, todos los sistemas de portacables deben estar debidamente CONECTADOS A TIERRA, según la sección 259.96. Para cumplir con este requisito, Cablofil recomienda usar empalmes clasificados UL para unir secciones y que la bandeja portacables esté conectada a tierra al acero del edificio o al sistema de conexión a tierra de la instalación cada 50'-60'. Al conectar a tierra cada 50'-60' de bandeja, la bandeja mantendrá un potencial bajo a tierra lo que reduce las interferencias electromagnéticas y proporciona una vía continua para corrientes parásitas. Los soportes colgantes de acero tipo trapecio sujetos firmemente al acero del edificio proporciona una conexión a tierra firme. Los empalmes estándar Cablofil (SWK, EDRN, EZBN, EZT90, RADT90) están diseñados para tener una resistencia menor que 1 miliohmio entre conexiones y proporcionan una conexión a tierra entre secciones. UL ha probado estos empalmes como parte del sistema de

conexión a tierra de la bandeja portacables. La bandeja de malla de cable pintada Cablofil requiere retirar el recubrimiento exterior de la superficie conductora en cada extremo de la bandeja antes de instalar el empalme (SWK). Este empalme (SWK) proporciona una continuidad de conexión a tierra clasificada por UL entre secciones de bandejas pintadas. Todas las bandejas portacables necesitan ser eléctricamente continuas según NEC 250.96. Los empalmes Cablofil estándar proporcionan continuidad según 250.96. El corte y la retirada de secciones de bandejas portacables sigue permitiendo la continuidad según 250.96 y sólo afecta al uso poco común de bandejas de cable como EGC. El uso de bandejas portacables como EGC es poco común, ya que UL requiere cables multiconductores para contener un EGC integral y los cables monoconductores sólo deben usarse en unas pocas aplicaciones industriales.

LOADING

CHARGE / CARGA

Cablofil has been tested to UL, CSA, NEMA VE1 and IEC standards. Cablofil wire mesh tray and supports are designed to support any cable load allowed by the NEC when supports are spaced on 8' spans. Only the heaviest cables (750 kcmil multiconductor power or larger) may require shorter spans. For specific loading go to the interactive load table on www.legrand.us/cablofil and choose your exact cable for detailed cable capacity and span requirements.

Le chemin Cablofil a été testé aux normes UL, CSA, NEMA VE1 et IEC. Le chemin en treillis métallique Cablofil et ses supports sont conçus pour accepter toute charge de câbles autorisée par le Code national de l'électricité tant que les supports sont espacés de 2,40 m (8 pi). Seuls les câbles les plus lourds (multipolaires d'alimentation de 750 kcmil ou plus gros) peuvent exiger un espacement inférieur. Pour toute charge particulière, consulter le tableau des charges interactif à www.cablofil.com et choisir le câble exact pour les spécifications détaillées de capacité en câbles et d'espacement des supports.

Se han hecho pruebas de Cablofil según las normas UL, CSA, NEMA VE1 e IEC. La bandeja de malla de alambre y los soportes de Cablofil están diseñados para soportar cualquier carga de cable permitida por el NEC cuando los soportes estén separados a intervalos de 8'. Solamente los cables más gruesos (de alimentación de conductores múltiples de 750 kcmil o mayores) pueden requerir separaciones más cortas. Para obtener cargas específicas vaya a la tabla de cargas interactivas en www.cablofil.com y escoja su cable exacto para obtener requisitos detallados de capacidad de cables y separaciones.

SUPPORT SPACING

ESPACEMENT DES SUPPORTS / SEPARACIÓN DE SOPORTES

Cablofil comes in 118" lengths and straight sections are designed for 6'-8' support spacing; (building joists or purlins are typically on 6'-7' spacing).

Cablofil has developed the following diagrams as a general guideline for supporting Field Fabricated Wire Mesh Tray. These guidelines will provide assistance in estimating and locating supports for the most common wire mesh tray installations. Supports are required as some of the side wires have been cut and the load capacity has been reduced. In actual installation, shallow and narrow trays may not require as many supports just as deep and wide trays may require additional supports. The installer should keep in mind that unique requirements arise in the field and practical solutions are often simple.

SUPPORT SPACING

ESPACEMENT DES SUPPORTS / SEPARACIÓN DE SOPORTES

Le chemin Cablofil est offert en sections de 295 cm (118 po) et les sections droites sont conçues pour un espacement de 1,80 à 2,40 m (6 à 8 pi) des supports (les poutrelles ou pannes de bâtiments sont généralement espacées de 1,80 à 2,10 m [6 à 7 pi]).

Cablofil a créé les schémas suivants destinés à servir de directives générales de soutien d'un chemin de câble en treillis métallique confectionné sur place. Ces directives aideront à estimer le nombre et l'espacement des supports pour les installations les plus courantes de chemins de câbles en treillis métallique. Il est nécessaire de prévoir les supports en tenant compte de la coupe de certains des fils latéraux de treillis et de la réduction de la charge admissible. Dans une installation réelle, les chemins peu profonds et étroits peuvent ne pas exiger autant de supports, de même que les chemins profonds et larges peuvent en exiger plus. L'installateur ne doit pas oublier que des exigences particulières apparaissent chez le client et que les solutions pratiques sont souvent simples.

Cablofil viene en secciones de 118" y las secciones rectas están diseñadas para una separación entre soportes de 6'-8'; (las viguetas o correas del edificio están separadas normalmente 6'-7').

Cablofil ha desarrollado los diagramas siguientes como guía general para sujetar la bandeja de malla de alambre fabricada en planta. Estas guías serán de ayuda para estimar y ubicar los soportes para las instalaciones de bandejas de malla de alambre más comunes. Se necesitan soportes, ya que se han cortado algunos de los alambres laterales y se ha reducido la capacidad de carga. En la instalación real, es posible que las bandejas poco profundas y estrechas no requieran tantos soportes tan profundos y las bandejas anchas pueden requerir soportes adicionales. El instalador deben tener en cuenta que los requisitos exclusivos surgen en la planta y las soluciones prácticas a menudo son sencillas.

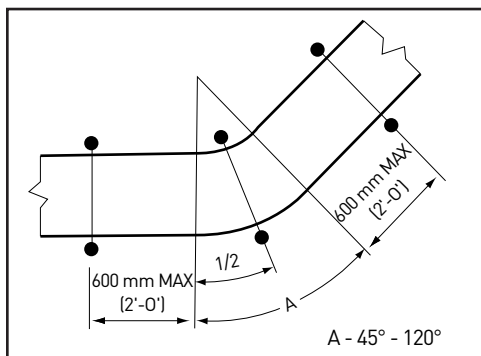

HORIZONTAL SWEEP SUPPORT

SOUTIEN DES COURBES HORIZONTALES À GRAND RAYON

SOPORTE DE CURVA HORIZONTAL

Center support not required on trays less than 12" wide and sweeps less than 45 degrees.

Un support central n'est pas nécessaire sur les chemins de moins de 30 cm (12 po) de large ni sur les courbes de moins de 45 degrés.

No se necesita un soporte central en bandejas de menos de 12" de ancho y en curvas de menos de 45 grados.

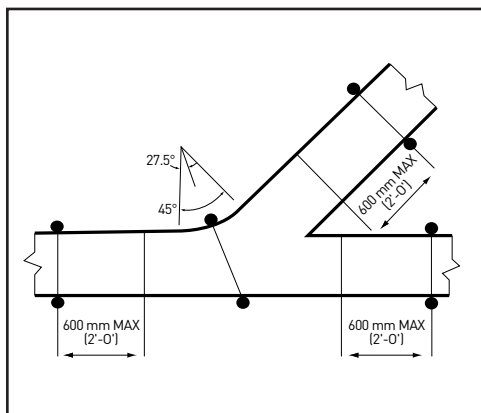

HORIZONTAL Y SUPPORT

SUPPORT DE JONCTION HORIZONTALE EN Y

SOPORTE Y HORIZONTAL

Center support not required on trays less than 12" wide.

Un support central n'est pas nécessaire sur les chemins de moins de 30 cm (12 po) de large.

No se requiere un soporte central en bandejas de menos de 12" de ancho. on trays less than 12" wide.

SUPPORT SPACING

ESPACEMENT DES SUPPORTS / SEPARACIÓN DE SOPORTES

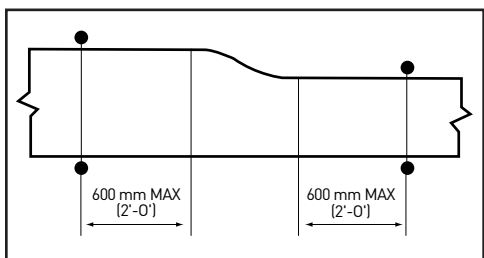

REDUCTION SUPPORT

SUPPORT DE RÉTRÉCISSEMENT

SOPORTE DE REDUCCIÓN

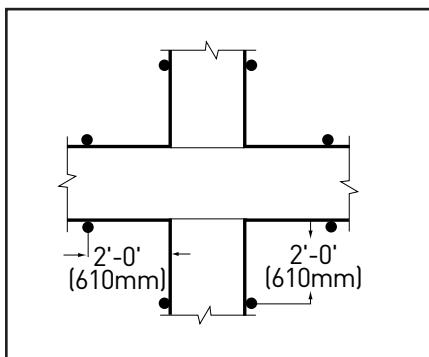

HORIZONTAL CROSS SUPPORT

SUPPORT DE JONCTION TRANSVERSALE HORIZONTALE

SOPORTE TRANSVERSAL HORIZONTAL

On 24" wide items, recommended distance is 1 ft. 6 in. (457mm) from splice connection.

Sur les chemins de 60 cm (24 po) de large, la distance recommandée par rapport à la jonction est de 457 mm (1 pi 6 po).

En artículos de 24" de ancho, la distancia recomendada es de 1 pie 6 pulg (457mm) desde la conexión del empalme.

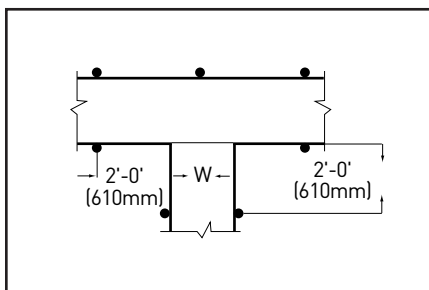

HORIZONTAL TEE SUPPORT

SUPPORT DE JONCTION EN TÉ HORIZONTALE

SOPORTE DE TE HORIZONTAL

Additional support recommended at back of tee (shown) or directly under tee, diagonally positioned, for 4" and 6" deep trays, 18" and wider.

Un support supplémentaire est recommandé à l'arrière du té (illustré) ou juste sous celui-ci, en diagonale, pour les chemins de 10 et 15 cm (4 et 6 po) de profondeur et d'au moins 45 cm (18 po) de large.

Se recomienda un soporte adicional en la parte trasera de la te (mostrada) o directamente debajo de la te, colocado diagonalmente, para bandejas de 4" y 6" de profundidad, 18" y más.

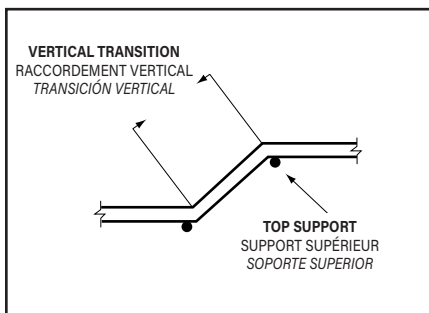

VERTICAL TRANSITION

RACCORDEMENT VERTICAL

TRANSICIÓN VERTICAL

Support vertical transition at top support location. Distances of 3 ft. and larger should be supported at each end as illustrated.

Soutenir un raccordement vertical à l'emplacement de support supérieur. Les portions d'au moins 91 cm (3 pi) doivent être soutenues à chaque extrémité comme sur l'illustration.

Soporte la transición vertical en la ubicación del soporte superior. Las distancias de 3 pies y más deben estar sujetas en cada extremo según se indica.

TRAY

CHEMIN DE CÂBLES / BANDEJA



CF 105

4" DEEP TRAY

CHEMIN DE 4 PO
DE PROFONDEUR
BANDEJA DE 4"
DE PROFUNDIDAD
4", 6", 8", 12", 18", 20", & 24"
WIDE / DE LARGE /
DE ANCHO



CF 150

6" DEEP TRAY

CHEMIN DE 6 PO
DE PROFONDEUR
BANDEJA DE 6"
DE PROFUNDIDAD
12", 18", 20", & 24"
WIDE / DE LARGE /
DE ANCHO

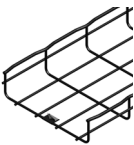

UL CLASSIFIED PAINTED WIRE CABLE TRAY

CHEMIN DE CÂBLES
EN FILS PEINT AVEC
CONFORMITÉ UL
BANDEJA PORTACABLES
DE ALAMBRE PINTADO
CLASIFICADA POR UL
2", 4", 6", 8", 12", 18", 20", & 24"
WIDE / DE LARGE / DE
ANCHO

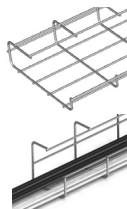

CFG

CABLOFIL G-TRAY AND G-MINI

CABLIFIL G-TRAY
ET G-MINI
BANDEJA G Y G-MINI
DE CABLOFIL



CF 54

2" DEEP TRAY

CHEMIN DE 2 PO
DE PROFONDEUR
BANDEJA DE 2"
DE PROFUNDIDAD
2", 4", 6", 8", 12", 18", 20", & 24"
WIDE / DE LARGE / DE
ANCHO

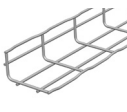

CFL

CABLOFIL L TRAY

CHEMIN CABLOFIL
L
BANDEJA CABLOFIL
L



TXF35

TELEX RAIL

RAIL TELEX
CARRIL TELEX

TRAY COVERS

COUVRE-CHEMINS / CUBIERTAS DE BANDEJAS

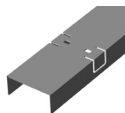

CTXF 35

TELEX RAIL COVER

COUVRE-RAIL
TELEX
CUBIERTA DE
CARRIL TELEX



UC 35

TELEX RAIL STANDOFF SUPPORT

SUPPORT À
MONTAGE VERTICAL
DE RAIL TELEX
SOPORTE DE
SEPARACIÓN DE
CARRIL TELEX



INSERT

TRAY INSERT

INSERT POUR
CHEMIN
INSERTO DE
BANDEJA

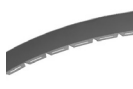

COT F

FLEXIBLE DIVIDER

JONCTION FLEXIBLE
DIVISOR FLEXIBLE

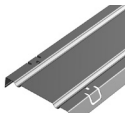

CVN

CABLOFIL TRAY COVER

COUVRE-CHEMIN
CABLOFIL
CUBIERTA DE
BANDEJA CABLOFIL



COT J

DIVIDER COUPLER

DISPOSITIF DE
JONCTION
ACOPLADOR
DIVISOR

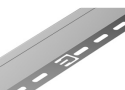

COT 54

DIVIDER STRIP

BANDE DE
JONCTION
TIRA DIVISORA

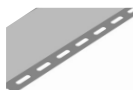

COT 105/COT 150

DIVIDER STRIP

BANDE DE
JONCTION
TIRA DIVISORA

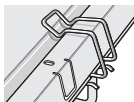

CLIP FO2

CABLOFIL COVER CLIP

CLIP DE COUVRE-CHEMIN CABLOFIL
PRESILLA DE CUBIERTA CABLOFIL

SPLICING

JONCTION / EMPALMES



EDRN
FAST SPLICE
JONCTION
RAPIDE
EMPALME RÁPIDO



EDRNT
TOOL
MOUNTING TOOL
OUTIL DE MONTAGE
HERRAMIENTA
DE MONTAJE



EDRNT
TOOL
MOUNTING TOOL
OUTIL DE MONTAGE
HERRAMIENTA
DE MONTAJE



ED 275
UNIVERSAL
SPLICE BAR
BARRE DE
JONCTION
UNIVERSELLE
BARRA DE EMPALME
UNIVERSAL

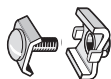

SWK
SPLICE WASHER KIT
JEU DE RONDELLES
DE JONCTION
JUEGO DE
ARANDELAS
DE EMPALME

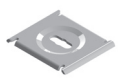

CE 40
SQUARE SPLICE
WASHER
RONDELLE CARRÉE
DE JONCTION
ARANDELA DE
EMPALME CUADRADA



CE 25
SPLICE WASHER
RONDELLE CARRÉE
DE JONCTION
ARANDELA
DE EMPALME
CUADRADA



CE 35
CLAMPING
WASHER
RONDELLE
DE SERRAGE
ARANDELA
DE FIJACIÓN



EZT 90 KIT
90° AND TEE
BEND KIT
KIT DE TÉ / COURBE
JUEGO DE CODOS
DE 90° Y TES



EAC
ELEVATION
CHANGE HINGE
ARTICULATION
DE CHANGEMENT
DE PENTE
ARTICULACIÓN
DE CAMBIO
DE ELEVACIÓN



RAD T 9012 KIT
12" RADIUS TEE 90°
KIT
KIT DE TÉ, 12
PO DE RAYON
JUEGO DE TES
DE 90° DE 12"
DE RADIO



RAD T 90 KIT
5½" RADIUS
TEE 90° KIT
KIT DE TÉ, 5½
PO DE RAYON
JUEGO DE TES
DE 90° DE 5½"
DE RADIO

ACCESSORIES

ACCESSOIRES / ACCESORIOS



EZBN
1/4"



EZHN
1/4", 3/8", 1/2"



EZFW
1/4", 3/8", 1/2"



THRD
1/4", 3/8", 1/2"



TRP
THREADED ROD
PROTECTOR
PROTECTION DE
TIGE FILETÉE
PROTECTOR DE
BARRAS
ROSCADO



EZCN
1/4", 3/8", 1/2"



SWK

ACCESSORIES

ACCESOIRES / ACCESORIOS



CE25



CE 40



CE 35



CUTYFIL

ED 275/1100



COUPFIL

WALL MOUNTINGS

MONTAGE MURAUX / MONTAJES EN LA PARED



FAS P
FAS PROFILE
PROFILÉ FAS
PERFIL FAS



CAT 30/41
SNAP-IN WALL
HANGER SUPPORT
SUPPORT DE
SUSPENSION
MURALE À
ENCLÈCHEMENT
RAPIDE
SOPORTE DE PARED
ENCAJABLE



FAS L
BRACKET
SUPPORT
SOPORTE

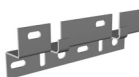

FV
VERTICAL BRACKET
SUPPORT VERTICAL
SOPORTE VERTICAL



FAS C
BRACKET
SUPPORT
SOPORTE



EDF
RAIL
RAIL
CARRIL



FAS U
UNIVERSAL
BRACKET
SUPPORT
UNIVERSEL
SOPORTE
UNIVERSAL



CRP
UNIVERSAL WALL
BRACKET
SUPPORT MURAL
UNIVERSEL
SOPORTE DE
PARED UNIVERSAL



C 50
WALL MOUNT
ATTACHMENT
FIXATION MURALE
ACCESORIO DE
MONTAJE EN LA
PARED



UC 50
CABLE TRAY
STANDOFF
SUPPORT À MONTAGE
VERTICAL DE CHEMIN
DE CÂBLES
ESPACIADO DE
BANDEJA
PORTACABLES

CEILING MOUNTINGS

MONTAGES AU PLAFOND / MONTAJES EN EL TECHO



SF 50
CENTER HANGER
 SUPPORT CENTRAL
 DE SUSPENSION
 SOPORTE
 COLGANTE
 CENTRAL



FAS P
FAS PROFILE
 PROFILÉ FAS
 PERFIL FAS



FAS PCH
CENTER HANGER
 SUPPORT CENTRAL
 DE SUSPENSION
 SOPORTE
 COLGANTE
 CENTRAL



AS
TRAPEZE
HANGING CLIP
 TIRANT
 TRAPÉZOÏDAL
 PRESILLA
 COLGANTE DE
 TRAPECIO



SON
SLIP-ON LOCK
NUT®



FAS C
BRACKET
 SUPPORT
 SOPORTE



EDF
RAIL
 RAIL
 CARRIL

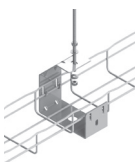

SF 100
CENTER HANGER
 SUPPORT CENTRAL
 DE SUSPENSION
 SOPORTE
 COLGANTE
 CENTRAL

UNDERFLOOR MOUNTINGS

MONTAGES SOUS PLANCHER / MONTAJES DEBAJO DEL PISO



UFC550 KIT UNDER FLOOR SUPPORT CLAMP KIT

KIT DE BRIDE DE
SUPPORT SOUS
PLANCHER
JUEGO DE
ABRAZADERAS
DE SOPORTE DE
DEBAJO DEL PISO



UFC
UNDER FLOOR
SUPPORT CLAMP
BRIDE DE SUPPORT
SOUS PLANCHER
ABRAZADERA
DE SOPORTE DE
DEBAJO DEL PISO



FAS P
FAS PROFILE
PROFILÉ FAS
PERFIL FAS



C 50
UNDER FLOOR
ATTACHMENT
FIXATION SOUS
PLANCHER
SUJECIÓN POR
DEBAJO DEL PISO



UC 50
CABLE TRAY
STANDOFF
SUPPORT À
MONTAGE
VERTICAL DE
CHEMIN DE CÂBLES
SOFF DE BANDEJA
PORTACABLES



FAS U
UNIVERSAL
BRACKET
SUPPORT
UNIVERSEL
SOPORTE
UNIVERSAL



FAS L
BRACKET
SUPPORT
SOPORTE



DF
ANGLE
MOUNTING
BRACKET
CORNIÈRE DE
MONTAGE
SOPORTE DE
MONTAJE ANGULAR



EDF
RAIL
RAIL
CARRIL



UFS
UNDER FLOOR
SUPPORT BRACKET
CONSOLE SUPPORT
SOUS PLANCHER
MÉNSULA DE APOYO
DE DEBAJO DEL
PISO



UFS
UNDER FLOOR
SUPPORT
SUPPORT SOUS
PLANCHER
SOPORTE DE
DEBAJO DEL PISO



UFFS
UNDER FLOOR
FIBERGLASS
SUPPORT STAND
CONSOLE SUPPORT
EN FIBRE DE VERRE
SOUS PLANCHER
BASE DE SOPORTE
DE FIBRA DE VIDRIO
DEBAJO DEL PISO

OTHER MOUNTINGS

AUTRES MONTAGES / OTROS MONTAJES



**C50CC
CONDUIT
CLAMP KIT**
KIT DE COLLIERS DE
TUBE PROTECTEUR

*JUEGO DE
ABRAZADERAS DE
CONDUCTOS*



**CC KIT
CONDUIT
CLAMP KIT**
KIT DE COLLIERS DE
TUBE PROTECTEUR

*JUEGO DE
ABRAZADERAS DE
CONDUCTOS*

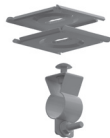

**CE40CC & CH
CONDUIT
ATTACHMENT
FITTINGS AND
CONDUIT CLAMP KIT**

ACCESSOIRES DE
FIXATION POUR ET
KIT DE COLLIER
POUR TUBE
PROTECTEUR

*JUEGO DE
ACCESORIOS
DE SUJECIÓN DE
CONDUCTOS Y
ABRAZADERAS DE
CONDUCTOS*



**FASCLM KIT
BEAM CLAMP**
BRIDE DE FIXATION
SUR POUTRE
*ABRAZADERA
DE VIGA*



**EZBC
BEAM CLAMP**
BRIDE DE FIXATION
SUR POUTRE
*ABRAZADERA
DE VIGA*



**ETC
TRAY BEAM
SUPPORT**
SUPPORT DE
CHEMIN SUR
POUTRE
*SOPORTE DE VIGA
DE BANDEJA*



**C 50
ELECTRICAL
BOX SUPPORT**
SUPPORT DE
COFFRET DE
BRANCHEMENT
*SOPORTE DE CAJA
ELÉCTRICA*



**SBDA
CONDUIT AND
BOX SUPPORT**
SUPPORT DE
CONDUIT ET DE
COFFRET
*SOPORTE DE
CONDUCTOS Y CAJAS*



**AB225 KIT
ANGLE BRACKET**
ÉQUERRE DE
FIXATION
SOPORTE EN ÁNGULO

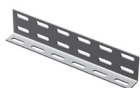

**HB 2
WALL/FLOOR
TERMINATION
BRACKET**
SUPPORT DE
RACCORDEMENT
MUR/PLANCHER
*SOPORTE DE
TERMINACIONES DE
PARED/PISO*



**CCLMP
CABLE CLAMP**
SERRE-CÂBLE
SUJETACABLES

OTHER MOUNTINGS

AUTRES MONTAGES / OTROS MONTAJES

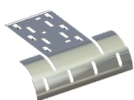

BDO

SDO CABLE DROP OUT

DESCENTE DE
CÂBLE
BAJAA DE CABLE

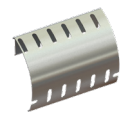

CLIP CABLE LABEL CLIP

ATTACHE ÉTIQUETTE
DE CÂBLE
PRESILLA DE
ETIQUETAS DE
CABLES



EZVC VELCRO ROLL ROULEAU VELCRO ROLLO DE VELCRO

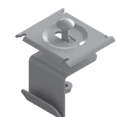

RB112KIT RACK BRACKET KIT KIT SUPPORT POUR BAIE JUEGO DE SOPORTES DE ESTANTES



FS 41 FASTRUT CONNECTOR BARRETTE FASTRUT CONECTOR FASTRUT



GNDCL GROUNDING LUG COSSE DE MISE À LA TERRE OREJA DE CONEXIÓN A TIERRA



FAS ROLLER HD HEAVY DUTY GUIDE-CÂBLE À ROULEAUX RENFORCÉ SERVICIO PESADO



WMC2LA WIRE MESH CABLE TRAY-TO-LADDER CLAMP

BRIDE DE FIXATION
DE CHEMIN DE
CÂBLES EN TREILLIS
MÉTALLIQUE À
ÉCHELLE
ABRAZADERA
DE BANDEJA A
ESCALERILLA DE
ALAMBRES DE MALLA

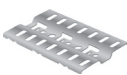

MFM METALLIC MULTIFIX PLATE PLAQUE MÉTALLIQUE MULTIFIX PLACA METÁLICA DE FIJACIÓN MÚLTIPLE



CABLO SNAP CABLE BUNDLER COLLIER DE FAISCEAU DE CÂBLES EMPAQUETADOR DE CABLES



EZJB 5/16 J-BOLT BOULON EN J PERNO EN J



SZMCKIT SEISMIC BRACING KIT KIT DE LIGATURE ANTIVIBRATILE JUEGO DE TIRANTES SÍSMICOS



GNDSB GROUNDING LUG COSSE DE MISE À LA TERRE OREJA DE CONEXIÓN A TIERRA



FAS ROLLER



www.legrand.us/cablofil

Phone 800-658-4641

618-566-3230

Fax 618-566-4978

8319 State Route 4

Mascoutah, IL USA 62258

designed to be better.™

EZ-331-03-14