



SHARP LA SERIES
INSTALLATION GUIDELINES

PN-LA652 / PN-LA752 / PN-LA862

Sharp NEC Display Solutions Europe GmbH

24-Jun-24

- Precautions for transportation of the packed display ...page 3-6
- Precautions for opening package ...page 7
- Precautions for installation and handling ...page 8-10
- Precautions for display mounting ...page 11
 - Temperature, clearance and environment ...page 12
 - Portrait installation ...page 13
 - Tilted and face-up installation ...page 14
 - Side-by-side installation ...page 15

Transportation of packed display

- **4 persons** are needed to handle the packed display.
- Transport the packed display on a cart. In case cart cannot be used (e.g., stairs), move the display with more than 4 persons.
- Move the packed display in landscape position. Transporting the display in portrait or flat position is not supported. (**Temporary** transportation in portrait position in an elevator for example is allowed.)

<Packaging dimensions>

	W	D	H
PN-LA862	2,095	225	1,310
PN-LA752	1,900	225	1,125
PN-LA652	1,660	220	1,010

(For North America) Packing carton is on the skid

	W	D	H
PN-LA862	2,185	235	1,429
PN-LA752	1,925	235	1,244
PN-LA652	1,685	235	1,129

(mm)

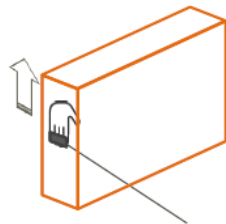

Hand grip

Use the shown handgrip to lift up the packed display. Hold the side of the package so that it will not fall down.

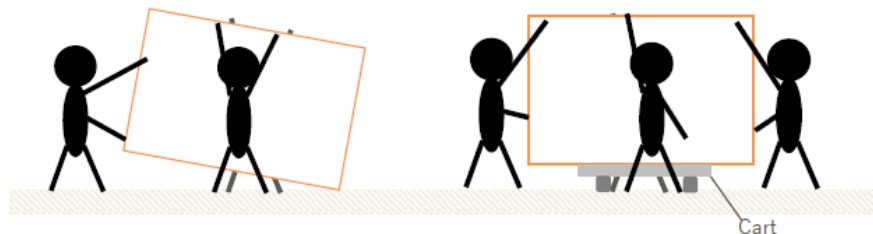

Lift either side of the package in order to place it onto the cart. Package must be held by other persons in order to avoid falling down. (2 persons are holding the package in above illustration)

While transporting the packed display by cart, hold the all sides of the displays by 4 persons.

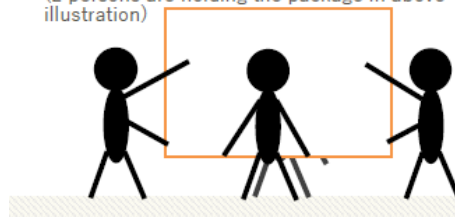

In case a cart cannot be used, move the packed display by more than **4 persons**, with each person holding each side of the package.

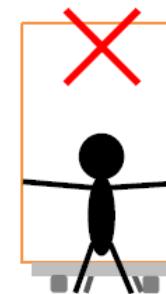

Packed display should not be transported in portrait position. In the case transportation in landscape position is impossible, it may be temporarily transported in portrait position.

Carry in space

1) Space to carry in

A cart should be used for transportation.
 In order to transport the packed product with a cart, the following space is necessary.
 (In case width of a cart is <300mm and height of cart is < 150mm)

	Width	Height
PN-LA862	> 400mm	> 1,650mm
PN-LA752	> 400mm	> 1,500mm
PN-LA652	> 400mm	> 1,300mm

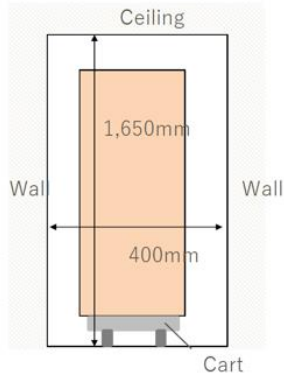

2) Space at a corner

In case there are turns alongside with transportation pathway, 1,200mm < width is necessary.
 Caution: Take care not to hit the package against the corner wall.

	Space
PN-LA862	> 1,200mm
PN-LA752	> 1,100mm
PN-LA652	> 1,000mm

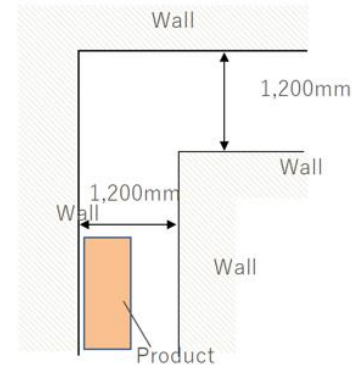

Use of elevator

1) Accommodation space

When using an elevator to transport, following are the minimum size of the elevator.

In case transportation in landscape position is not possible, it may be transported temporarily in portrait position.

Caution: Take care not to hit the package against the elevator door or the wall while carrying the display into the elevator.

	Landscape position		
	Width	Depth	Height
PN-LA862	> 2,250mm	> 400mm	> 1,500mm
PN-LA752	> 2,000mm	> 400mm	> 1,200mm
PN-LA652	> 1,730mm	> 400mm	> 1,100mm

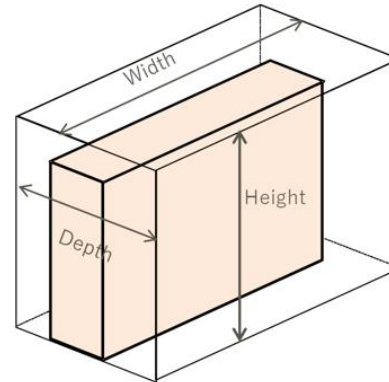

Note: The space for the workers who ride together is not included.

Use of elevator

2) Carry in space

An elevator should have the size that accommodate the product when using an elevator.

Caution: The packing or product should not contact with the door and/or the wall when using an elevator.

The following list is indicating angles and required sized when the depth is insufficient and carrying the package diagonally is required.

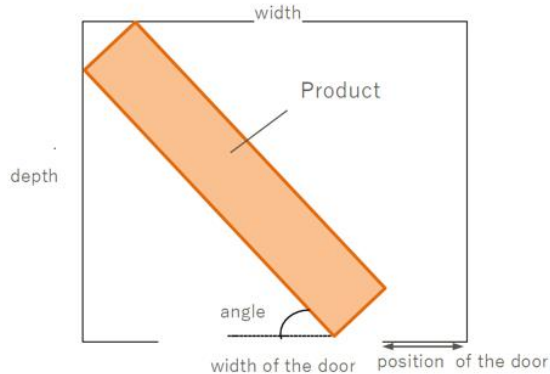

Size	Angle	Position of the door	Packed		Body only	
			Width	Depth	Width	Depth
86"	45°	0	1,850	1,850	1,600	1,600
		150	1,950	1,850	1,700	1,600
		250	2,050	1,850	1,800	1,600
75"	45°	0	1,700	1,700	1,400	1,400
		150	1,800	1,700	1,500	1,400
		250	1,900	1,700	1,600	1,400
65"	45°	0	1,550	1,550	1,300	1,300
		150	1,700	1,550	1,450	1,300
		250	1,800	1,550	1,550	1,300

※The door should have the same width of the product when the angle is 0 degree. [mm]

- Depth : Depth of the elevator (length from front to back)
- Width : Width of the elevator
- Width of the door : Width of the door
- Position of the door : Distance between the side wall to the edge of the door
- Angle : Tilting angle of the product when carrying in an elevator

Precaution for opening package

- Please open the package with at least **2 persons**.
- Remove the 4 joints attached to the lower part of the package.
- Hold the both side of the package and lift it up straight.



Remove the joint downward pinching the inner side of it.

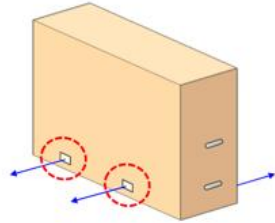

Remove the joints at the bottom of the packing box along the longest side.

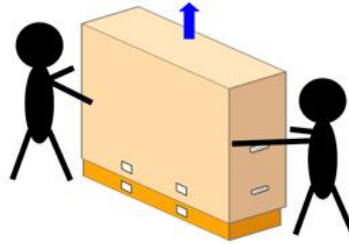

After removal of the joints, please lift up the both sides of the carton box straight.

Note: For North America, the packing box is on the skid for ISTA compatibility.

Condensation

Dew condensation can be built up on the display, either on the surface or internally when bringing the display from a cold to warm space or if the ambient temperature rises rapidly by air conditioning for example.

In case dew condensation occurs not only on the surface but internally, please do not turn on the display until the condensation disappears. Otherwise, it may cause malfunction. (Please raise the ambient temperature gradually in order to avoid dew condensation.)



Precautions when installing and moving the display

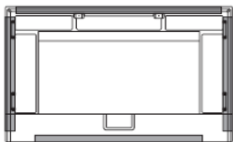

- The LCD screen is made of glass. When installing or moving the product, be sure to hold the handle on the parts marked by grey.
 - Also, do not put your hands on the liquid crystal display surface, the corners of the device, the speaker, or the pen tray shown in red.
 - Do not touch the power switch on the back, the bottom, or the terminals on the sides. Doing so may cause damage, malfunction, or injury.
- Be careful not to slip your hands.
- When lifting with a crane, etc., do not use the handle. (See next page for details)

Caution:

Prior to installing this product, please read the following items carefully in order to use it in good condition for long time.

- Please use a mounting bracket which can support 4 times weight of the display. The wall on which displays are mounted must support 4 times total weight of the display and a mounting bracket (concrete wall, pillar etc).
- Install the display vertical to the level surface. Tilt angle is up to 5 degrees upward. In case that the tilt angle will exceed it or flat installation, please consult your dealer.

There is some conditions for the installation.

- Usable ambient temperature range of this display is 5°C-35°C. Using under other condition may cause malfunction. Please keep enough space to avoid heating up.

(Example) : When heat is not dissipated and the internal temperature of the unit becomes high, the brightness of the backlight decreases and display of the unit becomes darker. If the internal temperature increases further more, the unit is turned off and becomes standby mode.

- In case when securing the space is difficult such as the unit is installed inside a case or the unit is installed where the ambient temperature does not range from 5°C to 35°C, please take measures so as the temperature inside a case or the ambient temperature ranges from 5°C to 35°C by installing a fan, for example.
- Please do not obstruct the ventilation hole. It may cause inner rise of temperature and malfunction.
 - Please keep the display away from direct sunlight. It may cause failure and deterioration.
 - In dusty areas, it is necessary to take measures against dust such as regular cleaning.
 - For safety, please give measures for preventing fall of display.
 - The ground connection is necessary when the power plug is connected. 3-pin plug is used for the power plug. Please ask the professional dealer/contractor if you are not able to make ground connection.
 - When the display is temporary put on the desk etc without a stand, please spread a soft sheet under it because the mounting bracket interfere with the desk.

Note:

- Please refer to “Mounting precautions (for SHARP dealers and service engineers)” which is described in the operation manual and “Mounting precautions (For SHARP dealers and service engineers)” which is described in the setup manual.
- Please be careful that the product warranty is not valid if these precautions are not taken.

Hang the display using the handle

- Be sure the handles are secure.

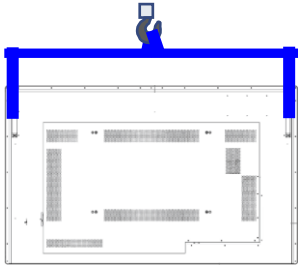

Hang the display using the installation hole

- Attach the bracket. Fix the bracket with 4 points.
- Lift the display by attaching it to the VESA mounting points.

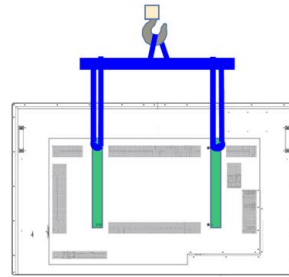

Attaching eyebolts for temporary use (75 inch & 86 inch only)

This model is equipped with pre-installed eyebolt brackets for attaching eyebolts (not included) to aid in mounting.

- Screw the eyebolts into eyebolt holes in eyebolt brackets as shown in the picture.
- Be sure the eyebolts are secure.
- Do not mount the monitor using only the eyebolts. Eyebolts are for temporary use only.

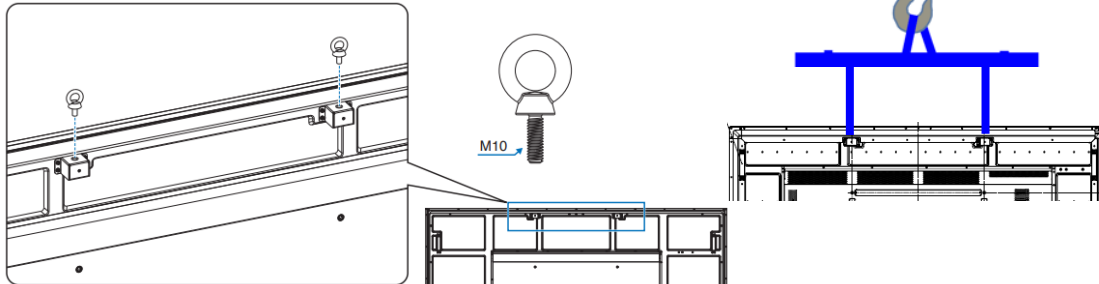

When temporarily hanging the display, vertical support is required. Diagonal suspensions are not permitted.

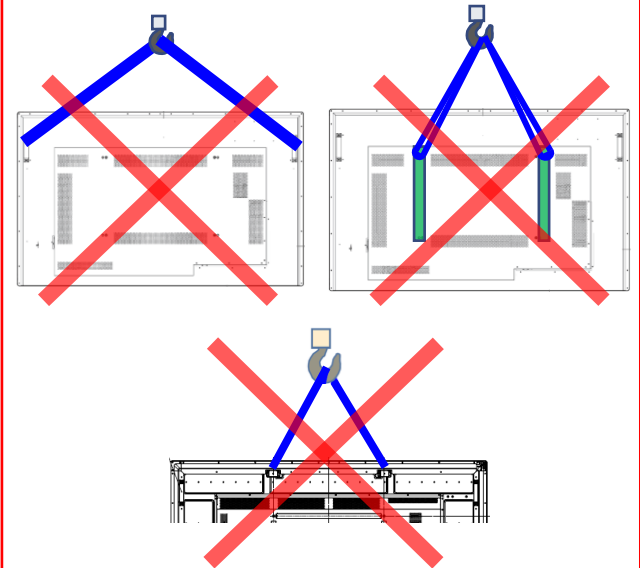

Worker position, assignment and cautions while lifting up the display

- As this product is heavy, please wear gloves and safety shoes when you lift up this display.
- In order to lift up the display, such as the move from a packing box to a cart, **4 persons (86" and 75")** or **2 persons (65")** are required.
- Please check the position and assignment for each worker by referring to the illustration below.

86 inch / 75 inch

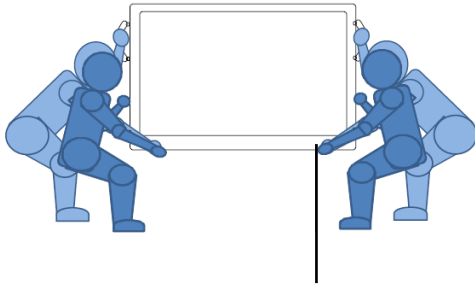

65 inch

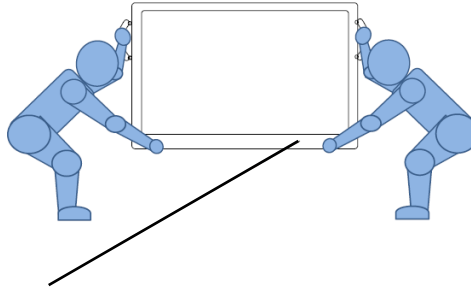

Caution: Please be careful not to touch the speakers.

VESA compliant mounting bracket for the display (M8 screw)

Please pay attention to the following items when using the screw holes on the back of the display.

- 1) Please use 4 mounting screws to fix the display.
- 2) Please use screws with correct length as described in the operation manual of the display. Display may drop with a long screw.
- 3) Please take proper countermeasures to prevent the screws from becoming loose (for example : using screws with a split lock washer).
- 4) Please tighten the screws to approximately 3Nm torque.
 - ※ Do not use an impact driver.

Please mount the displays onto the mounting bracket recommended by SHARP.

Read carefully the notes described in the instruction manual of each option.

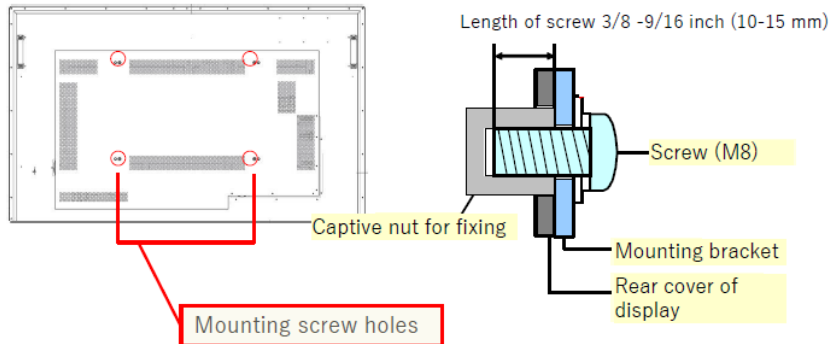

When using the monitor laying flat on a surface (when the monitor is tilted more than 20 degrees upward from the perpendicular in relation to a level surface), consult an authorized SHARP/NEC dealer because there are some specific mounting conditions. Adhere to the following. Failing to adhere to the following may cause malfunctions.

- Set HORIZONTAL INSTALLATION in the MONITOR menu to “FACE UP”. (“FACE UP” mode makes display decrease the max of brightness only for 65”.)
- Use the monitor at the ambient temperature within the range of 41°F (5°C) to 86°F (30°C).
- Provide 7-7/8 inch (200 mm) or more space between the monitor and the floor or other mounting surfaces and surrounding objects to prevent heat from accumulating inside. If it is difficult to provide sufficient space or if the ambient temperature may be outside of the range of 41°F (5°C) to 86°F (30°C), install a fan or take other measures to keep the ambient temperature within the required range.
- In case of flat face-up installation, unable to use touch pen and portrait installation.
- Do not press hard on the LCD panel or otherwise subject it to impacts.
- For 75 and 86 inch, need special face-up bracket for supporting the LCD module.
 - FACE-UP BRACKET PN-LA752 (100016245)
 - FACE-UP BRACKET PN-LA862 (100016246)

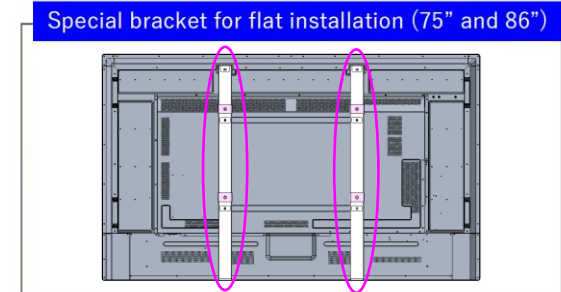
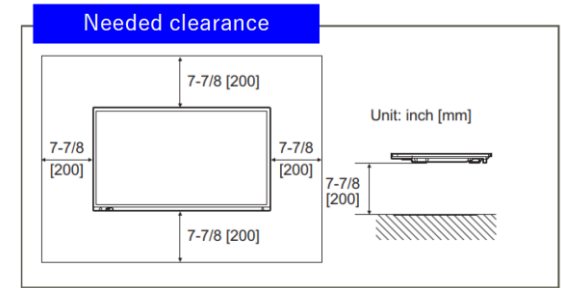

Without bracket

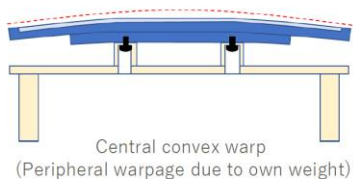

With bracket

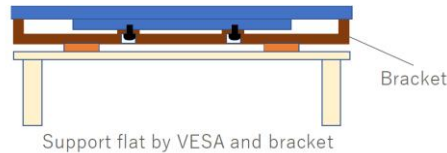

Installing the display in portrait orientation

- Install the monitor such that the power LED is located on the bottom side.
- Be sure to clamp the power cord (supplied) onto the cable clamp attachment using the supplied cable clamp.
- When clamping the power cord, take care not to stress the terminal of the power cord.
- Do not bend the power cord excessively.
- Set the “PORTRAIT/LANDSCAPE INSTALL” on the ADMIN menu to “PORTRAIT”.
- Use the cover SHARP logo when you install the monitor in portrait orientation.

For the monitor in portrait orientation

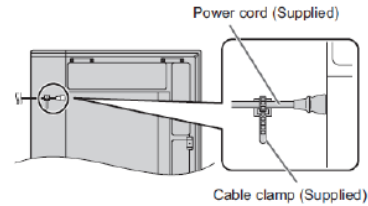
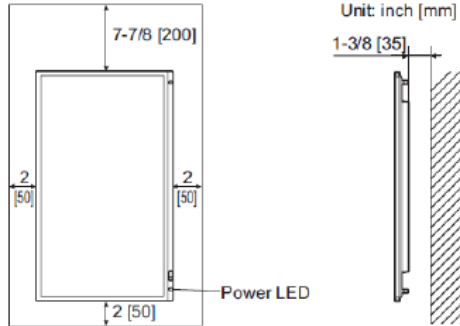

PN-LA652

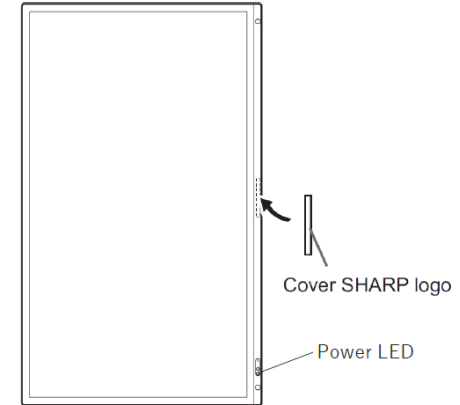
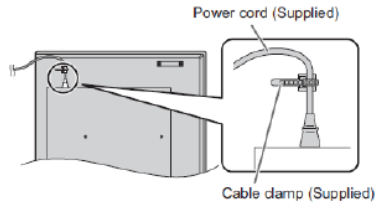

- In case that the installation angle is from 0 to 20 degrees versus the vertical direction, usable ambient temperature range of this display is 5°C-35°C.
- In case that the installation angle is 45 degrees versus the vertical direction or flat, usable ambient temperature range of this display is 5°C-30°C.
- Other than the ambient temperature range, there are following conditions when using LA Series face-up or in tilted installation:
 - Only landscape installation
 - Unable to use touch pen
 - Limitation of max. brightness for 65 inch in case of face-up
 - Need special face-up supporting bracket for 75 inch and 86 inch:
 - FACE-UP BRACKET PN-LA752 (100016245)
 - FACE-UP BRACKET PN-LA862 (100016246)
 - Unable to use PIP mode of 4 screens in case of tilted 90 degrees

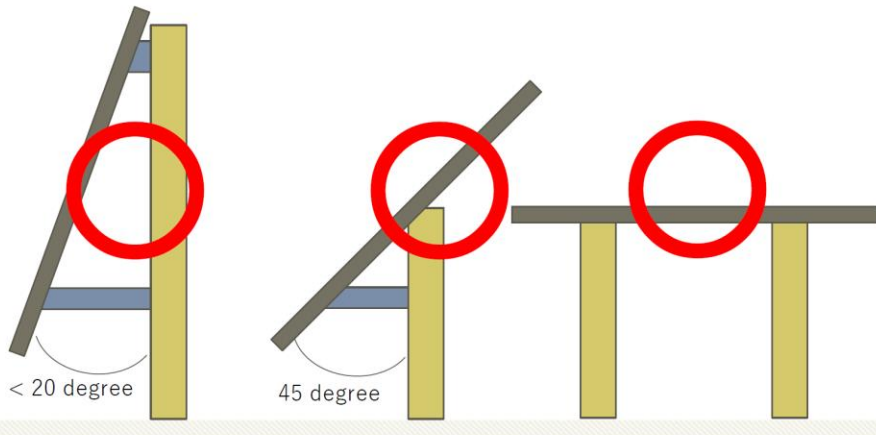

Inch	Tilt angle (degree)	Usage condition			Installation condition	
		Temperature	Brightness	Touch pen	Portrait	Special bracket
65	0-20	5-35°C	-	Available	Yes	No need
	45	5-30°C	-	Unavailable	No	No need
	90	5-30°C	Max 200cd	Unavailable	No	No need
75"	0-20	5-35°C	-	Available	Yes	No need
	45	5-30°C	-	Unavailable	No	Need
	90	5-30°C	-	Unavailable	No	Need
86"	0-20	5-35°C	-	Available	Yes	No need
	45	5-30°C	-	Unavailable	No	Need
	90	5-30°C	-	Unavailable	No	Need

*1: Don't use PIP mode of 4 screen

*1
*1
*1

Conditions for side-by-side installation

- Please keep the product away from direct sunlight or strong light.
- Multiple monitors can be installed in side-by-side conditions.
- When using multiple monitors closely, be sure the infrared transmitter/receiver does not affect the other ones.

MULTIPLE DISPLAY MODE in the OSD setting menu:

- Please set to “ON” when two or more monitors are used in close proximity.

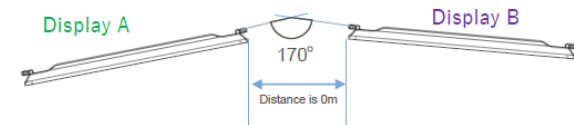

Supports up to 170° when facing inwards to each other in side-by-side conditions.

SHARP / NEC

Sharp NEC Display Solutions Europe GmbH