

PUBLIC VIEW MONITOR

SMT-1031PV/SMT-1031PVW

SMT-3231PV/SMT-3221PV

SMT-2731PV/SMT-2721PV

SAFETY INSTRUCTIONS

1. WARNING

To reduce the risk of fire or electric shock, do not expose this product to rain or moisture.

Do not insert any metallic object through the ventilation grills or other openings on the equipment.

Apparatus shall not be exposed to dripping or splashing and that no objects filled with liquids, such as vases, shall be placed on the apparatus.

To prevent injury, this apparatus must be securely attached to the Wall/ceiling in accordance with the installation instructions.

2. CAUTION

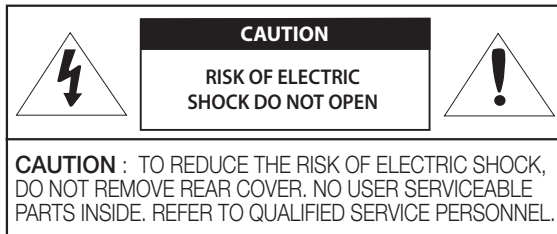

3. EXPLANATION OF GRAPHICAL SYMBOLS



The lightning flash with arrowhead symbol, within an equilateral triangle, is intended to alert the user to the presence of "dangerous voltage: within the product's enclosure that may be of sufficient magnitude to constitute a risk of electric shock to persons.



The exclamation point within an equilateral triangle is intended to alert the user to the presence of important operating and maintenance (servicing) instructions in the literature accompanying the product.

CAUTION

RISK OF EXPLOSION IF BATTERY IS REPLACED BY AN INCORRECT TYPE.
DISPOSE OF USED BATTERIES ACCORDING TO THE INSTRUCTIONS.

ATTENTION

IL Y A RISQUE D'EXPLOSION SI LA BATTERIE EST REMPLACÉE PAR UNE BATTERIE DE TYPE INCORRECT.
METTRE AU REBUT LES BATTERIES USAGÉES CONFORMÉMENT AUX INSTRUCTIONS.

※ This device has been verified using STP cable. The use of appropriate GND grounding and STP cable is recommended to effectively protect your product and property from transient voltage, thunderstroke, communication interruption.

※ Select an installation site that can hold at least 4 times the monitor weight.

CONTENTS

OVERVIEW	4	Package Contents
	4	Separately sold product
4	5	Names and functions of each part(SMT-1031PV/SMT-1031PVW)
	8	Names and functions of each part(SMT-3231PV/SMT-3221PV/SMT-2731PV/SMT-2721PV)
	11	Remote control
CONNECTING WITH OTHER DEVICE	12	Things to check before connection
	12	Connecting with external devices
12		
MENU SETTINGS	14	OSD Menu setting (SMT-1031PV/SMT-1031PVW)
	16	OSD Menu setting (SMT-3231PV/SMT-3221PV/SMT-2731PV/SMT-2721PV)
14		
NETWORK CONNECTION AND SETUP & WEBVIEWER	23	Connecting the PVM Directly to Local Area Networking
	24	Connecting the PVM Directly to a DHCP Based DSL/Cable Modem
	25	Using Device Manager
	25	Automatically searching camera
	25	Configuring IP address
	27	Manually registering camera
	28	Automatically configuring IP
	28	Port Range Forward (Port Mapping) Setup
	30	Connecting to the Camera from a Shared Local PC
	30	Connecting to the Camera from a Remote PC via the Internet
	30	Connecting to the Camera
	32	Password setting
	32	Login
	32	Camera Web Viewer Setup
23		
SETUP SCREEN	33	Setup
	33	Hallway view
	34	Creating a text overlay
	35	PVM setup
	37	Setting alarm input
33		
APPENDIX	41	Mechanical
	44	Troubleshooting
41		

overview

PACKAGE CONTENTS

Please check the following contents are included in addition to the main unit.

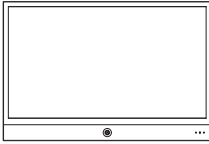

Public View Monitor

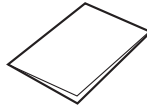

Quick Start Guide



Alarm terminal block

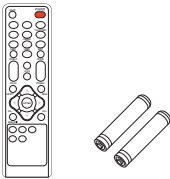

Remote Controller / Battery

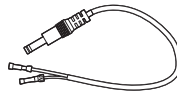

Power Inverter Harness



Machine screw (5EA)
(SMT-1031PV/SMT-1031PVW only)

SEPARATELY SOLD PRODUCT

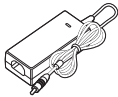
Appearance	Item Name	Description	Model Name
	HPoE Injector	Connects power supply and network	SP0-8315
	Adpater	DC 24V power supply	SPU-60240

The wired LAN hub providing power over the Ethernet (PoE) in accordance with IEEE 802.3bt shall be a UL Listed device with the output evaluated as a Limited Power Source as defined in UL60950-1 or PS2 as defined in UL62368-1.

NAMES AND FUNCTIONS OF EACH PART(SMT-1031PV/SMT-1031PVW)

Front

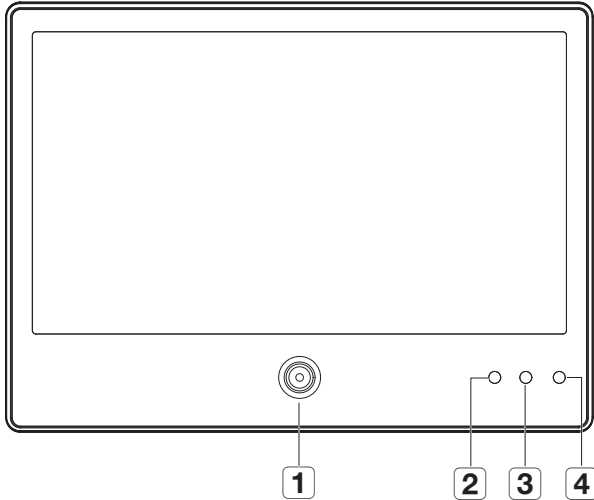

Name		Description of functions
1	Camera Lens	IP camera is installed.
2	ALARM LED	Displayed when an alarm output occurs.
3	LED	Displays the power ON/OFF status. ON – GREEN OFF – RED
4	IR Receiver	Receive IR signal from Remote Controller.

overview

Back

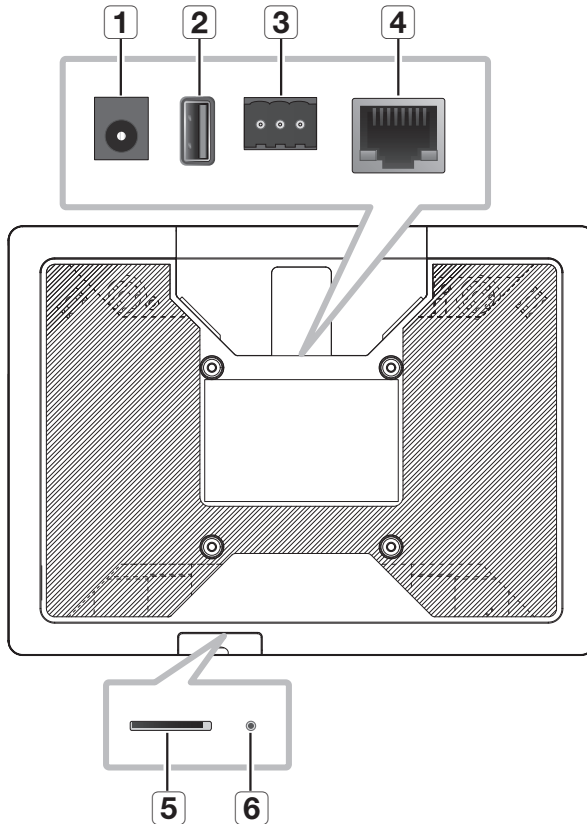

Name		Description of functions
1	DC 24V	This is the DC 24V Power input terminal.
2	USB	Connect the USB Devices for Monitor F/W update.
3	ALARM	ALARM signal input / output
4	HPoE (or PoE+)	Used to connect the HPoE or Ethernet cable for network connection.
5	Micro SD card slot	Compartment for the Micro SD card.
6	RESET	Resets the camera installed in the monitor to its factory default settings. <ul style="list-style-type: none">▪ If you forget your password, use the RESET button.



- Remove the terminal cover by pushing the fixing hook, and then remove the SD card cover by loosening the screws counterclockwise.

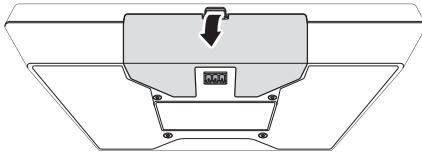

<Top>

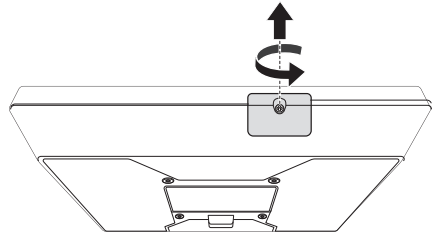

<Bottom>

- This product is intended to be supplied by a UL Listed Power Supply Unit marked "Class 2" or "LPS" or "PS2".
- This product dose not support LLDP.

VESA 75X75 Screw

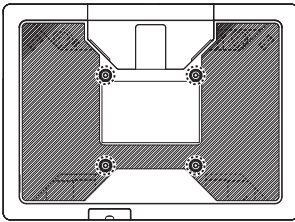

Use the screws provided as accessories.

- Screw specifications : Machine type, PAN(+), M4 x L8



- Use the machine screw, not the tapping screw.

**NAMES AND FUNCTIONS OF EACH PART(SMT-3231PV/SMT-3221PV/
SMT-2731PV/SMT-2721PV)**

Front

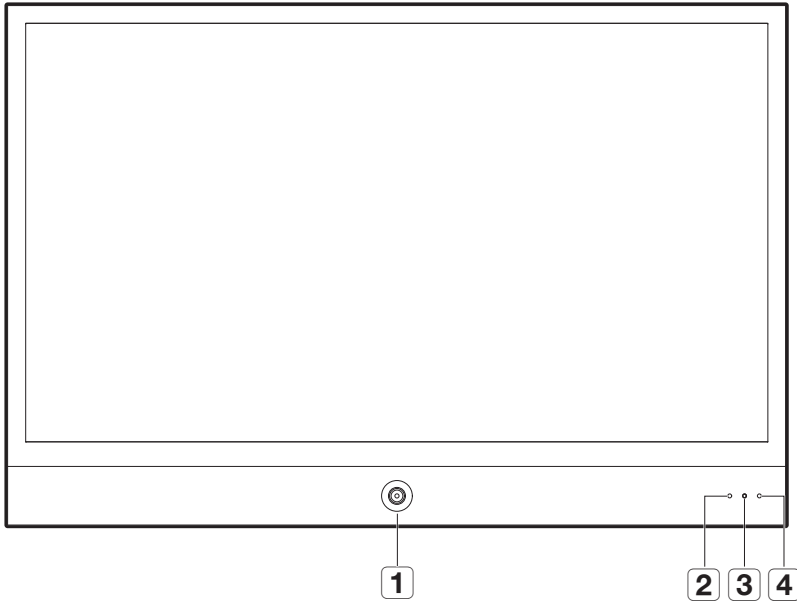

Name		Description of functions
1	Camera Lens	IP camera is installed.
2	ALARM LED	Displayed when an alarm output occurs.
3	LED	Displays the power ON/OFF status. ON – GREEN OFF – RED
4	IR Receiver	Receive IR signal from Remote Controller.

Back

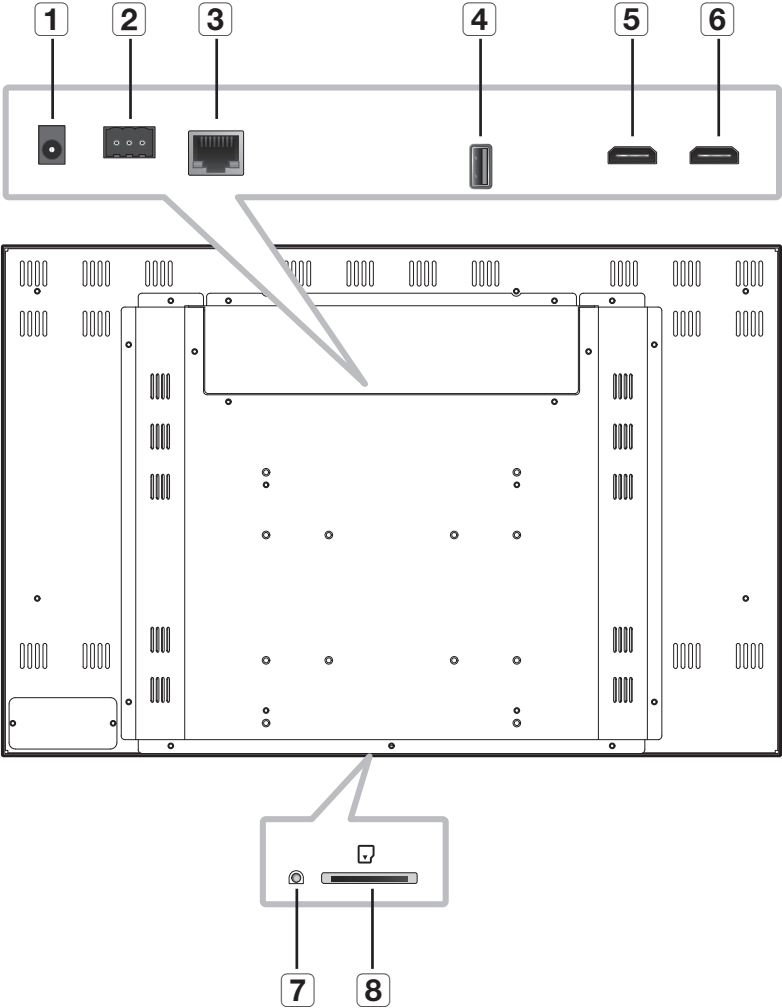

overview

Name		Description of functions
1	DC 24V	This is the DC 24V Power input terminal.
2	ALARM	ALARM signal input / output
3	HPoE	Used to connect the HPoE or Ethernet cable for network connection.
4	USB	Connect the USB Devices for Monitor F/W update.
5	HDMI1 PIP/PBP	HDMI Input terminal for PIP/PBP (PIP/PBP cannot be used on SMT-3221PV and SMT-2721PV models)
6	HDMI2	HDMI Input terminal (not support PIP/PBP in Web viewer)
7	RESET	Resets the camera installed in the monitor to its factory default settings. <ul style="list-style-type: none">▪ If you forget your password, use the RESET button.
8	Micro SD card slot	Compartment for the Micro SD card.



- While the monitor outputs video sources from both HDMI1 and HDMI2, audio source is supported from HDMI1.
- The menu button on the remote control works only when the video (Camera, HDMI1, HDMI2) appears on the monitor's main screen (PIP: large screen, PBP: screen on the left).
- If there is no output signal (black screen) on the monitor, press the **[ENTER]** button on the remote control to check and change the input source type.
- Detach the terminal cover by rotating the fastening screw in a counterclockwise direction to loosen it, then connect the cable.

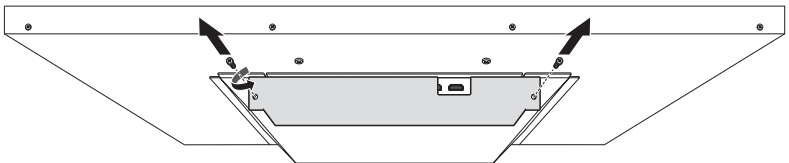

- This product is intended to be supplied by a UL Listed Power Supply Unit marked "Class 2" or "LPS" or "PS2".
- This product does not support LLDP.

REMOTE CONTROL

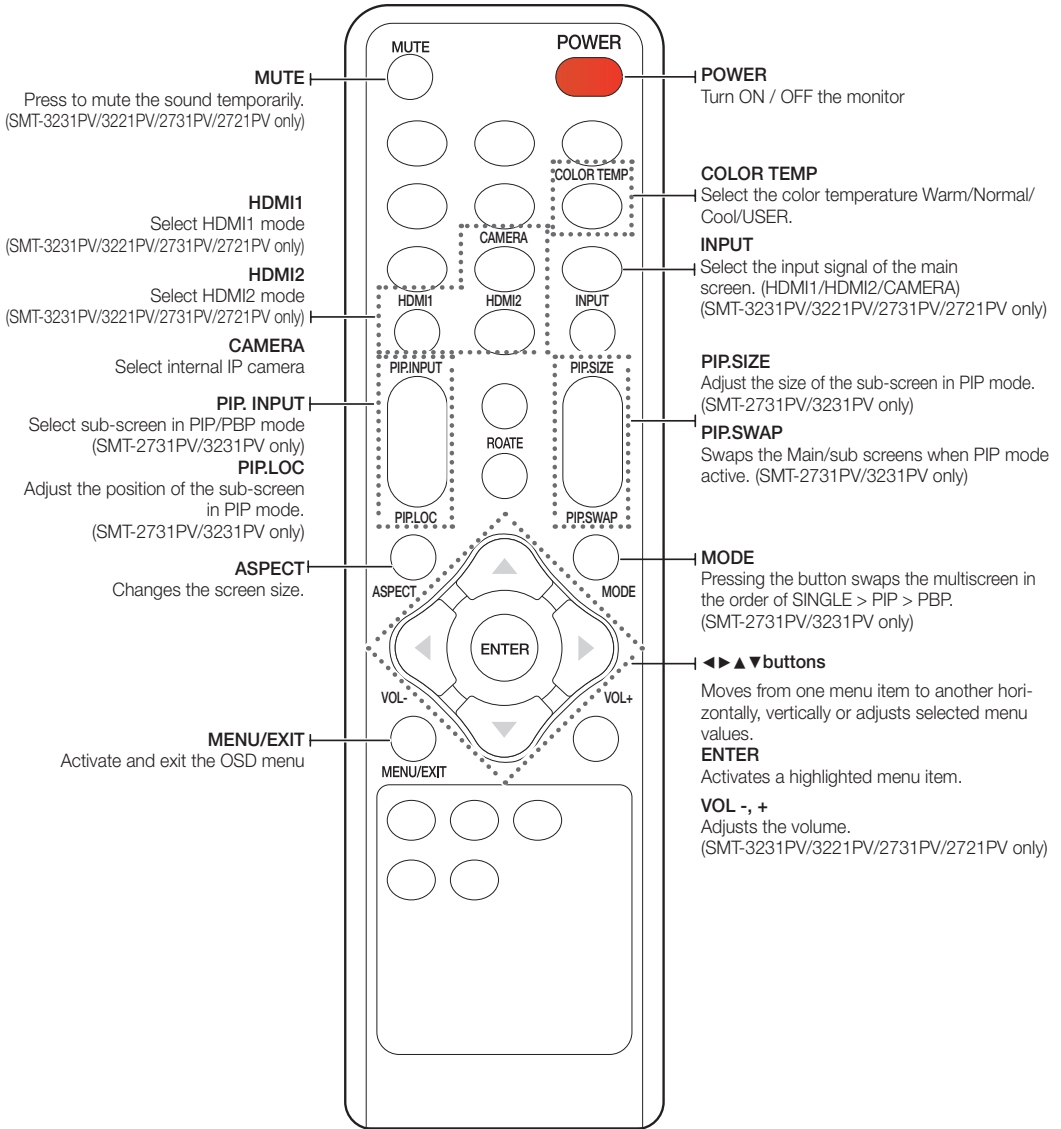

Those buttons without specific description are deprecated buttons.

connecting with other device

THINGS TO CHECK BEFORE CONNECTION

Check before connecting

- ❗ When connecting, refer to the instruction manual of the product to be connected. The number and position of external devices may differ depending on the product.
- Do not connect the power until all connections are complete. Connecting the power supply during connection may damage the product.
- Check the type of terminal behind the product you want to connect.

CONNECTING WITH EXTERNAL DEVICES

HDMI cable connection method

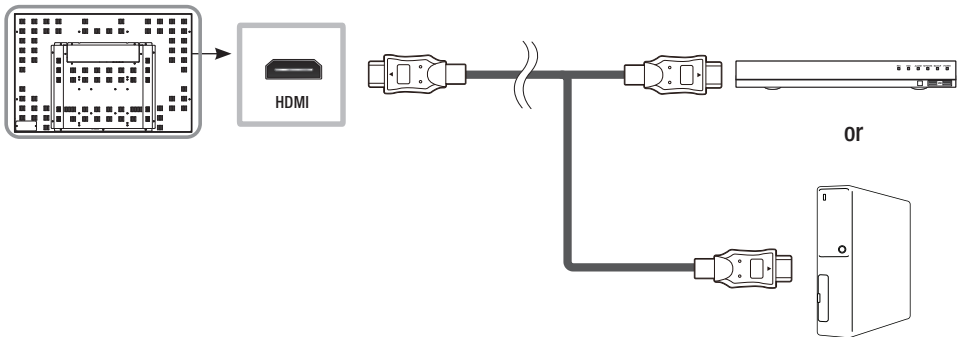

Powering and networking

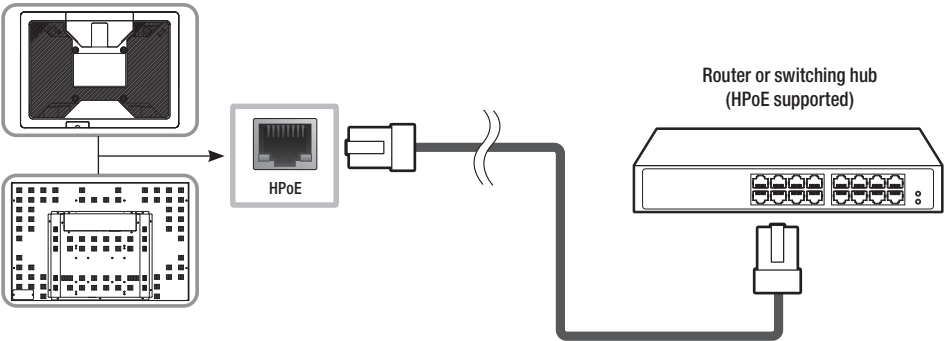

menu settings

OSD MENU SETTING (SMT-1031PV/SMT-1031PVW)

Selecting OSD menu

You can select the OSD menu by pressing the [MENU/EXIT] button on the remote controller.

1. Press the ◀▶ buttons to select the main menu
2. Press the ▲▼ buttons to select the sub-menu, and then press the ENTER.
3. Press the ▲▼/◀▶ buttons to adjust the adjustment value.
4. Press the MENU/EXIT button to exit.

Picture Menu

1. Press the MENU/EXIT button to enter the main menu.
2. Press the ◀▶ button to select <PICTURE>, and then press the ENTER.
3. The PICTURE Menu can be selected from the following 3 modes by pressing ▲▼ buttons.

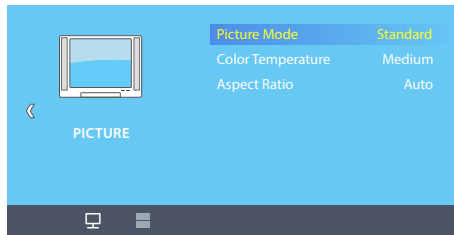

- Picture Mode : Adjust setting of the picture. Picture Mode can select 4 modes as Standard, Soft, User and Vivid. Three of the four modes except for User mode are shipped with fixed values at the time of shipment from the factory.
- Color Temperature : The color temperature can be adjusted and used depending on the monitor color. Color Temperature can select 4 modes as Cool, Medium, Warm and User. Three modes except User mode are factory shipped with factory default values, and each color item (Red, Green, Blue) is selected with the ▲▼ buttons in the User mode only.
- Aspect Ratio : You can select a screen size you want. (Auto/4:3/16:9)

Option Menu

1. Press the **MENU/EXIT** button to enter the main menu.
2. Press the **◀/▶** button to select <OPTION>, and then press the **ENTER**.
3. The Option Menu can be selected from the following 3 modes by pressing **▲/▼** buttons.

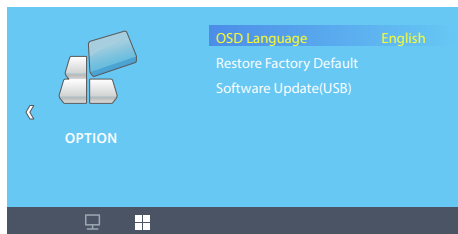

- OSD Language : Select the screen language. (English/Espanol/Francais)
- Restore Factory Default : Resets the monitor to its factory default settings.
- Software Update(USB) : The monitor can be updated by connecting a USB to the USB port.

menu settings

OSD MENU SETTING (SMT-3231PV/SMT-3221PV/SMT-2731PV/SMT-2721PV)

The displayed image may differ depending on the model.

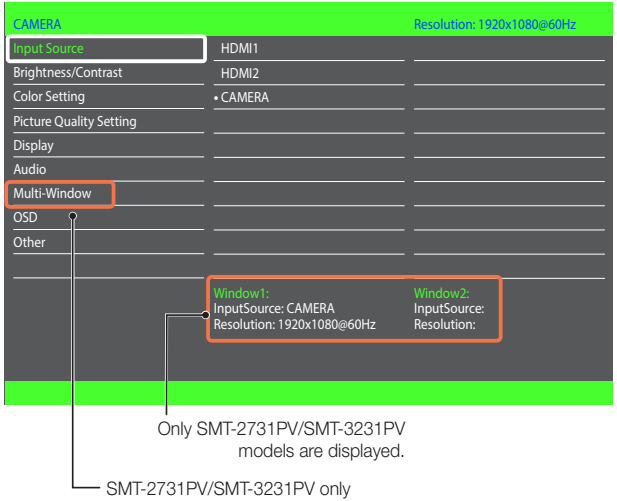

Selecting OSD menu

You can select the OSD menu by pressing the [MENU/EXIT] button on the remote controller.

1. Press the **MENU/EXIT** button to enter the main menu.
2. Press the **▲/▼** buttons to select the main menu, and then press the **ENTER** or **▶** button.
3. Press the **▲/▼** buttons to select the sub-menu, and then press the **ENTER** or **▶** button.
4. Press the **▲/▼** buttons to adjust the adjustment value.
5. Press the **MENU/EXIT** button to exit.

Input Source

1. Press the **MENU/EXIT** button to enter the main menu.
2. Press the **▲/▼** button to select **<Input Source>**, and then press the **ENTER** or **▶** button.

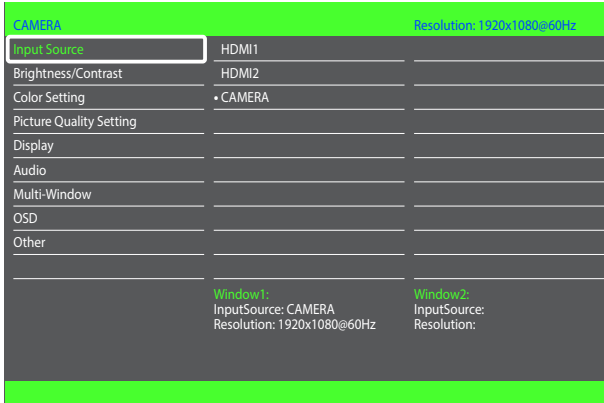

- HDMI 1 : Select external HDMI1 input
- HDMI 2 : Select external HDMI2 input
- CAMERA : Select internal Camera input

Brightness/Contrast

1. Press the **MENU/EXIT** button to enter the main menu.
2. Press the **▲/▼** button to select **<Brightness/Contrast>**, and then press the **ENTER** or **▶** button.



menu settings

- Brightness : Adjusts the brightness of the screen. (Adjust 0 ~ 100)
- Contrast : Adjusts the difference in brightness between the object and the environment. (Adjust 0 ~ 100)

Color Setting

1. Press the **MENU/EXIT** button to enter the main menu.
2. Press the **▲/▼** button to select **<Color Setting>**, and then press the **ENTER** or **▶** button.

CAMERA		Resolution: 1920x1080@60Hz
Input Source	Gamma	2.2
Brightness/Contrast	Picture Mode	Standard
Color Setting	Color Temperature	Normal
Picture Quality Setting	Hue	50
Display	Saturation	50
Audio		
Multi-Window		
OSD		
Other		
	Window1: InputSource: CAMERA Resolution: 1920x1080@60Hz	Window2: InputSource: Resolution:

- Gamma : Adjust the mid-range brightness (Gamma) of the screen.(1.8/2.0/2.2/2.4/2.6)
- Picture Mode : Select a screen mode appropriate for your viewing environment. (Standard/Photo/ Movie/Game)
- Color Temp. : The color temperature can be adjusted and used depending on the monitor color. (Warm/Normal/Cool/USER)
- Hue : Adjusts the color of the screen. (Adjust 0 ~ 100)
- Saturation : Adjusts the saturation of the screen. (Adjust 0 ~ 100)

Picture Quality Setting

1. Press the **MENU/EXIT** button to enter the main menu.
2. Press the **▲/▼** button to select **<Picture Quality Setting>**, and then press the **ENTER** or **▶** button.

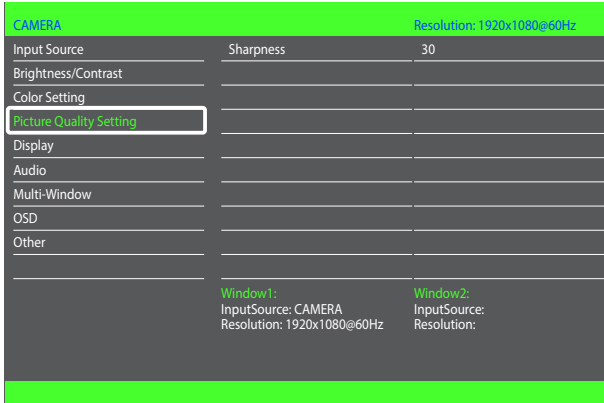

- Sharpness : Adjusts the sharpness of the screen. (Adjust 0 ~ 100)

Display

1. Press the **MENU/EXIT** button to enter the main menu.
2. Press the **▲/▼** button to select **<Display>**, and then press the **ENTER** or **▶** button.

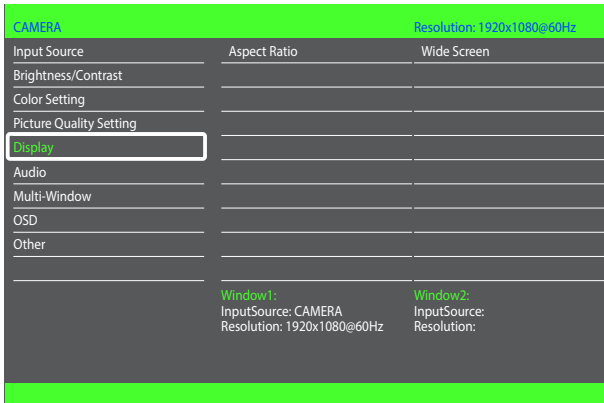

- Aspect Ratio : You can select a screen size you want. (Wide Screen/4:3/1:1/Auto)

menu settings

Audio

1. Press the **MENU/EXIT** button to enter the main menu.
2. Press the **▲/▼** button to select **<Audio>**, and then press the **ENTER** or **▶** button.



The screenshot shows a menu interface with a green header bar. The header contains 'CAMERA' on the left and 'Resolution: 1920x1080@60Hz' on the right. The main menu items are listed in a table with three columns. The 'Audio' item is highlighted with a white border. At the bottom, there are two window status indicators: 'Window1: InputSource: CAMERA Resolution: 1920x1080@60Hz' and 'Window2: InputSource: Resolution:'.

CAMERA		Resolution: 1920x1080@60Hz
Input Source	Mute	off
Brightness/Contrast	Volume	50
Color Setting		
Picture Quality Setting		
Display		
Audio		
Multi-Window		
OSD		
Other		
Window1: InputSource: CAMERA Resolution: 1920x1080@60Hz		Window2: InputSource: Resolution:

- Mute : You can set whether to use the mute function. (On/Off)
- Volume : You can adjust the volume. (Adjust 0 ~ 100)

Multi-Window (SMT-3221PV/SMT-2721PV only)

1. Press the **MENU/EXIT** button to enter the main menu.
2. Press the **▲/▼** button to select **<Multi-Window>**, and then press the **ENTER** or **▶** button.

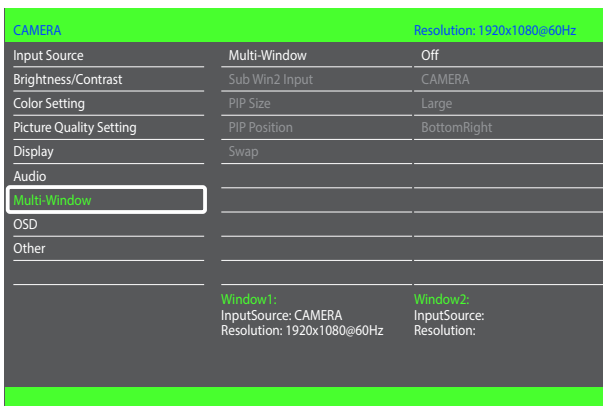

The screenshot shows a menu interface with a green header bar. The header contains 'CAMERA' on the left and 'Resolution: 1920x1080@60Hz' on the right. The main menu items are listed in a table with three columns. The 'Multi-Window' item is highlighted with a white border. At the bottom, there are two window status indicators: 'Window1: InputSource: CAMERA Resolution: 1920x1080@60Hz' and 'Window2: InputSource: Resolution:'.

CAMERA		Resolution: 1920x1080@60Hz
Input Source	Multi-Window	Off
Brightness/Contrast	Sub Win2 Input	CAMERA
Color Setting	PIP Size	Large
Picture Quality Setting	PIP Position	BottomRight
Display	Swap	
Audio		
Multi-Window		
OSD		
Other		
Window1: InputSource: CAMERA Resolution: 1920x1080@60Hz		Window2: InputSource: Resolution:

- Multi-Window : You can select Picture in Picture (PIP) or Picture by Picture (PBP) mode. (Off/PIP Mode/PBP 2Win)
- Sub Win2 Input : Displays the currently output Sub Win2 Input. (HDMI1/HDMI2/CAMERA)
- PIP Size : You can adjust the size of the sub-screen in PIP mode. (Small/Medium/Large)
- PIP Position : You can adjust the position of the sub-screen in PIP mode. (TopRight/TopLeft/BottomRight/BottomLeft)
- Swap : You can switch between the main screen and sub-screen in PIP or PBP mode.

OSD

1. Press the **MENU/EXIT** button to enter the main menu.
2. Press the **▲/▼** button to select **<OSD>**, and then press the **ENTER** or **▶** button.

CAMERA		Resolution: 1920x1080@60Hz
Input Source	Language	English
Brightness/Contrast	OSD H-Position	50
Color Setting	OSD V-Position	50
Picture Quality Setting	OSD Transparency	50
Display	OSD Time Out	20
Audio	OSD Rotatio	Normal
Multi-Window		
OSD		
Other		
	Window1: InputSource: CAMERA Resolution: 1920x1080@60Hz	Window2: InputSource: Resolution:

- Language : Select the screen language. (English/Español/Français)
- OSD H-Position : Moves the screen of the menu to the left or right. (Adjust 0 ~ 100)
- OSD V-Position : Moves the screen position of the menu up or down. (Adjust 0 ~ 100)
- OSD Transparency : Sets the transparency of the menu screen. (Adjust 0 ~ 100)
- OSD Time Out : The menu screen disappears if the screen does not change for a certain period of time. (Adjust 0 ~ 100)
- OSD Rotation : You can rotate the menu screen. (Normal/90/180/270)

menu settings

Other

1. Press the **MENU/EXIT** button to enter the main menu.
2. Press the **▲/▼** button to select **<Other>**, and then press the **ENTER** or **▶** button.

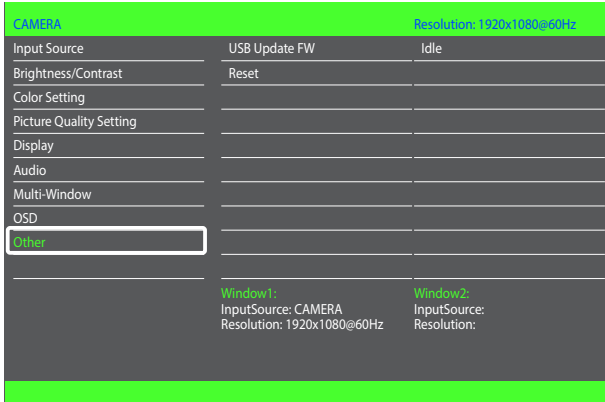

- USB Update FW : The monitor can be updated by connecting a USB to the USB port. (Idle/Writing)
- Reset : Resets the monitor settings to default.

network connection and setup & webviewer

You can set up the network settings according to your network configurations.

CONNECTING THE PVM DIRECTLY TO LOCAL AREA NETWORKING

Connecting to the PVM from a local PC in the LAN

1. Launch an Internet browser on the local PC.
2. Enter the IP address of the PVM in the address bar of the browser.

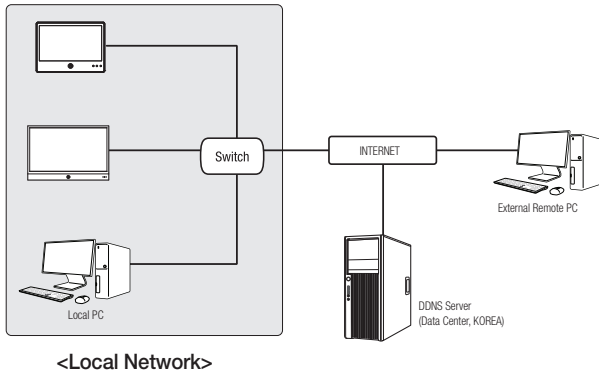

- A remote PC in an external Internet out of the LAN network may not be able to connect to the PVM installed in the intranet if the port-forwarding is not properly set or a firewall is set. In this case, to resolve the problem, contact your network administrator.
- By factory default, the IP address will be assigned from the DHCP server automatically. If there is no DHCP server available, the IP address will be set to 192.168.1.100. To change the IP address, use the Device Manager. For further details on Device Manager use, refer to "**Using Device Manager**". (Page 25)

network connection and setup & webviewer

CONNECTING THE PVM DIRECTLY TO A DHCP BASED DSL/CABLE MODEM

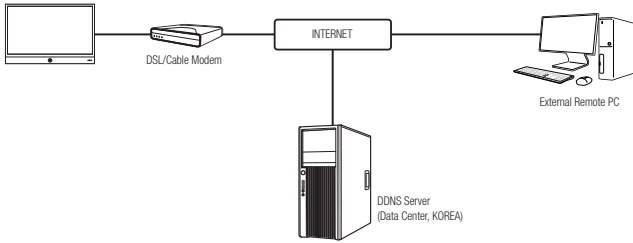

1. Connect the user PC directly with the PVM.
2. Run the Device Manager and change the IP address of the PVM so that you can use the web browser on your desktop to connect to the Internet.
3. Use the Internet browser to connect to the web viewer.
4. Move to **[Setup]** page.
5. Move to **[Network]** – **[DDNS]** and configure the DDNS settings.
6. Move to **[Basic]** – **[IP & Port]**, and set the IP type to **[DHCP]**.
7. Connect the PVM, which was removed from your PC, directly to the modem.
8. Restart the camera.



- For information on how to set DDNS, refer to the online help of Web Viewer.
- For information on how to set the IP format, refer to the online help of Web Viewer.

USING DEVICE MANAGER



- Device manager program can be downloaded from <Support>-<Online Tools> menu at Hanwha Vision website (<https://www.HanwhaVision.com>).
- More instructions of Device Manager can be found at <Help> menu of the main page.

AUTOMATICALLY SEARCHING CAMERA

If a camera is connected to the same network of the PC where device manager is installed, you can find network camera by using search function.

- Click <Search> at the main page of device manager.
- Check the camera from the list.
 - Check MAC address at the sticker attached to the camera.

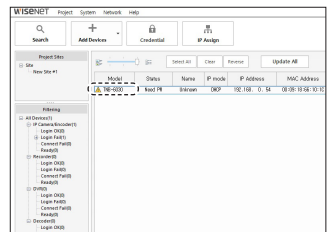

CONFIGURING IP ADDRESS

If you want to change camera network setting, <Login OK> sign must be displayed at <Status>. Click <Authentication> at the main page to log in.

Configuring Static IP

Manually insert and configure IP address & port information.

- Click the camera from the list that you want to change the IP setting.
- Click <IP Assign> at the main page of device manager.
- Select <Assign the following IP address>.
 - IP information of the camera will be displayed as previously set.
- Fill in IP & Port related categories.

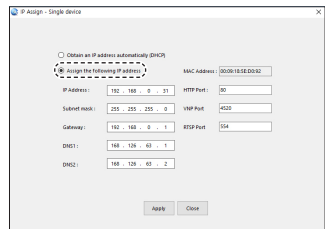

If not using a Broadband Router

For setting <IP Address>, <Subnet Mask>, and <Gateway>, contact your network administrator.

- HTTP Port : Used to access the camera using the Internet browser, defaulted to 80.
- RTSP Port : A port that controls real-time streaming. The initial value is 554.

network connection and setup & webviewer

If using a Broadband Router

- IP Address : Enter an address falling in the IP range provided by the Broadband Router.
ex) 192.168.1.2~254, 192.168.0.2~254, 192.168.XXX.2~254
- Subnet Mask : The <Subnet Mask> of the Broadband Router will be the <Subnet Mask> of the camera.
- Gateway : The <Local IP Address> of the Broadband Router will be the <Gateway> of the camera.

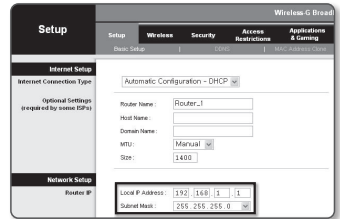

- The settings may differ depending on the connected Broadband Router model. For more information, refer to the user manual of the applicable router.
- For more information about port forwarding of the broadband router, refer to "**Port Range Forward (Port Mapping) Setup**". (Page 28)

If the Broadband Router has more than one camera connected

Configure the IP related settings and the Port related settings distinctly with each other.

ex)

Category		Camera #1	Camera #2
IP related settings	IP Address	192.168.1.100	192.168.1.101
	Subnet Mask	255.255.255.0	255.255.255.0
	Gateway	192.168.1.1	192.168.1.1
Port related settings	HTTP Port	8080	8081
	RTSP Port	554	555



- If the <HTTP Port> is set other than 80, you must provide the <Port> number in the address bar of the Internet browser before you can access the camera.
ex) http://IP address : HTTP Port
http://192.168.1.100:8080

5. Click [Apply] Button.
6. If the success message is displayed, click [OK].

Configuring Dynamic IP

Receive IP address from DHCP

- Example of the Dynamic IP environment
 - If a Broadband Router, with cameras connected, is assigned an IP address by the DHCP server
 - If connecting the camera directly to modem using the DHCP protocols
 - If IPs are assigned by the internal DHCP server via the LAN

1. Click the camera from the list that you want to change the IP setting.
2. Click **<IP Assign>** at the main page of device manager.
3. Select **<Obtain an IP address automatically (DHCP)>**.
4. Click **[Apply]** button.
5. If the success message is displayed, click **[OK]**.

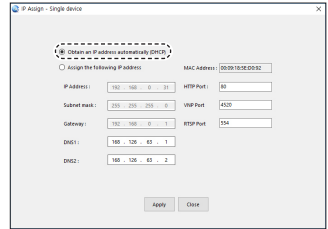

MANUALLY REGISTERING CAMERA

If the camera cannot be found using search function, the camera can be registered remotely by manually inserting IP information, if the camera is connected to external network.

1. Click **<Add Devices>** - **<Manually Add Device>** at the main page of device manager.
2. Insert the range of IP address that you search.
3. Select the **<Model Name>** of the camera that you register, and insert HTTP port, ID, and password.
4. Click **[Register]** button.
5. Check if camera is registered.
 - Check MAC address at the sticker attached to the camera.

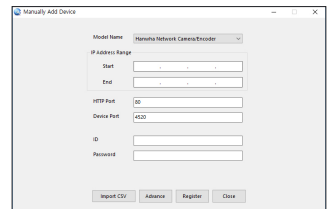

network connection and setup & webviewer

AUTOMATICALLY CONFIGURING IP

1. Click the camera from the list that you want to automatically configure the IP.
2. Click < + > at the main page of device manager.
 - Equipment Setting menu appears.
3. At the menu, click <Auto IP Configure>.
4. Click [Close] button.

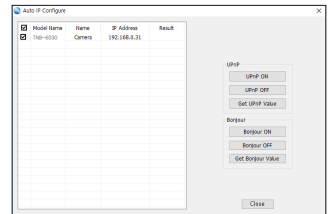

PORT RANGE FORWARD (PORT MAPPING) SETUP

If you have installed a Broadband Router with a camera connected, you must set the port range forwarding on the Broadband Router so that a remote PC can access the camera in it.

Manual Port Range Forwarding

1. From the Setup menu of the Broadband Router, select <Applications & Gaming> - <Port Range Forward>. For setting the port range forward for a third-party Broadband Router, refer to the user guide of that Broadband Router.
2. Select <TCP> and <UDP Port> for each connected camera to the Broadband Router. The number of each port to be configured to the IP router should be set according to the port number designated in <Setup> - <Basic> - <IP & Port> on the camera web viewer.
3. When done, click [Save Settings]. Your settings will be saved.

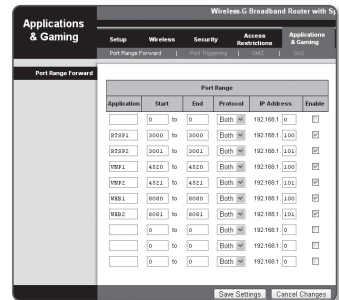

- Port forwarding setting is an example of setting CISCO IP router.
- The settings may differ depending on the connected Broadband Router model. For more information, refer to the user manual of the applicable router.

Setting up Port Range Forward for several network cameras

- You can set a rule of Port Forwarding on the Broadband Router device through its configuration web page.
- A user can change each port using the camera setting screen.

When Camera1 and Camera2 are connected to a router :

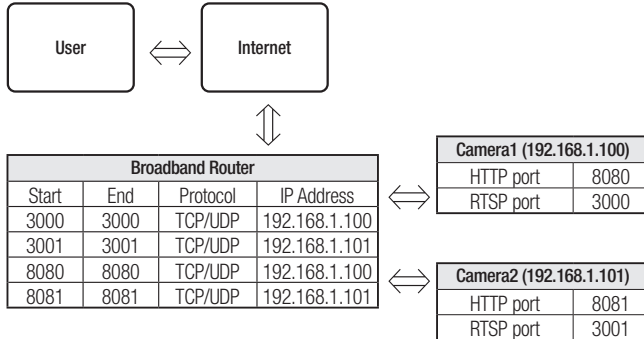

- Port forwarding can be done without additional router setup if the router supports the UPnP (Universal Plug and Play) function.
After connecting the network camera, select the checkbox from the menu <Quick connect> in <DDNS> in "Settings -> Network -> DDNS".

network connection and setup & webviewer

CONNECTING TO THE CAMERA FROM A SHARED LOCAL PC

1. Run device manager.
It will scan for connected cameras and display them as a list.
2. Double-click a camera to access.
The Internet browser starts and connects to the camera.



- Access to the camera can also be gained by typing the camera's IP address in the address bar of the Internet browser.

CONNECTING TO THE CAMERA FROM A REMOTE PC VIA THE INTERNET

On a remote computer that is not in the Broadband Router's network cluster is not allowed, users can access cameras within a Broadband Router's network by using the camera's DDNS URL.

1. Before you can access a camera in the Broadband Router network, you should have set the port range forward for the Broadband Router.
2. From the remote PC, launch the Internet browser and type the DDNS URL address of the camera, or the IP address of the Broadband Router in the address bar.
ex) <http://ddns.hanwha-security.com/ID>



- To use DDNS, sign up at the DDNS homepage (<http://ddns.hanwha-security.com>) and register the product at **[My DDNS]>[Register Product]**.

CONNECTING TO THE CAMERA

Normally, you would

1. Launch the Internet browser.
2. Type the IP address of the camera in the address bar.
ex) • IP address (IPv4) : 192.168.1.100 → <http://192.168.1.100>
- the Login dialog should appear.
• IP address (IPv6) : 2001:230:abcd:ffff:0000:0000:ffff:1111
→ [http://\[2001:230:abcd:ffff:0000:0000:ffff:1111\]](http://[2001:230:abcd:ffff:0000:0000:ffff:1111]) - the Login dialog should appear.

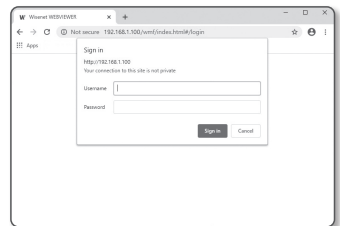

If the HTTP port is other than 80

1. Launch the Internet browser.

Type the IP address and HTTP port number of the camera in the address bar.

ex) IP address : 192.168.1.100:HTTP Port number(8080)

→ <http://192.168.1.100:8080> - the Login dialog should appear.

Using URL

1. Launch the Internet browser.
2. Type the DDNS URL of the camera in the address bar.
ex) URL address : <http://ddns.hanwha-security.com/ID>
- the Login dialog should appear.



- Network connection is disabled in the LAN only environment.

Connecting via UPnP

1. Run the client or operating system in support of the UPnP protocol.
2. Click the camera name for search.
In the Windows operating system, click the camera name searched from the network menu.
 - The login window is displayed.

Connecting via Bonjour

1. Run the client or operating system in support of the Bonjour protocol.
2. Click the camera name for search.
In the Mac operating system, click the camera name searched from the Bonjour tab of Safari.
 - The login window is displayed.

To check the DDNS address

If the camera is connected directly to a DHCP-based cable modem or DSL modem, the IP address will change each time it tries to connect to the ISP (the company you subscribed to).

If this is the case, you will not be informed of the IP address changed by DDNS.

Once you register a dynamic IP-based device with the DDNS server, you can easily check the changed IP when you try to access the device.

To register your device to the <DDNS> server, visit <http://ddns.hanwha-security.com> and register your device first, and then set the Web Viewer's <Network> - <DDNS> to <DDNS>, as well as providing <Product ID> that had been used for DDNS registration.

network connection and setup & webviewer

PASSWORD SETTING

When you access the product for the first time, you must register the login password.



- For a new password with 8 to 9 characters, you must use at least 3 of the following: uppercase/lowercase letters, numbers and special characters. For a password with 10 characters or longer, you must use at least 2 types of those mentioned. (support up to 64 characters)

- Special characters that are allowed :
~!@#%&^&(')_-+={ }|] ; : " < > , . ? /

- Space is not allowed for password.
- For higher security, you are not recommended to repeat the same characters or consecutive keyboard inputs for your passwords.
- If you lost your password, you can press the **[RESET]** button to initialize the product. So, don't lose your password by using a memo pad or memorizing it.

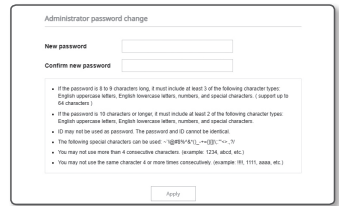

LOGIN

Whenever you access the camera, the login window appears. Enter the User ID and password to access the camera.

- Enter **"admin"** in the **<User name>** input box. The administrator ID, **"admin"**, is fixed and can not be changed.
- Enter the password in the **<Password>** input field.
- Click **[Sign in]**.
If you have logged in successfully, you will the Live Viewer screen.

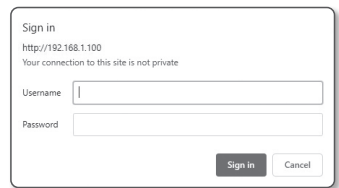

- When you access the camera web viewer, pay special attention to the security by checking whether the image data is encrypted.



- You will experience the best video quality if the screen size is 100%. Reducing the ratio may cut the image on the borders.

CAMERA WEB VIEWER SETUP

- Click the **[Setup (⚙)]** icon.
- The Settings window appears.
- You can configure settings for the camera's basic information, video, audio, network, event, analysis, and system over the network.
- Click **<Help (?)>** to view detailed descriptions of each function.

setup screen

SETUP

On the network, you can set up basic information on the camera, video and audio, network, events, people counting, heatmap and system.

1. On the live screen, click the **[Setup (⚙)]** button.
2. The Setup screen appears.



HALLWAY VIEW

To use the monitor vertically, rotate the screen by using the Hallway view feature.

1. From the Setup menu, select the **<Video & Audio>** tab.
2. Click **<Video setup>**.
 - Hallway view : By rotating the camera image in an environment where a general camera cannot properly monitor the narrow aisles or hallways, you can magnify the vertical monitoring areas. You can rotate the video 0, 90 or 270 degrees.

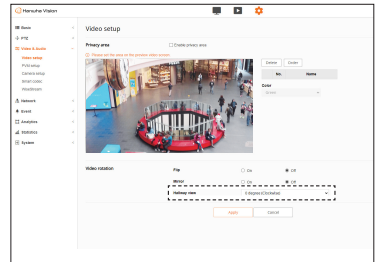

- When you set **<Hallway view>**, the web browser will close automatically. You will need to reconnect to the web viewer.
- When changing the angle of hallway view, the values set in the default angle (0 degrees) are canceled, so set the hallway view angle first.

setup screen

CREATING A TEXT OVERLAY

1. From the Setup menu, select the <Video & Audio> tab.
2. Click <Camera setup>.

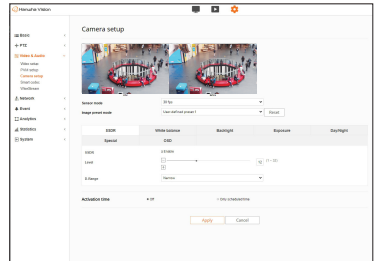

3. Select <OSD>.

 - The default setting for OSD is "Recording in Progress."

4. Select each item and set it properly.

 - Camera title : It specifies the name of the camera to be displayed on the screen. Select the <Enable> check box to add a camera name.
 - Add : Click the <Add> button and you can add a total of 5 lines, 21 characters per line and a total of 105 characters.
 - Preview : Click the <Preview> button to check the name of camera that will be displayed on the screen.

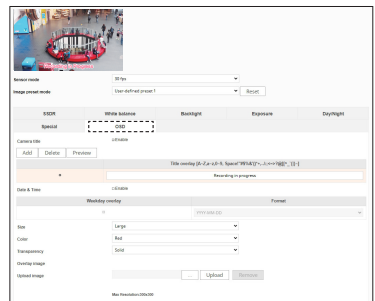

- Date & time : Set the time display and date formats on the screen.
- Weekday overlay : Specify the use of date display date on the screen.
- Size : Sets the size of OSD to small/medium/large.
- Color : Sets the color of the OSD to White/Red/Blue/Green/Black/Ggray.
- Transparency : Sets the transparency of OSD to Solid / Low / Middle / High.
- Overlay image : You can display the image you want on the screen.
- Upload image : [...] button can be clicked to search files in bitmap format. Click the [Upload] button to upload image files. To delete image files applied to the screen, click the [Remove] button.



- A position-adjustable item (Camera title, Date & Time, Overlay image) may not be displayed normally if it overlaps with another fixed OSD item.
- Multilingual other than English: Input only in the selected language is available.

PVM SETUP

Monitor setup

You can control the power of the PVM or set the monitor's screen mode.

1. From the Setup menu, select the <Video & Audio setup> tab.
2. Click <PVM setup>.
3. Click <Monitor setup>.
 - Remote control : Not to use the remote control when controlling the monitor, uncheck <Enable>.
 - Monitor power : You can turn on and off the monitor from the web viewer. Click the **[ON]** button to turn on the monitor, or click the **[Off]** button to turn off the monitor.
 - Screen mode : You can set the screen mode.(SMT-2731PV/SMT-3231PV only)
 - Single : It outputs the image from the built-in camera.
 - PIP : You can select the PIP (Picture-in-picture) mode. You can configure detailed settings for the main and secondary screens.
 - PBP : You can select the PBP (Picture-by-picture) mode.

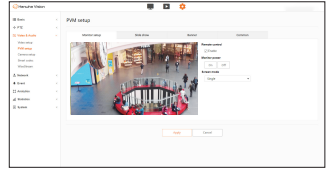

Banner

You can display banners on the live video.

1. From the Setup menu, select the <Video & Audio setup> tab.
2. Click <PVM setup>.
3. Click <Banner>.
4. Click the [...] button to select the PC folder containing the Image files to be uploaded.
5. Select an image to upload and click <Install>.

The files uploaded in <Banner list> are displayed in a list.

 - You can upload up to 2 banner images.
 - For the file name, use only English letters, numbers, and a period. The file with special characters cannot be uploaded.
 - Image files can be uploaded only in JPG, PNG or BMP formats.
 - The banners are positioned at the top of the screen by default.
 - You can move a banner up and down by dragging with the mouse.
6. Checking the Enable box runs the feature.
 - The banner feature works only on the live video.

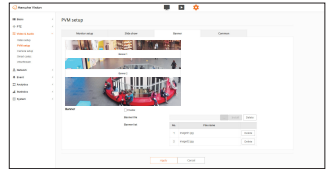

setup screen

Common

You can configure the detailed Public View Monitor (PVM) settings.

1. From the Setup menu, select the **<Video & Audio setup>** tab.
2. Click **<PVM setup>**.
3. Click **<Common>**.
 - Face detection area color : You can set the border color of the detection area while detecting faces. The **<Face detection area color>** setting is applied only when **<Object detection>** feature is enabled.
 - Monitor power schedule: You can set the monitor to turn on at the specified time.
 - If you select **<Only scheduled time>**, the weekly timetable appears: you can set the operation time by clicking or dragging the mouse on the timetable. The schedule repeatedly runs on the specified day of the week and time.

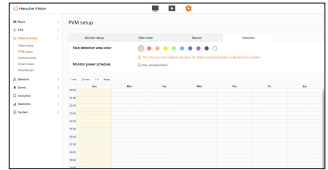

Slide show setup

You can play a slide show on the PVM.

If you enable the slider show, the set still image continues to appear on the monitor.

If you enable **<Motion detection>** feature in the **<Analytics>** menu, the camera's live video appears instead of the still image whenever motion is detected by the camera.

1. From the Setup menu, select the **<Video & Audio setup>** tab.
2. Click **<PVM setup>**.
3. Click **<Slide show>**.
4. Set Image dwell time/Live streaming time.
5. Click the [...] button to select the PC folder containing the Image files to be uploaded.
6. Select an image to upload and click **<Install>**.
The files uploaded in **<image list>** are displayed in a list.
 - You can upload up to 10 image files to be used for slide show.
 - For the file name, use only English letters, numbers, and a period. The file with special characters cannot be uploaded.
 - Image files can be uploaded only in JPG, PNG or BMP formats.
 - During the process, do not power off camera or move to another page because doing so will make the process to fail.
7. Checking the Enable box runs the feature.

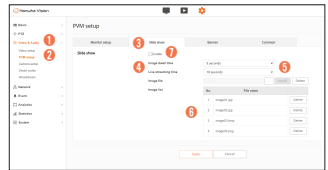

Motion detection menu setup

1. From the Setup menu, select the **<Analytic>** tab.
2. Click **<Motion detection>**.
3. Set the desired detection area/sensitivity and others.
4. If motion is detected, it changes from Still image to Live video.

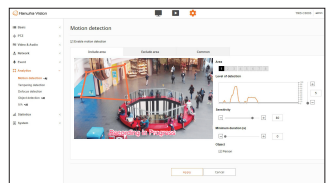

SETTING ALARM INPUT

Connecting to the I/O port box

Connect the Alarm I/O cable to the corresponding port of the port box.

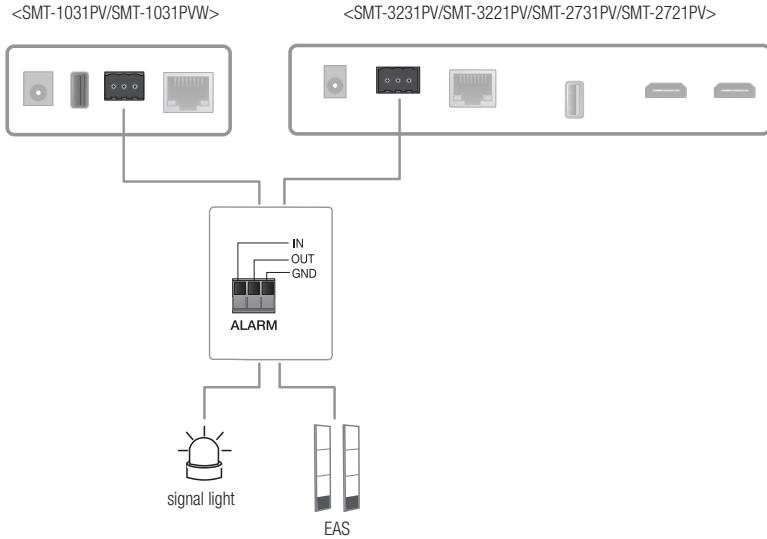

- ALARM-IN : Used to connect the alarm input sensor.
- ALARM-OUT : Used to connect the alarm output signal.
- GND : Common port for alarm in/output signal.



- If devices (e.g., flashing light and siren) that exceed the voltage and current specifications are connected by using the open collector method, it may cause malfunction. Refer to the **“Alarm Out Wiring Diagram”** when connecting devices that exceed the voltage and current specifications.

setup screen

Alarm In Wiring Diagram

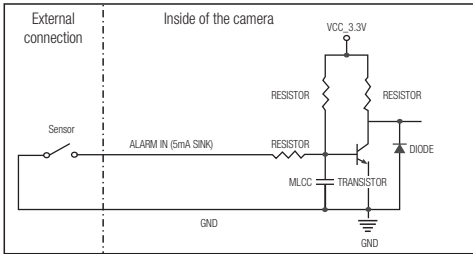

Alarm Out Wiring Diagram

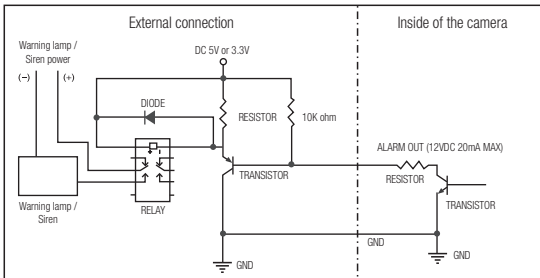

Alarm I/O

An alarm input event occurs if an alarm is input. You can set the alarm input method that recognizes an alarm input and which actions the camera operates when an alarm event occurs. Also, you can set how to control the alarm when users output the alarm directly or when the alarm is being output due to an event occurring.

1. From the Setup menu, select the **<Event>** tab.
2. Click **<Alarm I/O>**.

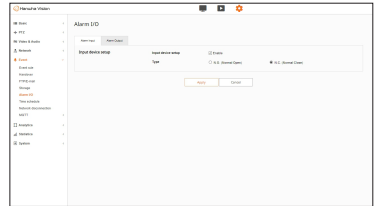

Alarm Input setup

3. Select **<Alarm Input>**.
 - Input device setup : To use an alarm input device, select [Enable].
 - Type : Select the alarm input type.
 - N.O. (Normal Open) : It is normally open, but if it is closed, an alarm will be triggered.
 - N.C. (Normal Close) : It is normally closed, but if it is open, an alarm will be triggered.

Alarm Output setup

3. Select **<Alarm Output>**.
 - Type : Selects the alarm output type.
 - N.O. (Normal Open) : The alarm output sensor is open by default and when it is closed, an alarm is outputted.
 - N.C. (Normal Close) : The alarm output sensor is closed by default and when it is open, an alarm is outputted.
 - Mode : Sets the control type when an alarm is outputted.
 - Pulse : An alarm is outputted for the time set in **<Duration>** and the alarm turns off automatically.
 - Active/Inactive : When you press the alarm output button on the monitoring screen, an alarm will turn on; when you press the button again, the alarm will turn off.
 - Duration : Sets the alarm output time when **<Pulse>** is selected in **<Mode>**
4. When done, click **[Apply]**.

setup screen

Adding event rules

You can register detailed event rules of when the camera will perform a specific action when a specific event occurs.

1. From the Setup menu, select the **<Event>** tab.
2. Click **<Event rules>**.
3. Click the **[Add]** button.
4. In **<Rule name>**, enter the desired name of event rules.
Up to 15 characters can be entered.

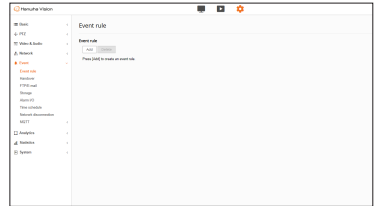

5. After selecting **<+Add>** in the **<Event trigger>** panel, select both the channel number where the event occurs and the trigger type to create the event.
6. In the **<Event action>** panel, select the desired event action to perform when an event occurs.
 - Alarm output: To output an alarm when an event occurs, select the output time. If **<Always>** is selected, the alarm will continue to be output until it is stopped by the user. To disable the alarm when an event occurs, select **<Off>**. Detailed alarm output settings can be configured in **<Event>**→**<Alarm I/O>**.
 - E-mail : Specify the use of email transfer in the alarm input setup.
 - FTP : Specify the use of FTP transfer in the alarm input setup.
 - Record : You can set up the alarm to record to a Micro SD card or an NAS when operating.
 - PVM alarm : Set how the PVM (Public View Monitor) runs when an event occurs. If you do not want any alarms to go off even when an event occurs, select **<Off>**. Select **<LED flashing>** to flash LED lights mounted on the PVM; select **<Beep>** to emit a beepsound; and select **<Beep & LED flashing>** to emit a beep sound and flash LED lightssimultaneously.
 - Activation time : Configure the schedule of event action from **<Activation time>**. In other words, an event action is performed only at the set time when an event occurs.
 - Duration: Set up the minimum time for the event to occur before performing the action.
7. When done, click **[Apply]**.



- Even if you select a trigger type to occur an event, while the feature is disabled using the camera menu, **<Invalid>** appears in the event rules list.

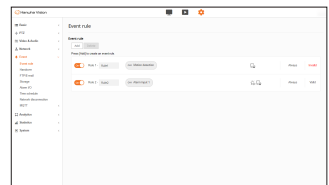

MECHANICAL

SMT-1031PV/SMT-1031PVW

unit : mm

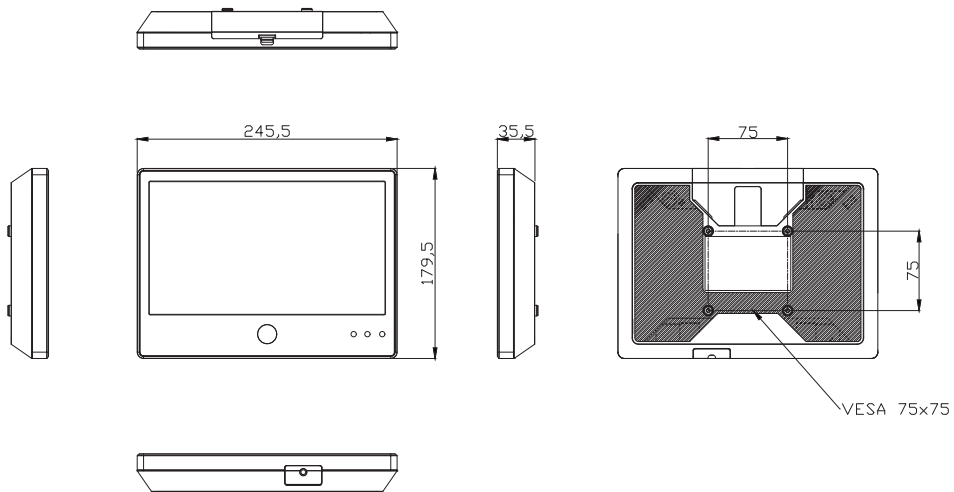

- Since the use of a screw longer than the standard size may cause a problem, VESA standard screws recommended.

SMT-2731PV/SMT-2721PV

unit : mm

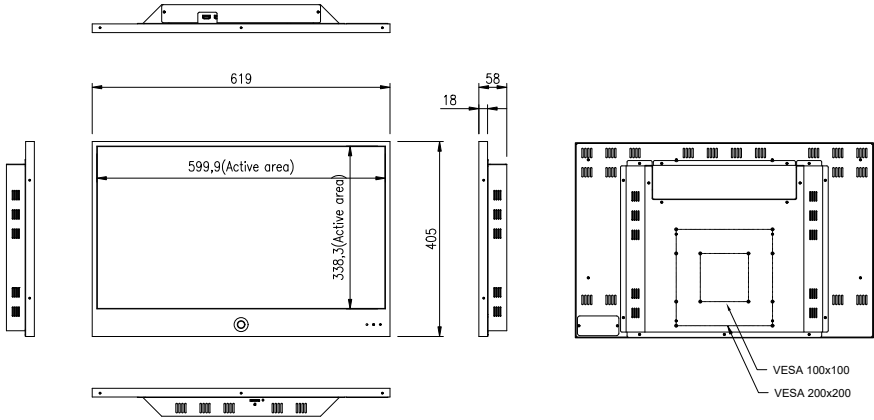

- Since the use of a screw longer than the standard size may cause a problem, VESA standard screws recommended.

SMT-3231PV/SMT-3221PV

unit : mm

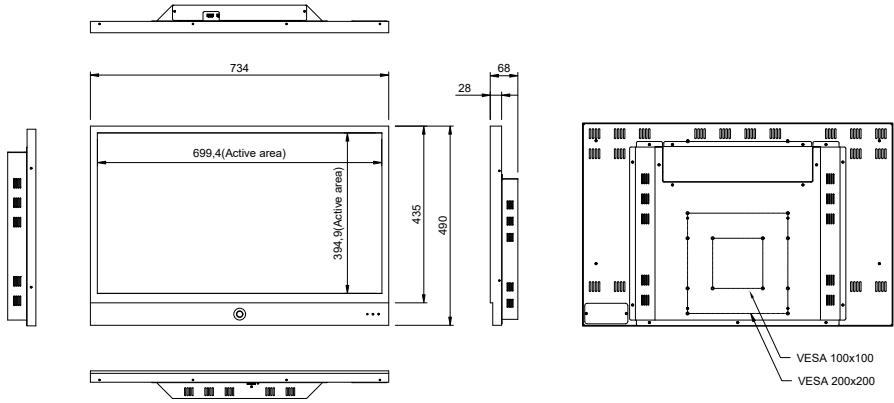

- Since the use of a screw longer than the standard size may cause a problem, VESA standard screws recommended.

TROUBLESHOOTING

When the following troubles are occurred, follow the trouble shooting.
Before contacting service center.

Problems and Symptoms	Troubleshooting
The screen doesn't show up	<ul style="list-style-type: none">• Make sure if the power supply is connected property• Turn on the power.• Select the input signal right for the connected port.
The screen is too light or to dark	<ul style="list-style-type: none">• Control the BRIGHTNESS



Hanwha Vision cares for the environment at all product manufacturing stages, and is taking measures to provide customers with more environmentally friendly products.

The Eco mark represents Hanwha Vision's devotion to creating environmentally friendly products, and indicates that the product satisfies the EU RoHS Directive.



Correct Disposal of This Product (Waste Electrical & Electronic Equipment)

(Applicable in the European Union and other European countries with separate collection systems)

This marking on the product, accessories or literature indicates that the product and its electronic accessories (e.g. charger, headset, USB cable) should not be disposed of with other household waste at the end of their working life. To prevent possible harm to the environment or human health from uncontrolled waste disposal, please separate these items from other types of waste and recycle them responsibly to promote the sustainable reuse of material resources.

Household users should contact either the retailer where they purchased this product, or their local government office, for details of where and how they can take these items for environmentally safe recycling.

Business users should contact their supplier and check the terms and conditions of the purchase contract. This product and its electronic accessories should not be mixed with other commercial wastes for disposal.



Correct disposal of batteries in this product

(Applicable in the European Union and other European countries with separate battery return systems.)

This marking on the battery, manual or packaging indicates that the batteries in this product should not be disposed of with other household waste at the end of their working life. Where marked, the chemical symbols Hg, Cd or Pb indicate that the battery contains mercury, cadmium or lead above the reference levels in EC Directive 2006/66. If batteries are not properly disposed of, these substances can cause harm to human health or the environment.

To protect natural resources and to promote material reuse, please separate batteries from other types of waste and recycle them through your local, free battery return system.

