

QIO Series Audio I/O Expanders for Q-SYS:

QIO-ML4i, QIO-L4o, QIO-ML2x2, QIO-AES8x8, QIO-TEL2, QIO-FLEX4A

QIO Series Control I/O Expanders for Q-SYS:

QIO-GP8x8, QIO-S4, QIO-IR1x4, QIO-LVR4

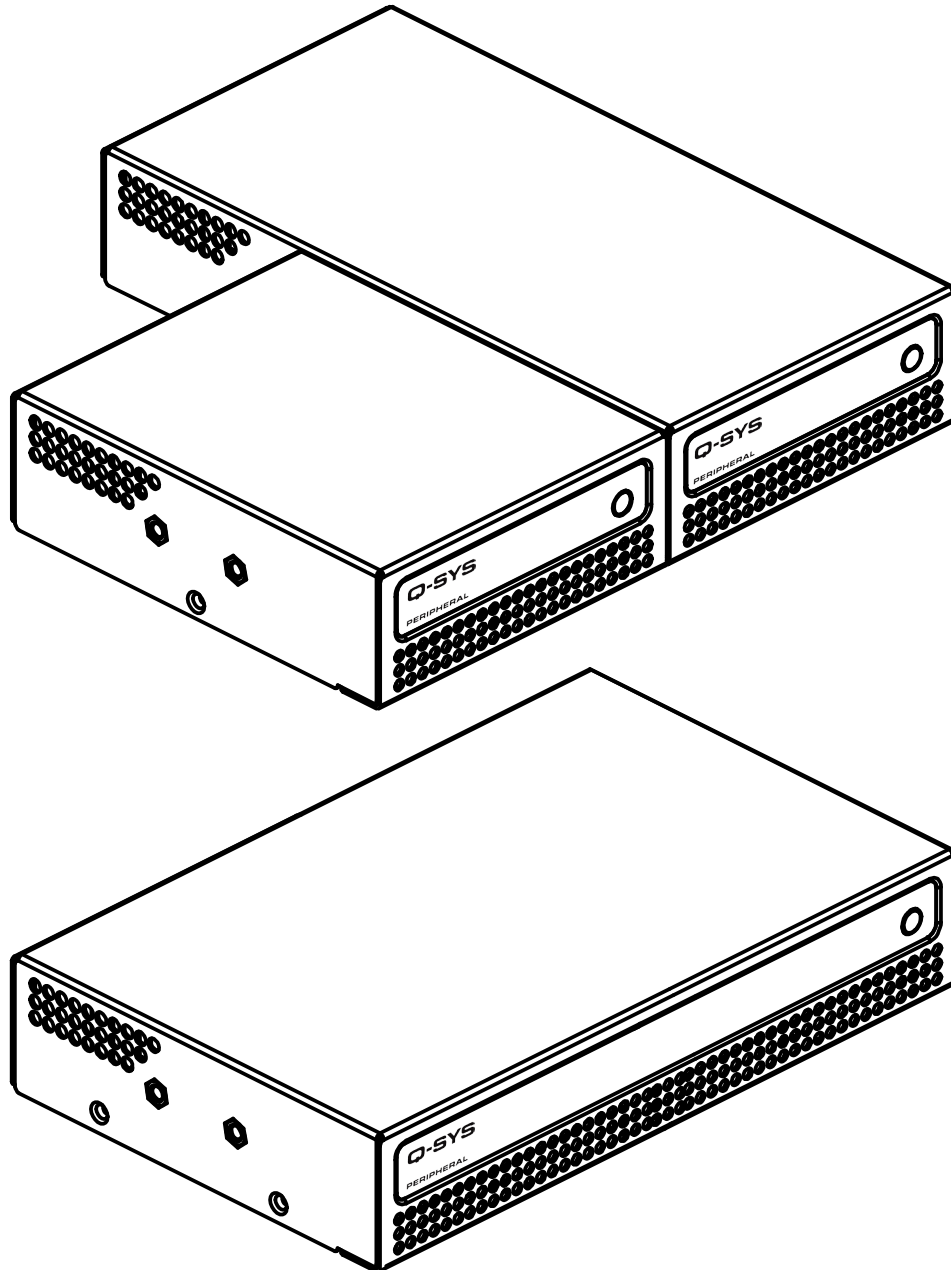

EXPLANATION OF TERMS AND SYMBOLS

The term "**WARNING**" indicates instructions regarding personal safety. Failure to follow them may result in bodily injury or death.

The term "**CAUTION**" indicates instructions regarding possible damage to physical equipment. Failure to follow them may result in equipment damage to equipment that may not be covered under the warranty.

The term "**IMPORTANT**" indicates instructions or information that are vital to the successful completion of the procedure.

The term "**NOTE**" indicates additional useful information.



The lightning flash with arrowhead symbol in a triangle alerts the user to the presence of uninsulated dangerous voltage within the product's enclosure that may constitute a risk of electric shock to humans.



The exclamation point within a triangle alerts the user to important safety, operating, and maintenance instructions in this manual.



IMPORTANT SAFETY INSTRUCTIONS



WARNING! TO PREVENT FIRE OR ELECTRIC SHOCK, DO NOT EXPOSE THIS EQUIPMENT TO RAIN OR MOISTURE.

- **Elevated Operating Ambient** – If installed in a closed or multi-unit rack assembly, the ambient operating temperature of the rack environment may be greater than room ambient. Consideration should be given to ensure that the maximum operating temperature range (0°C to 50°C) is not exceeded. However, if installing a QIO-GP8x8 in a multi-unit rack assembly with units on all sides, the maximum operating temperature should not exceed 40°C when devices are placed above or below.
- **Reduced Air Flow** – Installation of the equipment in a rack should be such that the amount of air flow required for safe operation of the equipment is not compromised.



CAUTION: To reduce the risk of fire, use only 26 AWG or larger telecommunication line cord with the QIO-TEL2.

1. Read these instructions.
2. Keep these instructions.
3. Heed all warnings.
4. Follow all instructions.
5. Do not use this apparatus near water.
6. Do not submerge the apparatus in water or liquids.
7. Do not use any aerosol spray, cleaner, disinfectant or fumigant on, near or into the apparatus.
8. Clean only with a dry cloth.
9. Do not block any ventilation opening. Install in accordance with the manufacturer's instructions.
10. Keep all ventilation openings free of dust or other matter.
11. Do not install near any heat sources such as radiators, heat registers, stoves, or other apparatus (including amplifiers) that produce heat.
12. Do not unplug the unit by pulling on the cord, use the plug.
13. Only use attachments/accessories specified by the manufacturer.
14. Unplug this apparatus during lightning storms or when unused for long periods of time.
15. Refer all servicing to qualified service personnel. Servicing is required when the apparatus has been damaged in any way, such as liquid has been spilled or objects have fallen into the apparatus, the apparatus has been exposed to rain or moisture, does not operate normally, or has been dropped.
16. Adhere to all applicable, local codes.
17. Consult a licensed, professional engineer when any doubt or questions arise regarding a physical equipment installation.

Maintenance and Repair



WARNING: Advanced technology, e.g., the use of modern materials and powerful electronics, requires specially adapted maintenance and repair methods. To avoid a danger of subsequent damage to the apparatus, injuries to persons and/or the creation of additional safety hazards, all maintenance or repair work on the apparatus should be performed only by a QSC authorized service station or an authorized QSC International Distributor. QSC is not responsible for any injury, harm or related damages arising from any failure of the customer, owner or user of the apparatus to facilitate those repairs.



IMPORTANT! 24V DC power supply or Power over Ethernet (PoE) PSE required. The QIO-FLEX4A requires an IEEE 802.3at Type 2 (PoE+) PSE or 802.3af Type 1 Class 3 PoE PSE if the device amplifier is not used. All other QIO models require an 802.3af Type 1 PoE PSE. See "QIO Series Control I/O Expanders - Cont'd" on page 11.

FCC Statements

QIO Series Audio I/O Expanders (except QIO-TEL2) and Control I/O Expanders

This equipment has been tested and found to comply with the limits for a Class A digital device, pursuant to Part 15 of the FCC Rules. These limits are designed to provide reasonable protection against harmful interference when the equipment is operated in a commercial environment. This equipment generates, uses, and can radiate radio frequency energy and, if not installed and used in accordance with the instruction manual, may cause harmful interference to radio communications. Operation of this equipment in a residential area is likely to cause harmful interference in which case the user will be required to correct the interference at his own expense.

QIO-TEL2 Only

This equipment has been tested and found to comply with the limits for a Class B digital device, pursuant to part 15 of the FCC Rules. These limits are designed to provide reasonable protection against harmful interference in a residential installation. This equipment generates, uses and can radiate radio frequency energy and, if not installed and used in accordance with the instructions, may cause harmful interference to radio communications. However, there is no guarantee that interference will not occur in a particular installation. If this equipment does cause harmful interference to radio or television reception, which can be determined by turning the equipment off and on, the user is encouraged to try to correct the interference by one or more of the following measures:

- Reorient or relocate the receiving antenna.
- Increase the separation between the equipment and receiver.
- Connect the equipment into an outlet on a circuit different from that to which the receiver is connected.
- Consult the dealer or an experienced radio/TV technician for help.

New Zealand Telepermit

QIO-TEL2: The unit's answering system only responds to Distinctive Alert cadence(s) DA1 and DA3.

Environmental

- **Expected Product Life Cycle:** 10 years
- **Ambient Operating Temperature Range:** 0°C to +50°C
- **Storage Temperature Range:** -20°C to +70°C
- **Relative Humidity:** 5 to 85% RH, non-condensing

RoHS Statements

The QSC Q-SYS QIO Series Audio I/O Expanders and Control I/O Expanders are in compliance with European RoHS Directive.

The QSC Q-SYS QIO Series Audio I/O Expanders and Control I/O Expanders are in compliance with "China RoHS" directives. The following table is provided for product use in China and its territories:

QSC Q-SYS QIO Series Audio I/O Expanders and Control I/O Expanders						
部件名称 (Part Name)	有害物质 (Hazardous Substances)					
	铅 (Pb)	汞 (Hg)	镉 (Cd)	六价铬 (Cr(vi))	多溴联苯 (PBB)	多溴二苯醚 (PBDE)
电路板组件 (PCB Assemblies)	X	○	○	○	○	○
机壳装配件 (Chassis Assemblies)	X	○	○	○	○	○

本表格依据 SJ/T 11364 的规定编制。

O: 表示该有害物质在该部件所有均质材料中的含量均在 GB/T 26572 规定的限量要求以下。

X: 表示该有害物质至少在该部件的某一均质材料中的含量超出 GB/T 26572 规定的限量要求。

(目前由于技术或经济的原因暂时无法实现替代或减量化。)

This table is prepared following the requirement of SJ/T 11364.





O: Indicates that the concentration of the substance in all homogeneous materials of the part is below the relevant threshold specified in GB/T 26572.

X: Indicates that the concentration of the substance in at least one of all homogeneous materials of the part is above the relevant threshold specified in GB/T 26572.



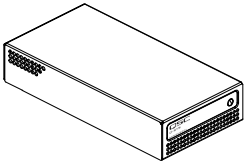
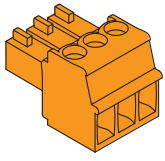
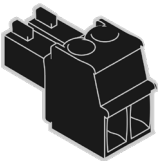
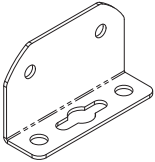

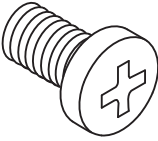
(Replacement and reduction of content cannot be achieved currently because of the technical or economic reason.)

What's in the Box

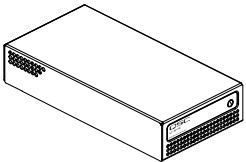
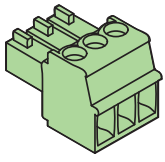
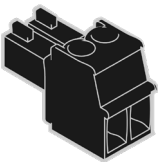
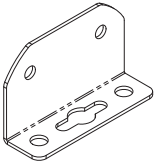

QIO-ML4i

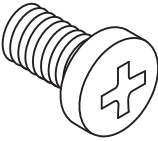
 <p>(1x) QIO-ML4i</p>	 <p>(4x) Mic/Line In connector (orange)</p>	 <p>(2x) Power connector (black)</p>
 <p>(2x) Surface mounting bracket</p>	 <p>(4x) Foam spacer</p>	 <p>(4x) M4 x 6 mm pan head screws</p>
 <p>(1x) Warranty statement</p>	 <p>(1x) Safety and regulatory statements</p>	



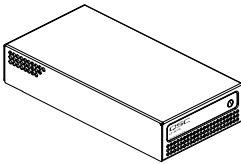
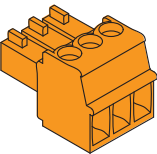
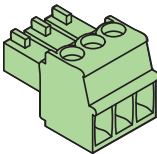
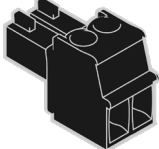
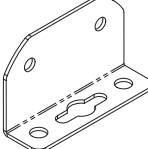

QIO-L4o

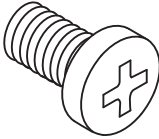
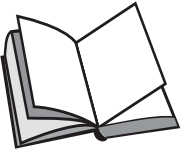
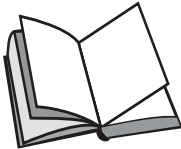
 <p>(1x) QIO-L4o</p>	 <p>(4x) Line Out connector (green)</p>	 <p>(2x) Power connector (black)</p>
 <p>(2x) Surface mounting bracket</p>	 <p>(4x) Foam spacer</p>	 <p>(4x) M4 x 6 mm pan head screws</p>
 <p>(1x) Warranty statement</p>	 <p>(1x) Safety and regulatory statements</p>	

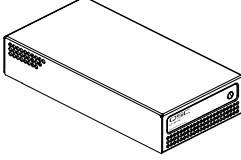
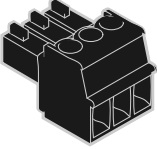
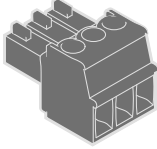
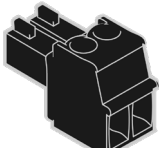
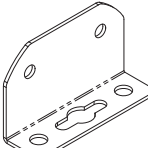

QIO-ML2x2

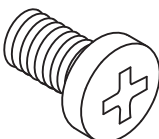
 <p>(1x) QIO-ML2x2</p>	 <p>(2x) Mic/Line In connector (orange)</p>	 <p>(2x) Line Out connector (green)</p>
 <p>(2x) Power connector (black)</p>	 <p>(2x) Surface mounting bracket</p>	 <p>(4x) Foam spacer</p>
 <p>(4x) M4 x 6 mm pan head screws</p>	 <p>(1x) Warranty statement</p>	 <p>(1x) Safety and regulatory statements</p>

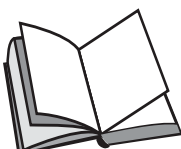

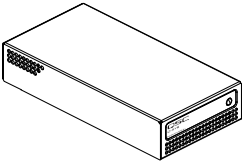
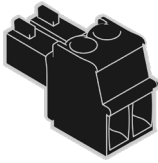
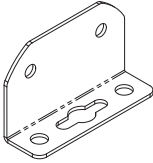

QIO-AES8x8

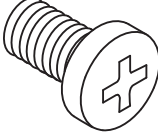
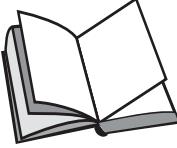
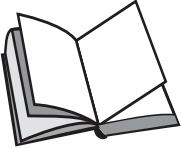
 <p>(1x) QIO-AES8x8</p>	 <p>(4x) AES Input connector (black)</p>	 <p>(4x) AES Output connector (gray)</p>
 <p>(2x) Power connector (black)</p>	 <p>(2x) Surface mounting bracket</p>	 <p>(4x) Foam spacer</p>
 <p>(4x) M4 x 6 mm pan head screws</p>	 <p>(1x) Warranty statement</p>	 <p>(1x) Safety and regulatory statements</p>

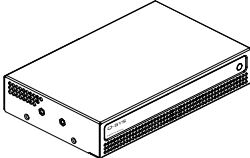
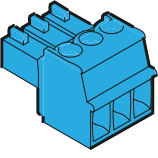
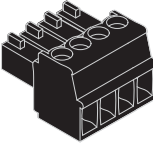
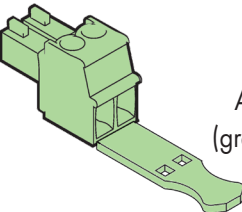
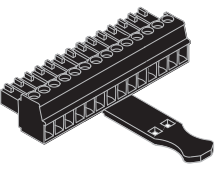

QIO-TEL2

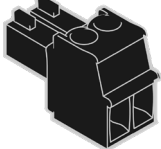
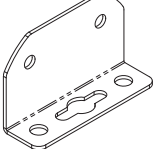
	(1x) QIO-TEL2		(2x) Power connector (black)		(2x) Surface mounting bracket
	(4x) Foam spacer		(4x) M4 x 6 mm pan head screws		(1x) Warranty statement
	(1x) Safety and regulatory statements				

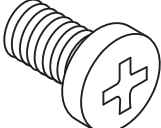
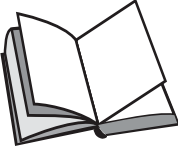
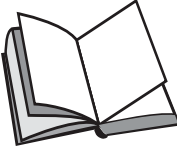

QIO-FLEX4A

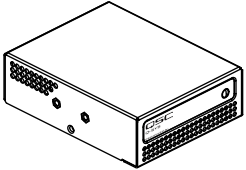
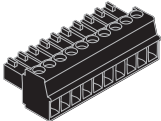
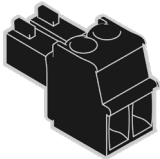
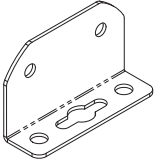
	(1x) QIO-FLEX4A		(4x) FLEX connector (blue)		(1x) RS232 connector (black)
	(2x) AMP connector (green, with strain relief tab)		(1x) GPIO connector (black, with strain relief tab)		(3x) Cable tie (for AMP and GPIO connector strain relief)
	(2x) Power connector (black)		(2x) Surface mounting bracket		(4x) Foam spacer
	(4x) M4 x 6 mm pan head screws		(1x) Warranty statement		(1x) Safety and regulatory statements

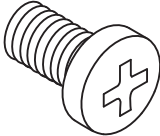
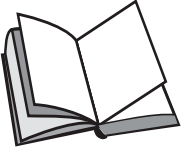
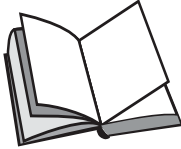

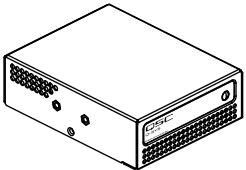
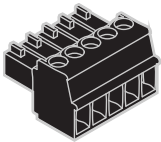
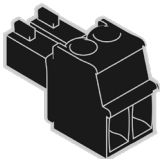
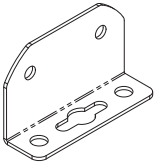

QIO-GP8x8

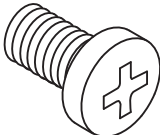
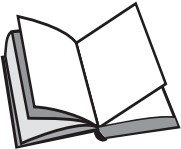
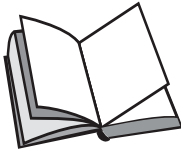
 <p>(1x) QIO-GP8x8</p>	 <p>(2x) GPIO connector (black)</p>	 <p>(2x) Power connector (black)</p>
 <p>(2x) Surface mounting bracket</p>	 <p>(4x) Foam spacer</p>	 <p>(4x) M4 x 6 mm pan head screws</p>
 <p>(1x) Warranty statement</p>	 <p>(1x) Safety and regulatory statements</p>	

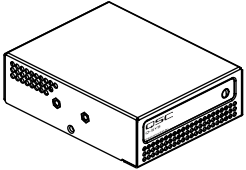

QIO-S4

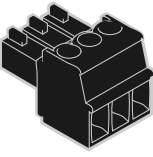
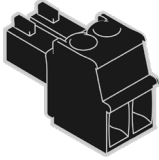
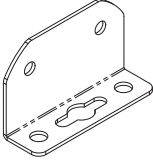
 <p>(1x) QIO-S4</p>	 <p>(4x) Serial connector (black)</p>	 <p>(2x) Power connector (black)</p>
 <p>(2x) Surface mounting bracket</p>	 <p>(4x) Foam spacer</p>	 <p>(4x) M4 x 6 mm pan head screws</p>
 <p>(1x) Warranty statement</p>	 <p>(1x) Safety and regulatory statements</p>	

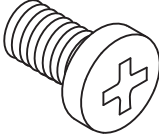
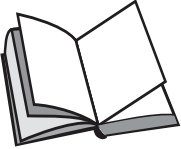
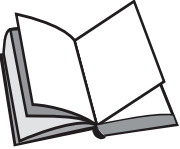
QIO-IR1x4

 <p>(1x) QIO-IR1x4</p>	 <p>(1x) IR Output connector (black)</p>	 <p>(1x) IR Input connector (black)</p>
 <p>(2x) Power connector (black)</p>	 <p>(2x) Surface mounting bracket</p>	 <p>(4x) Foam spacer</p>
 <p>(4x) M4 x 6 mm pan head screws</p>	 <p>(1x) Warranty statement</p>	 <p>(1x) Safety and regulatory statements</p>

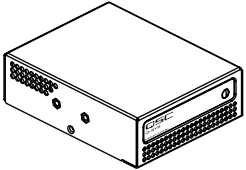
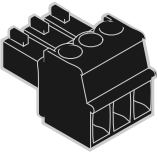
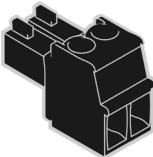
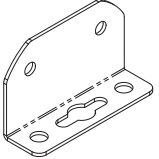
QIO-LVR4

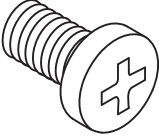
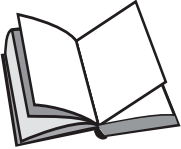
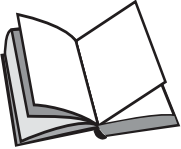
 <p>(1x) QIO-LVR4</p>	 <p>(4x) Relay connector (black)</p>	 <p>(2x) Power connector (black)</p>
 <p>(2x) Surface mounting bracket</p>	 <p>(4x) Foam spacer</p>	 <p>(4x) M4 x 6 mm pan head screws</p>
 <p>(1x) Warranty statement</p>	 <p>(1x) Safety and regulatory statements</p>	

Introduction

QIO Series Audio I/O Expanders

The **Q-SYS QIO-ML4i** is a network audio endpoint native to the Q-SYS Ecosystem, serving as a mic/line input that enables network-based audio distribution. The compact form factor includes surface mounting hardware permitting discreet and strategic mounting while an optional rack kit fits one to four devices into a standard 1U nineteen-inch format. The four-channel granularity locates the right amount of analog audio connectivity in desired locations without bulk or waste. Up to four devices may be daisy-chained off one access switch port, provided 24V DC power is available. Alternatively, each may be individually powered over Ethernet.

The **Q-SYS QIO-L4o** is a network audio endpoint native to the Q-SYS Ecosystem, serving as a line output that enables network-based audio distribution. The compact form factor includes surface mounting hardware permitting discreet and strategic mounting while an optional rack kit fits one to four devices into a standard 1U nineteen-inch format. The four-channel granularity locates the right amount of analog audio connectivity in desired locations without bulk or waste. Up to four devices may be daisy-chained off one access switch port, provided 24V DC power is available. Alternatively, each may be individually powered over Ethernet.

The **Q-SYS QIO-ML2x2** is a network audio endpoint native to the Q-SYS Ecosystem, serving as a mic/line input, line output device, that enables network-based audio distribution. The compact form factor includes surface mounting hardware permitting discreet and strategic mounting while an optional rack kit fits one to four devices into a standard 1U nineteen-inch format. The four-channel granularity locates the right amount of analog audio connectivity in desired locations without bulk or waste. Up to four devices may be daisy-chained off one access switch port, provided 24V DC power is available. Alternatively, each may be individually powered over Ethernet.

The **Q-SYS QIO-AES8x8** is a network audio endpoint native to the Q-SYS Ecosystem, serving as an AES3 input/output device, that enables network-based audio distribution. The compact form factor includes surface mounting hardware permitting discreet and strategic mounting while an optional rack kit fits one to four devices into a standard 1U nineteen-inch format. The eight-channel granularity locates the right amount of connectivity in desired locations without bulk or waste. Up to four devices may be daisy-chained off one access switch port, provided 24V DC power is available. Alternatively, each may be individually powered over Ethernet.

The **Q-SYS QIO-TEL2** is a network audio endpoint native to the Q-SYS Ecosystem, serving as a POTS FXO device, that enables network-based audio distribution. The compact form factor includes surface mounting hardware permitting discreet and strategic mounting while an optional rack kit fits one to four devices into a standard 1U nineteen-inch format. Two POTS interfaces provide the right amount of connectivity in desired locations without bulk or waste. Up to four devices may be daisy-chained off one access switch port, provided 24V DC power is available. Alternatively, each may be individually powered over Ethernet.

The **Q-SYS QIO-FLEX4A** is a network audio endpoint native to the Q-SYS Ecosystem, serving as an all-in-one I/O peripheral for presentation, discussion, and connected collaboration spaces. The compact form factor includes surface mounting hardware permitting discreet and strategic mounting while an optional rack kit fits one to two QIO-FLEX4A devices (or one QIO-FLEX4A with up to two quarter rack-width QIO devices) into a standard 1U nineteen-inch format. With four FLEX I/O that can be used as analog mic/line inputs or outputs, two amplified speaker level outputs, 4x8 GPIO, and one RS232 port, QIO-FLEX4A locates the right amount of connectivity in desired locations without bulk or waste. Up to four devices may be daisy-chained off one access switch port, provided 24V DC power is available. Alternatively, each may be individually powered over Ethernet.

QIO Series Control I/O Expanders

The **Q-SYS QIO-GP8x8** is a network control endpoint native to the Q-SYS Ecosystem, providing General Purpose Input/Output (GPIO) connections that allow the Q-SYS network to interface with miscellaneous outside devices, such as LED indicators, switches, relays, and potentiometers, and with custom or third-party controls. The compact form factor includes surface mounting hardware permitting discreet and strategic mounting while an optional rack kit fits one to four devices into a standard 1U nineteen-inch format. Up to four devices may be daisy-chained off one access switch port, provided 24V DC power is available. Alternatively, each may be individually powered over Ethernet.

The **Q-SYS QIO-S4** is a network control endpoint native to the Q-SYS Ecosystem, serving as an IP-to-serial bridge that enables network-based control distribution. The compact form factor includes surface mounting hardware permitting discreet and strategic mounting while an optional rack kit fits one to four devices into a standard 1U nineteen-inch format. Up to four devices may be daisy-chained off one access switch port, provided 24V DC power is available. Alternatively, each may be individually powered over Ethernet.

The **Q-SYS QIO-IR1x4** is a network control endpoint native to the Q-SYS Ecosystem, serving as an IP-to-IR bridge that enables network-based infrared control distribution. The compact form factor includes surface mounting hardware permitting discreet and strategic mounting while an optional rack kit fits one to four devices into a standard 1U nineteen-inch format. Up to four devices may be daisy-chained off one access switch port, provided 24V DC power is available. Alternatively, each may be individually powered over Ethernet.

QIO Series Control I/O Expanders - Cont'd

The **Q-SYS QIO-LVR4** is a network control endpoint native to the Q-SYS Ecosystem, serving as an IP-to-relay bridge that enables communication with common motorized motor shades, lighting controllers, as well as other environmental systems via four controllable low-voltage relays. The compact form factor includes surface mounting hardware permitting discreet and strategic mounting while an optional rack kit fits one to four devices into a standard 1U nineteen-inch format. Up to four devices may be daisy-chained off one access switch port, provided 24V DC power is available. Alternatively, each may be individually powered over Ethernet.

Power Requirements

The Q-SYS QIO Series offers a flexible power solution that allows the integrator to choose to use either a 24V DC power supply or Power over Ethernet (PoE). With either power solution, you must follow the safety instructions for the specific power supply or injector chosen. For details on the 24V DC or PoE power supply requirements, refer to the product specifications.



WARNING: To avoid the risk of electric shock, this equipment must only be connected to a supply mains with protective earth when using class I power supply.

Power over Ethernet (PoE)

The QIO-FLEX4A requires an IEEE 802.3at Type 2 (PoE+) PSE or 802.3af Type 1 Class 3 PoE PSE if the device amplifier is not used. All other QIO models require an 802.3af Type 1 PoE PSE.



NOTE: A device cannot provide daisy-chained power to an external device with Power over Ethernet. An external 24V DC supply is required for power daisy-chaining applications. A device can provide Ethernet daisy-chaining with either power source.

24V DC External Supply and Daisy-Chained Devices



NOTE: When using an accessory power supply (24V DC @ 3.75A max, less than 100W), a maximum of four (4) quarter-rack QIO devices, two (2) QIO-FLEX4A devices, or any combination of QIO devices that can fit in a single QIO-RMK Rack Kit may be powered simultaneously. For rack mounting information, see "Rack Mount Installation" on page 24.

Common ¹ Accessory Power Supply Connections: 2-pin Euro connector	
White or red wire (24V DC)	+
Black or bare wire (GND)	⏏ or ↓

¹ Common accessory power supply wiring provided for reference only. Confirm wire color in the accessory power supply specification.

Specifications and Dimensions

Product specifications and dimension drawings for Q-SYS QIO Endpoints can be found online at qsys.com.

Connections and Callouts

QIO-ML4i Front Panel

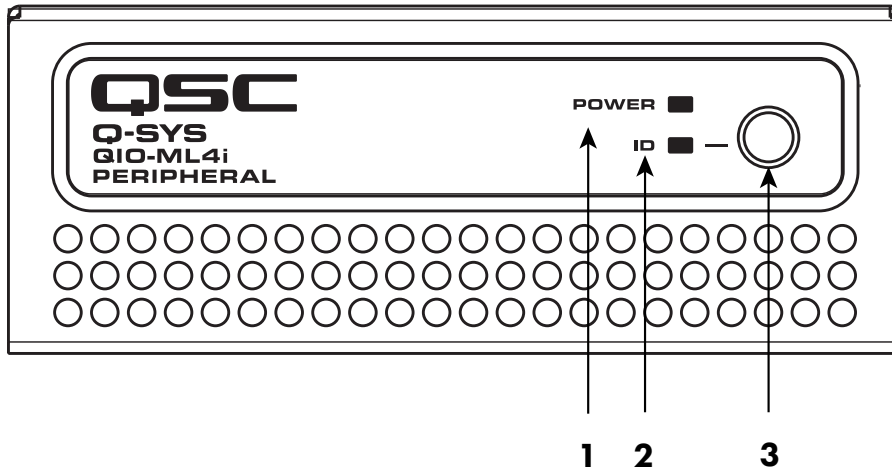

1. **Power LED** – Illuminates blue when the Q-SYS QIO-ML4i is powered on.
2. **ID LED** – LED blinks green when placed into ID Mode via ID Button or Q-SYS Configurator.
3. **ID Button** – Locates the QIO-ML4i in Q-SYS Designer Software and Q-SYS Configurator.

QIO-ML4i Rear Panel

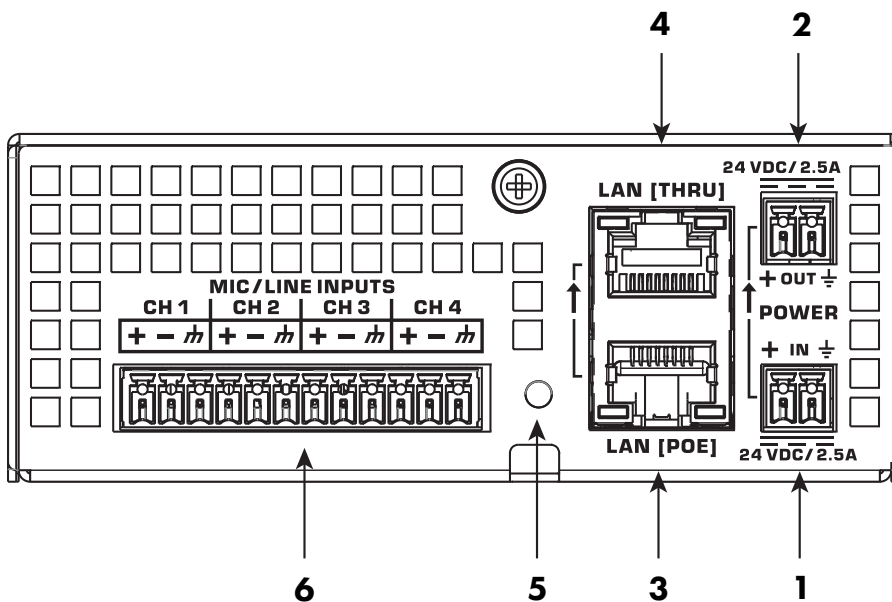

1. **External Power Input 24V DC 2.5 A** – Auxiliary power, 24V DC, 2.5 A, 2-pin Euro connector.
2. **Daisy-Chain Power Output 24V DC 2.5 A** - Auxiliary power, 24V DC, 2.5 A 2-pin Euro connector.
3. **LAN [PoE]** – RJ-45 connector, 802.3af PoE Type 1 Class 3 power, Q-LAN.
4. **LAN [THRU]** – RJ-45 connector, Ethernet daisy-chaining.
5. **Device Reset** – Use a paperclip or similar tool to restore default network settings and recover factory default settings. Before attempting a reset, refer to the Q-SYS Help for details.
6. **Mic/Line Inputs** – Four channels, balanced or unbalanced, phantom power – orange.

QIO-L4o Front Panel

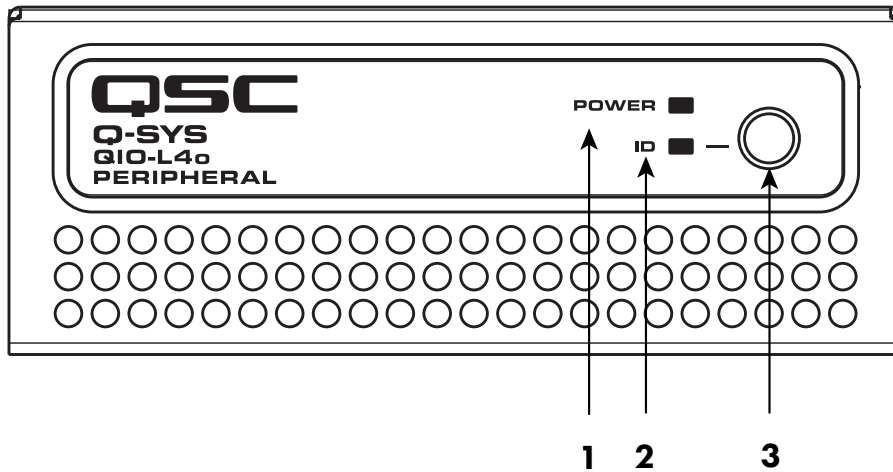

1. **Power LED** – Illuminates blue when the Q-SYS QIO-L4o is powered on.
2. **ID LED** – LED blinks green when placed into ID Mode via ID Button or Q-SYS Configurator.
3. **ID Button** – Locates the QIO-L4o in Q-SYS Designer Software and Q-SYS Configurator.

QIO-L4o Rear Panel

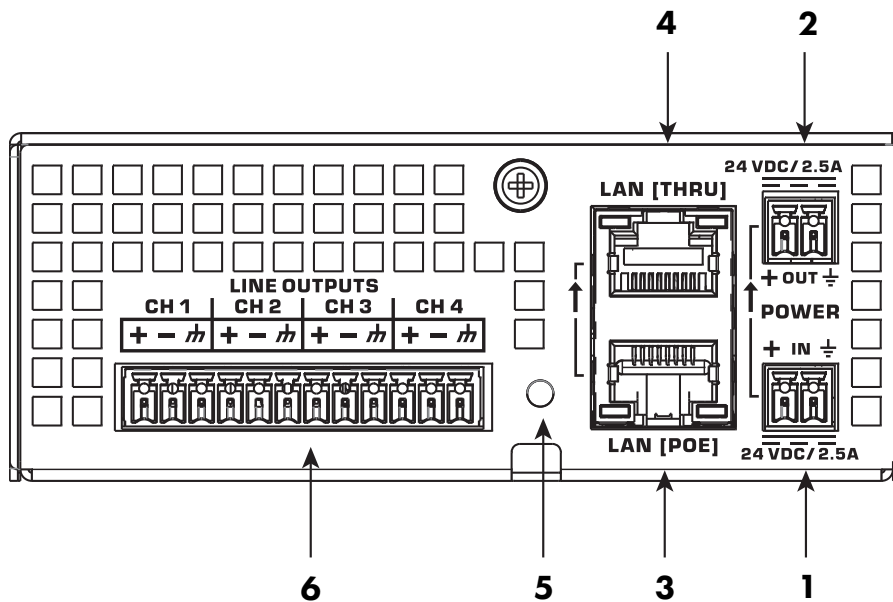

1. **External Power Input 24V DC 2.5 A** – Auxiliary power, 24V DC, 2.5 A, 2-pin Euro connector.
2. **Daisy-Chain Power Output 24V DC 2.5 A** - Auxiliary power, 24V DC, 2.5 A 2-pin Euro connector.
3. **LAN [PoE]** – RJ-45 connector, 802.3af PoE Type 1 Class 2 power, Q-LAN.
4. **LAN [THRU]** – RJ-45 connector, Ethernet daisy-chaining.
5. **Device Reset** – Use a paperclip or similar tool to restore default network settings and recover factory default settings. Before attempting a reset, refer to the Q-SYS Help for details.
6. **Line Outputs** – Four channels, balanced or unbalanced – green.

QIO-ML2x2 Front Panel

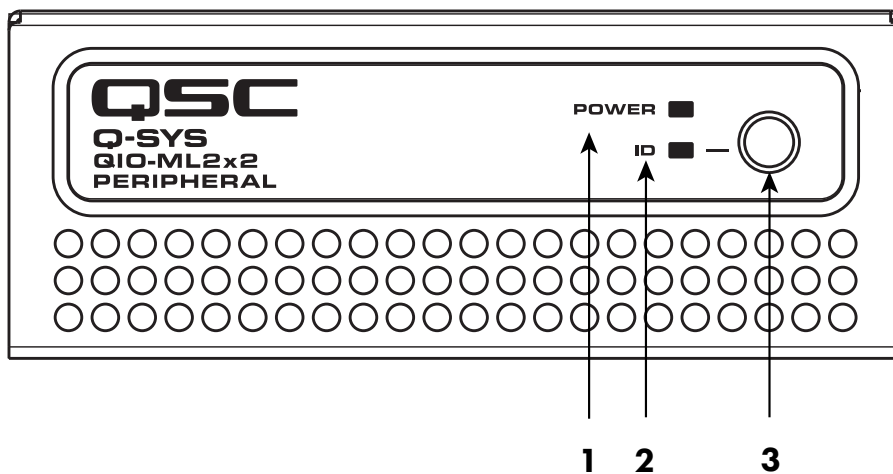

1. **Power LED** – Illuminates blue when the Q-SYS QIO-ML2x2 is powered on.
2. **ID LED** – LED blinks green when placed into ID Mode via ID Button or Q-SYS Configurator.
3. **ID Button** – Locates the QIO-ML2x2 in Q-SYS Designer Software and Q-SYS Configurator.

QIO-ML2x2 Rear Panel

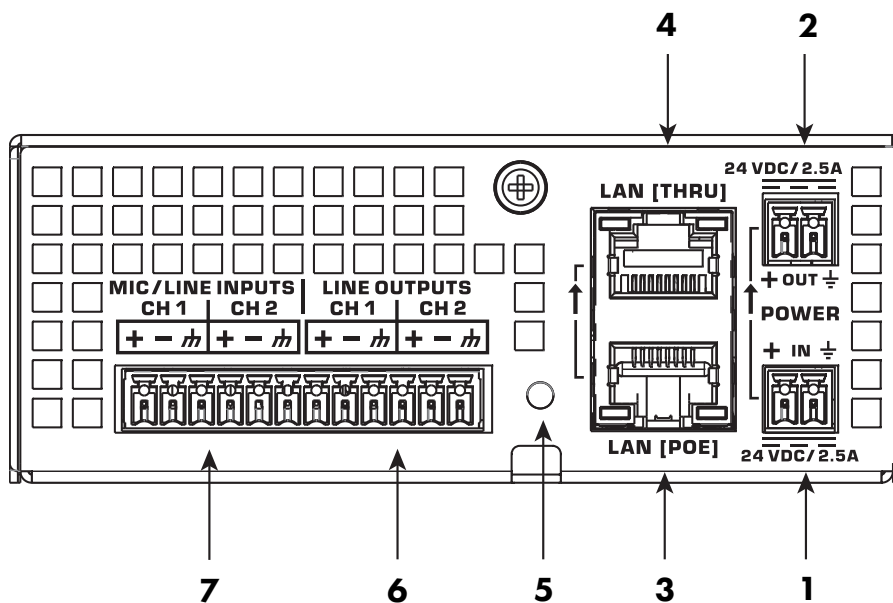

1. **External Power Input 24V DC 2.5 A** – Auxiliary power, 24V DC, 2.5 A, 2-pin Euro connector.
2. **Daisy-Chain Power Output 24V DC 2.5 A** - Auxiliary power, 24V DC, 2.5 A 2-pin Euro connector.
3. **LAN [PoE]** – RJ-45 connector, 802.3af PoE Type 1 Class 3 power, Q-LAN.
4. **LAN [THRU]** – RJ-45 connector, Ethernet daisy-chaining.
5. **Device Reset** – Use a paperclip or similar tool to restore default network settings and recover factory default settings. Before attempting a reset, refer to the Q-SYS Help for details.
6. **Line Outputs** – Two channels, balanced or unbalanced – green.
7. **Mic/Line Inputs** – Two channels, balanced or unbalanced, phantom power – orange.

QIO-AES8x8 Front Panel

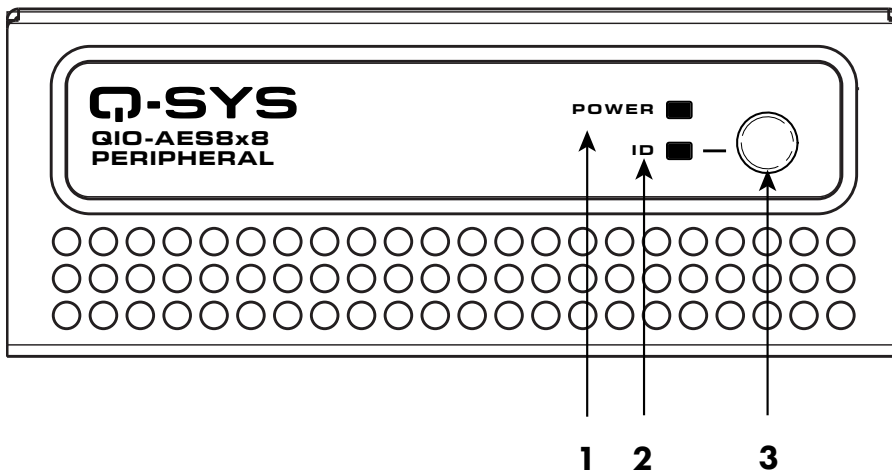

1. **Power LED** – Illuminates blue when the Q-SYS QIO-AES8x8 is powered on.
2. **ID LED** – LED blinks green when placed into ID Mode via ID Button or Q-SYS Configurator.
3. **ID Button** – Locates the QIO-AES8x8 in Q-SYS Designer Software and Q-SYS Configurator.

QIO-AES8x8 Rear Panel

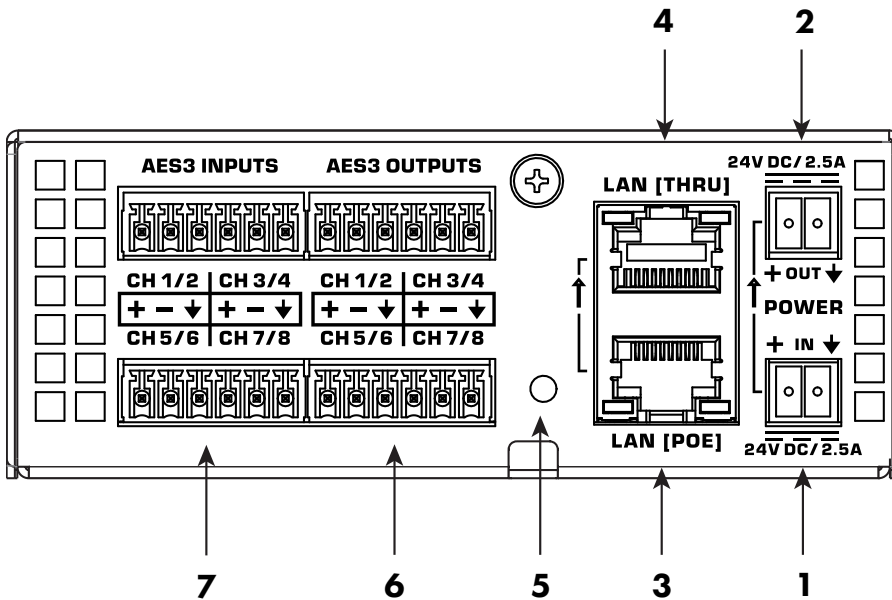

1. **External Power Input 24V DC 2.5 A** – Auxiliary power, 24V DC, 2.5 A, 2-pin Euro connector.
2. **Daisy-Chain Power Output 24V DC 2.5 A** - Auxiliary power, 24V DC, 2.5 A, 2-pin Euro connector.
3. **LAN [PoE]** – RJ-45 connector, 802.3af Type 1 Class 2 power, Q-LAN.
4. **LAN [THRU]** – RJ-45 connector, Ethernet daisy-chaining.
5. **Device Reset** – Use a paperclip or similar tool to restore default network settings and recover factory default settings. Before attempting a reset, refer to the Q-SYS Help for details.
6. **AES Outputs** – Eight channels, balanced, multiple sample rates.
7. **AES Inputs** – Eight channels, balanced, multiple sample rates.

QIO-TEL2 Front Panel

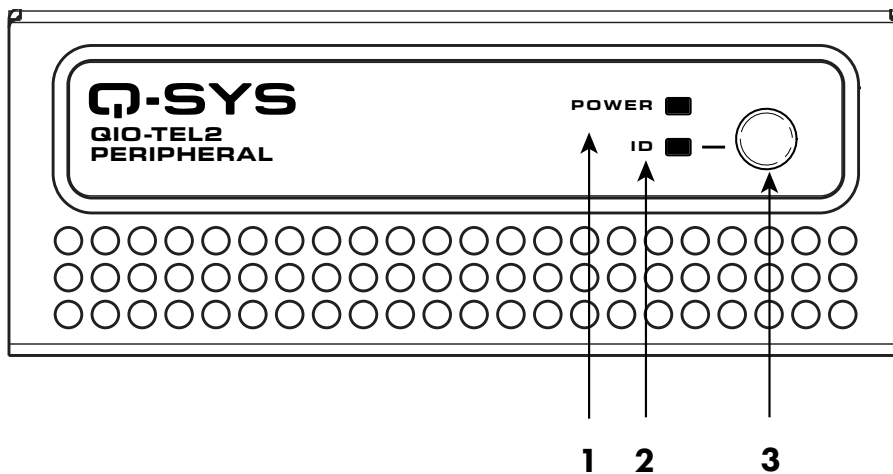

1. **Power LED** – Illuminates blue when the Q-SYS QIO-TEL2 is powered on.
2. **ID LED** – LED blinks green when placed into ID Mode via ID Button or Q-SYS Configurator.
3. **ID Button** – Locates the QIO-TEL2 in Q-SYS Designer Software and Q-SYS Configurator.

QIO-TEL2 Rear Panel

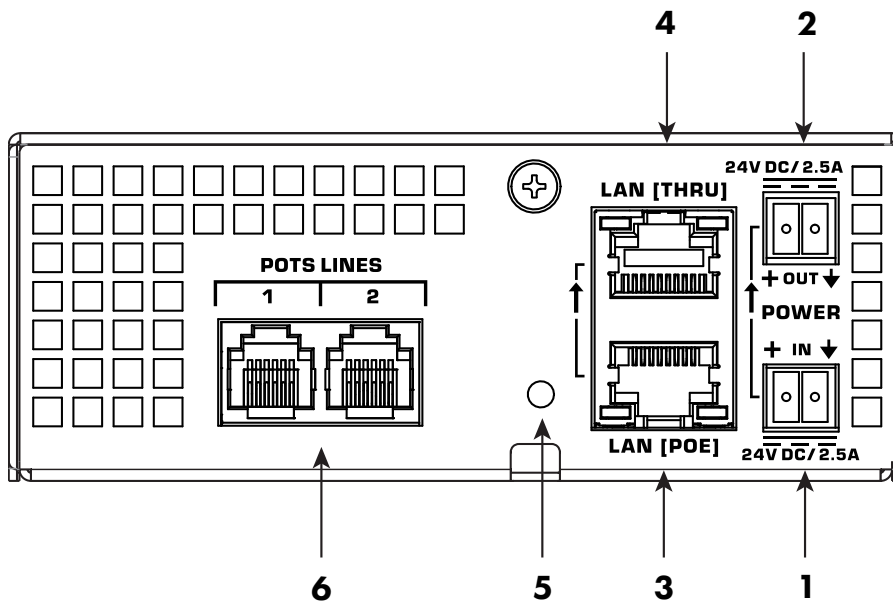

1. **External Power Input 24V DC 2.5 A** – Auxiliary power, 24V DC, 2.5 A, 2-pin Euro connector.
2. **Daisy-Chain Power Output 24V DC 2.5 A** - Auxiliary power, 24V DC, 2.5 A 2-pin Euro connector.
3. **LAN [PoE]** – RJ-45 connector, 802.3af Type 1 Class 1 power, Q-LAN.
4. **LAN [THRU]** – RJ-45 connector, Ethernet daisy-chaining.
5. **Device Reset** – Use a paperclip or similar tool to restore default network settings and recover factory default settings. Before attempting a reset, refer to the Q-SYS Help for details.
6. **POTS Lines** – Two FXO interfaces. **Note:** Each Q-SYS phone line is meant to be connected to a single PTSN line (FXO). It does not control a multi-line PBX or interface with an FXS.

QIO-FLEX4A Front Panel

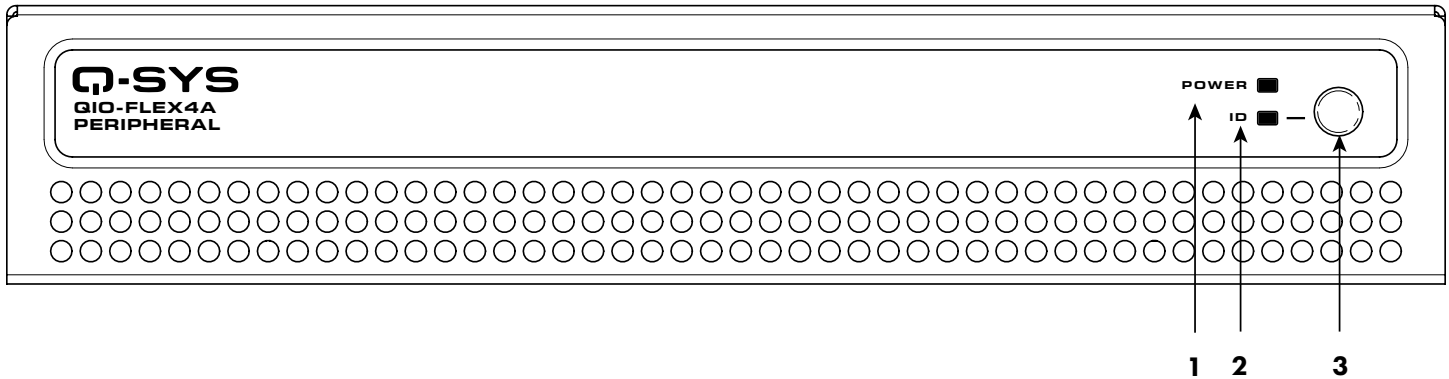

1. **Power LED** – Illuminates blue when the Q-SYS QIO-FLEX4A is powered on.
2. **ID LED** – LED blinks green when placed into ID Mode via ID Button or Q-SYS Configurator.
3. **ID Button** – Locates the QIO-FLEX4A in Q-SYS Designer Software and Q-SYS Configurator.

QIO-FLEX4A Rear Panel

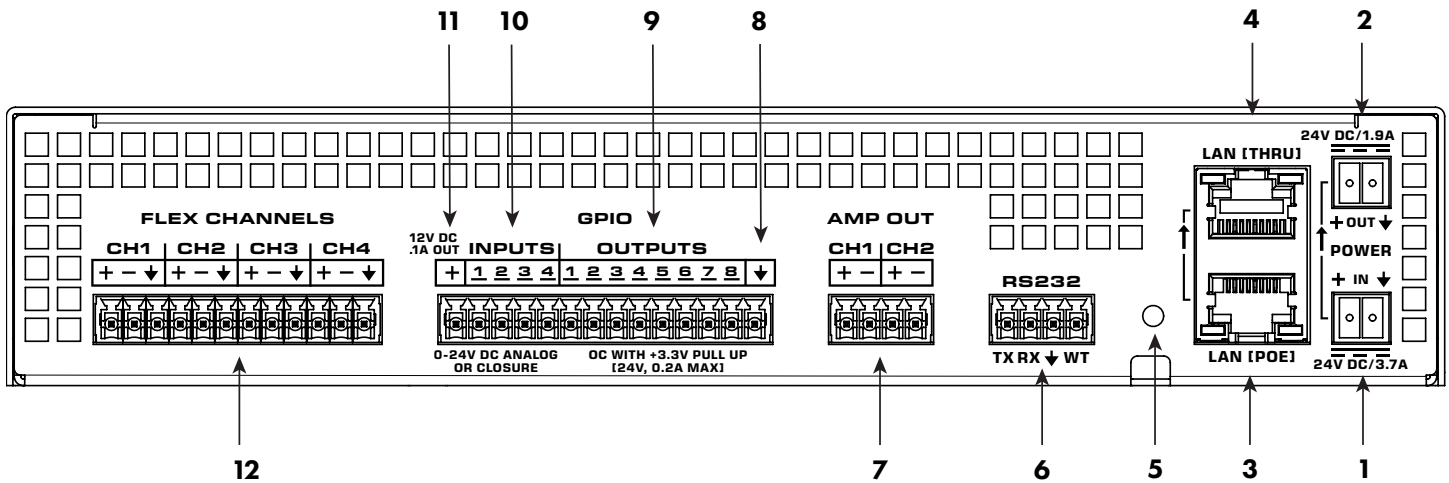

1. **External Power Input 24V DC 3.7 A** – Auxiliary power, 24V DC, 3.7 A, 2-pin Euro connector.
2. **Daisy-Chain Power Output 24V DC 1.9 A** - Auxiliary power, 24V DC, 1.9 A 2-pin Euro connector.
3. **LAN [PoE]** – RJ-45 connector, 802.3at Type 2 power, Q-LAN.
4. **LAN [THRU]** – RJ-45 connector, Ethernet daisy-chaining.
5. **Device Reset** – Use a paperclip or similar tool to restore default network settings and recover factory default settings. Before attempting a reset, refer to the Q-SYS Help for details.
6. **RS232** – COM: TX pin (output, transmit data), RX pin (input, receive data), Ground pin (signal ground), WT pin (5.5V DC 70 mA max).
7. **AMP Out** – 2 channels, 5W per channel (PoE+) or 9W per channel (Aux power).
8. **Signal Ground** – For use with General Purpose Inputs and Outputs (GPIO). Uses connector pin 14 (not numbered).
9. **GPIO Outputs** – 8 outputs, open collector (24V, 0.2A sink maximum) with pull up to +3.3V (pins labeled 1–8 equal pins 1–8 in the Q-SYS Designer GPIO Output component).
10. **GPIO Inputs** – 4 inputs, 0-24V analog input, digital input, or contact closure (pins labeled 1–4 equal pins 1–4 in the Q-SYS Designer GPIO Input component). Configurable pull-up to +12V.
11. **12V DC .1A Out** – For use with GPIO. Uses connector pin 1 (not numbered).
12. **FLEX Channels** – 4 user-configurable audio channels (mic/line input with optional phantom power, or line output), balanced or unbalanced.

QIO-GP8x8 Front Panel

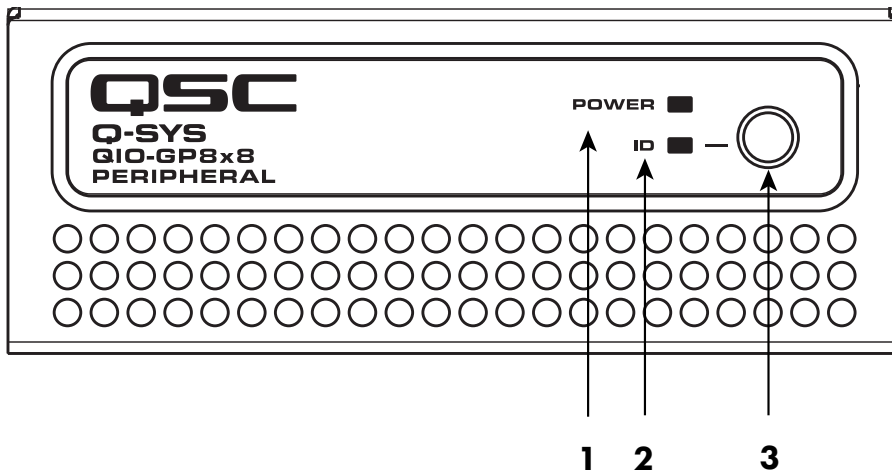

1. **Power LED** – Illuminates blue when the Q-SYS QIO-GP8x8 is powered on.
2. **ID LED** – LED blinks green when placed into ID Mode via ID Button or Q-SYS Configurator.
3. **ID Button** – Locates the QIO-GP8x8 in Q-SYS Designer Software and Q-SYS Configurator.

QIO-GP8x8 Rear Panel

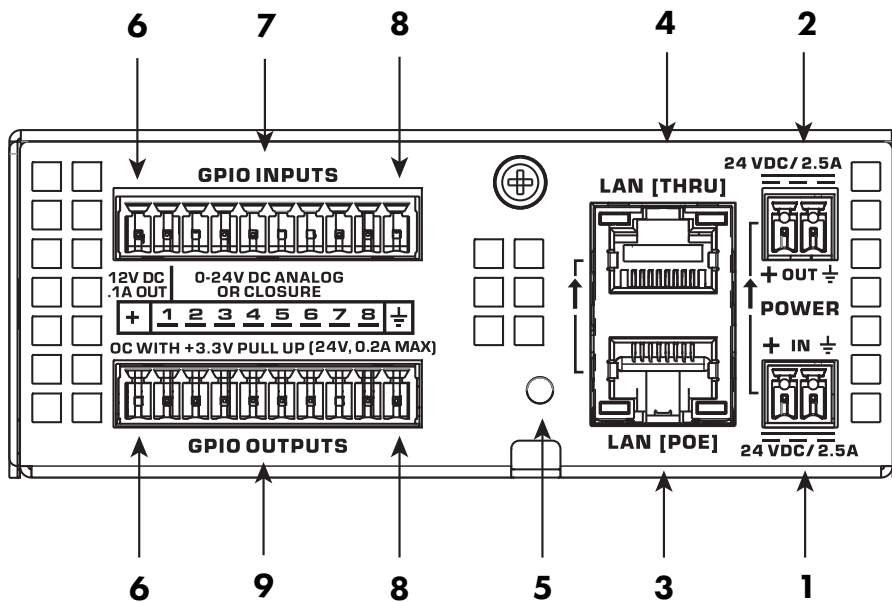

1. **External Power Input 24V DC 2.5 A** – Auxiliary power, 24V DC, 2.5 A, 2-pin Euro connector.
2. **Daisy-Chain Power Output 24V DC 2.5 A** - Auxiliary power, 24V DC, 2.5 A 2-pin Euro connector.
3. **LAN [PoE]** – RJ-45 connector, 802.3af PoE Type 1 Class 3 power, Q-LAN.
4. **LAN [THRU]** – RJ-45 connector, Ethernet daisy-chaining.
5. **Device Reset** – Use a paperclip or similar tool to restore default network settings and recover factory default settings. Before attempting a reset, refer to the Q-SYS Help for details.
6. **12V DC .1A Out** – For use with General Purpose Inputs and Outputs (GPIO). Uses black connector pins 1 and 11 (not numbered).
7. **GPIO Inputs** – 8 inputs, 0-24V analog input, digital input, or contact closure (Pins labeled 1–8 equal pins 1–8 in the Q-SYS Designer Software GPIO Input component). Configurable pull-up to +12V.
8. **Signal Ground** – For use with GPIO. Uses black connector pins 10 and 20 (not numbered).
9. **GPIO Outputs** – 8 outputs, open collector (24V, 0.2A sink maximum) with pull-up to +3.3V (Pins labeled 1–8 equal pins 1–8 in the Q-SYS Designer Software GPIO Output component).

QIO-S4 Front Panel

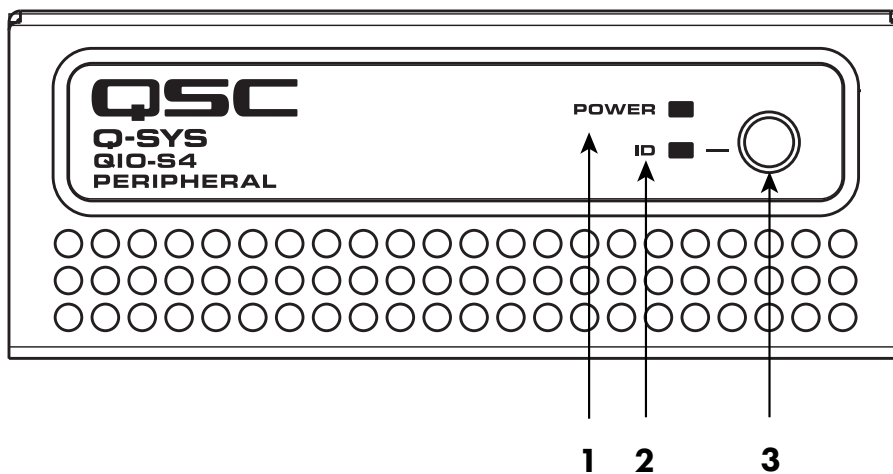

1. **Power LED** – Illuminates blue when the Q-SYS QIO-S4 is powered on.
2. **ID LED** – LED blinks green when placed into ID Mode via ID Button or Q-SYS Configurator.
3. **ID Button** – Locates the QIO-S4 in Q-SYS Designer Software and Q-SYS Configurator.

QIO-S4 Rear Panel

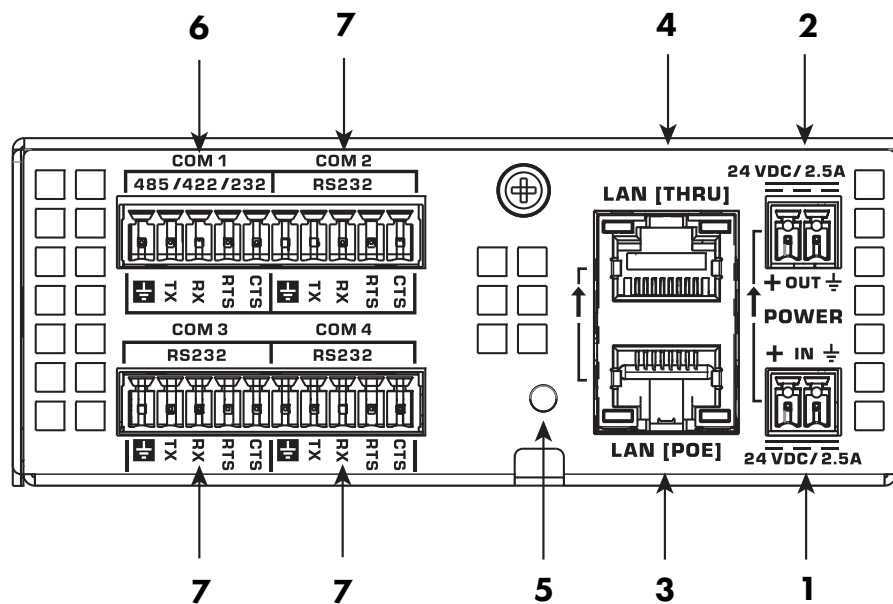

1. **External Power Input 24V DC 2.5 A** – Auxiliary power, 24V DC, 2.5 A, 2-pin Euro connector.
2. **Daisy-Chain Power Output 24V DC 2.5 A** - Auxiliary power, 24V DC, 2.5 A 2-pin Euro connector.
3. **LAN [PoE]** – RJ-45 connector, 802.3af PoE Type 1 Class 1 power, Q-LAN.
4. **LAN [THRU]** – RJ-45 connector, Ethernet daisy-chaining.
5. **Device Reset** – Use a paperclip or similar tool to restore default network settings and recover factory default settings. Before attempting a reset, refer to the Q-SYS Help for details.
6. **COM 1 Serial Port** – Configurable in Q-SYS Designer Software for RS232, RS485 Half-Duplex TX, RS485 Half-Duplex RX, or RS485/422 Full Duplex. See “QIO-S4 Serial Port Pinouts” on page 20.
7. **COM 2, COM 3, COM 4 Serial Ports** – Dedicated to RS232 communication. See “QIO-S4 Serial Port Pinouts” on page 20.

QIO-S4 Serial Port Pinouts

The QIO-S4 features four serial ports:

- COM 1 is configurable in Q-SYS Designer Software for RS232, RS485 Half Duplex TX, RS485 Half Duplex RX, or RS485/422 Full Duplex.
- COM 2-4 ports are dedicated to RS232 communication.

RS232 Pinout: COM 1 (Configurable), COM 2-4 (Dedicated)

Pin	Signal Flow	Description
	N/A	Signal ground
TX	Output	Transmit data
RX	Input	Receive data
RTS	Output	Ready to Send ²
CTS	Input	Clear to Send ²

² When using hardware flow control.

RS485 Half Duplex TX or RX Pinout: COM 1 (Configurable)

Pin	Signal Flow	Description
	N/A	Signal ground
TX	Input/Output	Differential B-
RX	(Unused)	(Unused)
RTS	Input/Output	Differential A+
CTS	(Unused)	(Unused)

RS485/422 Full Duplex: COM 1 (Configurable)

Pin	Signal Flow	Description
	N/A	Signal ground
TX	Output	Differential Z- / Tx-
RX	Input	Differential A+ / Rx+
RTS	Output	Differential Y+ / Tx+
CTS	Input	Differential B- / Rx-

QIO-IR1x4 Front Panel

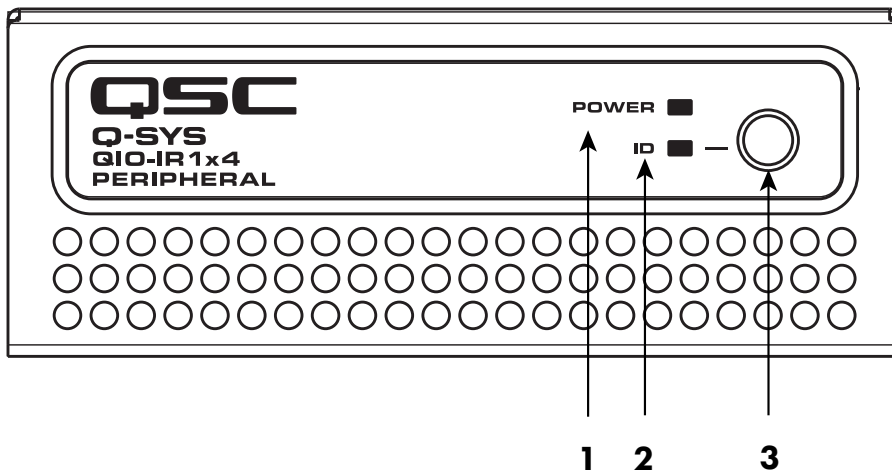

1. **Power LED** – Illuminates blue when the Q-SYS QIO-IR1x4 is powered on.
2. **ID LED** – LED blinks green when placed into ID Mode via ID Button or Q-SYS Configurator.
3. **ID Button** – Locates the QIO-IR1x4 in Q-SYS Designer Software and Q-SYS Configurator.

QIO-IR1x4 Rear Panel

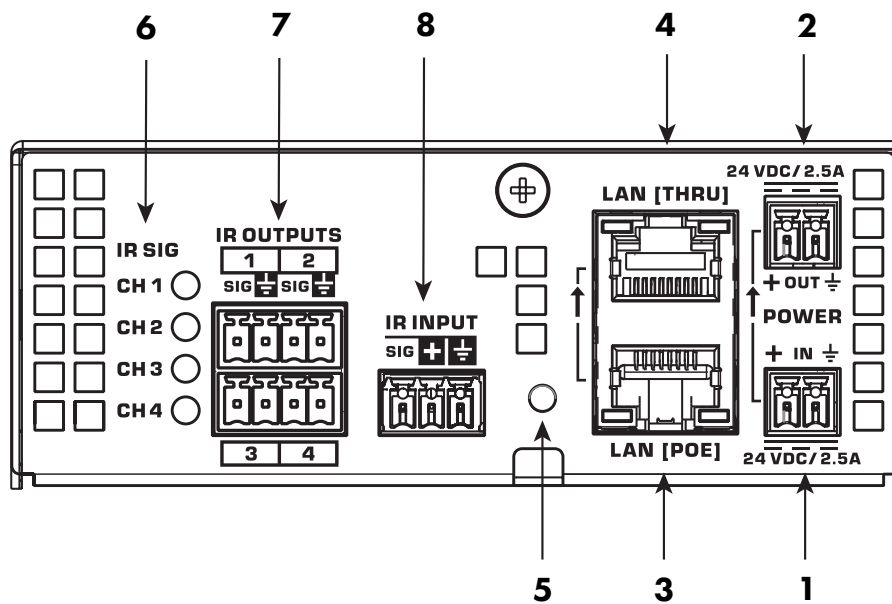

1. **External Power Input 24V DC 2.5 A** – Auxiliary power, 24V DC, 2.5 A, 2-pin Euro connector.
2. **Daisy-Chain Power Output 24V DC 2.5 A** - Auxiliary power, 24V DC, 2.5 A 2-pin Euro connector.
3. **LAN [PoE]** – RJ-45 connector, 802.3af PoE Type 1 Class 1 power, Q-LAN.
4. **LAN [THRU]** – RJ-45 connector, Ethernet daisy-chaining.
5. **Device Reset** – Use a paperclip or similar tool to restore default network settings and recover factory default settings. Before attempting a reset, refer to the Q-SYS Help for details.
6. **IR SIG LEDs** – Indicate transmit activity for CH/IR Output 1-4.
7. **IR Outputs** – Configurable in Q-SYS Designer Software as IR or Serial RS232. See “QIO-IR1x4 IR Port Pinouts” on page 22.
8. **IR Input** – Provides 3.3V DC and receives IR data. See “QIO-IR1x4 IR Port Pinouts” on page 22.

QIO-IR1 x4 IR Port Pinouts

The QIO-IR1 x4 features four IR outputs and one IR input:

- Outputs 1-4 are configurable in Q-SYS Designer Software for IR or Serial RS232 mode.
- Input provides 3.3V DC and receives IR data.



IR Output 1-4: IR Mode Pinout

Pin	Signal Flow	Description
SIG	Output	IR transmit data
	N/A	Signal reference

IR Output 1-4: Serial RS232 Mode Pinout

Pin	Signal Flow	Description
SIG	Output	RS232 transmit data
	N/A	Signal reference

IR Input Pinout

Pin	Signal Flow	Description
SIG	Input	IR receive data
	Output	3.3V DC
	N/A	Signal reference

QIO-LVR4 Front Panel

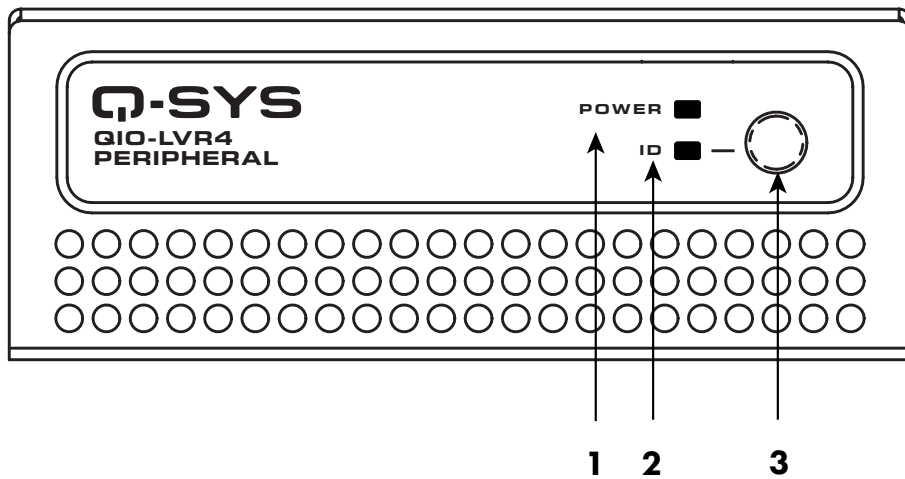

1. **Power LED** – Illuminates blue when the Q-SYS QIO-LVR4 is powered on.
2. **ID LED** – LED blinks green when placed into ID Mode via ID Button or Q-SYS Configurator.
3. **ID Button** – Locates the QIO-LVR4 in Q-SYS Designer Software and Q-SYS Configurator.

QIO-LVR4 Rear Panel

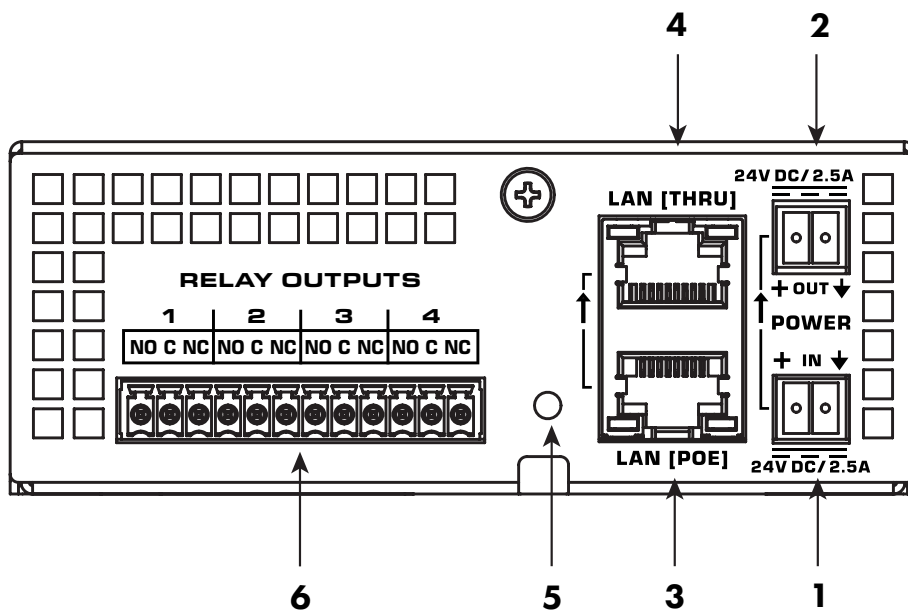



1. **External Power Input 24V DC 2.5 A** – Auxiliary power, 24V DC, 2.5 A, 2-pin Euro connector.
2. **Daisy-Chain Power Output 24V DC 2.5 A** - Auxiliary power, 24V DC, 2.5 A 2-pin Euro connector.
3. **LAN [PoE]** – RJ-45 connector, 802.3af PoE Type 1 Class 1 power, Q-LAN.
4. **LAN [THRU]** – RJ-45 connector, Ethernet daisy-chaining.
5. **Device Reset** – Use a paperclip or similar tool to restore default network settings and recover factory default settings. Before attempting a reset, refer to the Q-SYS Help for details.
6. **Relay Outputs** – Four relay circuits, 12-pin Euro connector: Normally Open (NO), Common (C), and Normally Closed (NC).

Rack Mount Installation

Q-SYS QIO Endpoints are designed to be mounted in a standard rack-mount unit using the Q-SYS 1RU rack tray (FG-901528-00, QIO-RMK). The rack tray accommodates up to four quarter-rack width QIO devices or two half-rack width (QIO-FLEX4A) devices. A QIO-FLEX4A unit can occupy the left, right, or center of the tray.

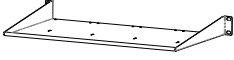
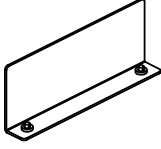
Rack Tray Hardware

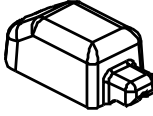
	(1x) Rack mounting tray		(3x) Blanking plates		(14x) M3 x 6 mm flat head screws		(4x) Retaining clips
---	----------------------------	---	-------------------------	---	-------------------------------------	---	-------------------------

Attach the Retaining Clips

For each QIO Endpoint you are installing in the tray, insert and attach a retaining clip in either the short (5.5") or long (8.5") length location using a flat head screw.

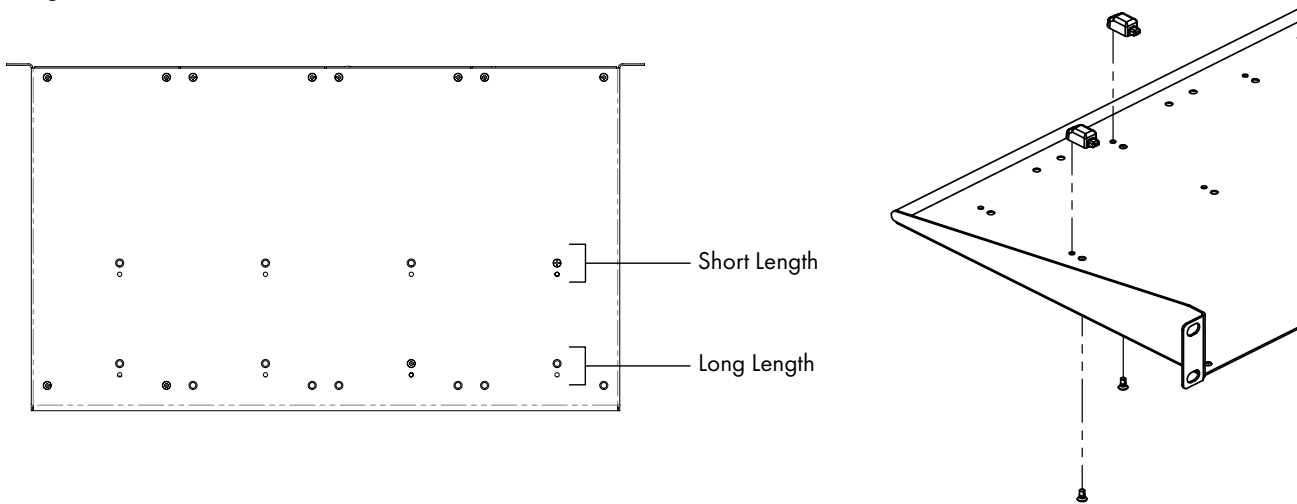

Attach the QIO Endpoints and Blanking Plates

Slide each QIO Endpoint into a retaining clip. Attach each unit with two flat head screws. Optionally attach the blanking plates, each with two flat head screws.

NOTE: Blanking plates are optional and can be used to facilitate proper rack airflow. Unused blanking plates can be attached at the rear of the tray if needed, as shown.

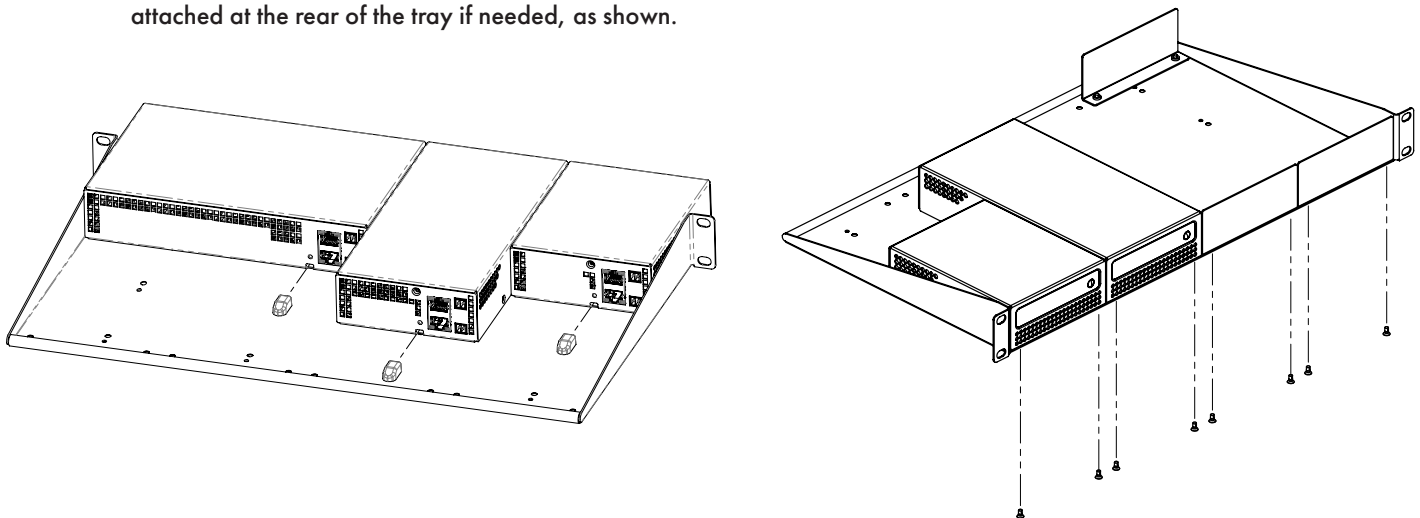

Surface Mount Installation

The QIO Endpoints can also be mounted under a table, on top of a table, or on a wall. For any of these mounting applications, use the surface mounting bracket and pan head screws included with the QIO Endpoint ship kit. The brackets are symmetrical to accommodate mounting right-side up to a ground-facing surface.

NOTE: Fasteners for attaching the bracket to a surface are pictured as an example but not provided.

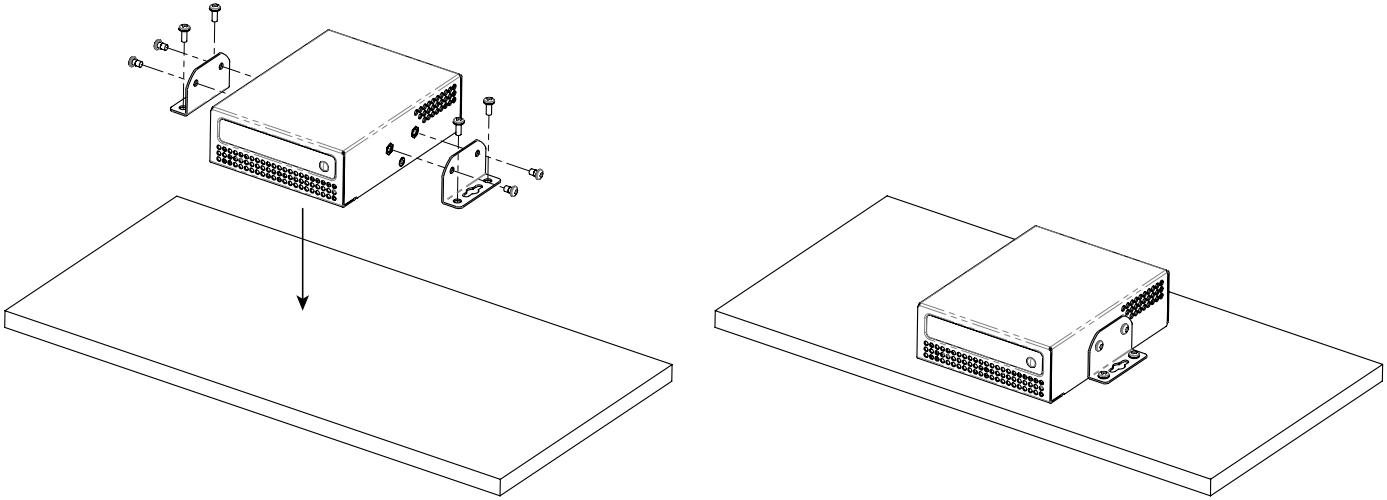

Freestanding Installation

For freestanding installation on a table top, apply the four adhesive foam spacers to the underside of the unit.

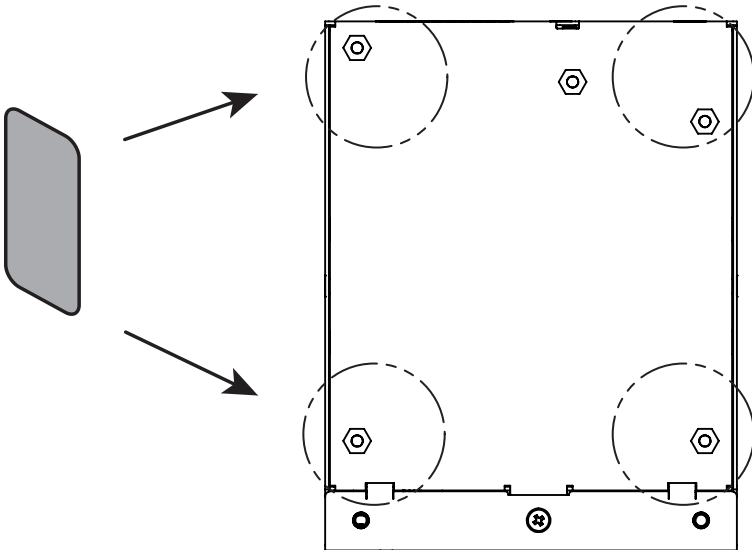



Knowledge Base

Find answers to common questions, troubleshooting information, tips, and application notes. Link to support policies and resources, including Q-SYS Help, software and firmware, product documents, and training videos. Create support cases.

support.qsys.com

Customer Support

Refer to the Contact Us page on the Q-SYS website for Technical Support and Customer Care, including their phone numbers and hours of operation.

qsys.com/contact-us/

Warranty

For a copy of the QSC Limited Warranty, go to:

qsys.com/support/warranty-statement/