

## EKI-K82T47C

### 6 x 4 MP ColorVu Turret +180° Panoramic IP KIT



- 6 x 4MP ColorVu TURRET CAMERAS DS-2CD1347G2-LUF(2.8mm)
- 1 x 4MP 180° PANORAMIC ColorVu CAMERA DS-2CD2347G2P-LSU/SL(2.8mm)
- 1 x 4K 8-CHANNEL POE NVR ERI-K108-P8 with 2 TB HDD Pre-installed



## ▪ Specification - Camera

<b>Model:</b> DS-2CD1347G2-LUF (2.8mm)	
Image Sensor	1/3" Progressive Scan CMOS
Max. Resolution	2560 × 1440
Shutter Time	1/3 s to 1/100,000 s
Min. Illumination	Color: 0.001 Lux @ (F1.0, AGC ON), 0 Lux with light
Day & Night	24/7 color imaging
Angle Adjustment	Pan: 0° to 360°, tilt: 0° to 75°, rotate: 0° to 360°
<b>Lens</b>	
Lens Type	Fixed focal lens, 2.8mm
Focal Length & FOV	horizontal FOV: 96°, vertical FOV: 52°, diagonal FOV: 113°
Lens Mount	M12
Iris Type	Fixed
Aperture	F1.0
Depth of Field	2 m to ∞
<b>DORI</b>	
DORI	D: 64 m, O: 25 m, R: 12 m, I: 6 m
<b>Illuminator</b>	
Supplement Light Type	White Light
Supplement Light Range	Up to 30 m
Smart Supplement Light	Yes
<b>Video</b>	
Main Stream	50 Hz: 20 fps (2560 × 1440) 25 fps (1920 × 1080, 1280 × 720) 60 Hz: 20 fps (2560 × 1440) 24 fps (1920 × 1080, 1280 × 720)
Sub-Stream	50 Hz: 25 fps (1280 × 720, 640 × 480, 640 × 360) 60 Hz: 24 fps (1280 × 720, 640 × 480, 640 × 360)
Video Compression	Main stream: H.265+/H.265/H.264+/H.264, Sub-stream: H.265/H.264/MJPEG
Video Bit Rate	32 Kbps to 8 Mbps
H.264 Type	Baseline Profile, Main Profile, High Profile
H.265 Type	Main Profile
Bit Rate Control	CBR, VBR
Region of Interest (ROI)	1 fixed region(s) for main stream
<b>Audio</b>	
Audio Type	Mono sound
Environment Noise Filtering	Yes
Audio Sampling Rate	8 kHz/16 kHz
Audio Compression	G.711ulaw/G.711alaw/G.722.1/G.726/MP2L2/PCM/AAC-LC
Audio Bit Rate	64 Kbps (G.711 ulaw)/64 Kbps (G.711 alaw)/16 Kbps (G.722.1)/16 Kbps (G.726)/32 to 160 Kbps (MP2L2)/16 to 64 Kbps (AAC-LC)

<b>Network</b>	
Protocols	TCP/IP, ICMP, DHCP, DNS, HTTP, RTP, RTSP, NTP, IGMP, IPv6, UDP, QoS, FTP, SMTP
Simultaneous Live View	Up to 6 channels
API	Open Network Video Interface (Profile S, Profile T, Profile G), ISAPI, SDK
User/Host	Up to 32 users 3 user levels: administrator, operator, and user
Security	Password protection, complicated password, watermark, basic and digest authentication for HTTP, WSSE and digest authentication for Open Network Video Interface, security audit log, host authentication (MAC address)
Client	iVMS-4200, Hik-Connect
Web Browser	Plug-in required live view: IE 10, IE 11 Local service: Chrome 57.0+, Firefox 52.0+
<b>Image</b>	
Wide Dynamic Range (WDR)	120 dB
SNR	≥ 52 dB
Day/Night Switch	Day, Night, Auto, Schedule
Image Enhancement	BLC, HLC, 3D DNR
Image Settings	Rotate mode, saturation, brightness, contrast, sharpness, gain, white balance, adjustable by client software or web browser
Privacy Mask	4 programmable polygon privacy masks
<b>Interface</b>	
Ethernet Interface	1 RJ45 10 M/100 M self-adaptive Ethernet port
On-Board Storage	Built-in memory card slot, support microSD/microSDHC/microSDXC card, up to 256 GB
Built-in Microphone	Yes
Reset Key	Yes
<b>Event</b>	
Basic Event	Motion detection (support alarm triggering by specified target types (human and vehicle)), video tampering alarm, exception
Linkage	Upload to FTP/memory card , notify surveillance center, send email, trigger recording, trigger capture
<b>General</b>	
Power	12 VDC ± 25%, 0.4 A, max. 5 W, Ø5.5 mm coaxial power plug PoE: 802.3af, Class 3, 36 V to 57 V, 0.2 A to 0.15 A, max. 6.5 W
Material	Metal & Plastic
Dimension	Ø109.9 mm × 103.6 mm (Ø4.3" × 4.1")
Package Dimension	150 mm × 150 mm × 141 mm (5.9" × 5.9" × 5.6")
Weight	Approx. 420 g (0.9 lb.)
With Package Weight	Approx. 650 g (1.4 lb.)
Storage Conditions	-30 °C to 60 °C (-22 °F to 140 °F). Humidity 95% or less (non-condensing)
Startup and Operating Conditions	-30 °C to 60 °C (-22 °F to 140 °F). Humidity 95% or less (non-condensing)
Language	English, Ukrainian
General Function	Heartbeat, anti-banding, mirror, password protection, password reset via email

## Approval

EMC	FCC: 47 CFR Part 15, Subpart B CE-EMC: EN 55032: 2015, EN 61000-3-2: 2019, EN 61000-3-3: 2013 + A1: 2019, EN 50130-4: 2011 + A1: 2014 RCM: AS/NZS CISPR 32: 2015 KC: KN32: 2015, KN35: 2015
Safety	UL: UL 62368-1 CB: IEC 62368-1: 2014 + A11 CE-LVD: EN 62368-1: 2014/A11: 2017 BIS: IS 13252 (Part 1): 2010/IEC 60950-1: 2005
Environment	CE-RoHS: 2011/65/EU WEEE: 2012/19/EU Reach: Regulation (EC) No 1907/2006
Protection	IP67: IEC 60529-2013



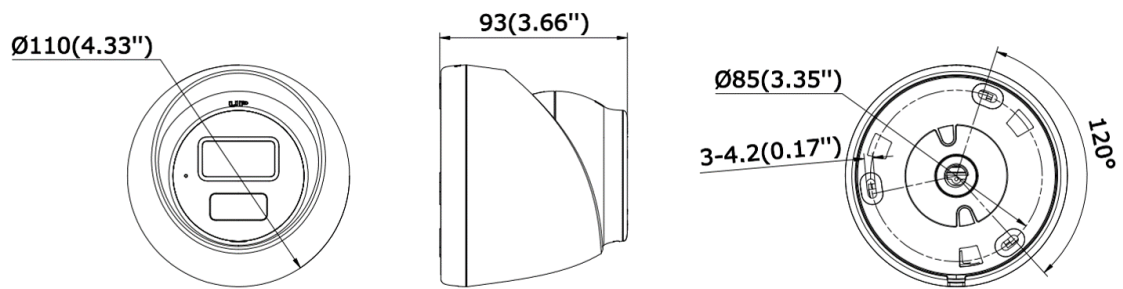

## Dimension



Unit:mm (inch)

## Accessory

### Optional

CM Corner Mount	CBS Junction Box	PM Vertical Pole Mount	ABS Inclined Ceiling Mount	WMS+PC110T Wall Mount
				

## ▪ Specification – Camera Model: DS-2CD2347G2P-LSU/SL

<b>Camera</b>	
Image Sensor	2 × 1/2.5" Progressive Scan CMOS
Max. Resolution	3040 × 1368
Min. Illumination	Color: 0.0005 Lux @ (F1.0, AGC ON), 0 Lux with light
Shutter Time	1/3 s to 1/100,000 s
Angle Adjustment	Pan: 0° to 30°, tilt: -75° to 75°
<b>Lens</b>	
Lens Type	Fixed focal lens, dual lens, 2.8 mm
Focal Length & FOV	2.8 mm, horizontal FOV: 180°, vertical FOV: 81°
Lens Mount	M12
Iris Type	Fixed
Aperture	F1.0
Depth of Field	2 m to ∞
<b>DORI</b>	
DORI	2.8 mm, D: 38 m, O: 15 m, R: 7.5 m, I: 3.5 m
<b>Illuminator</b>	
Supplement Light Type	White Light
Supplement Light Range	Up to 30 m
Smart Supplement Light	Yes
<b>Video</b>	
Main Stream	50 Hz: 25 fps (3040 × 1368) 60 Hz: 24 fps (3040 × 1368)
Sub-Stream	50 Hz: 25 fps (1200 × 536, 960 × 432) 60 Hz: 24 fps (1200 × 536, 960 × 432)
Video Compression	Main stream: H.265+/H.265/H.264+/H.264, Sub-stream: H.265/H.264/MJPEG
Video Bit Rate	32 Kbps to 8 Mbps
H.264 Type	Baseline Profile, Main Profile, High Profile
H.265 Type	Main Profile
Bit Rate Control	CBR, VBR
Scalable Video Coding (SVC)	H.264 and H.265 encoding
Region of Interest (ROI)	1 fixed region for main stream
<b>Audio</b>	
Audio Type	Mono sound
Audio Compression	G.711/G.722.1/G.726/MP2L2/PCM/MP3/AAC-LC
Audio Bit Rate	64 Kbps (G.711ulaw/G.711alaw)/16 Kbps (G.722.1)/16 Kbps (G.726)/32 to 192 Kbps (MP2L2)/8 to 320 Kbps (MP3)/16 to 64 Kbps (AAC-LC)
Audio Sampling Rate	8 kHz/16 kHz/32 kHz/44.1 kHz/48 kHz
Environment Noise Filtering	Yes
<b>Network</b>	
Protocols	TCP/IP, ICMP, HTTP, HTTPS, FTP, DHCP, DNS, DDNS, RTP, RTSP, RTCP, NTP, UPnP, SMTP, IGMP, 802.1X, QoS, IPv4, IPv6, UDP, Bonjour, SSL/TLS, PPPoE, SNMP, WebSocket, Websockets
Simultaneous Live View	Up to 6 channels
API	Open Network Video Interface (Profile S, Profile G, Profile T), ISAPI, SDK
User/Host	Up to 32 users, 3 user levels: administrator, operator, and user

Security	Password protection, complicated password, HTTPS encryption, 802.1X authentication (EAP-MD5), watermark, IP address filter, basic and digest authentication for HTTP/HTTPS, WSSE and digest authentication for Open Network Video Interface, RTP/RTSP over HTTPS, control timeout settings, security audit log, TLS 1.2, host authentication (MAC address)
Network Storage	NAS (NFS, SMB/CIFS),Auto Network Replenishment (ANR), Together with high-end Hikvision memory card, memory card encryption and health detection are supported.
Client	iVMS-4200,Hik-Connect,Hik-Central
Web Browser	Plug-in required live view: IE 10, IE 11, Plug-in free live view: Chrome 57.0+, Firefox 52.0+, Edge 89+, Local service: Chrome 57.0+, Firefox 52.0+, Edge 89+
<b>Image</b>	
Image Parameters Switch	Yes
Image Settings	Saturation,brightness,contrast,sharpness,gain,white balance,adjustable by client software or web browser
Day/Night Switch	Day,Night,Auto,Schedule
Wide Dynamic Range (WDR)	130 dB
SNR	≥ 52 dB
Image Enhancement	BLC,HLC,3D DNR
<b>Interface</b>	
Ethernet Interface	1 RJ45 10 M/100 M self-adaptive Ethernet port
On-Board Storage	Built-in memory card slot, support microSD/microSDHC/microSDXC card, up to 512 GB
Built-in Microphone	Yes
Built-in Speaker	Max. power consumption: 1.2 W, max. sound pressure level: 10 cm: 95 dB.
Audio	1 input (line in), terminal block, max. input amplitude: 3.3 Vpp, input impedance: 4.7 KΩ, interface type: non-equilibrium, 1 output (line out), terminal block, max. output amplitude: 3.3 Vpp, output impedance: 100 Ω, interface type: non-equilibrium
Alarm	1 input(s), 1 output(s) (max. 24 VDC/24 VAC, 1 A)
Reset Key	Yes
<b>Event</b>	
Basic Event	Motion detection (support alarm triggering by specified target types (human and vehicle)),alarm input and output,flashing alarm light output, audible alarm output, exception
Smart Event	Scene change detection
Linkage	Upload to FTP/NAS/memory card,notify surveillance center,send email,trigger alarm output,trigger recording,trigger capture,audible warning,white light flashing
<b>Deep Learning Function</b>	
Perimeter Protection	Line crossing, intrusion, region entrance, region exiting Support alarm triggering by specified target types (human and vehicle)
<b>General</b>	
Power	12 VDC ± 25%, 0.88 A, max. 10.5 W,Ø5.5 mm coaxial power plug,reverse polarity protection, PoE: IEEE 802.3af, Class 3, 36 V to 57 V, 0.35 A to 0.22 A, max. 12.5 W
Material	Base: metal, cover: metal

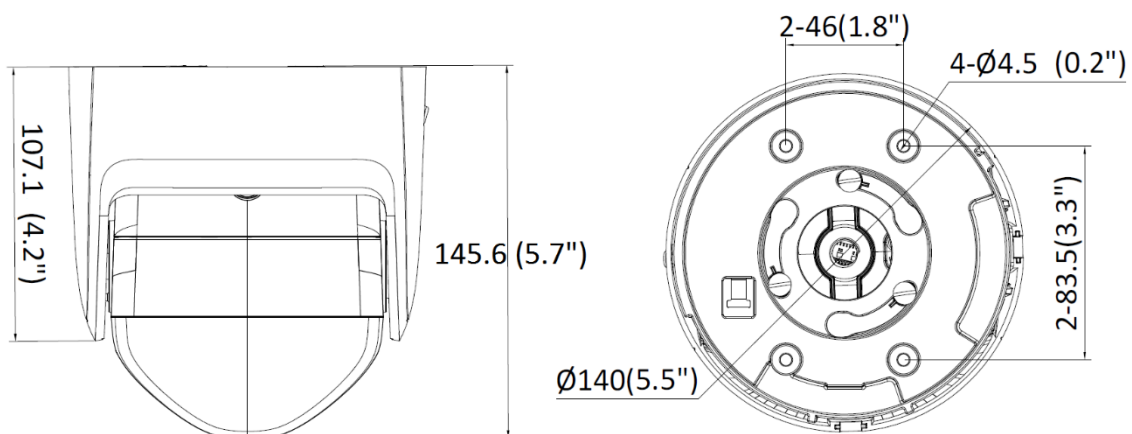

Dimension	Ø140 mm × 145.6 mm (Ø5.5" × 5.7")
Package Dimension	230 mm × 230 mm × 230 mm (9" × 9" × 9")
Weight	Approx. 920 g (2.0 lb.)
With Package Weight	Approx. 1670 g (3.7 lb.)
Storage Conditions	-30 °C to 60 °C (-22 °F to 140 °F). Humidity 95% or less (non-condensing)
Startup and Operating Conditions	-30 °C to 60 °C (-22 °F to 140 °F). Humidity 95% or less (non-condensing)
Language	33 languages: English, Russian, Estonian, Bulgarian, Hungarian, Greek, German, Italian, Czech, Slovak, French, Polish, Dutch, Portuguese, Spanish, Romanian, Danish, Swedish, Norwegian, Finnish, Croatian, Slovenian, Serbian, Turkish, Korean, Traditional Chinese, Thai, Vietnamese, Japanese, Latvian, Lithuanian, Portuguese (Brazil), Ukrainian
General Function	Anti-banding, heartbeat, mirror, flash log, pixel counter
Flashing Light	Yes
<b>Approval</b>	
EMC	FCC: 47 CFR Part 15, Subpart B, CE-EMC: EN 55032: 2015, EN 61000-3-2:2019, EN 61000-3-3: 2013+A1:2019, EN 50130-4: 2011 +A1: 2014, RCM: AS/NZS CISPR 32: 2015, IC: ICES-003: Issue 7
Safety	UL: UL 62368-1, CB: IEC 62368-1: 2014+A11, CE-LVD: EN 62368-1: 2014/A11: 2017
Environment	CE-RoHS: 2011/65/EU, WEEE: 2012/19/EU, Reach: Regulation (EC) No 1907/2006
Protection	IP67: IEC 60529-2013

## Dimension



Unit: mm(inch)

- Accessory
- Optional

<b>WML+PC140</b> Wall mount	<b>CPM+PC140</b> Pendant Mount
	



## ▪ Specification – NVR

<b>Model: ERI-K108-P8 (D)</b>	
<b>Motion Detection 2.0</b>	
Human/Vehicle Analysis	4-ch
<b>Video and Audio</b>	
IP Video Input	8-ch
Incoming Bandwidth	80 Mbps
Outgoing Bandwidth	80 Mbps
HDMI Output	1-ch, 4K (4096 x 2160)/30 Hz, 4K (3840 x 2160)/30 Hz, 2K (2560 x 1440)/60 Hz, 1920 x 1080/60 Hz, 1600 x 1200/60 Hz, 1280 x 1024/60 Hz, 1280 x 720/60 Hz
VGA Output	1-ch, 1920 x 1080/60 Hz, 1280 x 1024/60 Hz, 1280 x 720/60 Hz
Video Output Mode	HDMI/VGA simultaneous output
Audio Output	1-ch, RCA (Linear, 1 K $\Omega$ )
Two-Way Audio	1-ch, RCA (2.0 Vp-p, 1k $\Omega$ )
<b>Decoding</b>	
Decoding Format	H.265+/H.265/H.264+/H.264
Recording Resolution	8 MP/6 MP/5 MP/4 MP/3 MP/1080p/UXGA/ 720p/VGA/4CIF/DCIF/2CIF/CIF/QCIF
Synchronous playback	8-ch
Decoding Capability	1-ch@8 MP (30 fps)/3-ch@4 MP (30 fps)/6-ch@1080p (30 fps) *: The length or width of camera resolution (each track) cannot exceed 4096 pixels.
Stream Type	Video, Video & Audio
Audio Compression	G.711ulaw/G.711alaw/G.722/G.726
<b>Network</b>	
Remote Connection	32
Network Protocol	TCP/IP, DHCP, IPv4, IPv6, DNS, DDNS, NTP, RTSP, SADP, SMTP, SNMP, NFS, iSCSI, ISUP, UPnP™, HTTP, HTTPS
Network Interface	1 RJ-45 10/100 Mbps self-adaptive Ethernet interface
<b>PoE</b>	
Interface	8-ch, RJ-45 10/100 Mbps self-adaptive Ethernet interface
Power	≤ 75 W
Standard	IEEE 802.3 af/at
<b>Auxiliary Interface</b>	
SATA	1 SATA interface
Capacity	Up to 8 TB capacity for each disk
USB Interface	2 x USB 2.0
Alarm In/Out	N/A
<b>General</b>	
Power Supply	48 VDC, 1.88 A
Consumption	≤ 10 W (without HDD and PoE off)
Working Temperature	-10 °C to 55 °C (14 °F to 131 °F)
Working Humidity	10% to 90%
Dimension (W x D x H)	320 x 240 x 48 mm (12.4" x 9.4" x 1.9")
Weight	≤ 1 kg (without HDD, 2.2 lb.)

▪ **Available Model**

EKI-K82T47C

Distributed by

**HIKVISION®****Headquarters**

No.555 Qianmo Road, Binjiang District,  
Hangzhou 310051, China  
T +86-571-8807-5998  
overseasbusiness@hikvision.com

**Hikvision USA**  
T +1-909-895-0400  
sales.usa@hikvision.com

**Hikvision Australia**  
T +61-2-8599-4233  
salesau@hikvision.com

**Hikvision India**  
T +91-22-28469900  
sales@pramahikvision.com

**Hikvision Canada**  
T +1-866-200-6690  
sales.canada@hikvision.com

**Hikvision Thailand**  
T +662-275-9949  
sales.thailand@hikvision.com

**Hikvision Europe**  
T +31-23-5542770  
sales.eu@hikvision.com

**Hikvision Italy**  
T +39-0438-6902  
info.it@hikvision.com

**Hikvision Brazil**  
T +55 11 3318-0050  
Latam.support@hikvision.com

**Hikvision Turkey**  
T +90 (216)521 7070- 7074  
sales.tr@hikvision.com

**Hikvision Malaysia**  
T +601-7652-2413  
sales.my@hikvision.com

**Hikvision UK & Ireland**  
T +01628-902140  
sales.uk@hikvision.com

**Hikvision South Africa**  
Tel: +27 (10) 0351172  
sale.africa@hikvision.com

**Hikvision France**  
T +33(0)1-85-330-450  
info.fr@hikvision.com

**Hikvision Kazakhstan**  
T +7-727-9730667  
nikia.panfilov@hikvision.ru

**Hikvision Vietnam**  
T +84-974270888  
sales.vt@hikvision.com

**Hikvision UAE**  
T +971-4-4432090  
salesme@hikvision.com

**Hikvision Singapore**  
T +65-6684-4718  
sg@hikvision.com

**Hikvision Spain**  
T +34-91-737-16-55  
info.es@hikvision.com

**Hikvision Tashkent**  
T +99-87-1238-9438  
uzb@hikvision.ru

**Hikvision Hong Kong**  
T +852-2151-1761  
info.hk@hikvision.com

**Hikvision Russia**  
T +7-495-669-67-99  
saleru@hikvision.com

**Hikvision Korea**  
T +82-(0)31-731-8817  
sales.korea@hikvision.com

**Hikvision Poland**  
T +48-22-460-01-50  
info.pl@hikvision.com

**Hikvision Indonesia**  
T +62-21-2933759  
Sales.Indonesia@hikvision.com

**Hikvision Colombia**  
sales.colombia@hikvision.com