

Data Comm

DCRCM-15R

B-LINE
SERIES

RCM & RCM+™
enhancement
increasing network rack density





Energizing a world that demands more.

We deliver:

- **Electrical solutions** that use less energy, improve power reliability and make the places we live and work safer and more comfortable
- **Hydraulic and electrical solutions** that enable machines to deliver more productivity without wasting power
- **Aerospace solutions** that make aircraft lighter, safer and less costly to operate, and help airports operate more efficiently
- **Vehicle drivetrain and powertrain solutions** that deliver more power to cars, trucks and buses, while reducing fuel consumption and emissions

Discover today's Eaton.

Powering business worldwide

As a global power management company, we help customers worldwide manage the power needed for buildings, aircraft, trucks, cars, machinery and businesses.

Eaton's innovative technologies help customers manage electrical, hydraulic and mechanical power more reliably, efficiently, safely and sustainably.

We provide integrated solutions that help make energy, in all its forms, more practical and accessible.

With 2014 sales of \$22.6 billion, Eaton has approximately 100,000 employees around the world and sells products in more than 175 countries.

Eaton.com

EATON

Powering Business Worldwide

Table of Contents

Table of Contents	1
Rack Cable Management (RCM) Product Line Overview	2 & 3
RCM Products	
RCM Rack & Cable Management Value Pack	4
RCM High Density Cable Managers	5
RCM Dual Density Cable Managers	6
FLEXTRAY™ Lacing Device Kit	7
RCM Back Gate Kit	7
Rack Cable Management (RCM+) Product Line Overview	8 & 9
RCM+ Products	
RCM+ Rack Mounted Vertical Cable Manager with Cover - Single Sided High Density Plastic Finger Style	10 & 11
RCM+ Rack Mounted Vertical Cable Manager with Cover - Double Sided High Density Plastic Finger Style	12 & 13
RCM+ Rack Mounted Vertical Cable Manager - Single Sided Low Density Plastic Gate Style	14 & 15
RCM+ Rack Mounted Vertical Cable Manager - Double Sided Low Density Plastic Gate Style	16 & 17
RCM+ Rack Mounted Vertical Cable Manager with Cover - Double Sided Dual Density Style	18 & 19
RCM+ Vertical Cable Manager Door Kit	20
RCM+ Vertical Cable Manager Back Removable Cover	21
RCM+ Rack Mounted Horizontal Cable Manager With Cover Single Sided Plastic Finger Style	22
RCM+ Rack Mounted Horizontal Cable Manager With Cover Double Sided Plastic Finger Style	23
RCM+ Cable Management Finger Bracket Rack Mountable 11U Plastic Finger Style	24
RCM+ Cable Management Finger Bracket, 11U Plastic Finger Style	24
RCM+ Cable Management Plastic Gate Section	25
RCM+ Cable Management Cable Retaining Gate	25
RCM+ Cable Management Push-In Fastener & Cable Strap Mount	26
RCM+ Floor Mounting Bracket	26
VELCRO®+ Cable Hanger	27
VELCRO Buckle Strap	27
Eaton VELCRO Strap	27
RCM+ Cable Spools & Spool Kits	28
RCM+ Vertical Manager Kit	29
Product Guide	30
Cross Reference	30
Index	31 & 32

Cable Management - RCM

Rack Cable Management (RCM) Product Line Overview

Eaton's B-Line series rack cable management (RCM) product line provides ergonomic, sleek, and cost-effective options for standard network closet applications. The upgraded design features provide low-profile solutions and a common aesthetic with the RCM+ accessories for seamless integration across the two cable management product lines.

Front View



Rear View

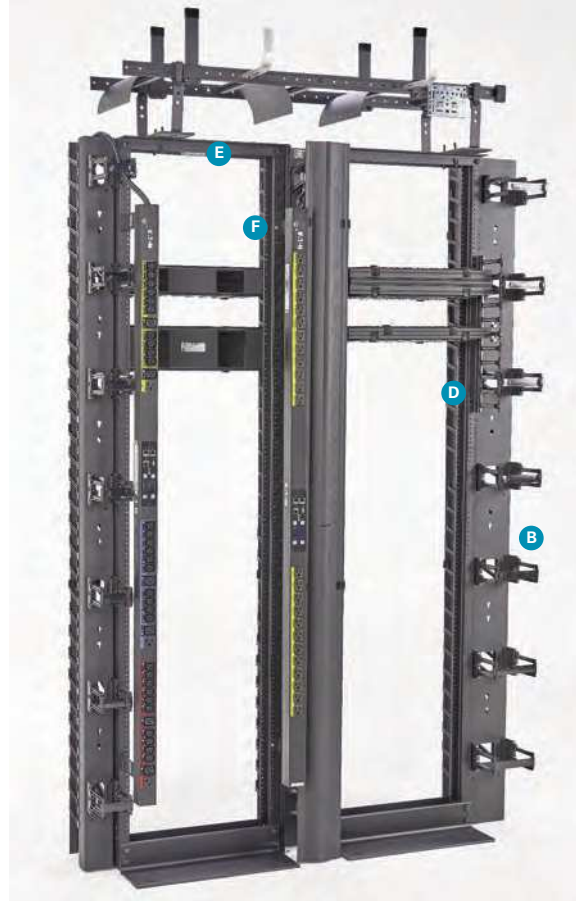

A RCM Dual Density Vertical Cable Manager

- Part No: SB86566DFB (see page 6)
- Stylistic, full-height door compatible with RCM+ standard horizontal cable management
- Sloped, high-density fingers for added support
- Plastic back gate kits for bulk cable support
- Available in 84" high and 3.6" or 6" wide versions

B RCM Back Gate Kit

- Part No: SB86306FTK (see page 7)
- Contains cable on back of single sided managers
- Snaps on for easy installation and removal

C RCM+ Standard Horizontal Cable Manager

- Part No: SB870192SFB (see page 22)
- Dual hinged door for easy access to network cables
- Compatible with RCM finger depths
- Available in single and double-sided versions

D RCM+ Rack Mountable Finger Bracket

- Part No: SB860FSFB (see page 24)
- Supports high density cabling applications
- Ideal for use with RCM Back Gate Kits (as shown)

E Two Post Rack

- Part No: SB556084XUFB (see DataComm catalog)
- 19" wide EIA mounting rails
- Light weight design, easy to install
- Compatible with full line of RCM and RCM+ cable management products

F Fixed ePDU Mounting Bracket

- Part No: SB3010FB (see DataComm catalog)
- Supports up to 3 vertical ePDU's
- Low profile design
- Mounts to rack equipment mounting holes

G Eaton Velcro®+ Straps

- Part No: SBCMVBCKL (see page 27)
- Stylistic support of cable bundles

H Redi-Rail Runway

- Part No: SB13AL12FB (see Redi-Rail Runway catalog)
- Flexible overhead cable support
- Removable rungs and accessories for on-site customization

† Mark shown is property of respective owner.

Rack Cable Management (RCM) Product Line Overview

Low-Profile Cabling Solutions To Minimize Rack Footprint

Low Profile 3.6"
Wide Vertical Cable
Managers Minimize
Network Rack Footprint



Compatible With Fixed &
Adjustable ePDU
Mounting Brackets



Compatible With RCM+ Accessories

RCM+ Standard Horizontal Cable Managers



RCM+ Telescopic
Cable Spool



Eaton Velcro® Straps



RCM Accessories

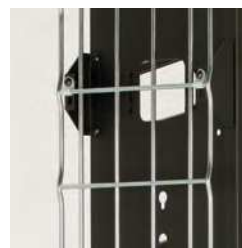

FLEXTRAY™ Kit

Value Pack's Available
For Fast Ordering



RCM Back Gate Kit



RCM Vertical Cable Manager Part Numbering System

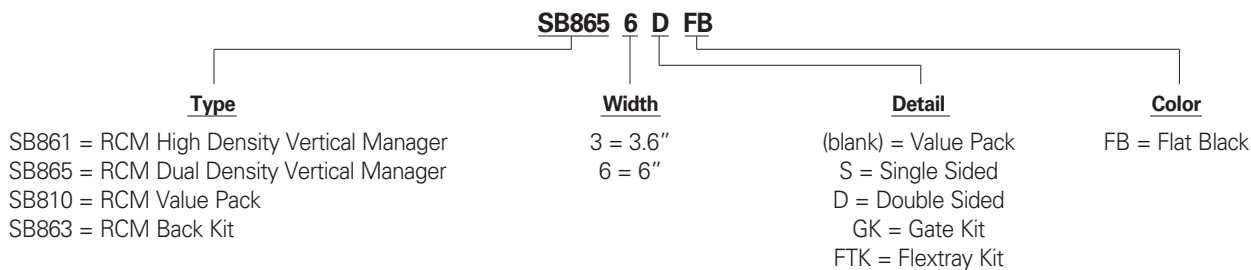

Cable Management - RCM

RCM Rack & Cable Management Value Pack

- Part number includes:
 One (1) Standard 19" (482mm) wide, 84" (2134mm) tall equipment rack (SB556084XUFB)
 Two (2) RCM high density single sided cable managers (SB861___FB, see page 5)
- Ships unassembled
- Stylistic, full-length cable management door compatible with RCM+ standard horizontal cable managers
- Rack is UL Listed (File No. E171936) as a communications circuit accessory
- Finish: Flat Black Powder Coat (FB)



Value Pack, 84" high x 6" wide
 vertical managers
SB81006FB



Sloped Fingers &
 Captive Mounting Nuts



Mounting Hardware

Catalog Number	Height		Cable Manager Width		Weight Each		Max CAT6A Cables Per Manager (50% Fill) (0.375" dia)
	In.	(mm)	In.	(mm)	Lbs.	(kg)	
SB81003FB	84"	(2134)	3.6"	(92)	44	(19.9)	86
SB81006FB	84"	(2134)	6.0"	(152)	55	(24.9)	153

RCM High Density Cable Managers

- Sloped fingers at 1.5U provide additional cable support
- Captive hardware for faster installation onto equipment rack
- Designed for fast, easy installation by one person
- Stylish, full-length door compatible with RCM+ standard horizontal cable managers
- Dual-hinged door provides cable access from either side
- Multiple cable pass-through openings with cable tie lances
- Finish: Flat Black Powder Coat (FB)

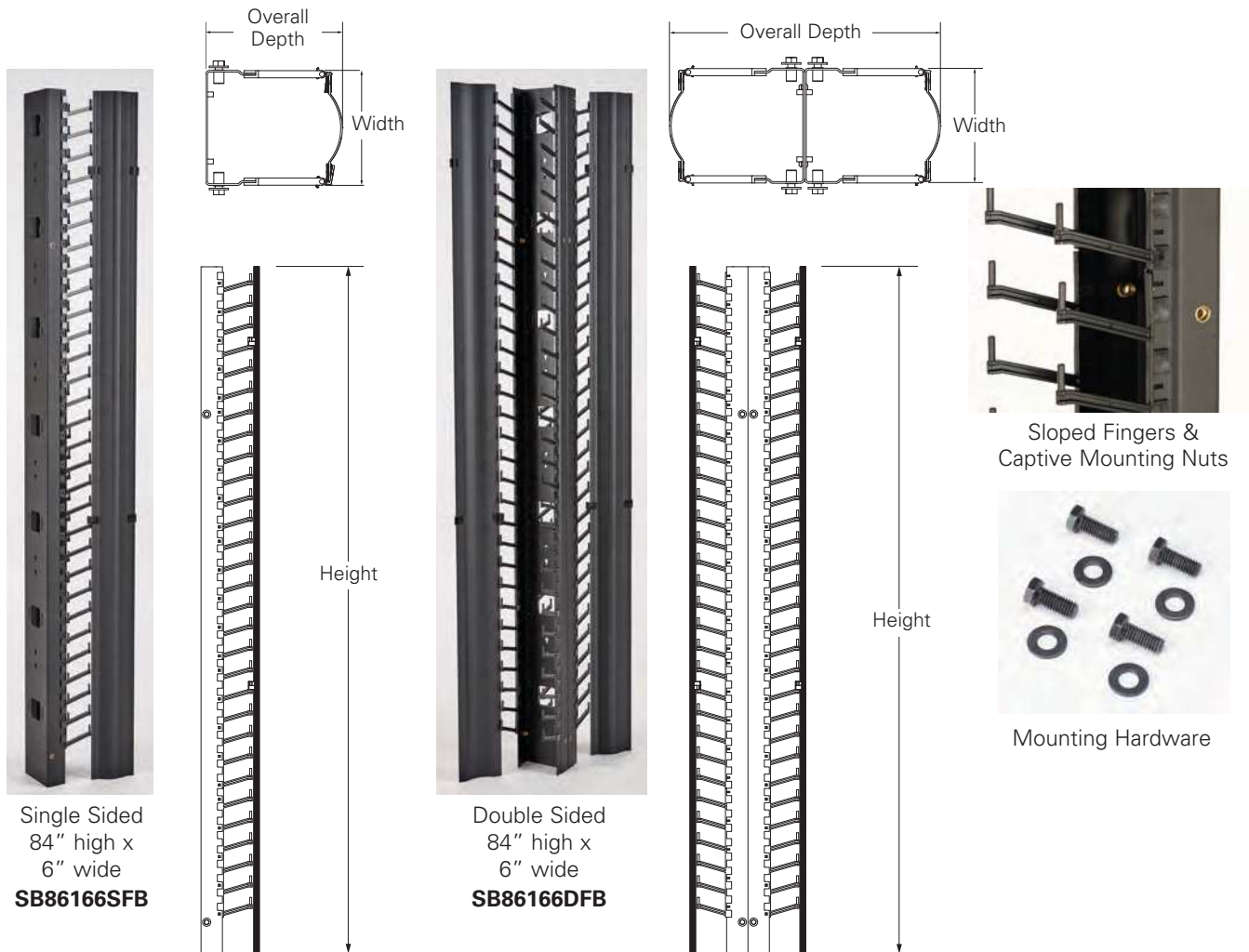

Catalog Number	Height		Width		Overall Depth		Configuration	Weight Each		Max CAT6A Cables Per Manager (50% Fill) (0.375" dia)
	In.	(mm)	In.	(mm)	In.	(mm)		Lbs.	(kg)	
SB86163SFB	84"	(2134)	3.6"	(92)	7.1"	(180)	Single	10.7	(4.8)	86
SB86166SFB	84"	(2134)	6.0"	(152)	7.1"	(180)	Single	22.3	(10.1)	153
SB86163DFB	84"	(2134)	3.6"	(92)	14.1"	(358)	Double	21.4	(9.7)	172
SB86166DFB	84"	(2134)	6.0"	(152)	14.1"	(358)	Double	44.6	(20.2)	307

Cable Management - RCM

RCM Dual Density Cable Managers

- Sloped fingers at 1.5U provide additional cable support
- Captive hardware for faster installation onto equipment rack
- Popular dual density configuration combines SB861 vertical manager with SB863 low density gates
- Designed for fast, easy installation by one person
- Stylish, full-length door compatible with RCM+ standard horizontal cable managers
- Dual-hinged door provides cable access from either side
- Multiple cable pass-through openings with cable tie lances
- Finish: Flat Black Powder Coat (FB)



Dual-Density
84" high x 6" wide
SB86566DFB

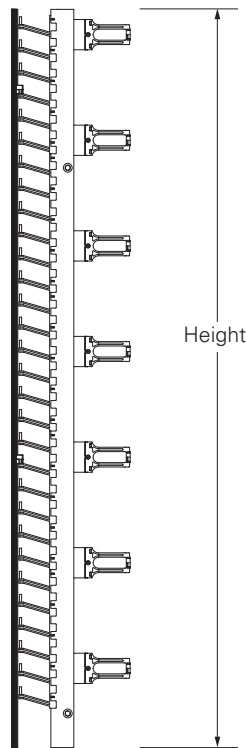
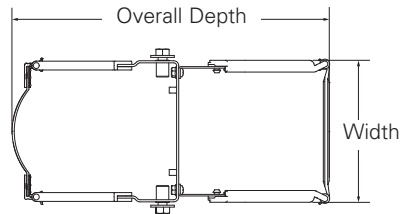

Sloped Fingers &
Captive Mounting Nuts



Mounting Hardware

Catalog Number	Height	Width	Overall Depth	Configuration	Weight Each	Max CAT6A Cables Per Manager (50% Fill) (0.375" dia)
	In. (mm)	In. (mm)	In. (mm)		Lbs. (kg)	
SB86563DFB	84" (2134)	3.6" (92)	13.5" (343)	Double	15.4 (7.0)	162
SB86566DFB	84" (2134)	6.0" (152)	13.5" (343)	Double	27.1 (12.3)	297

FLEXTRAY™ Lacing Device Kit for RCM System

- Kit installs easily onto the back of single-sided RCM cable managers
- Open framework leaves room for flexible cable lacing and attachment
- Available for 6" (152mm) wide vertical manager (SB86166SFB)
- Three (3) sets of mounting hardware included
- Finish: Flat Black Powder Coat (FB) Brackets
Electroplated Zinc FLEXTRAY

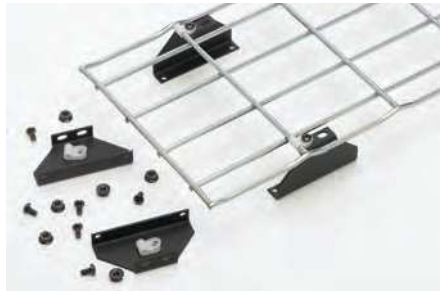

Mounting Hardware



Mounted On Cable Manager



Catalog Number	Height		Width		Weight Each	
	In.	(mm)	In.	(mm)	Lbs.	(kg)
SB86306FTK	84"	(2134)	6"	(152)	4.8	(2.2)

Flextray Kit 6" wide
SB86306FTK

RCM Back Gate Kit

- Gates contain cables on back of single sided managers
- Gate cover snaps on and off for easy installation and removal
- Available for 3.6" (92mm) and 6" (152mm) wide vertical managers
- Kits include seven (7) sets of gates and hardware



Back Gate Kit
6" wide
SB86306GK



Gates & Hardware



Gates & Hardware
Installed

Catalog Number	RCM Height		Width		Weight Each		Compatible With
	In.	(mm)	In.	(mm)	Lbs.	(kg)	
SB86303GK	84"	(2134)	3.6"	(92)	4.4	(2.0)	SB86163SFB
SB86306GK	84"	(2134)	6.0"	(152)	4.6	(2.1)	SB86166SFB

Cable Management - RCM+

Rack Cable Management Plus (RCM+) Product Line Overview

Eaton's B-Line series rack cable management plus (RCM+) product line is enhanced to provide greater network rack density, featuring up to 30% more total rack cable capacity versus leading competitors in its class. The patented system's innovative features include greater capacity, low-profile power mounting, and three color options, including the new Eaton White.

Front View



Rear View



A RCM+ Dual Density Vertical Cable Manager

- Part No: SB86486D084FB (see pages 18 & 19)
- Stylistic, full-height door compatible with quarter-turn latches for easy operation
- Extended fingers for high cable density applications
- Available in full line of heights, widths, and colors

B RCM+ Back Removable Cover

- Part No: SB862BRC6084FB (see page 21)
- Supports button-style mounting of full-height and half-height ePDU's directly to vertical manager
- Support cable spools and pathways

C RCM+ Extended Horizontal Cable Manager

- Part No: SB87019SX2FB (see page 22)
- Dual hinged door for easy access to network cables
- High capacity version compatible with RCM+ high density cable managers
- Available in single and double-sided versions

D RCM+ Floor Mounting Bracket

- Part No: SB860FMBFB (see page 26)
- Supports end-of-row vertical manager applications

E RCM+ Telescopic Cable Spools

- Part No: SB860ACSF (see page 28)
- Manages bend radius for cable bundles
- Compatible with RCM, RCM+, and HDNR vertical cable managers

F Adjustable ePDU Mounting Bracket

- Part No: SB3011FB (see DataComm catalog)
- Supports up to 2 vertical ePDU's
- Telescopic design
- Mounts to rack equipment mounting holes

G Eaton Velcro® Straps

- Part No: SBCMVBCKL (see page 27)
- Stylistic support of cable bundles

H Redi-Rail Runway

- Part No: SB13AL12FB (see Redi-Rail catalog)
- Flexible overhead cable support
- Removable rungs and accessories for on-site customization

† Mark shown is property of respective owner.

Rack Cable Management (RCM+) Product Line Overview

High Capacity Cabling Solutions To Increase Rack Density

High Density Vertical Managers With Extended Fingers



Low Profile ePDU Mounting On Back Removable Cover



Quarter-Turn Latches For Easy Door Operation



Compatible With RCM+ Extended Horizontal Cable Managers



Telescopic Cable Spool To Manage Bulk Cabling



Compatible With Full Line Of Eaton Cable And Power Management Accessories



VELCRO® Straps

ePDU Mounting Brackets

Extended Finger Design Available On All High Density Managers



Floor Mounting Brackets For Additional End-Of-Row Support



RCM+ Vertical Cable Manager Part Numbering System

Type	Depth	Width	Detail	Height	Color
SB860 = RCM+ High Density Vertical Manager	8 = 8.7"	3 = 3.6" 6 = 6"	S = Single Sided D = Double Sided	066 = 66" 072 = 72" 078 = 78" 084 = 84" 090 = 90" 096 = 96" 108 = 108"	FB = Flat Black SL = Silver EW = Eaton White
SB862 = RCM+ Low Density Vertical Manager		10 = 10" 12 = 12"			
SB864 = RCM+ Dual Density Vertical Manager					

† Mark shown is property of respective owner.

RCM+ Rack Mounted Vertical Cable Manager With Cover Single Sided High Density Plastic Finger Style

- Single-sided SB860 Series RCM+ vertical cable managers with extended fingers are designed for routing high density cabling by providing maximum cable support for each rack mounting space
- Stylistic, full length doors, with quarter-turn locking hinges, allow for quick opening from either side or complete removal
- Compatible with RCM+ extended horizontal cable managers
- Three (3) snap-on gates retain cables when doors are opened or removed. Gates can be placed at any location
- Open back design allows unrestricted front and rear routing of cables
- Installation is easy and can be done in minutes using standard hand tools
- Optional back removable covers are designed with pass through openings for cable routing, keyhole slots for cable spools, slots for cable straps, and keyhole slots for direct ePDU mounting
- 1/4" (6.3mm) accessory mounting holes run the full height on both sides of the cable manager to accommodate the attachment of cable management accessories
- UL Listed as a Communication Circuit Accessory. File No. E171936
- Material: Aluminum with UL 94V-0 black plastic components
- Finish___: Flat Black Powder Coat (FB), Silver Powder Coat (SL), or Eaton White (EW)
- Vertical cable manager includes:
(1) vertical cabling section, (1) door, (3) gates, (25) push-in fasteners,
(6) cable strap mounts, (2) cable retainer bars and mounting hardware



Outside Dim.	Inside Dim.
3.6"	2.6"
6.0"	5.0"
10.0"	9.0"
12.0"	11.0"

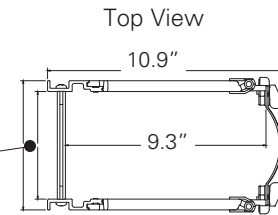

U.S. Patent 7,362,941
Other Patents Pending



Single sided,
84" high x 6" wide
SB86086S084FB



SB86086S084FB
shown with optional
back removable cover
(see page 21)

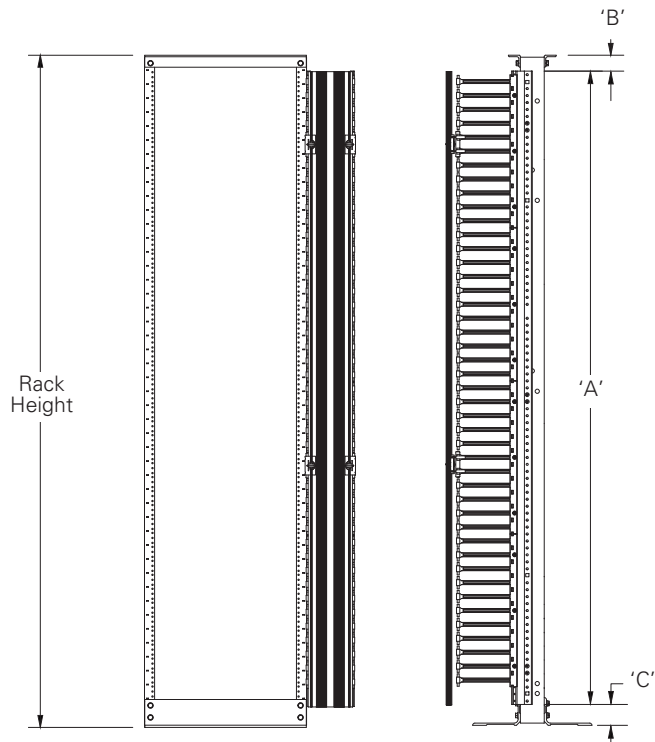

Continued on page 11.

**RCM+ Rack Mounted Vertical Cable Manager With Cover cont.
Single Sided High Density Plastic Finger Style**

Catalog Number	Fits Rack Height of In. (mm)	'A'		'B'		'C'		Weight Each		Max CAT6A Cables (0.375" OD) (50% Fill)
		In.	(mm)	In.	(mm)	In.	(mm)	Lbs.	(kg)	
3 ⁵ / ₈ " (92mm) Wide x 10 ⁵ / ₁₆ " (262mm) Deep										
SB86083S066__	66" (1676)	60 ³ / ₈ " (1533)		3" (76.2)		2 ⁵ / ₈ " (66.7)		11.8 (5.4)		109
SB86083S072__	72" (1829)	67 ³ / ₈ " (1711)		2" (50.8)		2 ⁵ / ₈ " (66.7)		13.3 (6.0)		109
SB86083S078__	78" (1981)	72 ⁵ / ₈ " (1845)		2 ³ / ₄ " (69.9)		2 ⁵ / ₈ " (66.7)		14.3 (6.5)		109
✓ SB86083S084__	84" (2133)	79 ⁵ / ₈ " (2022)		1 ³ / ₄ " (44.4)		2 ⁵ / ₈ " (66.7)		15.5 (7.0)		109
SB86083S090__	90" (2286)	84 ⁷ / ₈ " (2156)		2 ¹ / ₂ " (63.5)		2 ⁵ / ₈ " (66.7)		16.5 (7.5)		109
SB86083S096__	96" (2438)	90 ¹ / ₈ " (2289)		3 ¹ / ₄ " (82.6)		2 ⁵ / ₈ " (66.7)		17.6 (8.0)		109
SB86083S108__	108" (2743)	102 ³ / ₈ " (2600)		3" (76.2)		2 ⁵ / ₈ " (66.7)		20.0 (9.0)		109
6" (152mm) Wide x 10 ⁵ / ₁₆ " (262mm) Deep										
SB86086S066__	66" (1676)	60 ³ / ₈ " (1533)		3" (76.2)		2 ⁵ / ₈ " (66.7)		13.4 (6.1)		210
SB86086S072__	72" (1829)	67 ³ / ₈ " (1711)		2" (50.8)		2 ⁵ / ₈ " (66.7)		14.9 (6.9)		210
SB86086S078__	78" (1981)	72 ⁵ / ₈ " (1845)		2 ³ / ₄ " (69.9)		2 ⁵ / ₈ " (66.7)		16.1 (7.3)		210
✓ SB86086S084__	84" (2133)	79 ⁵ / ₈ " (2022)		1 ³ / ₄ " (44.4)		2 ⁵ / ₈ " (66.7)		17.4 (7.9)		210
SB86086S090__	90" (2286)	84 ⁷ / ₈ " (2156)		2 ¹ / ₂ " (63.5)		2 ⁵ / ₈ " (66.7)		18.6 (8.4)		210
SB86086S096__	96" (2438)	90 ¹ / ₈ " (2289)		3 ¹ / ₄ " (82.6)		2 ⁵ / ₈ " (66.7)		19.9 (9.0)		210
SB86086S108__	108" (2743)	102 ³ / ₈ " (2600)		3" (76.2)		2 ⁵ / ₈ " (66.7)		22.5 (10.2)		210
10" (254mm) Wide x 10 ⁵ / ₁₆ " (262mm) Deep										
SB860810S066__	66" (1676)	60 ³ / ₈ " (1533)		3" (76.2)		2 ⁵ / ₈ " (66.7)		16.3 (7.4)		378
SB860810S072__	72" (1829)	67 ³ / ₈ " (1711)		2" (50.8)		2 ⁵ / ₈ " (66.7)		18.3 (8.3)		378
SB860810S078__	78" (1981)	72 ⁵ / ₈ " (1845)		2 ³ / ₄ " (69.9)		2 ⁵ / ₈ " (66.7)		19.6 (8.9)		378
✓ SB860810S084__	84" (2133)	79 ⁵ / ₈ " (2022)		1 ³ / ₄ " (44.4)		2 ⁵ / ₈ " (66.7)		21.3 (9.7)		378
SB860810S090__	90" (2286)	84 ⁷ / ₈ " (2156)		2 ¹ / ₂ " (63.5)		2 ⁵ / ₈ " (66.7)		22.7 (10.3)		378
SB860810S096__	96" (2438)	90 ¹ / ₈ " (2289)		3 ¹ / ₄ " (82.6)		2 ⁵ / ₈ " (66.7)		24.3 (11.0)		378
SB860810S108__	108" (2743)	102 ³ / ₈ " (2600)		3" (76.2)		2 ⁵ / ₈ " (66.7)		27.5 (12.5)		378
12" (305mm) Wide x 10 ⁵ / ₁₆ " (262mm) Deep										
SB860812S066__	66" (1676)	60 ³ / ₈ " (1533)		3" (76.2)		2 ⁵ / ₈ " (66.7)		20.2 (9.2)		463
SB860812S072__	72" (1829)	67 ³ / ₈ " (1711)		2" (50.8)		2 ⁵ / ₈ " (66.7)		22.6 (10.2)		463
SB860812S078__	78" (1981)	72 ⁵ / ₈ " (1845)		2 ³ / ₄ " (69.9)		2 ⁵ / ₈ " (66.7)		24.3 (11.0)		463
SB860812S084__	84" (2133)	79 ⁵ / ₈ " (2022)		1 ³ / ₄ " (44.4)		2 ⁵ / ₈ " (66.7)		26.4 (12.0)		463
SB860812S090__	90" (2286)	84 ⁷ / ₈ " (2156)		2 ¹ / ₂ " (63.5)		2 ⁵ / ₈ " (66.7)		28.2 (12.8)		463
SB860812S096__	96" (2438)	90 ¹ / ₈ " (2289)		3 ¹ / ₄ " (82.6)		2 ⁵ / ₈ " (66.7)		30.3 (13.7)		463
SB860812S108__	108" (2743)	102 ³ / ₈ " (2600)		3" (76.2)		2 ⁵ / ₈ " (66.7)		34.0 (15.4)		463

Finish___: Flat Black Powder Coat (FB), Silver Powder Coat (SL), or Eaton White (EW)

✓ Popular items include (FB) 84" high in 3⁵/₈", 6" and 10" widths

A = Height of RCM+ vertical section without doors

B = Distance between the top of the rack and the top of the RCM+ cable manager

C = Distance between the floor and the lowest part of the RCM+ cable manager

RCM+ Rack Mounted Vertical Cable Manager With Cover Double Sided High Density Plastic Finger Style

- Single-sided SB860 Series RCM+ vertical cable managers with extended fingers are designed for routing high density cabling by providing maximum cable support for each rack mounting space. Provides greater cable capacity with access doors and gates on the front and rear
- Front and rear vertical sections can be spaced apart when mounting on racks deeper than 3" (76mm)
- Compatible with RCM+ extended horizontal cable managers
- Stylistic, full length doors, with quarter-turn locking hinges, allow for quick opening from either side or complete removal
- Six (6) snap-on gates retain cables when doors are opened or removed. Gates can be placed at any location
- Open back design allows unrestricted routing of cables between front and rear cables managers
- Installation is easy and can be done in minutes using standard hand tools
- Optional back removable covers are designed with pass through openings for cable routing, keyhole slots for cable spools, slots for cable straps, and keyhole slots for direct ePDU mounting
- 1/4" (6.3mm) accessory mounting holes run the full height on both sides of the cable manager to accommodate the attachment of cable management accessories
- UL Listed as a Communication Circuit Accessory. File No. E171936
- Material: Aluminum with UL 94V-0 black plastic components
- Finish___: Flat Black Powder Coat (FB), Silver Powder Coat (SL), or Eaton White (EW)
- Vertical cable manager includes:
(2) vertical cabling sections, (2) doors,
(6) gates, (50) push-in fasteners,
(12) cable strap mounts, (4) cable retainer bars and mounting hardware.
On 10" and 12" wide cable managers only, (2) spool kits are included

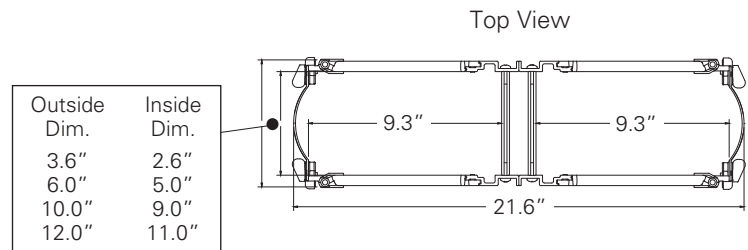

U.S. Patent 7,362,941
Other Patents Pending



Double sided,
84" high x 6" wide
SB86086D084FB

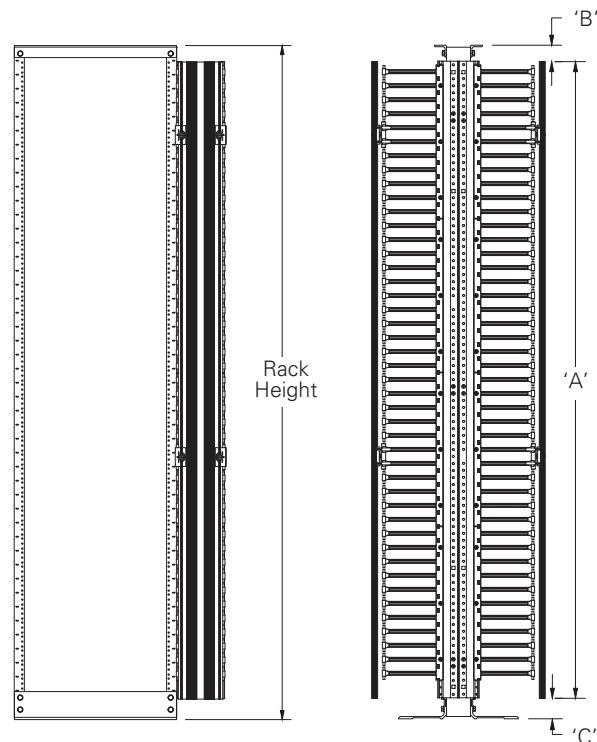

Continued on page 13.

**RCM+ Rack Mounted Vertical Cable Manager With Cover cont.
Double Sided High Density Plastic Finger Style**

Catalog Number	Fits Rack Height of In. (mm)	'A'		'B'		'C'		Weight Each		Max CAT6A Cables (0.375" OD) (50% Fill)
		In.	(mm)	In.	(mm)	In.	(mm)	Lbs.	(kg)	
3 ⁵ / ₈ " (92mm) Wide x 20 ³ / ₈ " (517mm) Deep										
SB86083D066__	66" (1676)	60 ³ / ₈ " (1533)		3" (76.2)		2 ⁵ / ₈ " (66.7)		23.7	(10.7)	218
SB86083D072__	72" (1829)	67 ³ / ₈ " (1711)		2" (50.8)		2 ⁵ / ₈ " (66.7)		26.5	(12.0)	218
SB86083D078__	78" (1981)	72 ⁵ / ₈ " (1845)		2 ³ / ₄ " (69.9)		2 ⁵ / ₈ " (66.7)		28.5	(12.9)	218
✓ SB86083D084__	84" (2133)	79 ⁵ / ₈ " (2022)		1 ³ / ₄ " (44.4)		2 ⁵ / ₈ " (66.7)		30.9	(14.0)	218
SB86083D090__	90" (2286)	84 ⁷ / ₈ " (2156)		2 ¹ / ₂ " (63.5)		2 ⁵ / ₈ " (66.7)		33.1	(15.0)	218
SB86083D096__	96" (2438)	90 ¹ / ₈ " (2289)		3 ¹ / ₄ " (82.6)		2 ⁵ / ₈ " (66.7)		35.3	(16.0)	218
SB86083D108__	108" (2743)	102 ³ / ₈ " (2600)		3" (76.2)		2 ⁵ / ₈ " (66.7)		39.9	(18.1)	218
6" (152mm) Wide x 20 ³ / ₈ " (517mm) Deep										
SB86086D066__	66" (1676)	60 ³ / ₈ " (1533)		3" (76.2)		2 ⁵ / ₈ " (66.7)		26.7	(12.1)	421
SB86086D072__	72" (1829)	67 ³ / ₈ " (1711)		2" (50.8)		2 ⁵ / ₈ " (66.7)		29.9	(13.6)	421
SB86086D078__	78" (1981)	72 ⁵ / ₈ " (1845)		2 ³ / ₄ " (69.9)		2 ⁵ / ₈ " (66.7)		32.1	(14.6)	421
✓ SB86086D084__	84" (2133)	79 ⁵ / ₈ " (2022)		1 ³ / ₄ " (44.4)		2 ⁵ / ₈ " (66.7)		34.9	(15.8)	421
SB86086D090__	90" (2286)	84 ⁷ / ₈ " (2156)		2 ¹ / ₂ " (63.5)		2 ⁵ / ₈ " (66.7)		37.2	(16.9)	421
SB86086D096__	96" (2438)	90 ¹ / ₈ " (2289)		3 ¹ / ₄ " (82.6)		2 ⁵ / ₈ " (66.7)		39.9	(18.1)	421
SB86086D108__	108" (2743)	102 ³ / ₈ " (2600)		3" (76.2)		2 ⁵ / ₈ " (66.7)		45.0	(20.4)	421
10" (254mm) Wide x 20 ³ / ₈ " (517mm) Deep										
SB860810D066__	66" (1676)	60 ³ / ₈ " (1533)		3" (76.2)		2 ⁵ / ₈ " (66.7)		38.4	(17.4)	757
SB860810D072__	72" (1829)	67 ³ / ₈ " (1711)		2" (50.8)		2 ⁵ / ₈ " (66.7)		42.8	(19.4)	757
SB860810D078__	78" (1981)	72 ⁵ / ₈ " (1845)		2 ³ / ₄ " (69.9)		2 ⁵ / ₈ " (66.7)		46.1	(20.9)	757
✓ SB860810D084__	84" (2133)	79 ⁵ / ₈ " (2022)		1 ³ / ₄ " (44.4)		2 ⁵ / ₈ " (66.7)		49.9	(22.6)	757
SB860810D090__	90" (2286)	84 ⁷ / ₈ " (2156)		2 ¹ / ₂ " (63.5)		2 ⁵ / ₈ " (66.7)		52.6	(23.9)	757
SB860810D096__	96" (2438)	90 ¹ / ₈ " (2289)		3 ¹ / ₄ " (82.6)		2 ⁵ / ₈ " (66.7)		56.8	(25.8)	757
SB860810D108__	108" (2743)	102 ³ / ₈ " (2600)		3" (76.2)		2 ⁵ / ₈ " (66.7)		64.0	(29.1)	757
12" (305mm) Wide x 20 ³ / ₈ " (517mm) Deep										
SB860812D066__	66" (1676)	60 ³ / ₈ " (1533)		3" (76.2)		2 ⁵ / ₈ " (66.7)		46.3	(21.0)	926
SB860812D072__	72" (1829)	67 ³ / ₈ " (1711)		2" (50.8)		2 ⁵ / ₈ " (66.7)		51.4	(23.3)	926
SB860812D078__	78" (1981)	72 ⁵ / ₈ " (1845)		2 ³ / ₄ " (69.9)		2 ⁵ / ₈ " (66.7)		55.4	(25.1)	926
SB860812D084__	84" (2133)	79 ⁵ / ₈ " (2022)		1 ³ / ₄ " (44.4)		2 ⁵ / ₈ " (66.7)		60.0	(27.2)	926
SB860812D090__	90" (2286)	84 ⁷ / ₈ " (2156)		2 ¹ / ₂ " (63.5)		2 ⁵ / ₈ " (66.7)		63.6	(28.9)	926
SB860812D096__	96" (2438)	90 ¹ / ₈ " (2289)		3 ¹ / ₄ " (82.6)		2 ⁵ / ₈ " (66.7)		68.7	(31.2)	926
SB860812D108__	108" (2743)	102 ³ / ₈ " (2600)		3" (76.2)		2 ⁵ / ₈ " (66.7)		77.1	(35.0)	926

Finish___: Flat Black Powder Coat (FB), Silver Powder Coat (SL), or Eaton White (EW)

✓ Popular items include (FB) 84" high in 3⁵/₈", 6" and 10" widths

A = Height of RCM+ vertical section without doors

B = Distance between the top of the rack and the top of the RCM+ cable manager

C = Distance between the floor and the lowest part of the RCM+ cable manager

RCM+ Rack Mounted Vertical Cable Manager Single Sided Low Density Plastic Gate Style

- Single-sided SB862 Series RCM+ low density vertical cable managers are designed for routing cabling on and between racks
- Vertical cabling section can be used with RCM+ standard horizontal cable managers
- Snap-on gates allow for quick opening from either side or complete removal
- Open back design allows unrestricted front and rear routing of cables
- Optional back removable covers are designed with pass through openings for cable routing, keyhole slots for cable spools, slots for cable straps, and keyhole slots for direct ePDU mounting
- Installation is easy and can be performed in minutes using standard hand tools
- 1/4" (6.3mm) accessory mounting holes run the full height on both sides of the cable manager to accommodate the attachment of cable management accessories
- UL Listed as a Communication Circuit Accessory. File No. E171936
- Material: Aluminum with UL 94V-0 black plastic components.
- Finish___: Flat Black Powder Coat (FB), Silver Powder Coat (SL), or Eaton White (EW)
- Vertical cable manager includes:
(1) vertical cabling section, (25) push-in fasteners,
(6) cable strap mounts, (2) cable retainer bars,
required number of gates, and mounting hardware



U.S. Patent 7,362,941
Other Patents Pending



Single sided,
84" high x 6" wide
SB86286S084FB



SB86286S084FB
shown with optional
back removable cover
(see page 21)

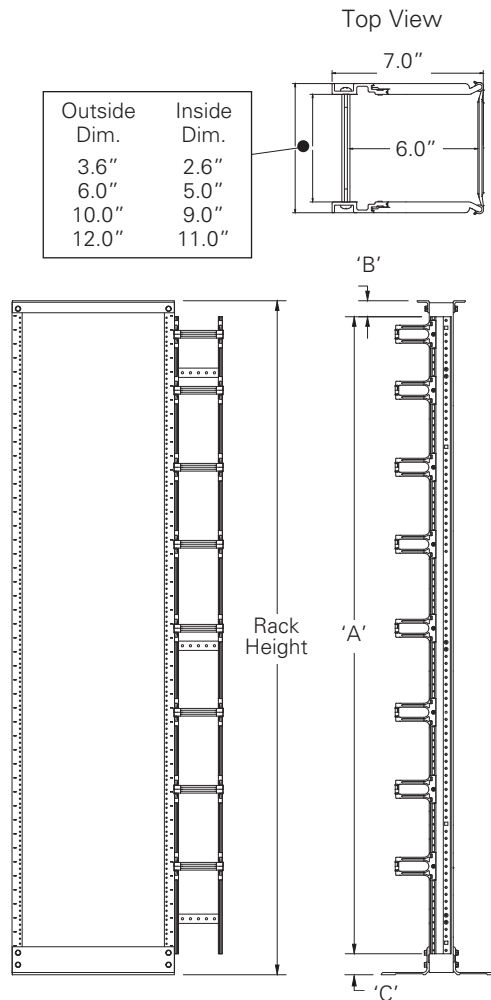

Continued on page 15.

**RCM+ Rack Mounted Vertical Cable Manager cont.
Single Sided Low Density Plastic Gate Style**

Catalog Number	Fits Rack Height of In. (mm)	'A' In. (mm)	'B' In. (mm)	'C' In. (mm)	Weight Each (kg)		Max CAT6A Cables (0.375" OD) (50% Fill)
					Lbs.	(kg)	
3 ⁵ / ₈ " (92mm) Wide x 7 ⁵ / ₁₆ " (186mm) Deep							
SB86283S066 __	66" (1676)	60 ³ / ₈ " (1533)	3" (76.2)	2 ⁵ / ₈ " (66.7)	8.0	(3.6)	69
SB86283S072 __	72" (1829)	67 ³ / ₈ " (1711)	2" (50.8)	2 ⁵ / ₈ " (66.7)	9.0	(4.1)	69
SB86283S078 __	78" (1981)	72 ⁵ / ₈ " (1845)	2 ³ / ₄ " (69.9)	2 ⁵ / ₈ " (66.7)	9.8	(4.4)	69
✓ SB86283S084 __	84" (2133)	79 ⁵ / ₈ " (2022)	1 ³ / ₄ " (44.4)	2 ⁵ / ₈ " (66.7)	10.5	(4.8)	69
SB86283S090 __	90" (2286)	84 ⁷ / ₈ " (2156)	2 ¹ / ₂ " (63.5)	2 ⁵ / ₈ " (66.7)	11.0	(5.0)	69
SB86283S096 __	96" (2438)	90 ¹ / ₈ " (2289)	3 ¹ / ₄ " (82.6)	2 ⁵ / ₈ " (66.7)	11.7	(5.3)	69
SB86283S108 __	108" (2743)	102 ³ / ₈ " (2600)	3" (76.2)	2 ⁵ / ₈ " (66.7)	13.2	(6.0)	69
6" (152mm) Wide x 7 ⁵ / ₁₆ " (186mm) Deep							
SB86286S066 __	66" (1676)	60 ³ / ₈ " (1533)	3" (76.2)	2 ⁵ / ₈ " (66.7)	8.3	(3.8)	134
SB86286S072 __	72" (1829)	67 ³ / ₈ " (1711)	2" (50.8)	2 ⁵ / ₈ " (66.7)	9.4	(4.2)	134
SB86286S078 __	78" (1981)	72 ⁵ / ₈ " (1845)	2 ³ / ₄ " (69.9)	2 ⁵ / ₈ " (66.7)	10.2	(4.7)	134
✓ SB86286S084 __	84" (2133)	79 ⁵ / ₈ " (2022)	1 ³ / ₄ " (44.4)	2 ⁵ / ₈ " (66.7)	10.9	(4.9)	134
SB86286S090 __	90" (2286)	84 ⁷ / ₈ " (2156)	2 ¹ / ₂ " (63.5)	2 ⁵ / ₈ " (66.7)	11.4	(5.2)	134
SB86286S096 __	96" (2438)	90 ¹ / ₈ " (2289)	3 ¹ / ₄ " (82.6)	2 ⁵ / ₈ " (66.7)	12.1	(5.5)	134
SB86286S108 __	108" (2743)	102 ³ / ₈ " (2600)	3" (76.2)	2 ⁵ / ₈ " (66.7)	13.7	(6.2)	134
10" (254mm) Wide x 7 ⁵ / ₁₆ " (186mm) Deep							
SB862810S066 __	66" (1676)	60 ³ / ₈ " (1533)	3" (76.2)	2 ⁵ / ₈ " (66.7)	8.9	(4.0)	241
SB862810S072 __	72" (1829)	67 ³ / ₈ " (1711)	2" (50.8)	2 ⁵ / ₈ " (66.7)	10.0	(4.5)	241
SB862810S078 __	78" (1981)	72 ⁵ / ₈ " (1845)	2 ³ / ₄ " (69.9)	2 ⁵ / ₈ " (66.7)	10.8	(4.9)	241
✓ SB862810S084 __	84" (2133)	79 ⁵ / ₈ " (2022)	1 ³ / ₄ " (44.4)	2 ⁵ / ₈ " (66.7)	11.6	(5.2)	241
SB862810S090 __	90" (2286)	84 ⁷ / ₈ " (2156)	2 ¹ / ₂ " (63.5)	2 ⁵ / ₈ " (66.7)	12.1	(5.5)	241
SB862810S096 __	96" (2438)	90 ¹ / ₈ " (2289)	3 ¹ / ₄ " (82.6)	2 ⁵ / ₈ " (66.7)	12.8	(5.8)	241
SB862810S108 __	108" (2743)	102 ³ / ₈ " (2600)	3" (76.2)	2 ⁵ / ₈ " (66.7)	14.4	(6.5)	241
12" (305mm) Wide x 7 ⁵ / ₁₆ " (186mm) Deep							
SB862812S066 __	66" (1676)	60 ³ / ₈ " (1533)	3" (76.2)	2 ⁵ / ₈ " (66.7)	9.2	(4.1)	294
SB862812S072 __	72" (1829)	67 ³ / ₈ " (1711)	2" (50.8)	2 ⁵ / ₈ " (66.7)	10.3	(4.7)	294
SB862812S078 __	78" (1981)	72 ⁵ / ₈ " (1845)	2 ³ / ₄ " (69.9)	2 ⁵ / ₈ " (66.7)	11.2	(5.1)	294
SB862812S084 __	84" (2133)	79 ⁵ / ₈ " (2022)	1 ³ / ₄ " (44.4)	2 ⁵ / ₈ " (66.7)	11.9	(5.4)	294
SB862812S090 __	90" (2286)	84 ⁷ / ₈ " (2156)	2 ¹ / ₂ " (63.5)	2 ⁵ / ₈ " (66.7)	12.4	(5.6)	294
SB862812S096 __	96" (2438)	90 ¹ / ₈ " (2289)	3 ¹ / ₄ " (82.6)	2 ⁵ / ₈ " (66.7)	13.2	(6.0)	294
SB862812S108 __	108" (2743)	102 ³ / ₈ " (2600)	3" (76.2)	2 ⁵ / ₈ " (66.7)	14.8	(6.7)	294

Finish__: Flat Black Powder Coat (FB), Silver Powder Coat (SL), or Eaton White (EW)

✓ Popular items include (FB) 84" high in 3⁵/₈", 6" and 10" widths

A = Height of RCM+ vertical section without doors

B = Distance between the top of the rack and the top of the RCM+ cable manager

C = Distance between the floor and the lowest part of the RCM+ cable manager

Note: Doors not furnished with this series of cable managers, can be ordered separately.

RCM+ Rack Mounted Vertical Cable Manager Double Sided Low Density Plastic Gate Style

- Double-sided SB862 Series RCM+ low density vertical cable managers are designed for routing lower density cabling on and between racks; with double cable capacity with gates on front and rear
- Front and rear vertical sections can be spaced apart when mounting on racks deeper than 3" (76mm)
- Vertical cabling section can be used with RCM+ standard horizontal cable managers
- Snap-on gates allow for quick opening from either side or complete removal
- Open back design allows unrestricted front and rear routing of cables
- Optional back removable covers are designed with pass through openings for cable routing, keyhole slots for cable spools, slots for cable straps, and keyhole slots for direct ePDU mounting
- Installation is easy and can be done in minutes using standard hand tools
- 1/4" (6.3mm) accessory mounting holes run the full height on both sides of the cable manager to accommodate the attachment of cable management accessories
- UL Listed as a Communication Circuit Accessory. File No. E171936
- Material: Aluminum with UL 94V-0 plastic components
- Finish___: Flat Black Powder Coat (FB), Silver Powder Coat (SL), or Eaton White (EW)
- Vertical cable manager includes:
(2) vertical cabling sections, (50) push-in fasteners, (12) cable strap mounts, (4) cable retainer bars, required number of gates, and mounting hardware



U.S. Patent 7,362,941
Other Patents Pending

Double sided,
84" high x 6" wide
SB86286D084FB

Outside Dim.	Inside Dim.
3.6"	2.6"
6.0"	5.0"
10.0"	9.0"
12.0"	11.0"

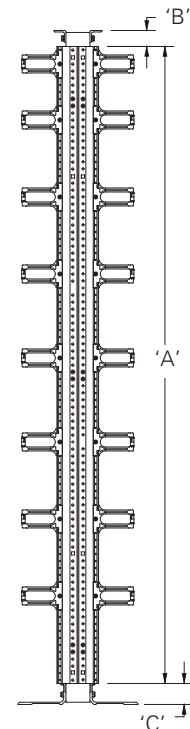
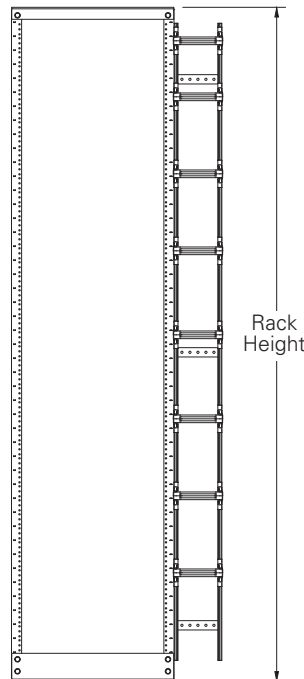
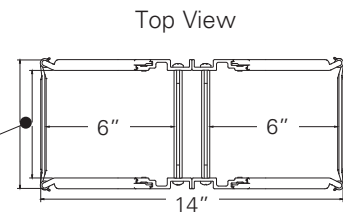

Continued on page 17.

**RCM+ Rack Mounted Vertical Cable Manager cont.
Double Sided Low Density Plastic Gate Style**

Catalog Number	Fits Rack Height of In. (mm)	'A' In. (mm)	'B' In. (mm)	'C' In. (mm)	Weight Each		Max CAT6A Cables (0.375" OD) (50% Fill)
					Lbs.	(kg)	
3 ⁵ / ₈ " (92mm) Wide x 14" (355mm) Deep							
SB86283D066 __	66" (1676)	60 ³ / ₈ " (1533)	3" (76.2)	2 ⁵ / ₈ " (66.7)	16.1	(7.3)	139
SB86283D072 __	72" (1829)	67 ³ / ₈ " (1711)	2" (50.8)	2 ⁵ / ₈ " (66.7)	18.0	(8.2)	139
SB86283D078 __	78" (1981)	72 ⁵ / ₈ " (1845)	2 ³ / ₄ " (69.9)	2 ⁵ / ₈ " (66.7)	19.6	(8.9)	139
✓ SB86283D084 __	84" (2133)	79 ⁵ / ₈ " (2022)	1 ³ / ₄ " (44.4)	2 ⁵ / ₈ " (66.7)	21.0	(9.5)	139
SB86283D090 __	90" (2286)	84 ⁷ / ₈ " (2156)	2 ¹ / ₂ " (63.5)	2 ⁵ / ₈ " (66.7)	22.1	(10.0)	139
SB86283D096 __	96" (2438)	90 ¹ / ₈ " (2289)	3 ¹ / ₄ " (82.6)	2 ⁵ / ₈ " (66.7)	23.4	(10.6)	139
SB86283D108 __	108" (2743)	102 ³ / ₈ " (2600)	3" (76.2)	2 ⁵ / ₈ " (66.7)	26.4	(12.0)	139
6" (152mm) Wide x 14" (355mm) Deep							
SB86286D066 __	66" (1676)	60 ³ / ₈ " (1533)	3" (76.2)	2 ⁵ / ₈ " (66.7)	16.7	(7.6)	268
SB86286D072 __	72" (1829)	67 ³ / ₈ " (1711)	2" (50.8)	2 ⁵ / ₈ " (66.7)	18.7	(8.5)	268
SB86286D078 __	78" (1981)	72 ⁵ / ₈ " (1845)	2 ³ / ₄ " (69.9)	2 ⁵ / ₈ " (66.7)	20.4	(9.3)	268
✓ SB86286D084 __	84" (2133)	79 ⁵ / ₈ " (2022)	1 ³ / ₄ " (44.4)	2 ⁵ / ₈ " (66.7)	21.8	(9.9)	268
SB86286D090 __	90" (2286)	84 ⁷ / ₈ " (2156)	2 ¹ / ₂ " (63.5)	2 ⁵ / ₈ " (66.7)	22.9	(10.4)	268
SB86286D096 __	96" (2438)	90 ¹ / ₈ " (2289)	3 ¹ / ₄ " (82.6)	2 ⁵ / ₈ " (66.7)	24.2	(11.0)	268
SB86286D108 __	108" (2743)	102 ³ / ₈ " (2600)	3" (76.2)	2 ⁵ / ₈ " (66.7)	27.3	(12.4)	268
10" (254mm) Wide x 14" (355mm) Deep							
SB862810D066 __	66" (1676)	60 ³ / ₈ " (1533)	3" (76.2)	2 ⁵ / ₈ " (66.7)	17.8	(8.1)	482
SB862810D072 __	72" (1829)	67 ³ / ₈ " (1711)	2" (50.8)	2 ⁵ / ₈ " (66.7)	19.9	(9.0)	482
SB862810D078 __	78" (1981)	72 ⁵ / ₈ " (1845)	2 ³ / ₄ " (69.9)	2 ⁵ / ₈ " (66.7)	21.6	(9.3)	482
✓ SB862810D084 __	84" (2133)	79 ⁵ / ₈ " (2022)	1 ³ / ₄ " (44.4)	2 ⁵ / ₈ " (66.7)	23.2	(10.5)	482
SB862810D090 __	90" (2286)	84 ⁷ / ₈ " (2156)	2 ¹ / ₂ " (63.5)	2 ⁵ / ₈ " (66.7)	24.2	(11.0)	482
SB862810D096 __	96" (2438)	90 ¹ / ₈ " (2289)	3 ¹ / ₄ " (82.6)	2 ⁵ / ₈ " (66.7)	25.7	(11.7)	482
SB862810D108 __	108" (2743)	102 ³ / ₈ " (2600)	3" (76.2)	2 ⁵ / ₈ " (66.7)	28.9	(13.1)	482
12" (305mm) Wide x 14" (355mm) Deep							
SB862812D066 __	66" (1676)	60 ³ / ₈ " (1533)	3" (76.2)	2 ⁵ / ₈ " (66.7)	18.3	(8.3)	589
SB862812D072 __	72" (1829)	67 ³ / ₈ " (1711)	2" (50.8)	2 ⁵ / ₈ " (66.7)	20.6	(9.3)	589
SB862812D078 __	78" (1981)	72 ⁵ / ₈ " (1845)	2 ³ / ₄ " (69.9)	2 ⁵ / ₈ " (66.7)	22.4	(10.2)	589
SB862812D084 __	84" (2133)	79 ⁵ / ₈ " (2022)	1 ³ / ₄ " (44.4)	2 ⁵ / ₈ " (66.7)	23.8	(10.8)	589
SB862812D090 __	90" (2286)	84 ⁷ / ₈ " (2156)	2 ¹ / ₂ " (63.5)	2 ⁵ / ₈ " (66.7)	24.9	(11.3)	589
SB862812D096 __	96" (2438)	90 ¹ / ₈ " (2289)	3 ¹ / ₄ " (82.6)	2 ⁵ / ₈ " (66.7)	26.4	(12.0)	589
SB862812D108 __	108" (2743)	102 ³ / ₈ " (2600)	3" (76.2)	2 ⁵ / ₈ " (66.7)	29.7	(13.5)	589

Finish___: Flat Black Powder Coat (FB), Silver Powder Coat (SL), or Eaton White (EW)

✓ Popular items include (FB) 84" high in 3⁵/₈", 6" and 10" widths

A = Height of RCM+ vertical section without doors

B = Distance between the top of the rack and the top of the RCM+ cable manager

C = Distance between the floor and the lowest part of the RCM+ cable manager

Note: Doors not furnished with this series of cable managers, can be ordered separately.

RCM+ Rack Mounted Vertical Cable Manager With Cover Double Sided Dual Density Style

- Double-sided SB864 Series cable managers utilize the SB860 and SB862 Series cable managers in back-to-back combination for use in applications with varying cable management requirements
- High-density extended fingers provide maximum cable support for each rack mounting space
- Low-density vertical cabling section can be used with RCM+ horizontal cable managers
- Front and rear vertical sections can be spaced apart when mounting on racks deeper than 3" (76mm), allowing cables to be routed out through side openings created between the vertical sections
- High-density vertical cable section can be used with RCM+ extended horizontal cable manager
- Snap-on gates on both sides allows for quick opening from either side or complete removal
- Open back design allows unrestricted routing of cables between front and rear sections
- Optional back removable covers are designed with pass through openings for cable routing, keyhole slots for cable spools, slots for cable straps, and keyhole slots for direct ePDU mounting
- Installation is easy and can be done in minutes using standard hand tools
- 1/4" (6.3mm) accessory mounting holes run the full height on both sides of cable manager to accommodate the attachment of cable management accessories
- UL Listed as a Communication Circuit Accessory. File No. E171936
- Material: Aluminum with UL 94V-0 black plastic components
- Finishes__: Flat Black Powder Coat (FB), Silver Powder Coat (SL), or Eaton White (EW)
- Vertical cable manager includes:
(2) vertical cabling sections, (1) door,
(50) push-in fasteners, (12) cable strap mounts, (4) cable retainer bars, required number of gates and mounting hardware



Top View

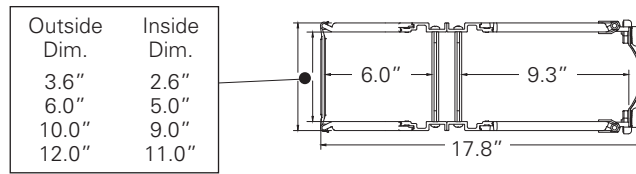

U.S. Patent 7,362,941
Other Patents Pending



Double sided,
84" high x 6" wide
SB86486D084FB

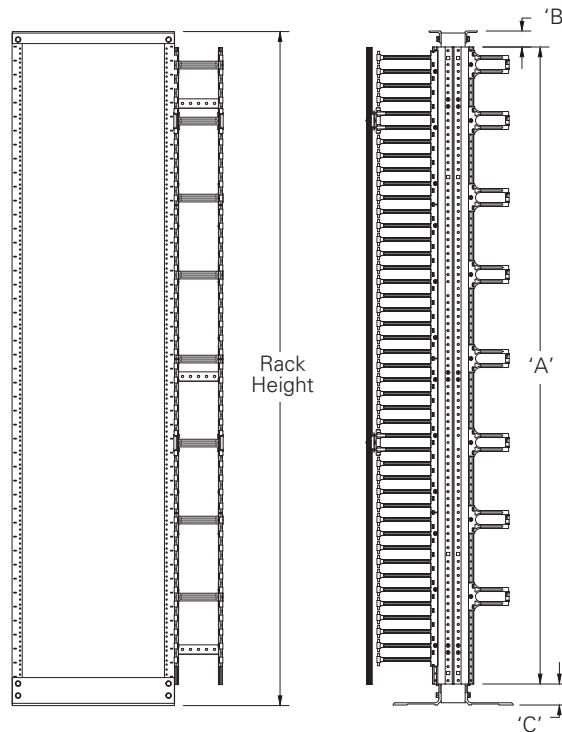

Continued on page 19.

**RCM+ Rack Mounted Vertical Cable Manager cont.
Double Sided Dual Density Plastic Gate Style**

Catalog Number	Fits Rack Height of In. (mm)	'A' In. (mm)	'B' In. (mm)	'C' In. (mm)	Weight Each (kg)		Max CAT6A Cables (0.375" OD) (50% Fill)
					Lbs.	(kg)	
3 ⁵ / ₈ " (92mm) Wide x 17 ⁷ / ₈ " (454mm) Deep							
SB86483D066 __	66" (1676)	60 ³ / ₈ " (1533)	3" (76.2)	2 ⁵ / ₈ " (66.7)	19.9	(9.0)	179
SB86483D072 __	72" (1829)	67 ³ / ₈ " (1711)	2" (50.8)	2 ⁵ / ₈ " (66.7)	22.3	(10.1)	179
SB86483D078 __	78" (1981)	72 ⁵ / ₈ " (1845)	2 ³ / ₄ " (69.9)	2 ⁵ / ₈ " (66.7)	24.1	(10.9)	179
✓ SB86483D084 __	84" (2133)	79 ⁵ / ₈ " (2022)	1 ³ / ₄ " (44.4)	2 ⁵ / ₈ " (66.7)	26.0	(11.8)	179
SB86483D090 __	90" (2286)	84 ⁷ / ₈ " (2156)	2 ¹ / ₂ " (63.5)	2 ⁵ / ₈ " (66.7)	27.6	(12.5)	179
SB86483D096 __	96" (2438)	90 ¹ / ₈ " (2289)	3 ¹ / ₄ " (82.6)	2 ⁵ / ₈ " (66.7)	29.3	(13.3)	179
SB86483D108 __	108" (2743)	102 ³ / ₈ " (2600)	3" (76.2)	2 ⁵ / ₈ " (66.7)	33.2	(15.0)	179
6" (152mm) Wide x 17 ⁷ / ₈ " (454mm) Deep							
SB86486D066 __	66" (1676)	60 ³ / ₈ " (1533)	3" (76.2)	2 ⁵ / ₈ " (66.7)	21.7	(9.8)	344
SB86486D072 __	72" (1829)	67 ³ / ₈ " (1711)	2" (50.8)	2 ⁵ / ₈ " (66.7)	24.3	(11.0)	344
SB86486D078 __	78" (1981)	72 ⁵ / ₈ " (1845)	2 ³ / ₄ " (69.9)	2 ⁵ / ₈ " (66.7)	26.3	(11.9)	344
✓ SB86486D084 __	84" (2133)	79 ⁵ / ₈ " (2022)	1 ³ / ₄ " (44.4)	2 ⁵ / ₈ " (66.7)	28.4	(12.9)	344
SB86486D090 __	90" (2286)	84 ⁷ / ₈ " (2156)	2 ¹ / ₂ " (63.5)	2 ⁵ / ₈ " (66.7)	30.1	(13.6)	344
SB86486D096 __	96" (2438)	90 ¹ / ₈ " (2289)	3 ¹ / ₄ " (82.6)	2 ⁵ / ₈ " (66.7)	32.1	(14.5)	344
SB86486D108 __	108" (2743)	102 ³ / ₈ " (2600)	3" (76.2)	2 ⁵ / ₈ " (66.7)	36.2	(16.4)	344
10" (254mm) Wide x 17 ⁷ / ₈ " (454mm) Deep							
SB864810D066 __	66" (1676)	60 ³ / ₈ " (1533)	3" (76.2)	2 ⁵ / ₈ " (66.7)	25.2	(11.4)	620
SB864810D072 __	72" (1829)	67 ³ / ₈ " (1711)	2" (50.8)	2 ⁵ / ₈ " (66.7)	28.3	(12.8)	620
SB864810D078 __	78" (1981)	72 ⁵ / ₈ " (1845)	2 ³ / ₄ " (69.9)	2 ⁵ / ₈ " (66.7)	30.4	(13.8)	620
✓ SB864810D084 __	84" (2133)	79 ⁵ / ₈ " (2022)	1 ³ / ₄ " (44.4)	2 ⁵ / ₈ " (66.7)	32.9	(14.9)	620
SB864810D090 __	90" (2286)	84 ⁷ / ₈ " (2156)	2 ¹ / ₂ " (63.5)	2 ⁵ / ₈ " (66.7)	34.8	(15.8)	620
SB864810D096 __	96" (2438)	90 ¹ / ₈ " (2289)	3 ¹ / ₄ " (82.6)	2 ⁵ / ₈ " (66.7)	37.2	(16.9)	620
SB864810D108 __	108" (2743)	102 ³ / ₈ " (2600)	3" (76.2)	2 ⁵ / ₈ " (66.7)	42.0	(19.0)	620
12" (305mm) Wide x 17 ⁷ / ₈ " (454mm) Deep							
SB864812D066 __	66" (1676)	60 ³ / ₈ " (1533)	3" (76.2)	2 ⁵ / ₈ " (66.7)	29.4	(13.3)	757
SB864812D072 __	72" (1829)	67 ³ / ₈ " (1711)	2" (50.8)	2 ⁵ / ₈ " (66.7)	32.9	(14.9)	757
SB864812D078 __	78" (1981)	72 ⁵ / ₈ " (1845)	2 ³ / ₄ " (69.9)	2 ⁵ / ₈ " (66.7)	35.5	(16.1)	757
SB864812D084 __	84" (2133)	79 ⁵ / ₈ " (2022)	1 ³ / ₄ " (44.4)	2 ⁵ / ₈ " (66.7)	38.3	(17.4)	757
SB864812D090 __	90" (2286)	84 ⁷ / ₈ " (2156)	2 ¹ / ₂ " (63.5)	2 ⁵ / ₈ " (66.7)	40.6	(18.4)	757
SB864812D096 __	96" (2438)	90 ¹ / ₈ " (2289)	3 ¹ / ₄ " (82.6)	2 ⁵ / ₈ " (66.7)	48.5	(19.7)	757
SB864812D108 __	108" (2743)	102 ³ / ₈ " (2600)	3" (76.2)	2 ⁵ / ₈ " (66.7)	48.9	(22.2)	757

Finish__ : Flat Black Powder Coat (FB), Silver Powder Coat (SL), or Eaton White (EW)

✓ Popular items include (FB) 84" high in 3⁵/₈", 6" and 10" widths

A = Height of RCM+ vertical section without doors

B = Distance between the top of the rack and the top of the RCM+ cable manager

C = Distance between the floor and the lowest part of the RCM+ cable manager

Note: Doors are not furnished on rear side cable managers, can be ordered separately.

RCM+ Vertical Cable Manager Door Kit

- Additional doors are designed to fit SB860 and SB864 Series vertical cable managers
- Double-hinge doors, with quarter-turn locking hinges, open in either direction, and can quickly be removed for easy cable access
- Select appropriate vertical cable manager height and width prior to selecting door
- Material: Aluminum with UL 94V-0 black plastic components
- Finishes__: Flat Black Powder Coat (FB), Silver Powder Coat (SL), or Eaton White (EW)

Pre-Installed
Quarter-Turn Latches



Catalog Number	Fits Rack Height of		Door Height		Weight Each	
	In.	(mm)	In.	(mm)	Lbs.	(kg)
3⁵/₈" (92mm) Wide						
SB860CVR3066__	66"	(1676)	60 ³ / ₈ "	(1533)	3.2	(1.5)
SB860CVR3072__	72"	(1829)	67 ³ / ₈ "	(1711)	3.5	(1.6)
SB860CVR3078__	78"	(1981)	72 ⁵ / ₈ "	(1845)	3.7	(1.7)
SB860CVR3084__	84"	(2133)	79 ⁵ / ₈ "	(2022)	3.8	(1.7)
SB860CVR3090__	90"	(2286)	84 ⁷ / ₈ "	(2156)	4.1	(1.9)
SB860CVR3096__	96"	(2438)	90 ¹ / ₈ "	(2289)	4.3	(2.0)
SB860CVR3108__	108"	(2743)	102 ³ / ₈ "	(2600)	4.6	(2.1)
6" (152mm) Wide						
SB860CVR6066__	66"	(1676)	60 ³ / ₈ "	(1533)	5.4	(2.5)
SB860CVR6072__	72"	(1829)	67 ³ / ₈ "	(1711)	5.9	(2.7)
SB860CVR6078__	78"	(1981)	72 ⁵ / ₈ "	(1845)	6.4	(2.9)
SB860CVR6084__	84"	(2133)	79 ⁵ / ₈ "	(2022)	6.6	(3.0)
SB860CVR6090__	90"	(2286)	84 ⁷ / ₈ "	(2156)	7.1	(3.2)
SB860CVR6096__	96"	(2438)	90 ¹ / ₈ "	(2289)	7.6	(3.4)
SB860CVR6108__	108"	(2743)	102 ³ / ₈ "	(2600)	8.1	(3.7)
10" (254mm) Wide						
SB860CVR10066__	66"	(1676)	60 ³ / ₈ "	(1533)	8.1	(3.7)
SB860CVR10072__	72"	(1829)	67 ³ / ₈ "	(1711)	8.8	(4.0)
SB860CVR10078__	78"	(1981)	72 ⁵ / ₈ "	(1845)	9.5	(4.3)
SB860CVR10084__	84"	(2133)	79 ⁵ / ₈ "	(2022)	9.9	(4.5)
SB860CVR10090__	90"	(2286)	84 ⁷ / ₈ "	(2156)	10.6	(4.8)
SB860CVR10096__	96"	(2438)	90 ¹ / ₈ "	(2289)	11.4	(5.2)
SB860CVR10108__	108"	(2743)	102 ³ / ₈ "	(2600)	12.2	(5.5)
12" (305mm) Wide						
SB860CVR12066__	66"	(1676)	60 ³ / ₈ "	(1533)	12.2	(5.5)
SB860CVR12072__	72"	(1829)	67 ³ / ₈ "	(1711)	13.4	(6.1)
SB860CVR12078__	78"	(1981)	72 ⁵ / ₈ "	(1845)	14.5	(6.6)
SB860CVR12084__	84"	(2133)	79 ⁵ / ₈ "	(2022)	15.2	(6.9)
SB860CVR12090__	90"	(2286)	84 ⁷ / ₈ "	(2156)	16.3	(7.4)
SB860CVR12096__	96"	(2438)	90 ¹ / ₈ "	(2289)	17.5	(7.9)
SB860CVR12108__	108"	(2743)	102 ³ / ₈ "	(2600)	18.7	(8.5)



Each catalog number includes a one-piece door as shown.

SB860CRV6084FB

RCM+ Vertical Cable Manager Back Removable Cover

- The back cover provides closure on the rear side of SB860, SB862, and SB864 vertical cable managers
- Back removable covers are designed with pass through openings for cable routing, keyhole slots for cable spools, slots for cable straps, and keyhole slots for direct ePDU mounting
 - 84" (2133mm) version can mount up to two (2) full-height ePDUs or four (4) half-height ePDUs
- Includes mounting hardware
- Material: 14 gauge (1.9mm) steel
- Finishes__: Flat Black Powder Coat (FB), Silver Powder Coat (SL), or Eaton White (EW)

Catalog Number	Fits Rack Height of In. (mm)	Weight		ePDU Mounting	
		Lbs.	(kg)	1/2 Height	Full Height
3⁵/₈" (92mm) Wide					
SB862BRC3066__	66" (1676)	2.8	(1.3)	-	-
SB862BRC3072__	72" (1829)	3.1	(1.4)	-	-
SB862BRC3078__	78" (1981)	3.4	(1.5)	-	-
SB862BRC3084__	84" (2133)	3.6	(1.6)	2	1
SB862BRC3090__	90" (2286)	3.6	(1.6)	-	-
SB862BRC3096__	96" (2438)	3.9	(1.8)	-	-
SB862BRC3108__	108" (2743)	4.3	(1.9)	-	-
6" (152mm) Wide					
SB862BRC6066__	66" (1676)	4.4	(2.0)	-	-
SB862BRC6072__	72" (1829)	4.6	(2.1)	-	-
SB862BRC6078__	78" (1981)	4.9	(2.2)	-	-
SB862BRC6084__	84" (2133)	5.3	(2.4)	4	2
SB862BRC6090__	90" (2286)	5.3	(2.4)	-	-
SB862BRC6096__	96" (2438)	5.7	(2.5)	-	-
SB862BRC6108__	108" (2743)	6.4	(2.9)	-	-
10" (254mm) Wide					
SB862BRC10066__	66" (1676)	6.5	(3.0)	-	-
SB862BRC10072__	72" (1829)	6.9	(3.1)	-	-
SB862BRC10078__	78" (1981)	7.5	(3.4)	-	-
SB862BRC10084__	84" (2133)	8.2	(3.7)	4	2
SB862BRC10090__	90" (2286)	8.2	(3.7)	-	-
SB862BRC10096__	96" (2438)	8.8	(4.0)	-	-
SB862BRC10108__	108" (2743)	10.0	(4.5)	-	-
12" (305mm) Wide					
SB862BRC12066__	66" (1676)	7.9	(3.6)	-	-
SB862BRC12072__	72" (1829)	8.1	(3.7)	-	-
SB862BRC12078__	78" (1981)	8.9	(4.0)	-	-
SB862BRC12084__	84" (2133)	9.6	(4.3)	4	2
SB862BRC12090__	90" (2286)	9.6	(4.3)	-	-
SB862BRC12096__	96" (2438)	10.3	(4.7)	-	-
SB862BRC12108__	108" (2743)	11.8	(5.3)	-	-



Each catalog number includes two half-height back removable covers.
SB862BRC6084FB

RCM+ Rack Mounted Horizontal Cable Manager With Cover Single Sided, Plastic Finger Style

- Used to provide horizontal pathway for cabling on one side of a two-post rack
- #12-24 mounting hardware is included
- Plastic cable manager fingers help control bend radius
- Snap-on removable hinged door opens past 180°, and remains open in up position for convenient cable access
- Stylized door that complements the look of the RCM and RCM+ vertical managers
- Open back design allows for free movement of cables from the front to the back of the cable manager
- Standard finger versions are fully compatible with the RCM vertical cable managers for enhanced cable capacity
- Extended finger versions are fully compatible with the RCM+ vertical cable managers
 - SX series managers offer extended length fingers which provide 45% more cable capacity than standard fingers
- UL Listed as a Communication Circuit Accessory. File No. E171936
- Material: Steel - 14 ga. (ASTM A569) with UL 94V-0 black plastic components
- Finishes___: Flat Black Powder Coat (FB), Silver Powder Coat (SL), or Eaton White (EW)



SB87019S2FB
Standard Length
(2U)



SB87019SX2FB
Extended Length
(2U)

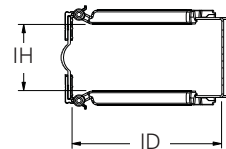

IH = Inner Height
ID = Inner Depth

Catalog Number	Height	Inner Height In. (mm)	Width In. (mm)	Inner Depth In. (mm)	Weight Each Lbs. (kg)	Max CAT6A Cables 0.375" OD (50% Fill)
Standard Fingers (for use with RCM Vertical Managers)						
✓ SB87019S1__	1U	0.7" (18)	19" (482)	5.5" (140)	2.1 (0.9)	17
SB87023S1__	1U	0.7" (18)	23" (584)	5.5" (140)	2.3 (1.0)	17
✓ SB87019S2__	2U	2.4" (61)	19" (482)	5.5" (140)	2.5 (1.1)	59
SB87023S2__	2U	2.4" (61)	23" (584)	5.5" (140)	2.7 (1.2)	59
SB87019S3__	3U	4.2" (106)	19" (482)	5.5" (140)	2.8 (1.3)	104
SB87023S3__	3U	4.2" (106)	23" (584)	5.5" (140)	3.1 (1.4)	104
SB87019S4__	4U	5.9" (150)	19" (482)	5.5" (140)	3.2 (1.4)	146
SB87023S4__	4U	5.9" (150)	23" (584)	5.5" (140)	3.6 (1.6)	146
Extended Fingers (for use with RCM+ High Density Vertical Managers)						
✓ SB87019SX1__	1U	0.7" (18)	19" (482)	8.0" (203)	2.4 (1.1)	25
✓ SB87019SX2__	2U	2.4" (61)	19" (482)	8.0" (203)	3.1 (1.4)	86
SB87019SX3__	3U	4.2" (106)	19" (482)	8.0" (203)	3.8 (1.7)	152
SB87019SX4__	4U	5.9" (150)	19" (482)	8.0" (203)	4.4 (2.0)	213

✓ FB is a popular item

RCM+ Rack Mounted Horizontal Cable Manager With Cover Double Sided, Plastic Finger Style

- Used to provide a horizontal pathway for cabling on both sides of a two-post rack in the same RMU spacing
- #12-24 mounting hardware is included
- Plastic cable manager fingers help control bend radius
- Snap-on, removable, hinged aluminum doors that open past 180° and remain open in the up position for convenient cable access
- Stylized door that complements the look of the RCM and RCM+ vertical managers
- Open back design allows for free movement of cables from the front to the back of the cable manager
- Standard finger versions are fully compatible with the RCM vertical cable managers for enhanced cable capacity
- Extended finger versions are fully compatible with the new RCM+ vertical cable managers
 - DX series managers offer extended length fingers which provide 45% more cable capacity than standard fingers
- Low-profile rear-design provides easy cabling access to the back-side of patch panels
- Material: Steel - 14 ga. (ASTM A569) with UL 94V-0 black plastic components
- Finishes___: Flat Black Powder Coat (FB), Silver Powder Coat (SL), or Eaton White (EW)



SB87019D1FB Standard (2U) Length



SB87019D2FB Standard (2U) Length

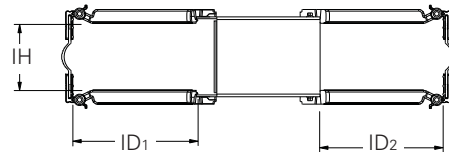

IH = Inner Height
ID = Inner Depth

Catalog Number	Height	IH In. (mm)	Width In. (mm)	ID ₁ In. (mm)	ID ₂ In. (mm)	Weight Each Lbs. (kg)	Max CAT6A Cables 0.375" OD (50% Fill)
Standard Fingers (for use with RCM Vertical Managers)							
SB87019D1 ___	1U	0.7" (18)	19" (482)	5.2" (132)	4.5" (114)	2.9 (1.3)	30
SB87023D1 ___	1U	0.7" (18)	23" (584)	5.2" (132)	4.5" (114)	3.3 (1.5)	30
SB87019D2 ___	2U	2.4" (61)	19" (482)	5.2" (132)	4.5" (114)	3.7 (1.7)	105
SB87023D2 ___	2U	2.4" (61)	23" (584)	5.2" (132)	4.5" (114)	4.1 (1.8)	105
SB87019D3 ___	3U	4.2" (106)	19" (482)	5.2" (132)	4.5" (114)	4.5 (2.0)	184
SB87023D3 ___	3U	4.2" (106)	23" (584)	5.2" (132)	4.5" (114)	4.9 (2.2)	184
Extended Fingers (for use with RCM+ High Density Vertical Managers)							
SB87019DX1 ___	1U	0.7" (18)	19" (482)	7.7" (195)	7.0" (178)	3.1 (1.4)	46
SB87019DX2 ___	2U	2.4" (61)	19" (482)	7.7" (195)	7.0" (178)	3.9 (1.7)	159
SB87019DX3 ___	3U	4.2" (106)	19" (482)	7.7" (195)	7.0" (178)	4.7 (2.1)	279

RCM+ Cable Management Finger Bracket Rack Mountable 11U Plastic Finger Section

- High-density finger bracket mounts directly to a relay rack and provides cable support at each rack mounting unit
- Fingers align with rack mounting units
- Material: Steel bracket with UL 94V-0 black plastic finger section
- Includes (1) finger bracket
- Finish: UL 94V-0 black plastic



SB860FSFB

Part Number	Height	Depth		Weight Each	
		In.	(mm)	Lbs.	(kg)
SB860FSFB	11U	4"	(101)	0.9	(0.41)
SB860FSXFB	11U	6 1/2"	(165)	1.0	(0.45)

RCM+ Cable Management Finger Bracket, 11U Plastic Finger Section

- Used to replace finger sections on RCM+ high density cable managers; or for use in adding high density finger sections to SB862 or the low density side of the SB864
- Finger section is 19" (482mm) long
- Includes (1) finger section and mounting hardware
- Material: UL 94V-0 black plastic



Part Number	Height	Depth		Weight Each Lbs. (kg)	Compatible With	
		In.	(mm)		Vertical	Horizontal
SB860FSKFB	11U	4"	(101)	0.50 (0.22)	VCM (Cabinet)	SB870
SB860FSXKFB	11U	6 1/2"	(165)	0.60 (0.27)	SB860, SB864	SB870 (X)

RCM+ Cable Management Plastic Gate Section

- Gate kits are 2U high and designed for attachment to SB862 and SB864 vertical cable managers
- Kit includes (2) finger sections, (1) gate, and mounting hardware
- Material: UL 94V-0 black plastic components



Part Number	Width		Weight Each	
	In.	(mm)	Lbs.	(kg)
SB8623KFB	3 ⁵ / ₈ "	(92)	0.23	(0.10)
SB8626KFB	6"	(152)	0.24	(0.11)
SB86210KFB	10"	(254)	0.27	(0.12)
SB86212KFB	12"	(305)	0.29	(0.13)

RCM+ Cable Management Plastic Cable Retaining Gate

- Designed to provide convenient cable containment on SB860, SB862, and SB864 vertical cable managers
- For use with SB860, SB862 and SB864 vertical cable managers
- Gates snap on and can be installed under doors
- Gates can be opened in either direction, and can be quickly removed for easy cable access
- Includes (6) gates
- Material: UL 94V-0 black plastic



Part Number	Width		Weight Each	
	In.	(mm)	Lbs.	(kg)
SB8623GTFB	3 ⁵ / ₈ "	(92)	0.15	(0.07)
SB8626GTFB	6"	(152)	0.26	(0.12)
SB86210GTFB	10"	(254)	0.44	(0.20)
SB86212GTFB	12"	(305)	0.53	(0.24)

RCM+ Cable Management Push-In Fastener & Cable Strap Mount

- SB862PIF is used to quickly attach accessories to 1/4" (6mm) mounting holes in a vertical cable manager
- SB862CSM provides attachment for cable straps up to 3/4" (19mm) wide. Attaches with SB862PIF to 1/4" (6mm) accessory mounting holes in cable manager
- Can be easily removed for relocation
- Standard pack: 100 pieces
- Material: Black Plastic UL 94V-2

Part Number	Weight per 100	
	Lbs.	(kg)
SB862PIF	0.62	(0.28)
SB862CSM	0.87	(0.40)



SB862CSM



SB862PIF

RCM+ Floor Mounting Bracket

- Provides floor support for RCM+ vertical managers on end-of-row applications
- Universal design can be used with single and double-sided managers
- Includes (1) floor mounting bracket and mounting hardware
- Material: 14 gauge (1.9mm) steel
- Finishes__: Flat Black (FB) or Eaton White (EW) Powder Coat

Part Number	Width		Weight Each	
	In.	(mm)	Lbs.	(kg)
SB860FMB__	5 7/8"	(149)	.53	(0.24)



Single Sided RCM+
SB860FMBFB



Double Sided RCM+
SB860FMBFB

VELCRO®† Cable Hanger

- Use to secure and organize cables to equipment racks
- VELCRO buckle straps allow for mechanical fastening of strap to multiple points in the enclosure
- VELCRO offers superior reusability versus tie wraps
- Grommet size: 1/4" (6mm)
- Ten (10) straps per kit (Standard VELCRO straps)



Part Number	Width x Length		Weight	
	In.	(mm)	Lbs.	(kg)
SB728^{3/4}x6	3/4"	6" (19 x 152)	.1	(.045)

Eaton VELCRO®† Straps

- Use to secure and large organize cables to equipment racks
- Compatible with cable strap mount
- Ten (10) straps per kit



Part Number	Width x Length		Weight	
	In.	(mm)	Lbs.	(kg)
✓ SBCMVBCKL	3/4"	10 ^{5/16} " (19 x 262)	.1	(.045)

✓ Popular item

VELCRO®† Buckle Straps

- Use to secure and organize cables to equipment racks
- VELCRO buckle straps allow for mechanical fastening of strap to multiple points in the enclosure
- VELCRO offers superior reusability versus tie wraps
- Ten (10) straps per kit (Standard VELCRO buckle straps)



Part Number	Width x Length		Weight	
	In.	(mm)	Lbs.	(kg)
✓ SB727^{5/8}x6	5/8"	6" (16 x 152)	.1	(.045)

✓ Popular item

† Mark shown is property of respective owner.

RCM+ Telescopic Cable Spools and Spool Kits

- Designed for use with RCM, RCM+, HDNR vertical cable managers
- Facilitates storage and routing of cable with a 1.125" (28mm) bend radius
- Unique, telescopic design that provides for depth adjustability from 5" (127mm) to 8" (203mm) with hands-only twist and lock capability (no tools required for adjustment)
- Cable spools attach quickly to keyhole slots provided in mounting channels and optional back covers
- Pre-installed screws for quick mounting inside cable pathways
- SB860ACSFb includes (1) spool
- SB860ACS__FB Spool kits includes (2) spools, mounting channels, and hardware
- Unique spool kit design provides for vertical and horizontal adjustability to suit any need
- Material: Steel mounting channels with UL 94V-0 black plastic spools
- Finish: Flat Black Powder Coat mounting channels, black plastic spools



SB860ACS

Spool Only

Part Number	Adjustable Depth		Bend Radius		Weight Each	
	In.	(mm)	In.	(mm)	Lbs.	(kg)
SB860ACSFb	5" - 8"	(127 - 203)	1.125"	(28)	0.53	(0.24)

Spool Kits - (2) Spools & Mounting Channel with Hardware

Part Number	Fits Rack Height of		Adjustable Depth		Bend Radius		Weight	
	In.	(mm)	In.	(mm)	In.	(mm)	Lbs.	(kg)
SB860ACSK066FB	66"	(1676)	5" - 8"	(127 - 203)	1.125"	(28)	3.1	(1.40)
SB860ACSK072FB	72"	(1829)	5" - 8"	(127 - 203)	1.125"	(28)	3.3	(1.49)
SB860ACSK078FB	78"	(1981)	5" - 8"	(127 - 203)	1.125"	(28)	3.6	(1.63)
SB860ACSK084FB	84"	(2133)	5" - 8"	(127 - 203)	1.125"	(28)	3.8	(1.72)
SB860ACSK090FB	90"	(2286)	5" - 8"	(127 - 203)	1.125"	(28)	4.1	(1.86)
SB860ACSK096FB	96"	(2438)	5" - 8"	(127 - 203)	1.125"	(28)	4.4	(1.99)
SB860ACSK108FB	108"	(2743)	5" - 8"	(127 - 203)	1.125"	(28)	4.8	(2.18)

84" Tall Kit
SB860ACSK084FB



SB860ACSK084FB

RCM+ High Density Vertical Manager Kit

- Complete RCM+ vertical cable manager kit offers easy ordering and shipment
- Compatible with full line of Eaton two-post and four-post racks
- High density fingers support large cabling applications
- Back removable cover mounts up to (10) spools and (2) full height ePDU's (back side)
- Kit includes:
 - (1) RCM+ high-density cable manager (single-sided)
 - (2) Cable spools
 - (10) Eaton VELCRO®+ straps
 - (1) Back removable cover (full height)
- Material: Aluminum with UL 94V-0 black plastic components
- Finish: Flat Black Powder Coat

RCM+ High Density Vertical Cable Manager (single-sided)



Single Sided
84" High x 6" Wide
SB86086S084FB

RCM+ Back Removable Cover



84" High x 6" Wide
SB862BRC084FB

RCM+ Telescopic Cable Spools



5" to 8" Adjustable Depth
SB860ACSF

Eaton VELCRO Straps



9" Long Strap
SBCMVBCKL

Part Number	Height		Width		Weight per Kit	
	In.	(mm)	In.	(mm)	Lbs.	(kg)
SB86086SK084FB	84"	(2133)	6"	(0152)	25.7	(11.6)
SB860810SK084FB	84"	(2133)	10"	(254)	33.6	(15.2)
SB860812SK084FB	84"	(2133)	12"	(305)	40.9	(18.5)

† Mark shown is property of respective owner.

Cable Management - RCM & RCM+™

Product Guide

	RCM Vertical Cable Management	RCM+ Vertical Cable Management
Applications	Network Closet	Network Closet, Data Center
Key Features	High Density Sloped Fingers • Low Density Fingers Floor rested • Fast Delivery	High Density Fingers (Extended) • Low Density Fingers Direct ePDU Mounting • Full line of accessories Full range of sizes • Fast Delivery
Series	SB861 (High Density) • SB865 (Dual Density)	SB860 (High Density) • SB862 (Low Density) SB864 (Dual Density)
Heights	84"	66", 72", 78", 84", 90", 96", 108"
Widths	3.6", 6"	3.6", 6", 10", 12"
Depths	7.1" (Single) • 14.1" (Double)	10.3" (Single) • 20.4" (Double)
Colors	Flat Black	Flat Black, Silver, Eaton White
Compatible Accessories	RCM+ Standard Horizontal Cable Managers Low Density Gates • Flextray™ Lacing Device Kit RCM+ Telescopic Cable Spools Eaton VELCRO® Cable Straps	RCM+ Extended Horizontal Cable Manager • Back Removable Cover High Density Finger Brackets • Cable Retention Gates RCM+ Telescopic Cable Spools • Cable Management Strap Mount Eaton VELCRO® Cable Straps • Floor Mounting Bracket

Cross Reference

Description	Eaton B-Line	CPI	Hoffman	Panduit
High Density Vertical Cable Manager, Single, 84"H x 3.5"W	SB86083S084FB	13901-703	EC3S7	-
High Density Vertical Cable Manager, Double, 84"H x 3.5"W	SB86083D084FB	13911-703	-	-
High Density Vertical Cable Manager, Single, 84"H x 6"W	SB86086S084FB	13902-703	DV6S7	PRVF6
High Density Vertical Cable Manager, Double, 84"H x 6"W	SB86086D084FB	13912-703	DV6DF7	PRV6
High Density Vertical Cable Manager, Single, 84"H x 10"W	SB860810S084FB	13904-703	DV10S7	PRVF10
High Density Vertical Cable Manager, Double, 84"H x 10"W	SB860810D084FB	13914-703	DV10DF7	PRV10
High Density Vertical Cable Manager, Single, 84"H x 12"W	SB860812S084FB	13905-703	DV12S7	PRVF12
High Density Vertical Cable Manager, Double, 84"H x 12"W	SB860812D084FB	13915-703	DV12DF7	PRV12
Low Density Vertical Cable Manager, Single, 84"H x 3.5"W	SB86283S084FB	-	-	-
Low Density Vertical Cable Manager, Double, 84"H x 3.5"W	SB86283D084FB	-	-	-
Low Density Vertical Cable Manager, Single, 84"H x 6"W	SB86286S084FB	-	-	-
Low Density Vertical Cable Manager, Double, 84"H x 6"W	SB86286D084FB	-	-	-
Low Density Vertical Cable Manager, Single, 84"H x 10"W	SB862810S084FB	-	-	-
Low Density Vertical Cable Manager, Double, 84"H x 10"W	SB862810D084FB	-	-	-
Low Density Vertical Cable Manager, Single, 84"H x 12"W	SB862812S084FB	-	-	-
Low Density Vertical Cable Manager, Double, 84"H x 12"W	SB862812D084FB	-	-	-
Dual Density Vertical Cable Manager, Double, 84"H x 3.5"W	SB86483D084FB	30164-703	EC3D7	-
Dual Density Vertical Cable Manager, Double, 84"H x 6"W	SB86486D084FB	30165-703	DV6D7	-
Dual Density Vertical Cable Manager, Double, 84"H x 10"W	SB864810D084FB	30166-703	DV10D7	-
Dual Density Vertical Cable Manager, Double, 84"H x 12"W	SB864812D084FB	-	DV12D7	-
High Density Horizontal Cable Manager, Single, 19W x 1U	SB87019S1FB	13930-701	DCHS1	NMF1
High Density Horizontal Cable Manager, Single, 19W x 2U	SB87019S2FB	13930-702	DCHS2	NMF2
High Density Horizontal Cable Manager, Single, 19W x 3U	SB87019S3FB	13930-703	-	NMF3
High Density Horizontal Cable Manager, Double, 19W x 1U	SB87019D1FB	30529-719	-	NM1
High Density Horizontal Cable Manager, Double, 19W x 2U	SB87019D2FB	30530-719	-	NM2
High Density Horizontal Cable Manager, Double, 19W x 3U	SB87019D3FB	30531-719	-	NM3
Low Density Plastic Gate Section, 3"W	SB8623KFB	13934-717	DGP3	-
Low Density Plastic Gate Section, 6"W	SB8626KFB	13934-727	DGP6	-
Low Density Plastic Gate Section, 10"W	SB86210KFB	13934-747	DGP10	-
Low Density Plastic Gate Section, 12"W	SB86212KFB	13934-757	-	-
Cable Spool	SB860ACSF	13935-701	PSP00L	PRSP7

† Mark shown is property of respective owner.

Part No.	Page No.	Part No.	Page No.	Part No.	Page No.
SB72834x6	27	SB860810D096__	12 & 13	SB86283S084__	14 & 15
SB72758x6	27	SB860810D108__	12 & 13	SB86283S090__	14 & 15
SB81003FB	4	SB860810S066__	10 & 11	SB86283S096__	14 & 15
SB81006FB	4	SB860810S072__	10 & 11	SB86283S108__	14 & 15
SB860ACSFb	28	SB860810S078__	10 & 11	SB86286D066__	16 & 17
SB860ACSK066FB	28	SB860810S084__	10 & 11	SB86286D072__	16 & 17
SB860ACSK072FB	28	SB860810S090__	10 & 11	SB86286D078__	16 & 17
SB860ACSK078FB	28	SB860810S096__	10 & 11	SB86286D084__	16 & 17
SB860ACSK084FB	28	SB860810S108__	10 & 11	SB86286D090__	16 & 17
SB860ACSK090FB	28	SB860810SK084FB	29	SB86286D096__	16 & 17
SB860ACSK096FB	28	SB860812D066__	12 & 13	SB86286D108__	16 & 17
SB860ACSK108FB	28	SB860812D072__	12 & 13	SB86286S066__	14 & 15
SB860FMB__	26	SB860812D078__	12 & 13	SB86286S072__	14 & 15
SB860FSFB	24	SB860812D084__	12 & 13	SB86286S078__	14 & 15
SB860FSXFB	24	SB860812D090__	12 & 13	SB86286S084__	14 & 15
SB86083D066__	12 & 13	SB860812D096__	12 & 13	SB86286S090__	14 & 15
SB86083D072__	12 & 13	SB860812D108__	12 & 13	SB86286S096__	14 & 15
SB86083D078__	12 & 13	SB860812S066__	10 & 11	SB86286S108__	14 & 15
SB86083D084__	12 & 13	SB860812S072__	10 & 11	SB862810D066__	16 & 17
SB86083D090__	12 & 13	SB860812S078__	10 & 11	SB862810D072__	16 & 17
SB86083D096__	12 & 13	SB860812S084__	10 & 11	SB862810D078__	16 & 17
SB86083D108__	12 & 13	SB860812S090__	10 & 11	SB862810D084__	16 & 17
SB86083S066__	10 & 11	SB860812S096__	10 & 11	SB862810D090__	16 & 17
SB86083S072__	10 & 11	SB860812S108__	10 & 11	SB862810D096__	16 & 17
SB86083S078__	10 & 11	SB860812SK084FB	29	SB862810D108__	16 & 17
SB86083S084__	10 & 11	SB86163DFB	5	SB862810S066__	14 & 15
SB86083S090__	10 & 11	SB86163SFB	5	SB862810S072__	14 & 15
SB86083S096__	10 & 11	SB86166DFB	5	SB862810S078__	14 & 15
SB86083S108__	10 & 11	SB86166SFB	5	SB862810S084__	14 & 15
SB86086D066__	12 & 13	SB862PIF	26	SB862810S090__	14 & 15
SB86086D072__	12 & 13	SB862CSM	26	SB862810S096__	14 & 15
SB86086D078__	12 & 13	SB8623GTfB	25	SB862810S108__	14 & 15
SB86086D084__	12 & 13	SB8623KfB	25	SB862812D066__	16 & 17
SB86086D090__	12 & 13	SB8626GTfB	25	SB862812D072__	16 & 17
SB86086D096__	12 & 13	SB8626KfB	25	SB862812D078__	16 & 17
SB86086D108__	12 & 13	SB86210GTfB	25	SB860812D084__	16 & 17
SB86086S066__	10 & 11	SB86210KfB	25	SB862812D090__	16 & 17
SB86086S072__	10 & 11	SB86212GTfB	25	SB862812D096__	16 & 17
SB86086S078__	10 & 11	SB86212KfB	25	SB862812D108__	16 & 17
SB86086S084__	10 & 11	SB86283D066__	16 & 17	SB862812S066__	14 & 15
SB86086S090__	10 & 11	SB86283D072__	16 & 17	SB862812S072__	14 & 15
SB86086S096__	10 & 11	SB86283D078__	16 & 17	SB862812S078__	14 & 15
SB86086S108__	10 & 11	SB86283D084__	16 & 17	SB862812S084__	14 & 15
SB86086SK084FB	29	SB86283D090__	16 & 17	SB862812S090__	14 & 15
SB860810D066__	12 & 13	SB86283D096__	16 & 17	SB862812S096__	14 & 15
SB860810D072__	12 & 13	SB86283D108__	16 & 17	SB862812S108__	14 & 15
SB860810D078__	12 & 13	SB86283S066__	14 & 15	SB862HRD3066__	20
SB860810D084__	12 & 13	SB86283S072__	14 & 15	SB862HRD3072__	20
SB860810D090__	12 & 13	SB86283S078__	14 & 15	SB862HRD3078__	20

Cable Management - RCM & RCM+™

Part No.	Page No.	Part No.	Page No.	Part No.	Page No.
SB862HRD3084_	20	SB862BRC12084_	21	SB87019SX2_	22
SB862HRD3090_	20	SB862BRC12090_	21	SB87019SX3_	22
SB862HRD3096_	20	SB862BRC12096_	21	SB87019SX4_	22
SB862HRD3108_	20	SB862BRC12108_	21	SB87023D1_	23
SB862HRD6066_	20	SB86306FTK	7	SB87023D2_	23
SB862HRD6072_	20	SB86303GK	7	SB87023D3_	23
SB862HRD6078_	20	SB86306GK	7	SB87023D4_	23
SB862HRD6084_	20	SB86483D066_	18 & 19	SB87023S1_	22
SB862HRD6090_	20	SB86483D072_	18 & 19	SB87023S2_	22
SB862HRD6096_	20	SB86483D078_	18 & 19	SB87023S3_	22
SB862HRD6108_	20	SB86483D084_	18 & 19	SB87023S4_	22
SB862HRD10066_	20	SB86483D090_	18 & 19	SBCMV BCKL	27
SB862HRD10072_	20	SB86483D096_	18 & 19		
SB862HRD10078_	20	SB86483D108_	18 & 19		
SB862HRD10084_	20	SB86486D066_	18 & 19		
SB862HRD10090_	20	SB86486D072_	18 & 19		
SB862HRD10096_	20	SB86486D078_	18 & 19		
SB862HRD10108_	20	SB86486D084_	18 & 19		
SB862HRD12066_	20	SB86486D090_	18 & 19		
SB862HRD12072_	20	SB86486D096_	18 & 19		
SB862HRD12078_	20	SB86486D108_	18 & 19		
SB862HRD12084_	20	SB864810D066_	18 & 19		
SB862HRD12090_	20	SB864810D072_	18 & 19		
SB862HRD12096_	20	SB864810D078_	18 & 19		
SB862HRD12108_	20	SB864810D084_	18 & 19		
SB862BRC3066_	21	SB864810D090_	18 & 19		
SB862BRC3072_	21	SB864810D096_	18 & 19		
SB862BRC3078_	21	SB864810D108_	18 & 19		
SB862BRC3084_	21	SB864812D066_	18 & 19		
SB862BRC3090_	21	SB864812D072_	18 & 19		
SB862BRC3096_	21	SB864812D078_	18 & 19		
SB862BRC3108_	21	SB864812D084_	18 & 19		
SB862BRC6066_	21	SB864812D090_	18 & 19		
SB862BRC6072_	21	SB864812D096_	18 & 19		
SB862BRC6078_	21	SB864812D108_	18 & 19		
SB862BRC6084_	21	SB86563DFB	6		
SB862BRC6090_	21	SB86566DFB	6		
SB862BRC6096_	21	SB87019D1_	23		
SB862BRC6108_	21	SB87019DX1_	23		
SB862BRC10066_	21	SB87019D2_	23		
SB862BRC10072_	21	SB87019DX2_	23		
SB862BRC10078_	21	SB87019D3_	23		
SB862BRC10084_	21	SB87019DX3_	23		
SB862BRC10090_	21	SB87019D4_	23		
SB862BRC10096_	21	SB87019S1_	22		
SB862BRC10108_	21	SB87019S2_	22		
SB862BRC12066_	21	SB87019S3_	22		
SB862BRC12072_	21	SB87019S4_	22		
SB862BRC12078_	21	SB87019SX1_	22		

U.S. Customer Service Center is staffed Monday through Friday
from 7 a.m. to 5:00 p.m. Central Standard Time.

For more information, visit
www.cooperbline.com/datacomm.

Eaton
United States
509 West Monroe Street
Highland, IL 62249
United States
Phone: (800) 851-7415
www.cooperbline.com/contactus

Eaton
1000 Eaton Boulevard
Cleveland, OH 44122
United States
Eaton.com

B-Line Division
509 West Monroe Street
Highland, IL 62249
Phone: 800-851-7415
Fax: 618-654-1917
www.eaton.com/b-lineseries

© 2015 Eaton
All Rights Reserved
Printed in USA
Publication No. BR303002EN
October 2015 2M (DCRCM-15R)

Eaton is a registered trademark

All other trademarks are property
of their respective owners.

Follow us on social media to get the
latest product and support information.

