

Eaton Bypass Power Module (BPM) Users Guide

For use with the Following:

Eaton 9155 UPS (8–15kVA)

Eaton 9170+ UPS (3–18kVA)

Eaton 9PX Split-Phase UPS (6–10kVA)

Eaton 9PXM Split Phase UPS (4–20kVA)

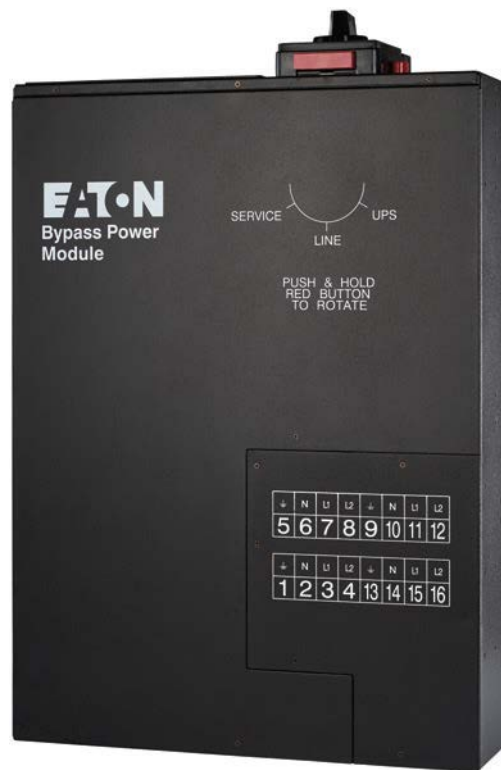

Special Symbols

The following are examples of symbols used on the product to alert you to important information:



RISK OF ELECTRIC SHOCK - Observe the warning associated with the risk of electric shock symbol.



CAUTION: REFER TO OPERATOR'S MANUAL - Refer to your operator's manual for additional information, such as important operating and maintenance instructions.



This symbol indicates that you should not discard the product in the trash. This product must be disposed of properly. For more information, contact your local recycling/reuse or hazardous waste center.



This symbol indicates that you should not discard waste electrical or electronic equipment (WEEE) in the trash. For proper disposal, contact your local recycling/reuse or hazardous waste center.



IMPORTANT

To ensure you have the most up-to-date content and information for this product, please review the latest manual revision on our website, www.eaton.com.

Table of Contents

| | |
|---|-----------|
| 1 Introduction | 1 |
| 1.1 Introduction | 1 |
| 1.2 Bypass Overview | 1 |
| 2 Installation | 3 |
| 2.1 Installation | 3 |
| 2.2 Bypass Power Module Dimensions | 3 |
| 2.3 Rackmount Installation | 4 |
| 2.4 Wallmount BPM Installation | 6 |
| 2.5 Input Current and Wire Ratings | 7 |
| 2.6 Signal Wire Routing | 8 |
| 3 BPM to UPS Connection Diagrams | 11 |
| 3.1 Eaton 9155 UPS to BPM Connection Diagram | 11 |
| 3.2 Eaton 9170+ UPS to BPM Connection Diagram | 12 |
| 3.3 9PX Split Phase UPS to BPM Connection Diagram | 13 |
| 3.4 Eaton 9PXM UPS Connection Diagram | 14 |
| 4 Operation | 15 |
| 4.1 No Break Transfer from UPS Mode to Service Mode | 15 |
| 4.2 Lock-out/Tag-out | 16 |
| 4.3 No Break Transfer from Service Bypass to UPS Mode | 16 |
| 5 Specifications | 19 |

Table of Contents

List of Figures

| | | |
|------------|---|----|
| Figure 1. | BPM Dimensions (in millimeters)..... | 3 |
| Figure 2. | Install Rail Kit..... | 4 |
| Figure 3. | Push BPM into the Rack..... | 4 |
| Figure 4. | Remove the Wire Access-Point Covers..... | 5 |
| Figure 5. | Remove the Access Panel Cover..... | 5 |
| Figure 6. | Install the Mounting Ears..... | 5 |
| Figure 7. | Secure the BPM to the Rack..... | 6 |
| Figure 8. | BPM with Wallmount Brackets..... | 6 |
| Figure 9. | BPM Hardwired Overview..... | 7 |
| Figure 10. | Signal Wire RoutingSignal Wire Routing..... | 9 |
| Figure 11. | Eaton 9155 UPS to BPM Connection Diagram Using Signal Inputs..... | 11 |
| Figure 12. | Eaton 9170+ UPS to BPM Connection Diagram With Signal Inputs..... | 12 |
| Figure 13. | 9PX Split Phase UPS to BPM Connection Diagram with Signal Inputs..... | 13 |
| Figure 14. | 9PXM UPS Connection Diagram with Signal Inputs..... | 14 |
| Figure 15. | From UPS to LINE..... | 15 |
| Figure 16. | From LINE to SERVICE..... | 16 |
| Figure 17. | LOTO Feature..... | 16 |
| Figure 18. | From SERVICE to LINE..... | 17 |
| Figure 19. | From Line to UPS..... | 17 |

List of Figures

List of Tables

| | | |
|----------|----------------------------------|---|
| Table 1. | BPM Positions | 1 |
| Table 2. | RBPM Terminal Block Sizing | 8 |

List of Tables

Chapter 1 Introduction

1.1 Introduction

The Eaton® Bypass Power Module (BPM) is designed to be a maintenance bypass switch that also contains flexible output power distribution and mounting options. The BPM is a bypass module that can be used with a variety of Eaton UPS models including the 9170+, 9155, and 9PX SP.

The BPM provides added reliability to Eaton uninterruptible power supply (UPS) systems by ensuring seamless, uninterrupted, no-break transfer as well as a lock-out/tag-out (LOTO) feature to ensure the greatest safety for UPS technicians and electricians. The BPM also offers output distribution in order to simplify wiring in a rackmount IT environment, potentially removing the need for a panelboard, breakers, and conduit for distribution.

Although the BPM is designed to be safe, the bypass can carry high levels of voltage and current. The BPM should only be operated by an experienced user, familiar with UPS behavior and functionality. Installation for models requiring hardwire connections should be performed by a qualified electrician following local electrical codes. Please refer to the installation chapter of your UPS manual for the BPM wiring diagram.

1.2 Bypass Overview

The BPM has three operating positions (see [Table 1](#)). Failure to understand the correct bypass sequence and position may cause the critical load to be dropped. Consider both the operating state of the UPS and the BPM when protecting your critical loads.



NOTE

In the UPS or LINE position, AC input power is still connected to the input terminals inside the UPS.

Table 1. BPM Positions

| Switch Position | Description |
|-----------------|---|
| UPS | The normal operating state of the system occurs when the BPM switch is in the UPS position. Utility power is fed to the bypass, where power is then fed to the UPS. The UPS provides critical battery backup and power conditioning and power is then fed back to the bypass switch and then the critical load. |

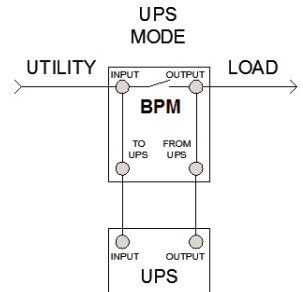

Table 1. BPM Positions (Continued)

| | | |
|---------|---|--|
| LINE | <p>When the switch is in the LINE position, utility power is directly connected to the critical load and the output of the UPS is disconnected. In this state the UPS remains powered, which is often beneficial for troubleshooting, obtaining logs, or updating firmware.</p> | |
| SERVICE | <p>Like the LINE position, the SERVICE position connects the load directly to AC input power and disconnects UPS output; however, because SERVICE also disconnects AC input from the UPS, this is the appropriate position for UPS maintenance or repair. In the SERVICE position, the UPS can be completely removed from the system.</p> | |

Chapter 2 Installation

2.1 Installation

WARNING

Risk of electrical shock. Only qualified service personnel (such as a licensed electrician) should perform the electrical installation.

CAUTION

To prevent electrical shock or damage to the equipment, verify that the Eaton UPS is OFF before you remove the entrance panel. The circuit breaker or disconnect switch must also be off at the AC input service panel. Also, turn OFF the AC disconnect and bypass switches before you connect any wires to the bypass switch terminal strip.

2.2 Bypass Power Module Dimensions

[Figure 1](#) shows the dimensions of the Bypass Power Module (BPM) in millimeters (inches).

Figure 1. BPM Dimensions (in millimeters)

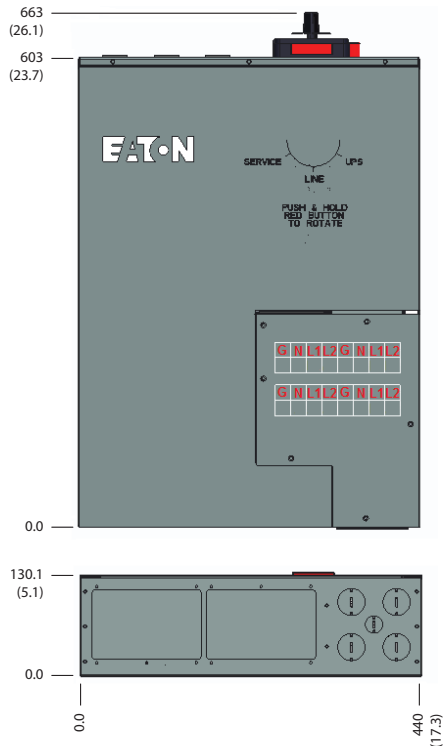

2.3 Rackmount Installation

CAUTION

- The BPM distributes high density power in a small form factor.
 - Read the complete installation procedure before beginning any electrical wiring.
-

To install the BPM in a rack:

1. Install the 4-post rail kit included with the BPM (see [Figure 2](#)).

Figure 2. Install Rail Kit

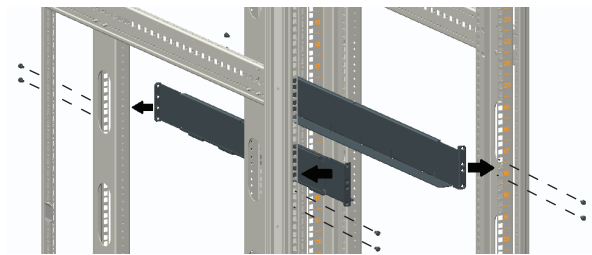

2. Place the BPM on the rails and push the BPM into the rack.
Verify that the breakers are facing the front of the rack and the BPM wiring terminals are facing the rear of the rack.
3. Push the BPM past the back of the rack to allow access to the rear wire access-point covers and the wire access panel cover (see [Figure 3](#)).

Figure 3. Push BPM into the Rack

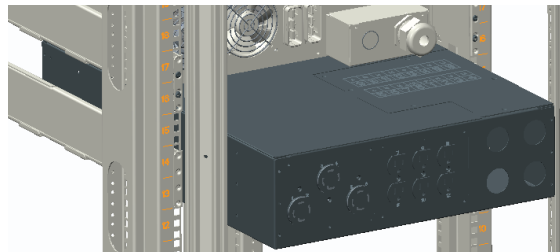

4. Remove the wire access-point covers (see [Figure 4](#)).

Figure 4. Remove the Wire Access-Point Covers

5. Remove the access panel cover (see [Figure 5](#)).

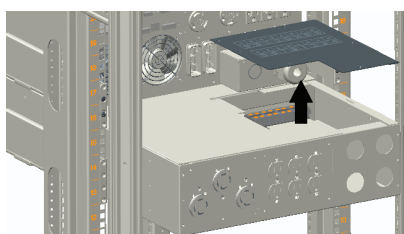
Figure 5. Remove the Access Panel Cover

6. To wire the BPM, .
7. After wiring is complete, replace the covers removed in [Step 4](#) and [Step 5](#).
8. Push the BPM past the front of the rack to allow access for the mounting ears installation.
9. Install the mounting ears to the BPM using the provided screws (see [Figure 6](#)).

Figure 6. Install the Mounting Ears

10. Push the BPM into the rack and secure the mounting ears to the rack using the provided screws (see [Figure 7](#)).

Figure 7. Secure the BPM to the Rack

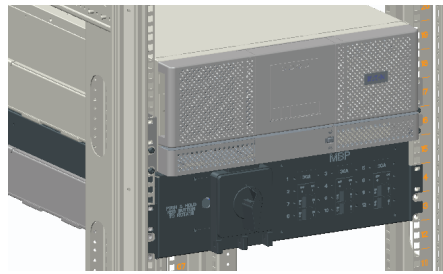

2.4 Wallmount BPM Installation

CAUTION

- The BPM distributes high density power in a small form factor.
- Read the complete installation procedure before beginning any electrical wiring.

To install the BPM in a wallmount form factor:

1. Select a mounting location for the bypass switch within sight of the UPS.



NOTE

The bypass switch should be mounted securely to a sturdy surface. You may need to turn the cabinet 90 degrees (on its side) to enable operator access to the switch handle.

2. Use the provided wallmount brackets to firmly secure the BPM to the wall ([Figure 8](#)).

Figure 8. BPM with Wallmount Brackets

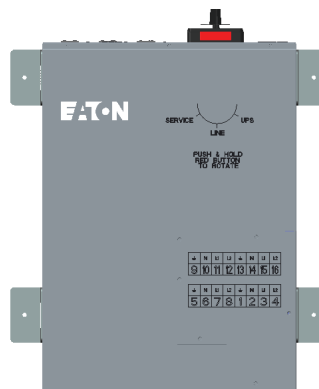

3. Remove the six (6) screws on the BPM front cover and remove the cover.
Remove any packing material inside the BPM.
4. Remove the knockouts in the bottom of the BPM as needed for wiring (see [Figure 9](#)).

Figure 9. BPM Hardwired Overview

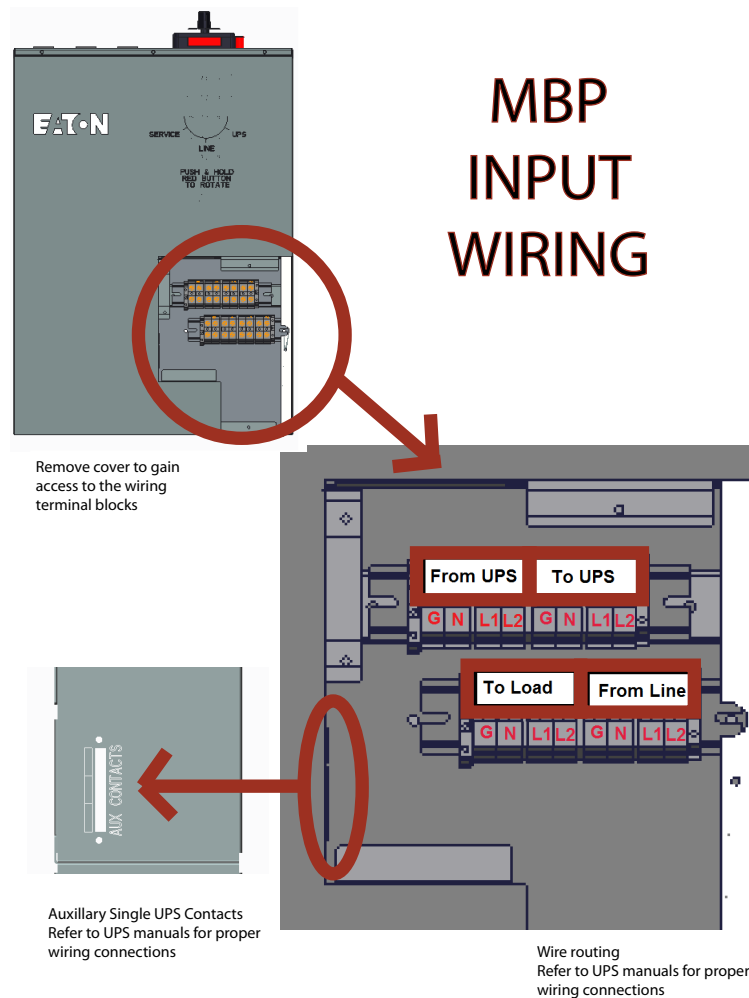

5. To wire the BPM, see [2.6 Signal Wire Routing](#).
6. After wiring is complete, replace the cover removed in [Step 3](#).

2.5 Input Current and Wire Ratings

Wiring to the BPM varies based on the UPS selection. Refer to the UPS manual for recommended input breaker size. To easily expand the system, it is recommended that initial installation of the BPM and UPS contains wiring to support the maximum capacity of the UPS system. For example, if the UPS is now designed to be a 12 kVA system with an 80A input, but can be expanded to 18 kVA requiring 125A input in the future, then 125A wiring would be used initially to prevent rewiring costs during future expansion.

Local electrical codes should always be followed, but be sure to check with the terminal block sizing on both the UPS and the BPM. The UPS terminal block sizing can be found in the UPS manual, while the BPM terminal block sizing can be found in [Table 2](#).

Table 2. RBPM Terminal Block Sizing

| BPM Terminal Block Sizing | 75°C Copper Wire Size | Conductor Screw Torque | Wire Size Range |
|---------------------------|------------------------------|------------------------|-----------------|
| BPM 125A Models | 42.1 mm ² (1 AWG) | 6.6 Nm (50 lb in) | 10 - 1/0 AWG |
| BPM 30A Models | 8.4 mm ² (8 AWG) | 4.5 Nm (40 lb in) | 14 - 6 AWG |

**IMPORTANT**

FOR U.S. INSTALLATIONS, READ THIS IMPORTANT NOTE

- [Table 2](#) lists the mm² and AWG wire size for each circuit breaker size shown on the wiring diagrams. The minimum recommended circuit breaker sizes for each model and voltage application are listed on the wiring diagrams.
- Conductor sizes shall be no smaller than the 75°C wire size based on the ampacities given in Table 310–16 of the National Electrical Code® (NEC®), ANSI/NFPA 70-1999, and article 220. All circuit conductors, including the neutral conductor, must be the same size (ampacity) wire. Code may require a larger AWG size than shown in this table because of temperature, number of conductors in the conduit, or long service runs. Follow local code requirements.

2.6 Signal Wire Routing

CAUTION

The auxiliary contacts must be wired to the BPM from the UPS for proper functionality. These auxiliary contacts signal the UPS to go to Internal Bypass mode to provide a synchronized transfer. Failure to wire the auxiliary contacts can be dangerous and result in system failure. Check the UPS users guide that is being used with the BPM for specific contact functionality.

NOTE 1 Refer to the UPS manual and [“Input Current and Wire Ratings” on page 11](#) for breaker, terminal block, and wire sizing.



NOTE 2 Provide enough flexibility in the conduit for the BPM to be firmly mounted in the rack.

NOTE 3 Connection diagrams can be found on pages 11–14 for wiring details.

To route signal wires (customer supplied):

1. Route the signal wires through the provided insulation.
2. Pass the insulated wires through the opening in the rear panel ([Figure 10](#)).
3. Connect terminal blocks to signal wires.
4. Plug in the terminal blocks into their proper locations.
5. Place the insulated wires into the two wire clips as shown.

Figure 10. Signal Wire Routing

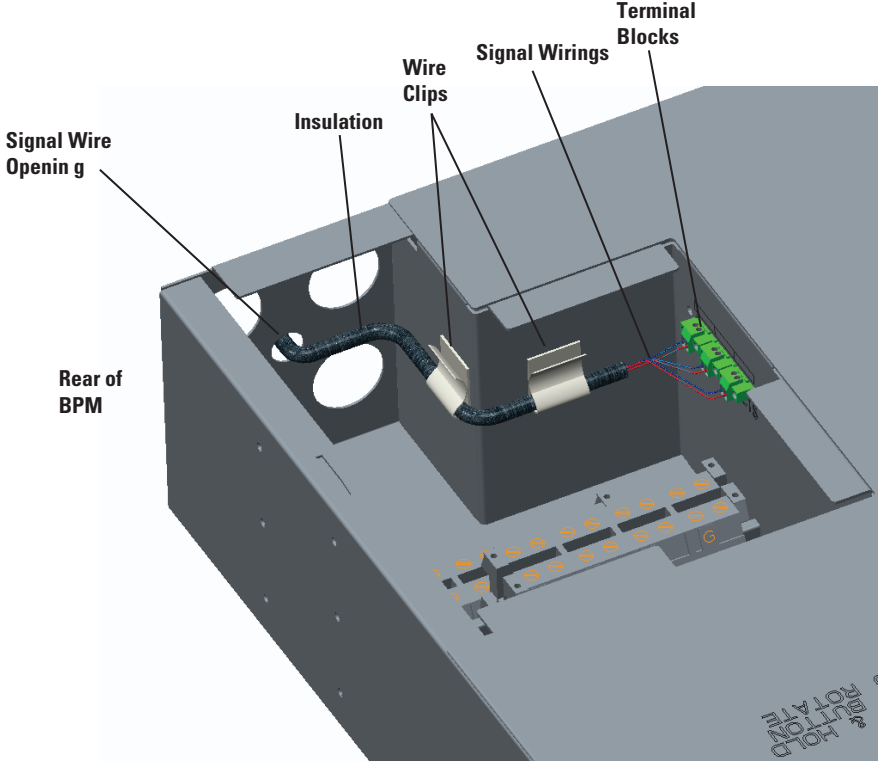

Chapter 3 BPM to UPS Connection Diagrams

3.1 Eaton 9155 UPS to BPM Connection Diagram

Figure 11. Eaton 9155 UPS to BPM Connection Diagram Using Signal Inputs

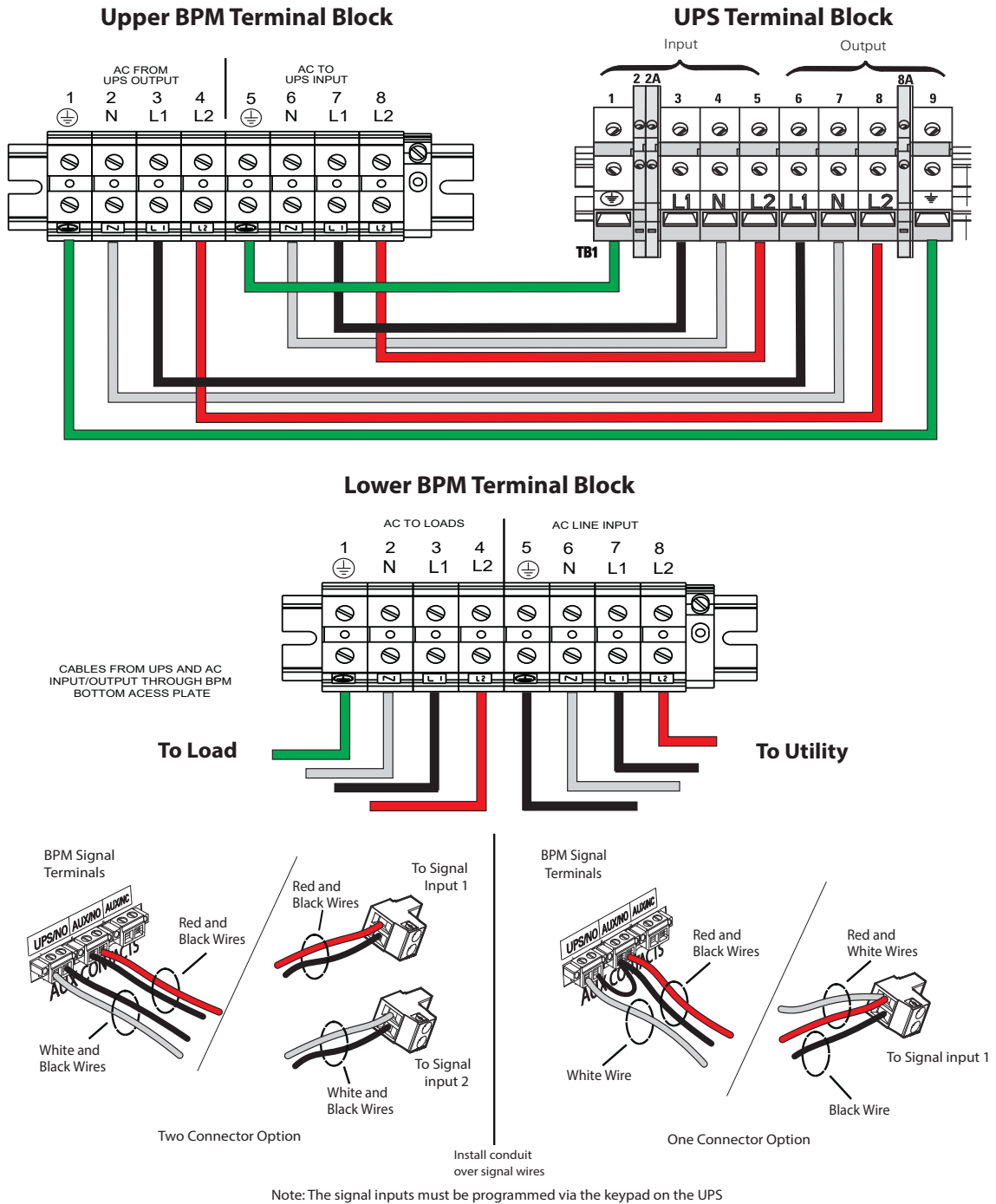

3.2 Eaton 9170+ UPS to BPM Connection Diagram

Figure 12. Eaton 9170+ UPS to BPM Connection Diagram With Signal Inputs

Consult 9170+ User Guide for Universal Connections

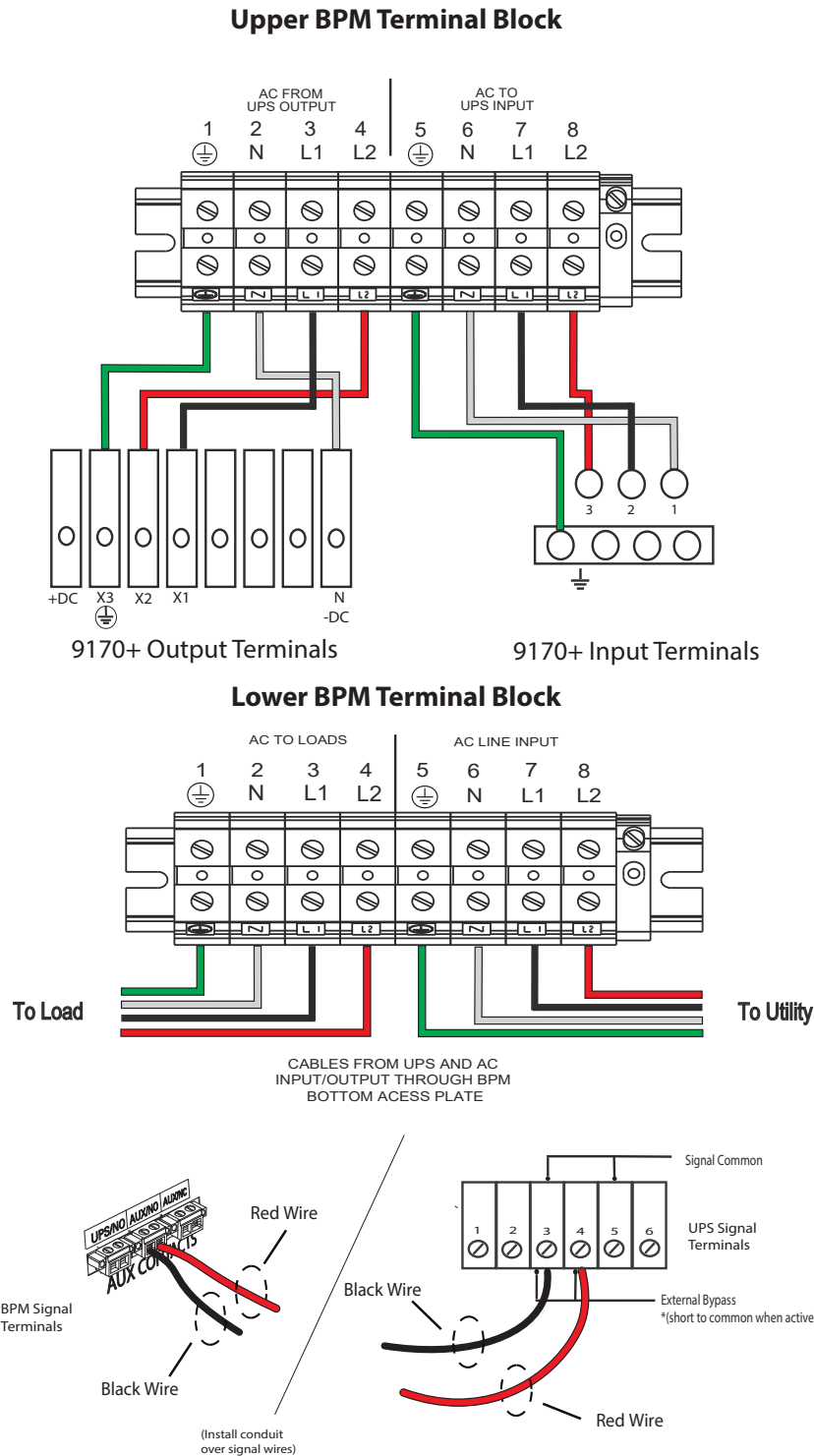

3.3 9PX Split Phase UPS to BPM Connection Diagram

Figure 13. 9PX Split Phase UPS to BPM Connection Diagram with Signal Inputs

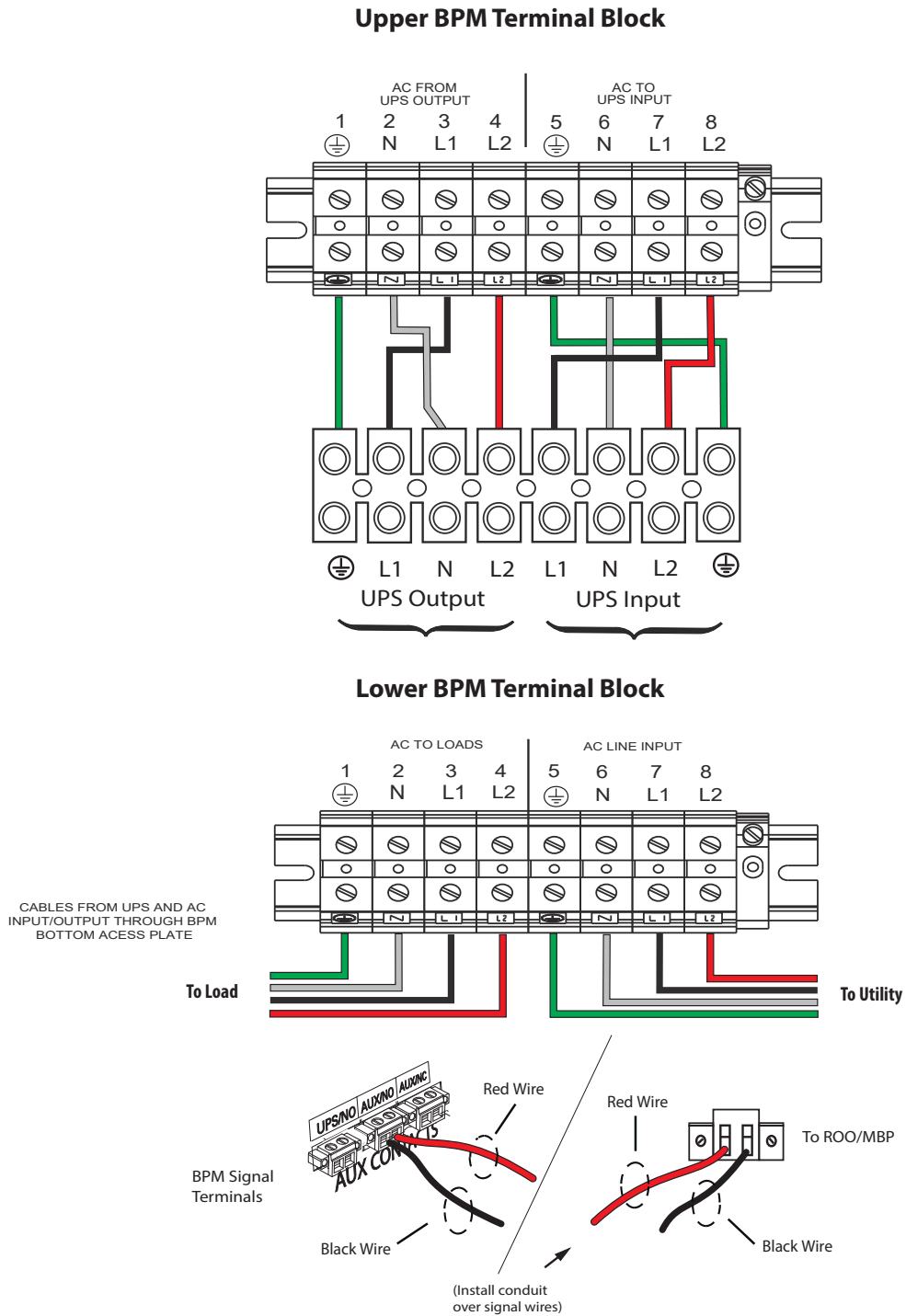

** Set the value of the "Remote On/Off parameter through the UPS front display to "Bypass for MBP" **

3.4 Eaton 9PXM UPS Connection Diagram

Figure 14. 9PXM UPS Connection Diagram with Signal Inputs

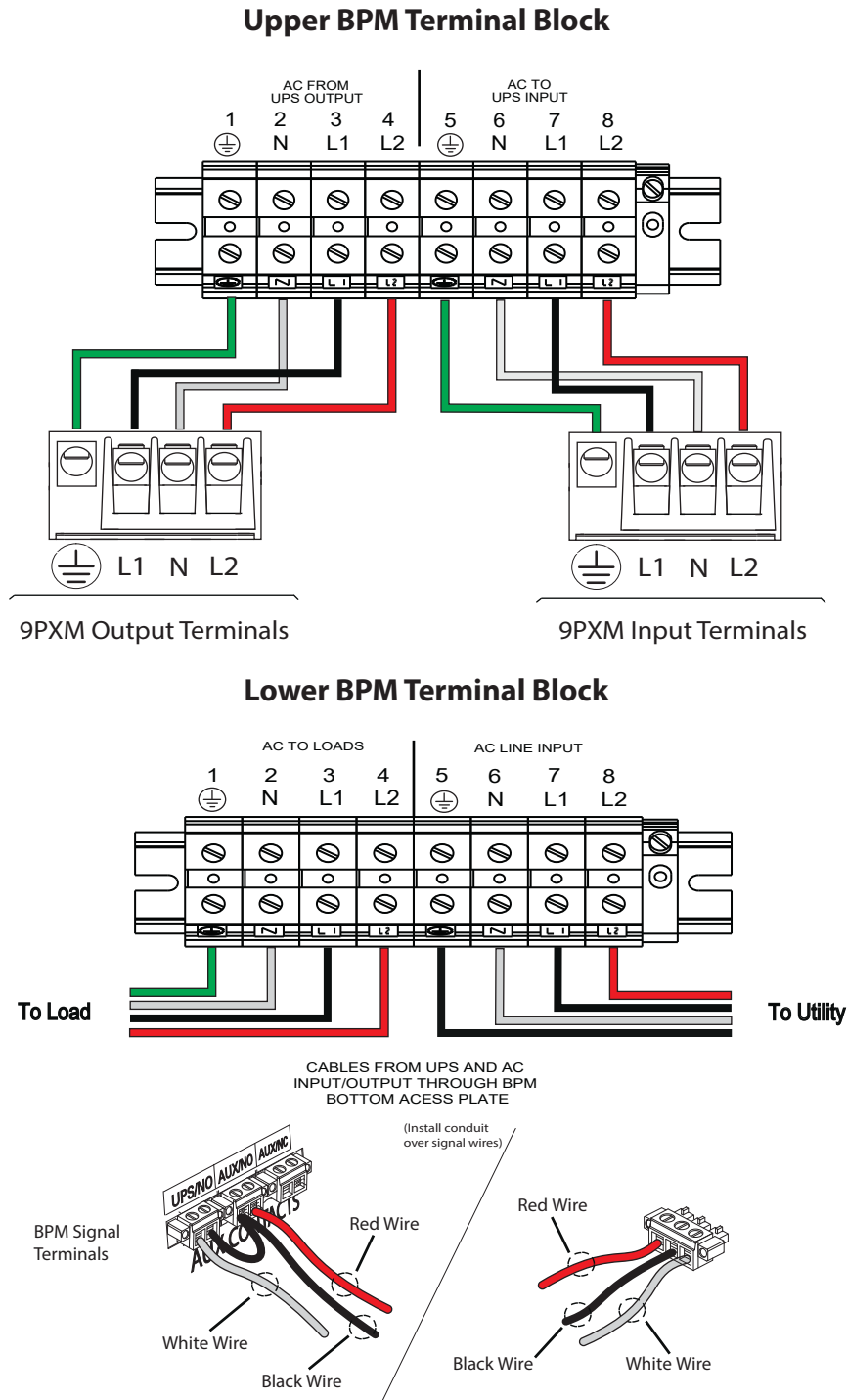

** Set the value of "Signal Input 1 and Signal Input 2" through the UPS front display to "Normally Open". **

Chapter 4 Operation

4.1 No Break Transfer from UPS Mode to Service Mode

CAUTION

It is critical that the following steps are followed to ensure correct and safe operation.

Do not attempt to push the red interlock button or attempt to move the bypass switch handle if the UPS is operating on battery power.

Refer to the UPS user guide or call the Eaton service help desk for specific BPM to UPS signal functionality.

To turn the BPM to SERVICE:

1. Press and hold the red button and turn the switch to LINE (see [Figure 15](#)).



NOTE

Pressing the red button sends the UPS into Internal Bypass mode. This allows the UPS output to synchronize with utility for safe, uninterrupted transfer.

The UPS is now in LINE mode. The critical load is fed directly from utility and the UPS remains energized from utility power. The UPS may be left in this mode while trying to troubleshoot, gather alarms from the UPS, or perform other preventative maintenance activities.

Figure 15. From UPS to LINE

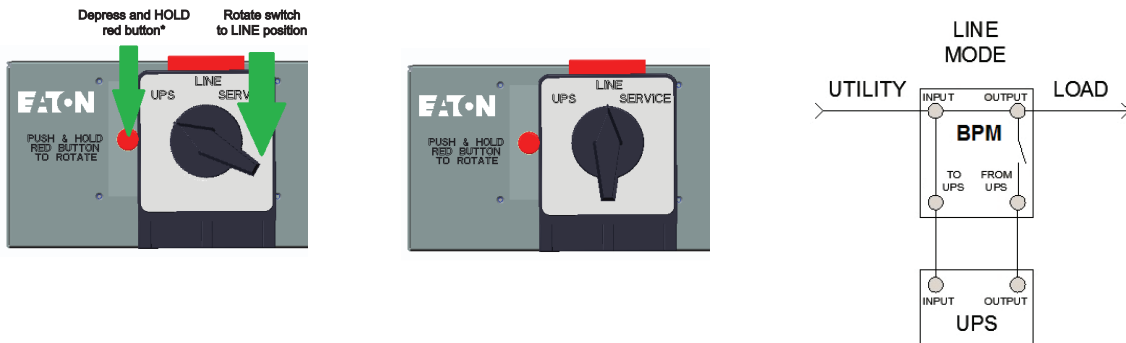

2. Turn the switch from LINE to SERVICE (see [Figure 16](#)). The critical load is fed directly from utility and the UPS is now completely disconnected from AC power. Ensure that the UPS is off and the terminals are completely de-energized before performing any maintenance on the UPS.

Figure 16. From LINE to SERVICE

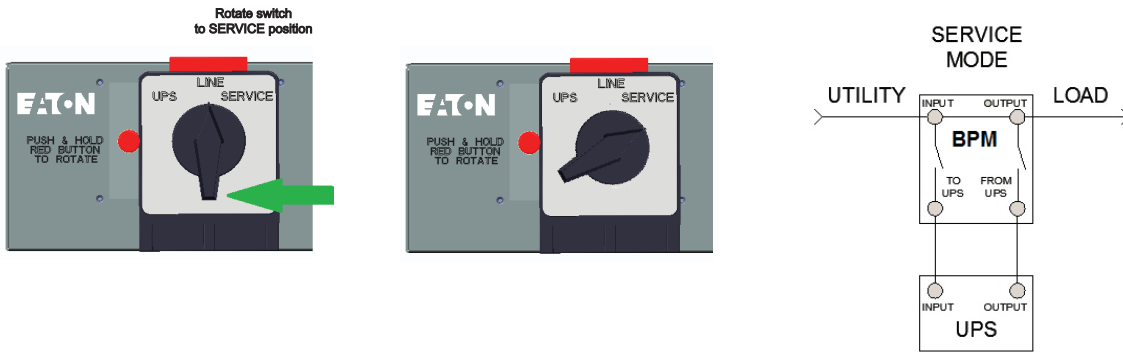

4.2 Lock-out/Tag-out

The BPM comes with a Lock-out/Tag-out (LOTO) feature to keep the BPM bypass switch locked in SERVICE mode while qualified service personnel works on the UPS. To use the LOTO feature:

1. Press and hold the red bar (see).

Figure 17. LOTO Feature

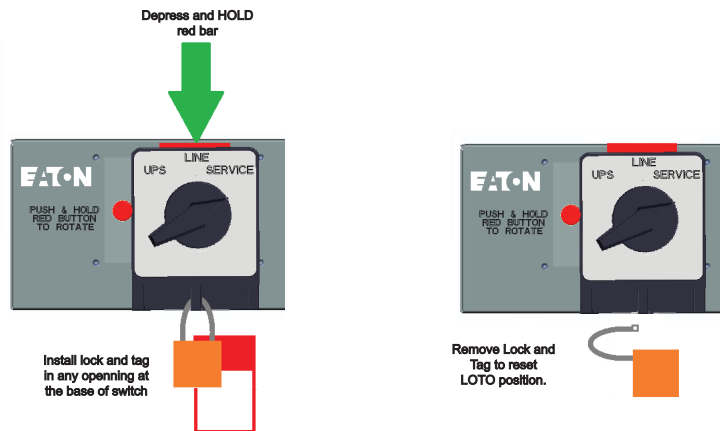

2. Install a lock and tag in any opening at the base of the switch according to LOTO procedures.
3. Remove the lock and tag to reset the LOTO position.

4.3 No Break Transfer from Service Bypass to UPS Mode

After the system has been placed into SERVICE mode, it must be returned to UPS state to resume normal operation.

⚠ CAUTION

It is critical that the following steps are followed to ensure correct and safe operation.

Do not attempt to push the red interlock button or attempt to move the bypass switch handle if the UPS is operating on battery power.

Refer to the UPS user guide or call the Eaton service help desk for specific BPM to UPS signal functionality.

To turn the BPM to UPS mode:

1. Turn the switch from SERVICE to LINE (see [Figure 18](#)).

The UPS is now in LINE mode and is energized. It is often best practice to check the UPS status and configure settings in this mode before transitioning to UPS mode. Simply check the status of the UPS through the front LCD menu to ensure the UPS is prepared for use.

Figure 18. From SERVICE to LINE

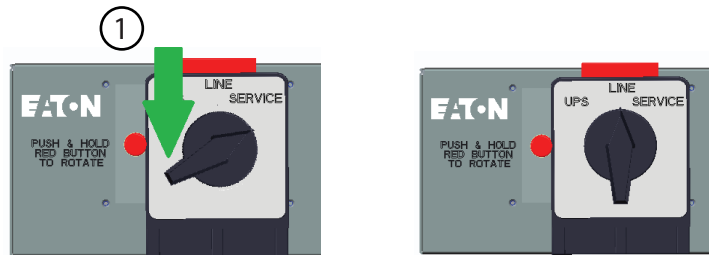

2. To transition the UPS from LINE to UPS, press and hold the red button and turn the switch to UPS (see).

NOTE 1 Pressing the red button sends the UPS into Internal Bypass mode. This allows the UPS output to synchronize with utility for safe, uninterrupted transfer.

 **NOTE 2** In UPS mode, the UPS resets from Internal Bypass to UPS Normal mode (online mode). This transition may take as long as 60 seconds.

NOTE 3 Do not attempt to push the red interlock button or attempt to move the bypass switch handle if the UPS is operating on battery power.

Figure 19. From Line to UPS

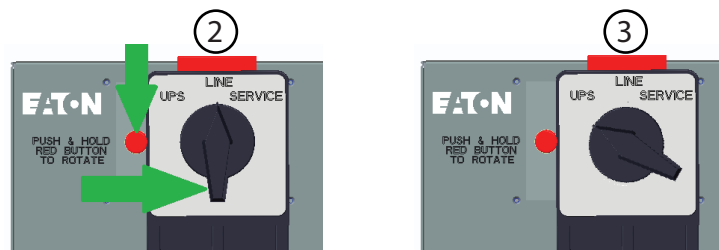

3. Once the switch is in UPS mode and the UPS is in Normal mode (online mode), the system is in normal operation and prepared to provide uninterrupted power to the critical load.

No Break Transfer from Service Bypass to UPS Mode

Chapter 5 Specifications

5.1 Weights and Dimensions

This chapter provides the following specifications:

- Dimensions and weights
- Electrical connections
- Rear Panel Outlet Options

Table 3. Weights and Dimensions

| Model | Dimensions HXWXD (mm/inch) | Weight (kg/lb) |
|----------|-------------------------------------|----------------|
| BPM125XX | 130 x 440 x 663 / 5.1 x 17.3 x 26.1 | 17/38 |

Table 4. Input Connection Type

| Model | Input Connection |
|----------|--------------------------|
| BPM125XX | Hardwired (L1, L2, N, G) |

Figure 20. Rear Panel Outlet Options

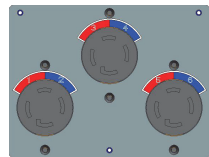

L14-30R

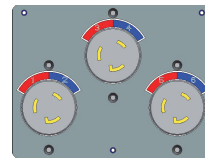

L6-20R



L6-30R

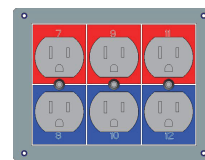

5-20R



C19



Blank

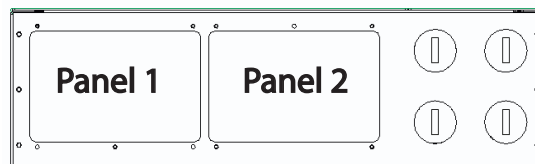



P-164000628 05