

 episode

INSTALLATION MANUAL

ES-SUB-ELE8-250

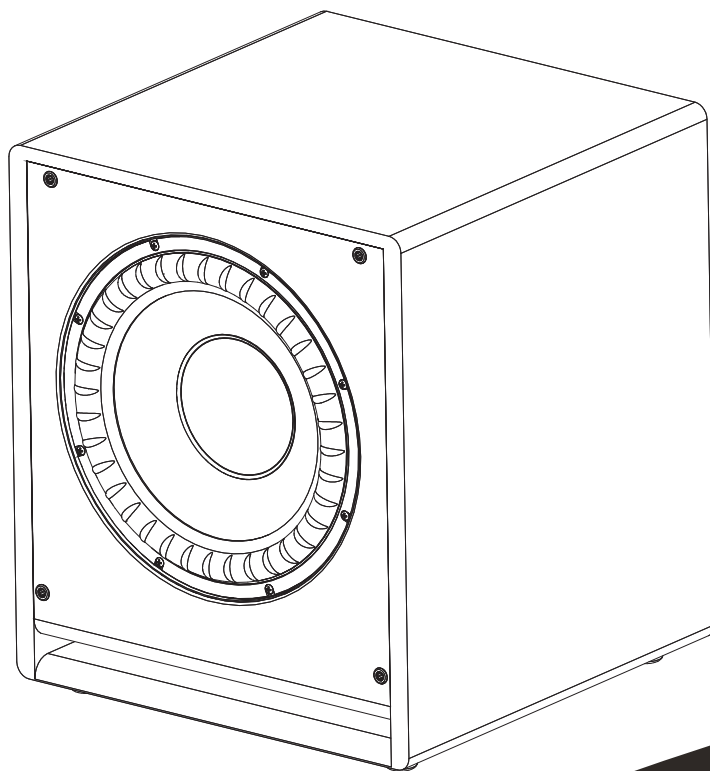

ES-SUB-ELE10-450

ES-SUB-ELE12-700



REAL. LIFE. SOUND.



	The lightning flash with arrowhead symbol within an equilateral triangle is intended to alert the user to the presence of uninsulated "dangerous voltage" within the product's enclosure that may be of sufficient magnitude to constitute a risk of electrical shock to persons.
	The exclamation point, within an equilateral triangle, is intended to alert the user to the presence of important operating and maintenance (servicing) instructions in the literature accompanying the product.

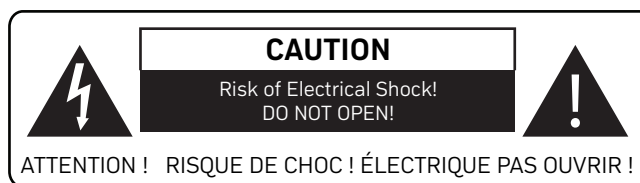

1. READ these instructions.
2. KEEP these instructions.
3. HEED all warnings.
4. FOLLOW all instructions.
5. DO NOT use this apparatus near water.
6. CLEAN ONLY with dry cloth.
7. DO NOT block any ventilation openings. Install in accordance with the manufacturer's instructions.
8. DO NOT install near any heat sources such as radiators, heat registers, stoves, or other apparatus (including amplifiers) that produce heat.
9. DO NOT defeat the safety purpose of the polarized or grounding type plug. A polarized plug has two blades with one wider than the other. A grounding type plug has two blades and a third grounding prong. The wider blade or the third prong are provided for your safety. If the provided plug does not fit into your outlet, consult an electrician for replacement of the obsolete outlet.
10. PROTECT the power cord from being walked on or pinched, particularly at plugs, convenience receptacles, and the point where they exit from the apparatus.
11. ONLY USE attachments/accessories specified by the manufacturer.
12.  USE ONLY with the cart, stand, tripod, bracket, or table specified by the manufacturer, or sold with the apparatus. When a cart is used, use caution when moving the cart/apparatus combination to avoid injury from tip-over.
13. UNPLUG this apparatus during lightning storms or when unused for long periods of time.
14. REFER all servicing to qualified service personnel. Servicing is required when the apparatus has been damaged in any way, such as power-supply cord or plug is damaged, liquid has been spilled or objects have fallen into the apparatus, the apparatus has been exposed to rain or moisture, does not operate normally, or has been dropped.
15. To reduce the risk of fire or electric shock, do not expose this apparatus to rain or moisture. The apparatus shall not be exposed to dripping or splashing and that objects filled with liquids, such as vases, shall not be placed on apparatus.
16. To completely disconnect this apparatus from the AC mains, disconnect the power supply cord plug from the AC receptacle.
17. The mains plug/appliance coupler is used as disconnect device, the disconnect device shall remain readily operable.
18. DO NOT overload wall outlets or extension cords beyond their rated capacity as this can cause electric shock or fire.
19. No naked flame sources, such as lighted candles, should be placed on the apparatus.
20. Correct Disposal of this product. This marking indicates that this product should not be disposed with other household

wastes throughout the EU. To prevent possible harm to the environment or human health from uncontrolled waste disposal, recycle it responsibly to promote the sustainable reuse of material resources. To return your used device, please use the return and collection systems or contact the retailer where the product was purchased. They can take this product for environmental safe recycling.

21. This equipment is a Class II or double insulated electrical appliance. It has been designed in such a way that it does not require a safety connection to electrical earth. (for wireless subwoofer unit)

WARNING: To reduce the risk of fire or electrical shock, do not expose this apparatus to rain or moisture.

WARNING: No naked flame sources – such as candles – should be placed on the product.

THIS PRODUCT CONTAINS A LITHIUM COIN CELL BATTERY. IF MISUSED OR ABUSED THIS CAN RESULT IN:

- Smoke or gas hazard • Heat hazard • Fire hazard • Explosion hazard

WARNING: Do not place batteries in mouth or ingest.

Chemical burn hazard. Keep new and used batteries out of reach of children and pets. If swallowed, it can cause severe internal burns in just 2 hours and can lead to death.

If you think batteries might have been swallowed or placed inside any part of the body, seek immediate medical attention.

WARNING: If battery compartment does not close securely, stop using the product and keep it away from children and pets.

WARNING: Do not handle leaking or damaged Lithium batteries.

WARNING: Risk of leakage. Only use the specified type of batteries. Never mix new and used batteries. Observe correct polarity. Remove batteries from products that are not in use for extended periods of time. Store batteries in a dry place.

WARNING: Batteries (battery pack or batteries installed) shall not be exposed to excessive heat such as sunshine, fire or the like.

WARNING: Danger of explosion if battery is incorrectly replaced. Replace only with the same or equivalent type.

WARNING: Do not recharge non-rechargeable batteries.

WARNING: Avoid exposure to extreme heat or cold. Please dispose of any used batteries properly, following any local regulations. Do not incinerate.

WARNING: Do Not Open! Risk of Electrical Shock. Voltages in this equipment are hazardous to life. No user-serviceable parts inside. Refer all servicing to qualified service personnel.

Place the equipment near a main power supply outlet and make sure that you can easily access the power breaker switch.

WARNING: This product is intended to be operated ONLY from the AC Voltages listed on the back panel or included power supply of the product. Operation from other voltages other than those indicated may cause irreversible damage to the product and void the products warranty. The use of AC Plug Adapters is cautioned because it can allow the product to be plugged into voltages in which the product was not designed to operate. If the product is equipped with a detachable power cord, use only the type provided with your product or by your local distributor and/or retailer. If you are unsure of the correct operational voltage, please contact your local distributor and/or retailer. This equipment complies with FCC radiation exposure limits set forth for an uncontrolled environment. This equipment should be installed and operated with minimum distance 20cm between the radiator & your body.



Eligible to bear the CE mark; Conforms to European Union Low Voltage Directive 2006/95/EC; European Union EMC Directive 2004/108/EC; European Union Restriction of Hazardous Substances Recast (RoHS2) Directive 2011/65/EC; European Union WEEE Directive 2002/96/EC; European Union Eco-Design Directive 2009/125/EC; European Union registration, Evaluation, Authorization and Restriction of Chemicals (REACH) Directive

2006/121/EC; European Union Radio and Telecommunications Terminal Equipment (R&TTE) Directive 1999/5/EC.

This product contains batteries that are covered under the 2006/66/EC European Directive, which cannot be disposed of with normal household waste. Please follow local regulations.

You may obtain a free copy of the Declaration of Conformity by contacting your dealer, distributor or worldwide headquarters.

WEEE NOTICE

Note: This mark applies only to countries within the European Union (EU) and Norway.



This appliance is labeled in accordance with European Directive 2002/96/EC concerning waste of electrical and electronic equipment (WEEE). This label indicates that this product should not be disposed of with household waste. It should be deposited at an appropriate facility to enable

recovery and recycling.

Federal Communication Commission Interference Statement

This device complies with Part 15 of the FCC Rules. Operation is subject to the following two conditions: (1) This device may not cause harmful interference, and (2) this device must accept any interference received, including interference that may cause undesired operation.

This equipment has been tested and found to comply with the limits for a Class B digital device, pursuant to Part 15 of the FCC Rules.

These limits are designed to provide reasonable protection against harmful interference in a residential installation. This equipment generates, uses and can radiate radio frequency energy and, if not installed and used in accordance with the instructions, may cause harmful interference to radio communications. However, there is no guarantee that interference will not occur in a particular installation. If this equipment does cause harmful interference to radio or television reception, which can be determined by turning the equipment off and on, the user is encouraged to try to correct the interference by one of the following measures:

Reorient or relocate the receiving antenna.

Increase the separation between the equipment and receiver.

Connect the equipment into an outlet on a circuit different from that to which the receiver is connected.

Consult the dealer or an experienced radio/TV technician for help.

Approved under the verification provision of FCC Part 15 as a Class B Digital Device.

Caution: Changes or modifications not expressly approved by the manufacturer could void the user's authority to operate this device.

Caution: To comply with the limits of the Class B digital device, pursuant to Part 15 of the FCC Rules, this device is to comply with Class B limits. All peripherals must be shielded and grounded. Operation with non-certified peripherals or non-shielded cables may result in interference to radio or reception.

Radiation Exposure Statement:

This equipment complies with FCC radiation exposure limits set forth for an uncontrolled environment. This equipment should be installed and operated with minimum distance 20cm between the radiator & your body.

Note: The country code selection is for non-US model only and is not available to all US model. Per FCC regulation, all WiFi product marketed in US must fixed to US operation channels only.

This Class B digital apparatus complies with Canadian ICES-003. CAN ICES-3 (B)/NMB-3(B)

WIRELESS TRANSMITTER COMPLIANCE INFORMATION

The term "IC:" before the radio certification number only signifies that Industry Canada technical specifications were met.

This device complies with part 15 of the FCC Rules and the applicable Industry Canada license-exempt RSS standard(s). Operation is subject to the following two conditions: (1) this

device may not cause harmful interference, and (2) this device must accept any interference, including interference that may cause undesired operation of the device.

This equipment complies with FCC and IC radiation exposure limits

set forth for an uncontrolled environment. This equipment should be installed and operated with minimum distance 20cm between the radiator and your body. This transmitter must not be co-located or operating in conjunction with any other antenna or transmitter.

PRÉCAUTIONS DE SÉCURITÉ IMPORTANTES A LIRE EN PREMIER !

1. Lisez ces instructions.
2. Conservez ces instructions.
3. Tenez compte de tous les avertissements.
4. Suivez toutes les instructions.
5. N'utilisez pas cet appareil près de l'eau.
6. Nettoyez uniquement avec un chiffon sec.
7. Ne bouchez aucune ouverture de ventilation. Installez conformément aux instructions du fabricant
8. Ne l'installez pas à proximité d'une source de chaleur telle que des radiateurs, des bouches de chaleur, des fourneaux ou d'autres appareils (y compris les amplificateurs) qui produisent de la chaleur.
9. Ne détournez pas l'objectif de sécurité de la fiche polarisée ou de mise à la terre. Une fiche polarisée a deux lames dont l'une est plus large que l'autre. Une fiche avec mise à la terre a deux lames et une troisième broche de mise à la terre. La lame large ou la troisième broche sont conçues pour votre sécurité. Si la fiche fournie ne s'insère pas correctement dans votre prise, consultez un électricien pour le remplacement de la prise obsolète.
10. Évitez de marcher sur le cordon secteur ou de le pincer, en particulier au niveau des fiches, des prises de courant et à son point de sortie de l
11. Utilisez seulement des compléments/accessoires spécifiés par le constructeur.
12. Utilisez l'appareil seulement avec le chariot, pied, trépied, support ou table spécifié par le constructeur, ou vendu avec l'appareil. Lors de l'utilisation d'un chariot, faites attention en déplaçant l'ensemble chariot/appareil afin d'éviter des blessures dues à un basculement.
13. Débranchez cet appareil pendant les orages ou s'il est inutilisé pendant de longues périodes.
14. Confiez tous les travaux d'entretien à du personnel qualifié. Un entretien est nécessaire si l'appareil a été endommagé d'une façon quelconque, si le cordon ou la fiche d'alimentation sont endommagés, si du liquide a été renversé sur l'appareil ou si des objets sont tombés dedans, si l'appareil a été exposé à la pluie ou à l'humidité, s'il ne fonctionne pas normalement ou s'il est tombé.
15. L'appareil : ne doit pas être exposé à un égouttement ou à des projections et aucun objet rempli de liquide, tel qu'un vase, ne doit être placé sur .
16. Pour débrancher complètement cet appareil du secteur, débranchez la fiche du cordon d'alimentation de la prise secteur.
17. La fiche secteur du cordon d'alimentation doit rester immédiatement accessible.
18. Les piles ne doivent pas être exposées à une chaleur excessive telle que le soleil, un feu ou un équivalent

AL'éclair avec un symbole fléché se trouvant dans un triangle équilatéral est destiné à alerter l'utilisateur de la présence d'un cc voltage dangereux » non isolé au sein du produit qui pourrait être d'une magnitude suffisante pour constituer un risque de décharge électrique sur une personne.

ÀLe point d'exclamation se trouvant dans un triangle équilatéral destiné à alerter l'utilisateur de la présence de consignes de maintenance (entretien) et d'utilisation importantes dans la documentation accompagnant le produit. AVERTISSEMENT Pour réduire le risque d'incendie ou d'électrocution n'exposez pas cet appareil à la pluie ou à l'humidité

LEGAL NOTICE

Manufactured under license from Dolby Laboratories. Dolby and the double-D symbol are registered trademarks of Dolby Laboratories.

INTRODUCTION

Welcome to Episode®

Episode® is one of the most highly regarded brands of speakers available today. We appreciate your business and we stand committed to providing our customers with the highest degree of quality and service in the industry.

Episode® subwoofers are a superb choice for bass reinforcement of most audio systems. They have been designed with advanced technology components that accurately reproduce low frequencies in all types of music and movies. For optimum system performance, we recommend pairing them with our acclaimed Episode® loudspeakers.

Features

World Class Digital Amplifier Technology

These powered subwoofers incorporate the latest digital amplifier technology to maximize performance while generating little heat. In standby mode, the subwoofer consumes less than 0.5 watts, making it one of the “greenest” solutions available.

Slot Port

The aerodynamic port design minimizes turbulence and allows for continuous air flow, which improves efficiency, maximizes output, and reduces distortion.

Tuned System Performance

Offers rear-mounted volume control, low-pass crossover adjustment, and continuously variable (0-180 degrees) phase control to ensure optimal system integration, giving a seamless blend for an unbelievable music and movie experience.

Signal-Sensing For Automatic Power Control

There are two power mode options with an Episode® powered subwoofer: Always On and Auto Sense. When Auto Sense is selected, the subwoofer will automatically switch to a power-saving standby mode until an input signal is detected. Power will turn on whenever a minimal amount of signal is detected on the input jacks, and off again when no signal is present for approximately 15 minutes.

Gold-Plated Inputs

Episode® only uses the highest quality inputs available to maximize performance. Stereo inputs are included for easy connections. For home theater use, the left RCA unbalanced input also serves as an LFE (Low Frequency Effects) input for a direct connection from the receiver or processor. For added versatility, there are also gold-plated, five-way binding-post speaker-level inputs and outputs.

USB Ports

A 5V USB port on the subwoofer back panel provides a convenient way for powering a wireless receiver (wireless receiver sold separately).

INSTALLATION AND SETUP

Overview

Proper installation of the Episode® ELE Sub powered subwoofer requires these basic steps:

1. Place the subwoofer in the room. (Page 4)
2. Make connections to the system. (Pages 5 & 6)
3. Fine tune the subwoofer for the best sound quality and operation. (Page 7)

Review the options for each step and use the best method for the application. After installation is complete, test the system thoroughly to ensure reliability and sustained sound quality. If the subwoofer will not function or perform as expected, make sure that installation was completed correctly and check the Troubleshooting Steps before contacting Episode® for assistance.

Placing the Subwoofer

Subwoofer placement can have an effect on the performance that you receive. All rooms are different, but the strongest output will likely occur if the subwoofer is placed in a corner of the room on the same wall as the front channel speakers. This is known as the boundary effect and will emphasize certain bass frequencies while canceling others. Some listeners will find this to be the best sounding result, while others may find it “boomy” or muddy. Experiment with the placement options available to you and use the tuning instructions that follow in the “Installation” section of this manual.

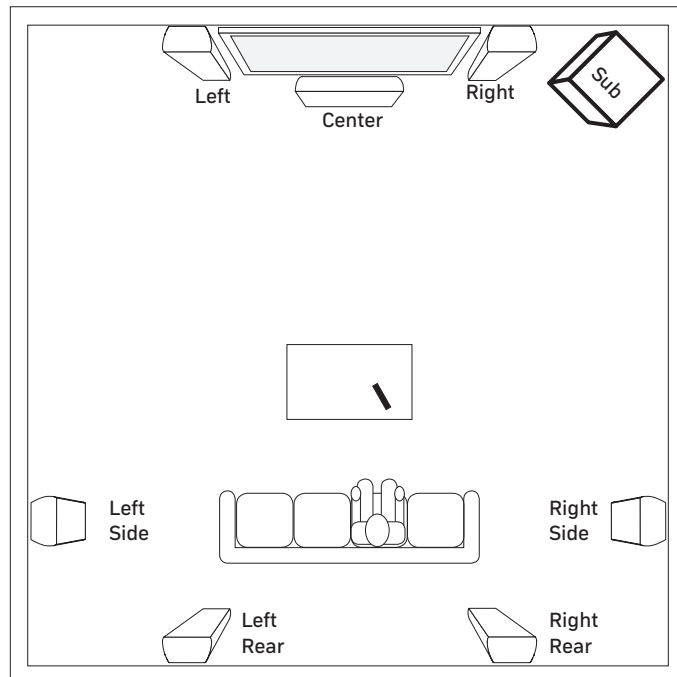

MAKING SYSTEM CONNECTIONS

Wiring Recommendations

For line-level connections, use high-quality, low impedance RCA cables with adequate shielding and high-quality connectors.

Use two-conductor loudspeaker cable for high level connections that is appropriate for the installation environment and wire length.

Audio Connections

To provide signal to the ELE subwoofer, a connection must be made from the audio source or speaker wiring. Most home theater AV receivers and sources supply an "LFE" output for subwoofers that should be used if available. Stereo line or speaker-level inputs from sources or speaker wiring may also be used.

CAUTION! DO NOT connect to both the line and speaker level connections at the same time. Use only line-level connections, or only speaker-level connections.

Line-Level RCA Connections

 **WARNING!** Do not connect to both the low-level RCA and high-level speaker connections. Use only one connection method.

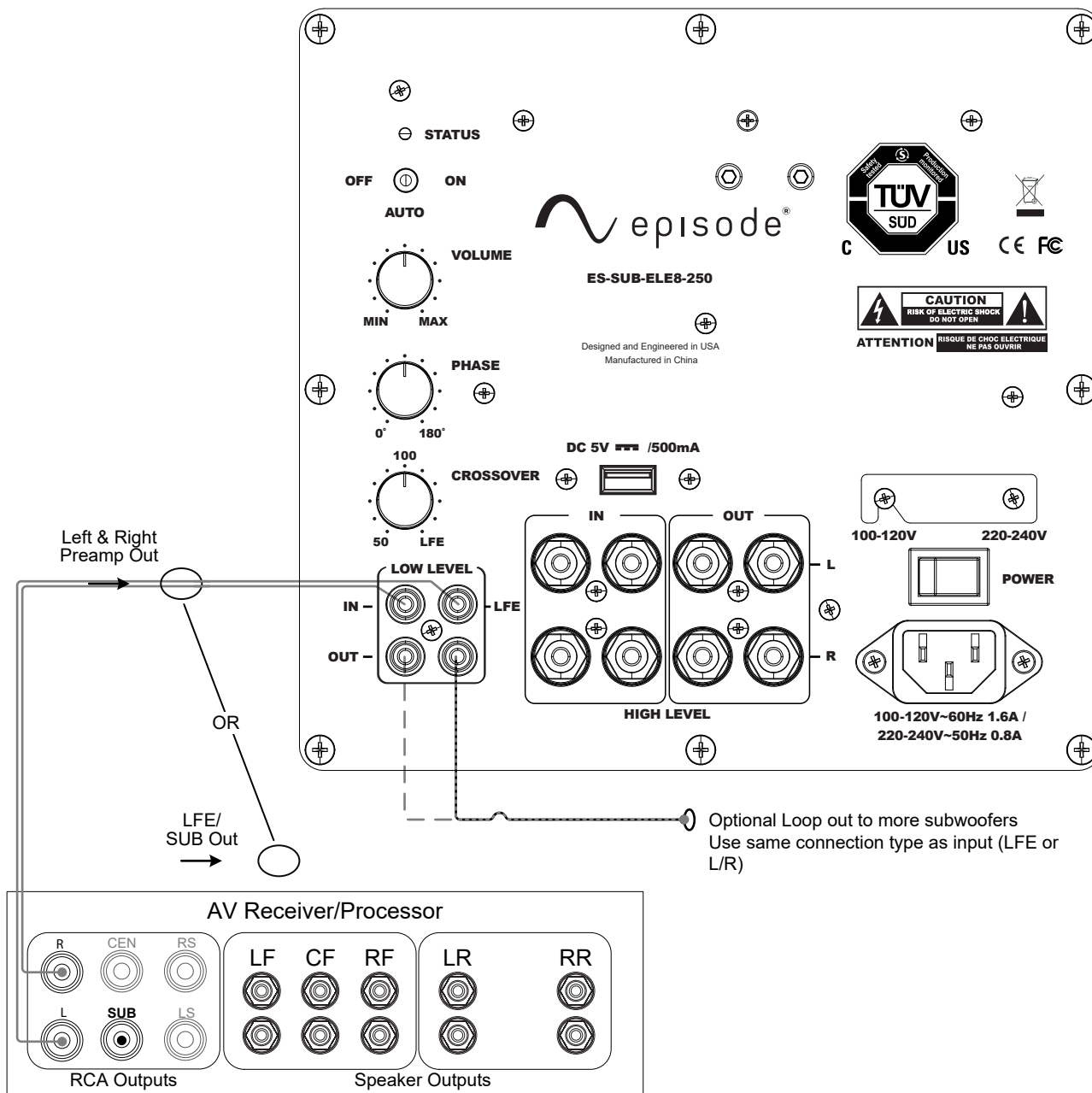

SPEAKER-LEVEL CONNECTIONS

WARNING! Do not connect to both the low-level RCA and high-level speaker connections. Use only one connection method.

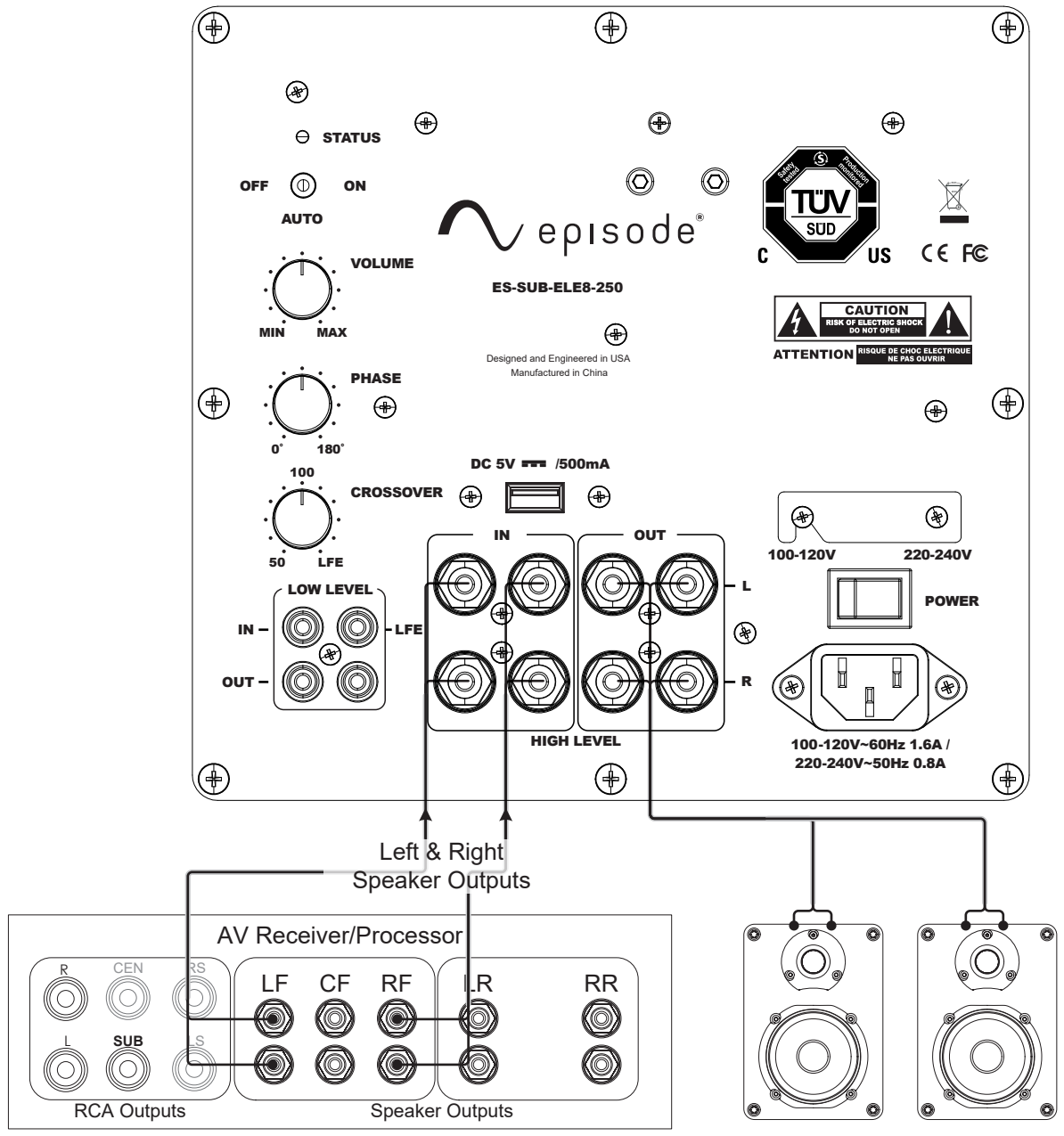

SETTINGS AND CONTROLS

Setting the Power Mode

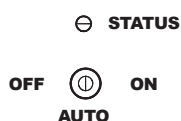

ON Mode

If the subwoofer is set to ON mode, it will always be ready to play. However, undesired noise from interference or connections changing may be heard, and leaving the subwoofer on all the time is not energy efficient. Use the standard ON mode only if needed. Set the power switch to OFF when the amplifier is not in use.

AUTO Mode

Setting the switch to AUTO enables AUTO Sense. The subwoofer turns on and off automatically in response to signal on the inputs. The unit will enter standby mode if no signal is sensed for 15 minutes.

Fine Tuning Audio and Operation

After making all the connections and calibrating the loudspeakers, set up your Episode® subwoofer using the following steps:

1. Set the MODE switch to the 'ON' position for setup.
2. Plug the subwoofer into an electrical outlet using the included power cord. The status LED will illuminate solid blue when power is present and the subwoofer is on.
3. Set the controls and switches to their initial setup positions:
 - VOLUME dial set to 50%, or 12 o'clock
 - CROSSOVER dial: Set to LFE if LFE input is used; Otherwise, set to match the low-end frequency limit of the satellite speakers in use. See specifications for the speakers installed to determine their low-end limit.
 - PHASE set to 0°
4. Play a movie scene or music track and set the system volume to an average level. Listen to the bass level from your favorite listening position. Adjust the VOLUME control as desired.
5. Continue listening to your favorite music and movie sources using the settings chosen for volume and crossover. Experiment with the PHASE setting until you find the best setting for the installation. Depending on your subwoofer's placement, the bass may sound louder or deeper when the phase has been optimized. In some cases, adjusting phase will make no audible difference.
6. Once calibration is complete, switch the power mode back to 'AUTO' if Auto Sense mode is being used. Wait 15-20 minutes to confirm that AUTO mode is working properly. See Troubleshooting if issues occur.
7. Setup is now complete.

TROUBLESHOOTING

Episode® speakers are designed to function trouble-free. Most problems that occur are due to simple issues. If you have trouble, please check the list of simple fixes below.

If the problem persists, contact Episode® Technical Support at 1.866.838.5052.

Note: During troubleshooting, temporarily set the MODE switch to 'ON' to ensure signal-sensing power mode is disabled. Ensure that the Status LED is blue with the switch on.

No Sound

- If power mode switch is set to On and LED is Red, call Technical Support.
- Verify that audio is coming from the source selected. Select another source to test, or connect the source directly to the subwoofer input, bypassing any other equipment.
- Ensure that any connected A/V equipment is turned on and connected properly.
- Check cable connections for damage, poor contact, or short circuits.
- Ensure the subwoofer volume is turned up to a reasonable level. The control is located on the back of the unit.

Interference

If undesired noise is heard coming from the subwoofer:

Check cable connections for damage, poor contact, or short circuits.

If the issue only occurs when the system is off, check the power mode switch to be sure the subwoofer is set to off, or if using AUTO mode, check that the subwoofer is actually turning off after 15 minutes of inactivity (LED will be Red). If the LED is Blue, the sources may be outputting signal at all times, causing the subwoofer to remain on.

If the signal cable is installed in the wall, it may be running parallel to high voltage cables. Test the system by running a separate in-room cable. If the issue is resolved, a new cable should be installed with proper clearance from high voltage.

If the interference occurs when using the Episode® ES-SUB-WIRELESS, bypass the adapter and test with a cable.

Common sources of interference include Wi-Fi antennas and devices or cordless phones set up too close to the subwoofer or source.

CLEANING AND MAINTENANCE

- The exterior of the Element subwoofer may be cleaned using a cloth. Use a vacuum cleaner dust brush attachment or lint brush to clean the grille.
- If the subwoofer enclosure is moved often for cleaning or relocation, check each time to ensure that connections are not damaged or loose.

REFERENCE

CONNECTIONS AND CONTROLS

ES-SUB-ELE8-250

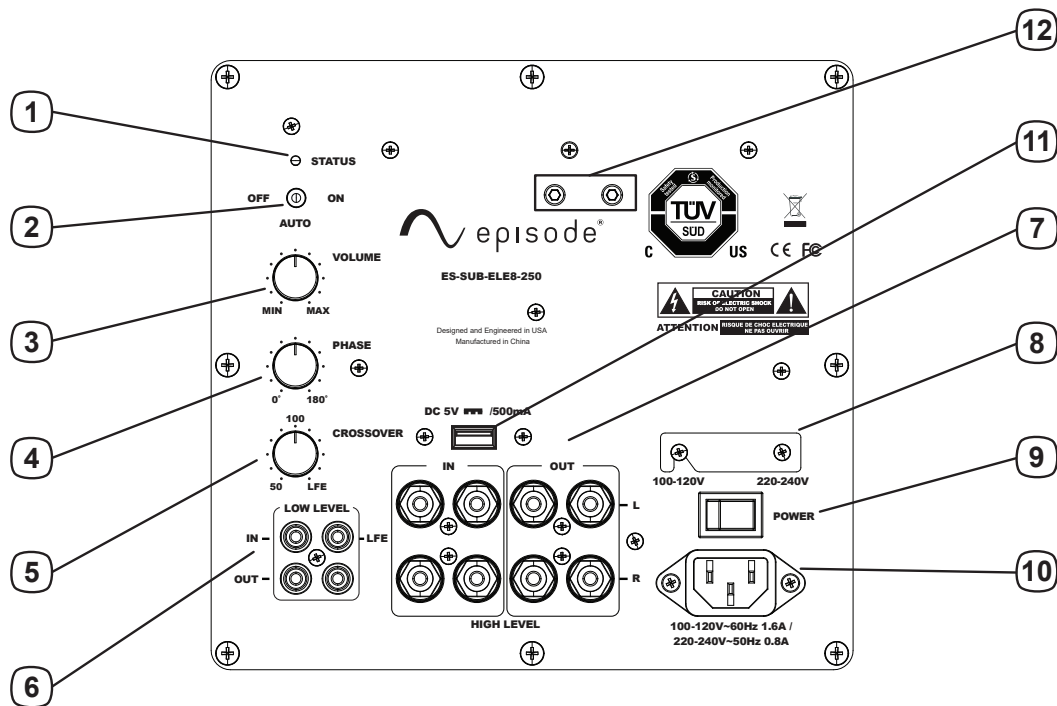

- 1. Status Led**
 Red- Subwoofer is in standby mode, or power mode switch is set to OFF. AC power is present.
 Blue- Subwoofer power mode switch is set to ON, or is set to AUTO and signal is being received.
- 2. Power Mode Switch**
 3 way toggle switch for setting power mode to OFF, AUTO, or ON.
- 3. Volume Knob**
 Adjust subwoofer volume.
- 4. Phase Knob**
 Set the phase of the subwoofer in relation to the listening area. Continuously variable from 0 to 180°.
- 5. Crossover Knob**
 Adjust the crossover frequency (limits the highest frequency the subwoofer will play).
Note: Set the crossover knob to "LFE" if the LFE input is used.
- 6. LOW LEVEL Inputs & Outputs (RCA)**
 For left/right or LFE connections from audio source, and outputs for connecting other equipment. To connect LFE, use the L (left) channel connections.
- 7. HIGH LEVEL Inputs & Outputs (Speaker Wire Binding Post)**
 Connect left/right connections from speaker cable runs, and loop to other speakers.
- 8. Voltage Selector Switch**
 Select the input voltage. Default: 100-120V.
- 9. Master Power Switch**
 Rocker switch to turn power off to the subwoofer. Power LED will be off if switch is off but power is present.
- 10. Power Cord Inlet**
 Connect the included cord for providing power.
- 11. USB Port**
 A 5V USB port on the subwoofer back panel provides a power source for an Episode Wireless receiver.
Note: Successful operation is not guaranteed with devices other than the Episode Wireless Kit. (Wireless Kit sold separately).
- 12. Wireless Receiver Holding Bolts**
 Secure the Wireless receiver to the subwoofer.

ES-SUB-ELE10-450 & ES-SUB-ELE12-700*

*ES-SUB-ELE12-700 pictured

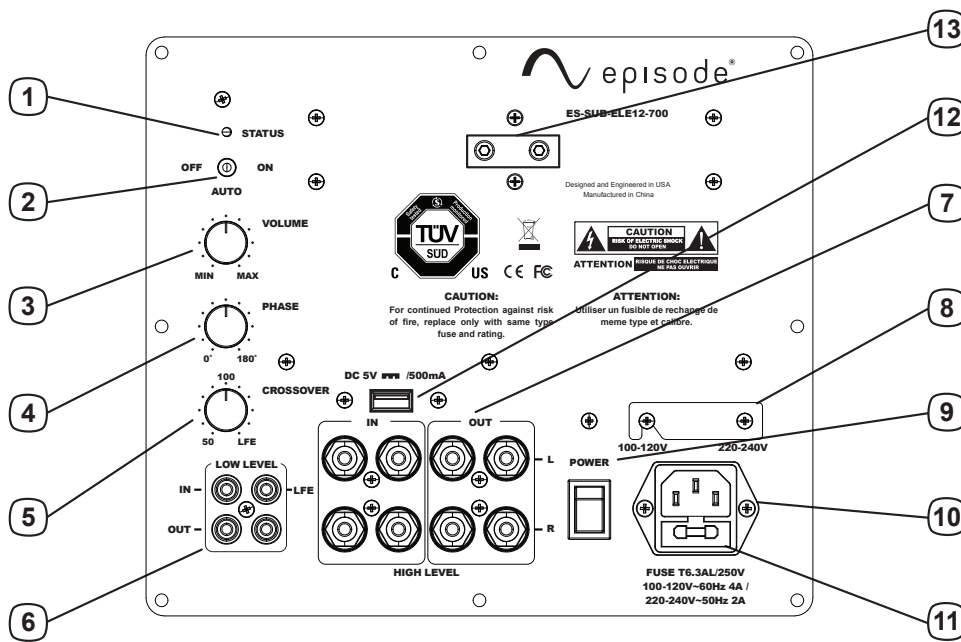

1. STATUS LED

Red- Subwoofer is in standby mode, or power mode switch is set to OFF. AC power is present.
Blue- Subwoofer power mode switch is set to ON, or is set to AUTO and signal is being received.

2. Power Mode Switch

3 way toggle switch for setting power mode to OFF, AUTO, or ON.

3. Volume Knob

Adjust subwoofer volume.

4. Phase Knob

Set the phase of the subwoofer in relation to the listening area. Continuously variable from 0 to 180°.

5. Crossover Knob

Adjust the crossover frequency (limits the highest frequency the subwoofer will play).

Note: Set the crossover knob to "LFE" if the LFE input is used.

6. LOW LEVEL Inputs & Outputs (RCA)

For left/right or LFE connections from audio source, and outputs for connecting other equipment. To connect LFE, use the L (left) channel connections.

7. HIGH LEVEL Inputs & Outputs (Speaker Wire Binding Post)

Connect left/right connections from speaker cable runs, and loop to other speakers.

8. Voltage Selector Switch

Select the input voltage. Default: 100-120V.

9. Master Power Switch

Rocker switch to turn power off to the subwoofer. Power LED will be off if switch is off but power is present.

10. Power Cord Inlet

Connect the included cord for providing power.

11. Fuse Holder (ES-SUB-ELE-10 and 12 Only)

Master Power fuse. See Specifications for the correct size and rating for the model in use. Includes spare fuse inside holder.

Note: ES-SUB-ELE10 Uses FUSE T4AL/250V 100-120V-60Hz 2.5A/220-240V-50Hz 1.25A.

12. USB Port

A 5V USB port on the subwoofer back panel provides a power source for an Episode Wireless receiver.

Note: Successful operation is not guaranteed with devices other than the Episode Wireless Kit. (Wireless Kit sold separately.)

13. Wireless Receiver Holding Bolts

Secure the Wireless receiver to the subwoofer.

SPECIFICATIONS

Description	Element 8" Matte Black (ES-SUB-ELE8-250)	Element Sub 10" Matte Black (ES-SUB-ELE10-450)	Element Sub 12" Matte Black (ES-SUB-ELE12-700)
Woofer:	8" Injection Molded PP/Mica Cone, High Temp 1.5" Voice Coil	10" Injection Molded PP/Mica Cone, High Temp 1.5" Voice Coil	12" Injection Molded PP/Mica Cone, High Temp 2" Voice Coil
Color:	Matte Black	Matte Black	Matte Black
Power:	110W RMS	200W RMS	300W RMS
Frequency Response (@ -3dB):	28 Hz	25 Hz	22 Hz
Crossover Control:	50 to 200 Hz		
Dimensions:	12" x 14.5" x 12.6" (W x H x D)	14.2" x 17" x 15.5" (W x H x D)	16" x 18.8" x 16.8" (W x H x D)
Connectors:	RCA Inputs, Gold Plated 5-Way Binding Posts, USB		
Adjustments:	Volume, Crossover Frequency, Phase Control, Auto On/Off		
Weight:	25.3 lbs	37.8 lbs	48.5 lbs
Replaceable Fuse:	NA	T4AL/250V	T6.3AL/250V
AC Input Voltage:	100-240V AC (Switchable 100-120 or 220-240V AC)		
Power Consumption:	100-120V AC 60Hz: 1.6A 220-240V AC 50Hz: 0.8A	100-120V AC 60Hz: 2.5A 220-240V AC 50Hz: 1.25A	100-120V AC 60Hz: 4A 220-240V AC 50Hz: 2A
Optional Accessories:	ES-SUB-WIRELESS, Cables	ES-SUB-WIRELESS, Cables	ES-SUB-WIRELESS, Cables

10/2-YEAR LIMITED WARRANTY

Episode® Subwoofers have a 2-Year Warranty on the amplifier and a 10-Year Warranty on the woofer and box. This warranty includes parts and labor repairs on all components found to be defective in material or workmanship under normal conditions of use. This warranty shall not apply to products which have been abused, modified or disassembled. Products to be repaired under this warranty must be returned to SnapAV or a designated service center with prior notification and an assigned return authorization number (RA).

CONTACTING TECHNICAL SUPPORT

Phone: 866.838.5052

Email: Techsupport@snapav.com



© 2018 Episode®
Rev: 180525-1020