

Quick Start Guide

I-200 Series Industrial 10G PoE++ Media Converter

Unpack the Device and Check Contents

Part Number	RJ-45 Ports	PoE Ports	SFP Ports
MI20010	1	1	1

 DIN-Rail Mounting Kit - one bracket and two screws.

 Wall Mounting Kit - two brackets and four screws

 Documentation—Quick Start Guide (this document) and Warranty Card

Note: Additional documentation can be obtained from www.signamax.com

Warnings and Cautionary Messages

 **Warning:** This product does not contain any serviceable user parts.

Warning: Installation and removal of the unit must be carried out by qualified personnel only.

Warning: When connecting this device to a power outlet, connect the field ground lead on the tri-pole power plug to a valid earth ground line to prevent electrical hazards.

Warning: This switch uses lasers to transmit signals over fiber optic cable. The lasers are compliant with the requirements of a Class 1 Laser Product and are inherently eye safe in normal operation. However, you should never look directly at a transmit port when it is powered on.

Warning: When selecting a fiber SFP device, considering safety, please make sure that it can function at a temperature that is not less than the recommended maximum operational temperature of the product. You must also use an approved Laser Class 1 SFP transceiver.

 **Caution:** Wear an anti-static wrist strap or take other suitable measures to prevent electrostatic discharge when handling this equipment.

Caution: Do not plug a phone jack connector in the RJ-45 port. This may damage this device.

Caution: Use only twisted-pair cables with RJ-45 connectors that conform to FCC standards.

Mount the Media Converter

DIN-Rail Mount

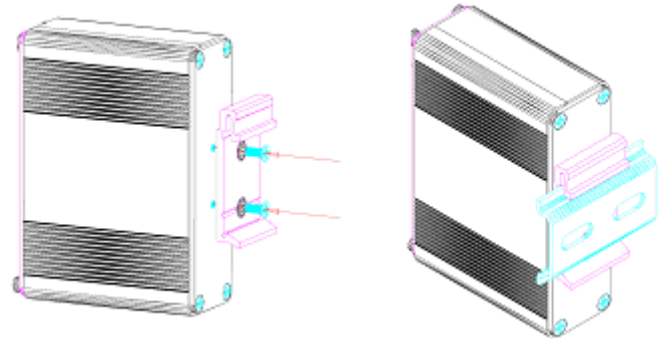

1. Screw the DIN-Rail bracket to the Media Converter
2. Insert the top of the DIN-Rail bracket to the DIN-Rail track.
3. Pull down the DIN-Rail bracket to the DIN-Rail track and check if it is mounted tightly on the DIN-Rail track.

Wall Mount

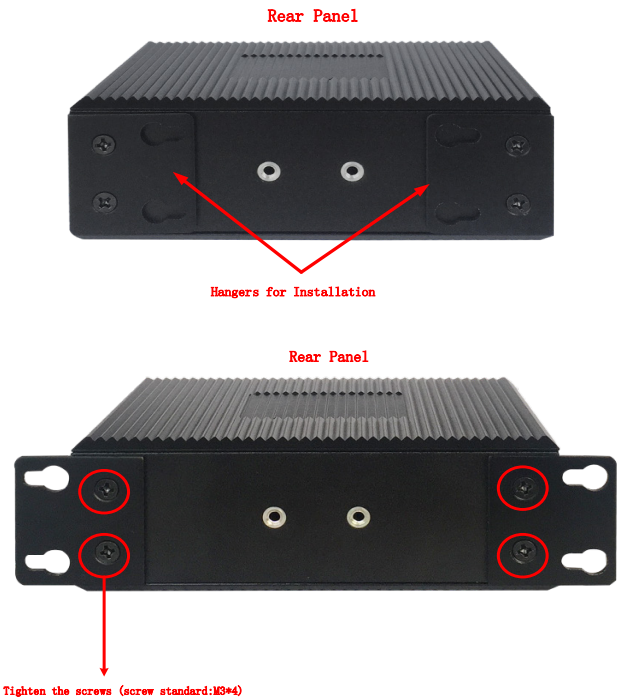

1. Remove the four mounting screws on the rear panel
2. Turn around the 2 brackets and reinsert the the four mounting screws

Quick Start Guide

I-200 Series Industrial 10G PoE++ Media Converter

Ground the Media Converter

1. This equipment must be grounded. Never defeat the ground conductor or operate the equipment in the absence of a suitably installed ground conductor. Contact the appropriate electrical inspection authority or an electrician if you are uncertain that suitable grounding is available.
2. Attach a lug (not provided) to a #12 AWG minimum grounding wire (not provided), and connect it to the grounding point on the rear panel. Then connect the other end of the wire to ground.



Caution: The earth connection must not be removed unless all supply connections have been disconnected.

Note: The device must be installed in a restricted access location. It should have a separate protective earthing terminal on the chassis that must be permanently connected to earth to adequately ground the chassis and protect the operator from electrical hazards.

Connect Power

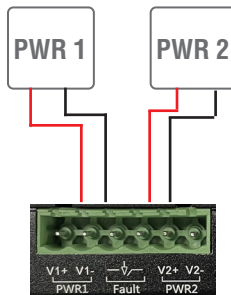

1. Insert the positive and negative wires into the PWR1 (+,-) and/or PWR2 (+,-) on the terminal block connector (only one power supply is required).
2. Tighten the screws to prevent the wires from loosening.
3. Only one power supply is required for operation of the switch. Dual power sources are for redundancy. The Fault LED will light on if only one power supply is connected.
4. The Media Converter supports 802.3bt Type 4 with maximum power consumption of 95W. Make sure the power supply is able to provide sufficient power for the PoE requirement.

Verify Media Converter Operations

1. Verify basic Media Converter operation by checking the system LEDs. When operating normally, the Power LED should be on and green.

Connect Network Cables

1. For RJ-45 ports, connect 100-ohm Category 5, 5e or better twisted-pair cable. Cat6A is required for 10GBase-T up to 100m while Cat5e or Cat6 may reach up to 55m. Cat6 or better is required for 5GBase-T and Cat5e for 2.5GBase-T.
2. For the SFP slots, first install SFP transceivers and then connect fiber optic cabling to the transceiver ports. The following transceivers are supported:
 - 10GBASE-SR (AS510020)
 - 10GBASE-LR (AS510030)
 - 10GBASET (AS50010)
3. As connections are made, check the port status LEDs to be sure the links are valid. See the LED description table below.

LED Description Table

LED	Status	Description
P1	ON	DC Power is connected to PWR1
	OFF	No DC power is connected to PWR1
P2	ON	DC Power is connected to PWR2
	OFF	No DC power is connected to PWR2
Fault	ON	Only 1 power supply is connected
	OFF	Both PWR1 and PWR2 are connected
LINK	ON	Port has a valid link
	BLINKING	Port has network activity
	OFF	The link is down
PoE	ON	A PoE device is connected and delivered PoE power
	OFF	Doesn't deliver PoE power