

AL168 Series

Multi-Output Power Supplies

Models Include:

AL168CB

- 16VAC @ 6A (100VA) or 18VAC @ 5.5A (100VA).
- Eight (8) PTC protected outputs.

AL168175CB

- 16VAC @ 10A (175VA).
- Eight (8) PTC protected outputs.

AL168300CB

- 16VAC @ 18A (350VA) or 18VAC @ 16A (350VA).
- Eight (8) PTC protected outputs.

AL168300CBM

- 16VAC @ 18A (350VA) or 18VAC @ 16A (350VA).
- Eight (8) PTC protected outputs.

AL168600CB

- 16VAC @ 40A (700VA) or 18VAC @ 36A (700VA).
- Eight (8) PTC protected outputs.

Installation Guide



Rev. 070109



More than just power.™

Installing Company: _____ Service Rep. Name: _____

Address: _____ Phone #: _____

Overview:

Altronix AL168CB Series Multi-Output Power Supplies provide 16VAC/18VAC distributed via eight (8) auto-resettable PTC protected outputs for powering multiple security system or access control panels.

Eight (8) Output AL168 Reference Chart:

Altronix Model Number	Output Voltage	Total Output Current (A)	Number of PTC Protected Outputs	Output Current (max per output)	Main Fuse Ratings on Board	115VAC 50/60Hz Input Current		
AL168CB	16VAC	6A	8	2.5A	10A/250V	0.9A		
	18VAC	5.5A			15A/250V	1.45A		
AL168175CB	16VAC	10A			2.5A	15A/32V	2.7A	
	16VAC	18A						
AL168300CB	18VAC	16A				16VAC		18A
	16VAC	18A						
AL168300CBM	18VAC	16A		6A		Two (2) 15A/32V		5.4A
	16VAC	40A						
AL168600CB	18VAC	36A						

Specifications:

Input:

- 115VAC, 50/60Hz.

Output:

- Eight (8) PTC protected outputs.
- 16VAC or 18VAC supply current.
- Outputs are rated @ 2.5A.
- Surge suppression.

Features:

- AC power LED indicator.
- Illuminated power disconnect circuit breaker with manual reset (except AL168CB).
- Unit maintains camera synchronization.
- Ease of installation saves time and eliminates costly labor.

Enclosure Dimensions:

AL168CB and AL168175CB:

8.5" x 7.5" x 3.5" (215.9mm x 190.5mm x 88.9mm)

AL168300CBM:

8.5" x 7.5" x 3.875" (215.9mm x 191mm x 98.4mm)

AL168300CB and AL168600CB:

13.5" x 13" x 3.25" (342.9mm x 330.2mm x 82.6mm)

Installation Instructions:

1. Mount unit in the desired location. Mark and predrill holes in the wall to line up with the top two keyholes in the enclosure. Install two upper fasteners and screws in the wall with the screw heads protruding. Place the enclosure's upper keyholes over the two upper screws, level and secure. Mark the position of the lower two holes. Remove the enclosure. Drill the lower holes and install the three fasteners. Place the enclosure's upper keyholes over the two upper screws. Install the two lower screws and make sure to tighten all screws (*Enclosure Dimensions, pgs. 10-12*). Secure enclosure to earth ground.
2. Turn OFF main switch (except AL168CB) (*Figs. 2-5, pgs. 5-8*).
3. All units are factory set for 16VAC operation.
For 18VAC operation adjust unit prior to mounting and applying power as follows:
Change the wire position so that the black wire [18V] is connected to the terminal marked [P] and the yellow wire [16V] is connected to the terminal marked [S].
4. Connect AC power to the black and white flying leads of the transformer(s) (*Figs. 1-5, pgs. 4-8*).
Use 18 AWG or larger for all power connections.
5. Measure output voltage before connecting devices. This helps avoiding potential damage.
Terminals marked [1P] - [8P] are positive of the same polarity.

CAUTION: Determine the maximum operating voltage of the equipment being powered before adjusting the output voltage.

6. Connect devices to terminals marked [1P] - [1N] through [4P] - [4N] on PD4CB board (Figs. 3, 5, pgs. 6, 8) or terminals marked [1P] - [1N] through [8P] - [8N] on PD8CB board (Figs. 1, 2, and 4, pgs. 4-5, 7), carefully observing polarity.
7. Turn main switch to the "RESET" (ON) position (except AL168CB) (Figs. 2-5, pgs. 5-8).
8. Green LED will illuminate when unit is powered.
9. Upon completion of the wiring secure enclosure door with screws (supplied).

Caution: Equipment to be installed/serviced by authorized/trained personnel only. Shut branch circuit power before installing/servicing equipment.

WARNING: To reduce the risk of fire or electric shock, do not expose the unit to rain or moisture. This installation should be made by qualified service personnel and should conform to the National Electrical Code and all local codes.

Terminal Identification:

PD4CB/PD8CB - Distribution Module

1P - 4P	AC output.
1N - 4N	AC output.

LED Diagnostics:

PD4CB/PD8CB - Power Distribution Module

Green (AC)	Power Distribution Module Status
ON	Normal operating condition.
OFF	No Power Output.



The lightning flash with arrowhead symbol within an equilateral triangle is intended to alert the user to the presence of an insulated DANGEROUS VOLTAGE within the product's enclosure that may be of sufficient magnitude to constitute an electric shock.



The exclamation point within an equilateral triangle is intended to alert the user to the presence of important operating and maintenance (servicing) instructions in the literature accompanying the appliance.



CAUTION
RISK OF ELECTRIC SHOCK
DO NOT OPEN



CAUTION: To reduce the risk of electric shock do not open enclosure. There are no user serviceable parts inside. Refer servicing to qualified service personnel.

Fig. 1 - AL168CB

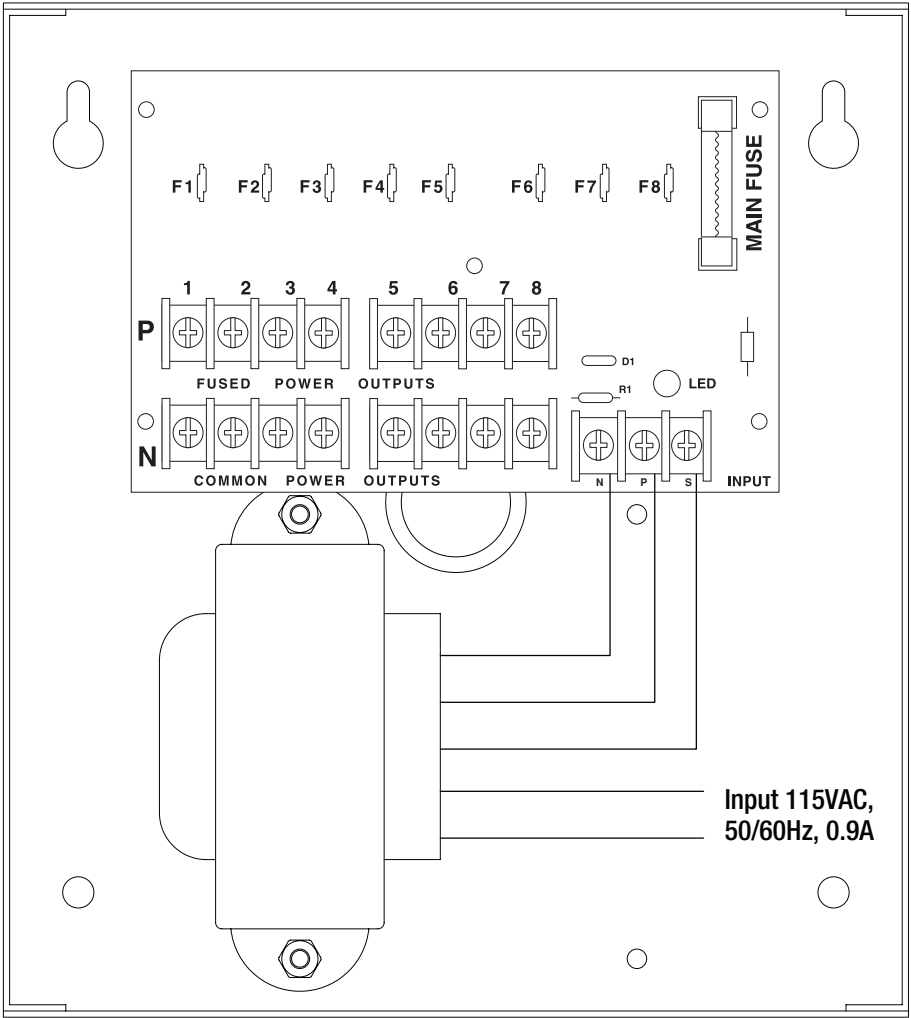

Voltage Selection Configuration

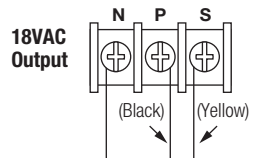
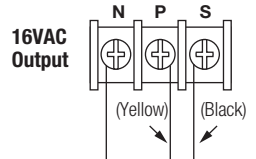

Fig. 2 - AL168175CB

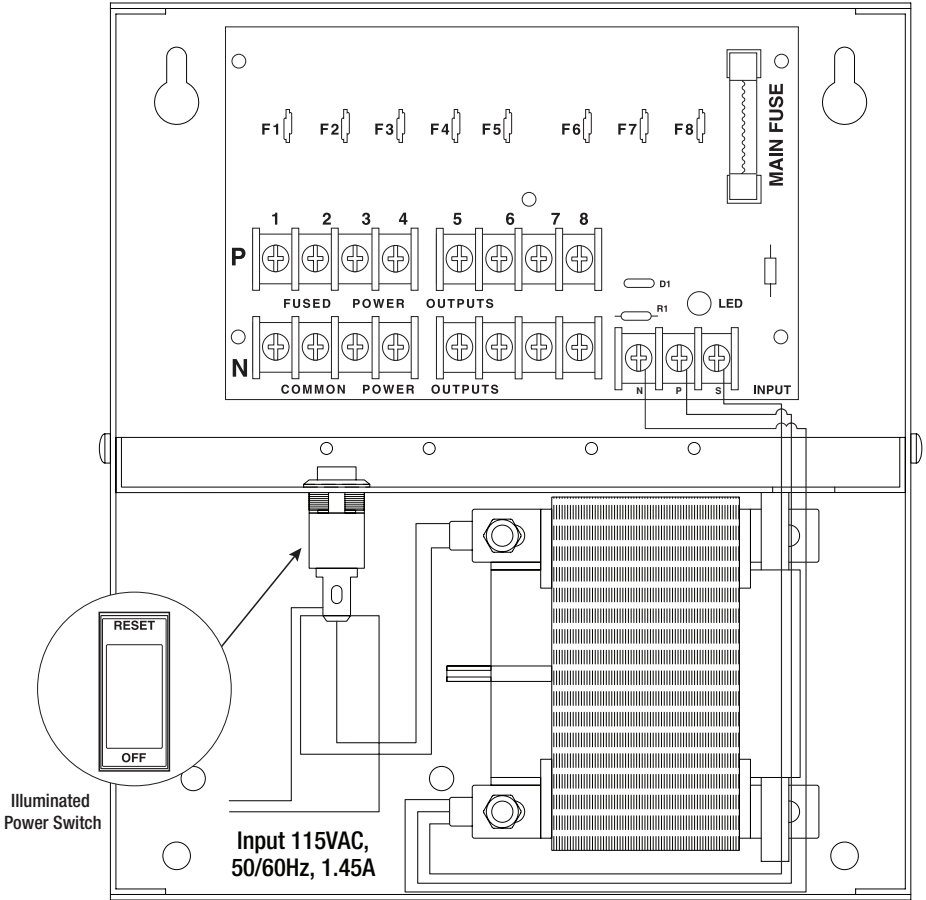
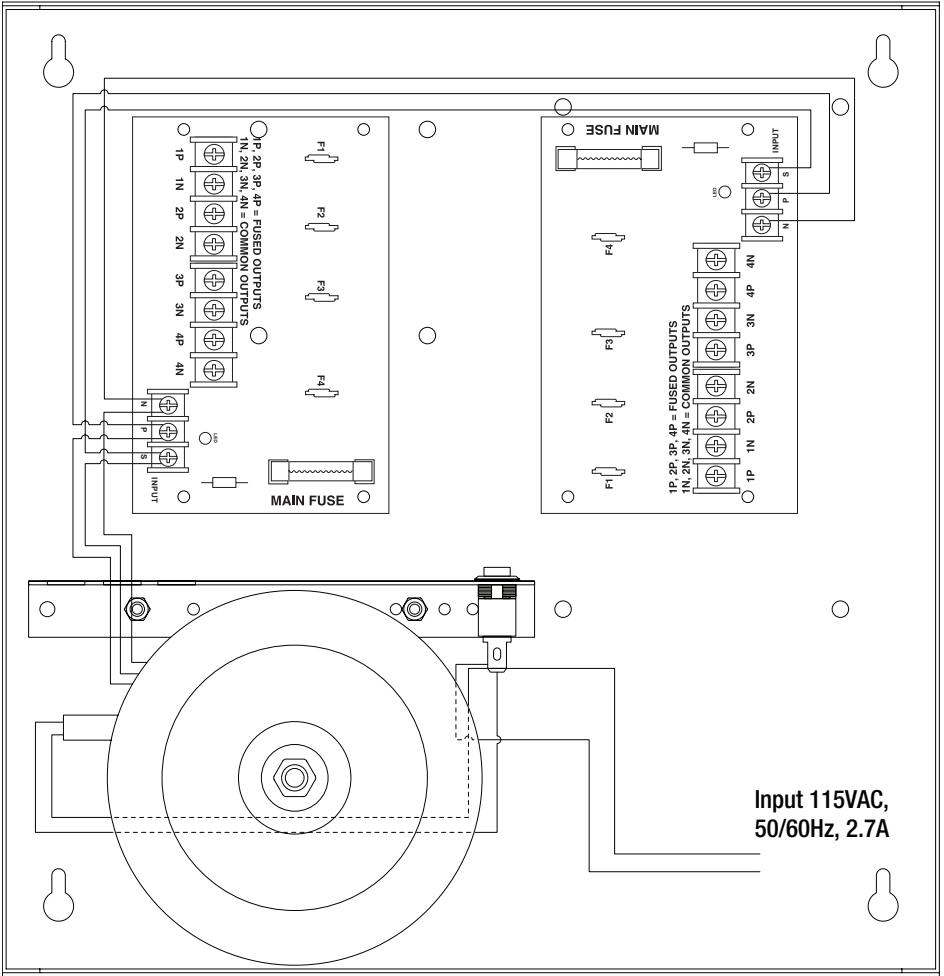

Fig. 3 - AL168300CB



Input 115VAC,
50/60Hz, 2.7A

Voltage Selection Configuration

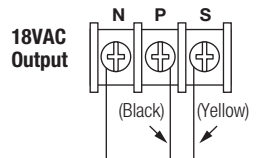
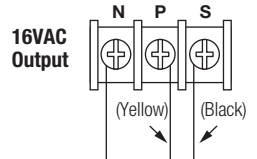
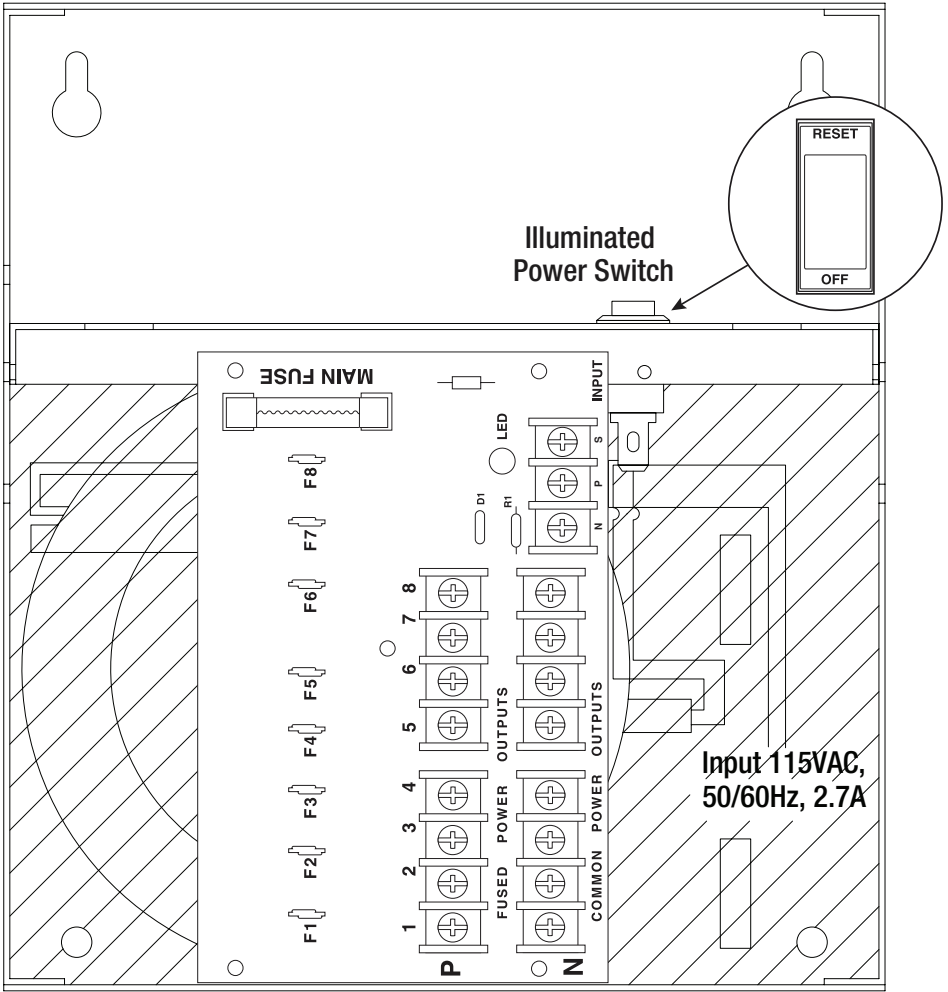

Fig. 4 - AL168300CBM



Voltage Selection Configuration

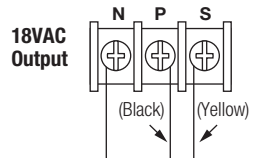
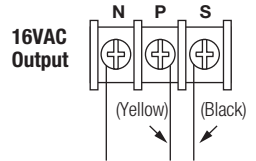
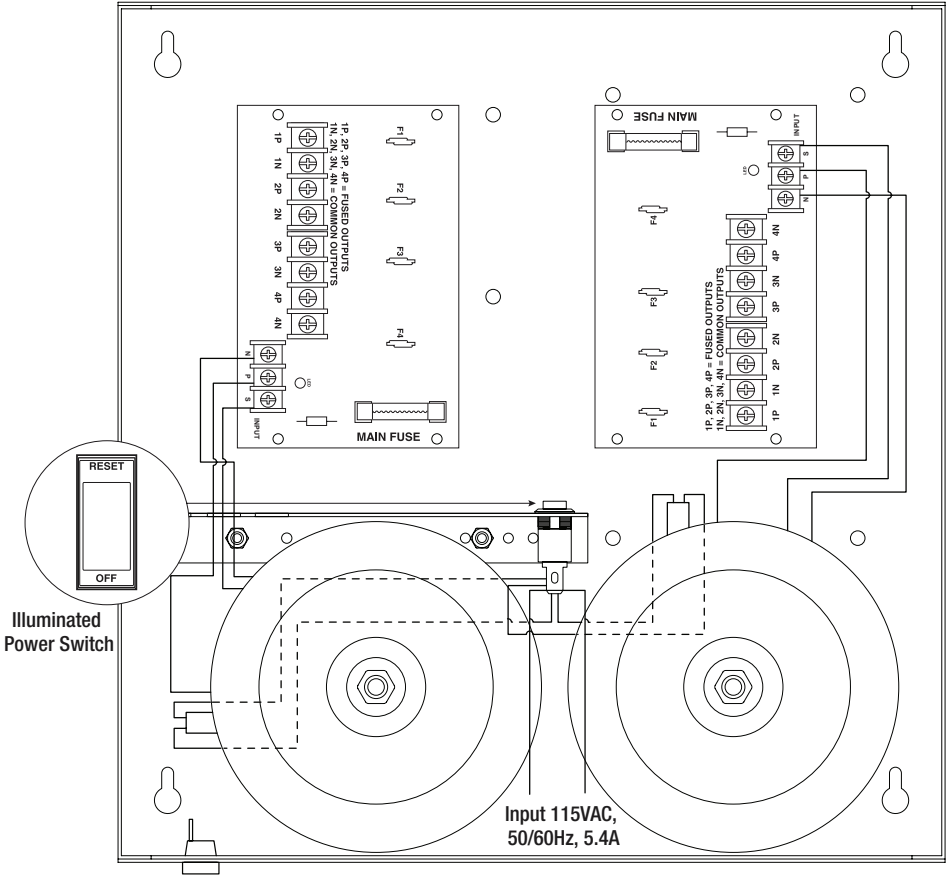
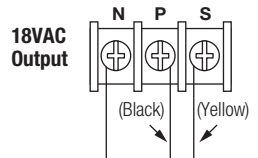
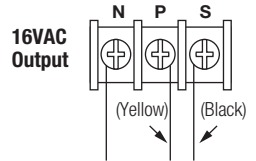

Fig. 5 - AL168600CB



Voltage Selection Configuration



Notes:

Enclosure Dimensions (H x W x D) for AL168CB and AL168175CB

8.5" x 7.5" x 3.5" (215.9mm x 190.5mm x 88.9mm)

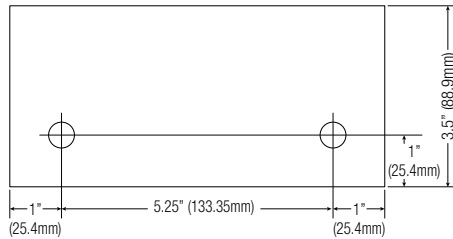
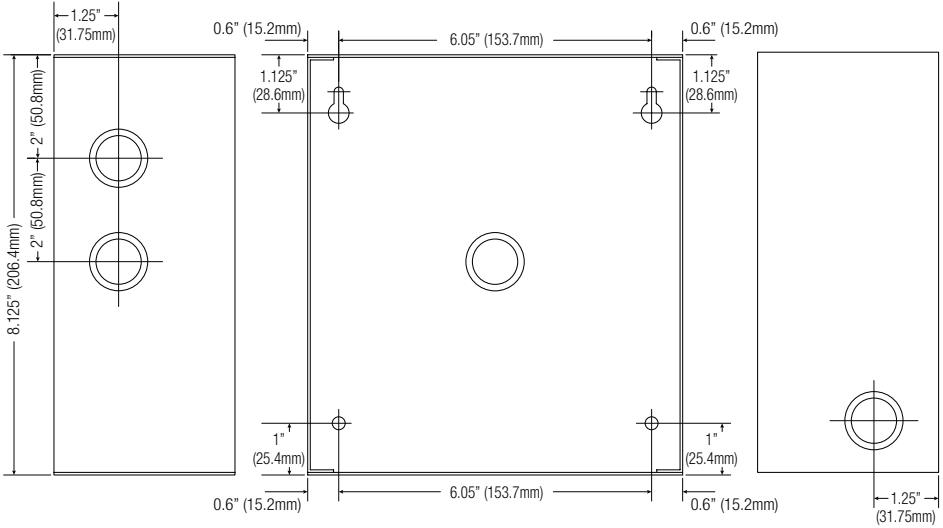
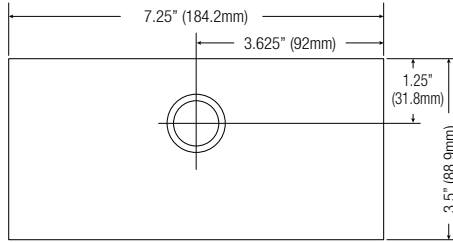

Enclosure Dimensions (H x W x D) for AL168300CBM

8.5" x 7.5" x 3.875" (215.9mm x 191mm x 98.4mm)

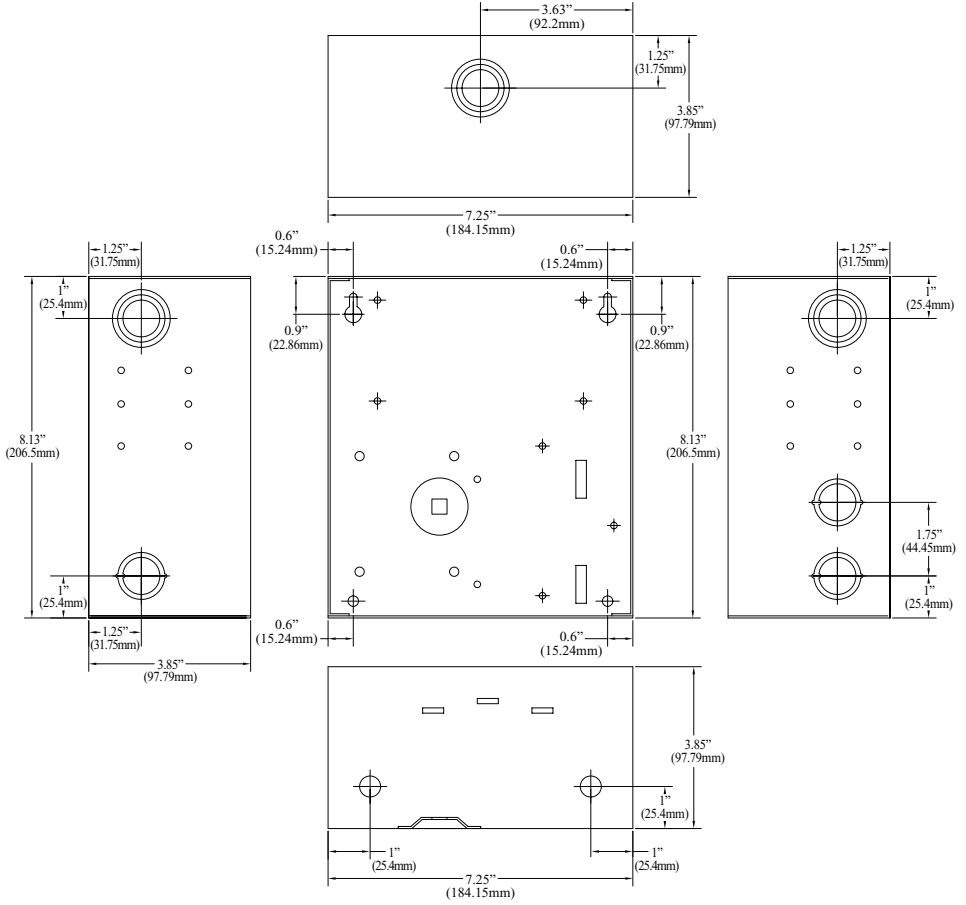

Enclosure Dimensions (H x W x D) for AL168300CB and AL168600CB:

13.5" x 13" x 3.25" (342.9mm x 330.2mm x 82.6mm)

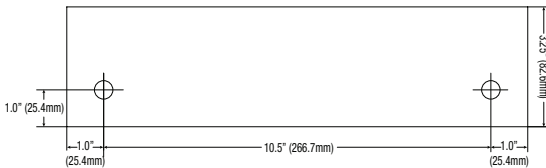
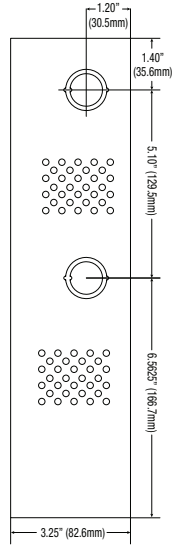
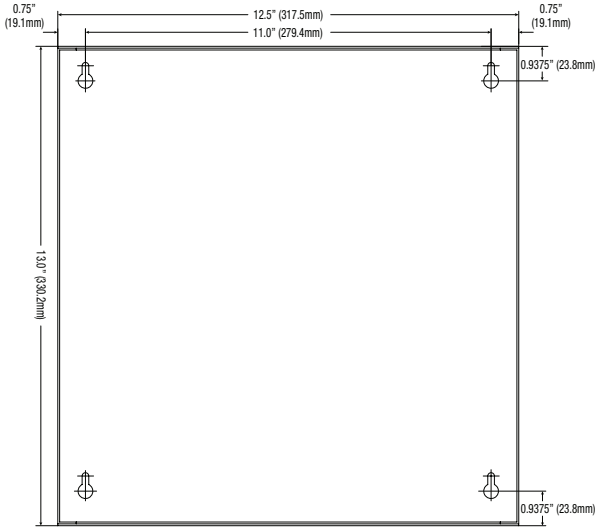
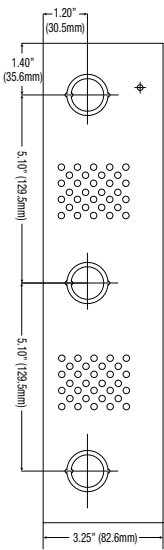
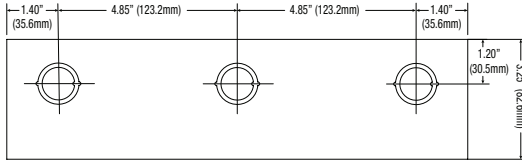

Altronix is not responsible for any typographical errors.

140 58th Street, Brooklyn, New York 11220 USA | phone: 718-567-8181 | fax: 718-567-9056
 website: www.altronix.com | e-mail: info@altronix.com | Lifetime Warranty
 IAL168CB Series E19U

