



Middle Atlantic Products

EXCEPTIONAL SUPPORT & PROTECTION™

MK Series Racks



SEISMIC CERTIFIED

EIA/TIA Compliant

The MK Series 19" Cable Management Racks Optimized for high-density patching applications

Features

- Innovative design incorporates captive fasteners (no loose bolts) which provide for quick assembly times & uncommon strength
- 800 lb. or 500 lb. weight capacity, depending on mounting method,
- 500 lbs. seismic certified load capacity on MK-1945-24 only
- 24" width for use with raised flooring tiles
- Oversized cable ducts for high density patching applications
- Unique swiveling front mount steel cable rings with position indexing
- Hook and loop cable fastening straps & front cable feed-through hole plugs included
- Abundant cable tie points accommodate hook and loop fastening straps and nylon wire ties
- Integral top cable tray front & rear
- Includes 100 qty. 10-32 rack screws
- Durable black powder coat finish

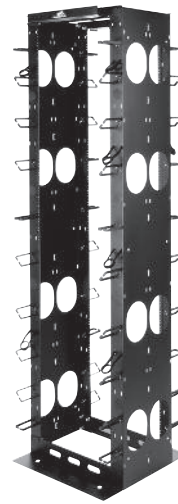

MK-1945-24

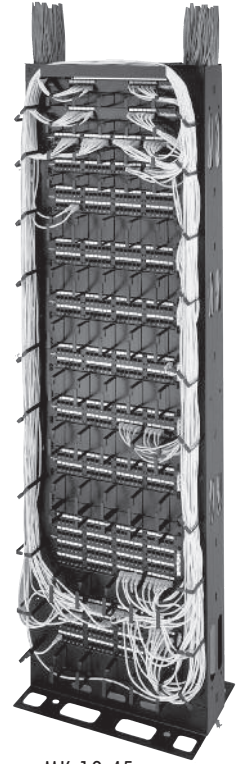

MK-19-45

SEISMIC CERTIFIED

Architects' and Engineers' Specifications

EIA compliant 19" cable management rack shall be Middle Atlantic Products model #MK-1945 / MK-1945-24. Overall dimensions of cable management rack shall be 84.28" H x 23.96" W x (16.44", 24.00") D, depth of rail channels shall be (6.44", 14.00"), depth at top including integrated cable tray shall be (12.44", 19.88"). Useable height shall be 45 rackspace. Weight capacity shall be 500 lbs., when properly loaded with the base securely anchored, and 800 lbs., when properly loaded with the base of the rack securely anchored and the top of the rack braced to a structural building component (Note: Installation of cable management racks can vary widely with all types of conditions. Please note that mounting equipment in cantilever fashion, which effectively changes the center of gravity of the rack, will lessen the overall ability of the rack to bear weight). MK shall come equipped with multi-position cable management rings in twenty places, multiple cable pass-through openings on front and sides of rack, and integrated cable trough at top of rack. Multiple raised cable lacing points for cable management shall be provided. MK-1945-24 Series enclosures shall satisfy the 2007 & 2010 CBC; 2006, 2009 & 2012 IBC; ASCE 7-05 (2005 Edition) & ASCE 7-10 (2010 Edition) and the 2006 & 2009 editions of NFPA 5000 for use in areas of high seismicity, Seismic Use Group III, Zone 4 or Seismic Design Category (SDC) "D" with lateral force requirements for protecting 500 lbs. of essential equipment in locations with the highest level of seismicity and top floor or rooftop installations with an Importance factor (Ip) of 1.5. MK series shall be GREENGUARD Indoor Air Quality Certified for Children and Schools. MK shall be manufactured by an ISO 9001 and ISO 14001 registered company.

MK shall be warranted to be free from defects in material or workmanship under normal use and conditions for the lifetime of the product.

OPTIONS

- Horizontal Lacer Bars shall be model #LBP-1X, please see website for available styles
- Horizontal cable managers shall be model #HCM-X, please see website for available styles
- Cable ladder adapter shall be model #MK-LA and include 2 J-bolts
- Rackmount Cable Tray shall be model #HCT-1 (1 rackspace), HCT-2 (2 rackspace)
- Vented Center Mount shelf shall be model #U2MS
- Gland grommet for 4" electrical knockout in side of MK-1945-24 shall be model #K-4G, 4 pieces
- VCD Series Vertical Cable Duct shall mount to one side, or in-between MK Series racks, and be model #VCD-__-45-__, please see website for available styles.

CUSTOMIZABLE SPECIFICATION CLIPS AVAILABLE AT MIDDLEATLANTIC.COM

US: New Jersey • California • Illinois • Voice: 973-839-1011 Fax: 973-839-1976 • middleatlantic.com
 Canada: Ontario • British Columbia • Voice: 613-836-2501 Fax: 613-836-2690 • middleatlantic.ca

96-281 / rev g / 5-11-20 / MK Series Racks

MK Series basic dimensions MK-1945 shown

All dimensions in inches unless otherwise noted [All bracketed dimensions are in millimeters]

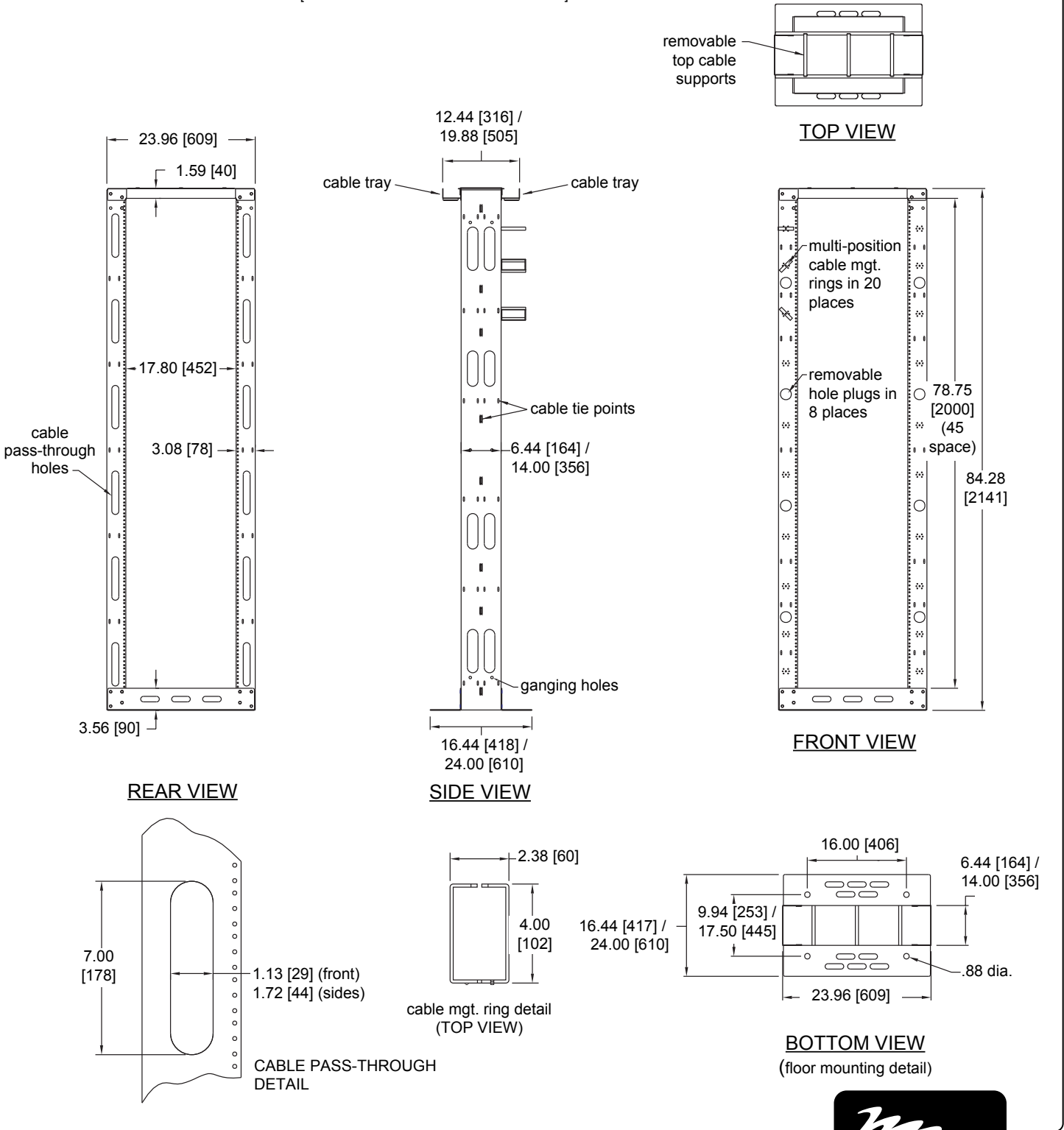

MK Series basic dimensions MK-1945-24 shown



All dimensions in inches unless otherwise noted [All bracketed dimensions are in millimeters]

TOP MOUNTING DETAIL

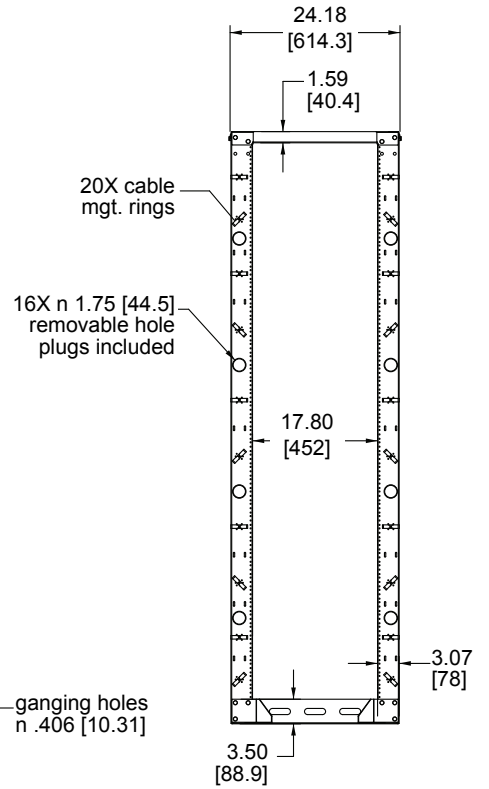
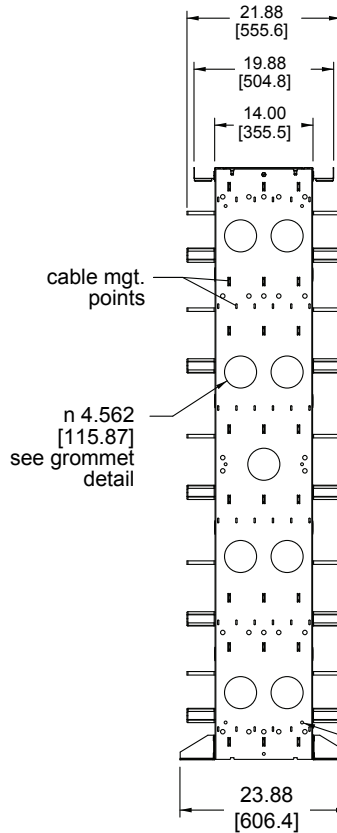
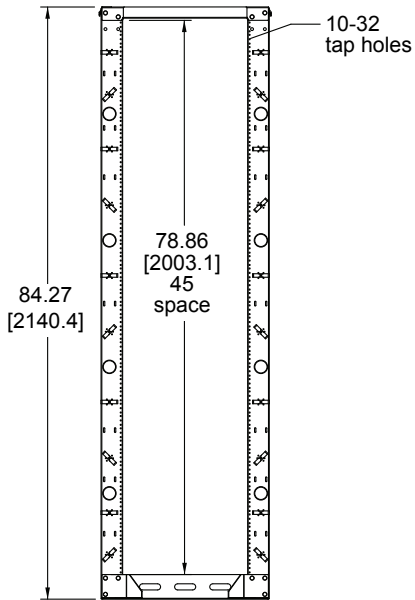
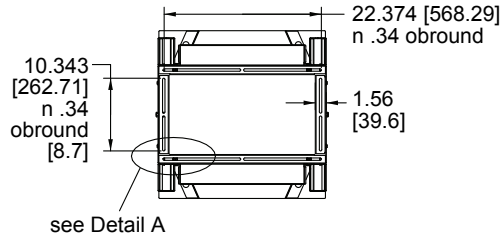

FLOOR MOUNTING DETAIL

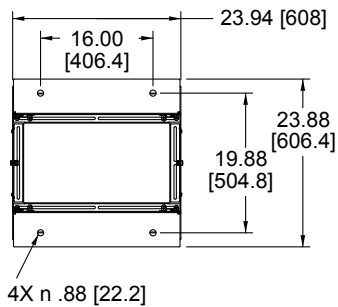

DETAIL A

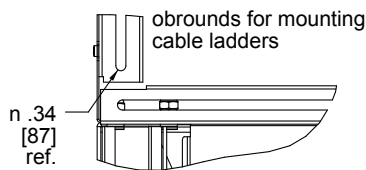

GROMMET DETAIL

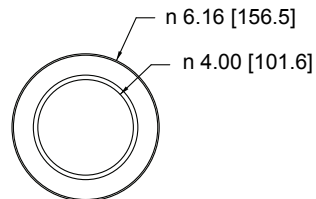

Part# GRK4

CABLE MGT. RING DETAIL

