



A TableSource Table Box installed in a typical work surface application.

Table Boxes bring technology to the point-of-use

Table Boxes bring technology into the user's work area. Routing of power, communications and A/V connectivity to the work surface needs to be unobtrusive with maximum accessibility and flexibility.

Our wide range of table box solutions offer the flexibility to meet the connectivity and power configurations requirements needed to run business smoothly, while enhancing the overall room appearance. From desks to lab benches, table boxes make technology easily accessible to the user.

Features & Benefits

- **Range of solutions.** Table Boxes allow you to access services on, above or below the work surface with cord-ended or field-wired options. Standard off-the-shelf, field configurable or custom configurations are available to meet any work area need.
- **Variety of applications.** Office workstations, conference rooms, even home offices can increase productivity by bringing access to connections up to the work surface.
- **Safety.** Wiremold Table Boxes meet U.S. and Canadian safety standards.
- **Aesthetics.** Elegant yet functional access to services includes cover style and color options to meet room décor. Built-in cable management with easy to install and replaceable retractors for communications and USB cables keeps the work surface clear.
- **Ease of installation.** From clamping to the edge of a desk or table, or using the supplied template to create the cut out, Wiremold Table Boxes are made easy to install so you can get back to business.

Compliance

TableSource™ Table Boxes:

Cord-Ended TableSource Boxes : cULus Listed Relocatable Power Tap: File E66421 Guide XBYS
Listed to US & Canadian Safety Standards. Meets Article 380 of NEC.



Hard-Wired TableSource Boxes: cULus Listed Multioutlet Assembly: File E15191 Guide PVGT
Listed to US & Canadian Safety Standards. Meets Article 380 of NEC.

deQuorum™ Flip-Up Table Boxes:

Cord-Ended deQuorum Table Boxes (DQFP): cULus Listed Relocatable Power Tap: File E66421 Guide XBYS
Listed to US & Canadian Safety Standards. Meets Article 380 of NEC.

Hard-Wired deQuorum Table Boxes (DQFF): cULus Listed Multioutlet Assembly: File E15191 Guide PVGT
Listed to US & Canadian Safety Standards. Meets Article 380 of NEC.

Table Boxes Quick Selection Guide

TABLE BOX MODEL	SVC. LOCATION @ TABLE	CORD LENGTH	FIELD WIRED OPTION	COVER COLOR/MATERIAL	ELECTRICAL OUTLETS	USB POWER RATING	DATA OPENINGS
TableSource Table Boxes (Standard Model) 	Above	6'	Yes	Clear Anodized Aluminum	(1) 15A Duplex, USB	2.4A	2 Openings with Adapters for Ortronics® Series II, TracJack or Wiremold Open System devices
TableSource Table Boxes (Configurable Model) 	Above	2'-12'	Yes	Clear Anodized Aluminum	(1-4) 15A Duplexes Gasketed, USB	2.4A	1-4 Openings with Adapters for Ortronics® Series II, TracJack or Wiremold Open System devices
deQuorum Flip Up Table Boxes 	Flush	6'	Yes	Black, Stainless	(1) 15A or 20A Duplex, (1) USB Duplex Receptacle	3.1A	Adapters for Ortronics® Series II, TracJack or Wiremold Open System devices

* Extron® Electronics MAAP modules are sold separately.

TableSource™ Table Boxes

TableSource™ Table Boxes provide effortless work surface accessibility for power and communication. They are offered in a range of standard or custom configured product. TableSource Table Boxes can be easily added to any work area and require minimal, adaptable installation.

CODE REFERENCE

Cord-Ended TableSource: cULus Listed Relocatable Power Tap:

File E66421 Guide XBY5

Hard-Wired TableSource: cULus Listed Multioutlet Assembly:

File E15191 Guide PVGT

Listed to US & Canadian Safety Standards. Meets Article 380 of NEC.

TABLESOURCE TABLE BOXES COLOR OPTIONS

Standard TableSource Table Boxes are available in a clear anodized aluminum finish. Other finishes are available for configurable units. Consult the configurator located on the next page.



TableSource™ Table Boxes provide flexibility in décor, datacom connectivity options, and installation to meet specific functional and aesthetic needs.

TableSource Table Boxes Ordering Information

TableSource Activations in this chart are packaged with a mounting clip that attaches to the work surface and a hardware bag of adapters that allows the communication openings to accept either Ortronics Series II, TracJack or Wiremold Open System.

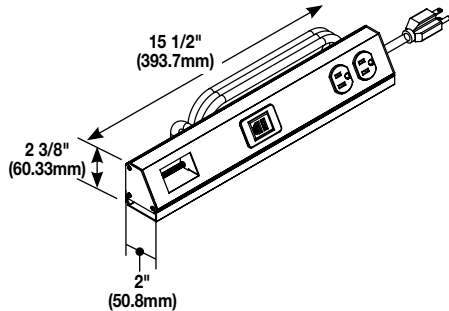

CATALOG NUMBER	FINISH	UNIT LENGTH		15A DUPLEX	CORD LENGTH		COMM. OPENINGS
		INCHES	(MM)		FEET	(MM)	
TSAX1F0AL1U	Clear Anodized	13"	(330.2mm)	1	6'	(1.83m)	0
TSAX1F1AL1U	Clear Anodized	15 1/2"	(393.7mm)	1	6'	(1.83m)	1
TSAX1F2AL1U	Clear Anodized	18 5/32"	(461.2mm)	1	6'	(1.83m)	2

Country of Origin:US

TableSource Activations in this chart are packaged with a mounting clip that attaches to the work surface and a hardware bag of adapters that allows the communication openings to accept either Ortronics Series II, TracJack or Wiremold Open System.

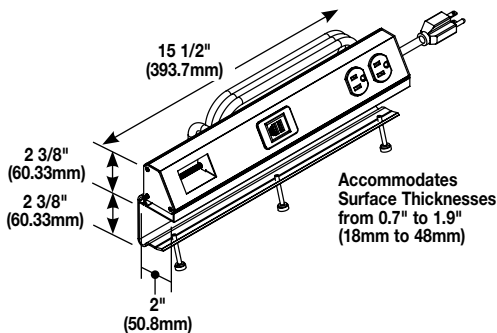

CATALOG NUMBER	FINISH	UNIT LENGTH		15A DUPLEX	CORD LENGTH		COMM. OPENINGS
		INCHES	[MM]		FEET	[MM]	
TSAM1F0AL1U	Clear Anodized	13"	(330.2mm)	1	6'	(1.83m)	0
TSAM1F1AL1U	Clear Anodized	15 1/2"	(393.7mm)	1	6'	(1.83m)	1
TSAM1F2AL1U	Clear Anodized	18 3/32"	(461.2mm)	1	6'	(1.83m)	2

Country of Origin:US

TableSource™ Table Boxes Configurator

Design a Cord-Ended TableSource Table Box

Sample Part: **TSAM2H1IV2U**

IMPORTANT

Use this chart to configure your own custom TableSource activation. Many of the configurations are standard offerings, and can be quoted and delivered to you quickly with the help of our Wiremold Customs group. Just call in with your TableSource part number, and they will be able to supply you with a quote, technical specifications and a CAD Drawing.

1. Select face for mounting device. Input letter.

2. Do you want optional mounting bracket for backslash application?

3. Number of Duplexes (from 1-4). Input number.

4. Choose a length and input the corresponding letter for that length.

5. Choose number of Communication Adapters (from 1-4). Input number.

6. Choose color of activation and devices. Input two-letter color code.

7. Choose number of USB modules. Input a number followed by "U"
#U = Number of USB Modules

Length Feet [metric]	Code Letter
2 [0.6m]	B
3 [0.9m]	C
4 [1.2m]	D
5 [1.5m]	E
6 [1.8m]	F
7 [2.1m]	G
8 [2.4m]	H
9 [2.7m]	I
10 [3.0m]	J
11 [3.4m]	K
12 [3.7m]	L

NOTE: Cord color is black.

Data Cables egress out the back (the side opposite the devices).

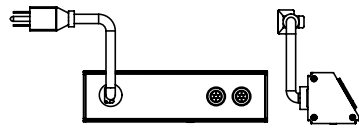

NOTE: Wiremold Open System, Ortronics Series II and TracJack modules provided with all assemblies.

Design a Hard-Wired TableSource Table Box

Sample Part: **TSAP2Z1BK2UG**

IMPORTANT

Use this chart to configure your own custom TableSource activation. Many of the configurations are standard offerings, and can be quoted and delivered to you quickly with the help of our Wiremold Customs group. Just call in with your TableSource part number, and they will be able to supply you with a quote, technical specifications and a CAD Drawing.

1. Select face for mounting device. Input letter.

2. Mounting Styles

3. Number of duplexes (from 1-4). Input number.

4. Choose face for 6' [1.8m], three-wire whip to exit. Y STYLE

5. Choose number of communication adapters (from 1-4). Input number.

6. Choose color of activation and devices. Input two-letter color code.

7. Choose number of USB modules. Input a number followed by "U"
#U = Number of USB Modules

8. Choose if Deadfront GFCI Protection is needed. If not, leave blank.
G = Dead Front GFCI Module

Data Cables egress out the back (the side opposite the devices).

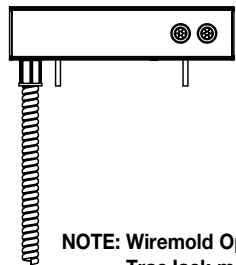

NOTE: Wiremold Open System, Ortronics Series II and TracJack modules provided with all assemblies.

deQuorum™ Flip-Up Table Boxes

deQuorum™ Flip-Up Table Boxes provide flexibility in décor, communication connectivity options, and installation to meet specific functional and aesthetic needs. Flip-Up Table Boxes bring the modules above the work surface when in use for easy access.

CODE REFERENCE

DQFP Table Boxes:
cULus Listed Relocatable Power Tap: File E66421 Guide XBY5

DQFF Table Boxes:
cULus Listed Multioutlet Assembly: File E15191 Guide PVGT
Listed to US & Canadian Safety Standards. Meets Article 380 of NEC.

deQUORUM FLIP-UP TABLE BOXES COLOR OPTIONS

deQuorum Flip-Up Table Box Covers are available in the following finishes: Black and Stainless.



deQuorum™ Flip-Up Table Boxes provide flexibility in décor, communication connectivity options, and installation to meet specific functional and aesthetic needs.

deQuorum Flip-Up Table Box Part Number Configurator

deQuorum Flip-Up Table Boxes

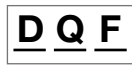

deQuorum Series:

DQF = deQuorum Flip-Up



Wiring Option:

P = Cord Ended
F = Field Wired



Receptacle Amperage:

15 = 15A
20 = 20A



USB:

U = USB



Unit Color:

BK = Black
ST = Stainless



Second Gang:

Communications = 2A
One Gang Only = Leave Blank

NOTE: Part Number Configurator can be used both to identify stock product configurations and also to request custom configurations from the factory. Consult the factory for more information.

deQuorum Flip-Up Table Boxes Ordering Information

DQFP15BK DQFP15ST

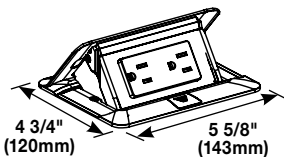

Single Flip-Up Unit – Unit includes one (1) 15A black tamper-resistant duplex receptacle. Unit comes with a 6' (1.83m) cord. Available in black or stainless finishes.

Country of Origin: Mexico

DQFP15UBK DQFP15UST

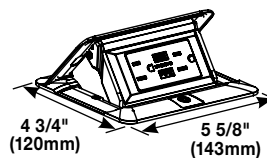

Single Flip-Up Unit – Unit includes one (1) 15A black tamper-resistant duplex receptacle with two (2) USB ports that provide 3.1A. Unit comes with a 6' (1.83m) cord. Available in black or stainless finishes.

Country of Origin: Mexico

DQFP15BK-2A DQFP15ST-2A

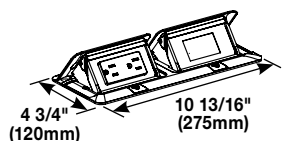

Dual Flip-Up Unit – Unit includes one (1) 15A black tamper-resistant duplex receptacle. Second opening will accept adapter for one (1) Wiremold CM Series Open System 2A module, one (1) Ortronics Series II or one (1) TracJack adapter to accommodate a wide range of communication outlets. Adapters are included in hardware bag. Unit comes with a 6' (1.83m) cord. Available in black or stainless finishes.

Country of Origin: Mexico

DQFP15UBK-2A DQFP15UST-2A

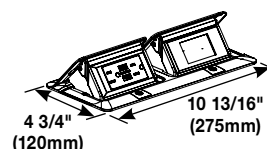

Dual Flip-Up Unit – Unit includes one (1) 15A black tamper-resistant duplex receptacle with two (2) USB ports that provide 3.1A. Second opening will accept adapter for one (1) Wiremold CM Series Open System 2A module, one (1) Ortronics Series II or one (1) TracJack adapter to accommodate a wide range of communication outlets. Adapters are included in hardware bag. Unit comes with a 6' (1.83m) cord. Available in black or stainless finishes.

Country of Origin: Mexico

NOTE: Single-gang table boxes require a cutout of 4 1/8" x 5" (105mm x 127mm).
Double-gang table boxes require a cutout of 4 1/8" x 10 1/4" (105mm x 260mm).

deQuorum Flip-Up Table Boxes Ordering Information

**DQFF15BK
DQFF15ST**

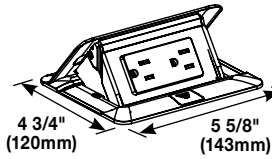

Single Flip-Up Unit – Unit includes one (1) 15A black tamper-resistant duplex receptacle. Unit can be field-wired with MC or EMT using any 1/2" trade size connector. Hot, neutral and ground wires come with quick connectors for activation. Available in black or stainless finishes.

Country of Origin: Mexico

**DQFF15UBK
DQFF15UST**

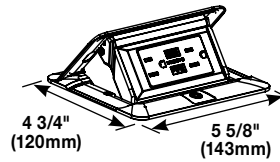

Single Flip-Up Unit – Unit includes one (1) 15A black tamper-resistant duplex receptacle with two (2) USB ports that provide 3.1A. Unit can be field-wired with MC or EMT using any 1/2" trade size connector. Hot, neutral, and ground wires come with quick connects for activation. Available in black or stainless finishes.

Country of Origin: Mexico

**DQFF20BK
DQFF20ST**

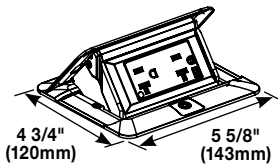

Single Flip-Up Unit – Unit includes one (1) 20A black tamper-resistant duplex receptacle. Unit can be field-wired with MC or EMT using any 1/2" trade size connector. Hot, neutral and ground wires come with quick connectors for activation. Available in black or stainless finishes.

Country of Origin: Mexico

**DQFF20UBK
DQFF20UST**

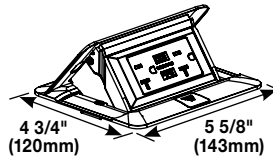

Single Flip-Up Unit – Unit includes one (1) 20A black tamper-resistant duplex receptacle with two (2) USB ports that provide 3.1A. Unit can be field-wired with MC or EMT using any 1/2" trade size connector. Hot, neutral, and ground wires come with quick connects for activation. Available in black or stainless finishes.

Country of Origin: Mexico

**DQFP20UBK
DQFP20UST**

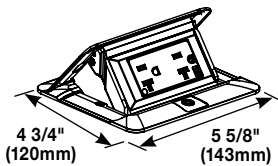

Single Flip-Up Unit – Unit includes one (1) 20A black tamper-resistant duplex receptacle with two (2) USB ports that provide 3.1A. Unit comes with a 6' (1.83m) cord. Available in black or stainless finishes.

Country of Origin: Mexico

**DQFP20BK
DQFP20ST**

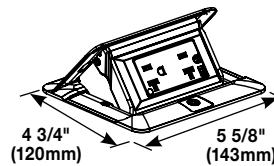

Single Flip-Up Unit – Unit includes one (1) 15A black tamper-resistant duplex receptacle. Unit comes with a 6' (1.83m) cord. Available in black or stainless finishes.

Country of Origin: Mexico

NOTE: Single-gang table boxes require a cutout of 4 1/8" x 5" (105mm x 127mm).

Vertical Markets

- Commercial
- Hospitality
- Education
- Parks
- Entertainment
- Healthcare
- Retail
- Transit

NOTE: All brand and product names referenced in this document are registered trademarks or trademarks of their respective holders.

 **NOTE:** The paper used to print this document is an environmentally responsible paper with 10% post consumer waste, with FSC and SFI Chain of Custody certifications, Lacey Act compliant. 100% of the electricity used to manufacture Flo sheets is generated with Green-e certified renewable energy.



Legrand, North America
60 Woodlawn Street
West Hartford, CT 06110
1.877.BY.LEGRAND (295.3472)
www.legrand.us

Canada
905.738.9195
www.legrand.ca

FOLLOW US

