



FITTINGS & STAMPINGS





FITTINGS & STAMPINGS



Staples PC 5020, 5025



- 12 Gauge Steel
- Rust Inhibitor
- Finger Friendly
- Boxed or in Pails
- Caution! Always Wear Eye Protection

Staples are used to attach NMC (non metallic cable) or BX (armored) cable to wooden studs. The RX Series is used for Romex® and the BX Series is used for Romex® and BX. The SEU staple is used for service entrance cable and is available in 100 pack. For electro galvanized specify G (i.e.; RXG50, BXG or SEU63G). Plastic Insulated staples are used for coaxial cable, bell wire, thermostat wire, telephone wire and Romex®.











CAT NO	UPC	CABLE SIZE	SIZE (W X L)	GAUGE	STD	MSTR	WT/STD	UNIT
1/2" - 2 Conductor (#12 & #14) Romex® and other type NM Cable - PC 5020								
RX501	30710	14-2, 12-2	1/2 x 1"	12 GA	100	5000	0.57#	M
RX505	30715	14-2, 12-2	1/2 x 1"	12 GA	500	5000	2.75#	M
RX50B	30720	14-2, 12-2	1/2 x 1"	12 GA	5000	5000	28.12#	M
RX503P	30725	14-2, 12-2	1/2 x 1"	12 GA	10000	10000(Pail)	56.60#	M
9/16" - 3 Conductor (#10, #12 & #14) Romex®, BX, MC and other Cable - PC 5020								
BX1001	27010	14-3, 12-3, 10-3	9/16 x 1-3/16"	12 GA	100	5000	0.69#	M
BX1005	27015	14-3, 12-3, 10-3	9/16 x 1-3/16"	12 GA	500	5000	3.38#	M
BX100B	27020	14-3, 12-3, 10-3	9/16 x 1-3/16"	12 GA	5000	5000	34.50#	M
BX3P	27025	14-3, 12-3, 10-3	9/16 x 1-3/16"	12 GA	7500	7500(Pail)	51.64#	M
SEU - PC 5025								
SEU63	27130	6/3 SEU Cable	13/16 x 1-3/8"	12 GA	100	1000	1.09#	M
SEU43	27135	4/3 & 2/3 SEU Cable	1-1/8 x 1-1/2"	12 GA	100	1000	1.30#	M

Staples - Electro Galvanized PC 5022, 5024



CAT NO	UPC	CABLE SIZE	SIZE (W X L)	GAUGE	STD	MSTR	WT/STD	UNIT
1/2" - 2 Conductor (#12 & #14) Romex® and other type NM Cable - PC 5022								
RXG501	10530	14-2, 12-2, 10-2	1/2 x 1"	12 GA	100	5000	0.60#	M
RXG505	10531	14-2, 12-2, 10-2	1/2 x 1"	12 GA	500	5000	2.85#	M
RXG503P	10532	14-2, 12-2, 10-2	1/2 x 1"	12 GA	10000	10000(Pail)	59.50#	M
9/16" - 3 Conductor (#10, #12 & #14) Romex®, BX, MC and other Cable - PC 5022								
BXG1001	10533	14-3, 12-3, 10-3	9/16 x 1-3/16"	12 GA	100	5000	0.70#	M
BXG1005	10534	14-3, 12-3, 10-3	9/16 x 1-3/16"	12 GA	500	5000	3.50#	M
BXG3P	10535	14-3, 12-3, 10-3	9/16 x 1-3/16"	12 GA	7500	7500(Pail)	52.50#	M
SEU - PC 5024								
SEU63G	27131	6/3 SEU Cable	13/16 x 1-3/8"	12 GA	100	1000	1.09#	M
SEU43G	27136	4/3 & 2/3 SEU Cable	1-1/8 x 1-1/2"	12 GA	100	1000	1.32#	M

Staples - Plastic Insulated PC 5026

CAT NO	UPC	CABLE SIZE	SIZE	COLOR	STD	MSTR	WT/STD	UNIT
1/2" - 2 Conductor (#12 & #14) Romex® and other type NM Cable								
PLX501	27140	14-2, 12-2	1/2"	White	100	5000	0.57#	M
PLX505	27142	14-2, 12-2	1/2"	White	500	5000	2.44#	M
PLX50P	27144	14-2, 12-2	1/2"	White	4000	4000(Pail)	22.80#	M
9/16" - 3 Conductor (#10, #12 & #14) Romex®, BX, MC and other Cable								
PLX751	27146	14-3, 12-3, 10-3	 3/4"	White	100	5000	0.62#	M
PLX755	27148	14-3, 12-3, 10-3	 3/4"	White	500	5000	2.53#	M
PLX75P	27150	14-3, 12-3, 10-3	 3/4"	White	3000	3000(Pail)	15.60#	M
Co-Axial Straps (Use Co-Axial RG-6 & RG-59U)								
PLX250W	10523	Tuff Pack 	 1/4"	White	500	3000	1.16#	M
PLX250B	10539	Tuff Pack 	 1/4"	Black(UV)	500	3000	1.16#	M
Bell, Telephone & Thermostat Wire Straps								
PLX18W	10540	Tuff Pack 	 1/4 x 1/8"	White	500	3000	1.08#	M
PLX18B	10541	Tuff Pack 	 1/4 x 1/8"	Black(UV)	500	3000	1.08#	M



Safety Plates PC 5050, 5060

Steel safety plates are affixed to the face of 2" x 4" members to protect utility pipes and to prevent nails from penetrating into hidden live wires (NMC cable) which may be running through notches or through the drilled holes in the stud.

- 16 Gauge Steel
- 20 Gauge Steel
- Nail Sharp Points
- Easy to Install
- Available in Boxes Or Pails
- Caution! Always Wear Eye Protection

CAT NO	UPC	SIZE	GAUGE	STD	MSTR	WT/STD	UNIT
PC 5050							
411	14100	1-1/2 x 2-3/4"	16	100	1000	7.00#	C
415	14105	1-1/2 x 2-3/4"	16	500	500	35.00#	C
41P	14116	1-1/2 x 2-3/4"	16	500(Pail)	500(Pail)	35.00#	C
PC 5060							
2516	14110	1-3/4 x 5"	16	100	100	16.00#	C
2520	14115	1-3/4 x 5"	20	100	100	10.00#	C
3516	14120	3 x 5"	16	100	100	26.80#	C

Dottie guarantees these plates to be 16 ga (.0538 to .0658) as required by some codes. Dottie makes no warranty that these plates cannot be pierced by powder actuated / gas powered nail guns.

Plate Straps PC 5150

Plate straps are nailed across studs to restrain pipe between studs; installed over utility pipes & electrical wire that pass through framing members to prevent piercing.

- 12 Gauge Steel
- 16 Gauge Steel
- Various Lengths
- Caution! Always Wear Eye Protection

CAT NO	UPC	SIZE	STD	MSTR	WT/STD	UNIT
PS129	60010	1-1/2 x 9"	50	50	16.66#	C
PS1212	60012	1-1/2 x 12"	50	50	23.50#	C
PS1218	60014	12 Gauge 1-1/2 x 18"	50	50	36.00#	C
PS1224	60016	1-1/2 x 24"	50	50	41.20#	C
PS169	60018	1-1/2 x 9"	50	50	9.14#	C
PS1612	60020	1-1/2 x 12"	50	50	15.40#	C
PS1618	60022	16 Gauge 1-1/2 x 18"	50	50	19.58#	C
PS1624	60024	1-1/2 x 24"	50	50	28.50#	C

Nail Straps PC 5070, 5080, 5090

Nail Straps are a stamped steel strap (J hook) which is nailed into studs to support tubing, pipe or E.M.T. Available in zinc or copper plated, and in copper plated with the top plastic coated.

- 12 Gauge Steel
- Copper Plated
- Zinc or Copper Plated
- Caution! Always Wear Eye Protection
- With Plastic Coating

CAT NO	UPC	SIZE	DESCRIPTION	STD	MSTR	WT/STD	UNIT
Zinc Plated - PC 5070							
D1	27655	1/2"	Pipe	100	1000	1.94#	M
D1P	27658	1/2"	Pipe	2000 (Pail)	2000 (Pail)	39.90#	M
D2	27660	3/4"	Pipe	100	1000	2.32#	M
D3	27665	1"	Pipe	100	1000	2.63#	M
D11	27670	1/2"	E.M.T.	100	1000	1.53#	M
D12	27675	3/4"	E.M.T.	100	1000	1.99#	M
D13	27680	1"	E.M.T.	100	1000	2.30#	M
Copper Plated - PC 5080							
K1	27100	1/2"	Tube	100	1000	1.60#	M
K2	27102	3/4"	Tube	100	1000	1.86#	M
K3	27104	1"	Tube	100	1000	2.36#	M
K4	27106	1-1/4"	Tube	100	1000	2.36#	M
Copper Plated w/ Plastic Coating - PC 5090							
PL10	27107	1/2"	Tube 3/8" Iron	100	1000	1.72#	M
PL20	27108	3/4"	Tube 1/2" Iron	100	1000	2.04#	M
PL30	27110	1"	Tube 3/4" Iron	50	500	1.30#	M
PL40	27112	1-1/4"	Tube 1" Iron	50	500	1.55#	M



Wire Hangers PC 5100

- 10 Gauge Steel
- Plain (Uncoated)
- Plastic Coated
- Caution! Always Wear Eye Protection

Wire Hangers are used to secure pipe or tubing transversing wood beams.



CAT NO	UPC	SIZE	STD	MSTR	WT/STD	UNIT
Plain						
WH124	27200	1/2 x 4"	100	500	4.38#	M
WH126	27202	1/2 x 6"	100	500	6.22#	M
WH344	27204	3/4 x 4"	100	500	4.36#	M
WH346	27206	3/4 x 6"	100	500	7.40#	M

Plastic Coated						
PC124	27208	1/2 x 4"	100	500	4.52#	M
PC126	27210	1/2 x 6"	100	500	6.20#	M
PC344	27212	3/4 x 4"	100	500	4.60#	M
PC346	27214	3/4 x 6"	100	500	6.30#	M

Hook on Clips · Hook on Straps PC 5110, 5120

- Hook on Clips & Straps
- Formed Wire
- Supplied With Insulator
- Caution! Always Wear Eye Protection

Hook on Straps & Clips are used to secure pipe or tubing running parallel with studs. The hook on straps are nailed across two studs. The hook on clips with insulator snap into holes in the strap and tubing or pipe is then secured perpendicular to the strap.

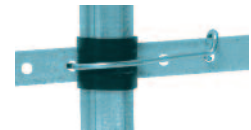

CAT NO	UPC	SIZE	STD	MSTR	WT/STD	UNIT
14 Gauge - PC 5110						
HC50	27220	1/2" Pipe	100	1000	1.66#	M
HC75	27225	3/4" Pipe	100	1000	1.75#	M
12 Gauge - PC 5120						
5818	27230	18" Length	100	100	21.08#	C
5826	27235	26" Length	100	100	30.58#	C

Plumber's Tape PC 5130, 5140

- Galvanized Steel
- Solid Copper

Plumber's Tape is 3/4" wide and is perforated with alternating size holes to accommodate nails or bolts. It is used to strap or support pipe, ducts & other fastening applications. Copper strap also used for grounding.



CAT NO	UPC	LENGTH	GAUGE	STD	MSTR	WT/STD	UNIT
Galvanized Steel - PC 5130							
PT28	30945	3/4 x 10'	28	100	100	35.16#	Ea
PT26	30940	3/4 x 10'	26	100	100	46.24#	Ea
PT22	30935	3/4 x 10'	22	50	50	37.64#	Ea
Solid Copper - PC 5140							
CU10	27550	3/4 x 10'	23	1	10	0.58#	Ea
CU25	27555	3/4 x 25'	23	1	6	1.48#	Ea
CU50	27560	3/4 x 50'	23	1	6	2.97#	Ea



One Hole Straps PC 5160

One Hole Straps are used to secure cables, tubing, pipe or E.M.T. to a surface

- Zinc Plated Steel (After Fabrication)
- Inverted Rib For Strength
- For E.M.T. / Pipe

CAT NO	UPC	TYPE	SIZE	GAUGE	STD	MSTR	WT/STD	UNIT
TW14	27745	Coaxial	1/4"	18 GA	100	1000	0.57#	C
TW38	27750	BX *	3/8"	18 GA	100	1000	1.15#	C
TW501	27700		1/2"	18 GA	100	1000	2.22#	C
TW75	27705		3/4"	18 GA	100	1000	3.12#	C
TW100	27710	E.M.T.	1"	18 GA	100	1000	3.45#	C
TW125	27715		1-1/4"	15 GA	100	500	5.49#	C
TW150	27720		1-1/2"	15 GA	50	500	3.86#	C
TW200	27725		2"	13 GA	50	500	7.10#	C
TW250	27726		2-1/2"	9 GA	25	100	10.13#	C
TW300	27727		3"	9 GA	25	100	13.38#	C
TW350	27728	E.M.T. / Pipe	3-1/2"	7 GA	25	100	16.61#	C
TW400	27729		4"	7 GA	25	100	19.02#	C
MTW50	27730	E.M.T.	1/2"	14 GA	100	1000	3.62#	C
MTW75	27735	Medium	3/4"	14 GA	100	1000	4.17#	C
MTW100	27740	Weight	1"	14 GA	100	500	5.45#	C
HW50	27800		1/2"	18 GA	100	1000	2.53#	C
HW75	27805		3/4"	18 GA	100	1000	3.19#	C
HW100	27810	Pipe	1"	14 GA	100	1000	6.66#	C
HW125	27815		1-1/4"	13 GA	50	500	5.49#	C
HW150	27820		1-1/2"	11 GA	50	500	8.36#	C
HW200	27825		2"	11 GA	50	500	10.66#	C
MHW50	27830	Pipe	1/2"	14 GA	100	1000	3.82#	C
MHW75	27835	Medium	3/4"	14 GA	100	1000	5.00#	C
MHW100	27840	Weight	1"	14 GA	100	1000	6.71#	C

* Accommodates 12-2, 12-3, 10-2, 10-3 BX



Two Hole Straps PC 5200

Two hole straps are used to secure cables, tubing, pipe or E.M.T. to a surface

- Zinc Plated Steel (After Fabrication)
- Inverted Rib For Strength
- For E.M.T. / Pipe

CAT NO	UPC	TYPE	SIZE	GAUGE	STD	MSTR	WT/STD	UNIT
TW301	27300		1/2"	22 GA	250	1000	4.13#	C
TW302	27305		3/4"	22 GA	250	1000	4.67#	C
TW303	27310		1"	22 GA	250	1000	8.24#	C
TW304	27315	E.M.T.	1-1/4"	20 GA	100	500	4.45#	C
TW305	27320		1-1/2"	20 GA	100	500	4.83#	C
TW306	27325		2"	20 GA	50	250	3.11#	C
HW400	27900		3/8"	22 GA	250	1000	4.64#	C
HW401	27905		1/2"	22 GA	250	1000	4.70#	C
HW402	27910		3/4"	22 GA	250	1000	5.33#	C
HW403	27915		1"	20 GA	100	1000	3.82#	C
HW404	27920		1-1/4"	20 GA	100	500	4.74#	C
HW405	27925	Pipe	1-1/2"	20 GA	100	500	5.30#	C
HW406	27930		2"	18 GA	50	500	4.32#	C
HW407	27935		2-1/2"	15 GA	25	250	4.96#	C
HW408	27940		3"	15 GA	25	250	5.64#	C
HW409	27945		3-1/2"	15 GA	10	50	3.44#	C
HW410	27950		4"	15 GA	10	50	3.72#	C





- Zinc Plated Steel (After Fabrication)
- Assembled With Combo Round Head Screws and Hex Nuts
- For E.M.T. & Pipe

Conduit hangers are used for supporting conduit or PVC from overhead applications.

CAT NO	UPC	PIPE	E.M.T.	GAUGE	BOLT SIZE	STD	MSTR	WT/STD	UNIT
PH50B	28320	3/8 -1/2"	1/2"	18 GA	1/4-20 x 1"	100	100	4.33#	C
PH75B	28322	3/4"	3/4"	18 GA	1/4-20 x 1-1/4"	100	100	6.12#	C
PH100B	28324	1"	1"	18 GA	1/4-20 x 1-1/4"	100	100	6.71#	C
PH110B	28326	-	1-1/4"	18 GA	1/4-20 x 1-1/4"	100	100	1.91#	C
PH125B	28328	1-1/4"	1-1/2"	18 GA	1/4-20 x 1-1/2"	100	100	9.18#	C
PH150B	28330	1-1/2"	-	16 GA	1/4-20 x 1-1/2"	100	100	13.88#	C
PH200B	28332	2"	2"	16 GA	1/4-20 x 1-1/2"	50	50	11.39#	C
PH250B	28334	2-1/2"	2-1/2"	16 GA	1/4-20 x 1-1/2"	50	50	12.07#	C
PH300B	28336	3"	3"	16 GA	1/4-20 x 1-1/2"	25	25	7.45#	C
PH350B	28337	3-1/2"	-	16 GA	1/4-20 x 2"	25	25	8.95#	C
PH400B	28338	4"	-	16 GA	1/4-20 x 2"	25	25	9.80#	C

**Conduit Hangers - Stainless Steel with
Stainless Steel Bolt - PC 5221**



- 301 Stainless Steel
- stainless Steel Bolts and Nuts
- For EMT & Pipe

Conduit hangers are used for supporting conduit or PVC from overhead applications. Stainless Steel dramatically improves corrosion resistance.

CAT NO	UPC	PIPE	E.M.T.	GAUGE	BOLT SIZE	STD	MSTR	WT/STD	UNIT
PH50BSS	81497	3/8 -1/2"	1/2"	18 GA	1/4-20 x 1"	10	100	0.43#	C
PH75BSS	81498	3/4"	3/4"	18 GA	1/4-20 x 1-1/4"	5	50	0.36#	C
PH100BSS	81499	1"	1"	18 GA	1/4-20 x 1-1/4"	5	50	0.33#	C
PH110BSS	81500	-	1-1/4"	18 GA	1/4-20 x 1-1/4"	2	20	0.38#	C
PH125BSS	81501	1-1/4"	1-1/2"	18 GA	1/4-20 x 1-1/2"	2	20	0.48#	C
PH150BSS	81502	1-1/2"	-	16 GA	1/4-20 x 1-1/2"	2	20	0.27#	C
PH200BSS	81503	2"	2"	16 GA	1/4-20 x 1-1/2"	2	20	0.45#	C
PH250BSS	81504	2-1/2"	2-1/2"	16 GA	1/4-20 x 1-1/2"	2	20	0.48#	C
PH300BSS	81505	3"	3"	16 GA	1/4-20 x 1-1/2"	2	20	0.59#	C
PH350BSS	81506	3-1/2"	-	16 GA	1/4-20 x 2"	2	20	0.72#	C
PH400BSS	81507	4"	-	16 GA	1/4-20 x 2"	2	20	0.78#	C

TECH TALK



ZINC CHROMATE Plating is the most widely used plating. Zinc is popular as a fastener coating because it is the least expensive and can be applied to a broad range of thicknesses. It has good to excellent corrosion resistance and is relatively non toxic.

STAINLESS STEEL Is a family of ferrous alloys, each with a minimum chromium content of 12 percent. Chromium is a non-corrodible element; consequently, all stainless steels have a high degree of corrosion resistance. Generally, the higher the chromium content, the better the corrosion resistance.



Universal Strut Clamps PC 5391

One tool is all you need with our Universal Strut Clamps thanks to the **welded stud** that allows for a quick and easy installation. Includes keps nut, and the clamps come assembled to make sure you never lose any parts. Electrogalvanized is the standard finish.

CAT NO	UPC	SIZE	DESCRIPTION	STD	MSTR	WT/STD	UNIT
SC50U	81707	1/2"	Universal Strut Clamps	50	50	5.5#	C
SC75U	81708	3/4"	Universal Strut Clamps	50	50	6.0#	C
SC100U	81709	1"	Universal Strut Clamps	50	50	7.5#	C
SC125U	81710	1-1/4"	Universal Strut Clamps	50	50	9.0#	C
SC150U	81711	1-1/2"	Universal Strut Clamps	50	50	10.0#	C
SC200U	81712	2"	Universal Strut Clamps	50	50	11.0#	C

E.M.T. Strut Clamps come assembled with a keps nut and slotted hex head bolt to make sure you never lose a part. Electrogalvanized is the standard finish.

CAT NO	UPC	SIZE	DESCRIPTION	STD	MSTR	WT/STD	UNIT
SC50E	81713	1/2"	E.M.T. Strut Clamps	100	100	11.0#	C
SC75E	81714	3/4"	E.M.T. Strut Clamps	100	100	12.0#	C
SC100E	81715	1"	E.M.T. Strut Clamps	100	100	15.0#	C
SC125E	81716	1-1/4"	E.M.T. Strut Clamps	50	50	7.5#	C
SC150E	81717	1-1/2"	E.M.T. Strut Clamps	50	50	14.5#	C
SC200E	81718	2"	E.M.T. Strut Clamps	50	50	16.5#	C

Rigid Strut Clamps come assembled with a keps nut and slotted hex head bolt to make sure you never lose a part. Electrogalvanized is the standard finish. Also available are Stainless Steel Ridge Strut Clamps Type 304 or 316, quoted upon request.

CAT NO	UPC	SIZE	DESCRIPTION	STD	MSTR	WT/STD	UNIT
SC50R	81719	1/2"	Rigid Strut Clamps	100	100	11.0#	C
SC75R	81720	3/4"	Rigid Strut Clamps	100	100	15.0#	C
SC100R	81721	1"	Rigid Strut Clamps	100	100	17.0#	C
SC125R	81722	1-1/4"	Rigid Strut Clamps	50	50	9.5#	C
SC150R	81723	1-1/2"	Rigid Strut Clamps	50	50	14.5#	C
SC200R	81724	2"	Rigid Strut Clamps	50	50	17.0#	C
SC250R	81725	2-1/2"	Rigid Strut Clamps	25	25	10.0#	C
SC300R	81726	3"	Rigid Strut Clamps	25	25	11.8#	C
SC350R	81727	3-1/2"	Rigid Strut Clamps	50	50	31.0#	C
SC400R	81728	4"	Rigid Strut Clamps	50	50	33.5#	C
SC500R	81729	5"	Rigid Strut Clamps	25	25	20.0#	C
SC600R	81730	6"	Rigid Strut Clamps	25	25	25.2#	C



Channel Nuts & U-Bolt Beam Clamps PC 5392

Channel Nuts are formed or stamped from steel bar stock and are case hardened after all forming and tapping operations have been completed. The nuts are then coated with zinc for an electrogalvanize finish. Sizes are also available in type 316 stainless steel, quoted upon request.

CAT NO	UPC	SIZE	DESCRIPTION	STD	MSTR	WT/STD	UNIT
SSN25	81731	1/4"	Standard Spring Nut	100	100	7.5#	C
SSN38	81732	3/8"	Standard Spring Nut	100	100	10.0#	C
SSN50	81733	1/2"	Standard Spring Nut	100	100	11.5#	C
SSN25S	81734	1/4"	Short Spring Nut	100	100	7.5#	C
SSN38S	81735	3/8"	Short Spring Nut	100	100	9.0#	C
SSN50S	81736	1/2"	Short Spring Nut	100	100	8.2#	C
SCN25	81737	1/4"	Channel Nut Without Spring	100	100	6.5#	C
SCN38	81738	3/8"	Channel Nut Without Spring	100	100	9.0#	C
SCN50	81739	1/2"	Channel Nut Without Spring	100	100	10.6#	C

U-Bolt Beam clamps are made from cold formed steel and conform to all tolerances listed in section 5.3 of the metal framing standards publication.

CAT NO	UPC	SIZE	DESCRIPTION	STD	MSTR	WT/STD	UNIT
SUB158	81767	1-5/8" x 1-5/8"	U-Bolt Beam Clamp for Strut	25	25	20.5#	C
SUB325	81768	1-5/8" x 3-1/4"	U-Bolt Beam Clamp for Strut	25	25	23.0#	C



Flat Plate Fittings PC 5393



Flat Plate Strut Fittings are made from cold formed steel and conform to all tolerances listed in section 5.3 of Metal Framing Standards Publication No. MFMA-1. Standard finish is electrogalvanized. Stainless steel types 304 and 316, quoted upon request.

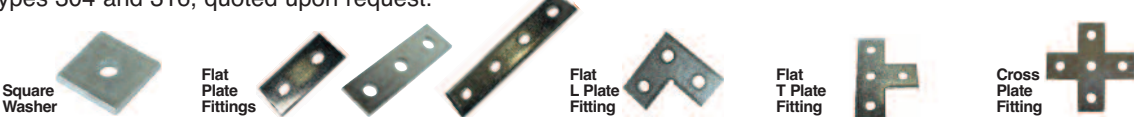

CAT NO	UPC	SIZE/TYPE	DESCRIPTION	STD	MSTR	WT/STD	UNIT
SQW516	81740	5/16"	Square Washer	100	100	18.0#	C
SQW38	81741	3/8"	Square Washer	100	100	18.0#	C
SQW50	81742	1/2"	Square Washer	100	100	18.0#	C
SQW58	81743	5/8"	Square Washer	100	100	17.0#	C
SFP2	81744	2 Hole	Flat Plate Fitting	50	50	19.0#	C
SFP3	81745	3 Hole	Flat Plate Fitting	50	50	29.0#	C
SFP4	81746	4 Hole	Flat Plate Fitting	25	25	19.5#	C
SFPL3	81747	3 Hole	Flat L Plate Fitting	50	50	31.0#	C
SFPT4	81748	4 Hole	Flat T Plate Fitting	25	25	20.0#	C
SFPC5	81749	5 Hole	Cross Plate Fitting	15	15	14.2#	C

Angle Fittings PC 5394

Angle Strut Fittings are made from cold formed steel and conform to all tolerances listed in section 5.3 of Metal Framing Standards Publication No. MFMA-1. Standard finish is electrogalvanized. Stainless steel types 304 and 316, quoted upon request.



CAT NO	UPC	TYPE	DESCRIPTION	STD	MSTR	WT/STD	UNIT
SAF290	81750	2 Hole	Bent 90° Angle Fitting	50	50	19.0#	C
SAF390	81751	3 Hole	Bent 90° Angle Fitting	50	50	29.0#	C
SAF490	81752	4 Hole	Bent 90° Angle Fitting	25	25	19.5#	C
SAFU690	81753	6 Hole	Universal 90° Angle Fitting	15	15	21.9#	C
SAF245	81754	2 Hole	Bent 45° Open Angle Fitting	50	50	25.0#	C
SAF245C	81755	2 Hole	Bent 45° Closed Angle Fitting	25	25	14.5#	C
SAF445	81756	4 Hole	Bent 45° Open Angle Fitting	25	25	15.0#	C
SAF445C	81757	4 Hole	Bent 45° Closed Angle Fitting	15	15	19.5#	C

Zee Fittings & U Fittings and Post Bases - PC 5395

Zee and U-shaped fittings, Post Bases are made from cold formed steel and conform to all tolerances listed in section 5.3 of Metal Framing Standards Publication No. MFMA-1. Standard finish is electrogalvanized. Stainless steel types 304 and 316, quoted upon request.



CAT NO	UPC	SIZE/TYPE	DESCRIPTION	STD	MSTR	WT/STD	UNIT
Zee Fittings and U Fittings							
SZFDS	81758	-	Zee Fitting Deep Strut	50	50	27.5#	C
SZFSS	81759	-	Zee Fitting Shallow Strut	50	50	23.5#	C
SUFDS	81760	-	U Fitting Deep Strut	15	15	13.2#	C
SUFSS	81761	-	U Fitting Shallow Strut	25	25	17.7#	C
Post Bases							
SPB890	81762	8 Hole	Single Channel Tall Clevis	10	10	28.7#	C
SPB1045	81763	10 Hole	Single Channel Tall Clevis	10	10	37.2#	C
SPB1090	81764	10 Hole	Single Channel Tall Clevis Square	10	10	37.2#	C
SPB1245	81765	12 Hole	Double Channel Tall Clevis	10	10	40.0#	C
SPB1290	81766	12 Hole	Double Channel Tall Clevis Square	10	10	40.0#	C

FITTINGS & STAMPINGS > FLAT PLATE, ANGLE, ZEE & U FITTINGS > POST BASES



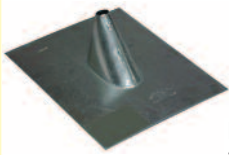

Standard - Roof Jacks PC 5230

Roof Jacks are applied to the roof to form a water-tight seal. They add additional support between the roof line and service entrance conduit or ventilation pipe.

- 28 Gauge
- Galvanized Steel

CAT NO	UPC	SIZE	STD	MSTR	WT/STD	UNIT	
RJ50	69600	Standard	1/2"	24	24	24.08#	Ea
RJ75	69605		3/4"	24	24	23.92#	Ea
RJ100	69610		1"	24	24	23.06#	Ea
RJ125	69615		1-1/4"	24	24	23.13#	Ea
RJ150	69620		1-1/2"	24	24	22.87#	Ea
RJ200	69625		2"	24	24	21.82#	Ea
RJ300	69630		3"	12	12	15.22#	Ea
RJ400	69635		4"	12	12	19.39#	Ea

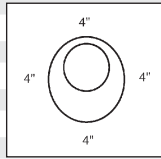

3 in 1 Roof Jacks PC 5250

Roof Jacks are applied to the roof to form a water-tight seal. They add additional support between the roof line and service entrance conduit or ventilation pipe.

- 24 Gauge
- Elastomer Collar

CAT NO	UPC	PIPE SIZE	STD	MSTR	WT/STD	UNIT
RN3	10350	Pipe Sizes: 1/2", 3/4", 1" * Base Size: 8-3/4", 12-1/2"	12	12	11.95#	Ea
RN4	10352	Pipe Sizes: 1-1/2", 2", 2-1/2", 3" Base Size: 10-3/4" x 12-1/2"	12	12	18.82#	Ea

*Can be modified to fit 1-1/4" pipe

Fits any roof pitch - from flat to 45°

Tested for ultraviolet, ozone, and weather resistance.



Steel / Galvanized - Tie Wire PC 5030 - 5035

Tie wire is used for many purposes, among them tying down PVC conduit in trenches before pouring concrete, as well as drop ceiling applications.

- 16 1/2 Gauge
- 400 Ft. (3 1/2#)
- Black Annealed or Galvanized

CAT NO	UPC	STD	MSTR	WT/STD	UNIT
Black Annealed - PC 5030					
TY164	28170	20	20	71.10#	Ea
Galvanized - PC 5035					
VTYG	28180	20	20	68.35#	Ea



Tie Wire Dispenser PC 5040

The tie wire dispenser stores and dispenses tie wire.

- High Impact Plastic
- Mounts On Tool Belt

CAT NO	UPC	DESCRIPTION	STD	MSTR	WT/STD	UNIT
TYD	28175	Tie Wire Dispenser	1	6	1.10#	Ea



Beam Clamps - Steel PC 5260, 5265



- Zinc Plated Steel or High Strength Malleable Iron
- Case Hardened Steel Bolt
- Tapped Threads Back & Bottom

Beam Clamps when secured to an I-beam, girder or other structural member, provide a mounting base for the attachment of conduit hangers, either directly or by using threaded rod.

CAT NO	UPC	SIZE	TYPE	STD	MSTR	WT/STD	UNIT
Steel - PC 5260							
BK14	10090	1/4-20	Steel	50	250	6.03#	C
BK38	10095	3/8-16	Steel	25	100	6.62#	C

Malleable - PC 5265							
BK14M	10092	1/4-20	Malleable	50	250	11.44#	C
BK38M	10097	3/8-16	Malleable	25	100	18.22#	C
BK50M	10099	1/2-13	Malleable	10	50	12.96#	C

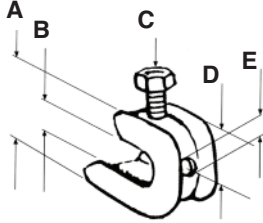

	A	B	C	D	E*
BK-14	1.39	.672	1/4 x 1"	.695	1/4-20
BK-14M	1.39	.750	5/16 x 1"	.625	1/4-20
BK-38	1.95	.781	5/16 x 1 3/8"	.979	3/8-16
BK-38M	1.75	.875	3/8 x 1 1/4"	.625	3/8-16
BK-50M	2.47	1.109	3/8 x 1 1/2"	.812	1/2-13

* Bottom & Back

Floor Flanges PC 5270

- High Strength Malleable Iron
- Zinc Plated

Floor flanges are secured to floors or walls and threaded conduit is then inserted as a post or divider.



CAT NO	UPC	SIZE	STD	MSTR	WT/STD	UNIT
FF50	60350	1/2"	25	25	6.79#	C
FF75	60351	3/4"	25	25	7.64#	C
FF100	60352	1"	10	10	4.50#	C
FF125	60353	1-1/4"	5	5	3.15#	C
FF150	60354	1-1/2"	5	5	3.85#	C
FF200	60355	2"	5	5	6.46#	C

Switch Box Supports PC 5290

- Quick Installation
- Supports Box, No Stud Needed
- Prevents Box Pull Out
- Galvanized Steel

Switch box supports are used in pairs in old work. The tongues are bent over the lip of the box and the bar is inserted into the opening to prevent the box from falling back out of the opening. The ears of the box keep it from falling into the opening.



CAT NO	UPC	DESCRIPTION	STD	MSTR	WT/STD	UNIT
SBS165	59850	Galvanized Box Support	100 Pair	500 Pair	5.30#	100 Pair

Ceiling Cover Plate PC 5280

- Steel
- White
- Adjustable Strap For 3" or 4" Boxes

Ceiling cover plates, 5 1/4" canopy with adjustable strap and screws for 3" or 4" outlet boxes. White color blends with most installations. Temporary or permanent.



CAT NO	UPC	SIZE	DESCRIPTION	STD	MSTR	WT/STD	UNIT
CP5	27545	5-1/4"	White Universal Cover Plate	10	50	7.11#	C



Reducing Bushings PC 5430

Reducing bushings are used with rigid /IMC conduit to reduce the size of a threaded opening to accept a smaller size conduit.

- Zinc Plated Steel
- High Strength Malleable Iron

CAT NO	UPC	SIZE	STD	MSTR	WT/STD	UNIT
R351	30500	1/2 x 3/8"	100	500	2.40#	C
R352	30505	3/4 x 1/2"	100	500	5.00#	C
R353	30510	1 x 1/2"	50	250	5.88#	C
R354	30515	1 x 3/4"	50	250	6.77#	C
R355	30520	1-1/4 x 1/2"	25	125	3.44#	C
R356	30525	1-1/4 x 3/4"	25	125	5.33#	C
R357	30530	1-1/4 x 1"	25	125	3.70#	C
R358	30535	1-1/2 x 1/2"	25	125	10.06#	C
R359	30540	1-1/2 x 3/4"	25	125	8.25#	C
R360	30545	1-1/2 x 1"	25	125	6.45#	C
R361	30550	1-1/2 x 1-1/4"	25	125	2.78#	C
R362	30555	2 x 1/2"	10	50	8.18#	C
R363	30560	2 x 3/4"	10	50	7.34#	C
R364	30565	2 x 1"	10	50	6.50#	C
R365	30570	2 x 1-1/4"	10	50	4.81#	C
R366	30575	2 x 1-1/2"	10	50	3.27#	C
R367	30576	2-1/2 x 2"	1	10	0.60#	C
R368	30577	3 x 2"	1	10	1.04#	C
R369	30578	3 x 2-1/2"	1	10	1.22#	C
R370	30579	3-1/2 x 2"	1	10	1.39#	C
R371	30580	3-1/2 x 2-1/2"	1	10	1.48#	C
R372	30581	3-1/2 x 3"	1	10	1.17#	C
R373	30582	4 x 2"	1	10	3.62#	C
R374	30583	4 x 2-1/2"	1	10	1.95#	C
R375	30584	4 x 3"	1	10	1.64#	C
R376	30585	4 x 3-1/2"	1	10	1.28#	C



Plastic Bushings PC 5670

Plastic bushings are threaded onto the end of conduit and are used to protect wires coming through the conduit.

- UL Listed
- Thermoplastic
- 105° C
- Fits Rigid Conduit

CAT NO	UPC	SIZE	STD	MSTR	WT/STD	UNIT
PB50	10100	1/2"	100	1000	0.49#	C
PB75	10105	3/4"	100	1000	0.64#	C
PB100	10110	1"	50	500	0.58#	C
PB125	10115	1-1/4"	25	250	0.44#	C
PB150	10120	1-1/2"	25	250	0.50#	C
PB200	10125	2"	25	250	0.74#	C
PB250	10130	2-1/2"	25	100	1.32#	C
PB300	10135	3"	25	100	1.55#	C
PB350	10140	3-1/2"	10	50	0.85#	C
PB400	10145	4"	10	20	0.98#	C
PB500	10150	5"	10	10	2.93#	C
PB600	10155	6"	10	10	3.85#	C



EMT Bushings PC 5675

EMT Insulating Bushings protect cables from abrasion. Use where nonmetallic low voltage cabling is installed in EMT.

- Stay-In-Place Design
- Engineered Plastic
- Color: White

CAT NO	UPC	SIZE	STD	MSTR	WT/STD	UNIT
EMTB50	81613	1/2"	100	1000	0.40#	C
EMTB75	81614	3/4"	50	500	0.25#	C
EMTB100	81615	1"	25	250	0.23#	C
EMTB125	81616	1-1/4"	25	250	0.27#	C
EMTB150	81617	1-1/2"	25	100	0.35#	C
EMTB200	81618	2"	25	100	0.55#	C
EMTB250	81619	2-1/2"	25	100	1.40#	C
EMTB300	81620	3"	25	100	1.30#	C
EMTB350	81621	3-1/2"	25	100	2.10#	C
EMTB400	81622	4"	25	100	3.20#	C

Nylon KO Bushings PC 6100



- 105° C
- Snap In
- Reusable

Nylon KO bushings are snapped into punched holes in panels to protect wires from the rough edges.

CAT NO	UPC	SIZE	STD	MSTR	WT/STD	UNIT
1210D	12100	1/2"	100	1000	0.45#	C
1211D	12110	3/4"	100	1000	0.66#	C
1212D	12120	1"	100	1000	0.99#	C
1213D	12130	1-1/4"	50	500	0.70#	C
1214D	12140	1-1/2"	25	250	0.46#	C
1215D	12150	2"	25	250	0.93#	C
1216D	12160	2-1/2"	25	250	1.20#	C

Anti-Short Bushings PC 5680



- Plastic
- Fits Armored Cable
- Prevents Shorts

Anti-Short bushings are used to protect wire insulation from the jagged or sharp cut edges of BX or flex. Priced per 100 pieces.

CAT NO	UPC	FLEX	CABLE SIZE	PKG	STD	MSTR	WT/STD	UNIT
0	11600	5/16"	14/2, 14/3, 12/2	100	1000	1000	0.75#	C
1	11601	3/8"	14/4, 6/1,4/1, 12/3	100	1000	1000	0.30#	C
2	11602	7/16"	12/4, 10/2, 10/3, 2/1	50	500	500	0.35#	C
3	11603	1/2"	10/4, 8/2, 8/3, 1/1	50	500	500	0.40#	C
4	11604	3/4"	8/4, 6/2, 6/3, 4/2, 4/3	50	500	500	0.40#	C

K.O. Seals PC 5440



- Snap In
- Steel
- Zinc Plated

Snap in K.O. seals are used to seal up holes punched in panels or knockouts from outlet boxes. They are held in place by spring tension. Available in sizes from 1/2" thru 2".

CAT NO	UPC	SIZE	STD	MSTR	WT/STD	UNIT
KO50	16000	1/2"	100	1000	1.44#	C
KO75	16010	3/4"	100	1000	1.62#	C
KO100	16020	1"	100	500	2.10#	C
KO125	16030	1-1/4"	50	100	1.45#	C
KO150	16040	1-1/2"	50	50	2.14#	C
KO200	16050	2"	25	25	1.44#	C

Three Piece K.O. Seals PC 5450



- Assembled*
- Includes Screw and Threaded Strap
- Steel
- Zinc Plated

Three piece K.O. seals are used to seal up holes punched in panels or knockouts from outlet boxes. They are held in place by a screw inserted through the seal into a threaded strap on the opposite side of the opening. Available in sizes from 1/2" thru 6". Three piece K.O. seals are embossed to centralize in knockout. Installs from the inside or outside of any box without rearranging wires. One screw secures unit. Size is stamped into seal.

CAT NO	UPC	SIZE	STD	MSTR	WT/STD	UNIT
D10S*	10240	1/2"	100	100	2.62#	C
D20S*	10242	3/4"	50	50	1.73#	C
D30S*	10244	1"	25	25	1.33#	C
D40S	10246	1-1/4"	25	25	1.74#	C
D50S	10248	1-1/2"	10	10	1.03#	C
D60S	10250	2"	10	10	1.46#	C
D70S	10252	2-1/2"	10	10	2.16#	C
D80S	10254	3"	10	10	3.11#	C
D90S	10256	3-1/2"	10	10	3.97#	C
D100S	10258	4"	10	10	5.81#	C
D110S	10260	4-1/2"	10	10	10.45#	C
D120S	10262	5"	10	10	13.33#	C
D130S	10264	6"	10	10	14.10#	C



Reducing Washers PC 5455

Reducing washers are used to reduce the size of a knockout on a sheet metal box, enclosure or cabinet.

- Steel
- Zinc Plated
- Stamped With Size

CAT NO	UPC	SIZE	STD	MSTR	WT/STD	UNIT
RW21	30103	3/4 x 1/2"	100	1000	0.98#	C
RW31	30106	1 x 1/2"	100	1000	1.90#	C
RW32	30109	1 x 3/4"	100	1000	1.37#	C
RW41	30112	1-1/4 x 1/2"	50	500	1.33#	C
RW42	30115	1-1/4 x 3/4"	50	500	1.24#	C
RW43	30118	1-1/4 x 1"	50	500	0.95#	C
RW51	30121	1-1/2 x 1/2"	50	500	1.93#	C
RW52	30124	1-1/2 x 3/4"	50	500	1.78#	C
RW53	30127	1-1/2 x 1"	50	500	1.54#	C
RW54	30130	1-1/2 x 1-1/4"	50	500	1.15#	C
RW61	30133	2 x 1/2"	25	250	1.56#	C
RW62	30136	2 x 3/4"	25	250	1.49#	C
RW63	30139	2 x 1"	25	250	1.37#	C
RW64	30142	2 x 1-1/4"	25	250	1.17#	C
RW65	30145	2 x 1-1/2"	25	250	0.99#	C
RW71	30148	2-1/2 x 1/2"	25	50	2.49#	C
RW72	30151	2-1/2 x 3/4"	25	50	2.37#	C
RW73	30154	2-1/2 x 1"	25	50	2.26#	C
RW74	30157	2-1/2 x 1-1/4"	25	50	2.04#	C
RW75	30160	2-1/2 x 1-1/2"	25	50	1.82#	C
RW76	30163	2-1/2 x 2"	25	50	1.37#	C
RW81	30166	3 x 1/2"	10	30	1.45#	C
RW82	30169	3 x 3/4"	10	30	1.43#	C
RW83	30172	3 x 1"	10	30	1.32#	C
RW84	30175	3 x 1-1/4"	10	30	1.28#	C
RW85	30178	3 x 1-1/2"	10	30	1.11#	C
RW86	30181	3 x 2"	10	30	1.01#	C
RW87	30184	3 x 2-1/2"	10	30	0.78#	C
RW91	30170	3-1/2 x 1/2"	10	10	2.08#	C
RW92	30171	3-1/2 x 3/4"	10	10	2.74#	C
RW93	30173	3-1/2 x 1"	10	10	2.57#	C
RW94	30185	3-1/2 x 1-1/4"	10	10	2.70#	C
RW95	30186	3-1/2 x 1-1/2"	10	10	2.29#	C
RW96	30188	3-1/2 x 2"	10	10	2.04#	C
RW97	30190	3-1/2 x 2-1/2"	10	10	2.33#	C
RW98	30192	3-1/2 x 3"	10	10	1.19#	C
RW101	30189	4 x 1/2"	10	10	3.47#	C
RW102	30191	4 x 3/4"	10	10	3.40#	C
RW103	30193	4 x 1"	10	10	3.32#	C
RW104	30195	4 x 1-1/4"	10	10	3.42#	C
RW105	30197	4 x 1-1/2"	10	10	3.06#	C
RW106	30194	4 x 2"	10	10	2.70#	C
RW107	30196	4 x 2-1/2"	10	10	2.35#	C
RW108	30198	4 x 3"	10	10	1.84#	C
RW109	30200	4 x 3-1/2"	10	10	1.39#	C



- UL Listed
- Allow Cables To Pull Easily, Prevent Hang-ups
- Snaps Securely Into Metal Studs
- 24 to 12 Gauge

Universal Plastic Stud Bushings are used to protect wires from abrasion in metal studs. Due to their molded high-strength, non-conductive polypropylene construction, the USB allows for the installation of multiple cables through a single opening while providing a smooth wire pulling surface. Dottie's USB's can be used with power cabling, low voltage datacom, video and voice cables. Fits all standard pre-punched and field punched holes.

CAT NO	UPC	SIZE	STD	MSTR	WT/STD	UNIT
USB	81031	3/8"	25	500	0.34#	C

Locknuts PC 5660



- Steel
- Zinc Plated

Locknuts are used to secure conduit by running or threading conduit into a box or panel and attaching the locknut and cinching up until tight.

CAT NO	UPC	SIZE	STD	MSTR	WT/STD	UNIT
LN38*	12300	3/8"	100	1000	3.02#	C
LN50	12301	1/2"	100	1000	1.34#	C
LN75	12302	3/4"	100	1000	2.05#	C
LN100	12303	1"	100	500	2.78#	C
LN125	12304	1-1/4"	50	250	2.08#	C
LN150	12305	1-1/2"	50	250	2.95#	C
LN200	12306	2"	50	100	3.22#	C
LN250	12307	2-1/2"	25	100	3.30#	C
LN300	12308	3"	25	100	3.94#	C
LN350	12309	3-1/2"	25	50	5.00#	C
LN400	12310	4"	25	50	6.06#	C
LN500	12311	5"	10	10	8.95#	C
LN600	12312	6"	10	10	9.90#	C

* LN38 Square Fixture Locknut

Sealing Locknuts PC 5665 Rated: NEMA FB1



- UL Listed
- Steel Locknut
- PVC Sealing Ring
- Zinc Plated

Used wherever a liquid tight application is needed when fastening threaded conduit to an unthreaded opening in a box or enclosure.

CAT NO	UPC	SIZE	STD	MSTR	WT/STD	UNIT
LNS50	12330	1/2"	100	1000	1.34#	C
LNS75	12331	3/4"	100	1000	2.05#	C
LNS100	12332	1"	100	500	2.78#	C
LNS125	12333	1-1/4"	50	250	2.08#	C
LNS150	12334	1-1/2"	50	250	2.95#	C
LNS200	12336	2"	50	100	3.22#	C
LNS250	12338	2-1/2"	25	100	3.30#	C
LNS300	12340	3"	25	100	3.94#	C
LNS350	12342	3-1/2"	25	50	5.00#	C
LNS400	12344	4"	25	50	6.06#	C

FITTINGS & STAMPINGS > UNIVERSAL PLASTIC STUD BUSHING > LOCKNUTS > SEALING LOCKNUTS



Non Metallic Cable Connectors PC 6081

DRC 50 & 75 are smaller and easily installed in confined and tight areas. No tools required. Snap in and you're done. Easily removed from knockouts and easy removal of Romex from connectors. A labor saving connector with 60 pound test pull!

- UL/CSA Listed
- Thermoplastic
- Easily Installed / No Tools Required
- 60 Pound Test Pull

CAT NO	UPC	CABLE SIZE	SIZE	STD	MSTR	WT/STD	UNIT
DRC50	50507	Single Cable 14/2 - 10/3 Two Cables 14/2, 12/2, 14/3	1/2"	100	4000	1.06#	C
DRC75	50508	Single Cable 8/3 - 6/3 Two Cables 14/2 - 8/2	3/4"	50	2400	0.72#	C



Non Metallic Cable Connectors PC 6070

The NMC50 connector for Romex is a snap to install. Molded in a one piece plastic construction, this push in design has a captive locking wedge. The cable will be securely retained and no locknut is required. They provide excellent strain relief and are designed to accommodate 14/2 minimum to 10/3 maximum cables, and one or more .300 to .600 diameter cords.

- UL Listed
- One or Two Cables
- Installs Quickly
- Excellent Strain Relief
- All Plastic Design; Resists Corrosion

CAT NO	UPC	SIZE	STD	MSTR	WT/STD	UNIT
NMC50	10160	1/2"	100	1000	1.14#	C



Cat-A-Pillar Wiring Device Spacer PC 6230

Cat-A-Pillar is a non conductive, low density polyethylene spacer strip consisting of 8 foldable segments. Each segment allows for 1/8" of spacing. It's easy to calculate. Determine the depth of the box to the surface and tear or cut the number of 1/8" segments needed. Snap over screw (no need to remove) and rotate a Cat-A-Pillar so that the slot faces away from the device. Installs quickly on single or multi-gang boxes. Reusable and can be used as a shim or a plastic washer to straighten crooked devices.

- Low Density Polyethylene
- Non Conductive
- Reusable
- Sold Per Ea Pack

CAT NO	UPC	STD	MSTR	WT/STD	UNIT
CA25	16170	25	250	0.18#	Ea Pack
CA100	16171	100	1000	0.65#	Ea Pack

CAT-A-PILLARS are not intended to be used in lieu of standard means of support under normal circumstances or when in conflict with governing electrical codes.



Wall Plate Insulation Gaskets PC 6240

Energy saving gaskets prevent the loss of heat and cold through outlets and switches located on outside walls. Constructed of UL Rated #94HFI listed cross link close cell polyethylene insulating foam. New one piece design fits: regular toggle or duplex receptacle and Decora Type Toggle and duplex receptacles.

- Polyethylene Insulating Foam
- Flame Retardant
- Energy Saving
- One Size Fits All
- Sold Per Ea Pack

CAT NO	UPC	STD	MSTR	WT/STD	UNIT
WPI25	16180	25	500	0.05#	Ea Pack
WPI100	16182	100	1000	0.40#	Ea Pack

Strain Relief Connectors - Nylon PC 5510



- UL Listed
- Liquid Tight to 70PSI
- Excellent Pullout Resistance
- Extended Cable Range

Nylon strain relief connectors grip portable cord to relieve strain on cord and prevent wires from being pulled out of connecting screws.
Note: Wire ranges vary from the steel strain relief connectors.
Locknut not supplied.

CAT NO	UPC	SIZE	CABLE RANGE	STD	MSTR	WT/STD	UNIT
NSR38L	36020	3/8"	.197 to .394	25	100	0.71#	C
NSR12L	36024	1/2"	.394 to .551	25	100	0.96#	C
NSR34L	36028	3/4"	.354 to .551	10	50	0.62#	C
NSR100L	36032	1"	.709 to .984	10	50	1.02#	C

Strain Relief Connectors - Steel PC 5520



- UL Listed
- Excellent Pullout Resistance
- Extended Cable Range
- Zinc Plated Steel

Steel strain relief connectors grip portable cord to relieve strain on cord and prevent wires from being pulled out of connecting screws.
Note: Wire ranges vary from the nylon strain relief connectors.

CAT NO	UPC	SIZE	CABLE RANGE	COLOR	STD	MSTR	WT/STD	UNIT
SR50A250	36050	1/2"	.150 to .250	Red	25	125	2.61#	C
SR50A350	36052	1/2"	.250 to .350	White	25	125	2.58#	C
SR50A450	36054	1/2"	.350 to .450	Blue	25	125	2.55#	C
SR50A560	36056	1/2"	.450 to .560	Green	25	125	2.50#	C
SR50A650	36058	1/2"	.550 to .650	Brown	25	125	2.43#	C
SR75A250	36060	3/4"	.150 to .250	Red	10	50	1.67#	C
SR75A350	36062	3/4"	.250 to .350	White	10	50	1.71#	C
SR75A450	36064	3/4"	.350 to .450	Blue	10	50	1.66#	C
SR75A560	36066	3/4"	.450 to .560	Green	10	50	1.62#	C
SR75A650	36068	3/4"	.550 to .650	Brown	10	50	1.57#	C
SR75B750	36070	3/4"	.650 to .750	Yellow	10	50	1.44#	C
SR75B850	36072	3/4"	.750 to .850	Purple	10	50	1.45#	C
SR100B750	36074	1"	.650 to .750	Yellow	5	25	1.44#	C
SR100B850	36076	1"	.750 to .850	Purple	5	25	1.44#	C
SR100C950	36078	1"	.850 to .950	Gray	5	25	1.43#	C
SR100C1050	36080	1"	.950 to 1.050	Black	5	25	1.41#	C

Steel Combo Couplings PC 5470



- UL Listed
- Steel
- Zinc Plated

Steel combo couplings are used to connect liquid tight conduit to E.M.T.

CAT NO	UPC	SIZE	STD	MSTR	WT/STD	UNIT
CF1	40750	1/2" Flex to E.M.T.	25	125	3.39#	C
CF2	40755	3/4" Flex to E.M.T.	10	50	2.16#	C
CF3	40760	1" Flex to E.M.T.	10	20	3.49#	C



Die Cast Liquid Tite Connectors PC 5460

Die cast liquid tite connectors are used to connect metallic & non-metallic liquid tite conduit into an enclosure.

- UL Listed
- Zinc Die Cast
- Straight & 90°
- Insulated & Non Insulated

CAT NO	UPC	SIZE	STD	MSTR	WT/STD	UNIT
LT38	11000	3/8"	25	250	3.22#	C
LT50	11005	1/2"	25	250	3.65#	C
LT75	11010	3/4"	10	100	2.19#	C
LT100	11015	Straight 1"	5	50	1.74#	C
LT125	11020	1-1/4"	5	50	2.69#	C
LT150	11025	1-1/2"	2	20	1.26#	C
LT200	11030	2"	2	20	1.60#	C
LT9038	11200	3/8"	10	100	2.17#	C
LT9050	11205	1/2"	10	100	2.97#	C
LT9075	11210	3/4"	10	100	2.73#	C
LT90100	11215	90° 1"	5	50	2.26#	C
LT90125	11220	1-1/4"	5	50	3.92#	C
LT90150	11225	1-1/2"	2	20	2.12#	C
LT90200	11230	2"	2	20	2.62#	C
LT38I	11100	3/8"	25	250	3.86#	C
LT50I	11105	1/2"	25	250	3.32#	C
LT75I	11110	3/4"	10	100	2.37#	C
LT100I	11115	1"	5	50	1.84#	C
LT125I	11120	Straight 1-1/4"	5	50	2.66#	C
LT150I	11125	Insulated 1-1/2"	2	20	1.24#	C
LT200I	11130	2"	2	20	1.64#	C
LT250I	11135	2-1/2"	1	1	1.74#	C
LT300I	11140	3"	1	1	2.68#	C
LT350I	11145	3-1/2"	1	1	3.45#	C
LT400I	11150	4"	1	1	3.87#	C
LT9038I	11300	3/8"	10	100	2.28#	C
LT9050I	11305	1/2"	10	100	1.98#	C
LT9075I	11310	3/4"	10	100	2.77#	C
LT90100I	11315	1"	5	50	2.26#	C
LT90125I	11320	90° 1-1/4"	5	50	4.09#	C
LT90150I	11325	Insulated 1-1/2"	2	20	2.06#	C
LT90200I	11330	2"	2	20	2.81#	C
LT90250I	11235	2-1/2"	1	1	3.43#	C
LT90300I	11240	3"	1	1	4.72#	C
LT90350I	11245	3-1/2"	1	1	7.33#	C
LT90400I	11250	4"	1	1	8.03#	C



PVC Liquid Tite Connectors PC 5490

PVC liquid tite connectors are used to connect non metallic liquid tite conduit & flexible non-metallic tubing to enclosures. UV rated plastic.

- UL Listed
- PVC With Polypropylene Sealing Ring
- Straight & 90°

CAT NO	UPC	SIZE	STD	MSTR	WT/STD	UNIT
NLT38	36000	3/8"	25	100	1.92#	C
NLT50	36002	1/2"	25	100	1.34#	C
NLT75	36004	3/4"	25	100	2.38#	C
NLT100	36006	Straight 1"	25	100	2.68#	C
NLT125	36007	1-1/4"	5	25	1.40#	C
NLT150	36009	1-1/2"	5	25	1.42#	C
NLT200	36011	2"	5	25	2.13#	C
NLT9038	36008	3/8"	10	50	0.89#	C
NLT9050	36010	1/2"	10	50	0.76#	C
NLT9075	36012	3/4"	10	50	1.07#	C
NLT90100	36014	90° 1"	5	25	1.00#	C
NLT90125	36013	1-1/4"	5	25	1.72#	C
NLT90150	36015	1-1/2"	5	25	2.43#	C
NLT90200	36016	2"	5	25	3.41#	C

Steel Liquid Tite Connectors PC 5480

- UL Listed
- Zinc Plated Steel
- Malleable Iron

- Straight, 45° & 90°
- Insulated & Non Insulated

Steel liquid tite connectors are used to connect liquid tite conduit into an enclosure.



FITTINGS & STAMPINGS > STEEL LIQUID TITE CONNECTORS

CAT NO	UPC		SIZE	STD	MSTR	WT/STD	UNIT
SL38	66701		3/8"	25	125	2.88#	C
SL50	66700		1/2"	25	125	3.22#	C
SL75	66702	Straight	3/4"	10	50	1.80#	C
SL100	66704		1"	5	25	1.49#	C
SL125	66736		1-1/4"	5	25	2.35#	C
SL150	66738		1-1/2"	5	5	3.01#	C
SL200	66740		2"	5	5	4.25#	C
SL4538	66705		3/8"	10	50	1.99#	C
SL4550	66706		1/2"	10	50	2.19#	C
SL4575	66708	45°	3/4"	10	50	3.06#	C
SL45100	66710		1"	5	25	2.61#	C
SL45125	66711		1-1/4"	5	5	3.43#	C
SL45150	66713		1-1/2"	2	2	2.04#	C
SL45200	66715		2"	2	2	2.92#	C
SL9038	66709		3/8"	10	50	2.22#	C
SL9050	66712		1/2"	10	50	2.35#	C
SL9075	66714	90°	3/4"	10	50	3.54#	C
SL90100	66716		1"	5	25	2.93#	C
SL90125	66742		1-1/4"	5	5	4.10#	C
SL90150	66743		1-1/2"	2	2	2.36#	C
SL90200	66745		2"	2	2	3.48#	C
SL38I	66717		3/8"	25	125	2.93#	C
SL50I	66718		1/2"	25	125	3.09#	C
SL75I	66720	Straight Insulated	3/4"	10	50	2.08#	C
SL100I	66722		1"	5	25	1.47#	C
SL125I	66744		1-1/4"	5	25	2.33#	C
SL150I	66746		1-1/2"	5	5	2.93#	C
SL200I	66748		2"	5	5	4.25#	C
SL250I	81623	2-1/2"	1	1	2.60#	C	
SL300I	81624	3"	1	1	3.60#	C	
SL350I	81625	3-1/2"	1	1	4.45#	C	
SL400I	81626	4"	1	1	5.20#	C	
SL4538I	66723		3/8"	10	50	1.99#	C
SL4550I	66724		1/2"	10	50	2.23#	C
SL4575I	66726	45° Insulated	3/4"	10	50	3.08#	C
SL45100I	66728		1"	5	25	2.67#	C
SL45125I	66729		1-1/4"	5	5	3.27#	C
SL45150I	66731		1-1/2"	2	2	1.79#	C
SL45200I	66733		2"	2	2	2.92#	C
SL45250I	81627	2-1/2"	1	1	4.78#	C	
SL45300I	81628	3"	1	1	7.75#	C	
SL45350I	81629	3-1/2"	1	1	8.80#	C	
SL45400I	81630	4"	1	1	10.00#	C	
SL9038I	66735		3/8"	10	50	2.37#	C
SL9050I	66730		1/2"	10	50	2.37#	C
SL9075I	66732	90° Insulated	3/4"	10	50	3.62#	C
SL90100I	66734		1"	5	25	3.37#	C
SL90125I	66749		1-1/4"	5	5	4.42#	C
SL90150I	66747		1-1/2"	2	2	2.00#	C
SL90200I	66751		2"	2	2	3.65#	C
SL90250I	81631	2-1/2"	1	1	6.25#	C	
SL90300I	81632	3"	1	1	9.00#	C	
SL90350I	81633	3-1/2"	1	1	10.00#	C	
SL90400I	81634	4"	1	1	15.00#	C	

NEW

NEW

NEW



Weathertight Hubs PC 5462

Weathertight hubs are used to terminate rigid conduit or IMC into an enclosure.

- UL Listed
- Die Cast From High Strength Zinc Alloy
- With or Without Lugs
- Sealing Ring
- 105° Rated Throat Insulator

CAT NO	UPC	SIZE	STD	MSTR	WT/STD	UNIT
WTH50	60255	1/2"	10	100	1.85#	C
WTH75	60256	3/4"	10	100	2.62#	C
WTH100	60257	1"	10	100	3.96#	C
WTH125	60258	1-1/4"	5	50	2.72#	C
WTH150	60259	1-1/2"	5	50	3.62#	C
WTH200	60260	2"	2	20	1.94#	C
WTH250	60261	2-1/2"	1	5	1.79#	C
WTH300	60262	3"	1	5	2.23#	C
WTH350	60263	3-1/2"	1	5	2.74#	C
WTH400	60264	4"	1	5	2.80#	C

Grounding Lug

WTHGL50	60270	1/2"	10	100	2.02#	C
WTHGL75	60271	3/4"	10	100	2.78#	C
WTHGL100	60272	1"	10	100	4.00#	C
WTHGL125	60273	1-1/4"	5	50	2.68#	C
WTHGL150	60274	1-1/2"	5	50	3.65#	C
WTHGL200	60275	2"	2	20	2.02#	C
WTHGL250	60276	2-1/2"	1	5	1.79#	C
WTHGL300	60277	3"	1	5	2.26#	C
WTHGL350	60278	3-1/2"	1	5	2.74#	C
WTHGL400	60279	4"	1	5	2.80#	C



No Thread Connectors & Couplings PC 5530

No thread connectors are used to connect rigid conduit to an enclosure. The connectors and couplings are raintite and approved for direct burial.

- UL-CSA Listed
- Zinc Plated Steel
- For Rigid Conduit
- Non Insulated & Insulated

CAT NO	UPC	SIZE	STD	MSTR	WT/STD	UNIT
Connectors						
NT50	66750	1/2"	25	125	2.95#	C
NT75	66752	3/4"	25	125	4.49#	C
NT100	66754	1"	10	50	3.06#	C
NT125	66756	1-1/4"	10	50	4.22#	C
NT150	66758	1-1/2"	5	25	2.83#	C
NT200	66780	2"	5	25	3.54#	C

NT50I	66760	1/2"	25	125	3.09#	C
NT75I	66762	3/4"	25	125	4.54#	C
NT100I	66764	1"	10	50	3.08#	C
NT125I	66766	1-1/4"	10	50	4.36#	C
NT150I	66768	1-1/2"	5	25	2.87#	C
NT200I	66782	2"	5	25	3.87#	C
NT250I	81635	2-1/2"	5	5	12.10#	C
NT300I	81636	3"	3	3	9.21#	C
NT350I	81637	3-1/2"	2	2	11.70#	C
NT400I	61638	4"	2	2	9.84#	C

Couplings						
NTC50	66770	1/2"	25	125	3.82#	C
NTC75	66772	3/4"	25	125	6.00#	C
NTC100	66774	1"	15	75	5.52#	C
NTC125	66776	1-1/4"	5	25	2.72#	C
NTC150	66778	1-1/2"	5	25	3.46#	C
NTC200	66784	2"	5	25	4.43#	C
NTC250	81639	2-1/2"	5	5	18.00#	C
NTC300	81640	3"	3	3	12.15#	C
NTC350	81641	3-1/2"	2	2	10.90#	C
NTC400	81642	4"	2	2	12.70#	C

NEW

NEW

Insulated Ground Bushings - Feed Through Lugs PC 5590



- Insulated Ground Bushings
- UL Listed
- Die Cast
- Feed Through
- Cu/Al (Copper/Aluminum)

Ground bushings with feed through lugs are used to terminate threaded rigid conduit or IMC to an enclosure. A 90° C Cu/Al dual rated feed through lug is provided for grounding jumper to neutral bus bar.

CAT NO	UPC	SIZE	RANGE	STD	MSTR	WT/STD	UNIT
GB50	10300	1/2"	14 Sol to 4 Str	25	250	1.68#	C
GB75	10305	3/4"	14 Sol to 4 Str	25	250	1.99#	C
GB100	10310	1"	14 Sol to 4 Str	25	250	2.50#	C
GB125	10315	1-1/4"	14 Sol to 4 Str	25	250	2.97#	C
GB150	10320	1-1/2"	14 Sol to 2 Str	25	250	3.63#	C
GB200	10325	2"	14 Sol to 2 Str	10	100	1.81#	C
GB250	10330	2-1/2"	14 Sol to 1/0 Str	5	50	1.69#	C
GB300	10335	3"	14 Sol to 1/0 Str	5	50	2.00#	C
GB350	10340	3-1/2"	14 Sol to 2/0 Str	2	20	2.40#	C
GB400	10345	4"	14 Sol to 2/0 Str	2	20	2.78#	C

Insulated Ground Bushings - Lay In Lugs PC 5600



- Insulated Ground Bushings
- UL Listed
- Die Cast
- Lay in Lug
- Cu/Al (Copper/Aluminum)

Ground bushings with lay-in lugs are used to terminate threaded rigid conduit or IMC to an enclosure. A 90° C Cu/Al dual rated lay in lug is provided for grounding jumper to neutral bus bar.

CAT NO	UPC	SIZE	RANGE	STD	MSTR	WT/STD	UNIT
GBL50	10400	1/2"	14 Sol to 4 Str	25	250	1.87#	C
GBL75	10405	3/4"	14 Sol to 4 Str	25	250	2.11#	C
GBL100	10410	1"	14 Sol to 4 Str	25	250	2.48#	C
GBL125	10415	1-1/4"	14 Sol to 4 Str	25	250	3.09#	C
GBL150	10420	1-1/2"	14 Sol to 2 Str	25	250	4.12#	C
GBL200	10425	2"	14 Sol to 2 Str	10	100	1.94#	C
GBL250	10430	2-1/2"	14 Sol to 1/0 Str	5	50	1.86#	C
GBL300	10435	3"	14 Sol to 1/0 Str	5	50	2.19#	C
GBL350	10440	3-1/2"	14 Sol to 1/0 Str	2	20	1.09#	C
GBL400	10445	4"	14 Sol to 1/0 Str	2	20	1.17#	C

Ground Rods (Copper Bonded) PC 5610



- UL Listed
- Copper Bonded
- Caution! Always Wear Eye Protection

Ground rods are available in 1/2", 5/8" and 3/4" diameters and in 8' and 10' lengths. The copper exterior is molecularly bonded to nickel sealed, high strength steel cores. Copper jacket plating thickness exceeds UL & ANSI specs of .010".

CAT NO	UPC	SIZE	STD	MSTR	WT/STD	UNIT
GR1208	35005	1/2 x 8'	10	100	50.00#	Ea
GR1210	35010	1/2 x 10'	10	100	63.00#	Ea
GR5808	35015	5/8 x 8'	10	100	69.50#	Ea
GR5810	35020	5/8 x 10'	10	100	86.00#	Ea
GR3408	35025	3/4 x 8'	5	50	49.75#	Ea
GR3410	35030	3/4 x 10'	5	50	63.75#	Ea

Ground Rod Driver PC 6550



- No Need For Ladders Or Sledge Hammers!
- Caution! Always Wear Eye Protection

Install ground rod from ground level. Sliding action drives rod without need of hammer. Driver will not deform end of rod. Heavy duty construction provides maximum driving forces, while soft rubber ergonomic grip provides user comfort.

CAT NO	UPC	DESCRIPTION	STD	MSTR	WT/STD	UNIT
GRD58	24101	5' Driver with insert for 5/8" Ground Rod	1	1	22.34#	Ea
GRD34	24102	5' Driver with insert for 3/4" Ground Rod	1	1	22.13#	Ea
Insert Only						
GRDI58	24103	Insert only for 5/8" Ground Rod	1	1	5.73#	Ea
GRDI34	24104	Insert only for 3/4" Ground Rod	1	1	5.63#	Ea

See new products at Ihdottie.com

Dottie

C19

FITTINGS & STAMPINGS > INSULATED GROUND BUSHINGS > GROUND RODS > GROUND ROD DRIVER



Bare Ground Clamps PC 5560

Bare ground clamps are used to connect bare copper wire to water pipe, rebar, ground rod or copper water tubing for grounding. Fittings are UL listed and cast from high strength, highly conductive copper alloy with steel, brass or bronze screws.

- UL Listed
- Pressure Cast or Bronze
- Bonding or Grounding
- With Steel, Stainless Steel, Brass or Bronze Screws

CAT NO	UPC	WIRE RANGE	DESCRIPTION	SCREW TYPE	PIPE SIZE	STD	MSTR	WT/STD	UNIT
20B*	10005	8 Sol to 2 Str	Prsr Cast Brs Plated	Steel	1/2 to 1"	25	250	3.83#	C
20M	10010	8 Sol to 2 Str	Prsr Cast Mlbl Finish	Steel	1/2 to 1"	25	250	4.40#	C
25	10015	10 Sol to 2 Str	Bronze	Steel	1/2 to 1"	25	250	4.48#	C
DB25	67500	10 Sol to 2 Str	Bronze Direct Burial	Bronze	1/2 to 1"	25	250	4.79#	C
DLI25	28090	10 Sol to 2 Str	Bronze Direct Burial Lay in Feature	Stainless Steel	1/2 to 1"	25	250	4.79#	C
DB25 and DLI25 Approved For Steel 4/6/8 Rebar									
DB2538	67503	10 Sol to 2 Str	Bronze Direct Burial	Bronze	1/2 to 1"	25	250	4.45#	C
DB2538 Dual Rated Suitable For Pipe or Steel Rebar 3/8 to 1" (#3 - #8). Accommodates Steel Rebar Without Disassembly									
PL25	56470	10 Sol to 2 Str	Bronze	Brass	1/2 to 1"	25	250	4.85#	C
27	10025	10 Sol to 2 Str	Bronze	Steel	1-1/4 to 2"	5	50	2.18#	C
DB27	67502	10 Sol to 2 Str	Bronze Direct Burial	Bronze	1-1/4 to 2"	5	50	2.13#	C
DLI27	28092	10 Sol to 2 Str	Bronze Direct Burial Lay in Feature	Stainless Steel	1-1/4 to 2"	5	50	2.13#	C
1001	10027	10 Sol to 2 Str	Bronze	Steel	2-1/2 to 4"	5	5	5.07#	C
1002	10028	10 Sol to 2 Str	Bronze	Steel	4-1/2 to 6"	5	5	9.12#	C

* Non UL Approved



Armored Ground Clamps PC 5560

Used to connect armored cable to water pipe for grounding. Special pressure bar grips armored cable insulation to decrease chances of grounding conductor being pulled out. Cast from high strength, highly conductive copper alloy.

- UL Listed
- Pressure Cast or Bronze
- Bonding or Grounding
- With Steel or Stainless Steel Screws

CAT NO	UPC	WIRE RANGE	DESCRIPTION	SCREW TYPE	PIPE SIZE	STD	MSTR	WT/STD	UNIT
21B*	10030	8 Sol to 4 Str	Prsr Cast Brs Plated	Steel	1/2 to 1"	25	250	5.09#	C
21M	10035	8 Sol to 4 Str	Prsr Cast Mlbl Finish	Steel	1/2 to 1"	25	250	5.09#	C
26	10040	8 Sol to 4 Str	Bronze	Steel	1/2 to 1"	25	250	5.83#	C
DLI26	28091	8 Sol to 4 Str	Bronze Lay in Feature	Stainless Steel	1/2 to 1"	25	250	5.63#	C
26SWV	10042	10 Sol to 6 Str	Bronze Swivel Type	Steel	1/2 to 1"	25	125	9.33#	C
26SWV Includes a pressure bar that swings 360° for easy adjustment									
28	10045	8 Sol to 4 Str	Bronze	Steel	1-1/4 to 2"	25	250	11.63#	C
28SWV	10046	10 Sol to 6 Str	Bronze swivel Type	Steel	1-1/4 to 2"	5	5	3.05#	C
28SWV Includes a pressure bar that swings 360° for easy adjustment									
1102*	10047	8 Sol to 4 Str	Bronze	Steel	2-1/2 to 4"	5	5	6.60#	C
1103*	11048	8 Sol to 4 Str	Bronze	Steel	4-5-6"	5	5	9.92#	C

* Non UL Approved



Ground Clamps With Hubs PC 5560

- UL Listed
- Bronze
- With 1/2", 3/4" or 1" Hubs

Ground clamps with hubs are used to connect grounding conductor in conduit to water pipe for grounding. Cast from high strength, highly conductive copper alloy with steel or bronze screws.

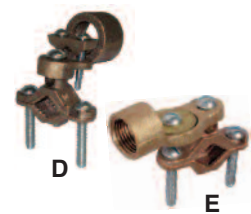

CAT NO	UPC	PHOTO	WIRE RANGE	HUB SIZE	PIPE SIZE	STD	MSTR	WT/STD	UNIT
29L	10051	E	10-6	1/2"	1/2 to 1"	25	125	9.80#	C
29BRZ	10054	E	10-6	1/2"	1/2 to 1"	25	125	10.06#	C
30L	10053	D	10-2/0	3/4"	1/2 to 1"	25	125	11.35#	C
31L	10056	D	10-3/0	1"	1/2 to 1"	25	125	12.33#	C
270L	10057	E	10-6	1/2"	1-1/4 to 2"	25	25	14.87#	C
271L	10059	D	10-2/0	3/4"	1-1/4 to 2"	25	25	16.63#	C
272L	10061	D	10-3/0	1"	1-1/4 to 2"	25	25	17.44#	C
280L	10063	E	10-6	1/2"	2-1/2 to 4"	5	5	6.23#	C
281L	10064	D	10-2/0	3/4"	2-1/2 to 4"	5	5	6.63#	C
282L	10066	D	10-3/0	1"	2-1/2 to 4"	5	5	6.64#	C

All clamps provided with steel screws except 29BRZ (bronze screws)

Ground Rod Clamps PC 5570

- UL Listed
- Direct Burial
- Bronze
- With Bronze Hex Head Bolt

Ground rod clamps are used to connect conductor to a driven ground rod. Cast from high strength, highly conductive copper alloy, they are approved for direct burial in ground and concrete and are assembled with a bronze hex head bolt.



CAT NO	UPC	SIZE	GROUND WIRE	STD	MSTR	WT/STD	UNIT
GR12	10500	1/2"	10 Sol to 2 Str	50	250	8.83#	C
GR58	10505	5/8"	10 Sol to 2 Str	50	250	4.65#	C
GR34	10510	3/4"	10 Sol to 2 Str	25	100	2.96#	C

Ground Rod Clamps - Universal PC 5570

- UL Listed
- Direct Burial
- Stainless Steel
- One Size Fits All

Universal Ground Rod Clamp is UL Listed for all sizes of Ground Rods and Rebar. Constructed of Stainless Steel Alloy and a High Performance Stainless Steel Bolt. For direct Burial in Earth or Concrete.



CAT NO	UPC	ROD SIZES	WIRE RANGE	STD	MSTR	WT/STD	UNIT
UGRCS	83180	3/8"	10 Sol - 1/0 Str	50	250	4.65#	C
		1/2"	10 Sol - 1/0 Str				
		5/8"	10 Sol - 1/0 Str				
		3/4"	8 Sol - 1/0 Str				



Hubs PC 5580

- UL Listed
- Bronze

Hubs are used with ground clamps to connect rigid conduit to water pipe for grounding. 360° swing type hub provides flexibility. They are cast from high strength, highly conductive copper alloy with zinc plated screws.

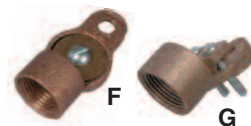

CAT NO	UPC	SIZE	PHOTO	GROUND WIRE	STD	MSTR	WT/STD	UNIT
HUB50L	10171	1/2"	F	10 Sol to 6 Str	25	250	5.04#	C
HUB75L	10176	3/4"	G	10 Sol to 2/0 Str	25	250	7.23#	C
HUB100L	10181	1"	G	10 Sol to 3/0 Str	10	100	3.00#	C



Now With Multi-Drive

Ground Screws PC 5620

Ground screws are plated green for identification purposes and are used for grounding pigtails or wire. They have either a 1/4" or 5/16" head with Hex/Slotted/Phillips/Square drive. The 1/4" (1032G & 1032GTP) has a leader point; the 5/16" (1032TC & 1032TCTP) has a thread cutting point.

- Steel
- Green Zinc Plated
- 1/4" or 5/16" Head
- Leader or Thread Cutting Point
- Hex/Slotted/Phillips/Square

CAT NO	UPC	DESCRIPTION	HEX SIZE	SCREW SIZE	STD	MSTR	WT/STD	UNIT
1032G	14107	Leader Point Hex/Slotted/Phillips/Square	1/4"	10-32 x 3/8"	100	1000	0.44#	C
1032GTP	14108	Tuff Pack	1/4"	10-32 x 3/8"	500	3000	4.20#	C
1032TC	14109	Thread Cutting Pt. Hex/Slotted/Phillips/Square	5/16"	10-32 x 3/8"	100	1000	0.50#	C
1032TCTP	14111	Tuff Pack	5/16"	10-32 x 3/8"	500	3000	4.86#	C



Now With Multi-Drive

Ground Pigtails PC 5630

Ground pigtails are used for grounding receptacles to steel boxes.

- Green Zinc Plated Ground Screw
- UL Listed Wire
- Green #12 Ga. Solid Copper Wire
- 7-1/2", 10-1/2" or 12-1/2" Lengths
- 1/4" Hex/Slotted/Phillips/Square with (Leader Point)

CAT NO	UPC	SIZE	GAUGE	STD	MSTR	WT/STD	UNIT
GP650	16100	7-1/2"	12 Ga	250	2000	4.90#	C
GP1050	16102	10-1/2"	12 Ga	250	2000	6.56#	C
GP1250	16103	12-1/2"	12 Ga	250	1000	7.44#	C



Ground Clips PC 5640

Ground Clips are intended to be pressed on the top edge of a box to hold a No.10, 12, or 14AWG copper or No.10, or 12AWG aluminum grounding conductor against the side wall. This clip may be used for connecting the grounding conductor of nonmetallic sheathed cable to outlet boxes or for connecting the grounding jumper from a receptacle to an outlet.

- UL Listed
- Zinc Plated
- Holds 10, 12, or 14 Ga. Copper Wire
- Holds 10, or 12 Ga. Aluminum Wire

CAT NO	UPC	STD	MSTR	WT/STD	UNIT
GC	27050	100	1000	0.38#	C
GCTP	27051	Tuff Pack	500	3000	1.90#



Copper Crimp Sleeves PC 5650

Copper Crimp Sleeves are used to group and terminate copper wires and provide a vibration resistant connection. Copper requires crimping pressure and resists corrosion.

- UL Listed
- Solid Copper
- 18 to 10 Ga. Wire
- 18 to 8 Ga. Wire

CAT NO	UPC	WIRE GAUGE	STD	MSTR	WT/STD	UNIT
CS410	27755	18-10 AWG	100	1000	0.24#	C
CS410TP	27756	Tuff Pack	500	3000	1.15#	C
CS411	27760	18-8 AWG	50	500	0.24#	C

Entrance Caps PC 5690



- UL Listed
- Die Cast Copper Free Aluminum
- Phenolic Insulator
- Clamp On Style
- Weather Resistant

Clamp on service entrance caps permit a weather resistant entrance for type SE cable on rigid, IMC or EMT for pulling service drop conductors. They are assembled with an electrical grade Phenolic insulator with multiple holes.

CAT NO	UPC	SIZE	STD	MSTR	WT/STD	UNIT
EC50	40005	1/2"	25	25	6.21#	C
EC75	40010	3/4"	25	25	7.18#	C
EC100	40015	1"	25	25	8.97#	C
EC125	40020	1-1/4"	10	10	4.89#	C
EC150	40025	1-1/2"	10	10	7.56#	C
EC200	40030	2"	5	5	6.09#	C
EC250	40035	2-1/2"	1	1	3.83#	C
EC300	40040	3"	1	1	5.43#	C
EC350	40045	3-1/2"	1	1	6.47#	C
EC400	40050	4"	1	1	6.78#	C

Entrance Ells (SLB) PC 5700



- UL Listed
- Die Cast Copper Free Aluminum
- Assembled with Fiber Gasket & Aluminum Cover
- Weather Resistant

Service Entrance Ells are used with threaded rigid conduit or IMC for providing access to the interior of a conduit system for pulling, splicing, inspection and maintenance.

CAT NO	UPC	SIZE	STD	MSTR	WT/STD	UNIT
SLB50	40100	1/2"	10	100	2.01#	C
SLB75	40105	3/4"	10	100	2.60#	C
SLB100	40110	1"	5	50	2.15#	C
SLB125	40115	1-1/4"	5	50	3.76#	C
SLB150	40120	1-1/2"	2	20	1.83#	C
SLB200	40125	2"	2	10	2.69#	C

Pulling Ells PC 5710



- UL Listed
- Die Cast
- High Strength Zinc Alloy
- Removable Aluminum Cover & Neoprene Gasket

Pulling Ells are used to connect two lengths of threaded rigid conduit or IMC to form a 90° bend and provide access for wire pulling.

CAT NO	UPC	SIZE	STD	MSTR	WT/STD	UNIT
PE1	40130	1/2"	10	100	1.89#	C
PE2	40135	3/4"	10	100	2.69#	C
PE3	40140	1"	5	25	2.50#	C



Threaded Conduit Bodies PC 5730

Threaded Conduit Bodies are used with rigid conduit to provide access to the interior of a conduit system. They are available as bodies only, or as bodies assembled with covers and gaskets. The flat back design allows the unit to be mounted close to the wall. They are die cast from high strength, copper free aluminum.

- UL Listed
- Die Cast Copper Free Aluminum
- Without Covers
- Without Gaskets

CAT NO	UPC		SIZE	STD	MSTR	WT/STD	UNIT
LB50	40400		1/2"	10	100	2.98#	C
LB75	40405		3/4"	10	50	4.41#	C
LB100	40410		1"	5	25	3.15#	C
LB125	40415		1-1/4"	2	10	2.63#	C
LB150	40420		1-1/2"	2	10	2.94#	C
LB200	40425	LB	2"	1	5	2.46#	C
LB250	40430		2-1/2"	1	1	4.71#	C
LB300	40435		3"	1	1	5.40#	C
LB350	40440		3-1/2"	1	1	8.32#	C
LB400	40445		4"	1	1	8.50#	C
LR50	40600		1/2"	10	100	2.52#	C
LR75	40605		3/4"	10	50	4.58#	C
LR100	40610		1"	5	25	3.12#	C
LR125	40615		1-1/4"	2	10	2.89#	C
LR150	40620		1-1/2"	2	10	3.15#	C
LR200	40625	LR	2"	1	5	2.59#	C
LR250	40630		2-1/2"	1	1	6.13#	C
LR300	40635		3"	1	1	9.02#	C
LR350	40640		3-1/2"	1	1	10.24#	C
LR400	40645		4"	1	1	9.60#	C
LL50	40550		1/2"	10	100	2.48#	C
LL75	40555		3/4"	10	50	4.50#	C
LL100	40560		1"	5	25	3.13#	C
LL125	40565		1-1/4"	2	10	2.47#	C
LL150	40570		1-1/2"	2	10	2.98#	C
LL200	40575	LL	2"	1	5	2.61#	C
LL250	40580		2-1/2"	1	1	4.69#	C
LL300	40585		3"	1	1	6.44#	C
LL350	40590		3-1/2"	1	1	9.13#	C
LL400	40595		4"	1	1	9.22#	C
C50	40700		1/2"	10	100	2.44#	C
C75	40705		3/4"	10	50	4.17#	C
C100	40710		1"	5	25	2.42#	C
C125	40715		1-1/4"	2	10	3.16#	C
C150	40720		1-1/2"	2	10	2.84#	C
C200	40725	C	2"	1	5	2.55#	C
C250	40730		2-1/2"	1	1	5.25#	C
C300	40735		3"	1	1	5.72#	C
C350	40740		3-1/2"	1	1	9.51#	C
C400	40745		4"	1	1	9.00#	C
T50	40800		1/2"	10	100	2.99#	C
T75	40805		3/4"	10	50	4.43#	C
T100	40810		1"	5	25	3.27#	C
T125	40815		1-1/4"	2	10	3.76#	C
T150	40820		1-1/2"	2	10	3.29#	C
T200	40825	T	2"	2	2	5.38#	C
T250	40830		2-1/2"	1	1	5.77#	C
T300	40835		3"	1	1	6.35#	C
T350	40840		3-1/2"	1	1	11.30#	C
T400	40845		4"	1	1	9.70#	C



- UL Listed
- Die Cast Copper Free Aluminum
- With Covers
- With Neoprene Gaskets

Threaded Conduit Bodies with cover and gasket are used with rigid conduit to provide access to the interior of a conduit system. They are available as bodies only, or as bodies assembled with covers and gaskets. The flat back design allows the unit to be mounted close to the wall. They are die cast from high strength, copper free aluminum.

CAT NO	UPC		SIZE	STD	MSTR	WT/STD	UNIT
LB50CG	10722		1/2"	10	100	2.93#	C
LB75CG	10724		3/4"	10	50	4.10#	C
LB100CG	10726		1"	5	25	3.58#	C
LB125CG	10728		1-1/4"	2	10	2.96#	C
LB150CG	10730		1-1/2"	2	10	3.25#	C
LB200CG	10732	LB	2"	1	5	2.80#	C
LB250CG	10734		2-1/2"	1	1	5.10#	C
LB300CG	10736		3"	1	1	6.20#	C
LB350CG	10738		3-1/2"	1	1	9.54#	C
LB400CG	10740		4"	1	1	10.09#	C
LR50CG	10762		1/2"	10	100	2.98#	C
LR75CG	10764		3/4"	10	50	5.21#	C
LR100CG	10766		1"	5	25	3.62#	C
LR125CG	10768		1-1/4"	2	10	3.06#	C
LR150CG	10770		1-1/2"	2	10	3.33#	C
LR200CG	10772	LR	2"	1	5	2.80#	C
LR250CG	10774		2-1/2"	1	1	6.43#	C
LR300CG	10776		3"	1	1	9.60#	C
LR350CG	10778		3-1/2"	1	1	11.39#	C
LR400CG	10780		4"	1	1	12.00#	C
LL50CG	10742		1/2"	10	100	3.00#	C
LL75CG	10744		3/4"	10	50	5.17#	C
LL100CG	10746		1"	5	25	3.52#	C
LL125CG	10748		1-1/4"	2	10	2.93#	C
LL150CG	10750		1-1/2"	2	10	3.22#	C
LL200CG	10752	LL	2"	1	5	2.84#	C
LL250CG	10754		2-1/2"	1	1	5.26#	C
LL300CG	10756		3"	1	1	7.02#	C
LL350CG	10758		3-1/2"	1	1	10.35#	C
LL400CG	10760		4"	1	1	10.80#	C
C50CG	10702		1/2"	10	100	2.82#	C
C75CG	10704		3/4"	10	50	4.79#	C
C100CG	10706		1"	5	25	2.87#	C
C125CG	10708		1-1/4"	2	10	2.88#	C
C150CG	10710		1-1/2"	2	10	2.90#	C
C200CG	10712	C	2"	1	5	2.65#	C
C250CG	10714		2-1/2"	1	1	5.67#	C
C300CG	10716		3"	1	1	6.28#	C
C350CG	10718		3-1/2"	1	1	9.90#	C
C400CG	10720		4"	1	1	10.35#	C
T50CG	10782		1/2"	10	100	3.80#	C
T75CG	10784		3/4"	10	50	4.25#	C
T100CG	10786		1"	5	25	3.63#	C
T125CG	10788		1-1/4"	2	10	4.03#	C
T150CG	10790		1-1/2"	2	10	3.55#	C
T200CG	10792	T	2"	2	2	5.85#	C
T250CG	10794		2-1/2"	1	1	7.06#	C
T300CG	10796		3"	1	1	7.63#	C
T350CG	10798		3-1/2"	1	1	12.52#	C
T400CG	10802		4"	1	1	10.95#	C
TB50CG	81526		1/2"	10	100	3.80#	C
TB75CG	81527		3/4"	10	50	4.25#	C
TB100CG	81528	TB	1"	5	25	3.63#	C
TB125CG	81529		1-1/4"	2	10	4.03#	C
TB150CG	81530		1-1/2"	2	10	3.55#	C
TB200CG	81531		2"	2	2	5.85#	C
X50CG	81532		1/2"	10	100	3.80#	C
X75CG	81533		3/4"	10	50	4.25#	C
X100CG	81534	X	1"	5	25	3.63#	C
X125CG	81535		1-1/4"	2	10	4.03#	C
X150CG	81536		1-1/2"	2	10	3.55#	C
X200CG	81537		2"	2	2	5.85#	C





Malleable Conduit Bodies PC 5731

- Tapered Thread
- Suitable For Use In Concrete
- Zinc Plated Aluminum Enameled

Malleable Threaded Conduit bodies are used with rigid conduit to provide access to the interior of a conduit system.

CAT NO	UPC	SIZE	STD	MSTR	WT/STD	UNIT
LB50M	81538	1/2"	10	100	7.06#	C
LB75M	81539	3/4"	10	50	9.67#	C
LB100M	81540	1"	5	25	7.13#	C
LB125M	81541	1-1/4"	2	10	5.75#	C
LB150M	81542	1-1/2"	2	10	6.63#	C
LB200M	81543	LB 2"	1	5	5.34#	C
LB250M	81544	2-1/2"	1	1	11.05#	C
LB300M	81545	3"	1	1	11.60#	C
LB350M	81546	3-1/2"	1	1	19.89#	C
LB400M	81547	4"	1	1	20.99#	C
LR50M	81568	1/2"	10	100	7.63#	C
LR75M	81569	3/4"	10	50	9.74#	C
LR100M	81570	1"	5	25	6.90#	C
LR125M	81571	1-1/4"	2	10	6.18#	C
LR150M	81572	1-1/2"	2	10	6.63#	C
LR200M	81573	LR 2"	1	5	4.97#	C
LR250M	81574	2-1/2"	1	1	11.05#	C
LR300M	81575	3"	1	1	14.36#	C
LR350M	81576	3-1/2"	1	1	23.20#	C
LR400M	81577	4"	1	1	24.31#	C
LL50M	81558	1/2"	10	100	7.63#	C
LL75M	81559	3/4"	10	50	9.74#	C
LL100M	81560	1"	5	25	6.90#	C
LL125M	81561	1-1/4"	2	10	6.18#	C
LL150M	81562	1-1/2"	2	10	6.63#	C
LL200M	81563	LL 2"	1	5	4.97#	C
LL250M	81564	2-1/2"	1	1	11.05#	C
LL300M	81565	3"	1	1	14.36#	C
LL350M	81566	3-1/2"	1	1	23.20#	C
LL400M	81567	4"	1	1	24.31#	C
C50M	81548	1/2"	10	100	9.82#	C
C75M	81549	3/4"	10	50	11.84#	C
C100M	81550	1"	5	25	8.48#	C
C125M	81551	1-1/4"	2	10	6.18#	C
C150M	81552	1-1/2"	2	10	7.36#	C
C200M	81553	C 2"	1	5	5.52#	C
C250M	81554	2-1/2"	1	1	12.15#	C
C300M	81555	3"	1	1	14.36#	C
C350M	81556	3-1/2"	1	1	22.10#	C
C400M	81557	4"	1	1	23.20#	C
T50M	81578	1/2"	10	100	11.15#	C
T75M	81579	3/4"	10	50	13.70#	C
T100M	81580	1"	5	25	9.82#	C
T125M	81581	1-1/4"	2	10	6.63#	C
T150M	81582	1-1/2"	2	10	7.36#	C
T200M	81583	T 2"	1	5	6.63#	C
T250M	81584	2-1/2"	1	1	12.70#	C
T300M	81585	3"	1	1	15.47#	C
T350M	81586	3-1/2"	1	1	25.41#	C
T400M	81587	4"	1	1	25.41#	C
TB50M	81607	1/2"	10	100	8.84#	C
TB75M	81608	3/4"	10	50	11.97#	C
TB100M	81609	1"	5	25	9.86#	C
TB125M	81610	TB 1-1/4"	2	10	3.96#	C
TB150M	81611	1-1/2"	2	10	6.85#	C
TB200M	81612	2"	1	5	6.90#	C
X50M	81588	1/2"	10	100	8.84#	C
X75M	81589	3/4"	5	50	11.97#	C
X100M	81590	1"	2	20	9.86#	C
X125M	81591	X 1-1/4"	2	10	3.96#	C
X150M	81592	1-1/2"	2	10	6.85#	C
X200M	81593	2"	1	5	6.90#	C





- Fiber
- Neoprene

Gaskets are available in fiber or neoprene and are used to make a conduit body weather resistant.

CAT NO	UPC	SIZE	STD	MSTR	WT/STD	UNIT
Fiber Gaskets - PC 5790						
G50	40200	1/2"	50	500	0.36#	C
G75	40205	3/4"	50	500	0.48#	C
G100	40210	1"	50	250	0.64#	C
G125/150	40215	1-1/4 & 1-1/2"	50	100	1.31#	C
G200	40220	2"	25	50	0.98#	C
G250/300	40225	2-1/2 & 3"	25	50	2.30#	C
G350/400	40230	3-1/2 & 4"	25	50	3.10#	C

Neoprene Gaskets - PC 5800

GN50	40250	1/2"	50	500	0.58#	C
GN75	40255	3/4"	50	500	0.78#	C
GN100	40260	1"	50	250	1.00#	C
GN125/150	40265	1-1/4 & 1-1/2"	50	100	2.21#	C
GN200	40270	2"	25	50	1.84#	C
GN250/300	40275	2-1/2 & 3"	25	50	4.60#	C
GN350/400	40280	3-1/2 & 4"	25	50	6.25#	C

**Aluminum Covers
PC 5760**



- UL Listed
- Captive Plated Screws

Aluminum covers are stamped from high strength aluminum and are used with all styles of aluminum conduit bodies.

CAT NO	UPC	SIZE	STD	MSTR	WT/STD	UNIT
BC50	40300	1/2"	50	50	2.40#	C
BC75	40305	3/4"	50	50	3.13#	C
BC100	40310	1"	25	25	2.22#	C
BC125/150	40315	1-1/4 & 1-1/2"	10	10	1.67#	C
BC200	40320	2"	5	5	1.42#	C
BC250/300	40325	2-1/2 & 3"	5	5	4.03#	C
BC350/400	40330	3-1/2 & 4"	5	5	4.12#	C

**Steel Covers
PC 5761**



- Raised Dome
- Captive Stainless Steel Screws
- Zinc Plated

Raised Dome Steel Conduit Body covers are stamped from high strength steel and are used with all style of malleable conduit bodies.

CAT NO	UPC	SIZE	STD	MSTR	WT/STD	UNIT
SC50	81598	1/2"	50	50	4.70#	C
SC75	81599	3/4"	50	50	6.25#	C
SC100	81600	1"	25	25	4.70#	C
SC125/150	81601	1-1/4 & 1-1/2"	10	10	3.13#	C
SC200	81602	2"	5	5	2.50#	C
SC250/300	81603	2-1/2 & 3"	5	5	4.69#	C
SC350/400	81604	3-1/2 & 4"	5	5	6.87#	C



Spider Plate PC 5910

Spider plates are a universal mounting plate which allows mounting fixtures to a 3" or 4" round box regardless of screw hole location.

- Steel
- Universal

CAT NO	UPC	DESCRIPTION	STD	MSTR	WT/STD	UNIT
SP34	42090	Adapts 3-1/4" to 4" boxes	20	20	3.00#	C



Closure Plugs PC 5910

Closure Plugs are used to seal unused holes in weatherproof boxes.

- Weatherproof
- Die Cast

CAT NO	UPC	DESCRIPTION	STD	MSTR	WT/STD	UNIT
TP50	42070	1/2" Threaded Plug	100	1000	0.10#	C
TP75	42075	3/4" Threaded Plug	100	1000	0.20#	C

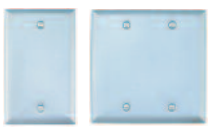

Blank Covers PC 5910

Industrial design provides a durable enclosure for weatherproof box.

- Weatherproof
- Die Cast

CAT NO	UPC	DESCRIPTION	STD	MSTR	WT/STD	UNIT
Blank Covers						
BLC1	42120	With gaskets & Screws	25	250	2.25#	C
Two Gang Blank Box Covers						
BLC2	43060	With gaskets & Screws	10	100	0.90#	C



Bend Saver - EMT Coupling System PC 6253

Never Bend 1/2" & 3/4" EMT again when running EMT into a junction box, standoff design eliminates conduit bending and provides automatic alignment with electrical box knockouts.

- UL Listed
- Steel and Die Cast
- No Offset Required
- Time Saver

CAT NO	UPC	SIZE	DESCRIPTION	STD	MSTR	WT/STD	UNIT
BSCS50	16460	1/2"	Steel Conduit Strap	50	500	1.88#	C
BSCS75	16461	3/4"	Steel Conduit Strap	50	500	2.20#	C
BSDC50	16462	1/2"	Die Cast EMT Coupling	50	500	2.15#	C
BSDC75	16463	3/4"	Die Cast EMT Coupling	50	500	3.45#	C

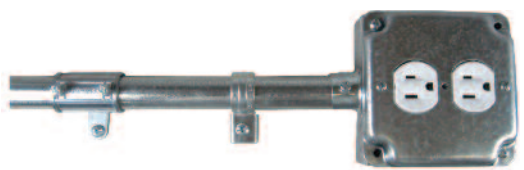

Bend Saver Installed

Quicklock Type Connectors Insulated Throat - PC 5715



QL50 QL75 QL50DUP

- UL Listed
- Tubular Steel
- Combo Screw
- No Locknut Required
- Single or Double
- Zinc Plated

Single unit construction eliminates loose component parts, integral green plastic insulated throat bushing provides maximum protection for insulated wires. For connecting MC, AC, and Flex Cable.

CAT NO	UPC	SIZE	STD	MSTR	WT/STD	UNIT
QL50	11977	1/2" Single	25	250	1.88#	C
QL75	11978	3/4" Single	25	250	3.63#	C
QL50DUP	11979	1/2" Double	20	200	1.02#	C

CABLE TYPE	QL-50 1/2" KO			QL-75 3/4" KO		QL-50DUP** 1/2 KO DUPLEX		
AC Steel	14/2 12/2	14/3 12/3	14/4 12/4	10/4 8/3	10/5 8/4	14/2 12/2	14/3 12/3	14/4 12/4
	10/2 10/3		6/3					
AC Aluminum Interlocked	14/2 12/2	14/3 12/3	14/4 12/4	8/3	10/4 8/4	14/2 12/2	14/3 12/3	14/4 12/4
MC Steel	14/2* 12/2*	14/3* 12/3*	14/4* 12/4*	10/3* 8/2*	10/4 8/3*	14/2 12/2	14/3 12/3	14/4 12/4
	10/2 10/3		6/2*		10/2			
MC Aluminum Interlocked	14/2 12/2	14/3 12/3	14/4 12/4	10/3 8/2	10/4	14/2 12/2	14/3 12/3	14/4 12/4
MC Aluminum	12/2*	14/3 12/3*	14/4 12/4	-	-	-	-	-
	10/2 10/3							
MC Aluminum Flat	12/3			-		-		
Flex RW	3/8 Steel & Al.			1/2 Steel		-		

* Concrete tight when taped and used with PVC jacketed cord. ** Accepts 2 cables of each size listed.

Offset Nipples PC 5540



- UL Listed
- Die Cast
- High Strength Zinc Alloy

Offset Nipples are used to offset the axis of raceways.

CAT NO	UPC	SIZE	STD	MSTR	WT/STD	UNIT
ON50	10600	1/2"	25	250	2.33#	C
ON75	10605	3/4"	20	200	2.48#	C
ON100	10610	1"	10	100	2.11#	C
ON125	10615	1-1/4"	10	100	2.79#	C
ON150	10620	1-1/2"	2	20	0.80#	C
ON200	10625	2"	2	20	1.18#	C

Conduit Nipples PC 5550



- UL Listed
- Die Cast
- High Strength Zinc Alloy

Conduit Nipples are used with a locknut to serve as a short raceway between enclosures.

CAT NO	UPC	SIZE	STD	MSTR	WT/STD	UNIT
CN50	10200	1/2"	100	500	2.97#	C
CN75	10205	3/4"	100	500	5.60#	C
CN100	10210	1"	100	500	7.66#	C
CN125	10215	1-1/4"	25	125	2.77#	C
CN150	10220	1-1/2"	25	125	3.99#	C
CN200	10225	2"	25	125	5.70#	C
CN250	67700	2-1/2"	5	5	2.19#	C
CN300	67702	3"	5	5	2.41#	C
CN350	67704	3-1/2"	5	5	3.71#	C
CN400	67706	4"	5	5	4.02#	C



Multi-Guard Covers PC 5912

"While In-use" weatherproof receptacle cover meets NEC 410-57(b) code. Protection from rain, sleet and snow with cord set plugged in for unattended receptacles. Designed to meet NEC 210-60(b) code.

- UL Listed
- Single & Double Gang
- Weatherproof
- Mounts Vertically or Horizontally

CAT NO	UPC	DESCRIPTION	DEPTH	STD	MSTR	WT/STD	UNIT
Single Gang							
FG1100C	10901	Standard Depth Cover	2-1/4"	1	10	0.45#	Ea
FG1110C	10902	Deep Cover	3-1/8"	1	10	0.49#	Ea

14 Configurations, One Cover
 Single Gang Vertical or Horizontal.
 Includes 3 Patented Inserts
 4 Rounds; Toggle; Duplex;
 GFCI 1-3/8"; 1-5/8"; 1-3/4"; 2-1/8"

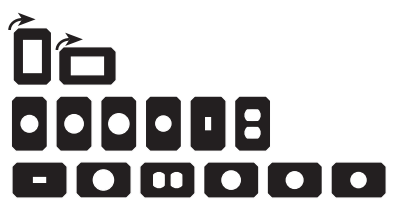

Mounts Vertically or Horizontally
 Plug and Outlet Protection for any Single Gang Application. The standard Depth Cover recommended for 16 gauge or lighter cord sets for vending machines, holiday lighting, landscape lighting and portable signs.

CAT NO	UPC	DESCRIPTION	DEPTH	STD	MSTR	WT/STD	UNIT
Double Gang							
FG1220C	10911	Standard Depth Cover	2-1/4"	1	10	0.55#	Ea

70 Configurations, One Cover
 Any Two Gang Application.
 Includes 6 Snap Together Patented Inserts.

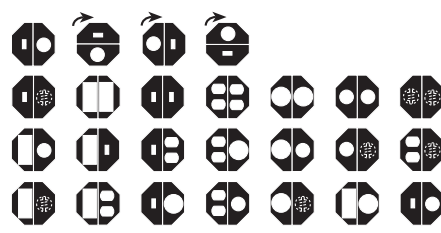

Mounts Vertically or Horizontally
 Plug and Outlet Protection for any Two Gang Application. The standard Depth Cover recommended for 16 gauge or lighter cord sets for vending machines, holiday lighting, landscape lighting and portable signs.

TECH TALK

Plastic In-Use Covers

Flexible and easy to install, "While in Use" Covers are ideal for single-gang, double-gang, horizontal and vertical outdoor applications in a wet location.

- Ensure compliance with Article 406.8(B)(1) of the National Electronic Code which states that 15 and 20 Ampere, 125 and 250 volt receptacles installed in a wet location shall have an enclosure that is weatherproof whether or not the attachment plug cap is inserted.
- Meets UL and CSA Cold Impact Testing at -60°F (-51°C)
- Clear UV Stabilized Polycarbonate Covers for long life in high abuse outdoor installations
- All Covers are shipped with gasket, mounting screws, base and cover assembly and two inserts
- Patented inserts for all wiring devices

