

# Select Series

## Rack Mount PDU with RackLink™

value oriented, intelligent outlet offering that is as versatile as your system and universally controlled

### features:

- Individual IP outlet control of up to 8 outlets
- Full and half-rack form factors
- Multiple IP autoping and recovery ensuring optimal system functionality
- Control start-up or shut-down with remote sequencing
- Easy set-up and control through RackLink user interface
- MOV surge and spike protection
- Automatic notification of connection status
- Seamlessly interfaces with 3rd party AV control systems and cloud platforms for scheduling, control, reporting and customization



RLNK-915R



RLNK-415R



### specifications:

Select Series Rack Mount PDU with RackLink™ Series power management products shall be Middle Atlantic Products model # RLNK-\_15R (refer to chart). Select Series Rack Mount PDU with RackLink power products shall be 1.75"H x \_\_\_"W x 9.67"D (refer to drawing). Select Series Rack Mount PDU with RackLink shall have a 15 amp power capacity. Select Series Rack Mount PDU with RackLink shall provide MOV surge and spike protection. Select Series Rack Mount PDU with RackLink shall provide \_\_\_ total outlets, \_\_\_ of which shall be individually controllable (refer to chart). Select Series Rack Mount PDU with RackLink shall provide sequencing. Select Series Rack Mount PDU with RackLink shall include a 9' power cord. Select Series Rack Mount PDU with RackLink shall monitor specific remote IP devices and services and shall automatically reboot an unresponsive network device and provide alerts via e-mail. Select Series Rack Mount PDU with RackLink shall allow local export of log files in CSV format, and shall allow log files to be extracted to 3rd party databases via IP. Select Series Rack Mount PDU with RackLink shall include an integrated web server for browser-based access and control. Select Series Rack Mount PDU with RackLink shall utilize an open-architecture serial communications protocol that is cloud compliant without being cloud dependent, and provide an API for seamless integration into any IP based architecture. Select Series Rack Mount PDU with RackLink shall be fully compliant with any control system or aggregator. Select Series Rack Mount PDU with RackLink shall be constructed of phosphate pre-treated steel with a black powdercoat finish. Select Series Rack Mount PDU with RackLink shall be manufactured by an ISO 9001 and ISO 14001 registered company. Select Series Rack Mount PDU with RackLink shall be warrantied to be free from defects in materials and workmanship under normal use and conditions for a period of 3 years. Select Series Rack Mount PDU with RackLink shall be listed to UL standard 60950-1 in US and to CAN/CSA C22.2 #60950-1 in Canada and FCC Part 15, Class B.

Customizable specification clips available at [middleatlantic.com](http://middleatlantic.com)



what **great systems** are built on.™

A brand of **legrand**



**Middle Atlantic Products**

[middleatlantic.com](http://middleatlantic.com) | [middleatlantic.ca](http://middleatlantic.ca)

96-01237 / rev b / 5-29-20

# Select Series

## Rack Mount PDU with RackLink™

all dimensions in inches unless otherwise noted [all dimensions in brackets are in millimeters]

### RLNK-415R

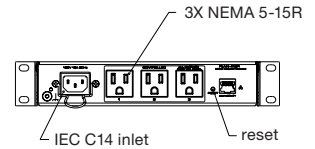
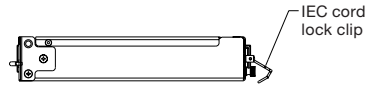
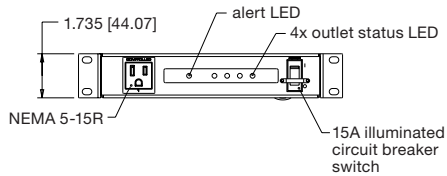
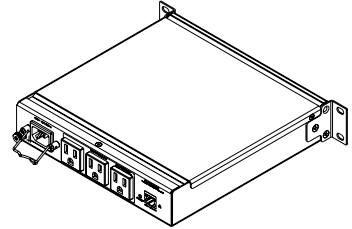
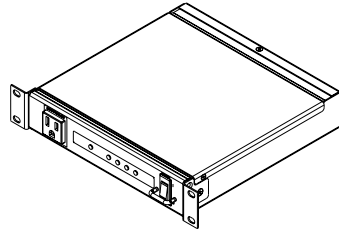
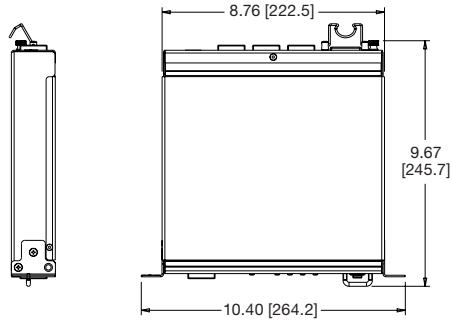

### RLNK-915R

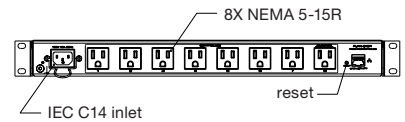
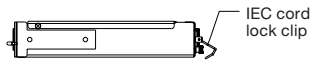
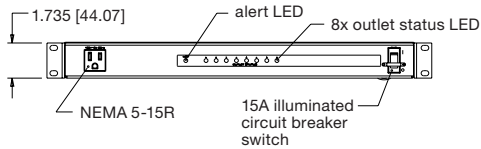
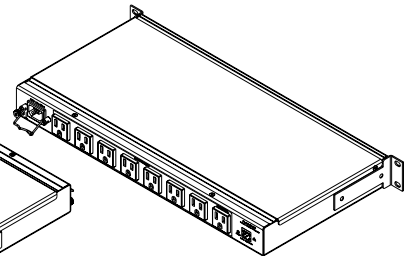
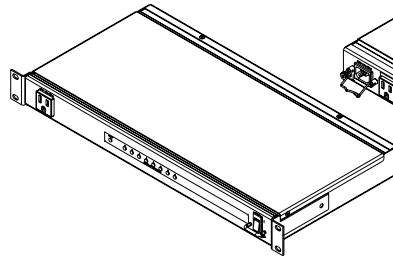
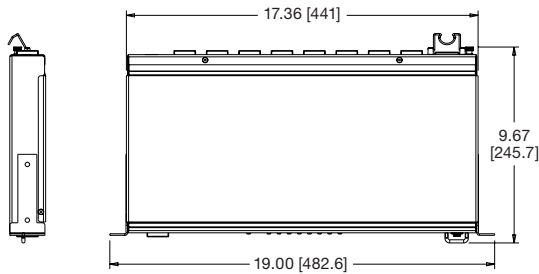

Notes:

1. All outputs 120V 12A total
2. RLNK-415R use cord, IEC, 5-15P, 125V, 10 Ft. L

what **great systems** are built on.™

A brand of **legrand**

**Middle Atlantic Products**

[middleatlantic.com](http://middleatlantic.com) | [middleatlantic.ca](http://middleatlantic.ca)

# Select Series

## Rack Mount PDU with RackLink™

all dimensions in inches unless otherwise noted [all dimensions in brackets are in millimeters]

		RLNK-415R	RLNK-915R
<b>SUMMARY</b>	Form Factor	Half Rackmount	Rackmount
	Max Load	15A	
	Rated Load	12A	
	Surge Protection	basic	
	Sequencing	yes	
	# of Outlets	4 total / 4 controlled	9 total / 8 controlled
	Integrated Web Server	yes	
<b>AC POWER</b>	Connection Type	9 ft. IEC (15A)	
	Line Voltage	Nominal: 120VAC / Minimum: 80VAC / Maximum: 140VAC	
	Maximum Peak Load	15 Amps	
	Maximum Cont.Load	12 Amps	
	No Load Power Dissipation	Less Than 1W Note: Ethernet disconnected, all relays off	
<b>BASIC SURGE SPECIFICATION</b>	Peak Impulse Current (8/20uS Waveform)	12,000 Amps, one time, 9,000 Amps, two times within 5 minutes - Maximum peak impulse current pulse as defined between line and neutral - Maximum multiple impulse current derated per spec	
	Protection Mode	Line to Neutral only; no ground contamination	
	Response Time	Less than 1 nanosecond	
	Surge Energy Dissipation	120 Joules (10 / 100 micro seconds)	
	EMI/RF Supression	>20dB Calculated Line to Neutral - 100kHz to 1Mhz - based on nominal impedance	
<b>REGULATORY APPROVALS</b>	Safety	UL 60950-1 and CSA C22.2 No. 60950-1	
	EMI/RF	FCC Part 15, Class B	
<b>EVENT DRIVEN/ RESPONSES</b>	AutoPing No Response/Recovery	Email and/or Control Outlet	
<b>GENERAL</b>	Operating Temperature Range	32 - 104°F (0-40°C)	
	Humidity Range	0-95% RH, non-condensing	
	Communication	SSL/TLS, SMTP, NTP, DDNS, Cloud, TCP/IP, HTTP (integrated web server)	
	Warranty	3 years limited warranty	

what **great systems** are built on.™

A brand of **legrand**

  
**Middle Atlantic Products**  
 middleatlantic.com | middleatlantic.ca