

The following is a list of accessories and fittings that can be provided with S8A tray. For more information on these items, contact our Engineering Department.

## ● Fittings

### Horizontal Bends

- 30° Bends with 24", 36", or 48" radius
- 45° Bends with 24", 36", or 48" radius
- 60° Bends with 24", 36", or 48" radius
- 90° Bends with 24", 36", or 48" radius

### Horizontal Tees & Crosses

With 24", 36", or 48" radius

### Vertical Outside Bends

- 30° Bends with 24", 36", or 48" radius
- 45° Bends with 24", 36", or 48" radius
- 60° Bends with 24", 36", or 48" radius
- 90° Bends with 24", 36", or 48" radius

### Vertical Inside Bends

- 30° Bends with 24", 36", or 48" radius
- 45° Bends with 24", 36", or 48" radius
- 60° Bends with 24", 36", or 48" radius
- 90° Bends with 24", 36", or 48" radius

### Reducing Fittings

## ● Accessories - (standard hardware is stainless steel Type 316)

**Splice Plate** - 9A-1008

**Expansion Splice Plate** - 9A-1018

**Horizontal Adjustable Splice Plate** - 9A-1038

**Vertical Adjustable Splice Plate** - 9A-1028

**Hold Down Clamps** - 9ZN-1281, 9G-1281, 9A-1281

**Guides** - S9ZN-1202, S9G-1202

**Step Down Splice Plate** -

9A-1048 = 8" to 4"

9A-1051 = 8" to 5"

9A-1050 = 8" to 6"

9A-1078 = 8" to 7"

**Other Accessories Include:**

**Offset Splice Plates**

**Blind Ends**

**Covers** - Standard aluminum cover number with S in front (Example: S807A40)

● Green = Fastest shipped items ● Black = Normal lead-time items ● Red = Normally long lead-time items

All dimensions in parentheses are millimeters unless otherwise specified.

# Series 2, 3, 4, & 5 Aluminum - Accessories

## Wedge Lock Splice Plates

- Furnished in pairs with 1/4" hardware.
- Standard 4-hole pattern.
- Furnished in pairs, with hardware.
- One pair including hardware provided with each section. (Expansion splice quantity subtracted)
- Boxed in pairs with hardware.
- For field installation drill 13/32" hole.

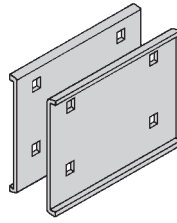

Catalog No.	Height in. mm
● 9A-1004	4 (101)
● 9A-1005	5 (127)
● 9A-1006	6 (152)
● 9A-1007	7 (178)

## H46A, H47A and 57A Mid-Span Splice

- Furnished in pairs with 1/4" hardware.
- Standard for H46A, H47A and 57A straight sections.
- Six bolt design 1/2" Stainless Steel Type 316 hardware standard.
- Available on ladder bottoms only. 09 and 12" rung spacing.
- Furnished in pairs with hardware.

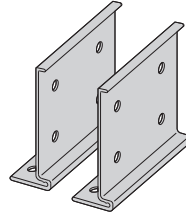

Catalog No.	Tray Series
● 9A-6006	H46A
● 9A-6007	H47A, 57A

## Expansion Splice Plates

- Expansion plates allow for one inch expansion or contraction of the cable tray, or where expansion joints occur in the supporting structure.
- Furnished in pairs with hardware.
- **Bonding Jumpers are required on each siderail. Order Separately.**

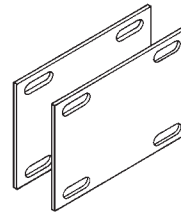

Catalog No.	Height in. mm
● 9A-1014	4 (101)
● 9A-1015	5 (127)
● 9A-1016	6 (152)
● 9A-1017	7 (178)

For heavy duty expansion splice plates see page APP-3.

## Universal Splice Plates

- Furnished in pairs with 1/4" hardware.
- UL Classified.

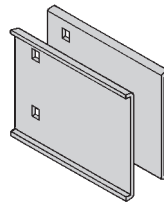

Catalog No.	Height in. mm
● 9A-1004-1/2	4 (101)
● 9A-1005-1/2	5 (127)
● 9A-1006-1/2	6 (152)
● 9A-1007-1/2	7 (178)

## Step Down Splice Plates

- These splice plates are offered for connecting cable tray sections having side rails of different heights.
- Furnished in pairs with hardware.

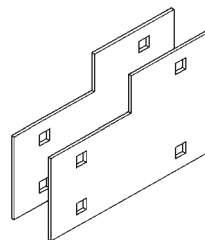

Requires supports within 24" on both sides, per NEMA VE 2.

Catalog No.	Height in. mm
● 9A-1045	5 to 4 (127 to 101)
● 9A-1046	6 to 4 (152 to 101)
● 9A-1060	6 to 5 (152 to 127)
● 9A-1047	7 to 4 (178 to 101)
● 9A-1061	7 to 5 (178 to 127)
● 9A-1062	7 to 6 (178 to 152)

## Vertical Adjustable Splice Plates

- These plates provide for changes in elevation that do not conform to standard vertical fittings.
- Furnished in pairs with hardware.
- Bonding Jumpers not required.

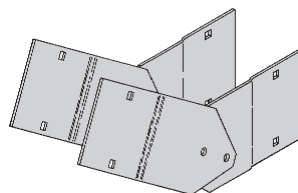

Catalog No.	Height in. mm
● 9A-1024	4 (101)
● 9A-1025	5 (127)
● 9A-1026	6 (152)
● 9A-1027	7 (178)

● Green = Fastest shipped items    ● Black = Normal lead-time items    ● Red = Normally long lead-time items

All dimensions in parentheses are millimeters unless otherwise specified.

## Horizontal Adjustable Splice Plates

- Offered to adjust a cable tray run for changes in direction in a horizontal plane that do not conform to standard horizontal fittings.
- Furnished in pairs with hardware.
- Bonding jumpers **not** required.
- (X) Insert 4, 5, 6 or 7 for side rail height.

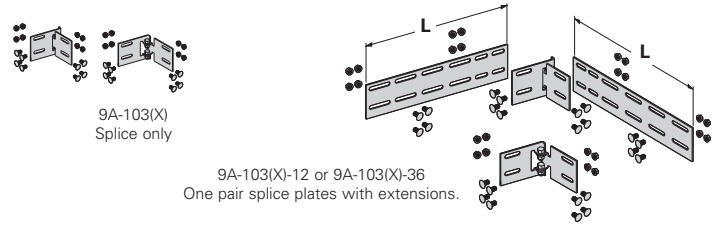

Requires supports within 24" on both sides, per NEMA VE 2.

Catalog No.	Cable Tray End Cut	Thru Tray Width		'L'
		in.	(mm)	in. (mm)
● 9A-103(X)	Mitered	36	(914)	N/A (NA)
● 9A-103(X)-12	Not mitered	12	(305)	16 (406)
● 9A-103(X)-36	Not mitered	36	(914)	41 (1041)

## Branch Pivot Connectors

- Branch from existing cable tray runs at any point.
- Pivot to any required angle.
- UL Classified for grounding (bonding jumpers not required).
- Furnished in pairs with hardware.

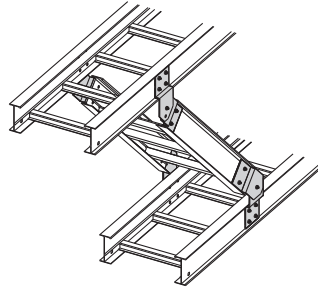

Catalog No.	Height	
	in.	mm
● 9A-2044	4	(101)
● 9A-2045	5	(127)
● 9A-2046	6	(152)
● 9A-2047	7	(178)

## Offset Reducing Splice Plate

- This plate is used for joining cable trays having different widths. When used in pairs they form a straight reduction; when used singly with a standard splice plate, they form an offset reduction.
- Furnished as one plate with hardware.
- (‡) Insert reduction

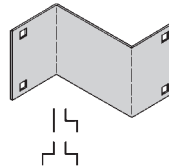

Catalog No.	Height	
	in.	mm
● 9A-1064-‡	4	(101)
● 9A-1065-‡	5	(127)
● 9A-1066-‡	6	(152)
● 9A-1067-‡	7	(178)

## Tray to Box Splice Plates

- Used to attach the end of a cable tray run to a distribution box or control panel.
- Furnished in pairs with hardware

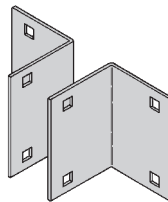

Catalog No.	Height	
	in.	mm
● 9A-1054	4	(101)
● 9A-1055	5	(127)
● 9A-1056	6	(152)
● 9A-1057	7	(178)

## Frame Type Box Connector

- Designed to attach the end of a cable tray run to a distribution cabinet or control center to help reinforce the box at the point of entry.
- Furnished with tray connection hardware.

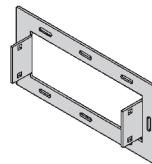

Catalog No.	Height	
	in.	mm
● 9A-1074-‡	4	(101)
● 9A-1075-‡	5	(127)
● 9A-1076-‡	6	(152)
● 9A-1077-‡	7	(178)

## Blind End

- This plate forms a closure for a dead end cable tray.
- Furnished as one plate with hardware.
- (‡) Insert tray width

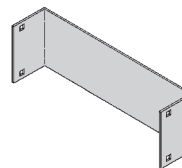

Catalog No.	Height	
	in.	mm
● 9A-1084-‡	4	(101)
● 9A-1085-‡	5	(127)
● 9A-1086-‡	6	(152)
● 9A-1087-‡	7	(178)

● Green = Fastest shipped items   ● Black = Normal lead-time items   ● Red = Normally long lead-time items

All dimensions in parentheses are millimeters unless otherwise specified.

# Series 2, 3, 4, & 5 Aluminum - Accessories

## Standard Tray Hardware (for field installation drill $1\frac{3}{32}$ " hole)

- Finish: Zinc Plated ASTM B633 SC1

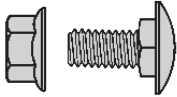

Catalog No.	Description
● SNCB $\frac{3}{8}$ " x $\frac{3}{4}$ " ZN	Square Neck Carriage Bolt ASTM A307 Grade A
● SFHN $\frac{3}{8}$ "-16 ZN	Serrated Flange Hex Nut ASTM A563 Grade A

## Optional Tray Hardware (for field installation drill $1\frac{3}{32}$ " hole)

- To order 316 stainless steel hardware add SS6 suffix to catalog number - Example: 9A1004SS6

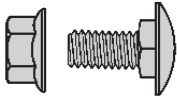

Catalog No.	Description
● SNCB $\frac{3}{8}$ " x $\frac{3}{4}$ " SS6	Square Neck Carriage Bolt AISI 316 Stainless Steel
● SFHN $\frac{3}{8}$ "-16 SS6	Serrated Flange Hex Nut AISI 316 Stainless Steel

## Cross Connector Bracket

- For field connecting crossing section.
- Furnished in pairs with  $\frac{3}{8}$ " hardware.

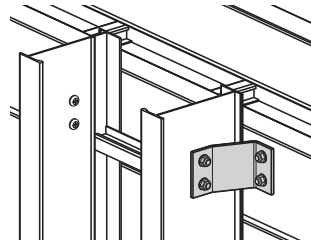
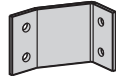

Catalog No.
● 9A-1240

## Conduit to Cable Tray Adaptor

- For easy attachment of conduit terminating at a cable tray.
- Use on aluminum or steel cable trays.

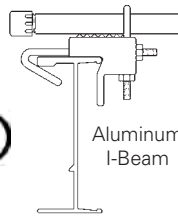
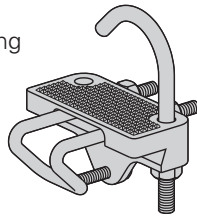

Aluminum I-Beam

Catalog No.	Conduit Size	
	in.	mm
● 9G-1158- $1\frac{1}{2}$ , $\frac{3}{2}$	$\frac{1}{2}$ , $\frac{3}{4}$	(15, 20)
● 9G-1158-1, $1\frac{1}{4}$	1, $1\frac{1}{4}$	(25, 32)
● 9G-1158- $1\frac{1}{2}$ , 2	$1\frac{1}{2}$ , 2	(40, 50)
● 9G-1158- $2\frac{1}{2}$ , 3	$2\frac{1}{2}$ , 3	(65, 80)
● 9G-1158- $3\frac{1}{2}$ , 4	$3\frac{1}{2}$ , 4	(90, 100)

## Conduit to Cable Tray Adaptor

- Assembly required.
- Mounting hardware included.
- Conduit clamps provided.
- (‡) = Insert conduit size ( $\frac{1}{2}$ " thru 4").

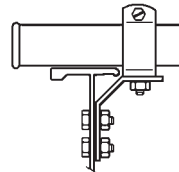

Catalog No.
● 9ZN-1150-(‡)

## Conduit to Cable Tray Adaptor

- Assembly required.
- Conduit clamps included.
- (‡) = Insert conduit size ( $\frac{1}{2}$ " thru 4").

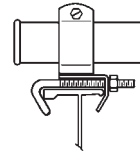
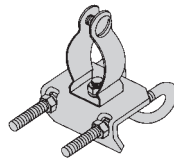

Catalog No.
● 9ZN-1155-(‡)

## Cable Tie (Ladder Tray)

- Nylon ties provide easy attachment of cable to ladder rungs; maximum cable O.D. is 3" (76mm).

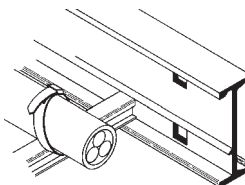

Overall Length 15" (381mm)

Catalog No.
● 99-2125-15

● Green = Fastest shipped items   ● Black = Normal lead-time items   ● Red = Normally long lead-time items

All dimensions in parentheses are millimeters unless otherwise specified.

## Ladder Drop-Out

- Specially-designed Ladder Drop-Outs provide a rounded surface with 4" (101 mm) radius to protect cable as it exits from the cable tray, preventing damage to insulation. The drop-out will attach to any desired rung.
- (‡) Insert tray width

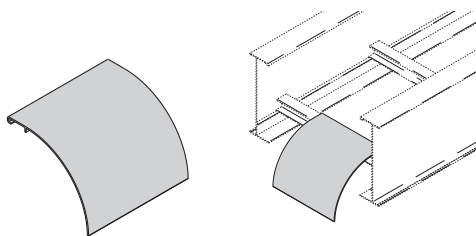

Catalog No.
● 9A-1104-(‡)

## Trough Drop-Out & Drop-Out Bushing

- These devices provide a rounded surface to protect cable as it exits from the trough-type cable tray.
- Hardware is included for attachment of the trough bottom drop-out.
- (‡) Insert tray width

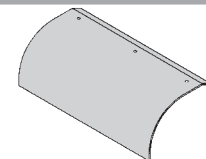
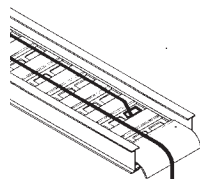

Trough-Type Drop-Out

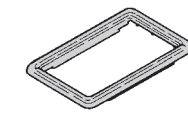

Snap-In Plastic Bushing

Catalog No.
● 9A-1104T-(‡)

Catalog No.
● 99-1124

## Barrier - Straight Section

- Length: Insert 120 for [120" - 10 ft.] (3.0 m) or 144 for [144" - 12 ft.] (3.6 m)
- Order catalog number based on loading depth.
- Furnished with four #10 x 1/2" plated self-drilling screws and a 99-9982 Barrier Strip Splice.

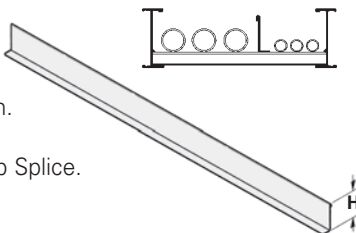

Catalog No.	Side Rail Height in. mm	Loading Depth 'H' in. mm
● 73A-Length	4 (101)	3 (76)
● 74A-Length	5 (127)	4 (101)
● 75A-Length	6 (152)	5 (127)
● 76A-Length	7 (178)	6 (152)

## Barrier - Horizontal Bend

- Horizontal Bend Barriers are flexible in order to conform to any horizontal fitting radius. Can be cut to desired length.
- Standard length is 72" [6 ft.] (1.8 m) - sold individually
- Order catalog number based on loading depth.
- Furnished with three #10 x 1/2" plated self-drilling screws and a 99-9982 Barrier Strip Splice.

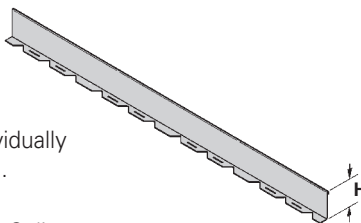

Catalog No.	Side Rail Height in. mm	Loading Depth 'H' in. mm
● 73A-90HBFL	4 (101)	3 (76)
● 74A-90HBFL	5 (127)	4 (101)
● 75A-90HBFL	6 (152)	5 (127)
● 76A-90HBFL	7 (178)	6 (152)

## Barrier - Vertical Outside Bend

- Vertical Outside Bend Barriers are preformed to conform to a specific vertical outside bend fitting.
- Furnished with three #10 x 1/2" plated self-drilling screws and a 99-9982 Barrier Strip Splice.
- (\*) Insert 30, 45, 60 or 90 for degrees
- (t) Insert 12, 24, 36 or 48 for radius

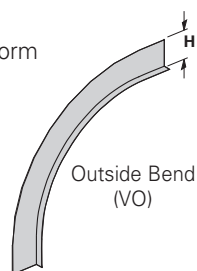

Catalog No.	Side Rail Height in. mm	Loading Depth 'H' in. mm
● 73A-(*)VO(†)	4 (101)	3 (76)
● 74A-(*)VO(†)	5 (127)	4 (101)
● 75A-(*)VO(†)	6 (152)	5 (127)
● 76A-(*)VO(†)	7 (178)	6 (152)

## Barrier - Vertical Inside Bend

- Vertical Inside Bend Barriers are preformed to conform to a specific vertical inside bend fitting.
- Furnished with three #10 x 1/2" plated self-drilling screws and a 99-9982 Barrier Strip Splice.
- (\*) Insert 30, 45, 60 or 90 for degrees
- (t) Insert 12, 24, 36 or 48 for radius

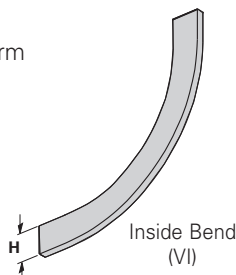

Catalog No.	Side Rail Height in. mm	Loading Depth 'H' in. mm
● 73A-(*)VI(†)	4 (101)	3 (76)
● 74A-(*)VI(†)	5 (127)	4 (101)
● 75A-(*)VI(†)	6 (152)	5 (127)
● 76A-(*)VI(†)	7 (178)	6 (152)

● Green = Fastest shipped items   ● Black = Normal lead-time items   ● Red = Normally long lead-time items

All dimensions in parentheses are millimeters unless otherwise specified.

# Series 2, 3, 4, & 5 Aluminum - Accessories

## Barrier Strip Clip

- Provides attachment to rung.
- Allows for installed barrier adjustment.
- Asymmetrical clip provides a wide range for screw location.
- Barrier strip clips not included with barriers.  
(Must be ordered separately)

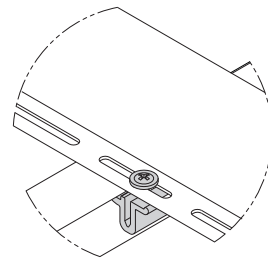
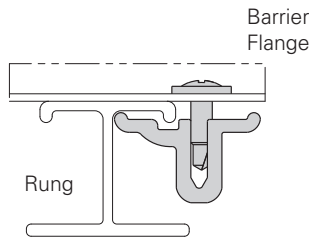
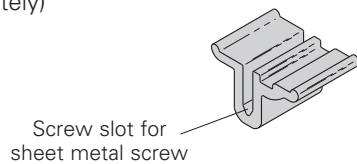

Catalog No.

● 9A-RBC

## Barrier Strip Splice

- Plastic splice holds adjoining barrier strips in straight alignment.
- 3" (76mm) long.

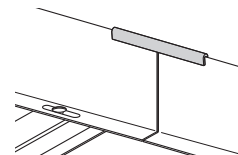
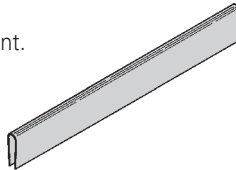

Catalog No.

● 99-9982

## Bonding Jumper

Use at each expansion splice and where the cable tray is not mechanically/electrically continuous to ground. Sold individually.

- Hardware included.
- See table 392.6(B)(2) on page CTS-9 for amperage ratings required to match the UL cross-sectional area of the tray.
- See tray loading chart for UL cross-sectional area.
- Bonding jumper is 14<sup>1</sup>/<sub>2</sub>" (368mm) long.

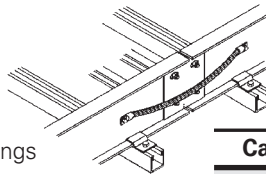

Catalog No.	Copper Wire Size	Ampacity
● 99-N1	#1	600
● 99-40	4/0	1600
● 99-1620	250 MCM	2000

## Grounding Clamp

Eaton's B-Line series cable tray is UL® classified as to its suitability as an equipment grounding conductor. If a separate conductor for additional grounding capability is desired, B-Line offers this clamp for bolting the conductor at least once to each cable tray section.

- Accepts #6 AWG to 250 MCM.

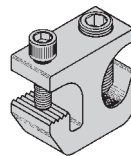

Catalog No.	Material
● 9A-2130	Tin Plated Aluminum

## Ground Wire Clamp

- Mechanically attaches grounding cables to cable tray.
- Hardware included.
- (\*) Insert **ZN** or **SS4**

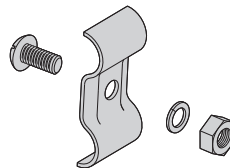

Catalog No.	Material
9(*)-2351	#1 thru 2/0
9(*)-2352	3/0 thru 250 MCM

## Thread Rod (ATR) & Rod Couplings

Loading based on safety factor 5.

Standard Finish: Zinc plated

See B-Line series Strut Systems Catalog for other sizes and finishes.

B655  
Rod Coupling

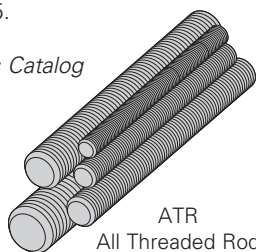
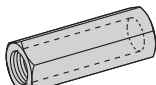

Size	Catalog No.	Available Length	Loading
<b>All Threaded Rod</b>			
3/8"-16	● ATR 3/8" x Length	36", 72", 120", 144"	730 lbs.
1/2"-13	● ATR 1/2" x Length	36", 72", 120", 144"	1350 lbs.
<b>Rod Coupling</b>			
3/8"-16	● B655-3/8"	NA	730 lbs.
1/2"-13	● B655-1/2"	NA	1350 lbs.

● Green = Fastest shipped items   ● Black = Normal lead-time items   ● Red = Normally long lead-time items

All dimensions in parentheses are millimeters unless otherwise specified.

## Stainless Steel Cable Clamp 'P'

- Fits with series 2, 3, & 4 rungs.
- Attaches to rung at any point.
- 14 gauge Type 316 stainless steel material to minimize corrosion and induction heating.
- Plated steel and aluminum also available.

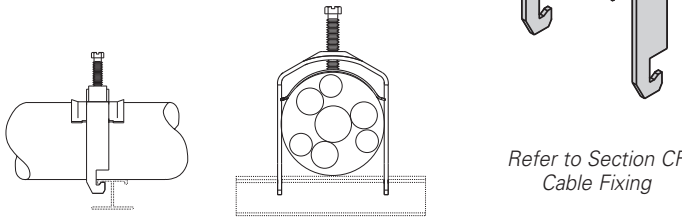

Refer to Section CF  
Cable Fixing

Catalog No.	Cable Size	
	in.	mm
● BP081SS	.250 - .840	(6.4 - 21.3)
● BP110SS	.810 - 1.100	(20.6 - 28.0)
● BP135SS	.850 - 1.350	(21.6 - 34.8)
● BP175SS	1.250 - 1.750	(31.8 - 44.5)
● BP205SS	1.550 - 2.050	(39.4 - 52.1)
● BP250SS	2.000 - 2.500	(50.8 - 63.5)
● BP300SS	2.500 - 3.000	(63.5 - 76.2)
● BP325SS	2.750 - 3.250	(69.9 - 82.6)
● BP375SS	3.250 - 3.750	(82.6 - 95.3)
● BP425SS	3.750 - 4.250	(95.3 - 108.0)
● BP475SS	4.250 - 4.750	(108.0 - 120.7)

## Hanger Rod Clamp

- For 1/2" ATR.
- Furnished in pairs.
- Order ATR and hex nuts separately.
- Two-piece "J"-hanger design.
- 1500 lbs./pair capacity safety factor 3.
- (\*) Insert **ZN** or **G**

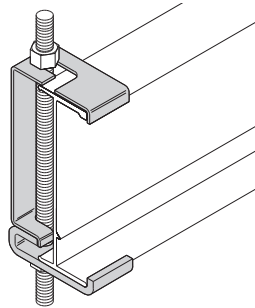

Catalog No.	Height	
	in.	mm
9(*)-5324	4	(101)
9(*)-5325	5	(127)
9(*)-5326	6	(152)
9(*)-5327	7	(178)

## Cable Tray Clamp/Guide

- Features a no-twist design.
- Has four times the strength of the traditional design.
- Each side is labeled to ensure proper installation.
- Furnished in pairs, with or without hardware.
- Not recommended for vertical support.

Note: For heavy duty or vertical applications see 9(\*)-1241 or 9(\*)-1242 page HAT-20

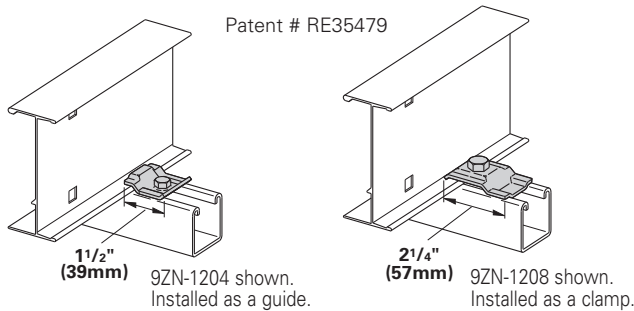

Catalog No.		Overall Length in. (mm)	Hardware Size in.	Finish
Without Hardware	With Hardware			
● 9ZN-1204	● 9ZN-1204NB	1 1/2 (38)	1/4"	G90
● 9ZN-1208	● 9ZN-1208NB	2 1/4 (57)	3/8"	G90
● 9A-1205	--	2 1/4 (57)	1/2"	Alum.
● 9G-1205	--	2 1/4 (57)	1/2"	HDGAF
● 9SS6-1205	--	2 1/4 (57)	1/2"	316SS
● 9ZN-1205	--	2 1/4 (57)	1/2"	G90

## Isolator Pad

- Use as a friction reducer and/or as a dissimilar metal isolator barrier.
- UV resistant HDPE.
- Temperature range: -100 to 160° F.
- Designed to use with 9(\*)-1205 or 9(\*)-1208 clamp/guide.
- Color - White.

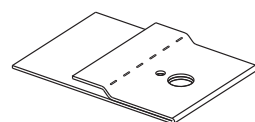

Isolation pad shown as when used with a guide.

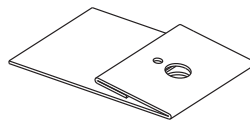

Isolation pad shown with top flange doubled under for clamp application.

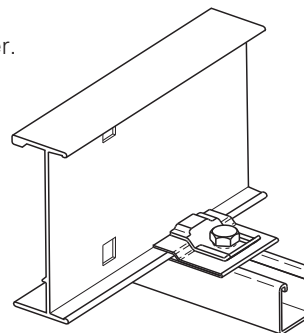

Catalog No.

● 99-PE34

● Green = Fastest shipped items    ● Black = Normal lead-time items    ● Red = Normally long lead-time items

All dimensions in parentheses are millimeters unless otherwise specified.

# Series 2, 3, 4, & 5 Aluminum - Accessories

## Cable Tray Clamp

- Hold-down clamps for single or double cable tray runs.
- No drilling of support I-beam or channel is required.
- Sold in pieces - two clamps are required per tray.
- Maximum beam flange thickness 1 1/8" (28.58 mm).

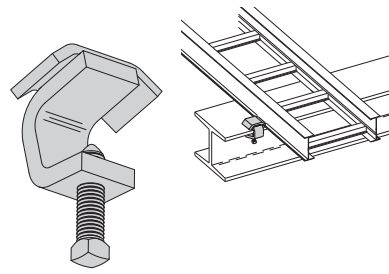

Catalog No.	Finish
● 9ZN-1249HD	Znplt
● 9G-1249HD	HDGAF

## Cable Tray Guide

- Expansion guide for single or double cable tray runs.
- Guide allows for longitudinal movement of the cable tray.
- No field drilling of support I-beam or channel is required.
- Guides are required on both sides of cable tray to prevent lateral movement - can be placed on either the inside or outside flange of cable tray.
- Guides are sold in pieces - two guides are required per tray.
- Maximum flange thickness 1 1/8" (28.58 mm).

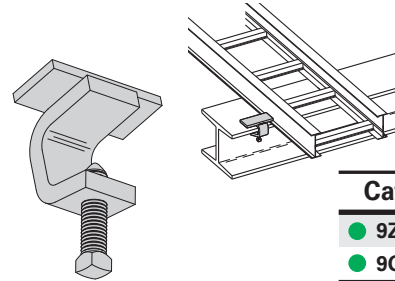

Catalog No.	Finish
● 9ZN-1249	Znplt
● 9G-1249	HDGAF

## Nylon Pad

- Use for friction reduction.
- Hardness: Shore D80.
- Low friction coefficient.
- UV resistant.
- Excellent weatherability.
- UL - 94HB.

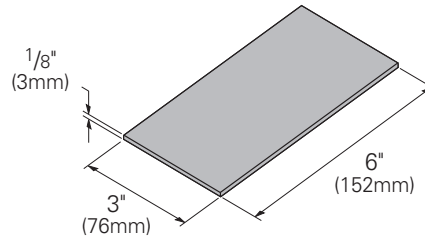

Catalog No.
● 99-PE36

## Neoprene Roll

- Use for material isolation.
- 1/8" x 2" x 25' roll.
- Hardness: Shore A60.
- Good weatherability.

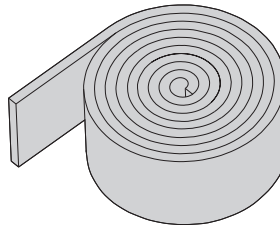

Catalog No.
● 99-NP300

## DURA-BLOK™ Rooftop Support Bases with B22 Channel

- Designed as a superior rooftop support for cable tray,
- UV resistant and approved for most roofing material or other flat surfaces.
- Can be used with any of B-Line series cable tray clamps and guides.
- Ultimate Load Capacity: 1,000 lbs. (uniform load)



Catalog No.	Height x Width x Length in. (mm)
● DB10-28	5 5/8 x 6 x 28.0 (143 x 152 x 711)
● DB10-36	5 5/8 x 6 x 36.0 (143 x 152 x 914)
● DB10-42	5 5/8 x 6 x 42.0 (143 x 152 x 1067)
● DB10-50	5 5/8 x 6 x 50.0 (143 x 152 x 1270)
● DB10-60	5 5/8 x 6 x 60.0 (143 x 152 x 1524)



LEEDS credit available, base made from 100% recycled material.

General Note: Consult roofing manufacturer or engineer for roof load capacity. The weakest point may be the insulation board beneath the rubber membrane.

● Green = Fastest shipped items   ● Black = Normal lead-time items   ● Red = Normally long lead-time items

All dimensions in parentheses are millimeters unless otherwise specified.



## Trapeze Support Kit

- Eaton's B-Line series trapeze kits provide the components required for a single trapeze support in one package. These kits are available in pre-galvanized steel with zinc-plated hardware, hot dip galvanized steel with 316 stainless steel hardware, or DURA GREEN™ painted steel with zinc-plated hardware.
- The SH channel provides the convenience of pre-punched slots, which eliminate the need for field drilling.
- The illustrated hardware is sealed in a plastic bag and boxed with the channel, which is pre-cut to the appropriate length as shown in the chart.
- Designed for use with 1/2" threaded rod. Order rod separately.

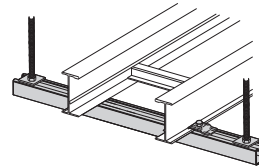
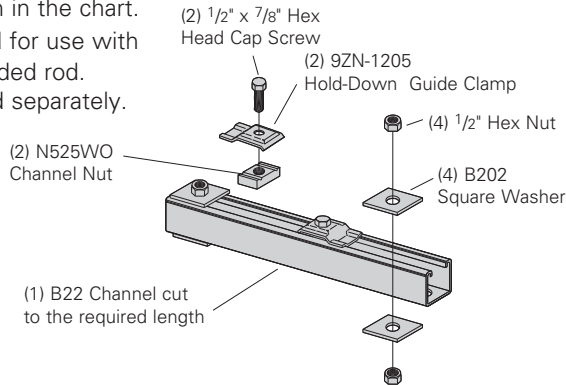

Catalog No.	Tray Width		Channel Length		Uniform Load	
	in.	mm	in.	mm	lbs	kN
● 9(*)-5506-22SH(†)	6	(152)	16	(406)	1350	(6.00)
● 9(*)-5509-22SH(†)	9	(229)	18	(457)	1250	(5.56)
● 9(*)-5512-22SH(†)	12	(305)	22	(559)	1125	(5.00)
● 9(*)-5518-22SH(†)	18	(457)	28	(711)	865	(3.85)
● 9(*)-5524-22SH(†)	24	(610)	34	(864)	700	(3.11)
● 9(*)-5530-22SH(†)	30	(762)	40	(1016)	590	(2.62)
● 9(*)-5536-22SH(†)	36	(914)	46	(1168)	510	(2.27)
● 9(*)-5542-22SH(†)	42	(1067)	52	(1321)	450	(2.00)

- (\*) Insert **P** **G** or **GRN**
- (†) Insert 3/8 for 3/8" threaded rod hardware. Safety factor of 3.0 on all loads.

## Heavy Duty Trapeze Support Kit

- Eaton's B-Line series trapeze kits provide the components required for a single trapeze support in one package. These kits are available in pre-galvanized steel with zinc-plated hardware, hot dip galvanized steel with 316 stainless steel hardware, or DURA GREEN™ painted steel with zinc-plated hardware.
- The SH channel provides the convenience of pre-punched slots, which eliminates the need for field drilling.
- The illustrated hardware is sealed in a plastic bag and boxed with the channel, which is pre-cut to the appropriate length as shown in the chart.
- Designed for use with 1/2" threaded rod. Order rod separately.

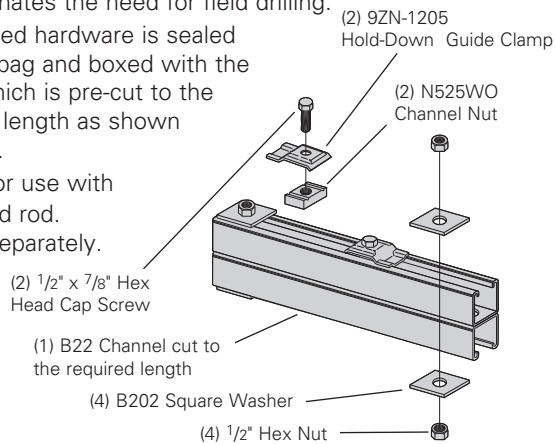

Catalog No.	Tray Width		Channel Length		Uniform Load	
	in.	mm	in.	mm	lbs	kN
● 9(*)-5506-22SHA	6	(152)	16	(406)	1350	(6.00)
● 9(*)-5509-22SHA	9	(229)	18	(457)	1350	(6.00)
● 9(*)-5512-22SHA	12	(305)	22	(559)	1350	(6.00)
● 9(*)-5518-22SHA	18	(457)	28	(711)	1350	(6.00)
● 9(*)-5524-22SHA	24	(610)	34	(864)	1350	(6.00)
● 9(*)-5530-22SHA	30	(762)	40	(1016)	1350	(6.00)
● 9(*)-5536-22SHA	36	(914)	46	(1168)	1350	(6.00)
● 9(*)-5542-22SHA	42	(1067)	52	(1321)	1350	(6.00)

- (\*) Insert **P** **G** or **GRN**
- Safety factor of 3.0 on all loads.

## Trapeze Hardware Kit

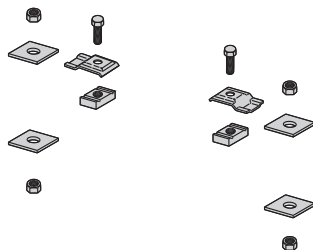

Catalog No.	● 9ZN-5500-1/2	● 9G-5500-1/2
In plastic bag	1 pr. 9ZN-1205 2 HHC Screw 1/2 x 7/8 ZN 2 N525 WO ZN 4 B202 ZN 1/2" sq washer 4 HN 1/2 ZN	1 pr. 9G-1205 2 HHC Screw 1/2 x 7/8 SS6 2 N525 WO SS6 4 B202 HDG 1/2" sq washer 4 HN 1/2 SS6

- Green = Fastest shipped items
- Black = Normal lead-time items
- Red = Normally long lead-time items

All dimensions in parentheses are millimeters unless otherwise specified.

# Series 2, 3, 4, & 5 Aluminum - Accessories

## Center Hung Tray Support

- Center Hung Cable Tray Support allows cable to be laid-in from both sides.
- Eliminates costly cable pulling and field cutting of cable tray supports. Labor costs are dramatically reduced.
- Required hardware and threaded rod material for trapeze assemblies are reduced by up to 50%.
- Designed for use with 1/2" threaded rod. (Order rod separately)
- Use with all aluminum and steel cable trays through 24" width.
- Load capacity is 700 lbs. (311kN) per support. Safety factor of 3.0. Eccentric loading is not to exceed a 60% vs. 40% load differential.
- The maximum recommended unsupported span length is 144"/12 ft. (3.66 m).
- Hardware shown is furnished.
- Finish available: Zinc Plated

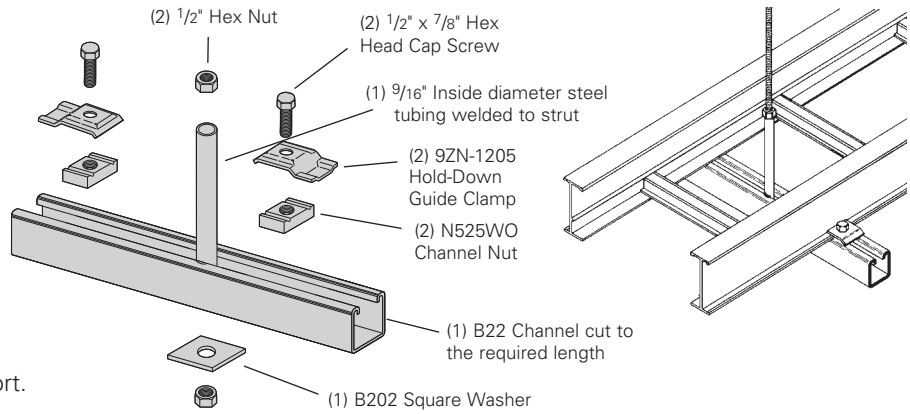

Catalog No.	Tray Width		Channel Length	
	in.	(mm)	in.	(mm)
● 9ZN-5212	6", 9", 12"	(152, 228, 305)	18"	(457)
● 9ZN-5224	18", 24"	(457, 609)	30"	(762)

## Center Hung Support Hardware Kit

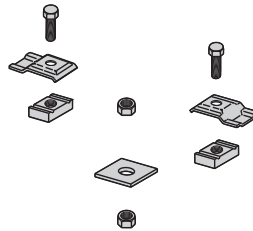

Catalog No.	● 9ZN-5200
In plastic bag	1 pr. 9ZN-1205 2 HHC Screw 1/2 x 7/8 ZN 2 N525 WO ZN 1 B202 ZN 1/2" sq washer 4 HN 1/2 ZN

## Bracket (12" - 48")

- (\*) Insert available finish: **ZN** **GRN** or **HDG**
- Safety Load Factor 2.5

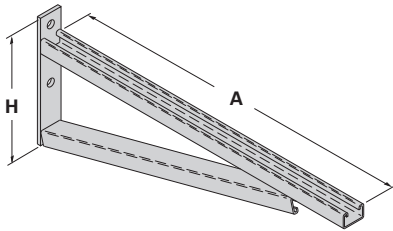

Bottom brace is B42 channel on B494-24 and smaller and B22 channel on B494-30 and larger

Catalog No.	Uniform Load lbs (kN)	Tray Width		'A'		'H'	
		in.	(mm)	in.	(mm)	in.	(mm)
● B494-12	2500 (11.12)	6 & 9	(152 & 229)	12	(305)	8 <sup>3</sup> / <sub>4</sub>	(222)
● B494-18	1700 (7.56)	12	(305)	18	(457)	8 <sup>3</sup> / <sub>4</sub>	(222)
● B494-24	1300 (5.78)	18	(457)	24	(610)	8 <sup>3</sup> / <sub>4</sub>	(222)
● B494-30	1600 (7.11)	24	(610)	30	(762)	11 <sup>1</sup> / <sub>4</sub>	(286)
● B494-36	1100 (4.89)	30	(762)	36	(914)	11 <sup>1</sup> / <sub>4</sub>	(286)
● B494-42	980 (4.36)	36	(914)	42	(1067)	16	(406)
● B494-48	980 (4.36)	42	(1067)	48	(1219)	16	(406)

For more dimensional data see Strut Systems catalog

## Cantilever Bracket

- (\*) Insert available finish: **ZN** **GRN** **HDG** **SS4** or **SS6**
- Safety Load Factor 2.5

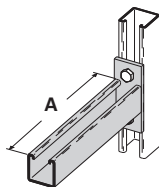

Catalog No.	Uniform Load		Tray Width		'A'	
	lbs	kN	in.	mm	in.	mm
B409-12	960	(4.27)	6 & 9	(152 & 229)	12	(305)
B409-18	640	(2.84)	12	(305)	18	(457)
B409-24	480	(2.13)	18	(457)	24	(610)

● Green = Fastest shipped items ● Black = Normal lead-time items ● Red = Normally long lead-time items

All dimensions in parentheses are millimeters unless otherwise specified.

# Series 2, 3, 4, & 5 Aluminum - Accessories

## Cantilever Bracket

- (\*) Insert available finish: **ZN** **GRN** **HDG** or **SS4**
- Safety Load Factor 2.5

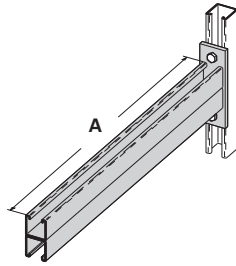

Catalog No.	Uniform Load		Tray Width		'A'	
	lbs	kN	in.	mm	in.	mm
<b>B297-12</b>	1660	(7.38)	6 & 9	(152 & 229)	12	(305)
<b>B297-18</b>	1100	(4.89)	12	(305)	18	(457)
<b>B297-24</b>	835	(3.71)	18	(457)	24	(610)
<b>B297-30</b>	665	(2.93)	24	(610)	30	(762)
<b>B297-36</b>	550	(2.44)	30	(762)	36	(914)
<b>B297-42</b>	465	(2.06)	36	(914)	42	(1067)

## Underfloor Support (U-Bolts not included)

- Finishes available: **ZN**
- Safety Load Factor 2.5

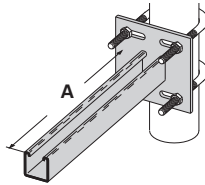

U-Bolt Size	Fits Pipe O.D.
B501-3/4	.841 - 1.050
B501-1	1.051 - 1.315
B501-1 1/4	1.316 - 1.660
B501-1 1/2	1.661 - 1.900
B501-2	1.901 - 2.375
B501-2 1/2	2.376 - 2.875

Catalog No.	Uniform Load		Tray Width		'A'	
	lbs	(kN)	in.	(mm)	in.	(mm)
<b>B409UF-12</b>	800	(3.56)	6 & 9	(152 & 229)	12	(305)
<b>B409UF-21</b>	450	(2.00)	12 & 18	(305 & 457)	21	(533)

## Vertical Hanger Splice Plates

- Design load is 1500 lbs (6.67kN) per pair.
- Safety Factor of 2.5
- Furnished in pairs.
- Hole size: 9/16" (14mm) for 1/2" threaded rod.

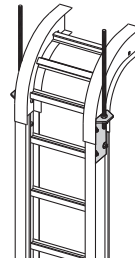
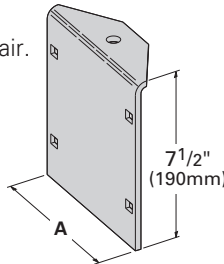

Catalog No.	Outside Cable Tray Ht.	'A'	
		in.	(mm)
● <b>9A-1224</b>	4"	3.84	(97.54)
● <b>9A-1225</b>	5"	4.73	(120.14)
● <b>9A-1226</b>	6"	5.84	(148.34)
● <b>9A-1227</b>	7"	6.84	(173.74)

## Heavy Duty Hold Down Bracket

- Design load is 2000 lbs (8.89kN) per pair.
- Two bolt design.
- Sold in pairs.
- 3/8" cable tray attachment hardware provided.
- 1/2" support attachment hardware **not** provided.
- (\*) Insert **ZN** **SS4** or **SS6**
- Recommended for support of vertical trays.

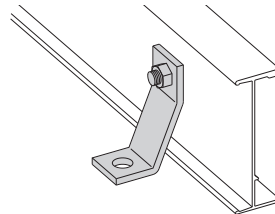

Catalog No.  
**9(\*)-1241**

## Heavy Duty Hold Down Bracket

- Design load is 4000 lbs (17.79kN) per pair.
- Four bolt design.
- Sold in pairs.
- 3/8" cable tray attachment hardware provided.
- 1/2" support attachment hardware **not** provided.
- (\*) Insert **ZN** **SS4** or **SS6**
- Recommended for support of vertical trays.

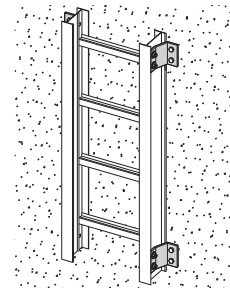
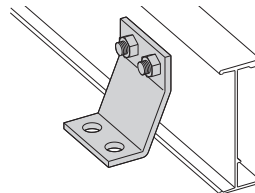

Catalog No.  
**9(\*)-1242**

## Beam Clamp

- Finishes available: **ZN** **GRN** **HDG** or **SS4**
- Sold in pieces.
- Design load is 1200 lbs (5.34kN) per pair.
- Safety Load Factor 5.0.
- Order HHCS and Channel Nuts separately.

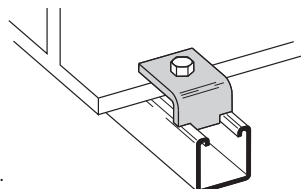

Catalog No.  
**B355**

● Green = Fastest shipped items    ● Black = Normal lead-time items    ● Red = Normally long lead-time items

All dimensions in parentheses are millimeters unless otherwise specified.

# Series 2, 3, 4, & 5 Aluminum - Accessories

## Beam Clamp

- Finishes available: **ZN** or **HDG**
- Sold in pieces.
- \*Design load when used in pairs. Safety Load Factor 5.0

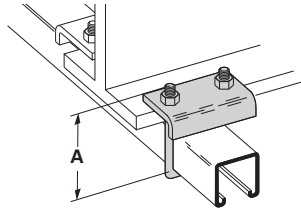

Catalog No.	Design Load lbs (kN)	'A' in. (mm)
<b>B441-22</b>	1200 (5.34)	3 <sup>3</sup> / <sub>8</sub> (86)
<b>B441-22A</b>	1200 (5.34)	5 (127)

## Beam Clamp

- Finishes available: **ZN** **GRN** or **HDG**
- Sold in pieces.
- \*Design load when used in pairs. Safety Load Factor 5.0

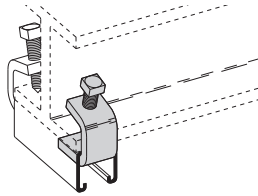

Catalog No.	B212-1/4	B212-3/8
<b>Design Load *</b>	600 lbs. (2.67kN)	1000 lbs. (4.45 kN)
<b>Max. Flange Thick</b>	3/4" (19 mm)	1 1/8" (28.6 mm)
<b>Mat'l. Thickness</b>	1/4" (6.3 mm)	3/8" (9.5 mm)

## B305 Thru B308 & B321 Series Beam Clamps

- Finishes available: **ZN** or **HDG**
- Setscrew included.
- Safety Load Factor 5.0

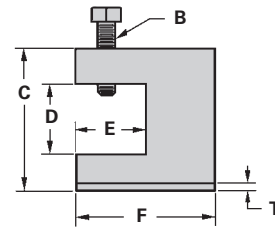
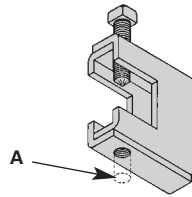

Catalog No.	Rod Size A	B	C in. (mm)	D in. (mm)	E in. (mm)	F in. (mm)	T in. (mm)	Design Load lbs (kN)
<b>B305</b>	3/8"-16	3/8"-16	2 <sup>5</sup> / <sub>16</sub> (58.7)	7/8 (22.2)	1 1/8 (28.6)	2 1/2 (63.5)	11 Ga. (3.0)	600 (2.67)
<b>B306</b>	3/8"-16	1/2"-13	2 <sup>7</sup> / <sub>16</sub> (61.9)	7/8 (22.2)	1 1/8 (28.6)	2 1/2 (63.5)	7 Ga. (4.5)	1100 (4.90)
<b>B307</b>	1/2"-13	1/2"-13	2 <sup>7</sup> / <sub>16</sub> (61.9)	7/8 (22.2)	1 1/8 (28.6)	2 1/2 (63.5)	7 Ga. (4.5)	1100 (4.90)
<b>B308</b>	1/2"-13	1/2"-13	2 <sup>9</sup> / <sub>16</sub> (65.1)	7/8 (22.2)	1 1/8 (28.6)	2 1/2 (63.5)	1/4 (6.3)	1500 (6.68)
<b>B321-1</b>	3/8"-16	1/2"-13	3 <sup>9</sup> / <sub>16</sub> (90.5)	1 11/16 (42.9)	1 <sup>5</sup> / <sub>8</sub> (41.3)	3 1/4 (82.5)	1/4 (6.3)	1300 (5.79)
<b>B321-2</b>	1/2"-13	1/2"-13	3 <sup>9</sup> / <sub>16</sub> (90.5)	1 11/16 (42.9)	1 <sup>5</sup> / <sub>8</sub> (41.3)	3 1/4 (82.5)	1/4 (6.3)	1400 (6.23)

## Anchor Strap - for B305 thru B308 & B321 Series

- Finish available: **ZN**
- For a maximum beam thickness of 3/4" (19mm).
- For thicker beams, step up one flange width size.

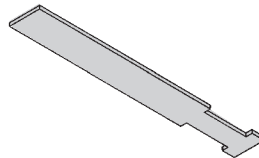

Catalog No.	Flange Width in. (mm)
<b>B312-6</b>	Up to 6 (Up to 152)
<b>B312-9</b>	6 - 9 (152 to 228)
<b>B312-12</b>	9 - 12 (228 to 305)

## Beam Clamp

- Finish available: **ZN**
- Design Load 500 lbs. (2.22 kN)
- Safety Load Factor 5.0
- Recommended torque:  
'J'-Hook Nut 125 In.-Lbs. (14.1 kN/m)
- Maximum flange thickness of 3/4" (19mm).

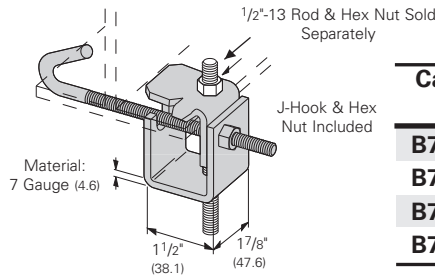

Catalog No.	For Flange Width in. (mm)	Wt./C lbs (kg)
<b>B750-J4</b>	3 - 6 (76.2 - 152.4)	109 (49.4)
<b>B750-J6</b>	5 - 9 (127.0 - 228.6)	124 (56.2)
<b>B750-J9</b>	8 - 12 (203.2 - 304.8)	135 (61.2)
<b>B750-J12</b>	11 - 15 (279.4 - 381.0)	147 (66.7)

## 'J'-Hook

- Finishes available: **ZN**
- Hex Nut included.

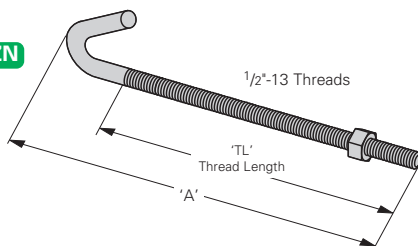

Catalog No.	'A' in. (mm)	'TL' in. (mm)	Wt./C lbs (kg)
<b>B700-J4</b>	8 1/2 (215.9)	5 (127.0)	44 (19.9)
<b>B700-J6</b>	11 1/2 (292.1)	6 (152.4)	53 (24.0)
<b>B700-J9</b>	12 1/4 (368.3)	6 (152.4)	63 (28.6)
<b>B700-J12</b>	17 1/2 (444.5)	6 (152.4)	78 (35.4)

● Green = Fastest shipped items ● Black = Normal lead-time items ● Red = Normally long lead-time items

All dimensions in parentheses are millimeters unless otherwise specified.