

# UD Series

## UTILITY DRAWERS

the UD series rackmount utility drawers offer an economical storage solution for any enclosure

### FEATURES:

- Full extension ball bearing slides extend a full 14"
- Durable black powder coat finish
- Keylock and latch option for security, user-installed (2, 3 and 4 space drawers only)
- Cable entry point at the rear of the drawer allows for optimized cable management
- Four sizes available
- UL Listed in the US and Canada

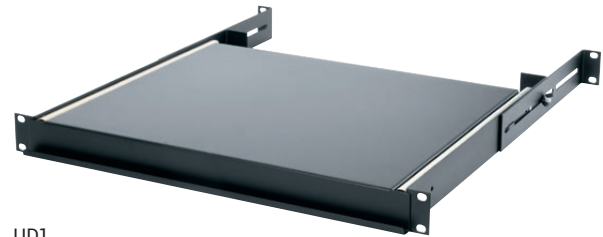

UD1  
(shown as a writing surface)



UD1



UD3

### SPECIFICATIONS:

EIA compliant 19" rackmount drawer shall be Middle Atlantic Products model # UD\_ (refer to chart). Drawer shall have useable width of \_\_", a useable surface of \_\_" and occupy \_\_ rackspaces (refer to chart). Drawer base shall be \_\_-gauge steel, top and sides shall be \_\_-gauge steel (refer to chart). Drawer faceplate shall be \_\_-gauge steel with a black powder coat finish (refer to chart). Drawer shall extend \_\_" (refer to chart). Drawer shall use full extension, ball bearing slides. UD\_ shall have cable entry point at the rear of the drawer. UD\_ shall have a knockout on the face of the drawer to accommodate optional user-installed latch and keylock (refer to chart). Drawer shall have mounting hole spacing of \_\_" (refer to chart). Drawer shall have a 50 lb. weight capacity. Drawer shall be UL Listed in the US and Canada. Drawer shall be manufactured by an ISO 9001 and ISO 14001 registered company. Drawer shall be warranted to be free from defects in materials or workmanship under normal use and conditions for a period of three years.

Customizable specification clips available at [middleatlantic.com](http://middleatlantic.com)

### OPTIONS:

- User installed latch for UD Series drawers shall be Middle Atlantic Products model # LATCH. LATCH shall fit 2, 3 and 4 space drawers.
- User installed keylock for UD Series drawers shall be Middle Atlantic Products model # KYLK. KYLK shall fit 2, 3 and 4 space drawers.
- Additional set of keys for KYLK shall be Middle Atlantic Products model # ACC-KEY.
- No-slip drawer mat for UD Series drawers shall be Middle Atlantic Products model #DM.



WHAT GREAT SYSTEMS ARE BUILT ON.™

A brand of  **legrand**



**Middle Atlantic Products**  
middleatlantic.com | middleatlantic.ca

96-01105 / rev c / 5-26-10

# UD Series Utility Drawers

## BASIC DIMENSIONS

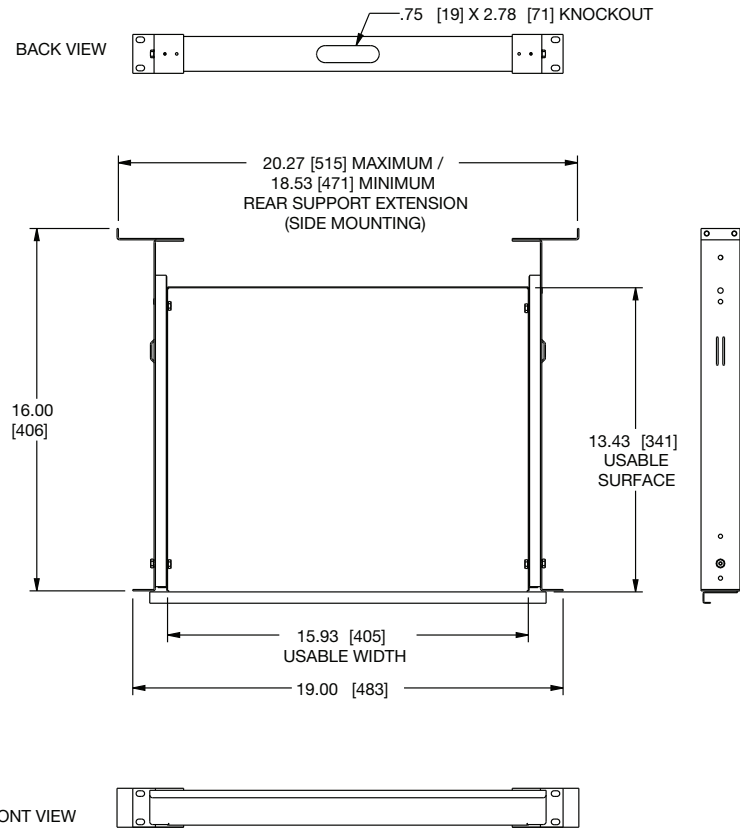
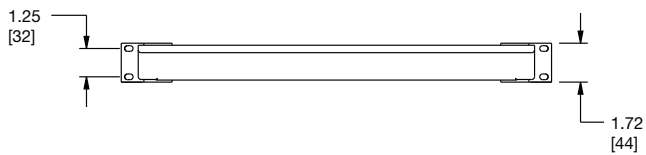
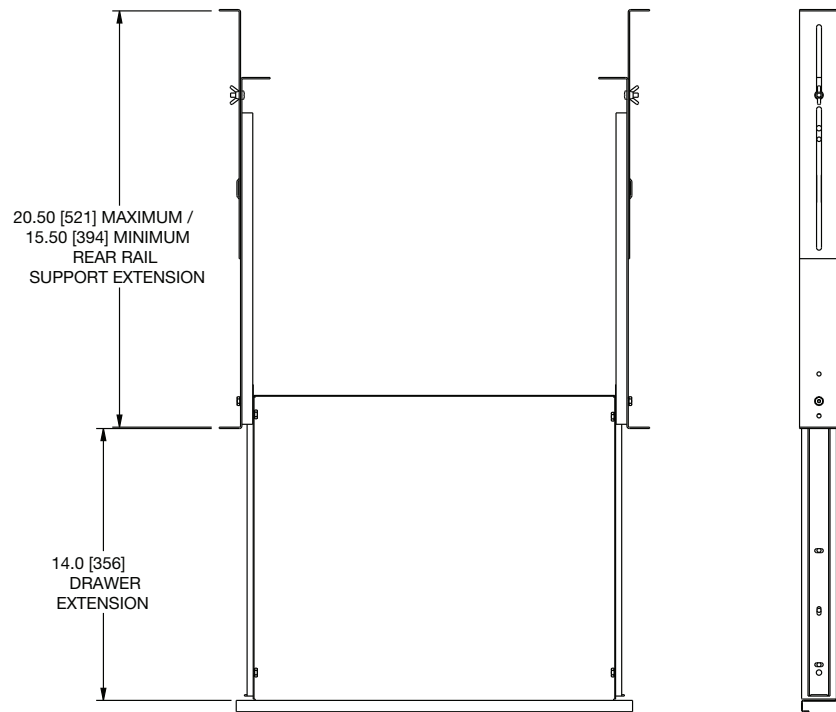

WHAT GREAT SYSTEMS ARE BUILT ON.™

A brand of  **legrand**

  
**Middle Atlantic Products**  
middleatlantic.com | middleatlantic.ca

# UD Series Utility Drawers

## BASIC DIMENSIONS

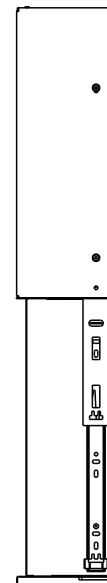
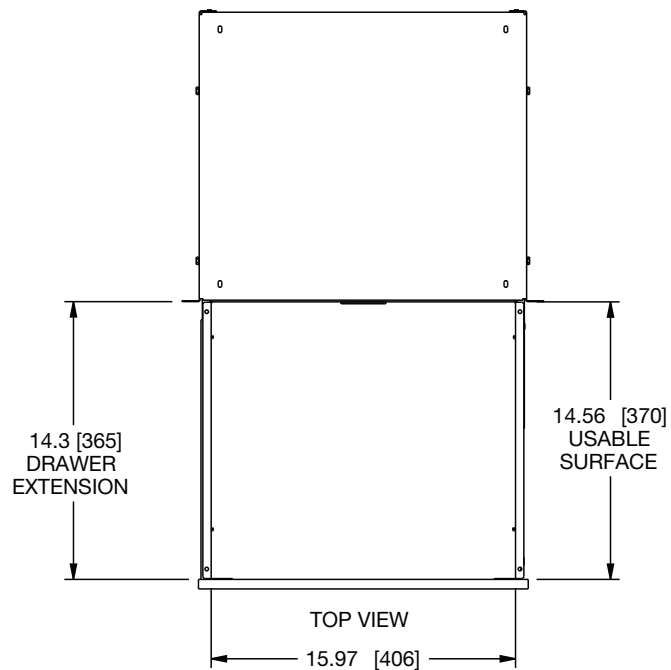
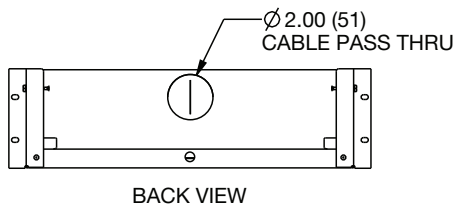

	"A" HEIGHT	"B" MOUNTING HOLE SPACING
UD2	3.50 [89]	3.00 [76]
UD3	5.25 [133]	2.25 [57]
UD4	7.00 [178]	4.00 [102]

WHAT GREAT SYSTEMS ARE BUILT ON.™

A brand of **legrand**

**MA**  
Middle Atlantic Products  
middleatlantic.com | middleatlantic.ca