



Centralized Distribution for Wired & Wireless Low Voltage Systems

20": ENP2050, ENP2060, ENP2060-5, ENP2080, ENP2080-5

30": ENP3050, ENP3060, ENP3060-5, ENP3080, ENP3080-5

42": ENP4250, ENP4260, ENP4260-5, ENP4280, ENP4280-5

Trim Rings: ENP2001, ENP3001, ENP4201

Accessories: AC1040, AC1041, AC1035-20

This enclosure secures both wired structured wiring systems and wireless networking equipment in a professional, out-of-sight installation.

Order as a complete assembly containing the enclosure and hinged door, a-la-carte, or in bulk to efficiently meet the requirements of your project

Enclosures: Features & Benefits

- **Wireless Transparent Material** – UL-rated ABS plastic allows wireless devices such as access points to secure in the cabinet without degrading network performance.
- **Stackable** – Enclosures and doors are each neatly stackable to efficiently ship and warehouse.
- **Surface or Flush Mounting** – Mounts flush to the stud bay with staggered tabs that allow side-by-side installations of multiple enclosures.
- **UL Rated** – Meets or exceeds the standards of UL Standard 2416. Specified for non-fire rated walls.
- **Universal Mounting Grid** – Compatible with video, voice and data distribution modules from multiple manufacturers. Ask us for our up-to-date compatibility list.
- **Extensive Venting** – Provides superior heat dispersion for powered devices mounted in the enclosure.
- **Extra Depth** – Protruded door adds 1.2" (30mm) of enclosure depth for compatibility with more third party devices such as uninterruptable power supplies (UPS).
- **Conceals Drywall Cutout** – Extended door circumference conceals the drywall cutout for a professional finish.
- **Layered Latch** – Holds the door shut and flush to the drywall without the need of a lock. Locking can be accommodated with the provided screw holes.



Enclosure includes two electrical knockouts on the bottom and five 2" (51mm) cable knockouts on top. 2" rubber grommets are available as an accessory item.

Compliance

- UL 985, Household Fire-Warning System Units. ULC-S545, Residential Fire Warning System Control Units
- UL 1023, Household Burglar-Alarm System Units. CAN/ULC/ORD-C1023, Household Burglar Alarm System Units
- UL 2416, Audio/Video, Information and Communication Technology Equipment Cabinet, Enclosure and Rack Systems
- UL60950-1 & CAN/CSA C22.2 No. 60950-01-07, Information Technology Equipment, Including Electrical Business Equipment
- RoHS Compliant

Trim Rings: Features & Benefits

- **Smooth Transitions** – Conceal drywall imperfections creating a smooth transition to wall surface
- **Modular Design** – Modular snap-together design saves valuable space and cost of bulky shipping and warehousing
- **Reversible Door Swing** – Trim Ring can be installed to support left or right door swing
- **Mounting Hardware** – Includes hardware for installation and cable management

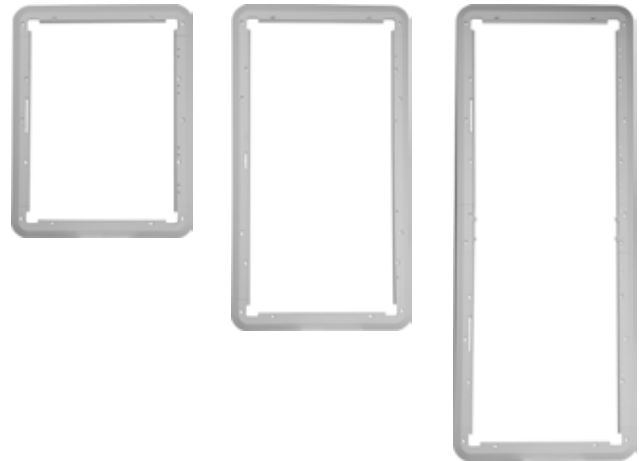

Accessories: Features & Benefits

AC1040

- **3rd Party Devices** – Allows 3rd party wired and wireless devices to be secured within structured wiring enclosure
- **Multiple Mounting Options** – Vertical and horizontal strapping locations provide a variety of mounting configurations
- **Secure** – Strategically places screw holes allow devices to be securely affixed within enclosure
- **Universal Mounting** – Universal mounting holes accept 3rd party modules to maximize compatibility
- **Mounting Hardware** – Includes (4) plungers and grommets and 8' of Velcro strapping



AC1041

- **Stay Organized** – Neatly organize and manage fiber within structured wiring enclosure
- **Bend Radius Protection** – 1.5" spool radius maintains proper bend requirements for fiber and category cable
- **Versatile Installation Options** – Half round design and multiple mounting holes provide versatile installation options for metal or plastic enclosures
- **Mounting Hardware** – Sold as a pair and includes (4) plungers and grommets and (2) 4" cable ties



AC1035-20

- **Clean Installations** – Harness cables within a plastic enclosure for clean installations
- **Loop Design** – Low-profile loop design is capable of accepting 1/2" w Velcro or cable ties
- **No Tools Necessary** – Easily attach to the plastic enclosure with included plunger/grommet
- **Secure** – Clips mount securely to enclosure, withstanding 20 lbs pull force
- **Materials** – Pack includes 20 Cable Management Clips



Technical Information

Enclosure Specifications

	20" Enclosure	30" Enclosure	42" Enclosure
Material	ABS Plastic	ABS Plastic	ABS Plastic
Color	White (Paintable*)	White (Paintable*)	White (Paintable*)
Specified Temperature	32°F - 122°F, 0°C - 50°C	32°F - 122°F, 0°C - 50°C	32°F - 122°F, 0°C - 50°C
Unit Weight	4.5 Lbs 2.04kg	6.17 Lbs 2.8kg (ENP3050)	8.64 Lbs 3.2kg (ENP4250)
Shipping Weight	6.5 Lbs 2.95kg	8.7 Lbs 3.95kg (ENP3050)	12.2 Lbs 5.5 kg (ENP4250)
Paintable*	Rust-Oleum Paint for Plastic or equivalent	Rust-Oleum Paint for Plastic or equivalent	Rust-Oleum Paint for Plastic or equivalent

Dimensions – Enclosures

20" Enclosure

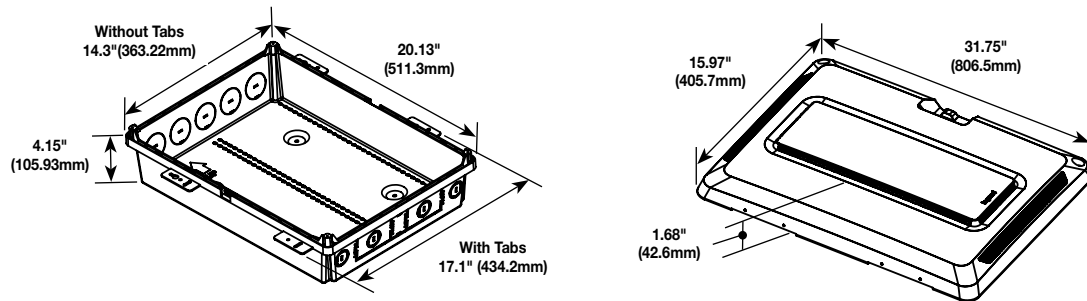

30" Enclosure

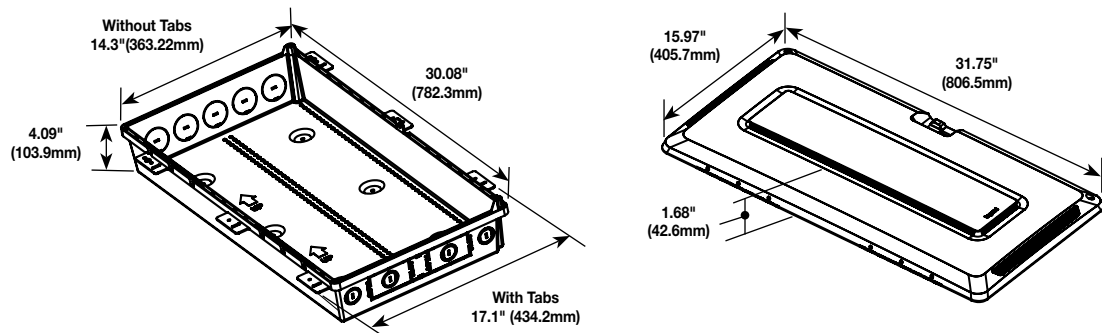

42" Enclosure

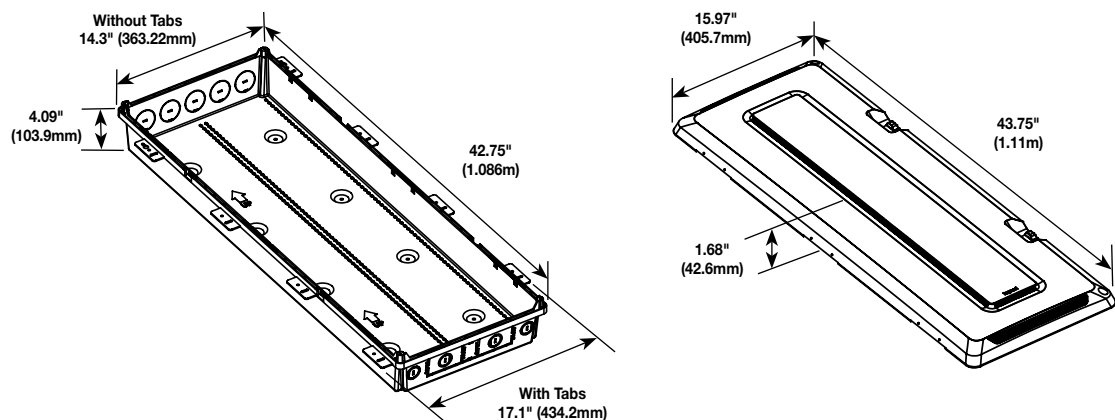

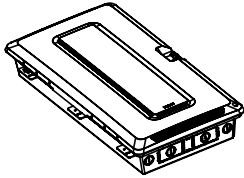
Ordering Information
Plastic Enclosure with Hinged Door

A complete assembly for an installation.

20" ENP2050
30" ENP3050
42" ENP4250

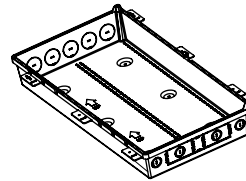
Plastic Enclosure

Separate rough-in and trim out phases by ordering enclosures and doors separately.

20" ENP2080
30" ENP3080
42" ENP4280

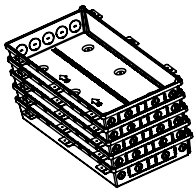
Plastic Enclosures (Pack of 5)

Neatly stacked enclosures, perfect for shipping to large projects.

20" ENP2080-5
30" ENP3080-5
42" ENP4280-5

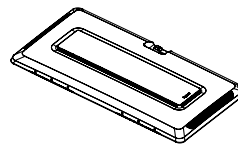
Plastic Door

Separate rough-in and trim out phases by ordering enclosures and doors separately.

20" ENP2060
30" ENP3060
42" ENP4260

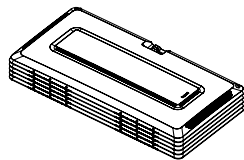
Plastic Doors (Pack of 5)

Neatly stacked doors, perfect for shipping to large projects.

20" ENP2060-5
30" ENP3060-5
42" ENP4260-5

2" Rubber Grommets for Plastic Enclosures (Pack of 5)

Covers top-facing knockout holes and protects cables.

AC1034

Technical Information

Trim Rings Specifications

	20" Trim Ring	30" Trim Ring	40" Trim Ring
Material	ABS Plastic	ABS Plastic	ABS Plastic
Color	White (Paintable*)	White (Paintable*)	White (Paintable*)
Specified Temperature	32°F - 122°F, 0°C - 50°C	32°F - 122°F, 0°C - 50°C	32°F - 122°F, 0°C - 50°C
Unit Weight	0.5 Lbs 0.227 kg	1 Lb 0.454kg	1 Lb 0.454kg
Shipping Weight	0.5 Lbs 0.227 kg	1 Lb 0.454kg	1 Lb 0.454kg
Paintable*	Rust-Oleum Paint for Plastic or equivalent	Rust-Oleum Paint for Plastic or equivalent	Rust-Oleum Paint for Plastic or equivalent

Dimensions – Trim Rings

ENP2001 – Plastic 20" Trim Ring

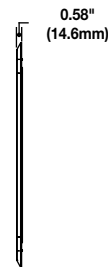
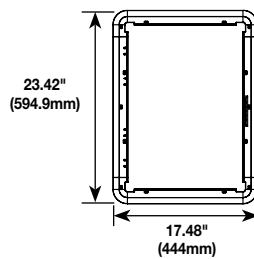
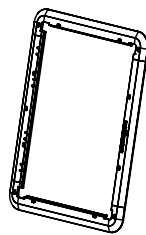

ENP3001 – Plastic 30" Trim Ring

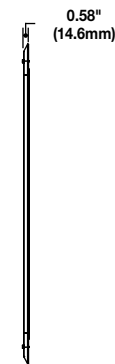
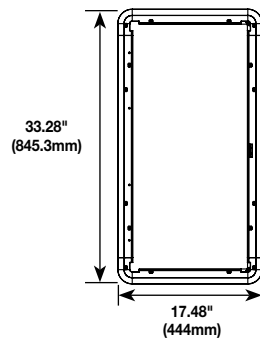
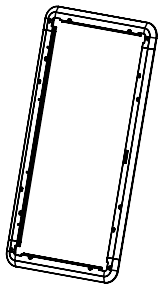

ENP4201 – Plastic 42" Trim Ring

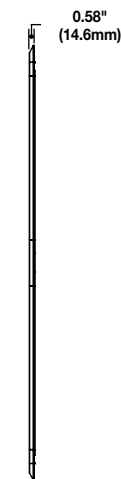
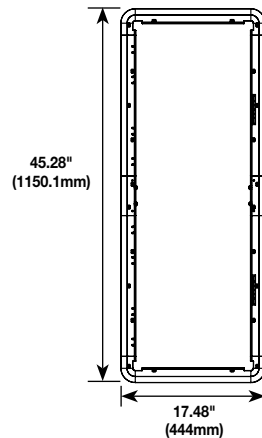
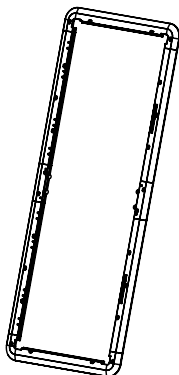

Technical Information

Accessories Specifications

	AC1040	AC1041	AC1035-20
Material	ABS Plastic	ABS Plastic	ABS Plastic
Color	White (Paintable*)	White (Paintable*)	White (Paintable*)
Specified Temperature	32°F - 122°F, 0°C - 50°C	32°F - 122°F, 0°C - 50°C	32°F - 122°F, 0°C - 50°C
Unit Weight	0.8 lbs. 0.36 kg.	0.6 lbs. 0.03 kg. (each spool)	0.01 Lbs 0.005kg
Shipping Weight	1.15 lbs. 0.41 kg.	0.12 lbs. 0.05 kg.	0.15 Lbs 0.07kg
Paintable*	N/A	N/A	N/A
Mounting	Mounts in Plastic Enclosure with included Plungers & Grommets (Quantity 4)	for Plastic or equivalent included Plungers & Grommets (Quantity 4)	Mounts in Plastic Enclosure with included Plungers & Grommets

Dimensions - Accessories

AC1040 - Universal Mounting Plate

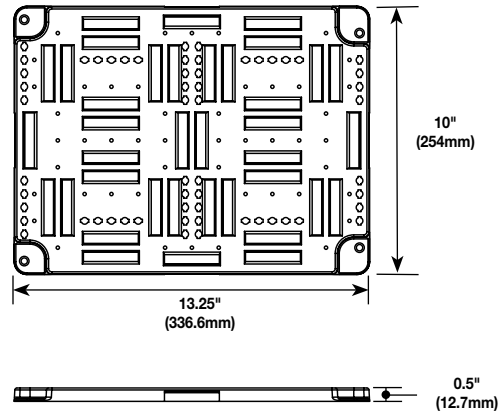
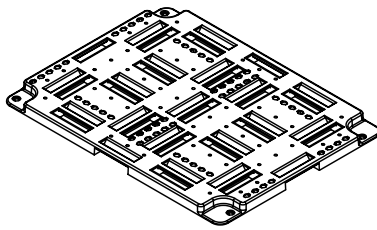

AC1041 - Fiber Management Spools

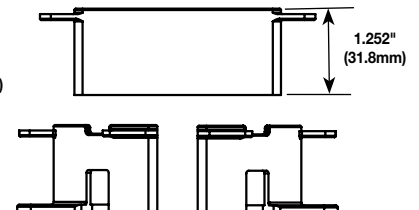
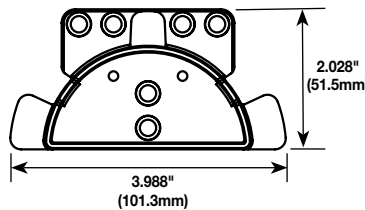
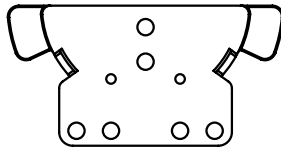
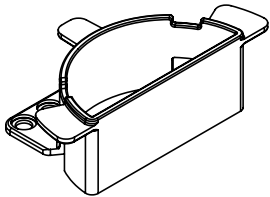

AC1035-20 - Cable Management Clips

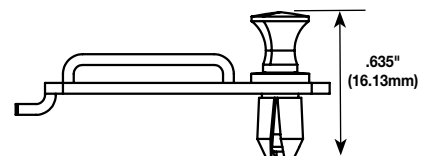
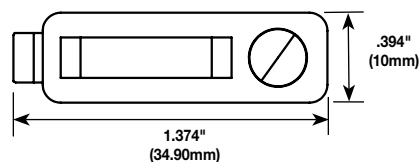
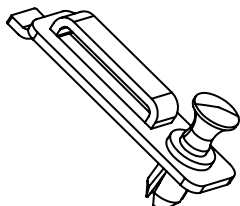

Ordering Information

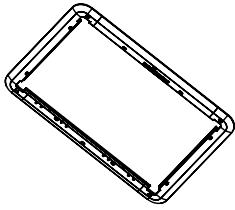

ENP2001 – 20" Trim Ring

Constructed from durable ABS Plastic and designed to conceal drywall imperfections creating a smooth transition to the finished wall surface. Trim Ring includes mounting hardware and cable tie clips.

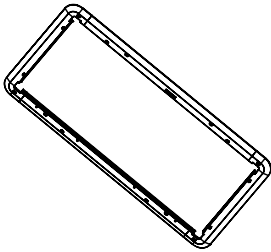

ENP3001 – 30" Trim Ring

Constructed from durable ABS Plastic and designed to conceal drywall imperfections creating a smooth transition to the finished wall surface. Trim Ring includes mounting hardware and cable tie clips.

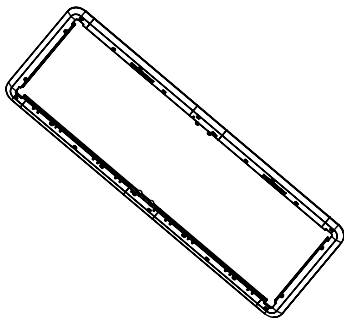

ENP4201 – 42" Trim Ring

Constructed from durable ABS Plastic and designed to conceal drywall imperfections creating a smooth transition to the finished wall surface. Trim Ring includes mounting hardware and cable tie clips.

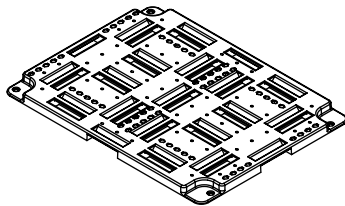

AC1040 – Universal Mounting Plate

Constructed from durable ABS Plastic and designed to securely mount a variety of devices. The Universal Mounting Plate includes (4) plungers and grommets and 4 feet of Velcro strapping.

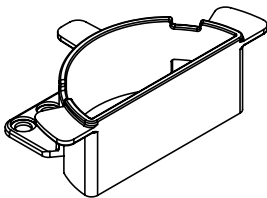

AC1041 – Fiber management Spools

Designed to neatly organize and manage fiber and category cabling within a structured wiring enclosure.

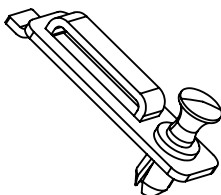

AC1035 – Cable Management Clips-Bulk Pack of 20

Designed to insert vertically into the enclosure mounting holes and easily secure with the included plunger/grommet – no tools necessary.

Featured Modules & Splitters

PATCH PANELS

AC1058	8-Port Cat 5e Network Interface Module
AC1068	8-Port Cat 6 Network Interface Module
AC1000	6-Port Cat 5e Network Interface Module
AC1001	6-Port Network Interface Module (Unpopulated)
AC1012	6-Port Cat 5e Network Interface Module
AC1013	6-Port Cat 6 Network Interface Module
AC1014	12-Port Cat 5e Network Interface Module
AC1015	12-Port Cat 6 Network Interface Module

DATA NETWORKING

DA1054	4-Port Gigabit Router/Switch
DA1008	8-Port Gigabit Switch

ACCESSORIES

364904-01	Universal Mounting Plate Full Width
364896-01	Universal Mounting Plate Half Width
AC1040	Universal Mounting Plate
AC1041	Fiber Management Spools
AC1035-20	20 Cable Management Clips
AC1042	MDU Mounting Bracket
PW1006	Twin Power Supply Bracket



VIDEO MODULES

VM1000	1 x 4 Passive Video Splitter/Combiner
VM1002	1 x 8 Passive Video Splitter/Combiner

VOICE MODULES

1267062-01-V1	6-Way Basic Telecom Module with RJ31X (110 Punchdown)
TM1045	10-Way Telecom Module with RJ31X (RJ45)
TM1110	10-Way Telecom Module with RJ31X (110 Punchdown)

VOICE & VIDEO COMBO MODULES

364400-04	Basic 6 x 4 Combo Module (110 Punchdown)
C01045	10 x 8 Combo with RJ31X (RJ45)
C01110	10 x 8 Combo with RJ31X (110 Punchdown)
C01156	Trio Combo Module with Cat5e Data
C01166	Trio Combo Module with Cat6 Data

POWER MANAGEMENT

AC1031	6-Port Power Strip, Half Width
364569-02-V1	Surge-Protected Duplex Power Kit
F7526	Duplex Power Kit

Vertical Markets

- Multi-Dwelling Units (MDU)
- Single Family Homes (SFH)

NOTE: All brand and product names referenced in this document are registered trademarks or trademarks of their respective holders.



NOTE: The paper used to print this document is an environmentally responsible paper with 10% post consumer waste, with FSC and SFI Chain of Custody certifications, Lacey Act compliant. 100% of the electricity used to manufacture Flo sheets is generated with Green-e certified renewable energy.



Legrand, North America
 60 Woodlawn Street
 West Hartford, CT 06110
 1.877.BY.LEGRAND (295.3472)
www.legrand.us

570 Applewood Crescent
 Vaughan, Ontario L4K 4B4
 905.738.9195
www.legrand.ca

FOLLOW US

