

CAUTION: TERMINATE TRACJACKS PER SPECIFIED WIRING SYSTEM 'T568A' or 'T568B'.

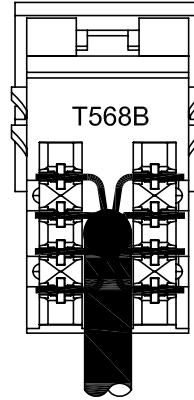
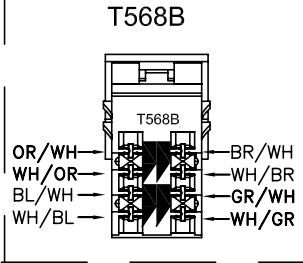
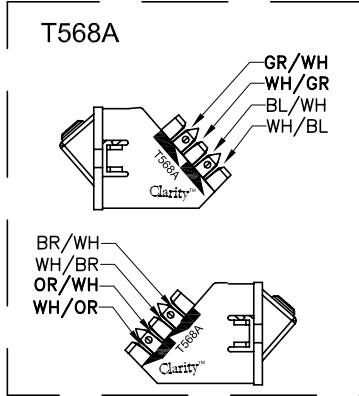

Alternate cable routing

NOTE: When terminating cables to TracJacks lace wires from the center to the outside of the module, and punch down with termination tool.

'This device is intended for indoor use on communication loop circuit which have been isolated from the Public Switched Telephone Network'

WIRING CHART

110 INSERT COLOR CODE	RJ45 T568A WIRING	RJ45 T568B WIRING
WHITE/BLUE	5	5
BLUE/WHITE	4	4
WHITE/ORANGE	3	1
ORANGE/WHITE	6	2
WHITE/GREEN	1	3
GREEN/WHITE	2	6
WHITE/BROWN	7	7
BROWN/WHITE	8	8

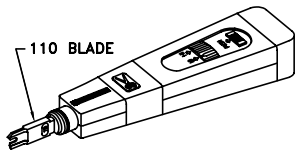

REQUIRED TERMINATION TOOL
 OR-60300005 (TOOL & BLADE)
 OR-60300006 (BLADE ONLY)

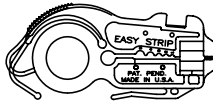

RECOMMENDED STRIPPING TOOL
 OR-60300032 (TOOL)

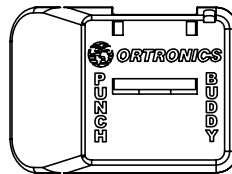

PUNCH BUDDY, TracJack holder supplied with full cartons of TracJacks or under part # TJPB5PK (5 pack)

TracJack Module Termination

- STEP 1: Feed station cables through faceplate. Mount faceplate to wall without modules installed.
- STEP 2: Strip 2" of cable jacket off station cables.
- STEP 3: Load TracJack as shown below, by sliding into accepting groove on Punch Buddy, until fully seated.
 Do not load TracJack from the top, this may damage TracJack or Punch Buddy.
- STEP 4: Lace color coded wire pairs into 110 termination.
- STEP 5: Place Punch Buddy short surface on solid flat surface, then using a single wire 110 tool terminate pairs. (see diagram below)
- STEP 6: Repeat steps 3 thru 5 until all TracJack Modules are terminated.
- STEP 7: Snap TracJack module into faceplate, or set TracJack module into base of surface mount box.

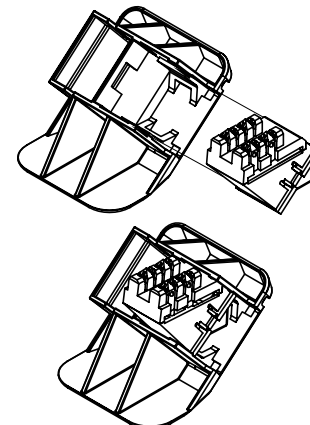
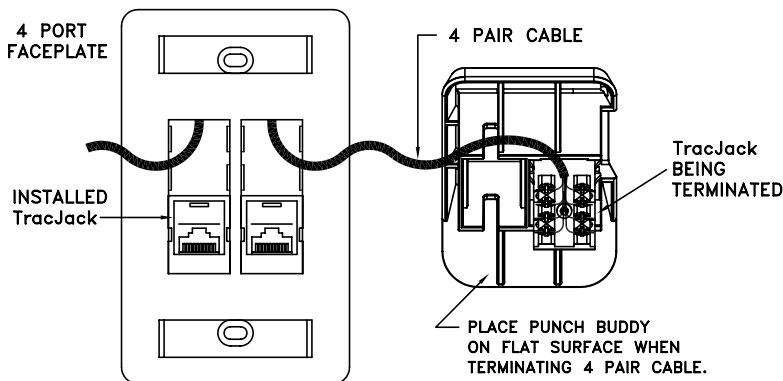

SLIDE TRACJACK INTO PUNCH BUDDY