

STRUCTURED WIRING & CONNECTIVITY GUIDE

STRUCTURED WIRING, CONNECTIVITY &
HOME THEATER SOLUTIONS

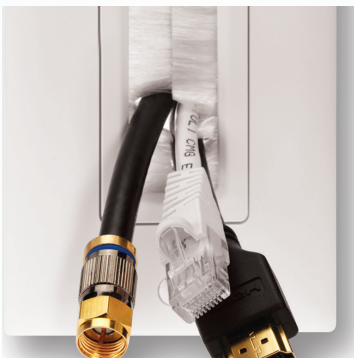



SUPERIOR

INFRASTRUCTURE SOLUTIONS

As the industry leader in structured wiring, Legrand provides the proven, practical solutions preferred by installers and major home builders across the country. Our comprehensive ON-Q product offering — which includes wall plates, jacks, HDMI cables, straps, tools, modules, enclosures & home theater solutions — simplifies installations and reduces time on site. We specialize in meeting the right specifications for any project — residential or light commercial — with solutions that exceed your needs. From single-family homes to apartments, townhomes to condominiums, Legrand has the professional answer for any project.



ENCLOSURES.....	4	HOME THEATER SOLUTIONS.....	25
PLASTIC ENCLOSURES.....	4	AV CABLING.....	26
METAL ENCLOSURES.....	11	HDMI CABLES.....	27
ACCESSORIES.....	7	AUDIO/VIDEO CABLES.....	28
VIDEO & VOICE DISTRIBUTION.....	13	PATCH CABLES.....	29
VOICE & VIDEO MODULES.....	13	CABLE TIES & PATCH PANELS.....	30
HOME NETWORKING.....	14	CABLE TIES / PATCH PANELS.....	30
NETWORK MODULES.....	14	INSTALLATION TOOLS & CONNECTORS.....	31
POWER MANAGEMENT.....	15	RESOURCES & SUPPORT.....	32
DATA CONNECTIVITY.....	16		
LOW VOLTAGE BRACKETS.....	16		
KEYSTONE WALL PLATES.....	17		
WALL PLATES.....	19		
STRAPS.....	21		
SURFACE MOUNT BOXES.....	21		
PRE-MOLDED WALL PLATES & STRAPS.....	22		
PRE-CONFIGURED PLATES & STRAPS.....	23		

ENCLOSURES

DUAL-PURPOSE ENCLOSURES

- The 9-in & 17-in Dual-Purpose In-Wall Enclosure are engineered to provide storage of structured wiring and AV components
- Constructed of Wi-Fi transparent material to manage wireless components and AV devices at point-of-use locations
- Available in 9-in. or 17-in. sizes, perfect for areas directly behind a TV or other media locations



PART NO.	DESCRIPTION
ENP0900-NA	Dual-Purpose 9" In-Wall Enclosure
ENP0905-NA-V1	DDual-Purpose 9" In-Wall Enclosure with 5" Mounting Plate
ENP1700-NA	Dual-Purpose 17" In-Wall Enclosure
ENP1705-NA-V1	Dual-Purpose 17" In-Wall Enclosure with 5" Mounting Plate



ENP0900-NA



ENP1700-NA



ENP0905-NA-V1



ENP1705-NA-V1

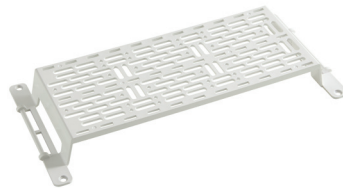
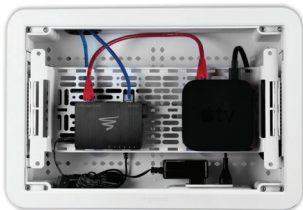

AC1050
5" Mounting Plate



ENCLOSURES

PLASTIC ENCLOSURES

- The ON-Q line of plastic enclosures provide Wi-Fi transparent infrastructure to properly organize, protect & support the home's wired and wireless connected systems
- Universal mounting grid maximizes compatibility with third party products without additional brackets
- Extra venting along vertical plane of door allows for superior heat dissipation
- Reversible door snaps easily into trim ring without tools, swings a full 180 degrees
- Lockable with included screws or Optional Keyed Lock (364478-01)

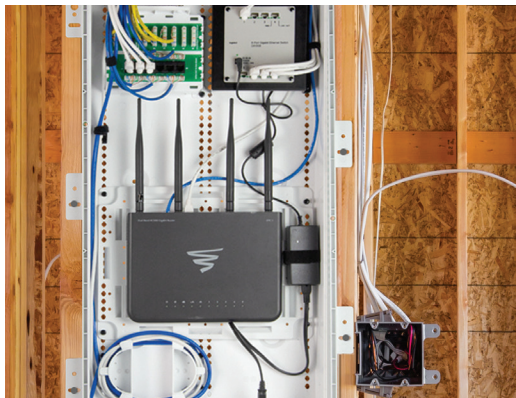

DESCRIPTION	20" Enclosure	30" Enclosure	42" Enclosure
Enclosure Dimensions	22.2" L x 17.5" W x 5.5" D	32.2" L x 17.5" W x 5.5" D	44.2" L x 17.5" W x 5.5" D
Plastic Enclosure with Hinged Door & Trim Ring	ENP2050-NA	ENP3050-NA	ENP4250-NA
Plastic Hinged Door & Trim Ring Only	ENP2060-NA	ENP3060-NA	ENP4260-NA
Plastic Enclosure Only	ENP2080-NA	ENP3080-NA	ENP4280-NA
Plastic Hinged Door & Trim Ring Only (Pack of 5)	ENP20605-NA	ENP30605-NA	ENP42605-NA
Plastic Enclosure Only (Pack of 5)	ENP20805-NA	ENP30805-NA	ENP42805-NA
Trim Ring, For Replacement Only	ENP2001-NA	ENP3001-NA	ENP4201-NA

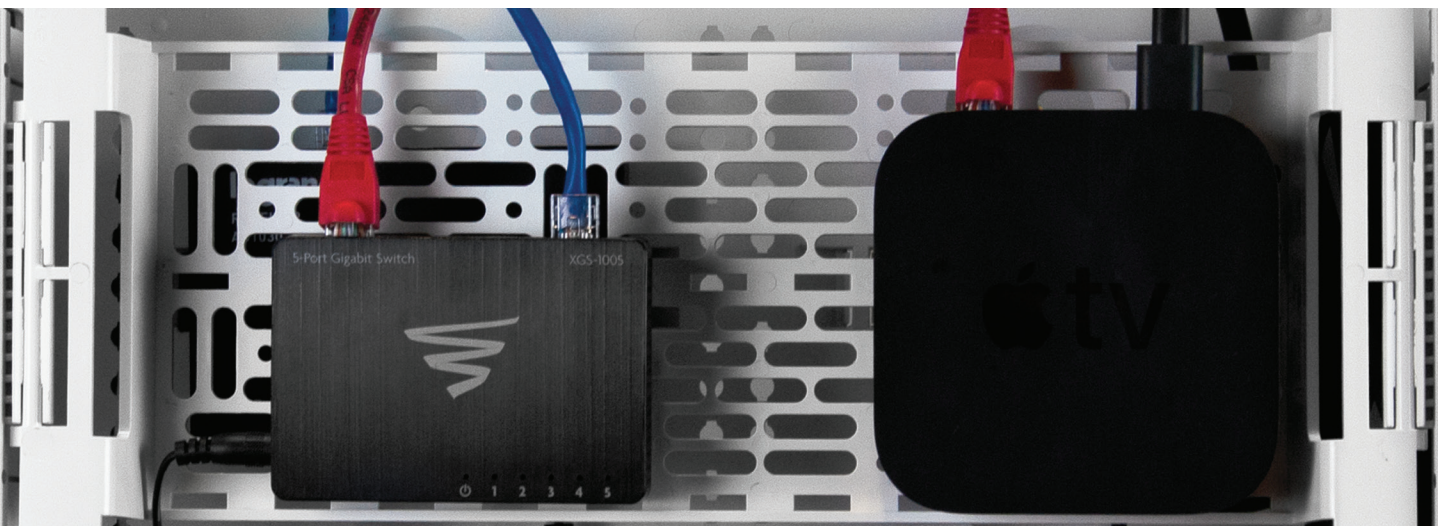

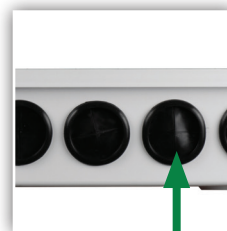

AC1034
2" RUBBER
GROMMET PACK

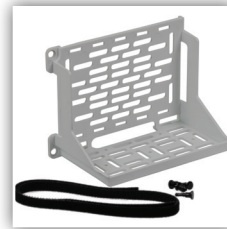

AC1060
SHELF MOUNTING
BRACKET

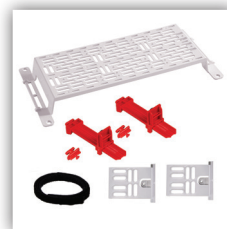









AC1050-EMK
5" ELEVATED MOUNTING
PLATE COMBO KIT

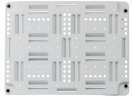

F7526
Duplex Power Kit

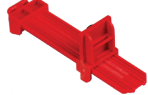

ENCLOSURE INSIDE DEVICE MOUNTING ACCESSORIES

	PART NO.	DESCRIPTION	DUAL PURPOSE ENCLOSURES	PLASTIC ENCLOSURES	METAL ENCLOSURES
	364896-01	UNIVERSAL MOUNTING PLATE, HALF WIDTH	●	●	●
	364904-01	UNIVERSAL MOUNTING PLATE, FULL WIDTH	●	●	●
	AC1040	PLASTIC UNIVERSAL MOUNTING PLATE	17 INCH ONLY	●	●
	AC1042	MDU MOUNTING BRACKET	●	●	●
	AC1043	DIN RAIL - HALF WIDTH	●	●	
	AC1050	5" MOUNTING PLATE WITH 1.5" OF ELEVATION	●	●	
	AC1050-EMK	5" ELEVATED MOUNTING PLATE COMBO KIT	●	●	
	AC1060	SHELF MOUNTING BRACKET, 10 PACK (AC1060-10)	●	●	●
	AC1060-L5	GATEWAY SHELF WITH GIGABIT NETWORK SWITCH	●	●	●
	AC1051-RC-20	FORWARD SMALL DEVICE MOUNTING CLAMP (PACK OF 20)	COMPATIBLE WITH: AC1050, AC1060, AC1052-CC		
	AC1051-RCKH-4	SMALL DEVICE MOUNTING CLAMP & KEYHOLE POST CLIPS (COMBO PACK)			
	AC1051-KH-20	FORWARD KEYHOLE POST CLIP (PACK OF 20)			

SECURITY MOUNTING & LEGACY ACCESSORIES

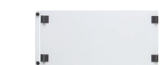
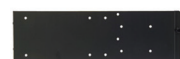
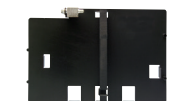

PART NO.	DESCRIPTION	DUAL PURPOSE ENCLOSURES	PLASTIC ENCLOSURES	METAL ENCLOSURES
363729-01	PLUNGERS & GROMMETS (10 PACK)	DESIGNED FOR STRUCTURED WIRING MODULES		
364254-01	CABLE MODEM MOUNTING PLATE	●	●	●
364259-01	CADDX MOUNTING PLATE	●	●	●
364465-01	DSC 1555 MOUNTING PLATE, HALF WIDTH	●	●	●
364466-01	DSC 832/1555 MOUNTING PLATE, FULL WIDTH	●	●	●
364516-01	CADDX NETWORKX SERIES MOUNTING PLATE <small>-NOT SHOWN</small>	●	●	●
364714-08	ADEMCO HALF WIDTH CONTROLLER MOUNTING PLATE	●	●	●
364715-01	ADEMCO UNIVERSAL CONTROLLER MOUNTING PLATE	●	●	●
364264-01	BATTERY HOLDER, HALF-WIDTH	●	●	●
364265-01	BATTERY HOLDER, FULL-WIDTH	●	●	●
364819-01	TWO BAY BRACKET	●	●	●
F7510	THREE BAY BRACKET	●	●	●
AC1011	UNIVERSAL CIRCUIT BOARD MOUNTING BRACKET	●	●	●
AC1020	THIRD-PARTY ENCLOSURE MOUNTING BRACKET	DESIGNED FOR 3 RD PARTY ENCLOSURES		



ENCLOSURE GROMMETS



PART NO.	DESCRIPTION	DUAL PURPOSE ENCLOSURES	PLASTIC ENCLOSURES	METAL ENCLOSURES
AC1034	2" RUBBER GROMMET PACK FOR PLASTIC ENCLOSURES (PACK OF 5)	●	●	
F2242	2.5" GROMMET RING			●
F2249	2.5" KNOCKOUT PLUG			●

LATCH AND LOCK KITS



PART NO.	DESCRIPTION	DUAL PURPOSE ENCLOSURES	PLASTIC ENCLOSURES	METAL ENCLOSURES
364478-01	REPLACEMENT LOCK ASSEMBLY & 2 KEY KIT		●	●
364490-01	REPLACEMENT KEY & COVER HARDWARE KIT			●
AC1019	LATCH LOCK KIT, HINGED COVER		●	●

CABLE MANAGEMENT



PART NO.	DESCRIPTION	DUAL PURPOSE ENCLOSURES	PLASTIC ENCLOSURES	METAL ENCLOSURES
363491-01	VELCRO TIE STRAP (PACK OF 50)	●	●	●
AC1035-20	CABLE MANAGEMENT CLIPS (PACK OF 20)	●	●	
AC1041	FIBER MANAGEMENT SPOOLS (PAIR)	●	●	●
AC1052-CC-2	CABLE CHANNEL (PACK OF 2)		●	



ENCLOSURES

METAL ENCLOSURES

- Flush and surface installation options
- Flanged covers hide drywall openings
- UL listed for fire and security alarm equipment
- Made in the USA
- Cable guard insert protects cables and equipment from dust, paint and debris between rough-in and trim out
- Includes 3 powder-coated openings for cable pass-through



DESCRIPTION	12" Enclosure	14" Enclosure	20" Enclosure	28" Enclosure	42" Enclosure
Enclosure Dimensions	12.13"H x 14.25" W x 3.6"D	14" H x 14.25" W x 3.6" D	20" H x 14.25" W x 3.6" D	28" H x 14.25" W x 3.6" D	42" H x 14.25" W x 3.6" D
Enclosure with Screw-On Cover	EN1200	EN1400	EN2000	EN2800	EN4200
Enclosure with Hinged Cover	N/A	EN1450	EN2050	EN2850	EN4250
Enclosure, Only	N/A	EN1480	EN2080	EN2880	EN4280
Screw On Cover, Only	EN1220	EN1420	EN2020	EN2820	EN4220
Hinged Cover, Only	N/A	EN1460	EN2060	EN2860	EN4260
Enclosure Only, with Stackable Knockouts*	N/A	EN1485	EN2085	EN2885	EN4285
Enclosure Depth Extender**	N/A	N/A	N/A	364450-03	364450-04
Enclosure Extender Wire Manager	N/A	N/A	N/A	364482-01	364482-01

* This enclosure has five knockout locations and allows vertical alignment of two enclosures for cable pass-through.

** Extenders add 2.5" of enclosure depth.

ENCLOSURES

- Knockouts include screwdriver holes for easy removal
- Includes four self-tapping screws for mounting and optional hardware to lock the cover
- Multiple compatible video, voice, and data distribution modules available
- Flush and surface-mount installation options



EN0800



EN0801



EN0802



EN0806



EN0803



EN0804

PLASTIC MDU ENCLOSURE

PART NO.	DESCRIPTION
EN0800	8-Inch MDU Enclosure with Cover
EN0801	8-Inch MDU Enclosure Cover
EN0802	8-Inch MDU Enclosure Kit (6 phone, 4 video)
	INCLUDES: (1) ENCLOSURE AND COVER, (1) 6-WAY PHONE MODULE TM0106, (1) 4-WAY COAX SPLITTER VM0204
EN0803	8-Inch MDU Enclosure Kit (6 phone, 4 video)
	INCLUDES: (1) ENCLOSURE AND COVER, (1) 6-WAY PHONE MODULE TM0106, (1) 6-PORT CAT 5E DATA BOARD AC0506, (1) 4-WAY COAX SPLITTER VM0204
EN0804	8-Inch MDU Enclosure Kit (6 phone, 4 video)
	INCLUDES: (1) ENCLOSURE AND COVER, (1) 6-WAY PHONE MODULE TM0106, (1) 6-PORT CAT 6 DATA BOARD AC06 06, (1) 4-WAY COAX SPLITTER VM0204
EN0806	8-Inch MDU Enclosure Bulk Pack (6)



AC1042



AC0506



AC0606



TM0106



TM0404



VM0104



VM0106



VM0108



VM0204



VM0206







VM0208

MDU ENCLOSURE MODULES

PART NO.	DESCRIPTION
AC1042	MDU Mounting Bracket
AC0506	6-Port Cat 5e Data Board (For use with EN0800)
AC0606	6-Port Cat 6 Data Board (For use with EN0800)
TM0106	6-Way Telephone Board (For use with EN0800)
TM0404	Combo 4-Way Phone / 4 Port Cat 5e Data Board (For use with EN0800)
VM0104	4-Way Vertical 1 GHz Splitter (For use with EN0800)
VM0106	6-Way Vertical 1 GHz Splitter (For use with EN0800)
VM0108	8-Way Vertical 1 GHz Splitter (For use with EN0800)
VM0204	4-Way Vertical 2 GHz Splitter (For use with EN0800)
VM0206	6-Way Vertical 2 GHz Splitter (For use with EN0800)
VM0208	8-Way Vertical 2 GHz Splitter (For use with EN0800)

VIDEO & VOICE DISTRIBUTION

COMBO MODULES

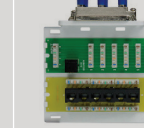
DESCRIPTION	Basic 6x4 Combo (110 Punchdown)	10x8 Combo with RJ31X (RJ45)	10x8 Combo with RJ31X (110 Punchdown)	10x8 Combo with RJ31X MoCA Optimized	Trio Combo Module with Cat5e Data	Trio Combo Module with Cat6e Data
						
PART NO.	364400-04	CO1045	CO1110	CO2110-V1	CO1156	CO1166
Telecom Outlets	6	10	10	10	6	6
Video Outlets	4	8	8	8	8	8
Telecom Connections	110 Punchdown	RJ45	110 Punchdown	110 Punchdown	110 Punchdown	110 Punchdown
RJ31X Line Seizure	N	Y	Y	Y	Y	Y
Bandwidth	1 GHz	1 GHz	1 GHz	1.675 GHz	2 GHz	2 GHz
Dimensions	5 1/8" x 6 1/2"	5 1/8" x 6 1/2"	5 1/8" x 6 1/2"	5 1/8" x 6 1/2"	6 3/4" x 6 1/2"	6 3/4" x 6 1/2"

VOICE MODULES

PART NO.	DESCRIPTION
TM1110	10-Way IDC Telephone Module with RJ31X
TM1045	10-Way RJ45 Telephone Module with RJ31X
1267062-01-V1	6-Way Basic Telecom Module with RJ31X



TM1110



TM1045



1267062-01-V1



VM1000



VM1002

VIDEO MODULES

PART NO.	DESCRIPTION
VM1000	1x4 Enhanced Passive Video Splitter/Combiner
VM1002	1x8 Enhanced Passive Video Splitter/Combiner

VIDEO SPLITTERS

PART NO.	DESCRIPTION
VM2201-V1	Single-Port RF Digital Cable Amplifier
NOTE: POWER SUPPLY INCLUDED	
VM2202-V1	Two-Way Digital Cable Splitter with Coax Network Support
VM2203-V1	Three-Way Digital Cable Splitter with Coax Network Support
VM2204-V1	Four-Way Digital Cable Splitter with Coax Network Support



VM2201-V1



VM2202-V1



VM2203-V1



VM2204-V1



VM2200-V1

VIDEO ACCESSORIES

PART NO.	DESCRIPTION
VM2200-V1	Coax Network Signal Blocker

HOME NETWORKING



AC1000



AC1001



AC1012



AC1013



AC1014



AC1015



AC1058



AC1068



AC106A6

PART NO.	DESCRIPTION
AC1000	6-Port Cat 5e Network Interface Module
AC1001	6-Port Network Interface Module (Unpopulated)
AC1012	6-Port Cat 5e Network Interface Module
AC1013	6-Port Cat 6 Network Interface Module
AC1014	12-Port Cat 5e Network Interface Module
AC1015	12-Port Cat 6 Network Interface Module
AC1058	8-Port Cat 5e Network Interface Module
AC1068	8-Port Cat 6 Network Interface Module
AC106A6	6 Port Cat 6a Network Interface Module

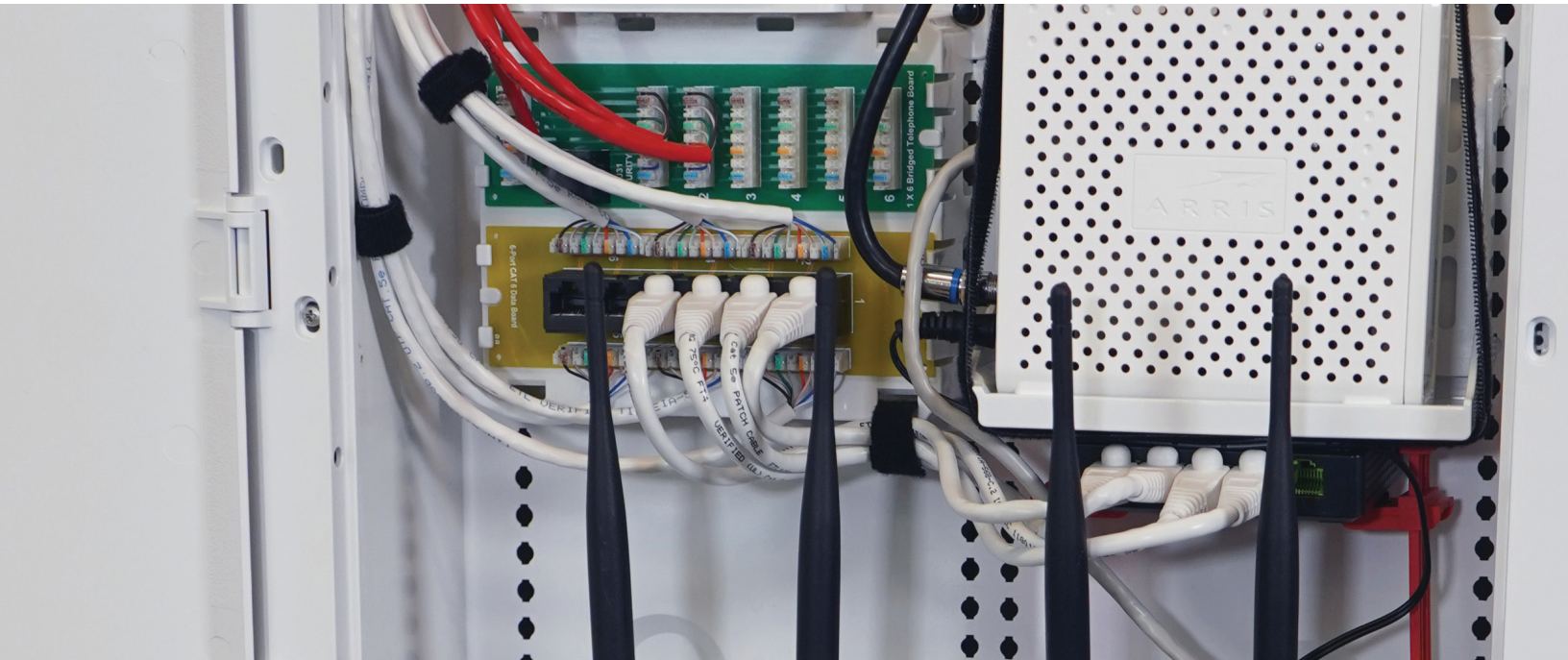

POWER MANAGEMENT

POWER SUPPLIES



PART NO.	DESCRIPTION
PW7760	12VDC, 18W Power Supply
PW7725	12VDC, 30W Power Supply
PW1030	24VDC, 30W Power Supply
PW1060	24VDC, 60W Power Supply
PW1458	48VDC, 60W Power Supply

ACCESSORIES



PART NO.	DESCRIPTION
364569-02-V1	Surge Protected Duplex Power Kit INCLUDES: (1) SURGE PROTECTED DUPLEX OUTLET, (1) METAL JUNCTION BOX, AND (1) FACEPLATE KIT NOTE: TAMPER RESISTANT
F7526	Duplex Power Kit INCLUDES: (1) DUPLEX OUTLET, (1) METAL JUNCTION BOX AND (1) FACEPLATE KIT NOTE: TAMPER RESISTANT
PW1006	Twin Power Supply Bracket

POWER MODULES



PART NO.	DESCRIPTION
AC1031	Enclosure Power Strip Module, Half Width

KITS



PART NO.	DESCRIPTION
PW1120	24VDC, 120W Power Supply Kit INCLUDES: (2) 24VDC, 60W POWER SUPPLIES (PW1060), (1) MOUNTING BRACKET (PW1006), (1) CUSTOM POWER STRIP, AND VELCRO STRAPS

DATA CONNECTIVITY

LOW VOLTAGE BRACKETS

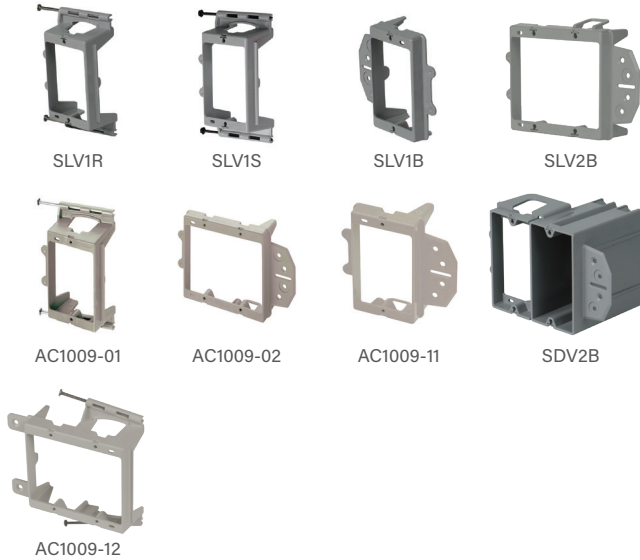

NEW CONSTRUCTION

PART NO.	DESCRIPTION
SLV1R	1-Gang, LV Bracket w/Nail, with Quick/Click®
SLV1S	1-Gang, LV Bracket w/Screw, with Quick/Click®
PLV1S	1-Gang, LV Bracket w/Screw, New Const.
SLV1B	1-Gang, LV Bracket Face Mount, with Quick/Click®
SLV2B	2-Gang, LV Bracket Face Mount, with Quick/Click®
AC1009-01	1-Gang, LV Bracket w/Nail, New Const.
AC1009-02	2-Gang, LV Bracket, Face Mount, New Const.
AC1009-11	1-Gang, LV Bracket, Face Mount, New Const.
AC1009-12	2-Gang, LV Bracket w/Nail, New Const.
SDV2B	2-Gang, LV Bracket, Face Mount, with Quick/Click®
PDV2B	2-Gang, LV Bracket, Face Mount
P100ND	1-Gang Slide Mount LV Bracket

RETROFIT

PART NO.	DESCRIPTION
SLV1W	1-Gang, Metal Wing, with Quick/Click®
AC1010-01	1-Gang, LV Bracket, Retrofit
SLV2W	2-Gang, Metal Wing, with Quick/Click®
AC1010-02	2-Gang, LV Bracket, Retrofit
SLV3W	3-Gang, Metal Wing, with Quick/Click®
AC1010-03	3-Gang, LV Bracket, Retrofit
P100WD	1-Gang LV Bracket Extender

DIVIDERS AND EXTENDERS

PART NO.	DESCRIPTION
LVDIV-1	LV Box Divider (12 Pack)
EXT1	1-Gang, 1/4" Box Extender (10 Pack)
EXT2	2-Gang, 1/4" Box Extender (10 Pack)

CRAFTED WITH DURABLE HEAVY-DUTY PLASTIC, ON-Q LV BRACKETS FEATURE AN OPEN BACK AND AN INTEGRATED CABLE MANAGEMENT SYSTEM FOR CLEAN CONNECTIONS AND EASY INSTALLATION.



DATA CONNECTIVITY

KEYSTONE INSERTS



PUNCH & GO TOOL

- SEAT AND CUT ALL WIRES AT ONCE WITH A SQUEEZE OF THE HANDLE.
- CONSISTENT TERMINATIONS EVERY TIME.
- NO MORE COMPROMISED CONNECTIONS OR WASTED JACKS.
- NEVER AGAIN PUNCH INTO THE PALM OF YOUR HAND OR THROUGH DRYWALL. THE AC3400 IS FOR USE EXCLUSIVELY WITH OUR LINE OF WP3475, WP3476 AND WP346A QUICK CONNECT JACKS.

QUICK CONNECT INSERTS

PART NO.	DESCRIPTION
AC3400	Punch & Go Tool IMPROVES TERMINATION SPEEDS, REDUCES COMPROMISED CONNECTIONS AND INCREASES PRODUCTIVITY OF ANY QUICK CONNECT DATA INSERT.
AC3401	Punch & Go Tool Replacement Blade
WP346a-XX	Cat 6a Quick Connect RJ45 Keystone Insert
WP3473-XX	RJ25 6-Position, 6-Conductor Telephone Keystone Insert 10 COUNT BULK PACKS IN WH AND LA (WP3473-XX-10)
COLORS: BK, BR, GY, IV, LA, WH	
WP3475-XX	Cat 5e Quick Connect RJ45 Keystone Connector 10 COUNT BULK PACKS IN WH AND LA (WP3475-XX-10) 50 COUNT BULK PACKS IN WH, LA AND BE (WP3475-XX-50) 100 COUNT BULK PACKS IN WH (WP3475-WH-100) *100 PACK INCLUDES AC3400 PUNCH & GO TOOL
COLORS: BE, BK, BR, GY, GN, IV, LA, OR, RE, WH, YE	
WP3476-XX	Cat 6 Quick Connect RJ45 Keystone Connector 10 COUNT BULK PACKS IN WH, LA (WP3476-XX-10) 50 COUNT BULK PACKS IN WH, LA AND BE (WP3476-XX-50) 100 COUNT BULK PACKS IN WH (WP3476-WH-100)
COLORS: BE, BK, BR, GY, IV, LA, OR, RE, WH NOTE: THESE INSERTS ARE COMPATIBLE WITH THE AC3400 PUNCH & GO TOOL WHICH ALLOW FOR ALL WIRES TO BE TERMINATED AT ONCE.	

OTHER INSERTS

PART NO.	DESCRIPTION
WP3425-XX	RJ25 6P6C Keystone Connector COLORS: BK, BR, IV, LA, WH
WP3450-XX	Cat 5e RJ45 Keystone Connector COLORS: BE, BK, BR, GY, IV, LA, OR, RE, WH
WP3451-XX	Cat 5e RJ45 Keystone Coupler COLORS: BK, WH
WP3458-XX	Cat 5e Keyed RJ45 Keystone Connector COLORS: BK, BR, IV, LA, WH
WP3460-XX	Cat 6 RJ45 Keystone Connector
WP3550-XX	Snap & Go Cat 5e Keystone Connector
WP3560-XX	Snap & Go Cat 6 Keystone Connector COLORS: BE, BK, BR, GY, IV, LA, OR, RE, WH

COAX VIDEO INSERTS

PART NO.	DESCRIPTION
WP3479-XX	Non-Recessed Coax Keystone F-Connector (1 GHz) 10 COUNT BULK PACKS IN WH OR LA (WP3479-XX-10) 50 COUNT BULK PACK IN WH OR LA (WP3479-XX-50)
WP3480-XX	Recessed Gold F-Connector (3 GHz)
WP3481-XX	Recessed Nickle F-Connector (3 GHz) 10 COUNT BULK PACKS IN WH OR LA (WP3481-XX-10) 50 COUNT BULK PACK IN WH (WP3481-WH-50)
WP3482-XX	Recessed Self-Terminating Keystone F-Connector (1 GHz) COLORS: BK, BR, IV, LA, WH

COLOR KEY:

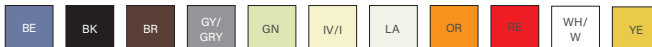

NOTE: Suffixes should be added to the end of all applicable part numbers.

DATA CONNECTIVITY



WP3461-WH



WP3462-WH



WP3463-WH



WP3464-WH



WP3465-WH



WP3466-WH



WP124K-XX



WP3455-WH



WP1215-WH



WP3457-WH



WP3456-WH



KSRCAYW



KSRCARW



KSRCABW



KSRCABEW



KSRCAGNW



WP1220-WH



WP1221-WH



WP1210-WH



WP1211-WH



KSSCW



KSSCTW

KEYSTONE AUDIO/VIDEO INSERTS

PART NO.	DESCRIPTION
WP3461-XX	White Keystone RCA-to-F Connector
WP3462-XX	Red Keystone RCA-to-F Connector
WP3463-XX	Green Keystone RCA-to-F Connector
WP3464-XX	Blue Keystone RCA-to-F Connector
WP3465-XX	Yellow Keystone RCA-to-F Connector
WP3466-XX	Purple Keystone RCA-to-F Connector

COLORS: BK, BR, IV, LA, WH

WP124K-XX	4k HDMI Keystone Coupler 10 COUNT BULK PACK IN WH (WP124K-WH-10)
WP3455-XX	Blank Keystone Insert
WP1215-XX	3.5MM Stereo Coupler
WP3457-XX	Audio Keystone Binding Post (Pair)
WP3456-XX	Speaker Keystone Binding Post

COLORS: BK, BR, IV, LA, WH

KSRCAYW	Keystone RCA-to-RCA (Yellow Insulator)
---------	--

COLORS: IV, LA, WH

KSRCARW	Keystone RCA-to-RCA (Red Insulator)
---------	-------------------------------------

COLORS: IV, LA, WH

KSRCABW	Keystone RCA-to-RCA (Black Insulator)
---------	---------------------------------------

COLORS: IV, LA, WH

KSRCABEW	Keystone RCA-to-RCA (Blue Insulator)
----------	--------------------------------------

COLORS: WH

KSRCAGNW	Keystone RCA-to-RCA (Green Insulator)
----------	---------------------------------------

COLORS: WH

USB & FIBER INSERTS

PART NO.	DESCRIPTION
WP1220-XX	USB 2.0 A/A Coupler

COLORS: BK, BR, IV, LA, WH

WP1221-XX	USB 2.0 A/B Adapter
-----------	---------------------

COLORS: BK, BR, IV, LA, WH

WP1210-XX	MTRJ Coupler MM
-----------	-----------------

COLORS: IV, LA, WH

WP1211-XX	LC Coupler MM
-----------	---------------

COLORS: IV, LA, WH

KSSCXX	SC Coupler MM
--------	---------------

COLORS: IV, LA, WH

KSSTXX	ST Coupler MM
--------	---------------

COLORS: IV, LA, WH

DATA CONNECTIVITY



WP3401-WH WP3402-WH WP3403-WH WP3404-WH



WP3406-WH WP3212-WH



WP3401-SS WP3402-SS WP3403-SS WP3406-SS



WP3300-WH WP3301-WH WP3302-WH WP3303-WH



WP3304-WH WP3306-WH



KTPDL1W KTPDL2W KTPDL3W KTPDL4W KTPDL6W

KEYSTONE WALL PLATES

PART NO.	DESCRIPTION
WP3401-XX	1-Gang, 1-Port Wall Plate 10 COUNT BULK PACK IN WH OR LA (WP3401-XX-10) 25 COUNT BULK PACK IN WH OR LA (WP3401-XX-25)
WP3402-XX	1-Gang, 2-Port Wall Plate 10 COUNT BULK PACK IN WH OR LA (WP3402-XX-10) 25 COUNT BULK PACK IN WH OR LA (WP3402-XX-25)
WP3403-XX	1-Gang, 3-Port Wall Plate 10 COUNT BULK PACK IN WH (WP3403-WH-10)
WP3404-XX	1-Gang, 4-Port Wall Plate
WP3406-XX	10 COUNT BULK PACK IN WH (WP3404-WH-10)

COLORS: BK, BR, IV, LA, WH, GY

WP3212-XX	2-Gang, 12-Port Wall Plate
-----------	----------------------------

COLORS: IV, LA, WH

DIMENSIONS: 1-GANG: 2.9375" X 4.6875" 2-GANG: 8.375" X 4.6875"

STAINLESS STEEL WALL PLATES

PART NO.	DESCRIPTION
WP3401-SS	1-Gang, 1-Port Wall Plate, Stainless Steel
WP3402-SS	1-Gang, 2-Port Wall Plate, Stainless Steel
WP3403-SS	1-Gang, 3-Port Wall Plate, Stainless Steel
WP3404-SS	1-Gang, 4-Port Wall Plate, Stainless Steel
WP3406-SS	1-Gang, 6-Port Wall Plate Stainless Steel

DIMENSIONS: 1-GANG: 2.9375" X 4.6875"

OVERSIZED WALL PLATES

PART NO.	DESCRIPTION
WP3300-XX	1-Gang, Blank Oversized Wall Plate
WP3301-XX	1-Gang, 1-Port Oversized Wall Plate 10 COUNT BULK PACK IN WH (WP3301-WH-10)
WP3302-XX	1-Gang, 2-Port Oversized Wall Plate 10 COUNT BULK PACK IN WH (WP3302-WH-10)
WP3303-XX	1-Gang, 3-Port Oversized Wall Plate
WP3304-XX	1-Gang, 4-Port Oversized Wall Plate
WP3306-XX	1-Gang, 6-Port Oversized Wall Plate

COLORS: WH, LA

DIMENSIONS: 1-GANG: 3.3125" X 5.0625

LABELED WALL PLATES

PART NO.	DESCRIPTION
KTPDL1XX	1-Gang, 1-Port Keystone Labeled Wall Plate
KTPDL2XX	1-Gang, 2-Port Keystone Labeled Wall Plate
KTPDL3XX	1-Gang, 3-Port Keystone Labeled Wall Plate
KTPDL4XX	1-Gang, 4-Port Keystone Labeled Wall Plate
KTPDL6XX	1-Gang, 6-Port Keystone Labeled Wall Plate

COLORS: I, LA, W

DIMENSIONS: 1-GANG: 2.9375" X 4.6875"

COLOR KEY:

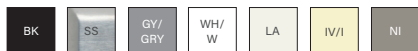

NOTE: Suffixes should be added to the end of all applicable part numbers.

DATA CONNECTIVITY

WALL PLATES



TP13W



TP23W



TP26W

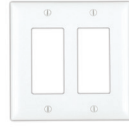

TP262W

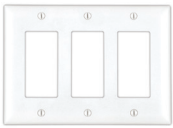

TP263W



TP264W

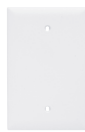

TPJ13W



TPJ26W



TPJ262W



TPJ263W

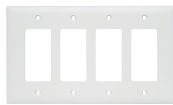

TPJ264W



RWP26XX



RWP262XX



RWP263XX



RWP264XX

STANDARD DECORATOR WALL PLATES

PART NO.	DESCRIPTION
TP13XXX	1-Gang Blank Wall Plate
TP23XXX	2-Gang Blank Wall Plate
TP26XXX	1-Gang Decorator Wall Plate
TP262XXX	2-Gang Decorator Wall Plate
TP263XXX	3-Gang Decorator Wall Plate
TP264XXX	4-Gang Decorator Wall Plate

COLORS: BK, I, LA, W, GRY (FOR BROWN, LEAVE BLANK)
 DIMENSIONS: 1-GANG: 2.9375" x 4.6875" 2-GANG: 4.75" x 4.6875"
 3-GANG: 6.563" x 4.6875 4-GANG: 8.375" x 4.6875"

JUMBO DECORATOR WALL PLATES

PART NO.	DESCRIPTION
TPJ13XXX	Jumbo 1-Gang Blank Wall Plate
TPJ26XXX	Jumbo 1-Gang Wall Plate
TPJ262XXX	Jumbo 2-Gang Wall Plate
TPJ263XXX	Jumbo 3-Gang Wall Plate
TPJ264XXX	Jumbo 4-Gang Wall Plate

COLORS: BK, I, LA, W, GRY (FOR BROWN, LEAVE BLANK)
 DIMENSIONS: 1-GANG: 3.3125" x 5.0625" 2-GANG: 5.125" x 5.0625"
 3-GANG: 6.9375" x 5.0625" 4-GANG: 8.75" x 5.0625"

RADIANT WALL PLATES

PART NO.	DESCRIPTION
RWP26XX	Screwless Wall Plate, 1-Gang
RWP262XX	Screwless Wall Plate, 2-Gang
RWP263XX	Screwless Wall Plate, 3-Gang
RWP264XX	Screwless Wall Plate, 4-Gang

COLORS: W, LA, I, GRY, BK, NICC6, DBCC6 (FOR BROWN, LEAVE BLANK)

COLOR KEY:



NOTE: Suffixes should be added to the end of all applicable part numbers. OMIT COLOR CODE TO ORDER BROWN DEVICE.



DATA CONNECTIVITY

STRAPS



WP3410-WH



WP3411-WH



WP3412-WH



WP3413-WH



WP3414-WH



WP3416-WH

PART NO.	DESCRIPTION
WP3410-XX	Blank Decorator Outlet Strap
WP3411-XX	1-Port Decorator Outlet Strap
	10 COUNT BULK PACK IN WH (WP3411-WH-10)
WP3412-XX	2-Port Decorator Outlet Strap
	10 COUNT BULK PACK IN WH (WP3412-WH-10)
WP3413-XX	3-Port Decorator Outlet Strap
	10 COUNT BULK PACK IN WH (WP3413-WH-10)
WP3414-XX	4-Port Decorator Outlet Strap
WP3416-XX	6-Port Decorator Outlet Strap

COLORS: BK, BR, IV, LA, WH, GY

SURFACE MOUNT BOXES



WP3409-WH



WP3501-WH



WP3502-WH



WP3504-WH

PART NO.	DESCRIPTION
WP3409-XX	Single Gang Surface Mount Box
WP3501-XX	Surface Mount Box 1-Port
WP3502-XX	Surface Mount Box 2-Port
WP3504-XX	Surface Mount Box 4-Port
WP3506-XX	Surface Mount Box 6-Port

COLORS: IV, LA, WH



WP3506-WH



A DEVICE OF
the
radiant[®]
collection



DATA CONNECTIVITY

PRE-MOLDED WALL PLATES & STRAPS



PART NO.	DESCRIPTION
TPTE1XX	2-Line Telephone Jack Wall Plate (4 Conductor Configuration)
COLORS:	BK, I, LA, W, GRY
TPTE2XX	Dual 2-Line Telephone Jack Wall Plate (4 Conductor Configuration)
COLORS:	BK, I, LA, W
WMTE14X	Modular Wall Mount Telephone Jack for Hanging Phones
COLORS:	W, LA, I
SMTE14I	Surface Mount Modular 2-Line Telephone Jack (4 Conductor Configuration)
COLORS:	I
TPCATVXX	1 GHz Coaxial Connector & Wall Plate
COLORS:	I, LA, W, BK
TPCATV2XX	Dual 1 GHz Coaxial Connector Wall Plate
COLORS:	I, LA, W, BK
TPTELVXX	1 GHz Coaxial Connector & 2-Line Phone Jack Wall Plate
COLORS:	I, LA, W, BK
26TELVCC10	1 GHz Coaxial Connector & 2-Line Phone Jack with 1-Piece Molded Decorator Plate
COLORS:	BK, I, LA, W
WP2002-WH	1-Gang 6P6C RJ25 Terminating Wall Phone Plate
COLORS:	WH
WP3467-XX	Keystone Wall Phone Plate
COLORS:	WH, SS (Stainless Steel)
26TE14XX	Decorator 2-Line Telephone Jack (4 Conductor Configuration)
COLORS:	I, LA, W
26TE16XX	Decorator 3-Line Telephone Jack (6 Conductor Configuration)
COLORS:	I, W
26CATVXX	Decorator 1GHz Coaxial Connector
COLORS:	I, LA, W

PRE-CONFIGURED PLATES & STRAPS



PART NO.	DESCRIPTION
WP3210-XX	1-Port Strap, 1RJ45
WP3211-XX	2-Port Strap Phone/TV
WP3220-XX	2-Port Strap Phone/Data
WP3422-XX	4-Port Strap Phone/Data, TV/AUX
COLORS:	BK, LA, WH

COLOR KEY:



NOTE: Suffixes should be added to the end of all applicable part numbers. OMIT COLOR CODE TO ORDER BROWN DEVICE.



HOME THEATER SOLUTIONS

HOME THEATER WALL PLATES & STRAPS



F9004-WH



F9005-WH



F9006-WH



F9008-WH-V1



WP9009-XX-V1



WP1011-WH

PART NO.	DESCRIPTION
F9004-XX	5.1 Home Theater Strap
COLORS:	BK, BR, IV, LA, WH
F9005-XX	2-Speaker Connection Strap
COLORS:	BK, BR, IV, LA, WH
F9006-XX	Single Speaker Connection Strap
COLORS:	BK, BR, IV, LA, WH
F9008-XX-V1	5.1 Home Theater Strap with Wall Plate
COLORS:	LA, WH
WP9009-XX-V1	7.1 Home Theater Strap with Wall Plate
COLORS:	DM, LA, WH
WP1011-WH	Pre-Configured HDMI 2 Port Strap
COLORS:	BK, LA, WH

CABLE ACCESS WALL PLATES



WP1014-WH



WP1014-XX-V1



WP9001-WH



WP9002-WH

PART NO.	DESCRIPTION
WP1014-XX	Cable Access Strap
	5 Count Bulk Pack in WP1014-WH-5 (5 Pack)
WP1014-XX-V1	Cable Access Strap with Wall Plate
COLORS:	BK, LA, WH
WP9001-XX	Single Gang Bullnose Wall Plate
COLORS:	BK, LA, WH
WP9002-XX	Double Gang Bullnose Wall Plate
COLORS:	BK, LA, WH

COLOR KEY:



NOTE: Suffixes should be added to the end of all applicable part numbers. OMIT COLOR CODE TO ORDER BROWN DEVICE.

DATA CONNECTIVITY

HOME THEATER CONNECTIONS



HT2102-XX-V1



HT21USB-WH-V1



HT2103-WH-V1



HT2000-WH-V1



HT2001-WH-V1



HT2004-WH-V1

PART NO.	DESCRIPTION
HT2102-XX-V1	Flat Panel TV Connection Kit INCLUDES: (1) HDMI 2-PORT STRAP, (1) CABLE ACCESS STRAP (2) WALL PLATES, (1) 9FT HIGH SPEED HDMI CABLE. NOW AVAILABLE IN WH AND BK
HT21USB-WH-V1	In-Wall TV Connection Kit with USB INCLUDES: (1) RECESSED BRACKET WITH CABLE ACCESS STRAP, (1) 1-GANGE DECORATOR WALL PLATE, (1) 15 AMP, 125 VOLT USB OUTLET, (1) 1-GANG ELECTRICAL BOX, (1) CUT-OUT TEMPLATE
HT2103-WH-V1	Home Theater Connection Kit INCLUDES: (1) RECESSED BRACKET WITH CABLE ACCESS STRAP, (1) 1-GANG WALL BOX, (1) TAMPER RESISTANT DECORATOR RECEPTACLE, (1) WALL PLATE
HT2000-WH-V1	HDMI In-Wall Connection Kit INCLUDES: (2) CABLE ACCESS STRAPS (2) WALL PLATES, (1) 9FT HIGH SPEED HDMI WITH ETHERNET CABLE
HT2001-WH-V1	HDMI Premium In-Wall Connection Kit INCLUDES: (1) HDMI 2-PORT STRAP, (1) CABLE ACCESS STRAP (2) WALL PLATES, (1) 9FT HIGH SPEED HDMI CABLE
HT2004-WH-V1	Dual Cable Access Kit INCLUDES (2) CABLE ACCESS BRUSH STRAPS AND (2) CORRESPONDING WALL PLATES

HOME THEATER ACCESSORIES



AC2102

PART NO.	DESCRIPTION
AC2102	TV Box, New Construction Bracket

NOTE: USE WITH HT2102-WH-V1 AND HT2103-WH-V1

COLOR KEY:



NOTE: Suffixes should be added to the end of all applicable part numbers.



HOME THEATER SOLUTIONS

IN-WALL TV POWER KITS



HT22U2-WH-R12



HT22U2-WH-R6



HT22U2-BK-R6

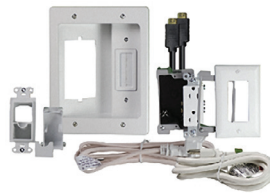

HT22U2-WH-R6C



CPS306W-V1



CPU306W-V1



CPT7526-WH-R6



CPT306W-V1

PART NO.	DESCRIPTION
HT22U2-WH-R12	Long Range In-Wall Pro Power and Cable Management Kit White INCLUDES: (1) UNASSEMBLED POWER OUTPUT MODULE, (1) 12 FT PREWIRED CORD, (2) UNASSEMBLED POWER INPUT MODULE, (1) DRYWALL BRACKET, (1) POWER CORD & CUTOUT TEMPLATE
HT22U2-WH-R6	Pro TV In-Wall Power & Cable Management Kit, White INCLUDES: (1) UNASSEMBLED POWER OUTPUT MODULE, (1) 6FT PREWIRED CORD, (1) UNASSEMBLED POWER INPUT MODULE, (1) DRYWALL BRACKET, (1) POWER CORD & CUTOUT TEMPLATE
HT22U2-BK-R6	Pro TV In-Wall Power & Cable Management Kit, Black (1) UNASSEMBLED POWER OUTPUT MODULE, (1) 6FT PREWIRED CORD, (1) UNASSEMBLED POWER INPUT MODULE, (1) DRYWALL BRACKET, (1) POWER CORD & CUTOUT TEMPLATE
HT22U2-WH-R6C	Pro TV In-Wall Power & Cable Management Kit with (2)10Ft HDMI (1) UNASSEMBLED POWER OUTPUT MODULE, (1) 6FT PREWIRED CORD, (1) UNASSEMBLED POWER INPUT MODULE, (1) DRYWALL BRACKET, (1) POWER CORD & CUTOUT TEMPLATE, (2) 10FT HDMI CABLES

PART NO.	DESCRIPTION
CPS306W-V1	TV In-Wall Power Kit with Surge, White INCLUDES: (1) POWER OUTPUT MODULE, (1) 6FT PREWIRED CORD, (1) POWER INPUT MODULE, (1) DRYWALL BRACKET, (1) POWER CORD & CUTOUT TEMPLATE
CPU306W-V1	TV In-Wall Power Kit with USB, White INCLUDES: (1) UNASSEMBLED POWER OUTPUT MODULE, (1) 6FT PREWIRED CORD, (1) UNASSEMBLED POWER INPUT MODULE, (1) DRYWALL BRACKET, (1) POWER CORD & CUTOUT TEMPLATE
CPT306W-V1	TV In-Wall Power Kit, White INCLUDES: (1) POWER OUTPUT MODULE, (1) 6FT PREWIRED CORD, (1) POWER INPUT MODULE, (1) DRYWALL BRACKET, (1) POWER CORD & CUTOUT TEMPLATE
CPT7526-WH-R6	Enclosure In-Wall Power Kit, White INCLUDES: (1) JUNCTION BOX WITH PRE-WIRED OUTLET, (1) 6FT. IN-WALL RATED CABLE, (1)POWER INPUT MODULE, (1) 6FT. POWER CORD, (1) DRYWALL SAW & NECESSARY HARDWARE



AV CABLING

HDMI CABLES



8K ULTRA HIGH SPEED HDMI CABLE 48GBPS / 60Hz **NEW!**

PART NO.	DESCRIPTION
AC8K1M-BK	1 Meter Ultra High Speed 8K HDMI 2.1
AC8K2M-BK	2 Meter Ultra High Speed 8K HDMI 2.1
AC8K3M-BK	3 Meter Ultra High Speed 8K HDMI 2.1
AC8K4M-BK	4 Meter Ultra High Speed 8K HDMI 2.1

- Supports 8K at 60Hz
- All lengths CL3/FT4 rated for in-wall use
- Sure Grip connector provides a firm grip to prevent cable damage
- Enhanced retention clips keep cable firmly in place
- Gold plated connector resists corrosion and provides the highest level of signal conductivity
- Enhanced Audio Return Channel (eARC): Supports high-bitrate audio formats including DTS-HD Master Audio™, DTS:X®, Dolby® TrueHD and Dolby Atmos®



4K PREMIUM CERTIFIED HDMI CABLE 18.6 GBPS / 60Hz **NEW!**

PART NO.	DESCRIPTION
AC4K1M-BK	1 Meter Premium 4K HDMI 2.0 Cable
AC4K2M-BK	2 Meter Premium 4K HDMI 2.0 Cable
AC4K3M-BK	3 Meter Premium 4K HDMI 2.0 Cable
AC4K4M-BK	4 Meter Premium 4K HDMI 2.0 Cable
AC4K5M-BK	5 Meter Premium 4K HDMI 2.0 Cable
AC4K7M-BK	7 Meter Premium 4K HDMI 2.0 Cable
AC4K2M-BK-10	2 Meter Premium 4K HDMI 2.0 Cable - 10 Pack
AC4K3M-BK-10	3 Meter Premium 4K HDMI 2.0 Cable - 10 Pack

- Supports 4K at 60Hz
- All lengths CL3/FT4 rated for in-wall use
- Enhanced retention clips keep cable firmly in place
- Gold plated connector resists corrosion and provides the highest level of signal conductivity
- Enhanced Audio Return Channel (eARC): Supports high-bitrate audio formats including DTS-HD Master Audio™, DTS:X®, Dolby® TrueHD and Dolby Atmos®



18GBPS PREMIUM HIGH SPEED HDMI SLIM LINE CABLE WITH ETHERNET

PART NO.	DESCRIPTION
AC3MP1-WH	1 Meter Premium High Speed HDMI Slim Line Cable with Ethernet, White
AC3MP1-BK	1 Meter Premium High Speed HDMI Slim Line Cable with Ethernet, Black - not shown
AC3MP2-WH	2 Meter Premium High Speed HDMI Slim Line Cable with Ethernet, White
AC3MP2-BK	2 Meter Premium High Speed HDMI Slim Line Cable with Ethernet, Black - not shown

NOTES: HDMI CERTIFIED TO ENSURE FULL 18GBPS BANDWIDTH NECESSARY FOR 4K ULTRAHD

AV CABLING

HDMI CABLES



10GBPS HIGH SPEED HDMI WITH ETHERNET SLIM LINE CABLE

PART NO.	DESCRIPTION
AC3M01-WH-V1	1 Meter High Speed HDMI with Ethernet Slim Line Cable
AC3M02-WH-V1	2 Meter High Speed HDMI with Ethernet Slim Line Cable
AC3M04-WH-V1	4 Meter High Speed HDMI with Ethernet Slim Line Cable



10GBPS HIGH SPEED HDMI CABLES WITH ETHERNET

PART NO.	DESCRIPTION
AC2M00-BK	0.7 Meter HDMI cable w/Ethernet
AC2M01-BK	1 Meter HDMI cable w/Ethernet
AC2M02-BK	2 Meter HDMI cable w/Ethernet
AC2M03-BK	3 Meter HDMI cable w/Ethernet
AC2M04-BK	4 Meter HDMI cable w/Ethernet
AC2M05-BK	5 Meter HDMI cable w/Ethernet
AC2M07-BK	7.5 Meter HDMI cable w/Ethernet
AC2M10-BK	10 Meter HDMI cable w/Ethernet
AC2M15-BK	15 Meter HDMI cable w/Ethernet
AC2M20-BK	20 Meter HDMI cable w/Ethernet



AC2403-BK



AC2406-BK

TOSLINK

PART NO.	DESCRIPTION
AC2403-BK	3 Feet Toslink w/Mini Audio Cable
AC2406-BK	6 Feet Toslink w/Mini Audio Cable
AC2412-BK	12 Feet Toslink w/Mini Audio Cable
AC2425-BK	25 Feet Toslink w/Mini Audio Cable

ACCESSORIES



AC2103-V1

AC2100

AC2101

PART NO.	DESCRIPTION
AC2100	HDMI Repeater COUPLES UP TO (2) 20 FT. HDMI CABLES.
AC2101	HDMI Hinged Coupler CONNECT 2 CABLES TO MAKE 90-DEGREE BENDS.
AC2103-V1	Hinged HDMI Male-to-Female Adapter

AV CABLING

AUDIO/VIDEO CABLES



AC2006-BK



AC2103-BK



AC2203-BK



AC2303-BK



AC2501-BK



AC2506-BK



AC2606-BK



AC2701-BK



AC2702-BK



AC2704-BK



AC2706-BK



CM1015



CM1016



CM1017



CM1018

COMPOSITE

PART NO.	DESCRIPTION
AC2006-BK	6 Feet Composite Vid L/R Audio Cable
AC2012-BK	12 Feet Composite Vid L/R Audio Cable

UNIVERSAL

PART NO.	DESCRIPTION
AC2103-BK	3 Feet Universal 1 Subwoofer Cable
AC2106-BK	6 Feet Universal 1 Subwoofer Cable
AC2112-BK	12 Feet Universal 1 Subwoofer Cable
AC2125-BK	25 Feet Universal 1 Subwoofer Cable
AC2203-BK	3 Feet Universal 2 L/R Audio Cable
AC2206-BK	6 Feet Universal 2 L/R Audio Cable
AC2303-BK	3 Feet Universal 3 Component Video Cable
AC2306-BK	6 Feet Universal 3 Component Video Cable
AC2312-BK	12 Feet Universal 3 Component Video Cable
AC2325-BK	25 Feet Universal 3 Component Video Cable

3.5 MM

PART NO.	DESCRIPTION
AC2501-BK	6 Inches Stereo 3.5 mm Y M/2F Adapter
AC2506-BK	6 Feet Stereo 3.5 mm M/F Audio Cable
AC2512-BK	12 Feet Stereo 3.5 mm M/F Audio Cable
AC2606-BK	6 Feet Stereo 3.5 mm M/M Audio Cable
AC2612-BK	12 Feet Stereo 3.5 mm M/M Audio Cable
AC2625-BK	25 Feet Stereo 3.5 mm M/M Audio Cable

RCA

PART NO.	DESCRIPTION
AC2701-BK	6 Inches RCA Y M/2F Adapter
AC2702-BK	6 Inches RCA Y F/2M Adapter
AC2704-BK	RCA Coupler Pair
AC2706-BK	6 Feet 3.5 mm to L/R RCA Audio Cable
AC2712-BK	12 Feet 3.5 mm to L/R RCA Audio Cable
AC2725-BK	25 Feet 3.5 mm to L/R RCA Audio Cable
CM1015	RCA to RCA Y Splitter Cable - Yellow (1 ft)
CM1016	RCA to RCA Y Splitter Cable - White (1 ft)
CM1017	RCA to RCA Patch Cable (1 ft)
CM1018	Audio Mini Patch Cable (1 ft)

CAT 6 CABLES

The differences between the types of category patch cables are found in the speed, bandwidth, and the distance the signal can travel.

CAT 6A PATCH CABLES

- 500MHZ PATCH CABLE FULLY SUPPORTS 1 GIGABIT ETHERNET SPEEDS UP TO 328 FT.
- UL VERIFIED TO SUPPORT THE CAT 6A PERFORMANCE PATCH CABLE SPECIFICATION
- SNAGLESS OVERMOLD PREVENTS INSERTION TAB FROM CATCHING ON OTHER CABLES 26 AWG STRANDED PATCH CABLE

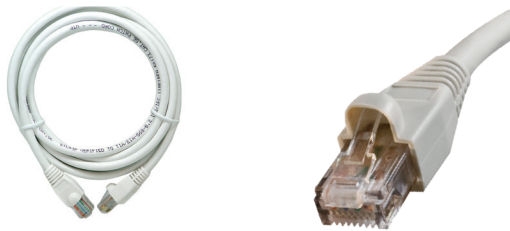

AC6A07-GY-V1

PART NO.	DESCRIPTION
AC6A01-GY-V1	1 Foot Cat 6a Patch Cable
AC6A02-GY-V1	2 Foot Cat 6a Patch Cable
AC6A03-GY-V1	3 Foot Cat 6a Patch Cable
AC6A07-GY-V1	7 Foot Cat 6a Patch Cable
AC6A14-GY-V1	14 Foot Cat 6a Patch Cable
AC6A25-GY-V1	25 Foot Cat 6a Patch Cable
AC6A50-GY-V1	50 Foot Cat 6a Patch Cable

CAT 6 PATCH CABLES

- 250MHZ PATCH CABLE FULLY SUPPORTS 1 GIGABIT ETHERNET SPEEDS UP TO 328 FT.
- UL VERIFIED TO SUPPORT THE CAT 6 PERFORMANCE PATCH CABLE SPECIFICATION
- SNAGLESS OVERMOLD PREVENTS INSERTION TAB FROM CATCHING ON OTHER CABLES
- 24 AWG STRANDED PATCH CABLE

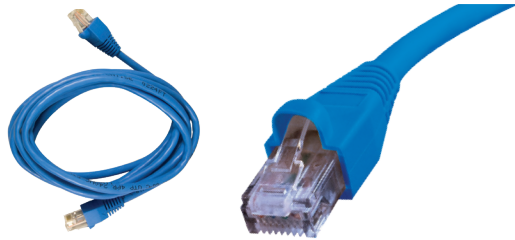

AC3607-BE-V1

PART NO.	DESCRIPTION
AC3601-BE-V1	1 Foot Cat 6 Patch Cable
AC3602-BE-V1	2 Foot Cat 6 Patch Cable
AC3603-BE-V1	3 Foot Cat 6 Patch Cable
AC3607-BE-V1	7 Foot Cat 6 Patch Cable
AC3614-BE-V1	14 Foot Cat 6 Patch Cable
AC3625-BE-V1	25 Foot Cat 6 Patch Cable
AC3650-BE-V1	50 Foot Cat 6 Patch Cable

CAT 5E PATCH CABLES

- 100MHZ PATCH CABLE SUPPORTS 1 GIGABIT ETHERNET SPEEDS UP TO 328FT.
- UL VERIFIED TO SUPPORT THE CAT 5e PERFORMANCE PATCH CABLE SPECIFICATION
- SNAGLESS OVERMOLD PREVENTS INSERTION TAB FROM CATCHING ON OTHER CABLES
- 24 AWG STRANDED PATCH CABLE

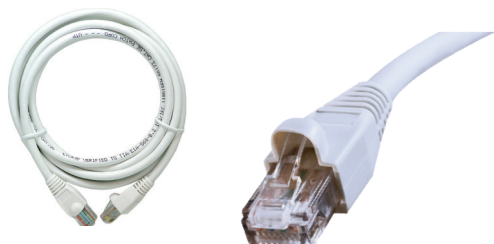

AC3507-WH-V1

PART NO.	DESCRIPTION
363201-26-V1	1 Foot Cat 5e Patch Cable
363201-25-V1	2 Foot Cat 5e Patch Cable
AC3503-WH-V1	3 Foot Cat 5e Patch Cable
AC3507-WH-V1	7 Foot Cat 5e Patch Cable
AC3514-WH-V1	14 Foot Cat 5e Patch Cable
AC3525-WH-V1	25 Foot Cat 5e Patch Cable
AC3550-WH-V1	50 Foot Cat 5e Patch Cable

CABLE TIES & PATCH PANELS

CABLE TIES

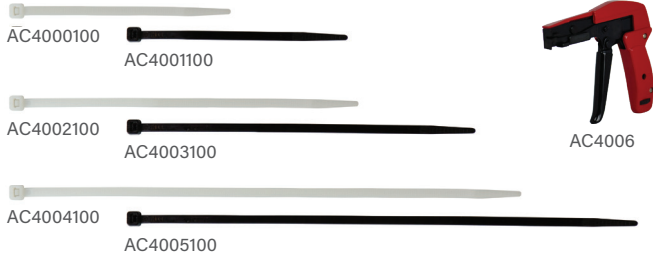

PART NO.	DESCRIPTION
AC4000100	4.75 Inch, Natural, Cable Ties (100 Pack)
AC4001100	4.75 Inch, Black, Cable Ties (100 Pack)
AC4002100	7.5 Inch, Natural, Cable Ties (100 Pack)
AC4003100	7.5 Inch, Black, Cable Ties (100 Pack)
AC4004100	11 Inch, Natural, Cable Ties (100 Pack)
AC4005100	11 Inch, Black, Cable Ties (100 Pack)
AC4006	Cable Tie Tool

NOTE: FOR CONSISTANT AND CLEAN INSTALLATIONS USE WITH CABLE TIE TOOL, AC4006

PATCH PANELS

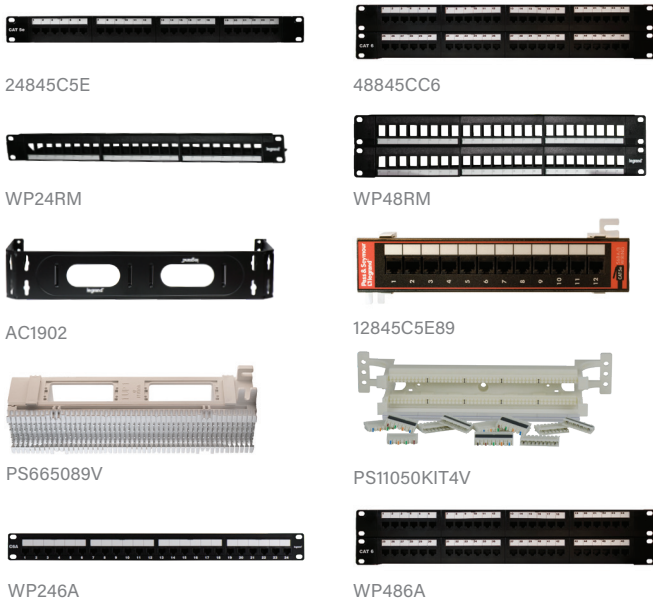

PART NO.	DESCRIPTION
24845C5E	Category 5e 24-Port T568A/B Universal Wiring
48845CC6	Category 5e 48-Port T568A/B Universal Wiring
24845CC6	Category 6 24-Port T568A/B Universal Wiring
48845CC6	Category 6 48-Port T568A/B Universal Wiring

- 24 PORT PATCH PANEL USES 1 RACK MOUNT SPACE
- 48 PORT PATCH PANEL USES 2 RACK MOUNT SPACES
- 110 PUNCHDOWN REAR TERMINATION

WP24RM	24 Port Keystone Blank
WP48RM	48 Port Keystone Blank
AC1902	2 U Wall Mount Rack with Extenders
12845C5E89	12-Port T568A/B Universal Wiring
PS665089V	50-Pair 66 Block, Unwired & Mounting Bracket
PS11050KIT4V	50-Pair 110 Kit with Legs
	INCLUDES: 110 PUNCH DOWN BLOCK WITH STAND-OFF LEGS, 10 C5 CLIPS, AND LABEL BAR.
WP246A	Cat 6A 24 Port Rack Mount Patch Panel
WP486A	Cat 6A 48 Port Rack Mount Patch Panel

INSTALLATION TOOLS & CONNECTORS

TOOLS



362721-02



363292-01



364555-01



AC1018



AC3007



AC4006

PART NO.	DESCRIPTION
362721-02	RG-6 Coax Stripper
363292-01	Cat 5e Strip and Fit Tool
364555-01	EZ RJ-45 Modular Plug Hand Tool
AC1018	Radial Taper Compression Tool (use with 364246-01 Coax F Plug)
AC3007	Adjustable Compression Tool
AC3400	Punch & Go Tool IMPROVES TERMINATION SPEEDS, REDUCES COMPROMISED CONNECTIONS AND INCREASES PRODUCTIVITY OF ANY QUICK CONNECT DATA INSERT.
AC4006	Cable Tie Tool



AC3400

CONNECTORS



364405-01



AC3000100



AC345050



AC346025



WP3483-01



AC3001-10



AC3002-10



AC3003-10



AC3004-10



AC3005-10



AC3006-10



AC3008-10

PART NO.	DESCRIPTION
364405-01	High Performance RJ45 Modular Plugs (25 Pack)
AC3000100	360 Conical Coax F Plug (100 Pack)
AC345050	EZ-RJ45 Modular Cat 5e Plug (50 Pack)
AC346025	EZ-RJ45 Modular Cat 6 Plug (25 Pack)
WP3483-01	Banana Plugs (pair)
AC3001-10	Compression RG6U/Quad F Plug, 10 Pack
AC3002-10	Compression RG6U/Quad 3 GHz F Jack, 10 Pack
AC3003-10	Compression RG6U/Quad Shield BNC Plug, 10 Pack
AC3004-10	Compression RG6U/Quad Shield RCA Plug, 10 Pack 50 PACK ALSO AVAILABLE, AC3004-50
AC3005-10	Compression RG6U/Quad Shield Right Angle RCA Plug
AC3006-10	Nickle F-81 1 GHz Coupler, 10 Pack 50 PACK ALSO AVAILABLE, AC3006-50
AC3008-10	Compression RG6U/Quad F Plug 10 Pack 50 PACK ALSO AVAILABLE, AC3008-50

RESOURCES & SUPPORT

TECH SUPPORT

Need help on the job? Legrand's expert team of support specialists are available Monday through Friday, from 8:30 am to 6:30 pm Eastern Time, to answer your product or installation questions. The staff can be reached during these standard hours by any of the below options:

Phone: 800.223.4162, Option #3, then Option #2 or 1-717-546-5412
Email: technical.support-hs@legrand.us
Live Chat: available through the www.legrand.us website

CUSTOMER SERVICE

Friendly and knowledgeable, our team can handle a wide variety of needs and requests – from order processing to system registration – and is available Monday through Friday, from 9 am to 6 pm Eastern Time.

Phone: 844.334.8044
Email (general inquiries): customer.support.lv@legrand.us
Email (orders): orders.lv@legrand.us

TRAINING & SALES COLLATERAL

Knowledge is power, and Legrand offers a wealth of product, industry, and installation knowledge through our in-person and online courses.

Visit the Legrand University at <http://go.bluevolt.com/Legrand> for convenient online courses you can complete at your own pace, recordings of past webinars to catch anything you may have missed, and a complete schedule of upcoming FREE webinars and in-person training events.



301 Fulling Mill Road, Suite 700
Middletown, PA 17057
(800) 321-2343
www.legrand.us/onq

9024 Keele Street,
Vaughan, Ontario L4K 2N2
(800) 723-5175
www.legrand.ca

04/26/2023
DM04722