

IBDN Copper Connectivity Solutions

Reliable, Scalable, End-to-End
Networking Solutions



**Be certain.
Belden.**

Our End-to-End Expertise.
Your End-to-End Solution.



BELDEN
SENDING ALL THE RIGHT SIGNALS

Belden has the end-to-end copper cabling system to meet your current networking challenges while providing the bandwidth and scalability for the needs of the future.

**Be certain.
Belden.**

Our End-to-End Expertise.
Your End-to-End Solution.



IBDN Copper Connectivity Solutions

Belden Copper Systems Provide Reliable, End-to-End Networking Performance

Belden understands that cabling is the core foundation of every network – its ability to provide high performance, reliable transmission is essential for carrying out day-to-day business operations. From critical data center links that connect network switches and servers, to horizontal and backbone links that deliver voice, data and video for a wide range of networking, communications, audio-visual, security and building management applications, Belden has the end-to-end copper cabling system to meet your current networking challenges while providing the bandwidth and scalability for the needs of the future.



Table of Contents

There's a Belden IBDN Copper System that's right for you.



IBDN Structured Cabling Solutions		Page
Markets		6
Applications		7
Solutions		8–9
Innovation		10–11
■ Cables		
UTP (CAT6A, CAT6+, CAT5E)		14–15
STP (CAT6A, CAT6+, CAT5E)		16–17
■ Accessories		
Tools		20–21
Labels		22–23
■ 10GX CAT6A System Connectivity		
CAT6A UTP		25–31
CAT6A UTP UHD-Panels, HD-Panels, SD-Panels, OU-Panel		26–27
CAT6A UTP Modular Patch Cords		28–29
CAT6A UTP Traceable Modular Patch Cords		28–29
CAT6A UTP Pre-Term Modular Cable Assemblies		28–29
Connecting Components, Accessories, X-Connect Cable – 10GX IDC System		30–31
CAT6A STP		32–35
CAT6A STP HD-panels, SD-panels		32–33
Unloaded and Modular		32–33
CAT6A STP Modular Patch Cords		34–35
CAT6A STP Pre-Term Modular Cable Assemblies		34–35
■ 2400 CAT6+ System Connectivity		
CAT6+ UTP		37–43
CAT6+ UTP UHD-Panels, HD-Panels, SD-Panels, OU-Panel		38–39
CAT6+ UTP Bonded-Pair Modular Patch Cords and Nonbonded-Pair Pigtailed		40–41
CAT6+ UTP Traceable Modular Patch Cords		40–41
CAT6+ UTP Pre-Term Modular Cable Assemblies		40–41
CAT6+ UTP GigaBIX IDC System		42–43
CAT6+ STP		44–47
CAT6+ STP SHD-panels, SD-panels		44–45
CAT6+ KeyConnect Style Shielded Modular Jacks		44–45
CAT6+ STP Modular Patch Cords		46–47



Our End-to-End Expertise.
Your End-to-End Solution.



■ 1200 CAT5E System Connectivity	Page
CAT5E UTP	49–53
CAT5E UTP UHD-panels, HD-Panels, SD-Panels, OU-Panel	50–51
CAT5E UTP KeyConnect Patch Panels	50–51
CAT5E UTP KeyConnect Preloaded Patch Panels	50–51
UTP Modular Patch Cords	52–53
Traceable Bonded-Pair Patch Cords	52–53
CAT5E STP	54–57
CAT5E STP HD-panels, SD-panels	54–55
CAT5E STP KeyConnect-Style Shielded Modular Jack	54–55
CAT5E Shielded Modular Cords, Patch Cords and Pigtails	56–57
■ Workstation	
Workstation	59–65
KeyConnect Square Faceplate	60–61
KeyConnect Boxes	62
KeyConnect-Style UTP and STP Modular Jacks, Multimedia Modules	62–64
RJ45 Plug Kits and Accessories	65
■ Components	
Components	67–71
CAT6A, CAT6, CAT5E UHD-panels, HD-panels, SD-panels	68–69
CAT6A Modular Jack	68–69
CAT6+ Jacks	70–71
CAT5E Jacks	70–71
■ QSFP+/SFP+ Direct Attached Cables	
QSFP+/SFP+ Direct Attached Cables	73–75
SFP+ Direct Attached Copper Cable Assemblies, 10 Gb/s, Passive	75
QSFP+ Direct Attached Copper Cable Assemblies, 40 Gb/s, Passive	75
QSFP+ to 4/SFP+ Breakout Direct Attached Copper CA, 4 x 10 Gb/s, Passive	75
■ Warranties	
Belden 10GX System Certified Installations	78–79
Belden 2400 System Certified Installations	80–81
Belden 1200 System Certified Installations	82–83
■ Miscellaneous	
RJ45 Plug Kits and Accessories	86
Voice Panel	86–87
Outside Plant Cable Nonbonded-Pair	86–87
Backdoor Indoor Cable	86–87



We are a leading company serving a multitude of industries with a strong focus on selected markets.

Markets

The use of multiple infrastructures within the enterprise, comprised of components from any number of infrastructure vendors and installers, adds undue complexity to the buying and specifying process, as well as to the updating and management of the infrastructure.

Adding to this complexity is the fact that most infrastructure vendors are unable to provide both high-value legacy cabling solutions for autonomous systems and high-performance IP-based solutions. Unlike any other infrastructure vendor, Belden tackles these problems by taking a universal approach to the enterprise – resolving every signal transmission need with IP- and legacy-based solutions that enable a smooth migration to convergence. Our high-bandwidth, high-density copper connectivity solutions provide solutions for a diverse set of markets including:

Local Area Networks

Full compliment of innovative and highly reliable infrastructure solutions to support all LAN applications from building entrance to desktop.

Data Center

Consultative design of custom infrastructure solutions for optimal turn-up time, agility, reliability and Total Cost of Ownership.

Key Markets

- Data Hosting
- Healthcare
- Education
- Financial
- Government



Our End-to-End Expertise.
Your End-to-End Solution.



Applications



Industry's Most Extensive Enterprise Connectivity Portfolio

Copper Cable & Connectivity

- Category systems for LAN and Data Center
- Access Control Cabling
- Building Automation & Control



Data Center Ready Solutions

- Customization & Design services
- Pre-configured and pre-installed Cable Management and Connectivity options

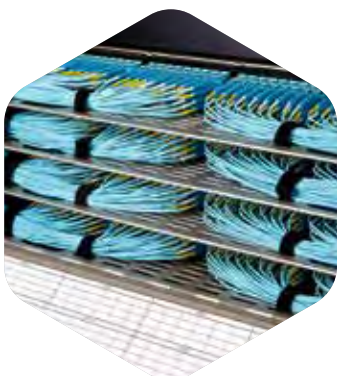

Fiber Cable & Connectivity

- Backbone, campus, in-building and Fiber to the Desk
- Quick Deploy Pre-Term Systems
- Industry Leading Low-Loss Connectivity



Infrastructure Solutions

- Racks & Enclosures
- Rack Power Distribution
- Air Flow and Climate Monitoring
- Cable Management Accessories



Different levels of Belden Copper Systems are offered to meet customers' specific needs.

Solutions

Representing Networking Leadership at Every Turn

Belden Copper Systems represent networking leadership at every turn, providing top performing structured cabling systems that reduce downtime, ease deployment and facilitate migration to advanced networking technologies and converged building systems. Designed with innovative technologies that provide beyond-standards performance, Belden Copper Systems provide a wide range of product options to meet your specific needs – no matter what your application, your environment or your plans.

IBDN 10GX System

The 10GX System is an end-to-end copper system designed with dynamic enabling technologies to support the most demanding current and future high-end applications with performance beyond the TIA/EIA Category 6A standard. With a guaranteed 625 MHz of usable bandwidth for 10GBASE-T applications and the highest supported frequency for broadband video at 860 MHz, the 10GX System is an ideal long-term investment that will outlast several equipment and application upgrades. Combined with a host of patch panels, assemblies, connectors and accessories, as well as a preterminated system, the 10GX System is the ideal solution for any current and future data center or horizontal cabling system.



CAT6A 10GX System

2400 System

The 2400 System offers moderate communications performance for general business applications and transactions, including advanced file sharing and downloads. It offers a guaranteed bandwidth of 250 MHz to support 10/100/1000BASE-T applications with enhanced, error-free Category 6 performance. With cables, modular jacks, cords, patch panels and a cross-connect system, the 2400 System is an ideal market-entry solution for businesses ready for reliable end-to-end Category 6 performance.



CAT6+ 2400 System

1200 System

For networks requiring only Category 5e performance, the 1200 System is the best performing Category 5e system available. The 1200 System exceeds all requirements for Category 5e performance with guaranteed bandwidth to 160 MHz – more bandwidth than typical Category 5e systems. Ideal for budget conscious and short-term investments, the 1200 System is robust enough to support a variety of basic business applications in standard environments, including basic PoE.

Our End-to-End Expertise.
Your End-to-End Solution.



Best-in-Class Support and Warranties

All Belden Systems are backed by expert service and technical support and a commitment to delivering high-performance, reliable transmission solutions. Belden backs certified systems with two unique best-in-class warranties for complete peace of mind – a 25-Year Product Warranty and a Lifetime Application Assurance Program.

From the date of installation, the 25-Year Product Warranty warrants against defects in materials and workmanship and guarantees components to meet or exceed all applicable standards. Under the Lifetime Application Assurance Program, Belden warrants that each certified System will deliver its specified throughput rate and minimum bandwidth capabilities and be capable of operating the applications that the system was originally designed to support, as well as any new applications, for the lifetime of the installed system.

Belden Copper Systems – Performance and Component Selection Matrix

Type	10GX System	2400 System	1200 System
Performance Standard	Category 6A	Category 6	Category 5e
Available Bandwidth	Belden Performance up to 625 MHz TIA Performance 500 MHz	Belden Performance up to 350 MHz TIA Performance 250 MHz	Belden Performance up to 160 MHz TIA Performance 100 MHz
Cable Selection	10GXS Series 10GX Series 10GB Series	DataTwist 2400 Series MediaTwist Series	DataTwist 1200 Series
Connectivity Selection	10GX IDC Cross-Connect	GigaBIX Cross-Connect	BIX and 110 Cross-Connect
	10GX Patch Panels 10GX Modular Jacks 10GX Modular Cords	CAT6+ Patch Panels CAT6+ Modular Jacks CAT6+ Modular Cords	CAT5E Patch Panels CAT5E Modular Jacks CAT5E Modular Cords
	KeyConnect and Flex Modular Patch Panels KeyConnect, Interface and Outlet Hardware <i>(Configurable with appropriate modules)</i>		

Belden Shielded Systems – Performance and Component Selection Matrix

Type	10GX Shielded System	2400 Shielded System	1200 Shielded System
Performance Standard	Category 6A	Category 6	Category 5e
Available Bandwidth	Belden Performance up to 625 MHz TIA Performance 500 MHz	Belden Performance up to 350 MHz TIA Performance 250 MHz	Belden Performance up to 160 MHz TIA Performance 100 MHz
Cable Selection	10GX Shielded Series	2400 Shielded Series	1200 Shielded Series
Connectivity Selection	10GX Shielded Modular Jacks 10GX Shielded Modular Cords	CAT6+ Shielded Modular Jacks CAT6+ Shielded Modular Cords	CAT5E Shielded Modular Jacks CAT5E Shielded Modular Cords
	KeyConnect Shielded Patch Panels Faceplates, KeyConnect Faceplates and Adapters <i>(Configurable with appropriate modules)</i>		



COMING
SOON



Innovation

REVConnect is a brand new RJ45 connectivity system. A single **Reliable** and **Easy** termination method that offers unparalleled **Versatility**; it covers jack and plug, shielded or unshielded, Category 5e through Category 6A.



Reliable

What Makes REVConnect Reliable?

REVConnect gets its reliability from a unique termination process featuring a universal 'core' comprised of a cable manager and cap. The cap features eight insulation piercing contacts which create a highly reliable, gas-tight termination proven to increase first pass yields and reduce rework.

How Much More Reliable Is REVConnect?

Voice of customer feedback indicates nearly 5% of terminations need some level of rework ranging from repunching one wire to completely starting over with a new connector. With REVConnect, rework will be reduced to less than 1% of all terminations.



Easy

What Makes REVConnect Easy?

The termination of the REVConnect core is a simple, straightforward process that requires no pair separation! This means, both bonded and non-bonded cables terminate in the same amount of time. On top of that, the single core termination is all the installer needs to know in order to terminate eight different modules.

How Much Faster Is REVConnect?

Though it does depend on what you're comparing to, REVConnect has shown to be over 50% faster than some existing connectors and is, no doubt, one of the fastest connectors to terminate available today.

Versatile

How Is REVConnect Versatile?

REVConnect's core technology accepts eight RJ45 modules: UTP jacks (Category 5e through 10GX), Shielded jacks (Category 5e through 10GX), and 10GX Shielded and Unshielded Field Mountable Plugs. A single termination tool is all that is required for the entire termination, including cable prep!



What About Future Generation Modules?

As one could imagine, REVConnect's core technology has potential beyond the current offering. The available eight modules are only the beginning of what we expect to be a revolutionary connectivity platform to support the emerging applications of today and tomorrow.

Our End-to-End Expertise.
Your End-to-End Solution.



REV-Connect Configurator

Product Name	Performance	Module Type	Footprint	Shielding	Color	Put Up
REV-Connect = RV	10GX = A	Modular Jack = MJ	Keystone = K	Unshielded = U	Gray = GY	Single Bag = -S1
RV	CAT6+ = 6	Field Mount Plug = FP	** Jacks only	Shielded = S	Almond = AL	Bulk Pack of 24 = -B24
	CAT5E = 5	Termination Tool = TT		** Modules only	Electric White = EW	Bulk Pack of 50 = -B50
	Universal Item = U	Core = CO			Black = BK	
		Icon = IC			Ivory = IV	
		Dust Cover = DC			Brown = BR	
					Red = RD	
					Orange = OR	
					Yellow = YL	
					Green = GN	
					Blue = BL	
					Purple = PR	
					Brown (TIA) = TN	
					Red (TIA) = TR	
					Orange (TIA) = TO	
					Yellow (TIA) = TY	
					Green (TIA) = TG	
					Blue (TIA) = TB	
					Blue (TIA) = TB	
					Purple (TIA) = TP	

Example Partnumber REV-Connect Icon: **RVUICTB-B24**

Example Partnumber REV-Connect Modular Jack: **RVAMJKUTB-B50**

- RV = REV-Connect
- U = Universal Item
- IC = Icon
- TB = Blue (TIA)
- B24 = Bulk Pack of 24

- RV = REV-Connect
- A = 10GX
- MJ = Modular Jack
- K = Keystone
- U = Unshielded
- TB = Blue (TIA)
- B50 = Bulk Pack of 50

Description	Part Number
REV-Connect	
Termination Tool	RVUTTS1
Core	RVUCOEW-B50





Our End-to-End Expertise.
Your End-to-End Solution.



Cables

Section Table of Contents

■ Cables	
UTP (CAT6A, CAT6+, CAT5E)	14-15
STP (CAT6A, CAT6+, CAT5E)	16-17

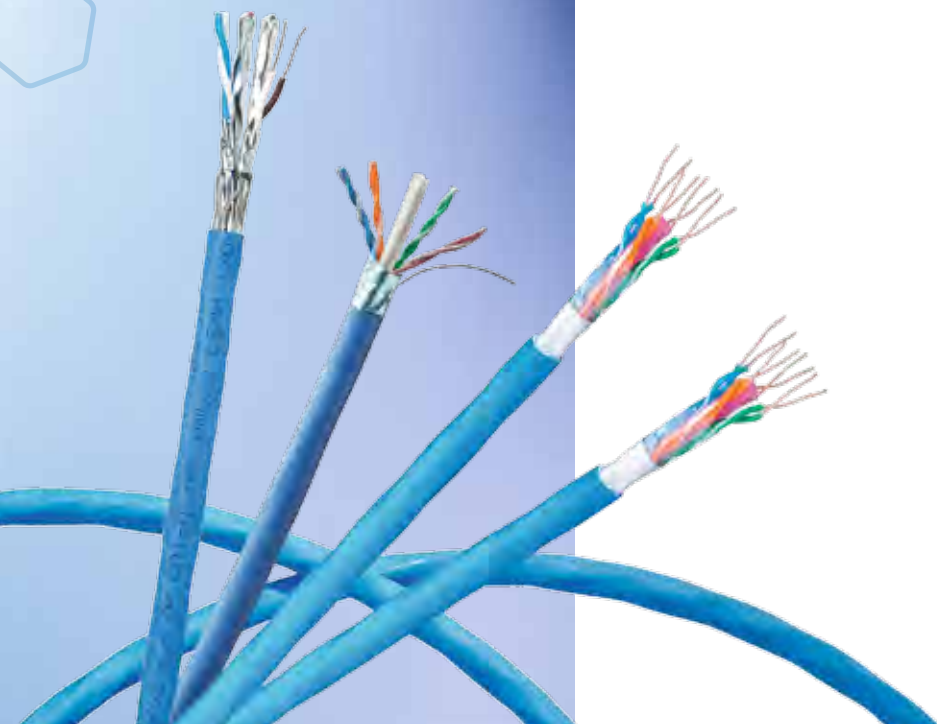

Cables – UTP

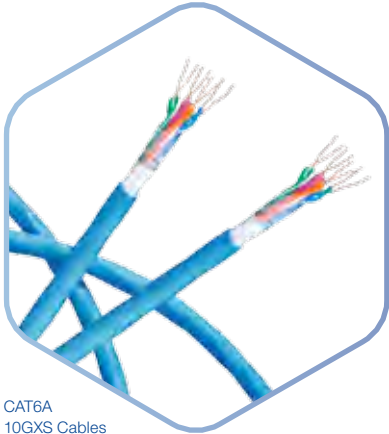

CAT6A
10GXS Cables



Cat6+ DataTwist
2400 Cables

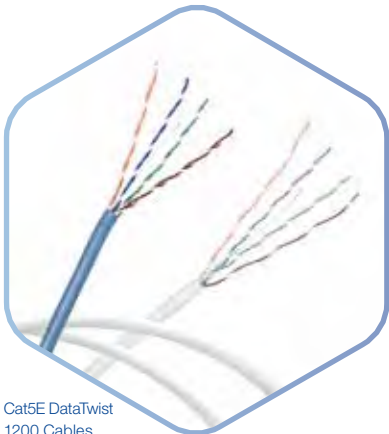

Cat5E DataTwist
1200 Cables

CAT6A UTP Cables

The **10GXS cable** is the gold standard of 10G networking. Combining smaller diameter with the best mechanical and electrical characteristics in a Category 6A cable isn't easy, but Belden's 10GXS Cables do it all. With an effective diameter of just 0.265" (6.73 mm) and proven performance that exceeds Category 6A requirements for 100-meter channels, they are ideal for LANs and enterprise data centers that require both high-density and high-bandwidth connections for current and emerging network applications.

The **10GX cable** delivers performance that goes beyond the ANSI/TIA/EIA 568-C.2 Category 6A standard. When used as the horizontal cable within the Belden 10GX System, it provides 625 MHz of proven channel bandwidth and a data rate of 10 Gigabits per second. This performance is made possible through the innovative RoundFlex™ design that serves to reduce alien crosstalk by randomizing the distance between the cables.

The **10GB cable** brings a cost-effective Category 6A U/UTP 500 MHz cabling system to the market that doesn't trade performance, design or ease of installation for affordability. Small 7.2 mm diameter reduces weight and space requirements while easy-to-separate pairs reduce installation time by requiring fewer twists. The cabling system helps building owners take advantage of 10 Gb/s speeds in high-density, high-bandwidth applications and devices, including data, voice, surveillance and wireless access points.

CAT6+ UTP Cables

DataTwist 2400 cable consists of 4-pair UTP cables that exceed Category 6 requirements as per ANSI/TIA/EIA-568-C.2. When used as the horizontal cable in the Belden 2400 System, the channel provides at least 250 MHz of bandwidth.

CAT5E UTP Cables

DataTwist 1200 cable series consists of 4-pair UTP cables that exceed the Category 5e requirements as per ANSI/TIA/EIA-568-C.2 Category 5e standard. When used as the horizontal cable in the Belden 1200 System, the channel provides 160 MHz of bandwidth.

Our End-to-End Expertise.
Your End-to-End Solution.



Part Number	Description
-------------	-------------

CAT6A UTP System Cables

10GXS Small Diameter, Nonbonded-Pair, 4-pair, 23 AWG, Riser-CMR, Cat6A	
10GXS12 00Z1000	305 m (1000 f)/Spool
10GXS1200ZA1000	305 m (1000 f)/Spool-in-box
10GXS Small Diameter, Bonded-Pair, 4-pair, 23 AWG, Riser-CMR, Cat6A	
10GXS32 00Z1000	305 m (1000 f)/Spool
10GXS3200ZA1000	305 m (1000 f)/Spool-in-box

10GX, Standard Diameter, Nonbonded-Pair, 4-pair, 23 AWG, LSZH, Cat6A	
10GX24.0Z1000	305 m (1000 f)/Spool
10GX24.0ZA1000	305 m (1000 f)/Spool-in-box

10GX, Standard Diameter, Bonded-Pair, 4-pair, 23 AWG, LSZH, Cat6A	
10GX44 00Z1000	305 m (1000 f)/Spool
10GX44 00ZA1000	305 m (1000 f)/Spool-in-box

10GX, Standard Diameter, Nonbonded-Pair, 4-pair, 23 AWG, Riser-CMR, Cat6A	
10GX12 00Z1000	305 m (1000 f)/Spool
10GX1200ZA1000	305 m (1000 f)/Spool-in-box

10GX, Standard Diameter, Bonded-Pair, 4-pair, 23 AWG, Riser-CMR, Cat6A	
10GXS32 00Z1000	305 m (1000 f)/Spool
10GXS3200ZA1000	305 m (1000 f)/Spool-in-box

10GB, Reduced Diameter, Nonbonded-Pair, 4-pair, 23 AWG, LSZH, Cat6A	
10GB24.0Z500	500 m (1000 f)/Reel
10GB24.0ZA100	100 m (1000 f)/Reel-in-box

10GB, Reduced Diameter, Nonbonded-Pair, 4-pair, 23 AWG, PVC, Cat6A	
10GB12.0Z500	500 m (1000 f)/Reel
10GB12.0ZA100	100 m (1000 f)/Reel-in-box

CAT6 UTP System Cables

DataTwist 2400, Nonbonded-Pair, 4-pair, 24 AWG, CMR, Category 6	
2412D.0Z305	305 m (1000 f)/Spool
2412D.0ZA305	305 m (1000 f)/Spool-in-box
2412D.0Z500	500 m/Spool

DataTwist 2400, Nonbonded-Pair, 4-pair, 23 AWG, LSZH, Category 6	
2424.0Z305	305 m (1000 f)/Spool
2424.0ZA305	305 m (1000 f)/Spool-in-box
2424.0Z500	500 m/Spool

DataTwist 2400, Nonbonded-Pair, 4-pair, 24 AWG, LSZH, Category 6	
2424D.0Z305	305 m (1000 f)/Spool
2424D.0ZA305	305 m (1000 f)/Spool-in-box
2424D.0Z500	500 m/Spool

DataTwist 2400, Nonbonded-Pair, 4-pair, 24 AWG, LSZH 3-25, Category 6	
2425D.0Z305	305 m (1000 f)/Spool
2425D.0ZA305	305 m (1000 f)/Spool-in-box
2425D.0Z500	500 m/Spool

CAT5E UTP System Cables

DataTwist 1200, Nonbonded-Pair, 4-pair, 24 AWG, CMR, Category 5e	
1212 00Z1000	305 m (1000 f)/Reel
1212 00ZU1000	305 m (1000 f)/Reel-in-box

DataTwist 1200, Nonbonded-Pair, 4-pair, 24 AWG, LSZH, Category 5e	
1224.0Z500	500 m/Spool
1224.0ZU305	305 m (1000 f)/UniReel-box

Replace Z with color: 6 (Blue), 7 (Purple), 8 (Grey), 9 (White)
Other colors available on request.

Cables – Shielded

CAT6A Shielded Cables

The **10GX shielded cable** delivers performance that goes beyond the ANSI/TIA/EIA 568-C.2 Category 6A standard. When used as the horizontal cable within the Belden 10GX Shielded System, it provides 625 MHz of proven channel bandwidth and a data rate of 10 Gigabits per second. With a thick, 100% coverage foil shield, your 10 Gb/s of data is protected from harsh EMI environments.



10GX
Shielded Cable

Adding a shield to a high performance Category 6A cable is not as easy as one would think. Any metallic shield changes the electrical performance of the cable, and if the shield is not smooth, that performance becomes unpredictable. Our design utilizes an inner and outer jacket to sandwich the foil into having a smooth surface. This eliminates adverse PSNEXT and RL effects seen with most other 10G cable products.

CAT6+ Shielded Cables

DataTwist 2400 Shielded Cable consists of 4-pair F/UTP cables that exceed Category 6 requirements as per ANSI/TIA/EIA-568-C.2. When used as the horizontal cable in the Belden 2400 Shielded System, the channel provides at least 250 MHz of bandwidth.

DataTwist 2400 F/UTP shielded cable has a thick, 100% coverage foil shield. This shield protects your system from harsh EMI environments improving your data throughput.

CAT5E Shielded Cables

DataTwist 1200 Shielded Cable consists of 4-pair F/UTP cables that exceed the Category 5e requirements as per ANSI/TIA/EIA-568-C.2 Category 5e standard. When used as the horizontal cable in the Belden 1200 Shielded System, the channel provides 160 MHz of bandwidth.

DataTwist 1200 F/UTP shielded cable has a thick, 100% coverage foil shield. This shield protects your system from harsh EMI environments improving your data throughput.

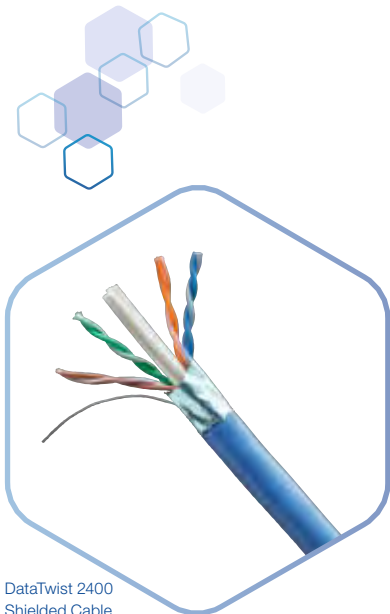

DataTwist 2400
Shielded Cable

Our End-to-End Expertise.
Your End-to-End Solution.



Part Number	Description
CAT6A Shielded System Cables	
10GX, Nonbonded-Pair, 4-pair, 23 AWG, CMR, Category 6A, F/UTP	
10GX52F 00Z1000	305 m (1000 f)/Spool
10GX, Bonded-Pair, 4-pair, 23 AWG, CMR, Category 6A, F/UTP	
10GX62F 00Z1000	305 m (1000 f)/Spool
10GX, Nonbonded-Pair, 4-pair, 23 AWG, LSZH, Category 6A, F/UTP	
10GXE00.0Z500	500 m/Spool
10GXE00.0Z100	100 m/Spool
10GX, Nonbonded-Pair, 4-pair, 23 AWG, LSZH, Category 6A, F/FTP	
10GXE01.0Z500	500 m/Spool
10GXE01.0Z305	305 m (1000 f)/Spool
10GX, Nonbonded-Pair, 4-pair, 23 AWG, LSZH, Category 6A, S/FTP	
10GXE02.0Z500	500 m/Spool
10GXE02.0Z305	305 m (1000 f)/Spool
10GX, Nonbonded-Pair, 4-pair, 23 AWG, LSZH - 3-24, Category 6A, F/FTP	
10GXE91.0Z500	500 m/Spool
10GX, Nonbonded-Pair, 4-pair, 23 AWG, LSZH - 3-24, Category 6A, S/FTP	
10GXE92.0Z500	500 m/Spool

CAT6+ Shielded System Cables

DataTwist 2400, Nonbonded-Pair, 4-pair, 23 AWG, CMR, Cat 6, F/UTP	
2412F 00Z1000	305 m (1000 f)/Spool

CAT5E Shielded System Cables

DataTwist 1200, Nonbonded-Pair, 4-pair, 24 AWG, CMR, Cat 5e, F/UTP	
1212F 00Z1000	305 m (1000 f)/Reel
1212F 00ZA1000	305 m (1000 f)/Reel-in-box

Replace **Z** with color: 6 (Blue), 7 (Purple), 8 (Grey), 9 (White)
Other colors available on request.

BELDEN
SENDING ALL THE RIGHT SIGNALS

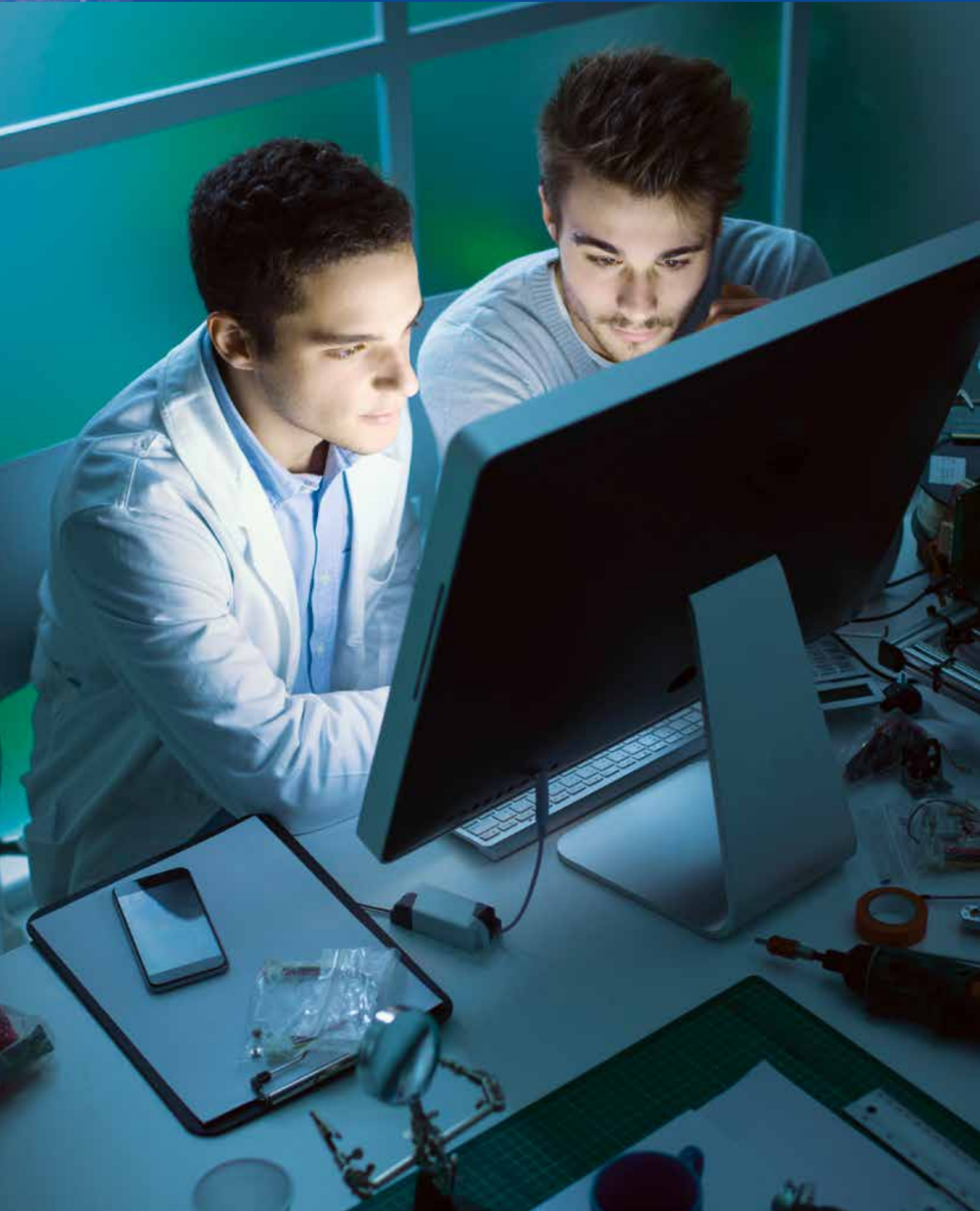

Our End-to-End Expertise.
Your End-to-End Solution.



Accessories

Section Table of Contents

■ Accessories	
Tools	20-21
Labels	22-23



Accessories – Tools



AX105568
Tool Headset for
KeyConnect Jacks



AX105566
Tool Assembly for
KeyConnect Jacks



CTPFC01
RJ45 Termination
Crimp Tool

Rapid Termination Tool

Belden's new Rapid Termination Tool reduces termination time by up to 50%, including cable preparation. All conductors are terminated and cut at once; virtually eliminating the need for troubleshooting and re-work, saving hours of re-termination and re-testing. It provides a safer working method with no need for an impact tool with a sharp blade, or a Termination Station to hold jacks.

- Terminates KeyConnect CAT6+ and CAT5E Jacks
- Diecast aluminium frame is lightweight and provides durability
- Patent Pending lever action reduces fatigue during termination process
- Polymer handle covers improve comfort
- Bottom cable entry allows ergonomic working position with minimum cable slack
- Handle Locking mechanism facilitates carrying and storage
- Easy to replace Headset (blade block and press head)
- Blade block uses stainless steel push blades and high grade tool steel knives for extra durability
- The Rapid Termination Tool is guaranteed for 5,000 terminations

Tools

The Bonded-Pair Cable Preparation Tool makes it faster and easier to prepare cables for connector termination. This tool is ideal for use with Belden Bonded-Pair cables, providing special features that help separate twisted pairs. It can also be used to prepare any unbonded-pair cable for installation.

The Termination Station is an ergonomically designed holder that provides stability to the KeyConnect Module during the termination process. The station has pockets with locking features that steadily holds KeyConnect-Style Modules or MediaFlex Inserts during pair placement and wire termination. Cable retainers on each end of the station will secure and hold cables during the pair placements process. The flat bottom surface will provide the required stability to safely terminate the modules. The tool is made of very durable plastic and its low profile makes it an easy tool to use and carry.

The Outlet Release Tool is a very convenient tool for servicing the MediaFlex and Interface outlets. Its bent tip allows for easy front removal of MediaFlex inserts, especially when used in Angled Entry plates. It is also very useful to extract KeyConnect Modules from miscellaneous mounting hardware.

The Patch Cord Tool allows to connect and disconnect RJ45 patch cords installed in very high-density environments (48-port, 1U patch panels and high-density networking equipment).

Our End-to-End Expertise.
Your End-to-End Solution.



Description	Part Number
Rapid Termination Tool	
Termination Tools for KeyConnect CAT6+ and CAT5E	
Tool Assembly for KeyConnect Jacks	AX105566
Tool Headset for KeyConnect Jacks	AX105568
Tool Pouch	AX105569
Connecting, Cable Preparation Tools, Release Tool, PCord Tool	
Bonded-Pair Cable Preparation Tool	1797B
Termination Station	AX101852
Outlet Release Tool	AX101185
Patch Cord Tool	AX102775
RJ45 Termination Crimp Tool	CTPFC01



1797B Cable Preparation Tool



AX101852 Termination Station



AX101185 Outlet Release Tool



AX102775 Patch Cord Tool



Accessories – Labels

LabelFlex

The LabelFlex solution is aimed at simplifying network management. Using the labeling system (software and label types), the installer can rapidly produce quality, application specific labels for most Belden products in a fraction of the time taken by traditional methods.

The range of Belden products covered by the labeling system is:

- GigaBIX and BIX Cross-Connect Systems
- KeyConnect Patch Panels
- Flex Patch Panels
- Workstation Outlets
- Cable Applications, 4-pair and 25-pair

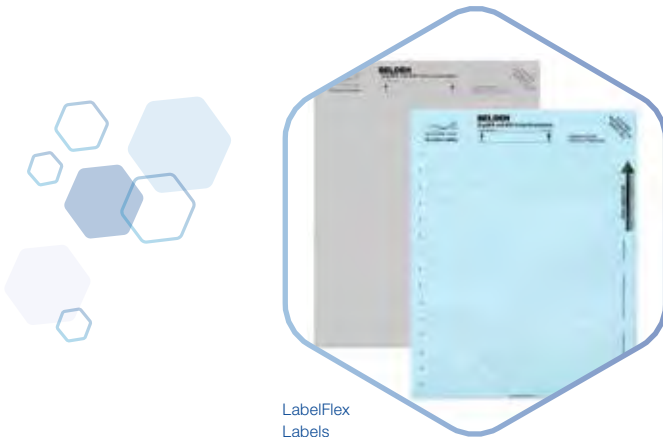

LabelFlex
Labels

Our End-to-End Expertise.
Your End-to-End Solution.



Description	Part Number
Labels	
Labels for Ultra High Density Patch Panels (KeyConnect)	
White, 24 labels/sheet, 5 sheets/pack	AX103275
Labels for 10GX, CAT6+ and KeyConnect Modular Patch Panels	
White, 24 labels/sheet, 5 sheets/pack	AX102299
Labels for KeyConnect AngleFlex and 10GX IDC Patch Panels	
White, 180 labels/sheet, 5 sheets/pack	AX103257
Labels for Flex Patch Panels	
White, 28 labels/sheet, 5 sheets/pack	AX101551
Labels for GIGABIX	
Gray, 15 labels/sheet, 5 sheets/pack	AX101532
White, 15 labels/sheet, 5 sheets/pack	AX101533
Orange, 15 labels/sheet, 5 sheets/pack	AX101534
Red, 15 labels/sheet, 5 sheets/pack	AX101535
Yellow, 15 labels/sheet, 5 sheets/pack	AX101536
Green, 15 labels/sheet, 5 sheets/pack	AX101537
Blue, 15 labels/sheet, 5 sheets/pack	AX101538
Purple, 15 labels/sheet, 5 sheets/pack	AX101539
Brown, 15 labels/sheet, 5 sheets/pack	AX101540
Silver, 15 labels/sheet, 5 sheets/pack	AX101541
Labels for Workstation Faceplates ID	
White, 80 labels/sheet, 5 sheets/pack	AX101552
Labels for Cable Applications, 4-pair & 25-pair	
White, 48 labels/sheet, 25 sheets/pack	AX101555
White, 24 labels/sheet, 25 sheets/pack	AX101556
Software	
Software available on www.belden.com	

Our End-to-End Expertise.
Your End-to-End Solution.



10GX CAT6A System Connectivity

Section Table of Contents

■ 10GX CAT6A System Connectivity	
CAT6A UTP	25–31
CAT6A UTP UHD-Panels, HD-Panels, SD-Panels, 0U-Panel	26–27
CAT6A UTP Modular Patch Cords	28–29
CAT6A UTP Traceable Modular Patch Cords	28–29
CAT6A UTP Pre-Term Modular Cable Assemblies	28–29
Connecting Components, Accessories, X-Connect Cable – 10GX IDC System	30–31
CAT6A STP	32–35
CAT6A STP HD-panels, SD-panels Unloaded and Modular	32–33
CAT6A STP Modular Patch Cords	34–35
CAT6A STP Pre-Term Modular Cable Assemblies	34–35

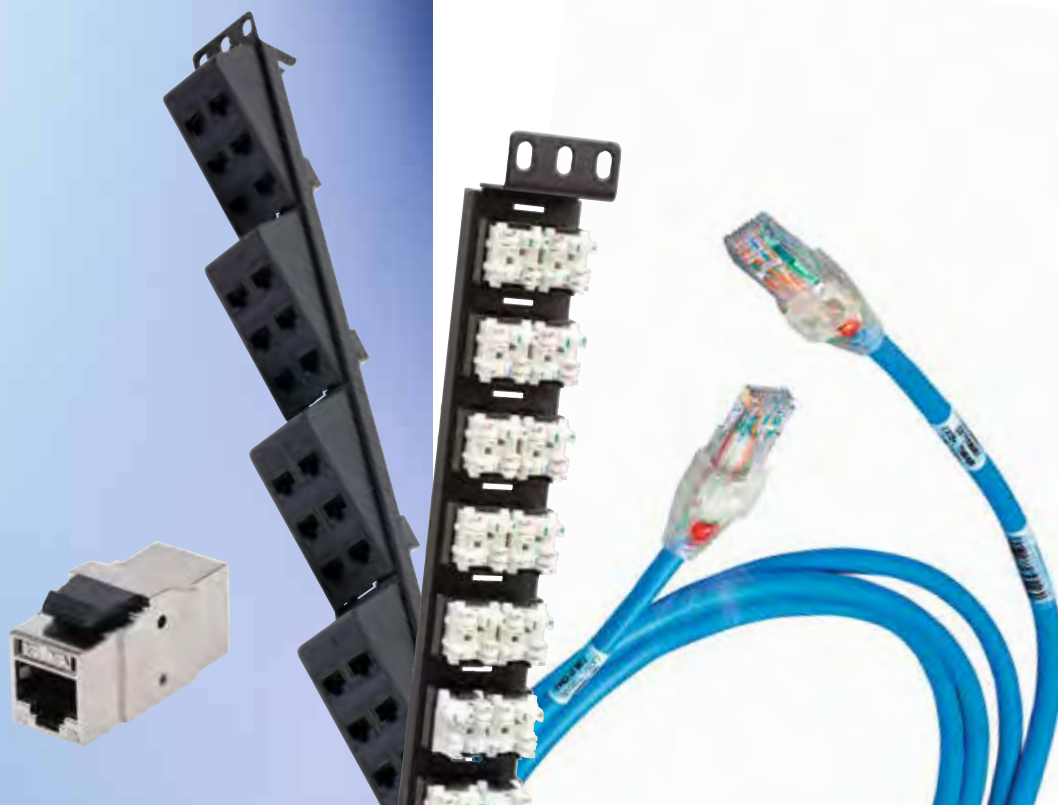

10GX CAT6A UTP System Connectivity

CAT6A UTP UHD-Panels, HD-Panels, SD-Panels, 0U-Panel

The 10GX Patch Panel is a fully loaded patch panel designed to be used within the 10GX System. It features the revolutionary 10GX Connector, specifically designed to meet the difficult challenges of 10 Gb/s transmission. 10GX Patch Panels are available in high-density options such as 24 ports in 1U or 48 ports in 2U, but the phenomenal ANEXT performance of the 10GX Connector has allowed Belden to also support an ultra high-density option offering the 10GX Ultra High-Density Patch Panel supporting 48 ports in 1U. The unmatched Beyond 10G™ performance exceeds all parameters specified in the Category 6A standard. All performance characteristics including ANEXT, NEXT, FEXT, Insertion Loss and Return Loss have been set to guarantee transmission performance up to 625 MHz.

KeyConnect Patch Panels are robust all-metal modular patch panels that provide a flexible, versatile and high-density termination solution for Data Center and Telecommunications Room installations. The modular KeyConnect Patch Panels are available in 24-port/1U, 48-port/2U and 48-port/1U configurations.

The KeyConnect Patch Panel series also includes the unique AngleFlex Patch Panel available in 24-port/1U and 48-port/2U configurations. Patent-pending removable angled inserts provide intuitive left, right or bi-directional patch cord routing and more efficient switch connection. Angled inserts eliminate the need for horizontal cable management, for a 27% space savings per rack.

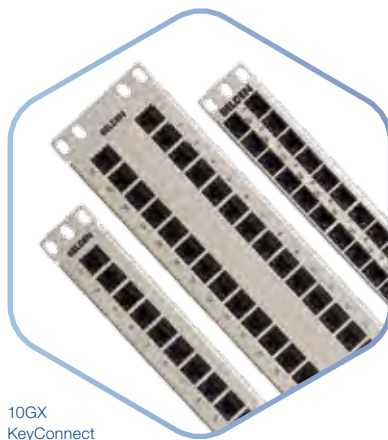

10GX
KeyConnect
Patch Panels



10GX Angled
KeyConnect
Patch Panels



Our End-to-End Expertise.
Your End-to-End Solution.



Description	Part Number
10GX CAT6A UTP Patch Panels	
10GX UHD KeyConnect Patch Panels	
10GX Flat Patch Panel, 1U, 48-port, Titanium	AX103264
10GX Angled Patch Panel, 1U, 48-port, Black	AX105365
10GX Flat Coupler Patch Panel, 1U, 48-port, Titanium	AX104592
10GX Angled Coupler Patch Panel, 1U, 48-port, Black	AX105348
10GX HD KeyConnect Patch Panels	
10GX Flat Patch Panel, 2U, 48-port, Titanium	AX103256
10GX Angled Patch Panel, 2U, 48-port, Black	AX105364
10GX Flat Coupler Patch Panel, 2U, 48-port, Titanium	AX104142
10GX Angled Coupler Patch Panel, 2U, 48-port, Black	AX105301
10GX AngleFlex Patch Panel, 2U, 48-port, Black	AX104571
10GX SD KeyConnect Patch Panels	
10GX Flat Patch Panel, 1U, 24-port, Titanium	AX103254
10GX Angled Patch Panel, 1U, 24-port, Black	AX105363
10GX Flat Coupler Patch Panel, 1U, 24-port, Titanium	AX104141
10GX Angled Coupler Patch Panel, 1U, 24-port, Black	AX105300
10GX AngleFlex Patch Panel, 1U, 24-port, Black	AX104569
10GX 0U KeyConnect Patch Panels	
10GX Vertical Mount Patch Panel, 0U, 8-port, Black	AX105366



10GX AngleFlex
Patch Panel, 1U,
24-port, Black



10GX AngleFlex
Patch Panel, 2U,
48-port, Black



10GX CAT6A UTP System Connectivity



10GX
Modular Cord



Traceable
Patch Cords



10GX Pre-Term
Cable Assemblies

CAT6A UTP Modular Patch Cords

The 10GX Modular Cords are 4-pair 24 AWG UTP modular cords designed to be used within the Belden 10GX System. Belden has designed the 10GX Modular Cord based on a patent-pending plug management bar design which allows for very good control of the internal plug NEXT. The Bonded-Pair patch cable design offers very good Alien crosstalk performance, while maintaining the important mechanical characteristics such as flexibility. The 10GX Modular Cords' design, with a very small footprint, makes them fully compatible with the highest density hubs that utilize RJ45 jack connections.

The 10GX Modular Cords are available in dark colors which match the horizontal cable colors and are also available in TIA/EIA-606 standard (pastel) colors. The unmatched performance exceeds all parameters specified in the Category 6A standard. All performance characteristics have been set to guarantee transmission performance up to 625 MHz.

- Exceeds TIA and ISO transmission and mechanical performance requirements
- Ordering code scheme to customize Bonded-Pair Patch Cord and Pigtail configurations

CAT6A UTP Traceable Modular Patch Cords

Belden Traceable Bonded-Pair Patch Cords have several unique features that make them an exceptional alternative to other patch cords on the market. They feature a highly-efficient and bright LED with a battery life expectancy of seven years, or 1,000 activations (battery is also replaceable). When activated, the LED blinks for 20 seconds and can be stopped at any time with a second press of the button. The LED and its tracing wires are integrated right into the patch cord, eliminating the need for a separate power source.

- Available in 10GX and CAT6+ for end-to-end systems
- Exceptionally bright, efficient LED light for easy identification in both bright and dark environments
- Belden Bonded-Pair technology for extra robustness, performance and reliability
- Bar code tagging on each end of the cord compatible with DCIM systems
- Low-profile plug boot supports ultra-high density 48-port 1U patch panels
- 100% factory tested and certified for CAT6A and CAT6+
- Replaceable battery with 7-year life expectancy or 1,000 activations

CAT6A UTP Pre-Term Modular Cable Assemblies

The 10GX Pre-Terminated Cabling System delivers rapid deployment coupled with guaranteed Category 6A performance and headroom, without the need for tradeoffs or compromise in performance and reliability. Bringing a new level of ease and convenience to cabling system design, ordering and installation, the system allows users to deploy their high-performance 10 Gigabit networks with optimal speed and efficiency.

Proven modular components are the cornerstone of the system. These include the 10GX Pre-Terminated Cable Assemblies and the 10GX RJ45 Modular Couplers. These components rely on unique enabling technologies: Belden's Bonded-Pair technologies ensure that the cable assemblies boast exceptional structural stability and unflinching electrical performance; and the patent-pending Dual-Flex design ensures controlled plug/jack mated connection on both sides of the coupler to provide an uninterrupted electrical path for superior connector reliability and transmission performance.

With simple planning, easy ordering and rapid delivery, the 10GX Pre-Terminated Cabling System can reduce installation time and labor costs by as much as 90 percent. In addition, this "green" system provides for plug-and-play installation and component reusability, resulting in lower installed cost and less waste.

Our End-to-End Expertise.
Your End-to-End Solution.



10GX CAT6A UTP Modular Patch Cords

Performance	Cable Type	Termination	Color	Length (meter)
10GX (CAT6A) = CA	LSZH patch cord = 24	T568A/B – T568A/B = 1	Red = 02	0.5 m = 0D5M
		Crossover T568A/B = 4	Orange = 03	1.0 m = 001M
	PVC patch cord = 99	Crossover IEEE = 5	Yellow = 04	2.0 m = 002M
			Green = 05	3.0 m = 003M
	Pigtails		Blue = 06	5.0 m = 005M
	LSZH Pigtail = 34	T568A – Open = 2	Purple = 07	10.0 m = 010M
	PVC Pigtail = 39	T568B – Open = 3	Grey = 08	
			White = 09	
			Black = 00	

Example Partnumber: **CA24106003M**

CA = CAT6A/UTP
24 = LSZH
1 = T568A/B
06 = Blue
003M = 3 meter patch cord

10GX CAT6A UTP Traceable Modular Patch Cords

Performance	Cable Type	Termination	Color	Length (feet)
10GX (CAT6A) = CA	CMR patch cord = T1	T568A/B – T568A/B = 1	Red = 02	2.0 ft = 002
			Orange = 03	4.0 ft = 004
			Yellow = 04	7.0 ft = 007
			Green = 05	10.0 ft = 010
			Blue = 06	15.0 ft = 015
			Purple = 07	20.0 ft = 020
			Grey = 08	
			White = 09	
			Black = 00	

Example Partnumber: **CAT1106004**

CA = CAT6A/UTP
T1 = CMR
1 = T568A/B
06 = Blue
004 = 4 feet patch cord

10GX CAT6A UTP Pre-Term Modular Cable Assemblies

Performance	Cable Type	Termination	Color	Length (meter)	Bundle
10GX (CAT6A) = CA	LSZH Cable Assy = 24	T568A/B – T568A/B = 1	Blue = 06	5.0 m = 005M	6 Cables = A06
			Grey = 08	10.0 m = 010M	8 Cables = A08
			White = 09	15.0 m = 015M	
			Black = 00	20.0 m = 020M	
				25.0 m = 025M	
				30.0 m = 030M	
				40.0 m = 040M	
				50.0 m = 050M	
				90.0 m = 090M	

Example Partnumber: **CA24106025MA06**

CA = CAT6A/UTP
24 = LSZH
1 = T568A/B
06 = Blue
025M = 25 meter
A06 = 6 cable pre-term assembly

10GX CAT6A UTP System Connectivity

Connecting Components, Accessories, X-Connect Cable

The Belden 10GX IDC System is a high-performance, space-efficient modular connection system. The system meets the TIA/EIA 568-C.2 standard, plus it is uniquely engineered to deliver unmatched 10G performance – handling 10GBase-T data networking and multi-media applications with headroom to spare.

The 10GX IDC System is extremely flexible in that it accommodates the configuration of large cross-connect systems and the configuration of interconnect systems within racks. Because of its modularity, the system also accommodates future moves, adds and changes (MACs) with ease.



10GX IDC
Connector



10GX IDC
Patch Panel, shown
with 10GX IDC Connectors



10GX IDC
X-Connect Cable

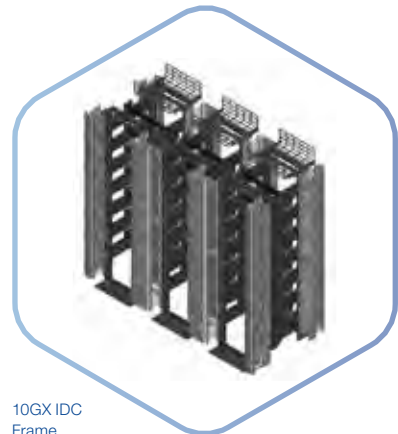

10GX IDC
Frame



Our End-to-End Expertise.
Your End-to-End Solution.



Description	Part Number
10GX CAT6A IDC System	
10GX IDC Patch Panel Components	
10GX IDC Patch Panel, 24-port, 1U, Black (Empty)	AX104138
10GX IDC Connector (24 units/pkg)	AX104139
10GX IDC Block Front (100 units/pkg)	AX102679
10GX IDC Block Rear (100 units/pkg)	AX102680
10GX IDC Accessories	
10GX IDC Test Adapter	AX104006
10GX IDC X-Connect Cable	
10GX IDC X-Connect Cable	10GB24.00Z1000

Replace **Z** with color: 6 (Blue), 7 (Purple), 8 (Grey), 9 (White)

10GX IDC Frame	
Two Post Self Supporting Rack	BHHR194
6 in. Vertical Manager	BHVH006
12 in. Vertical Manager	BHVH012
Front-to-Back Trough Kit 42 in.	AX104225
Front-to-Back Trough Kit 38 in.	AX104225-S
Overhead Kit	AX104226



10GX CAT6A STP System Connectivity

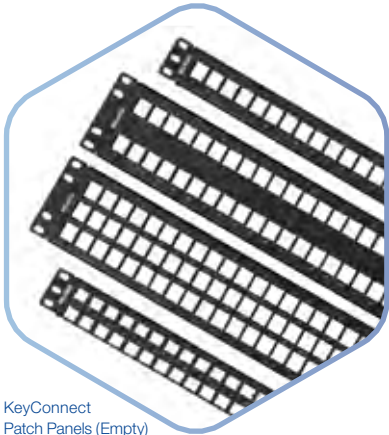

KeyConnect Patch Panels (Empty)

CAT6A STP HD-panels, SD-panels

KeyConnect Shielded Patch Panels are robust all-metal modular patch panels that provide a flexible, versatile and high-density termination solution for Data Center and Telecommunications Room installations. They come with a ground wire to guarantee shielding integrity (per TIA-607-B) and cable management brackets for neat cable dressing. The KeyConnect Shielded Patch Panels can be configured using 10GX Shielded Modular Jacks or any other KeyConnect modules.

Unloaded and Modular

The 10GX Patch Panel is a fully loaded patch panel designed to be used within the IBDN 10GX System. It features the revolutionary 10GX Connector, specifically designed to meet the difficult challenges of 10 Gb/s transmission.

10GX Patch Panels are available in high-density options such as 24 ports in 1U or 48 ports in 2U, but the phenomenal ANEXT performance of the 10GX Connector has allowed Belden to also support an ultra high-density option offering the 10GX Ultra High-Density Patch Panel supporting 48 ports in 1U. The unmatched Beyond 10G™ performance exceeds all parameters specified in the Category 6A standard. All performance characteristics including ANEXT, NEXT, FEXT, Insertion Loss and Return Loss have been set to guarantee transmission performance up to 625 MHz.

KeyConnect Patch Panels are robust all-metal modular patch panels that provide a flexible, versatile and high-density termination solution for Data Center and Telecommunications Room installations.

The KeyConnect Patch Panel series also includes the unique Angled Patch Panel available in 24-port/1U and 48-port/2U configurations. Provide intuitive left, right or bi-directional patch cord routing and more efficient switch connection. Angled eliminate the need for horizontal cable management, for a 27% space savings per rack.



10GX Shielded Modular Jack



10GX Shielded KeyConnect RJ45 Coupler



Our End-to-End Expertise.
Your End-to-End Solution.



Description	Part Number
-------------	-------------

10GX CAT6A Shielded Empty Patch Panels

HD KeyConnect Patch Panels

Flat Patch Panel, 2U, 48-port, Black	AX106911
10GX Angled Patch Panel, 2U, 48-port, Titanium	AX104623

SD KeyConnect Patch Panels

10GX Flat Patch Panel, 1U, 24-port, Black	AX106902
10GX Angled Patch Panel, 1U, 24-port, Black	AX106812

KeyConnect-Style Shielded Modular Jacks/Coupler

Color-coded Icon Kit

Red	AX104632-RD
Green	AX104632-GN
White	AX104632-EW
Orange	AX104632-OR
Blue	AX104632-BL
Black	AX104632-BK
Yellow	AX104632-YE
Purple	AX104632-PR

10GX KeyConnect Modular Jack/Coupler

10GX Shielded KeyConnect Modular Jack, Metallic	AX104562
10GX KeyConnect Shielded RJ45 Coupler	AX104501



AX104623
Patch Panels
(Angled, 2U, 48-port)



10GX CAT6A STP System Connectivity



10GX Shielded
Modular Cord

CAT6A STP Modular Patch Cords

10GX Modular Cords are designed around a patent pending plug management bar design which allows for very good control of the internal plug NEXT. The cord design offers excellent alien crosstalk performance, while maintaining flexibility. The system's unmatched performance exceeds all parameters specified in the Category 6A standard with guaranteed transmission performance up to 625 MHz.

CAT6A STP Pre-Term Modular Cable Assemblies

The 10GX Shielded Pre-Terminated Cabling System delivers rapid deployment coupled with guaranteed Category 6A performance and headroom, without the need for tradeoffs or compromise in performance and reliability. Bringing a new level of ease and convenience to cabling system design, ordering and installation, the system allows users to deploy their high-performance 10 Gigabit networks with optimal speed and efficiency. Proven modular components are the cornerstone of the system. These include the 10GX Shielded Pre-Terminated Cable Assemblies and the 10GX Shielded RJ45 Modular Couplers. These components rely on unique enabling technologies: Belden's Bonded-Pair technologies ensure that the cable assemblies boast exceptional structural stability and unfailing electrical performance; and the patent-pending Dual-FleX design ensures controlled plug/jack mated connection on both sides of the coupler to provide an uninterrupted electrical path for superior connector reliability and transmission performance.



10GX Shielded
Pre-Terminated
Cable System

With simple planning, easy ordering and rapid delivery, the 10GX Shielded Pre-Terminated Cabling System will drastically reduce installation time and labor cost. In addition, this "green" system provides for plug-and-play installation and component reusability, resulting in lower installation cost and less waste.

Our End-to-End Expertise.
Your End-to-End Solution.



10GX CAT6A STP Modular Patch Cords

Performance	Cable Type	Termination	Color	Length (meter)	
10GX (CAT6A) = CA	LSZH patch cord = E4	T568A/B – T568A/B = 1	Red = 02	0.5 m = 0D5M	
		Crossover T568A/B = 4	Orange = 03	1.0 m = 001M	
		Crossover IEEE = 5	Yellow = 04	2.0 m = 002M	
	Pigtails			Green = 05	3.0 m = 003M
	LSZH Pigtail = G4	T568A – Open = 2	Blue = 06	5.0 m = 005M	
		T568B – Open = 3	Purple = 07	10.0 m = 010M	
			Grey = 08		
			White = 09		
			Black = 00		

Example Partnumber: **CAE4106003M**

- CA = CAT6A/STP
- E4 = LSZH
- 1 = T568A/B
- 06 = Blue
- 003M = 3 meter patch cord

10GX CAT6A STP Pre-Term Modular Cable Assemblies

Performance	Cable Type	Termination	Color	Length (meter)	Bundle
10GX (CAT6A) = CA	LSZH CableAssy = E4	T568A/B – T568A/B = 1	Blue = 06	5.0 m = 005M	6 Cables = A06
			Grey = 08	10.0 m = 010M	8 Cables = A08
			White = 09	15.0 m = 015M	
			Black = 00	20.0 m = 020M	
				25.0 m = 025M	
				30.0 m = 030M	
				40.0 m = 040M	
				50.0 m = 050M	
				90.0 m = 090M	

Example Partnumber: **CAE4106025MA06**

- CA = CAT6A/STP
- E4 = LSZH
- 1 = T568A/B
- 06 = Blue
- 025M = 25 meter
- A06 = 6 cable pre-term assembly

BELDEN

SENDING ALL THE RIGHT SIGNALS



Our End-to-End Expertise.
Your End-to-End Solution.



2400 CAT6+ System Connectivity

Section Table of Contents

■ 2400 CAT6+ System Connectivity	
CAT6+ UTP	37-43
CAT6+ UTP UHD-Panels, HD-Panels, SD-Panels, OU-Panel	38-39
CAT6+ UTP Bonded-Pair Modular Patch Cords and Nonbonded-Pair Pigtails	40-41
CAT6+ UTP Traceable Modular Patch Cords	40-41
CAT6+ UTP Pre-Term Modular Cable Assemblies	40-41
CAT6+ UTP GigaBIX IDC System	42-43
CAT6+ STP	44-47
CAT6+ STP SHD-panels, SD-panels	44-45
CAT6+ KeyConnect Style Shielded Modular Jacks	44-45
CAT6+ STP Modular Patch Cords	46-47



2400 CAT6+ UTP System Connectivity

CAT6+ UTP UHD-Panels, HD-Panels, SD-Panels, 0U-Panel

The KeyConnect Patch Panel Series is a comprehensive line of robust all-metal, preloaded and modular patch panels. The series provides a flexible, versatile and high-density termination solution for Data Center and Telecommunications Room installations. The preloaded KeyConnect Patch Panels are available in 24-port/1U and 48-port/2U configurations with CAT6+ KeyConnect Modular Jacks. The modular KeyConnect Patch Panels are available in 24-port/1U, 48-port/1U, 48-port/2U configurations.

The KeyConnect Patch Panel series also includes the unique AngleFlex Patch Panel available in 24-port/1U and 48-port/2U configurations. Patent-pending removable angled inserts provide intuitive left, right or bi-directional patch cord routing and more efficient switch connection. Angled inserts eliminate the need for horizontal cable management, for a 27% space savings per rack.

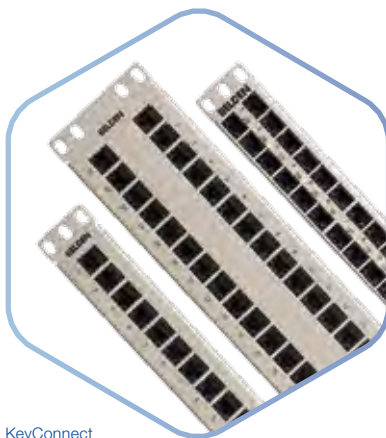

KeyConnect
Patch Panels



Angled
KeyConnect
Patch Panels



Our End-to-End Expertise.
Your End-to-End Solution.



Description	Part Number
CAT6+ UTP Patch Panels	
CAT6+ UHD KeyConnect Patch Panels	
CAT6+ Flat Patch Panel, 1U, 48-port, Black	AX103263
CAT6+ Angled Patch Panel, 1U, 48-port, Black	AX105362
CAT6+ Flat Coupler Patch Panel, 1U, 48-port, Black	AX104591
CAT6+ Angled Coupler Patch Panel, 1U, 48-port, Black	AX105351
CAT6+ HD KeyConnect Patch Panels	
CAT6+ Flat Patch Panel, 2U, 48-port, Black	AX103255
CAT6+ Angled Patch Panel, 2U, 48-port, Black	AX105361
CAT6+ Flat Coupler Patch Panel, 2U, 48-port, Black	AX104228
CAT6+ Angled Coupler Patch Panel, 2U, 48-port, Black	AX105350
CAT6+ AngleFlex Patch Panel, 2U, 48-port, Black	AX104570
CAT6+ SD KeyConnect Patch Panels	
CAT6+ Flat Patch Panel, 1U, 24-port, Black	AX103253
CAT6+ Angled Patch Panel, 1U, 24-port, Black	AX105360
CAT6+ Flat Coupler Patch Panel, 1U, 24-port, Black	AX104227
CAT6+ Angled Coupler Patch Panel, 1U, 24-port, Black	AX105349
CAT6+ AngleFlex Patch Panel, 1U, 24-port, Black	AX104568
CAT6+ 0U KeyConnect Patch Panels	
CAT6+ Vertical Mount Patch Panel, 0U, 8-port, Black	AX105367



AngleFlex
Patch Panel, 1U,
24-port, Black



AngleFlex
Patch Panel, 2U,
48-port, Black



2400 CAT6+ UTP System Connectivity



CAT6+
Bonded-Pair
Patch Cords

CAT6+ UTP Bonded-Pair Modular Patch Cords and Nonbonded-Pair Pigtails

The CAT6+ Series of Bonded-Pair Patch Cords are made with Belden's patented robust design Bonded-Pair cables. These modular cords offer the best combination of transmission performance and physical integrity.

- Exceeds TIA and ISO transmission and mechanical performance requirements
- Ordering code scheme to customize Bonded-Pair Patch Cord and Pigtail configurations
- Made with small diameter Bonded-Pair cable for greater flexibility and higher density installations
- Solid conductors improve attenuation and are needed in long patch cords and pigtails to eliminate the need for cable de-rating in open-office cabling
- Improved strain relief and a flexible boot for optimum protection in high-density installations
- Wrap-around label on each cord for easier product identification and length sorting



Traceable
Patch Cords

CAT6+ UTP Traceable Modular Patch Cords

Belden Traceable Bonded-Pair Patch Cords have several unique features that make them an exceptional alternative to other patch cords on the market. They feature a highly-efficient and bright LED with a battery life expectancy of seven years, or 1,000 activations (battery is also replaceable). When activated, the LED blinks for 20 seconds and can be stopped at any time with a second press of the button. The LED and its tracing wires are integrated right into the patch cord, eliminating the need for a separate power source.



Pre-Terminated
Cable Assembly

CAT6+ UTP Pre-Term Modular Cable Assemblies

Belden's CAT6+ Pre-Terminated Cabling System delivers rapid deployment coupled with guaranteed Category 6 performance and headroom, without the need for tradeoffs or compromise in performance and reliability. Bringing a new level of ease and convenience to cabling system design, ordering and installation, the system allows users to deploy their high-performance cabling networks with optimal speed and efficiency.

Proven modular components are the cornerstone of the system. These include the Pre-Terminated Cable Assemblies and the CAT6+ RJ45 Modular Couplers. These components rely on unique enabling technologies: Belden's Bonded-Pair technologies ensure that the cable assemblies boast exceptional structural stability and unfailing electrical performance; and the patent-pending plug management bar design which allows for very good control of the internal plug NEXT and superior plug/jack mated-pair performance.

With simple planning, easy ordering and rapid delivery, Pre-Terminated Cabling System can reduce installation time and labor costs by as much as 90 percent. In addition, this "green" system provides for plug-and-play installation and component reusability, resulting in lower installed cost and less waste.

Our End-to-End Expertise.
Your End-to-End Solution.



CAT6+ UTP Modular Patch Cords

Performance	Cable Type	Termination	Color	Length (meter)
CAT6+ (CAT6/5E) = C6	LSZH patch cord = 24	T568A/B – T568A/B = 1	Red = 02	0.5 m = 0D5M
		Crossover T568A/B = 4	Orange = 03	1.0 m = 001M
	Crossover IEEE = 5		Yellow = 04	2.0 m = 002M
	Pigtails		Green = 05	3.0 m = 003M
	LSZH Pigtail = 34	T568A – Open = 2	Blue = 06	5.0 m = 005M
		PVC Pigtail = 39	T568B – Open = 3	Purple = 07
				Grey = 08
			White = 09	
			Black = 00	

Example Partnumber: **C624106003M**

C6 = CAT6/UTP
24 = LSZH
1 = T568A/B
06 = Blue
003M = 3 meter patch cord

CAT6+ UTP Traceable Modular Patch Cords

Performance	Cable Type	Termination	Color	Length (feet)
CAT6+ (CAT6) = C6	CMR patch cord = T1	T568A/B – T568A/B = 1	Red = 02	2.0 ft = 002
			Orange = 03	4.0 ft = 004
			Yellow = 04	7.0 ft = 007
			Green = 05	10.0 ft = 010
			Blue = 06	15.0 ft = 015
			Purple = 07	20.0 ft = 020
			Grey = 08	
			White = 09	
			Black = 00	

Example Partnumber: **C6T1106004**

C6 = CAT6/UTP
T1 = CMR
1 = T568A/B
06 = Blue
004 = 4 feet patch cord

CAT6+ UTP Pre-Term Modular Cable Assemblies

Performance	Cable Type	Termination	Color	Length (feet)	Bundle
CAT6+ (CAT6) = C6	CMR CableAssy = 01	T568A/B – T568A/B = 1	Blue = 06	17.0 ft = 017	6 Cables = A06
			White = 09	33.0 ft = 033	8 Cables = A08
			Black = 00	50.0 ft = 050	
				66.0 ft = 066	
				82.0 ft = 082	
				99.0 ft = 099	

Example Partnumber: **C601106050A06**

C6 = CAT6/UTP
01 = CMR
1 = T568A/B
06 = Blue
050 = 50 feet
A06 = 6 cable pre-term assembly

2400 CAT6+ UTP System Connectivity

CAT6+ UTP GigaBIX IDC System

The Belden GigaBIX Cross-Connect System takes advantage of the proven reliability of BIX technology to provide high-performance connections for data networks. This uniquely designed system allows for very high termination density, while maintaining optimal ease of administration to accommodate moves, adds and changes.

Advantages of the Belden GigaBIX Cross-Connect System include easy installation and cable management, coupled with the industry's best performance-to-price ratio for high-density connectivity. The system allows up to 300 pairs to be terminated in a very small area – a real space saving advantage in today's office environment where real estate is at a premium.

GigaBIX Termination
Kit, 72-port



GigaBIX Cable
Management Module



GigaBIX Patch
Cord Organizer

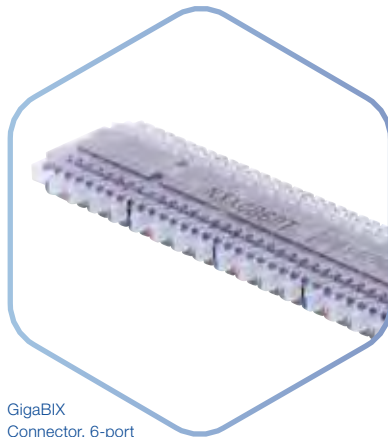

GigaBIX
Connector, 6-port



CAT6+
GigaBIX Patch
Cord, BIX-BIX, 4 ft



Our End-to-End Expertise.
Your End-to-End Solution.



Description	Part Number
CAT6+ UTP GigaBIX IDC System	
GigaBIX Termination Kits	
GigaBIX Termination Kit, 72-port	AX101470
GigaBIX Termination Kit, 300-pair	AX101471
GigaBIX Rack Mount Termination Kit, 48-port	AX101985
GigaBIX Connecting Components	
GigaBIX Connector, 6-port	AX101447
GigaBIX Connector, 25-pair	AX101448
GigaBIX Mount, 12-connector	AX101472
GigaBIX Rack Mount Panel, 48-port, 3U, Empty	AX101986
GigaBIX Wire Guard	AX101486
GigaBIX Designation Strip	AX101483
GigaBIX Termination Bar	AX101719
GigaBIX Cable Management Accessories	
GigaBIX Cable Management Module	AX101469
GigaBIX Patch Cord Organizer	AX101468
GigaBIX Patch Cord Organizer, Cover	AX101521
GigaBIX Horizontal Channel Plate	AX101520
GigaBIX Management Ring	AX101478
GigaBIX/MediaFlex Adapter	AX101987
10GX IDC Connecting Block Holder 6 positions	AX102677
GigaBIX Color-Coded Clip	
Gray	AX102146
Green	AX102153
Black	AX102149
Red	AX102151
Blue	AX102154
Yellow	AX102152
White	AX102148
GigaBIX Frames and Accessories	
GigaBIX Frame, 1152 ports/4800 pairs	AX102073
GigaBIX Deep Frame, 1152 ports/4800 pairs	AX104474
GigaBIX Frame End Kit	AX102082
GigaBIX Frame Overhead Kit	AX102145
Cross-Connect Wire	
GigaBIX 4-pair XC Wire, Reel-in-a-Box	XCGB4 000A1000
GigaBIX 4-pair XC Wire, Reel	XCGB4 000I000

CAT6+ UTP GigaBIX Patch Cords

Length	Part Number		
	P/N BIX-BIX	P/N BIX-8MOD T568A-ISDN	P/N BIX-8MOD T568B-ALT
1.2 m (4 ft)	AX101945	AX101951	AX101957
1.8 m (6 ft)	AX101946	AX101952	AX101958
2.4 m (8 ft)	AX101947	AX101953	AX101959
3.0 m (10 ft)	AX101948	AX101954	AX101960
4.6 m (15 ft)	AX101949	AX101955	AX101961
7.6 m (25 ft)	AX101950	AX101956	AX101962

2400 CAT6+ STP System Connectivity

CAT6+ STP SHD-panels, SD-panels

KeyConnect Shielded Patch Panels are robust all-metal modular patch panels that provide a flexible, versatile and high-density termination solution for Data Center and Telecommunications Room installations. The modular KeyConnect Patch Panels are available in 24-port/1U and 48-port/2U and are complete with a ground wire and cable management brackets to guarantee shielding integrity (per TIA-607-B) and neat cable dressing. The KeyConnect Shielded Patch Panels can be configured using 10GX Shielded Modular Jacks or any other KeyConnect modules.

CAT6+ KeyConnect Style Shielded Modular Jacks

The CAT6+ Shielded KeyConnect Modular Jack is a rugged tool-less connector designed to be used within the Belden 2400 Shielded System. Its 2-piece die-cast housing and its shielding lug provide a reliable shield and 360 degree durable bonding to the cable foil. Its color-coded wire guide speeds up pair placement and terminates all pairs when closing the 2-piece housing.

The excellent CAT6+ performance exceeds all parameters specified in the TIA Category 6 standard. Its performance characteristics including ANEXT, NEXT, FEXT, Insertion Loss and Return Loss have been set to guarantee transmission performance up to 250 MHz with a 10 dB margin on PSANEXT and PSAACRF. Its keystone footprint makes it compatible with KeyConnect Shielded Patch Panels and with KeyConnect and MediaFlex Workstation Outlets.

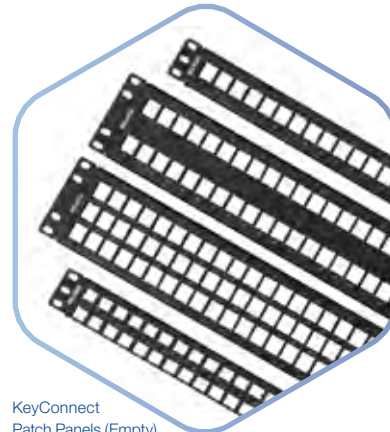

KeyConnect
Patch Panels (Empty)



CAT6+
Shielded
KeyConnect Modular Jack

Our End-to-End Expertise.
Your End-to-End Solution.



Description	Part Number
CAT6+ Shielded Empty Patch Panels	
HD KeyConnect Patch Panels	
Flat Patch Panel, 2U, 48-port, Black	AX106911
Angled Patch Panel, 2U, 48-port, Titanium	AX104623
SD KeyConnect Patch Panels	
Flat Patch Panel, 1U, 24-port, Black	AX106902
Angled Patch Panel, 1U, 24-port, Black	AX106812
KeyConnect-Style Shielded Modular Jacks/Coupler	
Color-coded Icon Kit	
Red	AX104632-RD
Green	AX104632-GN
White	AX104632-EW
Orange	AX104632-OR
Blue	AX104632-BL
Black	AX104632-BK
Yellow	AX104632-YE
Purple	AX104632-PR
CAT6+ KeyConnect Modular Jack	
CAT6+ Shielded KeyConnect Modular Jack, Metallic	AX104596



AX104623
Patch Panels
(Angled, 2U, 48-port)

2400 CAT6+ STP System Connectivity

CAT6+ STP Modular Patch Cords

The CAT6+ Shielded Modular Cords are 4-pair 24 AWG F/UTP modular cords designed to be used within the Belden 2400 Shielded System. These modular cords offer the best combination of transmission performance and shielding integrity.

- Exceeds TIA transmission and mechanical performance requirements
- Excellent shielding integrity per TIA-607-B
- Made with small diameter for greater flexibility and higher density installations
- Solid conductors 24 AWG improve attenuation and are needed in long patch cords and pigtails to eliminate the need for cable de-rating in open-office cabling
- Improved strain relief and a flexible boot for optimum protection in high-density installations
- Wrap-around label on each cord for easier product identification and length sorting



CAT6+
Shielded
Modular Cord



Our End-to-End Expertise.
Your End-to-End Solution.



CAT6+ STP Modular Patch Cords

Performance	Cable Type	Termination	Color	Length (meter)	
CAT6+ (CAT6/5E) = C6	LSZH CAT6+ = S4 Patch cord	T568A/B – T568A/B = 1	Red = 02	0.5 m = 0D5M	
		Crossover T568A/B = 4	Orange = 03	1.0 m = 001M	
		Crossover IEEE = 5	Yellow = 04	2.0 m = 002M	
		Pigtails		Green = 05	3.0 m = 003M
		LSZH Pigtail = B4	T568A – Open = 2	Blue = 06	5.0 m = 005M
	T568B – Open = 3		Purple = 07	10.0 m = 010M	
			Grey = 08		
			White = 09		
			Black = 00		

Example Partnumber: **C6S4106003M**

- C6 = CAT6/STP
- S4 = LSZH
- 1 = T568A/B
- 06 = Blue
- 003M = 3 meter patch cord

BELDEN

SENDING ALL THE RIGHT SIGNALS



Our End-to-End Expertise.
Your End-to-End Solution.



1200 CAT5E System Connectivity

Section Table of Contents

1200 CAT5E System Connectivity	Page
CAT5E UTP	49–53
CAT5E UTP UHD-panels, HD-Panels, SD-Panels, OU-Panel	50–51
CAT5E UTP KeyConnect Patch Panels	50–51
CAT5E UTP KeyConnect Preloaded Patch Panels	50–51
UTP Modular Patch Cords	52–53
Traceable Bonded-Pair Patch Cords	52–53
CAT5E STP	54–57
CAT5E STP HD-panels, SD-panels	54–55
CAT5E STP KeyConnect-Style Shielded Modular Jack	54–55
CAT5E Shielded Modular Cords, Patch Cords and Pigtails	56–57



1200 CAT5E UTP System Connectivity

CAT5E UTP UHD-panels, HD-Panels, SD-Panels, 0U-Panel

The CAT5E HD Patch Panels are robust and installer-friendly products by design, combining punch down connectors with standard modular jacks. CAT5E HD Patch Panels offer Category 5e performance and are designed to be used with the Belden 1200 System.

CAT5E UTP KeyConnect Patch Panels

The KeyConnect Patch Panels are a comprehensive line of robust all-metal, preloaded and modular patch panels. The series provides a flexible, versatile and high-density termination solution for Data Center and Telecommunications Room installations.

CAT5E UTP KeyConnect Preloaded Patch Panels

The modular KeyConnect Patch Panels are available in 24-port/1U, 48-port/2U and 48-port/1U configurations. Belden's unique KeyConnect AngleFlex Patch Panels are also available in 24-port/1U and 48-port/2U and offer better port-density and patch cord manageability.



KeyConnect
Patch Panels



KeyConnect
Coupler Patch
Panel (Preloaded)

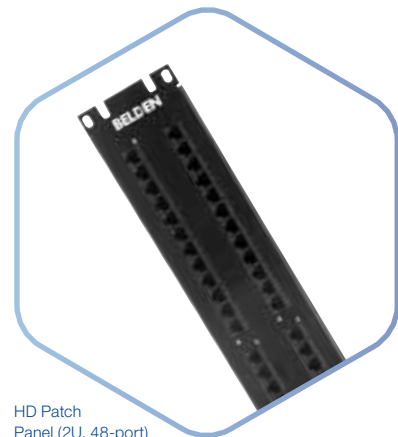

HD Patch
Panel (2U, 48-port)

Our End-to-End Expertise.
Your End-to-End Solution.



Description	Part Number
CAT5E UTP Patch Panels	
CAT5E UHD KeyConnect Patch Panels	
CAT5E Flat Patch Panel, 1U, 48-port, Black	AX103262
CAT5E Angled Patch Panel, 1U, 48-port, Black	AX105359
CAT5E HD KeyConnect Patch Panels	
CAT5E Flat Patch Panel, 2U, 48-port, Black	AX104014
CAT5E Angled Patch Panel, 2U, 48-port, Black	AX105358
CAT5E SD KeyConnect Patch Panels	
CAT5E Flat Patch Panel, 1U, 24-port, Black	AX104013
CAT5E Angled Patch Panel, 1U, 24-port, Black	AX105357



Angled
KeyConnect
Patch Panels

1200 UTP System Connectivity

UTP Modular Patch Cords

Belden's UTP Patch Cords are made with Belden's patented robust design Bonded-Pair cables. These modular cords offer the best combination of transmission performance and physical integrity.

- Made with small diameter Bonded-Pair cable for greater flexibility and higher density installations
- Solid conductors improve attenuation and are needed in long patch cords and pigtailed to eliminate the need for cable de-rating in open-office cabling
- Improved strain relief and a flexible boot for optimum protection in high-density installations
- Wrap-around label on each cord for easier product identification and length sorting
- Exceeds TIA and ISO transmission and mechanical performance requirements
- Ordering code scheme to customize Bonded-Pair Patch Cord and Pigtail configurations

Traceable Bonded-Pair Patch Cords

Belden Traceable Bonded-Pair Patch Cords have several unique features that make them an exceptional alternative to other patch cords on the market.

They feature a highly-efficient and bright LED with a battery life expectancy of seven years, or 1,000 activations (battery is also replaceable). When activated, the LED blinks for 20 seconds and can be stopped at any time with a second press of the button. The LED and its tracing wires are integrated right into the patch cord, eliminating the need for a separate power source.



CAT5E
Bonded-Pair
Patch Cords



Traceable
Patch Cords

Our End-to-End Expertise.
Your End-to-End Solution.



UTP Modular Patch Cords

Performance	Cable Type	Termination	Color	Length (meter)
CAT6+ (CAT6/5E) = C6	LSZH patch cord = 24	T568A/B – T568A/B = 1	Red = 02	0.5 m = 0D5M
		Crossover T568A/B = 4	Orange = 03	1.0 m = 001M
	PVC patch cord = 99	Crossover IEEE = 5	Yellow = 04	2.0 m = 002M
		Pigtails		Green = 05
	LSZH Pigtail = 34	T568A – Open = 2	Blue = 06	5.0 m = 005M
	PVC Pigtail = 39	T568B – Open = 3	Purple = 07	10.0 m = 010M
			Grey = 08	
			White = 09	
			Black = 00	

Example Partnumber: **C624106003M**

- C6 = CAT6/UTP
- 24 = LSZH
- 1 = T568A/B
- 06 = Blue
- 003M = 3 meter patch cord

CAT6+ UTP Traceable Modular Patch Cords

Performance	Cable Type	Termination	Color	Length (feet)
CAT6+ (CAT6) = C6	CMR patch cord = T1	T568A/B – T568A/B = 1	Red = 02	2.0 ft = 002
			Orange = 03	4.0 ft = 004
			Yellow = 04	7.0 ft = 007
			Green = 05	10.0 ft = 010
			Blue = 06	15.0 ft = 015
			Purple = 07	20.0 ft = 020
			Grey = 08	
			White = 09	
			Black = 00	

Note: we offer CAT6 for this system solution

Example Partnumber: **C6T1106004**

- C6 = CAT6/UTP
- T1 = CMR
- 1 = T568A/B
- 06 = Blue
- 004 = 4 feet patch cord

1200 CAT5E STP System Connectivity

CAT5E STP HD-panels, SD-panels

KeyConnect Shielded Patch Panels are robust all-metal modular patch panels that provide a flexible, versatile and high-density termination solution for Data Center and Telecommunications Room installations. The modular KeyConnect Patch Panels are available in 24-port/1U and 48-port/2U and are complete with a ground wire and cable management brackets to guarantee shielding integrity (per TIA-607-B) and neat cable dressing. The KeyConnect Shielded Patch Panels can be configured using 10GX Shielded Modular Jacks or any other KeyConnect modules.

CAT5E STP KeyConnect-Style Shielded Modular Jack

The CAT5E Shielded KeyConnect Modular Jack is a rugged tool-less connector designed to be used within the Belden 1200 Shielded System. Its 2-piece die-cast housing and its shielding lug provide a reliable shield and 360 degree durable bonding to the cable foil. Its color-coded wire guide speeds up pair placement and terminates all pairs when closing the 2-piece housing.

The excellent CAT5E performance exceeds all parameters specified in the TIA Category 5e standard. Its performance characteristics including ANEXT, NEXT, FEXT, Insertion Loss and Return Loss have been set to guarantee transmission performance up to 160 MHz with a 10 dB margin on PSANEXT and PSAACRF. Its keystone footprint makes it compatible with KeyConnect Shielded Patch Panels and with KeyConnect and Workstation Outlets.

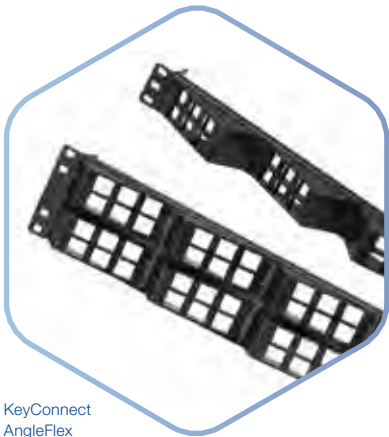

KeyConnect
AngleFlex
Patch Panels

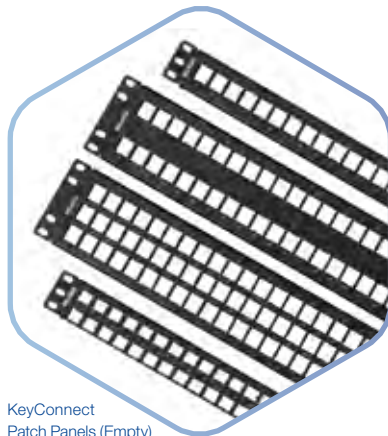

KeyConnect
Patch Panels (Empty)

Our End-to-End Expertise.
Your End-to-End Solution.



Description	Part Number
CAT5E Shielded Empty Patch Panels	
HD KeyConnect Patch Panels	
Flat Patch Panel, 2U, 48-port, Black	AX106911
Angled Patch Panel, 2U, 48-port, Titanium	AX104623
SD KeyConnect Patch Panels	
Flat Patch Panel, 1U, 24-port, Black	AX106902
Angled Patch Panel, 1U, 24-port, Black	AX106812
CAT5E KeyConnect-Style Shielded Modular Jacks	
Color-coded Icon Kit	
Red	AX104632-RD
Green	AX104632-GN
White	AX104632-EW
Orange	AX104632-OR
Blue	AX104632-BL
Black	AX104632-BK
Yellow	AX104632-YE
Purple	AX104632-PR
CAT5E KeyConnect Modular Jack	
CAT5E Shielded KeyConnect Modular Jack, Metallic	AX104595

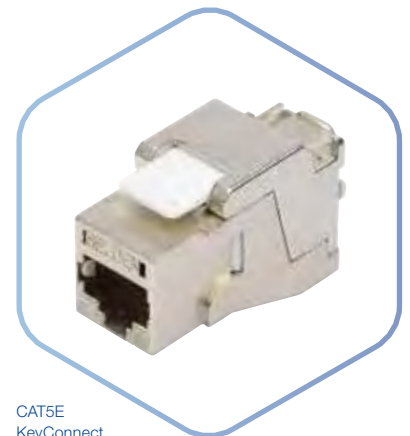

CAT5E
KeyConnect
Shielded Modular Jack

1200 STP System Connectivity

CAT5E Shielded Modular Cords, Patch Cords and Pigtails

The CAT5E Shielded Modular Cords are 4-pair 24 AWG F/UTP modular cords designed to be used within the Belden 1200 Shielded System. These modular cords offer the best combination of transmission performance and shielding integrity.

- Exceeds TIA transmission and mechanical performance requirements
- Excellent shielding integrity per TIA-607-B
- Made with small diameter for greater flexibility and higher density installations
- Solid conductors 24 AWG improve attenuation and are needed in long patch cords and pigtails to eliminate the need for cable de-rating in open-office cabling
- Improved strain relief and a flexible boot for optimum protection in high-density installations
- Wrap-around label on each cord for easier product identification and length sorting



CAT5E
Shielded
Modular Cord

Our End-to-End Expertise.
Your End-to-End Solution.



STP Modular Patch Cords

Performance	Cable Type	Termination	Color	Length (meter)	
CAT6+ (CAT6/5E) = C6	LSZH CAT5E = F4 Patch cord	T568A/B – T568A/B = 1	Red = 02	0.5 m = 0D5M	
		Crossover T568A/B = 4	Orange = 03	1.0 m = 001M	
		Crossover IEEE = 5	Yellow = 04	2.0 m = 002M	
	Pigtails			Green = 05	3.0 m = 003M
	LSZH Pigtail = B4	T568A – Open = 2	Blue = 06	5.0 m = 005M	
		T568B – Open = 3	Purple = 07	10.0 m = 010M	
			Grey = 08		
			White = 09		
			Black = 00		

Example Partnumber: **C6F4106003M**

- C6 = CAT6/STP
- F4 = LSZH
- 1 = T568A/B
- 06 = Blue
- 003M = 3 meter patch cord

BELDEN

SENDING ALL THE RIGHT SIGNALS



Our End-to-End Expertise.
Your End-to-End Solution.



Workstation

Section Table of Contents

■ Workstation	
Workstation	59-65
KeyConnect Square Faceplate	60-61
KeyConnect Boxes	62
KeyConnect-Style UTP and STP Modular Jacks, Multimedia Modules	62-64
RJ45 Plug Kits and Accessories	65



Workstation

KeyConnect Square Faceplate

Belden's new faceplate (86x86) range to complete IBDN® workstations quickly and efficiently, with the added benefit of installation flexibility, and uniform aesthetics.

Plenty of Choice for Maximum Flexibility

- The Belden faceplate range offers a choice of five faceplates, and two styles.
- The Faceplates are capable of accepting CAT5E, CAT6+ and CAT6A type of modular jack, in Keystone style.
- These new faceplates can be either wall-mounted on an appropriate wall back box or underfloor mounted in floor faceplates and are available in Electric White color.

Durability and Reliability

- All Belden faceplates are designed to provide maximum durability, protection and reliable performance.
- They feature a sturdy design for impact resistance, made from the best quality ABS.
- They include a shutter to protect modules from dust and debris and provide optimum performance, density and durability, while inserts and adapters are easily released for further configurations.
- Label windows are situated at the top part of the faceplates, so that the cords do not block the labels.
- This facilitates easy identification, avoiding labels at the bottom where they could not easily be seen after installation.

Our End-to-End Expertise.
Your End-to-End Solution.



Description	Part Number
KeyConnect Square Faceplate	
One Piece Faceplate/Electric White	
KeyConnect Single Port Faceplate 86 x 86 x 10	AX104441
KeyConnect Double Port Faceplate 86 x 86 x 10	AX104442
KeyConnect Quad Port Faceplate 86 x 86 x 10	AX104444
KeyConnect Tilted Single Faceplate 86 x 86 x 25.6	AX104447
KeyConnect Tilted Double Faceplate 86 x 86 x 25.6	AX104448
Premium Two Piece Faceplate/Almond	
KeyConnect Single Port Faceplate 86 x 86 x 14.4	AX104441C
KeyConnect Double Port Faceplate 86 x 86 x 14.4	AX104442C
KeyConnect Tilted Single Faceplate 86 x 86 x 37.7	AX104447C
KeyConnect Tilted Double Faceplate 86 x 86 x 37.7	AX104448C
KeyConnect Tilted Single Faceplate – Fiber 86 x 86 x 37.7	AX104447F
KeyConnect Tilted Double Faceplate – Fiber 86 x 86 x 37.7	AX104448F

KeyConnect Tamper Resistant Faceplates

Faceplate Kit, KeyConnect-Style/White	
4-port, single-gang with locking cover patch cord seal and wall gasket (dust and water resistant)	AX104687
4-port, single-gang with locking cover (secure outlet)	AX104688
Secure screw driver bit (Drilled Spanner 1/4")	AX104689

Description	Part Number		
	White	Black	Gray
KeyConnect Faceplates and Inserts			
6c Faceplates			
Single Gang, Single Aperture	NN01520	NN01532	NN01544
Single Gang, Dual Aperture	NN01521	NN01533	NN01545
Double Gang, Quad Aperture	NN01522	NN01534	NN01546
6c Inserts			
Shuttered Adapter, 1 Port Flush, KeyConnect	NN01525	NN01537	NN01549
Shuttered Adapter, 1 Port Angled, KeyConnect	NN01526	NN01538	NN01550
Blank Insert, 1 Port	NN01527	NN01539	NN01551
Euromod Faceplates			
Single Gang, 50 x 50 mm Aperture	NN01523	NN01535	NN01547
Double Gang, 50 x 100 mm Aperture	NN01524	NN01536	NN01548
Euromod Inserts			
Shuttered Adapter, 1 Port Flush, KeyConnect	NN01528	NN01540	NN01552
Shuttered Adapter, 1 Port Angled, KeyConnect	NN01529	NN01541	NN01553
Blank Insert, 12.5 x 50 mm	NN01530	NN01542	NN01554
Blank Insert, 25 x 50 mm	NN01531	NN01543	NN01555



AX104448C
KeyConnect
Tilted Double Faceplate



AX104688
KeyConnect
Tamper-Resistant Faceplate
with locking cover



6c Faceplates



AX104134
KeyConnect Side
Entry Boxes, 4-port

KeyConnect Boxes

KeyConnect Boxes in various sizes and colors provide flexible surface mount, modular furniture and standard electrical plate outlet installation, including high-density workstation outlets.

Features & Benefits

- KeyConnect Boxes available in 1, 2, 4 and 6-port configurations for design flexibility
- KeyConnect Boxes equipped with port shutters to provide dust protection to UTP jacks
- Fire-retardant plastic with UV stabilizer for protection against color degradation
- KeyConnect Adapters are compatible with all KeyConnect UTP and Multimedia Modules

Description	Part Number	
	Almond	Electr. White

KeyConnect UTP Boxes

KeyConnect Side-Entry Boxes, with Shutter Door		
1-port	AX104132	AX102651
2-port	AX104133	AX102652
4-port	AX104134	AX102653
6-port	AX104135	AX102654



RCA
Gold-plated
Couplers (AX105341-EW, AX105340-EW,
AX105339-EW, AX105337-EW, AX105338-EW)

KeyConnect-Style UTP and STP Modular Jacks

KeyConnect Multimedia Modules

- KeyConnect modular UTP, fiber and coax modules snap easily into KeyConnect Faceplates and Boxes to suit any voice, data, video or multimedia application including Belden 10GX, fiber-to-the-desk and high-definition video.
- They provide optimum performance, density and durability, and are easily removed with the release tool for reconfigurations.

Features & Benefits

- KeyConnect Modules are available in UTP, coax and fiber to suit any multimedia application and are compact in size to optimize network connectivity density
- KeyConnect Modular Jacks are available in CAT6A, CAT6+, and CAT5E to suit any network performance level
- KeyConnect LC Duplex Adapter Module (multimode) includes high-quality phosphor bronze sleeve – provides low insertion loss and excellent durability
- KeyConnect LC Duplex Adapter Module (single-mode) includes high-quality ceramic sleeve - provides precise alignment and long term durability
- All Modules can be easily snapped into faceplates and adapters or in simple sheet metal cut-outs for installation in custom-built devices

Our End-to-End Expertise.
Your End-to-End Solution.



Physical and Mechanical Characteristics

- Multimode LC module: beige and aqua adapters with phosphor bronze sleeve
- Single-mode LC module: blue adapter with ceramic sleeve
- ST Compatible MM/SM: metal adapter with ceramic sleeve
- Materials: Fire-retardant plastic UL94V-0
- Colors: Almond, electrical white and black

Packaging

- KeyConnect Modular Jacks – Individually packaged
- KeyConnect Multimedia Modules – 10 units in a clear plastic bag



Description	Part Number		
	Almond	Electr. White	Black

KeyConnect Multimedia Modules

Multimedia Modules, Copper			
3.5 mm Audio Coupler, F/F, Gold	AX105334-AL	AX105334-EW	AX105334-BK
3.5 mm Audio Coupler, F/Solder, Gold	AX105335-AL	AX105335-EW	AX105335-BK
S-video Coupler, F/F	AX105336-AL	AX105336-EW	AX105336-BK
RCA Gold-plated Coupler, F/F, Red	AX105337-AL	AX105337-EW	AX105337-BK
RCA Gold-plated Coupler, F/F, White	AX105338-AL	AX105338-EW	AX105338-BK
RCA Gold-plated Coupler, F/F, Yellow	AX105339-AL	AX105339-EW	AX105339-BK
RCA Gold-plated Coupler, F/F, Green	AX105340-AL	AX105340-EW	AX105340-BK
RCA Gold-plated Coupler, F/F, Blue	AX105341-AL	AX105341-EW	AX105341-BK
Video F Coax 3GHz, Recess, Gold-Plated	AX105346-AL	AX105346-EW	AX105346-BK
Video F Coax, Recessed	AX102903	AX102904	AX102905
Video F Coax, Flush	AX102906	AX102907	AX102908
Video BNC Coax, Flush	AX104573	AX104575	AX104574
USB 3.0 Coupler, A to A	AX105342-AL	AX105342-EW	AX105342-BK
USB 2.0 Coupler, B to B	AX105344-AL	AX105344-EW	AX105344-BK
HDMI Coupler (Version 1.4)	AX105345-AL	AX105345-EW	AX105345-BK
Multimedia Modules, Fiber			
LC Duplex OM3 (Aqua Adapter)	AX104937	AX104938	AX104939
LC Duplex OM4 (Erika Violet Adapter)	AX105641-AL	AX105641-EW	AX105641-BK
LC Duplex SM (Blue Adapter)	AX102419	AX102420	AX102421
LC Duplex SM/APC (Green Adapter)	AX105642-AL	AX105642-EW	AX105642-BK
SC Duplex OM3 (Aqua Adapter)	AX105643-AL	AX105643-EW	AX105643-BK
SC Duplex SM (Blue Adapter)	AX102686	AX102687	AX102688
SC Duplex SM/APC (Green Adapter)	AX105374-AL	AX105374-EW	AX105374-BK



AX102417
LC Duplex module



AX105342-EW
USB 3.0 Coupler
and AX105345-EW HDMI Coupler



KeyConnect
Modular Jacks



CAT6+
Shielded
KeyConnect Modular Jack

KeyConnect-Style UTP and STP Modular Jacks (continued)

Description	Part Number
KeyConnect-Style UTP RJ45 Modular Jacks	
10GX KeyConnect-Style UTP RJ45 Modular Jacks	
10GX KeyConnect-Style UTP RJ45 Modular Jacks, Electr. White	AX102282
10GX KeyConnect-Style UTP RJ45 Modular Jacks, Almond	AX102281
10GX KeyConnect-Style UTP RJ45 Modular Jacks, Black	AX102283
10GX Replacement X-Bars	
Replacement X-Bars, bag of 24 pieces	PX103838R
CAT6+ KeyConnect-Style UTP RJ45 Modular Jacks	
CAT6+ KeyConnect-Style UTP RJ45 Modular Jacks, Electr. White	AX101320
CAT6+ KeyConnect-Style UTP RJ45 Modular Jacks, Almond	AX101319
CAT6+ KeyConnect-Style UTP RJ45 Modular Jacks, Black	AX101321
CAT6+ Replacement X-Bars	
Replacement X-Bars, bag of 24 pieces	PX103356R
CAT5E KeyConnect-Style UTP RJ45 Modular Jacks	
CAT5E KeyConnect-Style UTP RJ45 Modular Jacks, Electr. White	AX101309
CAT5E KeyConnect-Style UTP RJ45 Modular Jacks, Almond	AX101308
CAT5E KeyConnect-Style UTP RJ45 Modular Jacks, Black	AX101310
CAT5E Replacement X-Bars	
Replacement X-Bars, bag of 24 pieces	PX103356R
KeyConnect-Style STP Modular Jacks	
10GX KeyConnect Modular Jack/Coupler	
10GX Shielded KeyConnect Modular Jack, Metallic	AX104562
CAT6+ KeyConnect Modular Jack	
CAT6+ Shielded KeyConnect Modular Jack, Metallic	AX104596
CAT5E KeyConnect Modular Jack	
CAT5E Shielded KeyConnect Modular Jack, Metallic	AX104595

Our End-to-End Expertise.
Your End-to-End Solution.



RJ45 Plug Kits

The Category 6A Field Mount Plugs are available in UTP and shielded and they are color-coded 568 A/B for universal wiring. They come equipped with an IDC terminated plug core that provides a quick, easy and reliable termination onto various cable sizes (small OD and large OD conductors). The new plugs are ideal for direct connections to WAP, IP Cameras and various IP devices.

- Supports the most demanding network applications
- Provides flexibility and reduces inventory
- Intermateable with all modular jacks
- Color-coded for universal wiring 568A/B
- Fully compliant with TIA-1096-A and IEC 60603-7-51



Description	Part Number
RJ45 Plug Kits	
RJ45 Plug Kits and Accessories	
CAT6A Field Mount Plug 568A/B, UTP, 27-23 AWG, Ins. 0.035–0.042 inch	CAPFMUS-S1
CAT6A Field Mount Plug 568A/B, UTP, 23-22 AWG, Ins. 0.042–0.062 inch	CAPFMUL-S1
CAT6A Field Mount Plug 568A/B, STP, 27-23 AWG, Ins. 0.035–0.042 inch	CAPFMFS-S1
CAT6A Field Mount Plug 568A/B, STP, 23-22 AWG, Ins. 0.042-0.062 inch	CAPFMFL-S1
Belden Coupler Test Adapter	AX104552



RJ45
Plug Kit, Metal



BELDEN
SENDING ALL THE RIGHT SIGNALS



Our End-to-End Expertise.
Your End-to-End Solution.



Components

Section Table of Contents

■ Components

Components	67-71
CAT6A, CAT6, CAT5E UHD-panels, HD-panels, SD-panels	68-69
CAT6A Modular Jack	68-69
CAT6+ Jacks	70-71
CAT5E Jacks	70-71



Components

CAT6A, CAT6, CAT5E UHD-panels, HD-panels, SD-panels

The KeyConnect Patch Panels are a comprehensive line of robust all-metal, preloaded and modular patch panels. The series provides a flexible, versatile and high-density termination solution for Data Center and Telecommunications Room installations.

The modular KeyConnect Patch Panels are available in 24-port/1U, 48-port/2U, 72-port/2U and 48-port/1U configurations. Belden's unique KeyConnect AngleFlex Patch Panels are also available in 24-port/1U and 48-port/2U and offer better port-density and patch cord manageability.

The Flex Patch Panel series is available in 24-port/1U and 48-port/2U configurations, and is designed to be populated using CAT6+ Modular Jacks or Multimedia Modules.

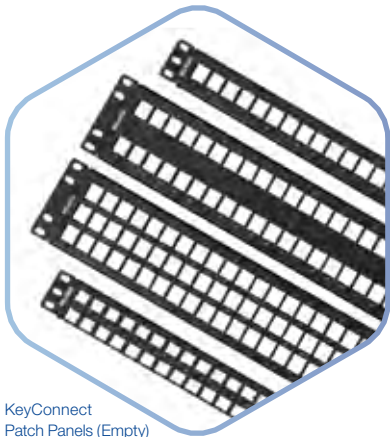

KeyConnect
Patch Panels (Empty)

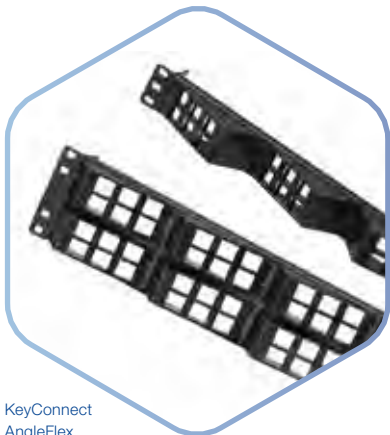

KeyConnect
AngleFlex
Patch Panels

Cat6A Modular Jack

The 10GX Module is a revolutionary punch down UTP connector designed to be used within the 10GX System. In order to achieve true 10G performance, Belden has designed the 10GX Module based on three revolutionary module technologies making the 10GX Module the most advanced 10G module available. The unmatched Beyond 10G™ performance exceeds all parameters specified in the Category 6A standard. All performance characteristics including ANEXT, NEXT, FEXT, Insertion Loss and Return Loss have been set to guarantee transmission performance up to 625 MHz.

The KeyConnect version has a keystone footprint, and is designed to be used with KeyConnect and AngleFlex Patch Panels and with KeyConnect Workstation Outlets. The modular jacks can also be mixed and matched with a wide variety of adapters and boxes to suit practically any installation configuration for workstation outlet, consolidation point and telecommunications closet applications.



AX104601
(Angled, 2U, 48-port)



AX104599
(Angled, 1U, 24-port)

Our End-to-End Expertise.
Your End-to-End Solution.



Description	Part Number
UTP Empty Patch Panels	
UHD KeyConnect Patch Panels	
10GX Flat Patch Panel, 1U, 48-port, Black	AX103121
10GX Angled Patch Panel, 1U, 48-port, Black	AX104600
10GX Flat Patch Panel, 2U, 72-port, Black	AX103116
10GX Flat Patch Panel, 3U, 96-port, Black	AX105371
10GX FrontAccess Patch Panel, 2U, 72-port, Black	AX106290
HD KeyConnect Patch Panels	
10GX Flat Patch Panel, 2U, 48-port, Black	AX103115
10GX Angled Patch Panel, 2U, 48-port, Black	AX104601
10GX AngleFlex Patch Panel, 2U, 48-port, Black	AX103249
10GX FrontAccess Patch Panel, 2U, 48-port, Black	AX106289
SD KeyConnect Patch Panels	
10GX Flat Patch Panel, 1U, 24-port, Black	AX103114
10GX Angled Patch Panel, 1U, 24-port, Black	AX104599
10GX AngleFlex Patch Panel, 1U, 24-port, Black	AX103248
10GX FrontAccess Patch Panel, 1U, 24-port, Black	AX106288
KeyConnect Front Access Patch Panel Items	
Labeling Kit (12 strips and LabelFlex sheets for 96 ports)	AX106291
Spare Bezel Kit for Front Access Patch Panel, 24-Pack	AX106292-B24
10GX KeyConnect-Style UTP RJ45 Modular Jacks	
10GX KeyConnect-Style UTP RJ45 Modular Jacks	
10GX KeyConnect-Style UTP RJ45 Modular Jacks, Gray	AX102280
10GX KeyConnect-Style UTP RJ45 Modular Jacks, Almond	AX102281
10GX KeyConnect-Style UTP RJ45 Modular Jacks, Electr. White	AX102282
10GX KeyConnect-Style UTP RJ45 Modular Jacks, Black	AX102283
10GX KeyConnect-Style UTP RJ45 Modular Jacks, Orange	AX102284
10GX KeyConnect-Style UTP RJ45 Modular Jacks, Red	AX102285
10GX KeyConnect-Style UTP RJ45 Modular Jacks, Yellow	AX102286
10GX KeyConnect-Style UTP RJ45 Modular Jacks, Green	AX102287
10GX KeyConnect-Style UTP RJ45 Modular Jacks, Blue	AX102288
10GX KeyConnect-Style UTP RJ45 Modular Jacks, Purple	AX102289
10GX KeyConnect-Style UTP RJ45 Modular Jacks, Brown	AX102290
10GX Replacement X-Bars	
Replacement X-Bars, bag of 24 pieces	PX103838R
10GX KeyConnect-Style UTP RJ45 Coupler	
10GX KeyConnect-Style UTP RJ45 Coupler	
10GX KeyConnect-Style UTP RJ45 Coupler, Orange	AX104015
10GX KeyConnect-Style UTP RJ45 Coupler, Green	AX104018
10GX KeyConnect-Style UTP RJ45 Coupler, Black	AX104024
10GX KeyConnect-Style UTP RJ45 Coupler, Red	AX104016
10GX KeyConnect-Style UTP RJ45 Coupler, Blue	AX104019
10GX KeyConnect-Style UTP RJ45 Coupler, Yellow	AX104017
10GX KeyConnect-Style UTP RJ45 Coupler, White	AX104023



AX104600
(Angled, 1U, 48-port)



KeyConnect
Modular Jacks



10GX RJ45
Coupler

CAT6+ Jacks

The CAT6+ Modular Jack is a punch down UTP connector based on a patented Encapsulated Lead Frame technology that ensures excellent long-term reliability as well as extremely stable transmission performance. The Beyond Category 6 performance exceeds all parameters specified in the Category 6 standard. All performance characteristics have been set to guarantee transmission performance up to 300 MHz and a data-rate of up to 4.8 Gb/s.

The KeyConnect version has a keystone footprint, and is designed to be used with KeyConnect and AngleFlex Patch Panels and with KeyConnect and Workstation Outlets. The modular jacks can also be mixed and matched with a wide variety of adapters and boxes to suit practically any installation configuration for workstation outlet, consolidation point and telecommunications closet applications.

The CAT6+ Shielded KeyConnect Modular Jack is a rugged tool-less connector designed to be used within the Belden 2400 Shielded System. Its 2-piece die-cast housing and its shielding lug provide a reliable shield and 360 degree durable bonding to the cable foil. Its color-coded wire guide speeds up pair placement and terminates all pairs when closing the 2-piece housing.

The excellent CAT6+ performance exceeds all parameters specified in the TIA Category 6 standard. Its performance characteristics including ANEXT, NEXT, FEXT, Insertion Loss and Return Loss have been set to guarantee transmission performance up to 250 MHz with a 10 dB margin on PSANEXT and PSAACRF. Its keystone footprint makes it compatible with KeyConnect Shielded Patch Panels and with KeyConnect and Workstation Outlets.

CAT5E Jacks

The CAT5E Modular Jack is a punch down UTP connector based on a patented Encapsulated Lead Frame technology that ensures excellent long-term reliability as well as extremely stable transmission performance. They are designed to be used within the Belden 1200 System. The CAT5E performance exceeds all parameters specified in the CAT5E standard. All performance characteristics have been set to guarantee transmission performance up to 160 MHz and a data-rate of up to 1.2 Gb/s.

The KeyConnect version has a keystone footprint, and is designed to be used with KeyConnect and AngleFlex Patch Panels and with KeyConnect and Workstation Outlets.

The modular jacks can also be mixed and matched with a wide variety of adapters and boxes to suit practically any installation configuration for workstation outlet, consolidation point and telecommunications closet applications.

The CAT5E Shielded KeyConnect Modular Jack is a rugged tool-less connector designed to be used within the Belden 1200 Shielded System. Its 2-piece die-cast housing and its shielding lug provide a reliable shield and 360 degree durable bonding to the cable foil. Its color-coded wire guide speeds up pair placement and terminates all pairs when closing the 2-piece housing.

The excellent CAT5E performance exceeds all parameters specified in the TIA Category 5e standard. Its performance characteristics including ANEXT, NEXT, FEXT, Insertion Loss and Return Loss have been set to guarantee transmission performance up to 160 MHz with a 10 dB margin on PSANEXT and PSAACRF. Its keystone footprint makes it compatible with KeyConnect Shielded Patch Panels and with KeyConnect and Workstation Outlets.

Our End-to-End Expertise.
Your End-to-End Solution.



Description	Part Number
CAT6+ KeyConnect-Style UTP RJ45 Modular Jacks	
CAT6+ KeyConnect-Style UTP RJ45 Modular Jacks	
CAT6+ KeyConnect-Style UTP RJ45 Modular Jacks, Gray	AX101318
CAT6+ KeyConnect-Style UTP RJ45 Modular Jacks, Almond	AX101319
CAT6+ KeyConnect-Style UTP RJ45 Modular Jacks, Electr. White	AX101320
CAT6+ KeyConnect-Style UTP RJ45 Modular Jacks, Black	AX101321
CAT6+ KeyConnect-Style UTP RJ45 Modular Jacks, Orange	AX101322
CAT6+ KeyConnect-Style UTP RJ45 Modular Jacks, Red	AX101323
CAT6+ KeyConnect-Style UTP RJ45 Modular Jacks, Yellow	AX101324
CAT6+ KeyConnect-Style UTP RJ45 Modular Jacks, Green	AX101325
CAT6+ KeyConnect-Style UTP RJ45 Modular Jacks, Blue	AX101326
CAT6+ KeyConnect-Style UTP RJ45 Modular Jacks, Purple	AX101327
CAT6+ KeyConnect-Style UTP RJ45 Modular Jacks, Brown	AX101328
CAT6+ Replacement X-Bars	
Replacement X-Bars, bag of 24 pieces	PX103356R



KeyConnect
Modular Jacks

CAT6+ KeyConnect-Style UTP RJ45 Coupler	
CAT6+ KeyConnect-Style UTP RJ45 Coupler	
CAT6+ KeyConnect-Style UTP RJ45 Coupler, Orange	AX104206
CAT6+ KeyConnect-Style UTP RJ45 Coupler, Green	AX104209
CAT6+ KeyConnect-Style UTP RJ45 Coupler, Black	AX104215
CAT6+ KeyConnect-Style UTP RJ45 Coupler, Red	AX104207
CAT6+ KeyConnect-Style UTP RJ45 Coupler, Blue	AX104210
CAT6+ KeyConnect-Style UTP RJ45 Coupler, Yellow	AX104208
CAT6+ KeyConnect-Style UTP RJ45 Coupler, White	AX104214

CAT5E KeyConnect-Style UTP RJ45 Modular Jacks	
CAT5E KeyConnect-Style UTP RJ45 Modular Jacks	
CAT5E KeyConnect-Style UTP RJ45 Modular Jacks, Gray	AX101307
CAT5E KeyConnect-Style UTP RJ45 Modular Jacks, Almond	AX101308
CAT5E KeyConnect-Style UTP RJ45 Modular Jacks, Electr. White	AX101309
CAT5E KeyConnect-Style UTP RJ45 Modular Jacks, Black	AX101310
CAT5E KeyConnect-Style UTP RJ45 Modular Jacks, Orange	AX101311
CAT5E KeyConnect-Style UTP RJ45 Modular Jacks, Red	AX101312
CAT5E KeyConnect-Style UTP RJ45 Modular Jacks, Yellow	AX101313
CAT5E KeyConnect-Style UTP RJ45 Modular Jacks, Green	AX101314
CAT5E KeyConnect-Style UTP RJ45 Modular Jacks, Blue	AX101315
CAT5E KeyConnect-Style UTP RJ45 Modular Jacks, Purple	AX101316
CAT5E KeyConnect-Style UTP RJ45 Modular Jacks, Brown	AX101317
CAT5E Replacement X-Bars	
Replacement X-Bars, bag of 24 pieces	PX103356R



10GX RJ45
Coupler

CAT5E KeyConnect-Style UTP RJ45 Coupler	
CAT5E KeyConnect-Style UTP RJ45 Modular Jacks	
CAT5E KeyConnect-Style UTP RJ45 Coupler, Orange	AX104206
CAT5E KeyConnect-Style UTP RJ45 Coupler, Green	AX104209
CAT5E KeyConnect-Style UTP RJ45 Coupler, Black	AX104215
CAT5E KeyConnect-Style UTP RJ45 Coupler, Red	AX104207
CAT5E KeyConnect-Style UTP RJ45 Coupler, Blue	AX104210
CAT5E KeyConnect-Style UTP RJ45 Coupler, Yellow	AX104208
CAT5E KeyConnect-Style UTP RJ45 Coupler, White	AX104214

BELDEN

SENDING ALL THE RIGHT SIGNALS



Our End-to-End Expertise.
Your End-to-End Solution.



QSFP+/SFP+ Direct Attached Cables

Section Table of Contents

■ QSFP+/SFP+ Direct Attached Cables

QSFP+/SFP+ Direct Attached Cables	73–75
SFP+ Direct Attached Copper Cable Assemblies, 10 Gb/s, Passive	75
QSFP+ Direct Attached Copper Cable Assemblies, 40 Gb/s, Passive	75
QSFP+ to 4/SFP+ Breakout Direct Attached Copper CA, 4 x 10 Gb/s, Passive	75



QSFP+/SFP+ Direct Attached Cables

To meet the most stringent signal transmission performance requirements, QSFP+/SFP+ Direct Attached Cables are manufactured with Belden Lightskew Series cable that offers intra-pair delay skew as low as 15 ps/m, silver-plated conductors, aluminum/Mylar foil and tinned copper braiding, and an FT4/CL2-rated PVC jacket.

Thoroughly third-party evaluated and tested, the zinc die-cast connectors with easy pull-to-release action are compatible with virtually all QSFP+/SFP+ Direct Attach compliant devices, cages and network interface cards.

Offered in a variety of lengths and manufactured using Belden's Lightskew™ Series twinax cables, Belden QSFP+/SFP+ Direct Attached Cables provide better cable management for high-density deployments and enhanced electrical characteristics for the most reliable signal transmission.

- Easy pull-to-release latching mechanism
- Compliant with the latest SFF-8431 specifications
- Connector cage designed for high-speed differential signaling
- Supports 8x/4x/2x/1x Fibre Channel data rates for SANs and NAS
- Supports Ethernet 10 Gb/s data rates with backwards compatibility to 1 Gb/s
- Available in a Generic or CISCO compatible EEPROM



SFP+ Cable
Assembly



Our End-to-End Expertise.
Your End-to-End Solution.



Description	Part Number
QSFP+/SFP+ Direct Attached Cables	
SFP+ Direct Attached Copper Cable Assemblies, 10 Gb/s, Passive	
SFP+ 2-pairs Belden Lightskew, 30 AWG, Generic EEPROM 0.5 m	SSFPP-P00M5-1
SFP+ 2-pairs Belden Lightskew, 30 AWG, Generic EEPROM 1 m	SSFPP-P01M0-1
SFP+ 2-pairs Belden Lightskew, 30 AWG, Cisco-compatible EEPROM 1 m	SSFPP-P01M0-2
SFP+ 2-pairs Belden Lightskew, 30 AWG, Generic EEPROM 2 m	SSFPP-P02M0-1
SFP+ 2-pairs Belden Lightskew, 30 AWG, Generic EEPROM 3 m	SSFPP-P03M0-1
SFP+ 2-pairs Belden Lightskew, 30 AWG, Cisco-compatible EEPROM 3 m	SSFPP-P03M0-2
SFP+ 2-pairs Belden Lightskew, 24 AWG, Generic EEPROM 5 m	SSFPP-P05M0-1
SFP+ 2-pairs Belden Lightskew, 24 AWG, Cisco-compatible EEPROM 5 m	SSFPP-P05M0-2
SFP+ 2-pairs Belden Lightskew, 24 AWG, Generic EEPROM 7 m	SSFPP-P07M0-1
QSFP+ Direct Attached Copper Cable Assemblies, 40 Gb/s, Passive	
SFP+ 8-pairs Belden Lightskew, 30 AWG, Generic EEPROM 0.5 m	QSSFP-P00M5-1
SFP+ 8-pairs Belden Lightskew, 30 AWG, Generic EEPROM 1 m	QSSFP-P01M0-1
SFP+ 8-pairs Belden Lightskew, 30 AWG, Cisco-compatible EEPROM 1 m	QSSFP-P01M0-2
SFP+ 8-pairs Belden Lightskew, 30 AWG, Generic EEPROM 2 m	QSSFP-P02M0-1
SFP+ 8-pairs Belden Lightskew, 30 AWG, Generic EEPROM 3 m	QSSFP-P03M0-1
SFP+ 8-pairs Belden Lightskew, 30 AWG, Cisco-compatible EEPROM 3 m	QSSFP-P03M0-2
SFP+ 8-pairs Belden Lightskew, 24 AWG, Generic EEPROM 5 m	QSSFP-P05M0-1
SFP+ 8-pairs Belden Lightskew, 24 AWG, Cisco-compatible EEPROM 5 m	QSSFP-P05M0-2
QSFP+ to 4/SFP+ Breakout Direct Attached Copper CA, 4 x 10 Gb/s, Passive	
4 x SFP+ 8-pairs Belden Lightskew, 30 AWG, Generic EEPROM 0.5 m	QSSFP-P00M5-1
4 x SFP+ 8-pairs Belden Lightskew, 30 AWG, Generic EEPROM 1 m	QSSFP-P01M0-1
4 x SFP+ 8-pairs Belden Lightskew, 30 AWG, Cisco-compatible EEPROM 1 m	QSSFP-P01M0-2
4 x SFP+ 8-pairs Belden Lightskew, 30 AWG, Generic EEPROM 2 m	QSSFP-P02M0-1
4 x SFP+ 8-pairs Belden Lightskew, 30 AWG, Generic EEPROM 3 m	QSSFP-P03M0-1
4 x SFP+ 8-pairs Belden Lightskew, 30 AWG, Cisco-compatible EEPROM 3 m	QSSFP-P03M0-2
QSFP+ 8-pairs "Octopus" Belden Lightskew, 26 AWG, Generic EEPROM	QSSFP-P05M0-1
QSFP+ 8-pairs "Octopus" Belden Lightskew, 26 AWG, Cisco-comp. EEPROM	QSSFP-P05M0-2

BELDEN

SENDING ALL THE RIGHT SIGNALS



Our End-to-End Expertise.
Your End-to-End Solution.



Warranties

Section Table of Contents

■ Warranties	
Belden 10GX System Certified Installations	78–79
Belden 2400 System Certified Installations	80–81
Belden 1200 System Certified Installations	82–83

Belden 10GX System Certified Installations

Performance & Warranties Profile for Belden 10 Gigabit System 10GX Certified System Installations

Belden will provide its authorized PartnerAlliance installers, for the benefit of their end users, with both an extended Belden Component Warranty and a lifetime Application Assurance Program for all Belden Certified Systems installed by the certified PartnerAlliance installer.

The extended Belden Component Warranty and the lifetime Application Assurance Program are offered to the certified PartnerAlliance installer by Belden, Inc., in accordance with the following terms and conditions.

This Warranty and this Assurance Program apply only to Belden Certified Systems installed by the certified PartnerAlliance installer in compliance with the PartnerAlliance Agreement.

A Belden Certified System is a structured cabling system that has been engineered, designed and installed by the certified Belden PartnerAlliance installer. The engineering, design and installation of the Belden System must be performed in accordance with all applicable Belden guidelines, practices, and other Belden documentation in effect at the time of installation. Belden structured cabling installations that meet these requirements will receive a Certification Registration Number and Certification Plaque or Certificate from Belden and will then be designated as a Belden Certified System, eligible for the extended Belden Component Warranty and lifetime Application Assurance Program described below.

In order to maintain the validity of the extended Belden Component Warranty and the lifetime Application Assurance Program, the Belden Certified System must be maintained in accordance with the Belden User Manual in effect at the time of installation.

Extended Belden Component Warranty:

Belden warrants that;

- 1) the Belden passive components installed in the Belden Certified System are covered by a manufacturer's warranty against defects in material and workmanship for a period of twenty-five (25) years from the date of installation, at the original installation location.
- 2) the Belden Certified System will meet or exceed the UTP channel transmission requirements specified by:
ANSI/TIA 568-C.2, Category 6A
ISO/IEC 11801 (edition 2.1) 2008, Class EA

Once an installed Belden passive component has been deemed defective by Belden, Belden shall repair or replace, at Belden's discretion, the defective component. Belden may use refurbished materials in either repair or replacement procedures, and the repaired or replaced component will be warranted for the balance of the original twentyfive year warranty period, or, ninety (90) days, whichever is longer.

The repair or replacement of a defective component under this warranty includes the reasonable costs of labor required to repair or replace the defective component. The decision of repair or

replacement of components, and the selection of labor services to perform the repair or replacement are at the sole discretion of Belden, Inc.

Application Assurance:

In addition to the extended Belden Component Warranty, Belden also provides a lifetime Application Assurance Program for all Belden Certified Systems.

Belden's lifetime Application Assurance Program warrants that the Belden Certified System will be capable of supporting all industry standard Applications during its entire installation life at its original installation location.

Industry standard Applications include;

- 1) all Category 5, Category 5e and Category 6 Applications identified in the current (at time of installation) Belden documentation, and;
- 2) any Category 5, Category 5e, Category 6 and Category 6A Applications introduced at a future date by recognized standards bodies and user forums that use ANSI/TIA 568-C.0, ANSI/TIA 568-C.1, ANSI/TIA 568-C.2 and ISO/IEC 11801 Class EA channel specifications for cabling.

In the event that the Belden Certified System is unable to support an existing or future industry standard Application as defined above, and such failure can be attributed to a deficiency in the Belden System, Belden will provide at, its expense, reasonable expertise, Belden materials and labor as required to remedy the problem and/or resolve the claim. The decision of repair or replacement of materials, and the selection of labor services to perform the remedial services are at the sole discretion of Belden, Inc.

Limitations

Belden, Inc. will not be liable for, nor pay for, any loss of use of the Belden System or products; costs of substitute goods, facilities or services; or for any other economic losses or incidental, consequential or exemplary damages.

This Extended Product Warranty and Application Assurance for the Belden Certified System does not cover any deficiencies in the System which result from failure to comply with Belden design guidelines and installation procedures as well as ANSI/NECA/BICSI 568-2006, Standard for Installing Commercial Building Telecommunications Cabling.

The following plugs are not covered by this warranty:

- | | |
|---------------|---------------|
| 1. C6PFCU-B24 | 3. C5PFCF-B25 |
| 2. CAPFCU-B25 | 4. CAPFCF-B25 |

Belden, Inc. shall not be liable for damages or defects resulting from circumstances beyond its control, including but not limited to, misuse, alteration, unauthorized repair, damages in transit, fire, floods and acts of God. Repair or replacement of the Belden Certified System by Belden, Inc. is your exclusive remedy.

This is the only warranty on the Belden Certified System. There are no other warranties, express or implied, made by Belden, Inc.

Belden 2400 System Certified Installations

Performance & Warranties Profile for Belden 2400 System Certified Installations

Belden will provide its authorized PartnerAlliance installers, for the benefit of their end users, with both an extended Belden Component Warranty and a lifetime Application Assurance Program for all Belden Certified Systems installed by the certified PartnerAlliance installer.

The extended Belden Component Warranty and the lifetime Application Assurance Program are offered to the certified PartnerAlliance installer by Belden, Inc., in accordance with the following terms and conditions.

This Warranty and this Assurance Program apply only to Belden Certified Systems installed by the certified PartnerAlliance installer in compliance with the PartnerAlliance Agreement.

A Belden Certified System is a structured cabling system that has been engineered, designed and installed by the certified Belden PartnerAlliance installer. The engineering, design and installation of the Belden System must be performed in accordance with all applicable Belden guidelines, practices, and other Belden documentation in effect at the time of installation. Belden structured cabling installations that meet these requirements will receive a Certification Registration Number and Certification Plaque or Certificate from Belden and will then be designated as a Belden Certified System, eligible for the extended Belden Component Warranty and lifetime Application Assurance Program described below.

In order to maintain the validity of the extended Belden Component Warranty and the lifetime Application Assurance Program, the Belden Certified System must be maintained in accordance with the Belden User Manual in effect at the time of installation.

Extended Belden Component Warranty:

Belden warrants that;

- 1) the Belden passive components installed in the Belden Certified System are covered by a manufacturer's warranty against defects in material and workmanship for a period of twenty-five (25) years from the date of installation, at the original installation location.
- 2) the Belden Certified System will meet or exceed the UTP channel transmission requirements specified by:
ANSI/TIA 568-C.2, Category 6
ISO/IEC 11801 (edition 2.1) 2008, Class EA

Once an installed Belden passive component has been deemed defective by Belden, Belden shall repair or replace, at Belden's discretion, the defective component. Belden may use refurbished materials in either repair or replacement procedures, and the repaired or replaced component will be warranted for the balance of the original twentyfive year warranty period, or, ninety (90) days, whichever is longer.

The repair or replacement of a defective component under this warranty includes the reasonable costs of labor required to repair or replace the defective component. The decision of repair or

replacement of components, and the selection of labor services to perform the repair or replacement are at the sole discretion of Belden, Inc.

Application Assurance:

In addition to the extended Belden Component Warranty, Belden also provides a lifetime Application Assurance Program for all Belden Certified Systems.

Belden's lifetime Application Assurance Program warrants that the Belden Certified System will be capable of supporting all industry standard Applications during its entire installation life at its original installation location.

Industry standard Applications include;

- 1) all Category 5, Category 5e and Category 6 Applications identified in the current (at time of installation) Belden documentation, and;
- 2) any Category 5, Category 5e and Category 6 Applications introduced at a future date by recognized standards bodies and user forums that use ANSI/TIA 568-C.0, ANSI/TIA 568-C.1, ANSI/TIA 568-C.2 and ISO/IEC 11801 Class EA channel specifications for cabling.

In the event that the Belden Certified System is unable to support an existing or future industry standard Application as defined above, and such failure can be attributed to a deficiency in the Belden System, Belden will provide at, its expense, reasonable expertise, Belden materials and labor as required to remedy the problem and/or resolve the claim. The decision of repair or replacement of materials, and the selection of labor services to perform the remedial services are at the sole discretion of Belden, Inc.

Limitations

Belden, Inc. will not be liable for, nor pay for, any loss of use of the Belden System or products; costs of substitute goods, facilities or services; or for any other economic losses or incidental, consequential or exemplary damages.

This Extended Product Warranty and Application Assurance for the Belden Certified System does not cover any deficiencies in the System which result from failure to comply with Belden design guidelines and installation procedures as well as ANSI/NECA/BICSI 568-2006, Standard for Installing Commercial Building Telecommunications Cabling.

The following plugs are not covered by this warranty:

- | | |
|---------------|---------------|
| 1. C6PFCU-B24 | 3. C5PFCF-B25 |
| 2. CAPFCU-B25 | 4. CAPFCF-B25 |

Belden, Inc. shall not be liable for damages or defects resulting from circumstances beyond its control, including but not limited to, misuse, alteration, unauthorized repair, damages in transit, fire, floods and acts of God. Repair or replacement of the Belden Certified System by Belden, Inc. is your exclusive remedy.

This is the only warranty on the Belden Certified System. There are no other warranties, express or implied, made by Belden, Inc.

Our End-to-End Expertise.
Your End-to-End Solution.



Belden 2400 System Cabling Solution

In addition to the extended Belden Component Warranty and lifetime Application Assurance Program described above, Belden System 2400 Certified Systems that conform with the Belden System 2400 Channel Configuration are guaranteed to meet or exceed the following performance parameters for the duration of their installed lifetime at the original site of installation. All conditions regarding original design, installation and maintenance for Belden Certified Systems must be met in order to validate these performance parameter guarantees.

Belden 2400 System Performance	
Bandwidth	250 MHz
Data Rate Capacity	2.4 Gb/s

Belden 2400 System Channel Configuration

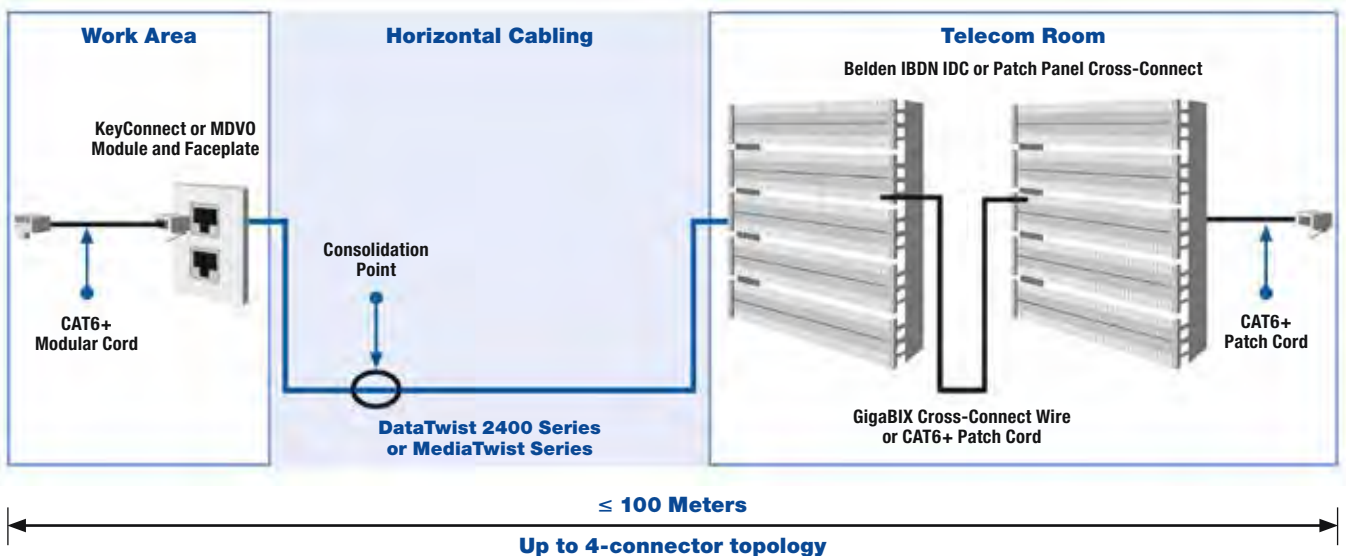

Belden 2400 System Matrix

Work Area		Consolidation Point		Horizontal Cable	Telecom Room			
Connectivity	Workstation Outlets	Connectivity	Workstation Outlets	Cable	Connectivity	Workstation Outlets		
CAT6+ KeyConnect Modular Jacks	KeyConnect Faceplates and Accessories	CAT6+ Patch Panels	KeyConnect Modular Patch Panels	2400 DataTwist UTP System Cable MediaTwist 1872/1874 Cable CAT6+ Pre-Term Cable Assemblies	CAT6+ Patch Panels	KeyConnect Modular Patch Panels		
	KeyConnect Adapters and Boxes		AngleFlex Patch Panels			AngleFlex Patch Panels		
CAT6+ KeyConnect Couplers	MediaFlex Outlet System	CAT6+ KeyConnect Modular Jacks	Multi-User Outlet Box			CAT6+ KeyConnect Modular Jacks	KeyConnect Couplers	KeyConnect Couplers
	Multi-User Outlet Box	CAT6+ KeyConnect Couplers				CAT6+ KeyConnect Couplers		
CAT6+ Modular Jacks (MDVO-Style)	Interface Plates	CAT6+ Modular Jacks (MDVO-Style)	Flex Modular Patch Panels (MDVO-Style)		CAT6+ Modular Jacks (MDVO-Style)	Flex Modular Patch Panels (MDVO-Style)		
	MDVO Adapter and Boxes Multimedia Outlet Box	CAT6+ Pigtails			CAT6+ Pigtails			
CAT6+ Patch Cords		CAT6+ Patch Cords			CAT6+ Patch Cords			
		GigaBIX IDC System			GigaBIX IDC System			

Green = KeyConnect Connectivity components and compatible workstation outlets
Blue = MDVO Connectivity components and compatible workstation outlets
Red = Universal cable and connectivity components

Belden 1200 System Certified Installations

Performance & Warranties Profile for Belden IBDN Gigabit System 1200 Certified System Installations

Belden will provide its authorized Certified System Vendors (CSVs), for the benefit of their end users, with both an extended Belden IBDN Component Warranty and a lifetime Application Assurance Program for all Belden IBDN Certified Systems installed by the CSV.

The extended Belden IBDN Component Warranty and the lifetime Application Assurance Program are offered to the CSV by Belden, Inc., in accordance with the following terms and conditions. This Warranty and this Assurance Program apply only to Belden IBDN Certified Systems installed by CSV acting as an authorized Certified System Vendor (CSV) and in compliance with the CSV Agreement.

A Belden IBDN Certified System is a structured cabling system that has been engineered, designed and installed by the CSV acting as an authorized Belden CSV. The engineering, design and installation of the Belden IBDN System must be performed in accordance with all applicable Belden IBDN guidelines, Belden IBDN practices, and other Belden IBDN documentation in effect at the time of installation. Belden IBDN structured cabling installations that meet these requirements will receive a Certification Registration Number and Certification Plaque or Certificate from Belden and will then be designated as a Belden IBDN Certified System, eligible for the extended Belden IBDN Component Warranty and lifetime Application Assurance Program described below.

In order to maintain the validity of the extended Belden IBDN Component Warranty and the lifetime Application Assurance Program, the Belden IBDN Certified System must be maintained in accordance with the Belden IBDN User Manual in effect at the time of installation.

Extended Belden IBDN Component Warranty:

Belden warrants that;

- 1) the Belden IBDN passive components installed in the Belden IBDN Certified System are covered by a manufacturer's warranty against defects in material and workmanship for a period of twenty-five (25) years from the date of installation, at the original installation location.
- 2) the Belden IBDN Certified System will meet or exceed the UTP channel transmission requirements specified by:
ANSI/TIA/EIA 568-B.1, Category 5e
ISO/IEC FDIS 11801:2002, Class D

Once an installed Belden IBDN passive component has been deemed defective by Belden, Belden shall repair or replace, at Belden's discretion, the defective component. The repaired or replaced component will be warranted for the balance of the original twenty-five year warranty period, or, ninety (90) days, whichever is longer.

The repair or replacement of a defective component under this warranty includes the reasonable costs of labor required to repair

or replace the defective component. The decision of repair or replacement of components, and the selection of labor services to perform the repair or replacement are at the sole discretion of Belden, Inc.

Application Assurance:

In addition to the extended Belden IBDN Component Warranty, Belden also provides a lifetime Application Assurance Program for all Belden IBDN Certified Systems.

Belden's lifetime Application Assurance Program warrants that the Belden IBDN Certified System will be capable of supporting all industry standard Category 5e Applications during its entire installation life at its original installation location.

Industry standard Category 5e Applications include;

- 1) all Category 5 and Category 5e applications identified in the current (at time of installation) Belden IBDN documentation, and;
- 2) any Category 5 or Category 5e application introduced at a future date by recognized standards bodies and user forums that use the ANSI/TIA/EIA 568-B.1, Category 5e and ISO/IEC FDIS 11801:2002, Class D component and link/channel specifications for cabling.

In the event that the Belden IBDN Certified System is unable to support an existing or future Category 5 or Category 5e Application as defined above, and such failure can be attributed to a deficiency in the Belden IBDN System, Belden will provide at, its expense, reasonable expertise, Belden IBDN materials and labor as required to remedy the problem and/or resolve the claim. The decision of repair or replacement of materials, and the selection of labor services to perform the remedial services are at the sole discretion of Belden, Inc.

Limitations

Belden, Inc. will not be liable for, nor pay for, any loss of use of the Belden IBDN System or products; costs of substitute goods, facilities or services; or for any other economic losses or incidental, consequential or exemplary damages.

This Extended Product Warranty and Application Assurance for the Belden IBDN Certified System does not cover any deficiencies in the System which result from failure to comply with Belden design guidelines and installation procedures.

Belden, Inc. shall not be liable for damages or defects resulting from circumstances beyond its control, including but not limited to, misuse, alteration, unauthorized repair, damages in transit, fire, floods and acts of God.

Repair or replacement of the Belden IBDN Certified System by Belden, Inc. is your exclusive remedy.

This is the only warranty on the Belden IBDN Certified System. There are no other warranties, express or implied, made by Belden, Inc.

Our End-to-End Expertise.
Your End-to-End Solution.



Belden IBDN System 1200 Gigabit Cabling Solution

In addition to the extended Belden IBDN Component Warranty and lifetime Application Assurance Program described above, Belden IBDN System 1200 Certified Systems installations that conform with the Belden IBDN System 1200 Channel Configuration are guaranteed to meet or exceed the following performance parameters for the duration of their installed lifetime at the original site of installation. All conditions regarding original design, installation and maintenance for Belden IBDN Certified Systems must be met in order to validate these performance parameter guarantees.

Belden IBDN System 1200 Performance Parameters	
Bandwidth	160 MHz
Data Rate Capacity	1.2 Gb/s

Belden IBDN Gigabit System 1200 Channel Configuration

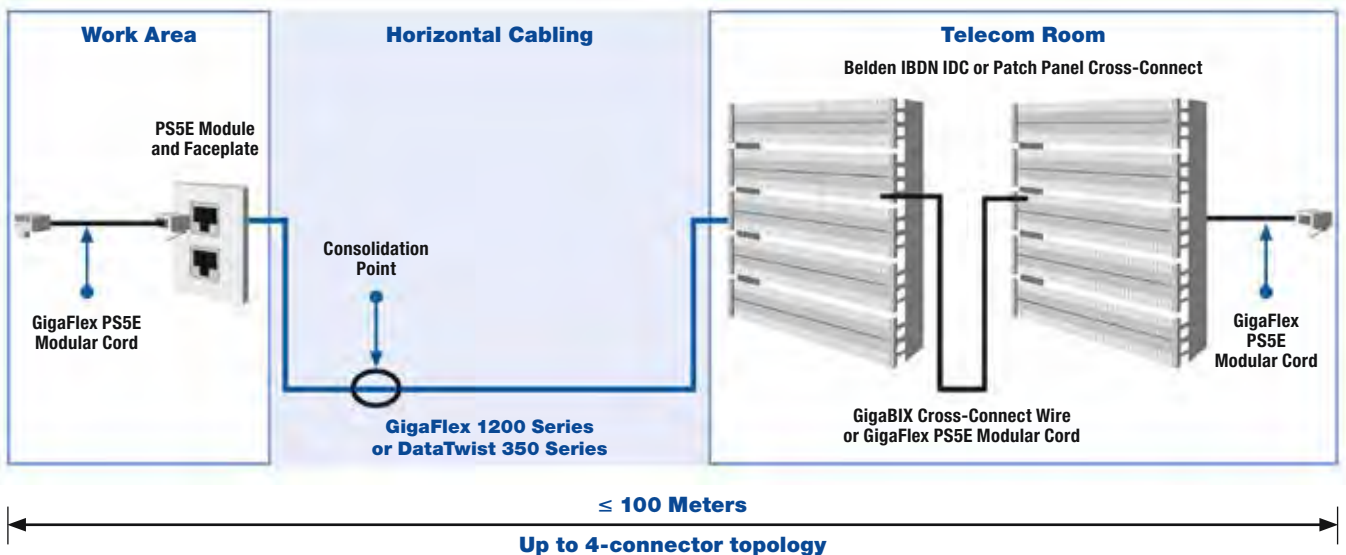

Belden IBDN Gigabit System 1200 Matrix

Work Area		Consolidation Point		Horizontal Cable	Telecom Room	
Outlets (Connectors – Faceplates & Adapters)	Modular Cords	Consolidation Point Connecting Hardware	Component between the Consolidation Point and the Work Area Outlets		Cross-Connect or Interconnect Hardware	Cross-Connect or Interconnect Patch System
EZ-MDVO PS5E Module	GigaFlex PS5E Modular Cord	BIX IDC Connector 110 IDC Connecting block GigaBix IDC Connector	DataTwist 350 1700 (CMR) DataTwist 350 1701 (CMP) DataTwist 350 1701 (CMP-50) GigaFlex 1212 (CMR) GigaFlex 1213 (CMP) GigaFlex 1224 (LSZH)	DataTwist 350 1700 (CMR) DataTwist 350 1701 (CMP) DataTwist 350 1701 (CMP-50) GigaFlex 1212 (CMR) GigaFlex 1213 (CMP) GigaFlex 1224 (LSZH)	GigaBIX Cross-Connect System	GigaBIX Cross-Connect Wire GigaBix PS5E Patch cords
GigaFlex PS5E Module		PS5E BIX Patch Panel PS5E HD-BIX Patch Panel Flex Patch Panel/ EZ-MDVO PS5E Modules	GigaFlex PS5E Single Ended Modular Cord		PS5E BIX Patch Panel PS5E HD-BIX Patch Panel Flex Patch Panel/ EZ-MDVO PS5E Modules	GigaFlex PS5E Modular Cord
MDVO Faceplates Interface Plates		Flex Patch Panel/ GigaFlex PS5E Modules			Flex Patch Panel/ GigaFlex PS5E Modules	
European Style Faceplates French Style Faceplates					HD-110 Patch Panel	
MDVO Adapters MediaFlex Outlets		HD-110 Patch Panel	GigaFlex PS5E Single Ended Modular Cord		110 Cross-Connect System	PS5E 110 Patch Cords

GigaFlex PS5E Modules are not available in all markets.



Our End-to-End Expertise.
Your End-to-End Solution.



Miscellaneous

Section Table of Contents

■ Miscellaneous	
RJ45 Plug Kits and Accessories	86
Voice Panel	86-87
Outside Plant Cable Nonbonded-Pair	86-87
Backdoor Indoor Cable	86-87

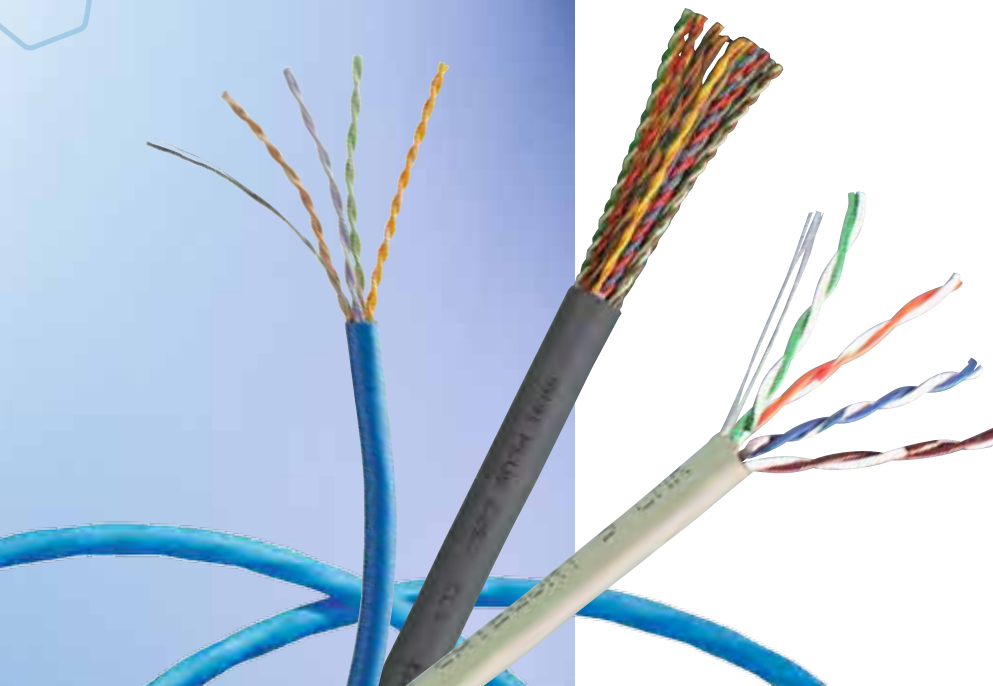

Miscellaneous

RJ45 Plug Kits and Accessories

Belden offers a series of RJ45 CAT6+/6A and CAT5E Modular Plugs as an accessible, easy-to-use solution to terminate twisted pair and cable for security, audio/video and broadcast applications where field installation is necessary. Belden modular plugs are designed for Belden category cable to optimize performance quality.

Description	Part Number
RJ45 Plug Kits	
RJ45 Plug Kits and Accessories	
Category 6/Category 6A RJ45 Plugs, UTP, 25 per kit	CAPFCU-B25
Category 5e/Category 6 RJ45 Plugs, UTP, 25 per kit	C6PFCU-B25
Category 6/Category 6A RJ45 Plugs, F/UTP, 25 per kit	CAPFCF-B25
Category 5e RJ45 Plugs, F/UTP, 25 per kit	C5PFCF-B25
Flexible Boots for 6 mm OD, 100 per pack	CB6MMBK-B100
Flexible Boots for 7 mm OD, 100 per pack	CB7MMBK-B100
Flexible Boots for 8 mm OD, 100 per pack	CB8MMBK-B100
RJ45 Termination Crimp Tool	CTPFC01

Voice Panel

The 50-ports telepanel is supplied in an easy and functional design with fixed cable guide prepared for use of Velcro tape or strips. All jacks are mounted as RJ45, enabling the use of general patch cables. The panel is available in white and black color with numbering from 1 to 50. Mounting is carried out by means of a "KRONE" tool.

Voice Panel

CAT3 Voice Panel	
50-port Voice Panel, CAT3	E1005460



Outside Plant Cable Nonbonded-Pair

DataTwist Category 6 and 5e Outside Plant (OSP) cables are 4-pair products and are 100% gel-filled with a non-sticky PP compound that is easy to remove when terminating. Each product also has a thick polyethylene jacket for better moisture and cut through resistance. DataTwist OSP products exceed Category 6 or Category 5e requirements as per ANSI/TIA/EIA-568-C.2.

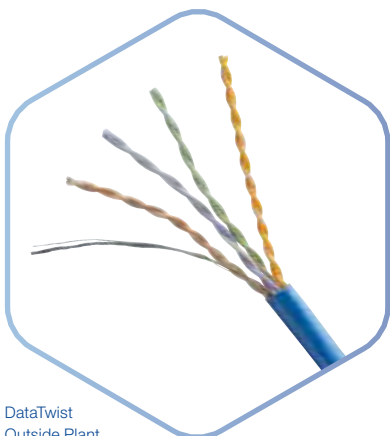

DataTwist
Outside Plant,
Gel-filled

Backdoor Indoor Cable

Available in plenum and non-plenum versions, 25-pair Cat 5e backbone cables are designed for high-speed applications. These cables meet and exceed the Category 5e transmission characteristics including the Power Sum Near End Crosstalk (NEXT) requirements of ANSI/TIA/EIA-568-C.2 Standard for Commercial Building Telecommunications Wiring.

DataTwist® 3 Cable is a high value UTP cable engineered specifically to perform to Category 3 requirements per ANSI/TIA/EIA-568-C.2. DataTwist 3, D-Inside Wire, D-Flex Plenum and the ATMM Cable Series are rugged multi-pair cable series that meet and exceed ANSI/TIA/EIA-568-C.2 and CSA T529-95 specifications for Category 3 transmission characteristics and are perfect for use in networking and communication systems.

Our End-to-End Expertise.
Your End-to-End Solution.



Description	Part Number
Outside Plant Cable	
DataTwist 6A OSP, 4-pair, 24 AWG, Category 6A	
DataTwist 6A OSP cable, 305 m (1000 ft) spool, Black	OSP6AU 0101000
DataTwist 6 OSP, 4-pair, 24 AWG, Category 6	
DataTwist 6 OSP cable, 305 m (1000 ft) spool, Black	OSP6U 0101000
DataTwist 6 OSP, 4-pair, 23 AWG, CMR/CMX Category 6	
DataTwist 6 OSP cable, 305 m (1000 ft) spool, Black	2148A 0101000
DataTwist 6 OSP/Indoor, CM-LS, 4-pair, 23 AWG, Category 6	
DataTwist 6 OSP/Indoor cable, 305 m (1000 ft) spool, Black	2143A 0101000
Backbone Indoor Cable	
Backbone Indoor Cable, Category 5E	
25-pair, 24 AWG, CMR, 305 m (1000 ft) spool, Blue	IBDN25R 0061000
25-pair, 24 AWG, CMR, 305 m (1000 ft) spool, Gray	IBDN25R 0081000
25-pair, 24 AWG, CMP, 305 m (1000 ft) spool, Gray	IBDN25P 0081000
Backbone Indoor Cable, Category 3	
2-pair, 24 AWG, CMR, 305 m (1000 ft) UnReel Box, Gray	1227A1 008U1000
4-pair, 24 AWG, CMR, 305 m (1000 ft) UnReel Box, Gray	1229A1 008U1000
25-pair, 24 AWG, CMR, 305 m (1000 ft) UnReel Box, Gray	1232A1 0081000
2-pair, 24 AWG, CMP, 305 m (1000 ft) UnReel Box, White	1243A2 009U1000
25-pair, 24 AWG, LSNH, 1000 m, Gray	NN00097 001000
25-pair, 24 AWG, LSNH, 305 m, Gray	NN00097 00305
100-pair, 24 AWG, LSNH, 1000 m, Gray	NN00101 001000
100-pair, 24 AWG, LSNH, 500 m, Gray	NN00101 00500
D-Inside Wire, 24 AWG, CMR, Category 3	
2-pair, 24 AWG, CMR, 762 m (2500 ft), Lt. Olive Gray, 45 boxes/pallet	DIW2 732U2500
3-pair, 24 AWG, CMR, 457 m (1500 ft), Lt. Olive Gray, 45 boxes/pallet	DIW3 732U1500
4-pair, 24 AWG, CMR, 457 m (1500 ft), Lt. Olive Gray, 45 boxes/pallet	DIW4 732U1500
6-pair, 24 AWG, CMR, 305 m (1000 ft), Lt. Olive Gray, 36 spool/pallet	DIW6 7321000
12-pair, 24 AWG, CMR, 305 m (1000 ft), Lt. Olive Gray, 27 spool/pallet	DIW12 7321000
25-pair, 24 AWG, CMR, 305 m (1000 ft), Lt. Olive Gray, 10 spool/pallet	DIW25 7321000
50-pair, 24 AWG, CMR, 305 m (1000 ft), Lt. Olive Gray, 4 spool/pallet	DIW50 7321000
100-pair, 24 AWG, CMR, Cut to any Length Spool, Lt. Olive Gray	DIW100 732CUT
200-pair, 24 AWG, CMR, Cut to any Length Spool, Lt. Olive Gray	DIW200 732CUT
300-pair, 24 AWG, CMR, Cut to any Length Spool, Lt. Olive Gray	DIW300 732CUT
D-Inside Wire, 24 AWG, CMP, Category 3	
3-pair, 24 AWG, CMP, 457 m (1500 ft), Lt. Olive Gray, 45 boxes/pallet	DFLEX3 732U1500
4-pair, 24 AWG, CMP, 457 m (1500 ft), Lt. Olive Gray, 45 boxes/pallet	DFLEX4 732U1500
25-pair, 24 AWG, CMR, 305 m (1000 ft), Lt. Olive Gray, 10 spool/pallet	DPLN25 7321000
50-pair, 24 AWG, CMR, Cut to any Length Spool, Lt. Olive Gray	DPLN50 732CUT
100-pair, 24 AWG, CMR, Cut to any Length Spool, Lt. Olive Gray	DPLN100 732CUT
200-pair, 24 AWG, CMR, Cut to any Length Spool, Lt. Olive Gray	DPLN200 732CUT
300-pair, 24 AWG, CMR, Cut to any Length Spool, Lt. Olive Gray	DPLN300 732CUT
ATMM/ARMM, Armored, 24 AWG, CMR, Category 3	
20-pair, 24 AWG, CMR, Cut to any Length Spool, Gray	ATMM25 008CUT
50-pair, 24 AWG, CMR, Cut to any Length Spool, Gray	ATMM50 008CUT
100-pair, 24 AWG, CMR, Cut to any Length Spool, Gray	ATMM100 008CUT
200-pair, 24 AWG, CMR, Cut to any Length Spool, Gray	ATMM200 008CUT
300-pair, 24 AWG, CMR, Cut to any Length Spool, Gray	ATMM300 008CUT
400-pair, 24 AWG, CMR, Cut to any Length Spool, Gray	ATMM400 008CUT

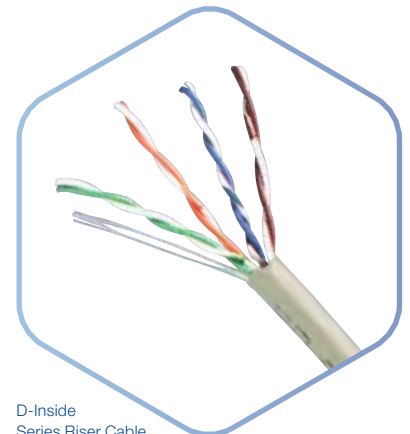

D-Inside Series Riser Cable



IBDN25R, 25-pair CAT5e Cable

GLOBAL LOCATIONS

For more information, please visit us at:
www.beldensolutions.com



**Be certain
you stay
in touch.**

EUROPE/MIDDLE EAST/AFRICA

Germany

Phone: +49-7127-14-0
venlo.salesinfo@belden.com

France

Phone: +33-472-109-990
lyon.salesinfo@belden.com

Italy

Phone: +39-039-5965-250
info.milano@belden.com

Russia

Phone: +7-495-787-06-55
info@belden.ru

Spain

Phone: +34-91-746-17-30
madrid.salesinfo@belden.com

Sweden

Phone: +46-40-699-88-60
venlo.salesinfo@belden.com

The Netherlands

Phone: +31-773-878-555
venlo.salesinfo@belden.com

United Arab Emirates

Phone: +971-4-391-0490
dubai.salesinfo@belden.com

United Kingdom

Phone: +44-161-49837-49
manchester.salesinfo@belden.com

AMERICAS

USA

Phone: +1-800-BELDEN1
(1-800-235-3361)

ASIA/PACIFIC

Singapore

Phone: +65-6879-9800
apac.ecsmarketing@belden.com

China

Phone: +86-21-5445-2388
apac.ecsmarketing@belden.com

IBDN is a registered trademark of Nordx/CDT which was acquired by Belden on February 2, 1996. Belden, Belden Sending All The Right Signals, GarrettCom, Hirschmann, Lumberg Automation, Tofino Security, Tripwire and the Belden logo are trademarks or registered trademarks of Belden Inc. or its affiliated companies in the United States and other jurisdictions. Belden and other parties may also have trademark rights in other terms used herein.