

Don't let a fuzzy signal cloud your message

Whether you're starting a new project or retrofitting legacy systems, Tripp Lite Display Solutions deliver superior signal quality for all display, distributed video and digital signage applications.

- Deliver high-resolution video over long distances while the source remains hidden and secure.
- Reduce costs by using nonproprietary solutions to make use of existing skills and equipment.
- Benefit from the experience, expertise and backing of a KVM, cables and connectivity market leader.

Choose the ideal display technology for your application:

Direct-Connect Cables connect computers and other audiovisual sources directly to displays and projectors.



VGA p. 3, Audio/Video p. 8, DVI p. 11, HDMI p. 16, DisplayPort p. 22

Easy Pull Cables include detachable connectors and integrated pull rings for long cable runs through conduit and other tight spaces.

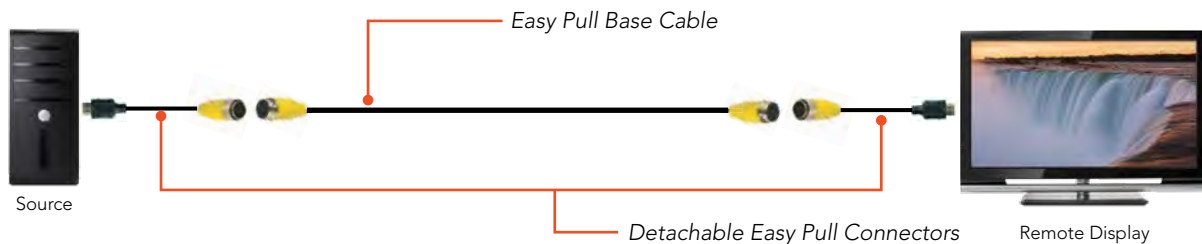

VGA p. 5, Audio/Video p. 8, DVI p. 13, HDMI p. 19

Over Cat5 Solutions offer the longest cable runs, support the most connected displays and use convenient, cost-effective Cat5/5e/6/6a (UTP) cabling.

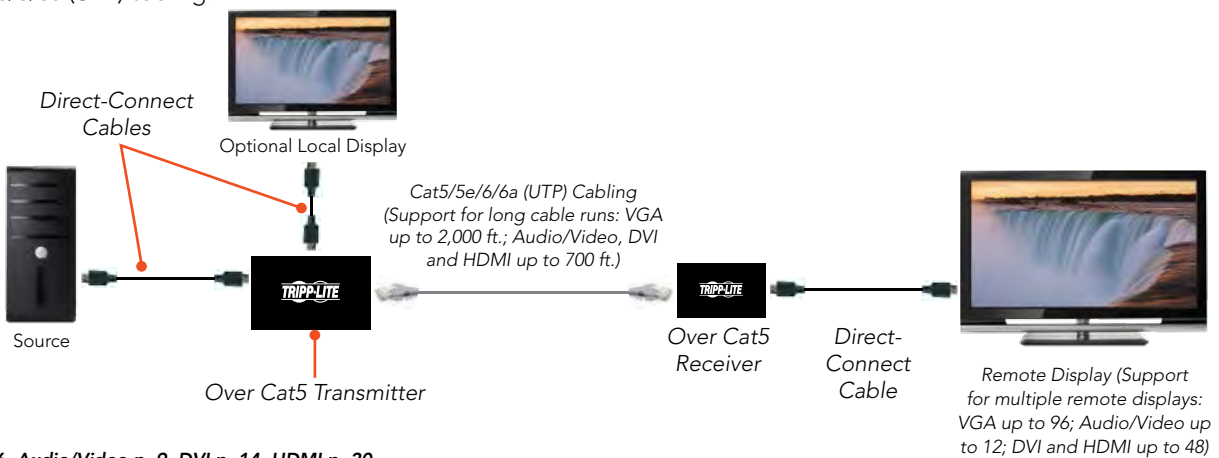

VGA p. 6, Audio/Video p. 9, DVI p. 14, HDMI p. 20

Deliver superior signal quality to displays in every venue:

Retail Locations • Restaurants • Bars • Classrooms • Houses of Worship • Office Buildings • Convention Centers • Big-Box Stores • Theaters
Hotels & Resorts • Auditoriums, Arenas & Stadiums • Distance-Learning Centers • Transportation Hubs • Schools & Libraries • Supermarkets
Cafeterias • Meeting Facilities • Public Buildings • Hospitals & Clinics • Athletic Facilities • Long-Term Care Facilities • Museums & Galleries
Fitness Centers • Factories • Laboratories • Vocational Schools • Health Clubs • Computer & Multimedia Labs • Colleges & Universities
Amusement Parks • Home Theaters • Correctional Facilities • Financial Institutions • Warehouses • Recording & Broadcast Studios
Airplanes, Trains & Buses • Casinos & Racetracks • Cruise Ships • Residential Buildings

Direct-Connect VGA Cables

- Foil and braid shielding for maximum EMI/RFI protection
- Mini-coax (RGB) and paired video wire construction for superior signal quality
- Resolutions up to 2048 x 1536 (QXGA)
- Lifetime product warranty



P502-xxx Series

VGA Display Cables with RGB Coax

- Connect a computer and display directly
- Standard and plenum-rated cables up to 100 ft.

VGA Display Cables (HD15 M/M)	
P502-001	1 ft. VGA Display Cable
P502-003	3 ft. VGA Display Cable
P502-006	6 ft. VGA Display Cable
P502-010	10 ft. VGA Display Cable
P502-015	15 ft. VGA Display Cable
P502-020	20 ft. VGA Display Cable
P502-025	25 ft. VGA Display Cable
P502-030	30 ft. VGA Display Cable
P502-035	35 ft. VGA Display Cable
P502-050	50 ft. VGA Display Cable
P502-075	75 ft. VGA Display Cable
P502-100	100 ft. VGA Display Cable
VGA Display Cables with Right-Angle Connectors (HD15 M/M)	
P502-003-RA	3 ft. VGA Display Cable (Right-Angle Connector)
P502-006-RA	6 ft. VGA Display Cable (Right-Angle Connector)
P502-010-RA	10 ft. VGA Display Cable (Right-Angle Connector)
P502-025-RA	25 ft. VGA Display Cable (Right-Angle Connector)
VGA Display Cables with Low-Profile Connectors (HD15 M/M)	
P502-003-SM	3 ft. VGA Display Cable (Low-Profile Connectors)
P502-006-SM	6 ft. VGA Display Cable (Low-Profile Connectors)
Plenum-Rated VGA Display Cables (HD15 M/M)	
P502-025-P	25 ft. Plenum-Rated VGA Display Cable
P502-050-P	50 ft. Plenum-Rated VGA Display Cable
VGA + Audio Cables (HD15 + 3.5 mm M/M)	
P504-006	6 ft. VGA Display + Stereo Audio Cable
P504-010	10 ft. VGA Display + Stereo Audio Cable
P504-015	15 ft. VGA Display + Stereo Audio Cable
P504-025	25 ft. VGA Display + Stereo Audio Cable
P504-030	30 ft. VGA Display + Stereo Audio Cable
P504-050	50 ft. VGA Display + Stereo Audio Cable
VGA + Audio Cables with Low-Profile Connectors (HD15 + 3.5 mm M/M)	
P504-003-SM	3 ft. VGA Display + Stereo Audio Cable (Low-Profile Connectors)
P504-006-SM	6 ft. VGA Display + Stereo Audio Cable (Low-Profile Connectors)
Plenum-Rated VGA + Audio Cables (HD15 + 3.5 mm M/M)	
P504-025-P	25 ft. Plenum-Rated VGA Display + Stereo Audio Cable



P502-xxx-SM Series



P504-xxx-SM Series



P502-xxx-RA Series

VGA Extension Cables with RGB Coax

- Extend the length of an existing display cable
- Standard and plenum-rated cables up to 100 ft.

VGA Display Extension Cables (HD15 M/F)	
P500-006	6 ft. VGA Display Extension Cable
P500-010	10 ft. VGA Display Extension Cable
P500-025	25 ft. VGA Display Extension Cable
P500-050	50 ft. VGA Display Extension Cable
P500-075	75 ft. VGA Display Extension Cable
P500-100	100 ft. VGA Display Extension Cable
Plenum-Rated VGA Display Extension Cable (HD15 M/F)	
P500-100-P	100 ft. Plenum-Rated VGA Display Extension Cable



P504-xxx Series

VGA Adapters & Splitters

- Accommodate a variety of applications
- Premium construction and shielding
- Lifetime product warranty

VGA Adapters

- Connect a VGA display or source to a dissimilar display or source



U244-001-VGA-R (front and back)

VGA Adapters	
P120-000	DVI Analog Source to VGA Cable Adapter (DVI-A M / HD15 F)
P120-001-2	1 ft. DVI Analog Source to VGA Cable Splitter (DVI-A M / HD15 2F)
P126-000	VGA Source to DVI Analog Cable Adapter (HD15 M / DVI-I F)
P134-06N-VGA	6 in. DisplayPort Source to VGA Cable Adapter (DP M / HD15 F)
P137-06N-VGA	6 in. Mini-DisplayPort Source to VGA Cable Adapter (mDP M / HD15 F)
P556-003	3 ft. DVI Analog Source to VGA Display Cable (DVI-A M / HD15 M)
P556-006	6 ft. DVI Analog Source to VGA Display Cable (DVI-A M / HD15 M)
P556-010	10 ft. DVI Analog Source to VGA Display Cable (DVI-A M / HD15 M)
P574-001	1 ft. DMS-59 Source to VGA Cable Splitter (DMS-59 M / HD15 2F)
P586-006-VGA	6 ft. Mini-DisplayPort Source to VGA Cable (mDP M / HD15 M)
U244-001-VGA-R	USB 2.0 Source to VGA Cable Adapter (USB-A M / HD15 F) ⁽¹⁾



P134-06N-VGA

VGA Gender Changers

- Convert a female VGA connector to male or vice-versa

VGA Gender Changers	
P158-000	VGA Gender Changer (HD15 M/M)
P160-000	VGA Gender Changer (HD15 F/F)

VGA Splitters

- Split a VGA signal for distribution to multiple displays

VGA Splitters	
B114-002-R	2-Port 350 Mhz VGA Splitter (HD15 M/2F) ⁽¹⁾
B114-004-R	4-Port 350 Mhz VGA Splitter (HD15 M/4F) ⁽¹⁾
P516-001-HR	1 ft. High-Resolution VGA Splitter Cable (HD15 M/2F)
P564-06N-DV	6 in. DVI to DVI+VGA Y Splitter Cable (DVI-I M to DVI-D F and HD15 F)

(1) 1-year product warranty.



P137-06N-VGA



B114-004-R (front and back)



P556-006

Go to www.tripplite.com for the latest specifications and ordering information

Easy Pull VGA Cables

- Detachable, screw-on connectors
- End caps with integrated pull rings
- Great for conduit and other tight spaces
- Premium construction and shielding
- Lifetime product warranty



EZA-xxx Series Base Cable and EZA-VGAM-2 Connector Kit

Easy Pull Base Cables (Type A)

- Require Easy Pull Type A connectors

Easy Pull Type A Base Cables

EZA-035	35 ft. Easy Pull Base Cable
EZA-050	50 ft. Easy Pull Base Cable
EZA-100	100 ft. Easy Pull Base Cable

Plenum-Rated Easy Pull Type A Base Cables

EZA-035-P	35 ft. Plenum-Rated Easy Pull Base Cable
EZA-050-P	50 ft. Plenum-Rated Easy Pull Base Cable
EZA-100-P	100 ft. Plenum-Rated Easy Pull Base Cable

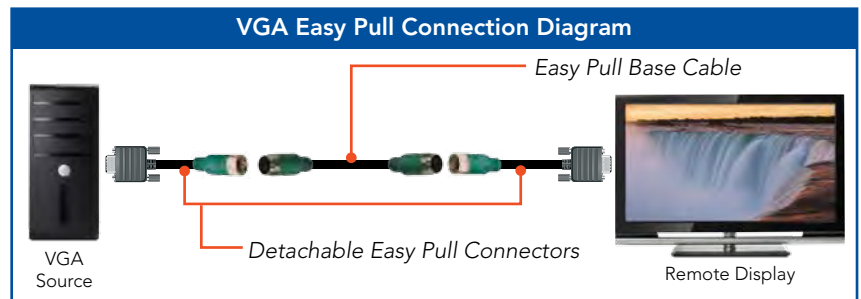

Easy Pull VGA Connector Kits (Type A)

- Include two connectors, with or without wall plates
- Require Easy Pull Type A base cable

Easy Pull Type A Connectors (VGA)

EZA-VGAM-2	2 Easy Pull VGA Connectors (HD15 M, HD15 M)
EZA-VGAF-2	2 Easy Pull VGA Connectors (HD15 F, HD15 F) ⁽¹⁾
EZA-VGAX-2	2 Easy Pull VGA Connectors (HD15 M, HD15 F) ⁽²⁾

Easy Pull Type A Connectors (VGA + Audio)

EZA-VGAAM-2	2 Easy Pull VGA + Audio Connectors (HD15 + 3.5 mm M, HD15 + 3.5 mm M)
EZA-VGAAF-2	2 Easy Pull VGA + Audio Connectors (HD15 + 3.5 mm F, HD15 + 3.5 mm F) ⁽¹⁾
EZA-VGAAX-2	2 Easy Pull VGA + Audio Connectors (HD15 + 3.5 mm M, HD15 + 3.5 mm F) ⁽²⁾

Easy Pull Type A Connectors (VGA + Audio + Composite Video)

EZA-VGACSAM-2	2 Easy Pull VGA + Audio + Composite Video Connectors (HD15 + 3.5 mm + 3 RCA M, HD15 + 3.5 mm + 3 RCA M)
EZA-VGACSAF-2	2 Easy Pull VGA + Audio + Composite Video Connectors (HD15 + 3.5 mm + 3 RCA F, HD15 + 3.5 mm + 3 RCA F) ⁽¹⁾
EZA-VGACSAX-2	2 Easy Pull VGA + Audio + Composite Video Connectors (HD15 + 3.5 mm + 3 RCA M, HD15 + 3.5 mm + 3 RCA F) ⁽²⁾



EZA-VGACSAX-2

Easy Pull VGA All-in-One Kits

- Cables up to 100 ft. with connectors included

Easy Pull VGA All-in-One Kits (Include Cable and Connectors)

P501-050	50 ft. Easy Pull VGA Extension Cable (HD15 M/F) ⁽²⁾
P501-100	100 ft. Easy Pull VGA Extension Cable (HD15 M/F) ⁽²⁾
P503-050	50 ft. Easy Pull VGA Display Cable (HD15 M/M)
P503-100	100 ft. Easy Pull VGA Display Cable (HD15 M/M)

Easy Pull VGA + Audio All-in-One Kits (Include Cable and Connectors)

P504-050-EZ	50 ft. Easy Pull VGA + Audio Cable (HD15 + 3.5 mm M/M)
P504-100-EZ	100 ft. Easy Pull VGA + Audio Cable (HD15 + 3.5 mm M/M)

(1) Includes two wall plates. (2) Includes one wall plate for the female connector(s).



P504-xxx-EZ Series

VGA Over Cat5 (UTP) Extenders

- Extend VGA signals up to 2,000 ft. over cost-effective Cat5 (UTP) cabling⁽¹⁾
- Support resolutions up to 1920 x 1440⁽²⁾
- Connect up to 97 displays (1 local, 96 remote) to a single source⁽³⁾
- Also extend audio or serial signals
- EDID copy feature ensures display compatibility

EXTEND YOUR VGA SIGNAL VIA CAT5

VGA over Cat5 extenders transmit a VGA video signal to one or more remote displays using Cat5 (UTP) cabling. Select models can also transmit audio or serial signals.

PROVIDE A VARIETY OF OPTIONS

Each installation requires at least one transmitter and one receiver or repeater. You can select the required units separately or select a kit that bundles them. You can also choose between box-style and wall-plate-style units.

CONNECT MULTIPLE DISPLAYS

If you need to connect multiple remote displays to a single source, 2-port and 4-port transmitters send the VGA signal to multiple connection ports. You can daisy-chain up to six 4-port transmitters to expand the number of connection ports. (A receiver or repeater is required for each remote display.)

You can also connect multiple remote displays by daisy-chaining repeaters with additional units. (You can daisy-chain up to three repeaters and one receiver to each transmitter connection port.) Daisy-chaining repeaters also extends the maximum cabling distance up to an additional 1,000 ft. (2,000 ft. in total).⁽⁴⁾

AVOID DISPLAY COMPATIBILITY ISSUES

Compatibility issues can occur when EDID information is not properly communicated between the source and the display. Select models include an EDID copy feature which stores a monitor's EDID information in the transmitter and sends it to the source, ensuring optimal display compatibility.



B132-004A 4-Port Transmitter (front and back)



B130-101A-2 Transmitter and Receiver Kit (front and back)

Box-Style Unit



B132-110 Repeater (front and back)

(1) Supported UTP cabling includes Cat 5/5e/6/6a. Transmitters support up to 1,000 ft. distance from the source to the receiver or first repeater. Repeaters support up to an additional 1,000 ft. distance from the first repeater to the last repeater or receiver. For best performance with long cable runs, use 24 AWG solid-wire cabling. For best performance with cable runs over 500 ft., use zero-skew 24 AWG solid-wire cabling. See p. 23 for more information about display-optimized Cat5 (UTP) cabling. **(2)** Maximum resolution is 1920 x 1440 (60 Hz); maximum resolution at 1,000 ft. is 1024 x 768 (60 Hz). For best performance, use 24 AWG solid-wire cabling. See p. 23 for more information about display-optimized Cat5 (UTP) cabling. **(3)** A single 4-port transmitter supports up to 1 local and 4 remote displays. Up to 6 units can be daisy-chained to support an additional 4 remote displays per unit, up to 1 local and 24 remote displays. By connecting the remote displays through daisy-chained repeaters, the installation can be expanded to a maximum of 1 local and 96 remote displays. **(4)** Up to 4 repeaters can be daisy-chained together. (A receiver can be placed at the end of the chain, as long as further expansion is not required.) The maximum distance between the first and last unit in the chain is 1,000 ft. For superior performance with long cable runs, use 24 AWG solid-wire cabling. For best performance with cable runs over 500 ft., use zero-skew 24 AWG solid-wire cabling. See p. 23 for more information about display-optimized Cat5 (UTP) cabling.

See p. 23 for display-optimized Cat5 (UTP) cabling

VGA Over Cat5 (UTP) Selection Chart (Transmitters, Receivers, Repeaters and Kits)

Application	Model	Kit	Product Includes:			Form Factor:		EDID Copy	Connects to:
			Transmitter	Receiver	Repeater	Box	Wall Plate		
VGA Only									
Extend signal to one display (can also add a local display)	A B130-101-2	✓	✓ (1-port)	✓		✓		✓	I
	B B130-101-U ⁽¹⁾	✓	✓ (1-port)	✓		✓			
	C B130-101-WP-1	✓	✓ (1-port)	✓			✓		I
	D B130-111	✓	✓ (1-port)		✓	✓			G H I
Extend signal to multiple displays (B132-004-2 can also add a local display)	E B132-002-2		✓ (2-port)			✓		✓	G H I
	F B132-004-2 ⁽²⁾		✓ (4-port)			✓		✓	G H I
	G B132-100-1			✓		✓			D E F I
	H B132-100-WP-1			✓			✓		D E F I
Add a remote display to an existing installation	I B132-110				✓	✓			A C D E F G H I
VGA with Audio									
Extend signal to one display (can also add a local display and speakers)	J B130-101A-2	✓	✓ (1-port)	✓		✓		✓	Q
	K B130-101A-WP-1	✓	✓ (1-port)	✓			✓		Q
	L B130-111A	✓	✓ (1-port)		✓	✓			O P Q
Extend signal to multiple displays (B132-004A-2 can also add a local display and speakers)	M B132-002A-2		✓ (2-port)			✓		✓	O P Q
	N B132-004A-2 ⁽²⁾		✓ (4-port)			✓		✓	O P Q
	O B132-100A			✓		✓			L M N Q
	P B132-100A-WP-1			✓			✓		L M N Q
Add a remote display to an existing installation	Q B132-110A				✓	✓			J K L M N O P Q
VGA with Serial									
Extend signal to one display (can also add a local display)	R B130-101S	✓	✓ (1-port)	✓		✓			
	S B130-101S-WP	✓	✓ (1-port)	✓			✓		

All models require Cat5/5e/6/6a (UTP) cabling, sold separately. All receivers and repeaters include equalization and gain adjustment controls. **(1)** Powered by USB connection at transmitter. Maximum distance is 500 ft. Does not support local display connection. **(2)** Up to three 4-port transmitters can be mounted in an optional 1U Rack Bracket (**B132-004-RB**). Up to six 4-port transmitters can be daisy-chained together to expand the number of displays connected to a single source.

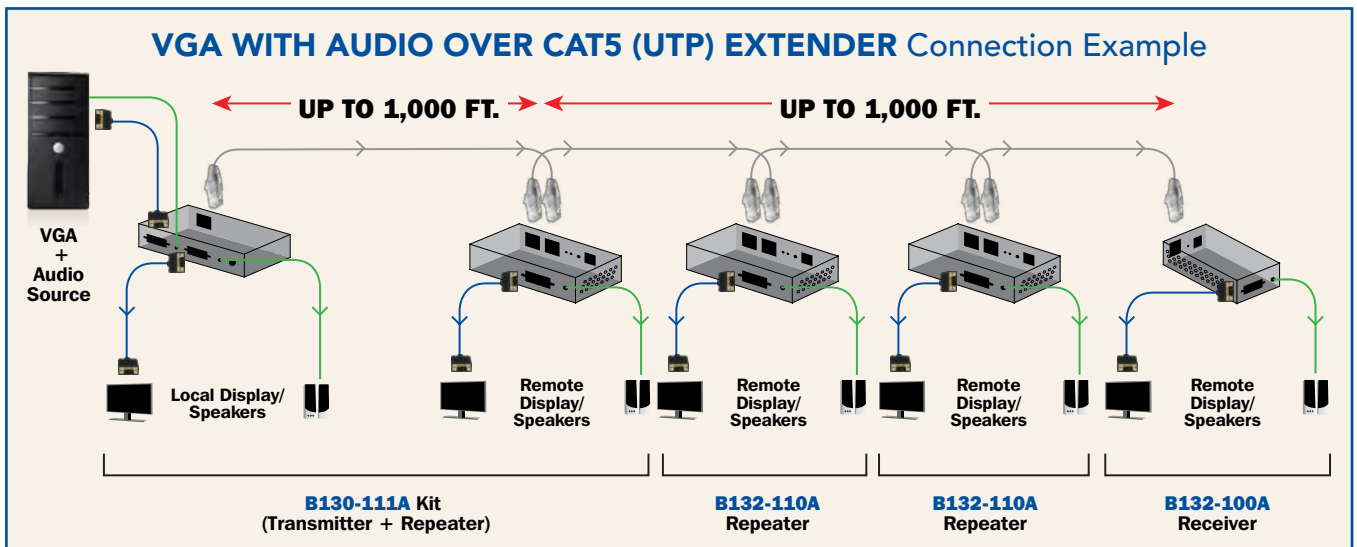

Direct-Connect Audio/Video Cables

- Foil and braid shielding for maximum EMI/RFI protection
- High-purity copper coax
- Lifetime product warranty



Direct-Connect Video Cables

Composite Video Cables (Yellow RCA M/M)

A004-006	6 ft. Composite Video Cable
A004-012	12 ft. Composite Video Cable

Component Video Cable (Red/Green/Blue RCA M/M)

A008-006	6 ft. Component Video Cable
-----------------	-----------------------------

S-Video Cables (S-Video M/M)

A012-006	6 ft. S-Video Cable
A012-012	12 ft. S-Video Cable

RG59 Coaxial Cables ("F" Connector M/M)

A200-006	6 ft. RG59 Coaxial Cable
A200-012	12 ft. RG59 Coaxial Cable
A200-025	25 ft. RG59 Coaxial Cable

Direct-Connect Audio Cables

Stereo Audio Cables (Red/White RCA M/M)

A050-006	6 ft. Stereo Audio Cable
A050-012	12 ft. Stereo Audio Cable

Mini-Stereo Audio Cables (3.5 mm M/M)

P312-006	6 ft. Mini-Stereo Audio Cable
P312-010	10 ft. Mini-Stereo Audio Cable
P312-025	25 ft. Mini-Stereo Audio Cable
P312-050	50 ft. Mini-Stereo Audio Cable

Direct-Connect Digital Audio Cables

Digital Coax Audio Cables (RCA M/M)

A060-006	6 ft. Digital Coax Audio Cable
A060-012	12 ft. Digital Coax Audio Cable

Toslink Digital Optical Audio Cables (Toslink M/M)

A102-01M	3 ft. Toslink Digital Optical Audio Cable
A102-02M	6 ft. Toslink Digital Optical Audio Cable
A102-03M	9 ft. Toslink Digital Optical Audio Cable
A102-04M	13 ft. Toslink Digital Optical Audio Cable

Easy Pull Audio/Video Cables

- Detachable, screw-on connectors; end caps with integrated pull rings
- Great for conduit and other tight spaces
- Lifetime product warranty

Easy Pull Base Cables

- Standard and plenum-rated cables up to 100 ft.

Easy Pull Type A Base Cables (Require Easy Pull Type A Connectors)

EZA-035	35 ft. Easy Pull Base Cable
EZA-050	50 ft. Easy Pull Base Cable
EZA-100	100 ft. Easy Pull Base Cable

Plenum-Rated Easy Pull Type A Base Cables (Require Easy Pull Type A Connectors)

EZA-035-P	35 ft. Plenum-Rated Easy Pull Base Cable
EZA-050-P	50 ft. Plenum-Rated Easy Pull Base Cable
EZA-100-P	100 ft. Plenum-Rated Easy Pull Base Cable

Easy Pull Video Connector Kits

- Include two connectors, with or without wall plates

Easy Pull Type A Connectors (Require Easy Pull Type A Base Cable)

EZA-VGACSAM-2	2 Easy Pull VGA + Audio + Composite Video Connectors (HD15 + 3.5 mm + 3 RCA M, HD15 + 3.5 mm + 3 RCA M)
EZA-VGACSAF-2	2 Easy Pull VGA + Audio + Composite Video Connectors (HD15 + 3.5 mm + 3 RCA F, HD15 + 3.5 mm + 3 RCA F) ⁽¹⁾
EZA-VGACSAX-2	2 Easy Pull VGA + Audio + Composite Video Connectors (HD15 + 3.5 mm + 3 RCA M, HD15 + 3.5 mm + 3 RCA F) ⁽²⁾

(1) Includes two wall plates. (2) Includes one wall plate for the female connector(s).



EZA-xxx Series Base Cable and EZA-VGACSAM-2 Connector Kit

Go to www.tripplite.com for the latest specifications and ordering information

Audio/Video Over Cat5 (UTP) Extenders

- Extend Component Video or S-Video signals with Audio up to 700 ft. over cost-effective Cat5 (UTP) cabling⁽¹⁾
- Connect up to 13 displays (1 local, 12 remote) to a single source⁽²⁾
- Support resolutions up to 1080p⁽¹⁾

EXTEND AUDIO/VIDEO SIGNALS VIA CAT5

Audio/Video over Cat5 extenders transmit analog audio and video signals to one or more remote displays using Cat5 (UTP) cabling.

PROVIDE A VARIETY OF OPTIONS

Each installation requires at least one transmitter and one receiver. You can select the required units separately or select a kit that bundles them, and you can choose between box-style and wall-plate-style units.

CONNECT MULTIPLE DISPLAYS

If you need to connect multiple remote displays to a single source, 4-port transmitters send the audio/video signal to multiple connection ports. You can daisy-chain up to three 4-port transmitters to expand the number of connection ports. (A receiver is required for each remote display.)

(continued on next page)



B136-004 4-Port Transmitter (front and back)



B136-101 Transmitter and Receiver Kit



B137-101 Transmitter and Receiver Kit

Wall-Plate-Style Unit



B136-100-WP Receiver

Box-Style Unit



B136-100 Receiver

⁽¹⁾ Supported UTP cabling includes Cat 5/5e/6/6a. Component video solutions support 1080p resolution up to 400 ft. with zero-skew cabling or up to 300 ft. with 24 AWG solid-wire cabling. Component video solutions support 480p resolution up to 700 ft. with zero-skew cabling or up to 500 ft. with 24 AWG solid-wire cabling. S-Video solutions support 480i resolution up to 700 ft. with zero-skew cabling or up to 500 ft. with 24 AWG solid-wire cabling. See p. 23 for more information about display-optimized Cat5 (UTP) cabling. ⁽²⁾ A single 4-port transmitter supports up to 1 local and 4 remote displays. Up to three units can be daisy-chained to support an additional 4 remote displays per unit, up to 1 local and 12 remote displays.

Audio/Video Over Cat5 (UTP) Selection Chart (Transmitters, Receivers and Kits)

Application	Model	Range ⁽¹⁾	Kit	Product Includes:		Form Factor:		Connects to:
				Transmitter	Receiver	Box	Wall Plate	
Component Video with Audio								
Extend signal to one display	A B136-101	700 ft.	✓	✓ (1-port)	✓	✓		
	B B136-101-WP-1	700 ft.	✓	✓ (1-port)	✓		✓	
Extend signal to multiple displays (B136-004 can also add a local display)	C B136-004⁽²⁾	700 ft.		✓ (4-port)		✓		D E
	D B136-100	700 ft.			✓	✓		C
	E B136-100-WP	700 ft.			✓		✓	C
S-Video with Audio								
Extend signal to one display	F B137-101	700 ft.	✓	✓ (1-port)	✓	✓		

All models require Cat5/5e/6/6a (UTP) cabling, sold separately. **(1)** Range and resolution may be affected by connected equipment. Supported UTP cabling includes Cat 5/5e/6/6a. Component video solutions support 1080p resolution up to 400 ft. with zero-skew cabling or up to 300 ft. with 24 AWG solid-wire cabling. Component video solutions support 480p resolution up to 700 ft. with zero-skew cabling or up to 500 ft. with 24 AWG solid-wire cabling. S-Video solutions support 480i resolution up to 700 ft. with zero-skew cabling or up to 500 ft. with 24 AWG solid-wire cabling. **(2)** Up to three 4-port transmitters can be mounted in an optional 1U Rack Bracket (**B132-004-RB**). Up to three 4-port transmitters can be daisy-chained together to expand the number of displays connected to a single source.

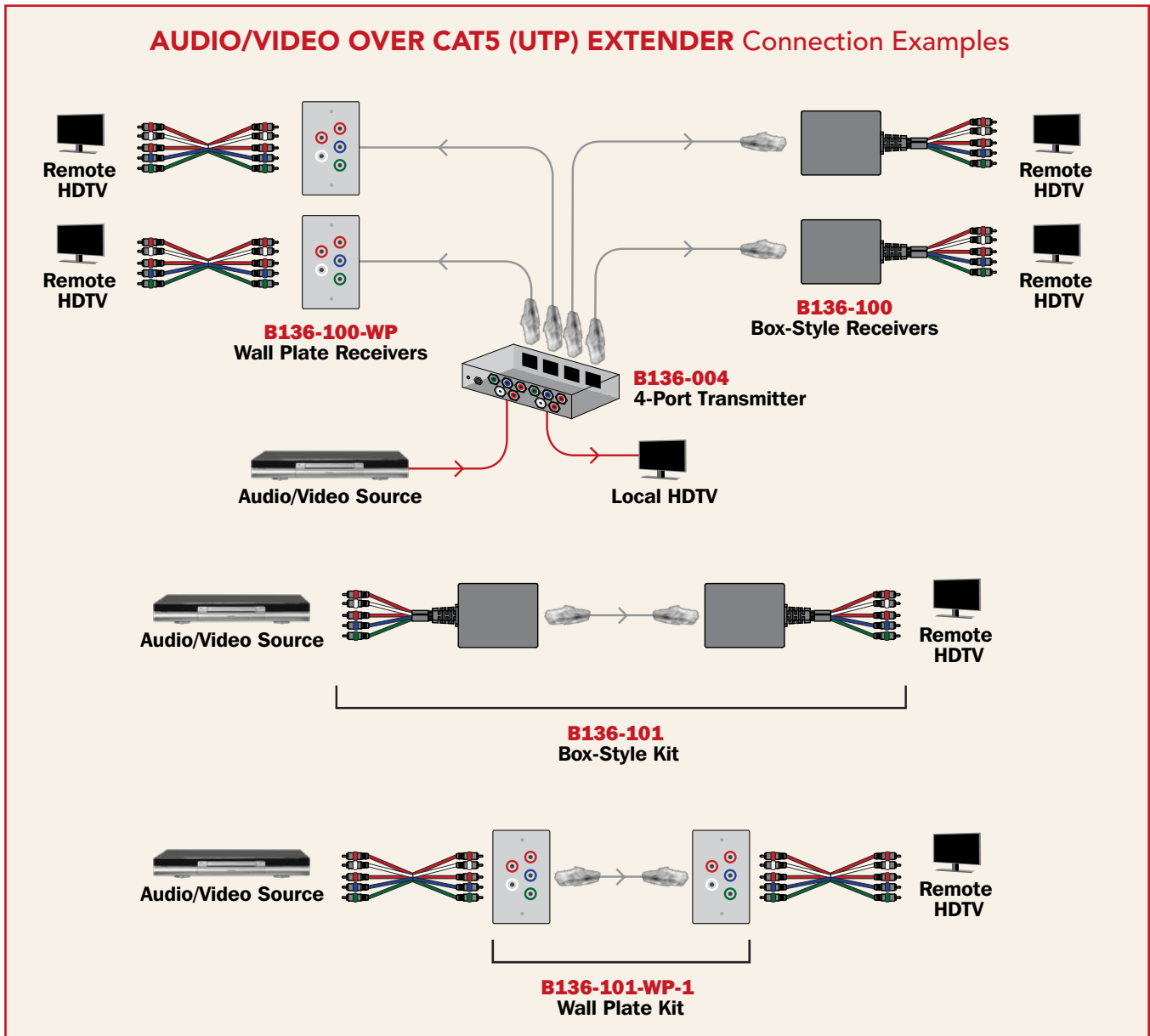

See p. 23 for display-optimized Cat5 (UTP) cabling

Direct-Connect DVI Cables

- Shielded for maximum EMI/RFI protection
- Dual-link resolutions/bandwidth up to 2560 x 1600 / 9.9 Gbps
- Single-link resolutions/bandwidth up to 1920 x 1080 / 4.95 Gbps
- Lifetime product warranty

DVI Display Cables

- Connect a computer and display directly

DVI Dual-Link Display Cables (DVI-D Dual-Link M/M)

P560-001	1 ft. DVI Dual-Link Display Cable
P560-003	3 ft. DVI Dual-Link Display Cable
P560-006	6 ft. DVI Dual-Link Display Cable
P560-010	10 ft. DVI Dual-Link Display Cable
P560-015	15 ft. DVI Dual-Link Display Cable
P560-020	20 ft. DVI Dual-Link Display Cable ⁽¹⁾
P560-025	25 ft. DVI Dual-Link Display Cable ⁽¹⁾
P560-050	50 ft. DVI Dual-Link Display Cable ⁽¹⁾
P560-100	100 ft. DVI Dual-Link Display Cable ⁽¹⁾
P560-100-HD	100 ft. DVI High-Definition Dual-Link Display Cable ⁽¹⁾

DVI Dual-Link Digital/Analog Display Cable (DVI-I Dual-Link M/M)

P560-006-DLI	6 ft. DVI Dual-Link Digital/Analog Display Cable
--------------	--

DVI Dual-Link + Stereo Audio Cables (DVI-D Dual-Link + 3.5 mm M/M)

P560-006-A	6 ft. DVI Dual-Link Display + Stereo Audio Cable
P560-010-A	10 ft. DVI Dual-Link Display + Stereo Audio Cable

DVI Dual-Link Display Extension Cables (DVI-D Dual-Link M/F)

P562-001-45L	1 ft. DVI Dual-Link Extension Cable with 45° Male Connector
P562-006	6 ft. DVI Dual-Link Extension Cable
P562-010	10 ft. DVI Dual-Link Extension Cable
P562-015	15 ft. DVI Dual-Link Extension Cable

DVI Single-Link Display Extension Cable (DVI-D Single-Link M/F)

P562-006-SL	6 ft. DVI Single-Link Extension Cable
-------------	---------------------------------------

DVI Single-Link Display Cables (DVI-D Single-Link M/M)

P561-003	3 ft. DVI Single-Link Display Cable
P561-006	6 ft. DVI Single-Link Display Cable
P561-010	10 ft. DVI Single-Link Display Cable
P561-015	15 ft. DVI Single-Link Display Cable
P561-050	50 ft. DVI Single-Link Display Cable ⁽¹⁾
P561-075	75 ft. DVI Single-Link Display Cable ⁽¹⁾
P561-100	100 ft. DVI Single-Link Display Cable ⁽¹⁾
P561-100-HD	100 ft. DVI High-Definition Single-Link Display Cable ⁽¹⁾

DVI Single-Link Digital/Analog Display Cable (DVI-I Single-Link M/M)

P561-006-SLI	6 ft. DVI Single-Link Display Cable
--------------	-------------------------------------

(1) May require a DVI signal booster (B120-000 or B120-000-SL). Check the display's specifications for maximum DVI cable length to determine whether a booster is required.



P560-xxx Series



P560-xxx-A Series



P562-001-45L



P562-006



P561-xxx Series

DVI Adapters, Splitters & Boosters

- Accommodate a variety of applications
- Boost DVI signals for long cable runs
- Premium construction and shielding
- Lifetime product warranty



U244-001-R (front and back)

DVI Adapters

- Connect a DVI display or source to a dissimilar display or source

DVI Adapters

P118-000	DVI Cable Adapter (DVI-I F / DVI-D Dual-Link M)
P120-000	DVI Analog Source to VGA Display Adapter (DVI-A M / HD15 F)
P120-001-2	1 ft. DVI Analog Source to VGA Display Splitter (DVI-A M / HD15 2F)
P122-000	DVI Source to DFP Cable Adapter (DVI-D M / DFP F)
P126-000	VGA Source to DVI Analog Display Adapter (HD15 M / DVI-I F)
P130-000	DVI Source to HDMI Cable Adapter (DVI-D Single-Link M / HDMI F)
P132-000	HDMI Source to DVI Cable Adapter (HDMI M / DVI-I F)
P132-06N-MICRO	6 in. Micro HDMI Source to DVI Cable Adapter (Micro-HDMI M to DVI-D F)
P132-08N	8 in. HDMI Source to DVI Gold Adapter (HDMI M / DVI-D F)
P134-000	6 in. DisplayPort Source to DVI Cable Adapter (DP M / DVI-I F)
P137-06N-DVI	6 in. Mini-DisplayPort Source to DVI Cable Adapter (mDP M / DVI-I F)
P138-000-DVI	8 in. Mini-DVI Source to DVI Cable Adapter (mDVI M / DVI-D Single-Link F)
P138-000-HDMI	8 in. Mini-DVI Source to HDMI Cable Adapter (mDVI M / HDMI F)
P138-000-VGA	8 in. Mini-DVI Source to VGA Cable Adapter (mDVI M / HD15 F)
P556-003	3 ft. DVI Analog Source to VGA Display Cable (DVI-A M / HD15 M)
P556-006	6 ft. DVI Source to VGA Display Cable (DVI-A M / HD15 M)
P556-010	10 ft. DVI Analog Source to VGA Display Cable (DVI-A M / HD15 M)
P566-003	3 ft. DVI to HDMI Display Cable (DVI Single-Link M / HDMI M)
P566-006	6 ft. DVI to HDMI Display Cable (DVI Single-Link M / HDMI M)
P566-010	10 ft. DVI to HDMI Display Cable (DVI Single-Link M / HDMI M)
P566-012	12 ft. DVI to HDMI Display Cable (DVI Single-Link M / HDMI M)
P566-016	16 ft. DVI to HDMI Display Cable (DVI Single-Link M / HDMI M)
P566-030	30 ft. DVI to HDMI Display Cable (DVI Single-Link M / HDMI M)
P566-050	50 ft. DVI to HDMI Display Cable (DVI Single-Link M / HDMI M)
P576-001	1 ft. DMS-59 Source to DVI Dual-Link Display Splitter (DMS-59 M / DVI-I 2F)
P581-006	6 ft. DisplayPort Source to DVI Display Cable (DP M / DVI-D Single-Link M)
P581-010	10 ft. DisplayPort Source to DVI Display Cable (DP M / DVI-D Single-Link M)
P586-006-DVI	6 ft. Mini-DisplayPort Source to DVI Display Cable (mDP M / DVI-I Single-Link M)
U244-001-R	USB 2.0 Source to DVI Single-Link or VGA (USB-A M / DVI-I F) ^(1,2)
U344-001-R	USB 3.0 Source to DVI or VGA Adapter (USB-A M / DVI-I F) ^(1,2)

DVI Gender Changer (Changes a male DVI connector to female.)

P162-000	DVI Male-to-Female Gender Changer (DVI-I F/F)
-----------------	---

DVI Splitters

- Split a DVI signal for distribution to multiple displays

DVI Splitters

B116-002A	2-Port DVI Single-Link + Stereo Audio Splitter (DVI-I + 3.5 mm F/2F) ⁽¹⁾
B116-004A	4-Port DVI Single-Link + Stereo Audio Splitter (DVI-I + 3.5 mm F/4F) ⁽¹⁾
B156-002-DVI	2-Port DisplayPort to DVI Multi-Display Splitter/Extender (DP F / DVI-I 2F) ⁽¹⁾
P564-06N-DV	6 in. DVI to DVI+VGA Y Splitter Cable (DVI-I M to DVI-D F and HD15 F)
P564-001	1 ft. DVI Y Splitter Cable (DVI-D M/2F)

DVI Signal Booster

- Boost a DVI signal for cable runs up to 150 ft.

DVI Dual-Link Signal Booster

B120-000	In-line booster with AC adapter. Supports dual-link and single-link DVI cable runs up to 150 ft. with resolutions up to 2560 x 1600. HDCP compliant. (DVI-I F/F) ^(1,3)
B120-000-SL	In-line booster with AC adapter. Supports single-link DVI up to 150 ft. with resolutions up to 1920 x 1080. HDCP compliant. (DVI-I F/F) ^(1,3)

(1) 1-year product warranty. (2) Also supports VGA displays through the included DVI to VGA adapter.

(3) Requires two DVI cables: one to connect the source to the booster and one to connect the booster to the display.



B116-004A (front and back)



P134-000



P566-xxx Series



B120-000 (front and back)

Easy Pull DVI Cables

- Detachable, screw-on connectors
- End caps with integrated pull rings
- Great for conduit and other tight spaces
- Single-link resolutions/bandwidth up to 1920 x 1080 / 4.95 Gbps
- Lifetime product warranty



EZB-xxx Series Base Cable and EZB-DVIM-2 Connector Kit

Easy Pull Base Cables

Easy Pull Type B Base Cables (Require Easy Pull Type B Connectors)

EZB-025	25 ft. Easy Pull Base Cable
EZB-050	50 ft. Easy Pull Base Cable
EZB-100	100 ft. Easy Pull Base Cable

Easy Pull DVI Connector Kits

- Include two connectors, with or without wall plates

Easy Pull Type B Connectors (Require Easy Pull Type B Base Cable)

EZB-DVIM-2	2 Easy Pull DVI Connectors (DVI-D Single-Link M, DVI-D Single-Link M) ⁽¹⁾
EZB-DVIF-2	2 Easy Pull DVI Connectors (DVI-D Single-Link F, DVI-D Single-Link F) ^(1,2)
EZB-DVIX-2	2 Easy Pull DVI Connectors (DVI-D Single-Link M, DVI-D Single-Link F) ^(1,3)



EZB-DVIX-2

Easy Pull DVI All-in-One Kits

- Cables up to 100 ft. with connectors included

Easy Pull All-in-One Kits (Include Cable and Connectors)

P561-050-EZ	50 ft. Easy Pull DVI Display Cable (DVI-D Single-Link M/M) ⁽¹⁾
P561-100-EZ	100 ft. Easy Pull DVI Display Cable (DVI-D Single-Link M/M) ⁽¹⁾

(1) Requires a DVI signal booster (B120-000-SL). (2) Includes two wall plates. (3) Includes one wall plate for the female connector.



P561-xxx-EZ Series

DVI Easy Pull Connection Diagram

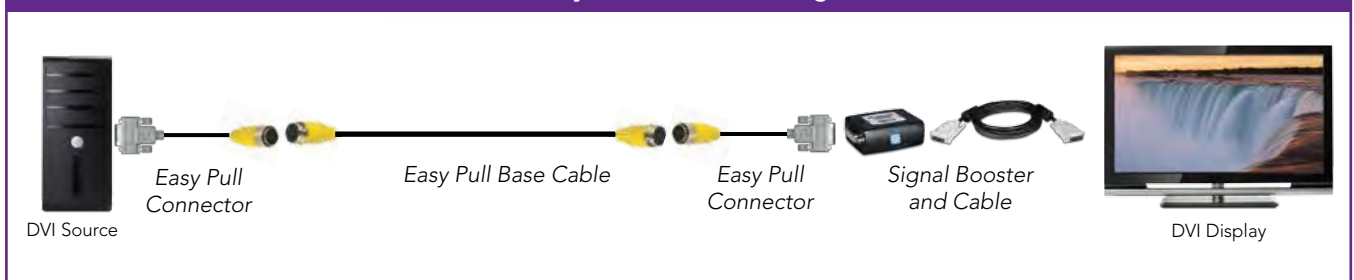

DVI Over Cat5 (UTP) Extenders

- Extend DVI signals over cost-effective Cat5 (UTP) cabling⁽¹⁾
- Connect up to 49 displays (1 local, 48 remote) to a single source⁽²⁾
- Support distances up to 700 ft. and resolutions up to 1920 x 1080⁽³⁾

EXTEND YOUR DVI SIGNAL VIA CAT5

DVI over Cat5 extenders transmit a DVI video signal to one or more remote displays using Cat5 (UTP) cabling.

PROVIDE A VARIETY OF OPTIONS

Each installation requires at least one transmitter and one receiver or repeater. You can select the required units separately or select a kit that bundles them, and you can choose between box-style and wall-plate-style units. You can also choose between active units that support longer distances but require an AC adapter near the remote display and passive units that support shorter distances but do not require an AC adapter near the remote display.

CONNECT MULTIPLE DISPLAYS

If you need to connect multiple remote displays to a single source, 2-port and 4-port transmitters send the DVI signal to multiple connection ports. You can daisy-chain up to three 4-port transmitters to expand the number of connection ports. The **B140-002-DD** Dual Monitor transmitter allows the DVI signals from a set of Dual DVI inputs to be routed to two sets of Dual Displays. (A receiver or repeater is required for each remote display.)

If you need to connect multiple remote displays to multiple sources, the **B140-202** 2x2 Matrix Switch transmitter unit sends multiple DVI signals to multiple connection ports. While standard transmitter units transmit a single DVI signal to one or more monitors, the 2x2 Matrix Switch allows you to transmit two DVI signals to two monitors. Either DVI signal can be routed to either monitor, or one DVI signal can be routed to both monitors. (A receiver or repeater is required for each remote display.)

You can also connect multiple remote displays by daisy-chaining repeaters with additional units. (You can daisy-chain up to three repeaters and one receiver to each transmitter connection port.) Daisy-chaining repeaters also extends the maximum cabling distance to 700 ft. in total.⁽³⁾



B140-004 4-Port Transmitter (front and back)



B140-101X Transmitter and Receiver Kit (front and back)

Wall-Plate-Style Unit



B140-1A0-WP Receiver

Box-Style Unit



B140-110 Repeater (front and back)

(1) Supported UTP cabling includes Cat 5/5e/6/6a. **(2)** A single 4-port transmitter supports up to 1 local and 4 remote displays. Up to three units can be daisy-chained to support an additional 4 remote displays per unit, up to 1 local and 12 remote displays. By connecting the remote displays through daisy-chained repeaters, the installation can be expanded to a maximum of 1 local and 48 remote displays. **(3)** Active receivers and kits support distances up to 150 ft. at 1920 x 1080 (60 Hz) resolution or 200 ft. at 1024 x 768 (60 Hz) resolution. Passive receivers and kits support distances up to 50 ft. at 1920 x 1080 (60 Hz) resolution or 100 ft. at 1024 x 768 (60 Hz) resolution. Repeaters support distances up to 125 ft. at 1920 x 1080 (60 Hz) resolution or 175 ft. at 1024 x 768 (60 Hz) resolution. Up to 4 repeaters can be daisy-chained together. (An active receiver can be placed at the end of the chain, as long as further expansion is not required.) The maximum distance between the transmitter and the first repeater is 175 ft. The maximum distance from each repeater to the next unit in the chain is 175 ft. The maximum distance from the transmitter to the last receiver in a complete daisy-chain is 700 ft. Maximum distance requires 24 AWG solid-wire cabling. See p. 23 for more information about display-optimized Cat5 (UTP) cabling.

DVI Over Cat5 (UTP) Selection Chart (Transmitters, Receivers, Repeaters and Kits)

Application	Model	Range ⁽¹⁾	Kit	Product Includes:			Form Factor:		Connects to:
				Transmitter	Receiver	Repeater	Box	Wall Plate	
DVI Only									
Extend signal to one display	A B140-101	100 ft.	✓	✓ (1-port)	✓ (passive)		✓		
	B B140-101X	200 ft.	✓	✓ (1-port)	✓ (active)		✓		M
	C B140-1A1-WP	200 ft.	✓	✓ (1-port)	✓ (active)			✓	M
	D B140-101-WP	100 ft.	✓	✓ (1-port)	✓ (passive)			✓	
Extend signal to multiple displays (B140-004 can also add a local display)	E B140-002	–		✓ (2-port)			✓		H I J K M
	F B140-002-DD ⁽³⁾	–		✓ (2-Port)			✓		H I J K M
	G B140-004 ⁽²⁾	–		✓ (4-port)			✓		G H I J K
	H B140-1A0	200 ft.			✓ (active)		✓		E F G L M
	I B140-1A0-WP	200 ft.			✓ (active)			✓	E F G L M
	J B140-1P0	100 ft.			✓ (passive)		✓		E F G L
	K B140-1P0-WP	100 ft.			✓ (passive)			✓	E F G L
Extend multiple signals to multiple displays	L B140-202 ⁽⁴⁾	–		✓ (2-Port)			✓		H I J K M
Add a remote display to an existing installation	M B140-110	175 ft.				✓	✓		B C E F G H I L M

All models require Cat5/5e/6/6a (UTP) cabling, sold separately. **(1)** Range and resolution may be affected by connected equipment. Active receivers and kits support distances up to 150 ft. at 1920 x 1080 (60 Hz) resolution or 200 ft. at 1024 x 768 (60 Hz) resolution. Passive receivers and kits support distances up to 50 ft. at 1920 x 1080 (60 Hz) resolution or 100 ft. at 1024 x 768 (60 Hz) resolution. Repeaters support distances up to 125 ft. at 1920 x 1080 (60 Hz) resolution or 175 ft. at 1024 x 768 (60 Hz) resolution. Up to 4 repeaters can be daisy-chained together. (An active receiver can be placed at the end of the chain, as long as further expansion is not required.) The maximum distance between the transmitter and the first repeater is 175 ft. The maximum distance from each repeater to the next unit in the chain is 175 ft. The maximum distance from the transmitter to the last receiver in a complete daisy-chain is 700 ft. Maximum distance requires 24 AWG solid-wire cabling. See p. 23 for more information about display-optimized Cat5 (UTP) cabling. **(2)** Up to three 4-port transmitters can be mounted in an optional 1U Rack Bracket (B132-004-RB). Up to three 4-port transmitters can be daisy-chained together to expand the number of displays connected to a single source. **(3)** The B140-002-DD Dual Monitor transmitter allows the DVI signals from a set of Dual DVI inputs to be routed to two sets of Dual Displays. **(4)** The B140-202 2x2 Matrix Switch transmitter unit allows you to transmit two DVI signals to two monitors. Either DVI signal can be routed to either monitor, or one DVI signal can be routed to both monitors.

DVI OVER CAT5 (UTP) EXTENDER Connection Example

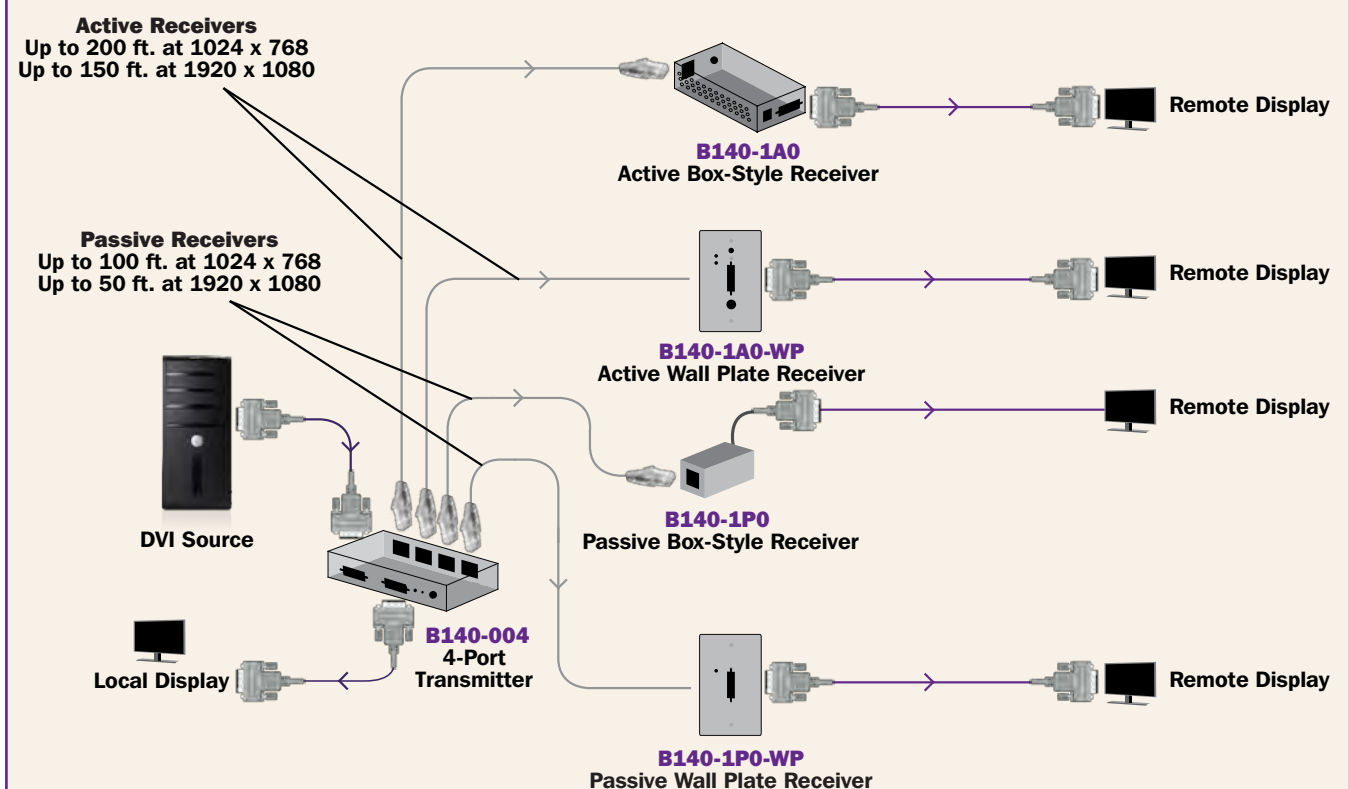

See p. 23 for display-optimized Cat5 (UTP) cabling

Direct-Connect HDMI Cables

- Shielded for maximum EMI/RFI protection
- Gold-plated for optimal signal transfer
- Up to 10.2 Gbps and full 1080p resolution
- Compatible with the most current HDMI technology standards, including 3D
- Lifetime product warranty



P568-xxx Series

High-Speed HDMI Cables

- Connect a source and HDTV or display directly
- Flat cables and space-saving connectors available



P568-xxx-FL Series

High-Speed HDMI Cables (HDMI M/M)

P568-003	3 ft. High-Speed HDMI Cable
P568-006	6 ft. High-Speed HDMI Cable
P568-010	10 ft. High-Speed HDMI Cable
P568-012	12 ft. High-Speed HDMI Cable
P568-016	16 ft. High-Speed HDMI Cable
P568-025	25 ft. High-Speed HDMI Cable ⁽¹⁾
P568-035	35 ft. High-Speed HDMI Cable ⁽¹⁾
P568-050	50 ft. High-Speed HDMI Cable ⁽¹⁾
P568-100	100 ft. High-Speed HDMI Cable ⁽¹⁾

Plenum-Rated High-Speed HDMI Cable (HDMI M/M)

P568-050-P	50 ft. Plenum-Rated High-Speed HDMI Cable ⁽¹⁾
------------	--

24 AWG High-Definition High-Speed HDMI Cable (HDMI M/M)

P568-100-HD	100 ft. HD High-Speed HDMI Cable ⁽¹⁾ with 24 AWG Conductors ⁽²⁾
-------------	---

Flat High-Speed HDMI Cables (HDMI M/M)

P568-003-FL	3 ft. Flat High-Speed HDMI Cable
P568-006-FL	6 ft. Flat High-Speed HDMI Cable
P568-010-FL	10 ft. Flat High-Speed HDMI Cable
P568-016-FL	16 ft. Flat High-Speed HDMI Cable

High-Speed HDMI Cables with Space-Saving 180° Swivel Connectors (HDMI M/M)

P568-003-SW	3 ft. High-Speed HDMI Cable with 180° Swivel Connectors
P568-006-SW	6 ft. High-Speed HDMI Cable with 180° Swivel Connectors
P568-010-SW	10 ft. High-Speed HDMI Cable with 180° Swivel Connectors

High-Speed HDMI Cables with Space-Saving Right-Angle Connectors (HDMI M/M)

P568-006-RA	6 ft. High-Speed HDMI Cable with Single Right-Angle Connector
P568-006-RA2	6 ft. High-Speed HDMI Cable with Dual Right-Angle Connectors

High-Speed Mini-HDMI Cable (Mini-HDMI M/M)

P572-006	6 ft. High-Speed Mini-HDMI Cable
----------	----------------------------------



P568-xxx-SW Series

High-Speed HDMI Cables with Ethernet

- Connect an Ethernet-enabled HDMI source and Ethernet-enabled HDTV or display directly
- Transfer HDMI and Ethernet signals over a single cable



P568-006-RA

High-Speed HDMI Cables with Ethernet (HDMI M/M)

P569-003	3 ft. High-Speed HDMI Cable with Ethernet
P569-006	6 ft. High-Speed HDMI Cable with Ethernet
P569-010	10 ft. High-Speed HDMI Cable with Ethernet
P569-016	16 ft. High-Speed HDMI Cable with Ethernet
P569-020	20 ft. High-Speed HDMI Cable with Ethernet ⁽¹⁾
P569-025	25 ft. High-Speed HDMI Cable with Ethernet ⁽¹⁾

(1) Cable runs longer than 16 ft. may require an HDMI signal booster (see p. 18).

(2) Heavy-gauge 24 AWG conductors provide superior signal transfer over long distances.



P569-xxx Series

HDMI Adapters

- Accommodate a variety of applications
- Premium construction and shielding
- Lifetime product warranty

HDMI Adapters

- Connect an HDMI display or source to a dissimilar display or source

HDMI Adapters

P130-000	DVI Source to HDMI Cable Adapter (DVI-D Single-Link M / HDMI F)
P131-06N	6 in. HDMI Source to VGA + Audio Adapter (HDMI M / HD15 F + 3.5 mm F)
P131-06N-MICRO	6 in. Micro-HDMI Source to VGA Adapter (Micro-HDMI M / HD15 F)
P132-000	HDMI Source to DVI Cable Adapter (DVI-D F / HDMI M)
P132-06N-MICRO	6 in. Micro-HDMI Source to DVI Cable Adapter (Micro-HDMI M to DVI-D F)
P132-08N	8 in. HDMI Source to DVI Gold Adapter (HDMI M / DVI-D F)
P136-000	6 in. DisplayPort Source to HDMI Cable Adapter (DP M / HDMI F)
P137-06N-HDMI	6 in. Mini-DisplayPort Source to HDMI Adapter for Mac / PC (mDP M / HDMI F)
P138-000-HDMI	8 in. Mini-DVI Source to HDMI Cable Adapter (mDVI M / HDMI F)
P142-000-UD	Adjustable-Angle HDMI Adapter (HDMI M/F)
P142-000-UP	Right-Angle HDMI Adapter (HDMI M/F)
P142-000-MICRO	HDMI to Micro-HDMI adapter (HDMI F / Micro-HDMI M)
P142-06N-MICRO	6 in. HDMI to Micro-HDMI adapter (HDMI F / Micro-HDMI M)
P142-000-MINI	HDMI to Mini-HDMI adapter (HDMI F / mHDMI M)
P566-003	3 ft. DVI to HDMI Display Cable (DVI Single-Link M / HDMI M)
P566-006	6 ft. DVI to HDMI Display Cable (DVI Single-Link M / HDMI M)
P566-010	10 ft. DVI to HDMI Display Cable (DVI Single-Link M / HDMI M)
P566-012	12 ft. DVI to HDMI Display Cable (DVI Single-Link M / HDMI M)
P566-016	16 ft. DVI to HDMI Display Cable (DVI Single-Link M / HDMI M)
P566-030	30 ft. DVI to HDMI Display Cable (DVI Single-Link M / HDMI M)
P566-050	50 ft. DVI to HDMI Display Cable (DVI Single-Link M / HDMI M)
P570-003-MICRO	3 ft. Micro-HDMI to HDMI Adapter Cable (Micro-HDMI M / HDMI M)
P570-006-MICRO	6 ft. Micro-HDMI to HDMI Adapter Cable (Micro-HDMI M / HDMI M)
P571-003-MINI	3 ft. HDMI to Mini-HDMI High Speed with Ethernet Cable (mHDMI M / HDMI M)
P571-006-MINI	6 ft. HDMI to Mini-HDMI High Speed with Ethernet Cable (mHDMI M / HDMI M)
P586-006-HDMI	6 ft. Mini-DisplayPort to HD Cable Adapter (mDP M / HDMI M)
U244-001-HDMI-R	USB 2.0 Source to HDMI Adapter (USB-A M / HDMI F) ⁽¹⁾
U344-001-HDMI-R	USB 3.0 Source to HDMI Adapter (USB-A M / HDMI F) ⁽¹⁾

HDMI Gender Changers

- Change a male HDMI connector to female

HDMI Gender Changers

P164-000	HDMI Male-to-Female Gender Changer (HDMI F/F)
P164-000-KJ-WH	HDMI Keystone Snap-In Wallplate Coupler (HDMI F/F)
P164-000-UP	Right-Angle HDMI Male-to-Female Gender Changer (HDMI F/F)
P166-001-P	HDMI Male-to-Female Pass-Through Wall Plate (HDMI F/F) ^(1,2)

(1) 1-year product warranty. (2) For cable runs longer than 16 ft. use the HDMI Wall Plate with Signal Booster (P166-001-A).



U244-001-HDMI-R (front and back)



P570-006



P136-000



P138-000-HDMI



P166-001-P



P142-000-UD

HDMI Splitters, Switches & Boosters

- Accommodate a variety of applications
- Boost HDMI signals for long cable runs
- Fully HDCP-compliant and 3D-compatible

HDMI Splitters

- Split an HDMI signal for distribution to multiple displays
- Support up to full 1080p (60 Hz) resolution
- Support up to 64 displays through multi-unit cascading

HDMI Splitters	
B118-002	2-Port HDMI Splitter (HDMI F/2F) ^(1,2,3)
B118-004	4-Port HDMI Splitter (HDMI F/4F) ^(1,2,4)
B156-002-HDMI	2-Port DisplayPort to HDMI Multi-Display Splitter/Expander (DP F / HDMI 2F) ^(1,2)

HDMI Switches

- Switch between multiple HDMI sources connected to a single HDMI port
- Support up to full 1080p (60 Hz) resolution

HDMI Switches	
B119-003-1	3-Port HDMI Switch with Remote (HDMI F/3F) ^(1,2)
B119-000-REC	IR Receiver for extending remote control range of B119-003-1
B119-302-R	2-Port HDMI Switch (HDMI F/2F) ^(1,2)

HDMI Signal Boosters

- Boost HDMI signals for cable runs up to 150 ft.

HDMI Signal Boosters	
B122-000	HDMI In-Line Active Signal Booster. Supports cable runs up to 150 ft. and resolutions up to 1080p/24 Hz. Includes AC adapter. (HDMI F/F) ^(1,2,5,6)
B122-000-60	HDMI In-Line Active Signal Booster. Supports cable runs up to 150 ft. and resolutions up to 1080p/60 Hz. Includes AC adapter. (HDMI F/F) ^(1,2,5,6)
B123-001	1 ft. HDMI Display-Side In-Line Cable with Active Signal Booster. Supports cable runs up to 150 ft. and resolutions up to 1080p/24 Hz. (HDMI M/F) ^(1,5,6)
B123-001-60	1 ft. HDMI Active Signal Extender. Supports cable runs up to 125 ft. and resolutions up to 1080p/60 Hz. Includes AC adapter. (HDMI M/F) ^(1,2,5,6)
P166-001-A	HDMI Pass-Through Wall Plate with Active Signal Booster. Supports cable runs up to 150 ft. and resolutions up to 1080p/60 Hz. (HDMI F/F) ^(1,5,6)



B119-003-1 (front and back)



B118-002 (front and back)

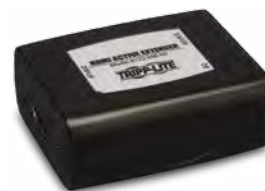

B122-000-60



P166-001-A



(1) 1-year product warranty. (2) Includes AC adapter. (3) Cascade multiple units to support up to 32 displays. (4) Cascade multiple units to support up to 64 displays. (5) For maximum signal quality at longer distances use a long-run HDMI cable with 24 AWG conductors, such as P568-100-HD. (6) Unit must be located within 16 ft. of display.

Easy Pull HDMI Cables

- Detachable, screw-on connectors
- End caps with integrated pull rings
- Great for conduit and other tight spaces
- Support up to full 1080p resolution
- Lifetime product warranty

Easy Pull Base Cables

Easy Pull Type B Base Cables (Require Easy Pull Type B Connectors)

EZB-025	25 ft. Easy Pull Base Cable
EZB-050	50 ft. Easy Pull Base Cable
EZB-100	100 ft. Easy Pull Base Cable

Easy Pull HDMI Connector Kits

- Include two connectors

Easy Pull Type B Connectors (Require Easy Pull Type B Base Cable)

EZB-HDMIM-2	2 Easy Pull HDMI Connectors (HDMI M, HDMI M) ⁽¹⁾
--------------------	---

Easy Pull HDMI All-in-One Kits

- Cables up to 100 ft. with connectors included

Easy Pull All-in-One Kits (Include Cable and Connectors)

P568-050-EZ	50 ft. Easy Pull HDMI Display Cable (HDMI M/M) ⁽¹⁾
P568-100-EZ	100 ft. Easy Pull HDMI Display Cable (HDMI M/M) ⁽¹⁾

⁽¹⁾ Also requires an HDMI signal booster (B122-000, B122-000-60, B123-001 or P166-001-A).



EZB-xxx Series Base Cable and EZB-HDMIM-2 Connector Kit



P568-xxx-EZ Series

HDMI Easy Pull Connection Diagram

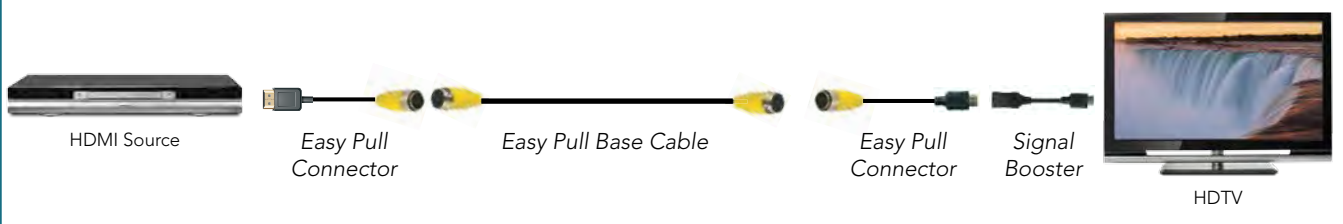

Tripp Lite HDMI Over Cat5 Extenders Proudly Participate on ABC's *Extreme Makeover: Home Edition*

"The B126-1A1 kits were easy to install and worked perfectly with all the TVs in the new home. Thank you, Tripp Lite, for a great solution and a high-quality product."

Justin Morabito, Test Engineer
Time Warner Cable Advanced Technology Group

Go to www.triplite.com/makeover for the full story! (PDF)
See page 20 for HDMI Over Cat5 Extenders.

HDMI Over Cat5 (UTP) Extenders

- Extend HDMI signals over cost-effective Cat5 (UTP) cabling⁽¹⁾
- Connect up to 49 displays (1 local, 48 remote) to a single source⁽²⁾
- Support distances up to 700 ft. and resolutions up to 1080p with full HDCP and 3D compatibility⁽³⁾

EXTEND YOUR HDMI SIGNAL VIA CAT5

HDMI over Cat5 extenders transmit an HDMI video signal to one or more remote displays using Cat5 (UTP) cabling.

PROVIDE A VARIETY OF OPTIONS

Each installation requires at least one transmitter and one receiver or repeater. You can select the required units separately or select a kit that bundles them, and you can choose between box-style and wall-plate-style units. You can also choose between active units that support longer distances but require an AC adapter near the remote display and passive units that support shorter distances but do not require an AC adapter near the remote display.

CONNECT MULTIPLE DISPLAYS

If you need to connect multiple remote displays to a single source, 2-port and 4-port transmitters send the HDMI signal to multiple connection ports. You can daisy-chain up to three 4-port transmitters to expand the number of connection ports. (A receiver or repeater is required for each remote display.)

If you need to connect multiple remote displays to multiple sources, the **B126-2X2** and **B126-4X4** Matrix Switches' transmitter units send multiple HDMI signals to multiple connection ports. While standard transmitter units transmit a single HDMI signal to one or more monitors, the 2x2 Matrix Switch allows you to transmit two HDMI signals to two monitors. Either HDMI signal can be routed to either monitor, or one HDMI signal can be routed to both monitors. The 4x4 Matrix Switch works the same way; it just adds more monitors. (A receiver or repeater is required for each remote display.)

You can also connect multiple remote displays by daisy-chaining repeaters with additional units. (You can daisy-chain up to three repeaters and one receiver to each transmitter connection port.) Daisy-chaining repeaters also extends the maximum cabling distance to 700 ft. in total.⁽³⁾

(1) Supported UTP cabling includes Cat 5/5e/6/6a. **(2)** A single 4-port transmitter supports up to 1 local and 4 remote displays. Up to three units can be daisy-chained to support an additional 4 remote displays per unit, up to 1 local and 12 remote displays. By connecting the remote displays through daisy-chained repeaters, the installation can be expanded to a maximum of 1 local and 48 remote displays. **(3)** Active receivers and kits support distances up to 150 ft. at 1080p (60 Hz) resolution or 200 ft. at 1080i (60 Hz) resolution. Passive receivers support distances up to 50 ft. at 1080p (60 Hz) resolution or 100 ft. at 1080i (60 Hz) resolution. Dual Cat5 kits require two Cat5 (UTP) cables and support distances up to up to 150 ft. at 1080p (60 Hz) resolution. Repeaters support distances up to 125 ft. at 1080p (60 Hz) resolution or 175 ft. at 1080i (60 Hz) resolution. Up to 4 repeaters can be daisy-chained together. (An active receiver can be placed at the end of the chain, as long as further expansion is not required.) The maximum distance between the transmitter and the first repeater is 175 ft. The maximum distance from each repeater to the next unit in the chain is 175 ft. The maximum distance from the transmitter to the last receiver in a complete daisy-chain is 700 ft. Maximum distance requires 24 AWG solid-wire cabling. See p. 23 for more information about display-optimized Cat5 (UTP) cabling.



B126-004 4-Port Transmitter (front and back)



B126-1A1 Transmitter and Receiver Kit (front and back)



B126-110 Repeater (front and back)

See p. 23 for display-optimized Cat5 (UTP) cabling

HDMI Over Cat5 (UTP) Selection Chart (Transmitters, Receivers, Repeaters and Kits)

Application	Model	Range ⁽¹⁾	Kit	Product Includes:			Form Factor:		Connects to:
				Transmitter	Receiver	Repeater	Box	Wall Plate	
HDMI Only									
Extend signal to one display (B126-1A1 can also add a local display)	A B125-101-60	150 ft.	✓	✓ (1-port)	✓ (dual Cat5)		✓		
	B B125-101-60-WP	150 ft.	✓	✓ (1-port)	✓ (dual Cat5)			✓	
	C B126-1A1	200 ft.	✓	✓ (1-port)	✓ (active)		✓		N
	D B126-1A1SR ⁽³⁾	328 ft. (100 m)	✓	✓ (1-port)	✓ (active)		✓		
	E B126-1A1-WP	200 ft.	✓	✓ (1-port)	✓ (active)			✓	N
Extend signal to multiple displays (B126-004 can also add a local display)	F B126-002	-		✓ (2-port)			✓		H I J K N
	G B126-004 ⁽²⁾	-		✓ (4-port)			✓		H I J K N
	H B126-1A0	200 ft.			✓ (active)		✓		F G N L M
	I B126-1A0-WP	200 ft.			✓ (active)			✓	F G N L M
	J B126-1P0	100 ft.				✓ (passive)		✓	F G L M
	K B126-1P0-WP	100 ft.				✓ (passive)		✓	F G L M
Extend multiple signals to multiple displays	L B126-2X2 ⁽⁴⁾	-		✓ (2-port)			✓		H I J K N
	M B126-4X4 ⁽⁴⁾	-		✓ (4-port)			✓		H I J K N
Add a remote display to an existing installation	N B126-110	175 ft.					✓	✓	C E F G H I N L M

All models require Cat5/5e/6/6a (UTP) cabling, sold separately. **(1)** Range and resolution may be affected by connected equipment. Active receivers and kits support distances up to 150 ft. at 1080p (60 Hz) resolution or 200 ft. at 1080i (60 Hz) resolution. Passive receivers support distances up to 50 ft. at 1080p (60 Hz) resolution or 100 ft. at 1080i (60 Hz) resolution. Dual Cat5 kits require two Cat5 (UTP) cables and support distances up to 150 ft. at 1080p (60 Hz) resolution. Repeaters support distances up to 125 ft. at 1080p (60 Hz) resolution or 175 ft. at 1080i (60 Hz) resolution. Up to 4 repeaters can be daisy-chained together. (An active receiver can be placed at the end of the chain, as long as further expansion is not required.) The maximum distance between the transmitter and the first repeater is 175 ft. The maximum distance from each repeater to the next unit in the chain is 175 ft. The maximum distance from the transmitter to the last receiver in a complete daisy-chain is 700 ft. Maximum distance requires 24 AWG solid-wire cabling. See p. 23 for more information about display-optimized Cat5 (UTP) cabling. **(2)** Up to three 4-port transmitters can be mounted in an optional 1U Rack Bracket (B132-004-RB). Up to three 4-port transmitters can be daisy-chained together to expand the number of displays connected to a single source. **(3)** In addition to transmitting a 1080p HDMI signal up to 328 ft. (100 m), the B126-1A1SR provides bi-directional IR and full-duplex RS-232 serial control. **(4)** The B126-2X2 and B126-4X4 Matrix Switches' transmitter units allow you to transmit multiple HDMI signals to multiple monitors. The B126-2X2 allows either HDMI signal to be routed to either monitor, or one HDMI signal can be routed to both monitors. The 4x4 Matrix Switch works the same way, it just adds more monitors.

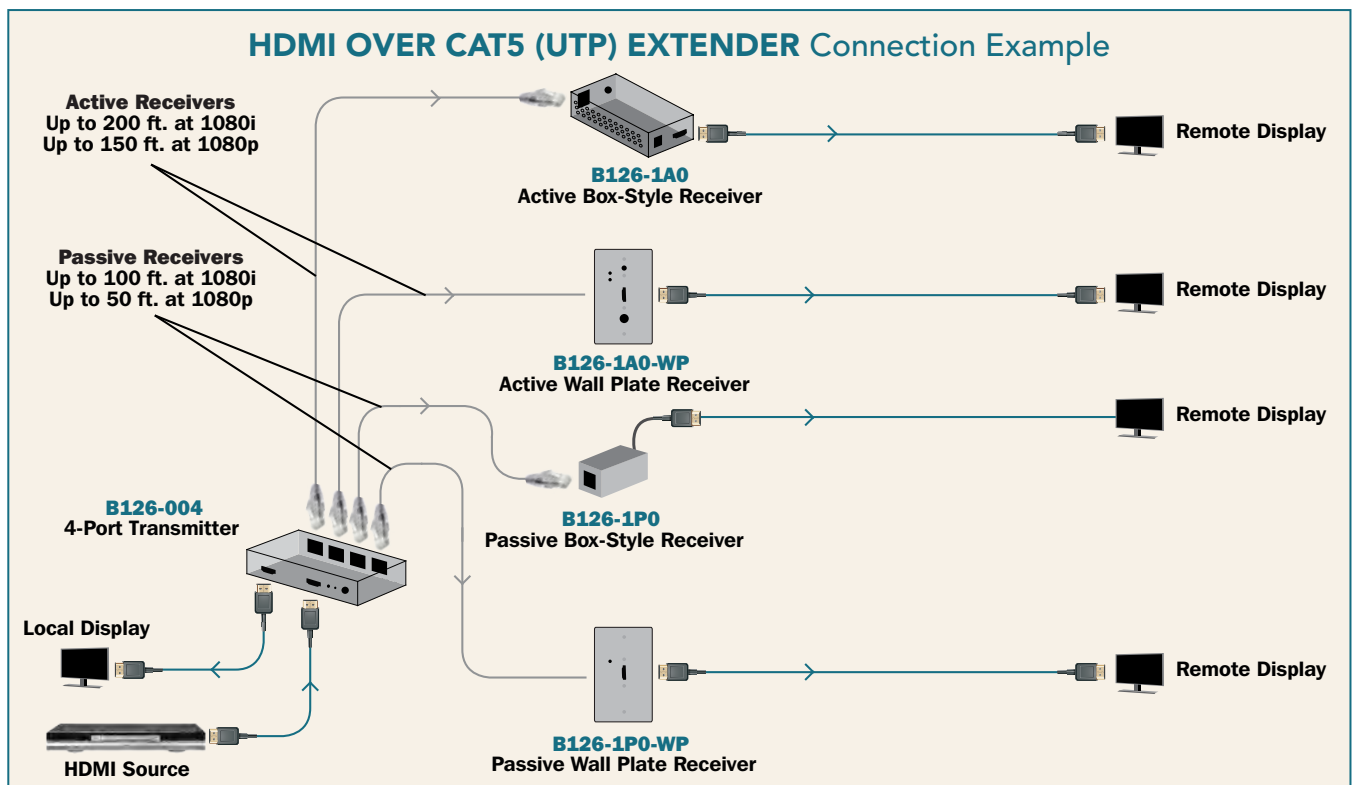

Go to www.triplite.com for the latest specifications and ordering information

DisplayPort Cables & Adapters

- Resolutions up to 2560 x 1600 (WQXGA)
- Shielded for maximum EMI/RFI protection
- Fully HDCP-compliant
- Lifetime product warranty

Direct-Connect DisplayPort Cables

- Connect a DisplayPort source and display directly



P580-xxx Series

DisplayPort Cables (DP M/M)	
P580-003	3 ft. DisplayPort Cable
P580-006	6 ft. DisplayPort Cable
P580-010	10 ft. DisplayPort Cable
P580-015	15 ft. DisplayPort Cable
P580-020	20 ft. DisplayPort Cable
P580-025	25 ft. DisplayPort Cable
P580-050	50 ft. DisplayPort Cable
P580-100	100 ft. DisplayPort Cable



P134-000

DisplayPort Adapters & Splitters

DisplayPort Adapters	
P134-000	6 in. DisplayPort Source to DVI Cable Adapter (DP M / DVI-D Single-Link F)
P134-06N-VGA	6 in. DisplayPort Source to VGA Cable Adapter (DP M / HD15 F)
P136-000	6 in. DisplayPort Source to HDMI Cable Adapter (DP M / HDMI F)
P137-06N-DVI	6 in. Mini-DisplayPort Source to DVI Cable Adapter (mDP M / DVI-D Single-Link F)
P137-06N-HDMI	6 in. Mini-DisplayPort Source to HDMI Cable Adapter (mDP M / HDMI F)
P137-06N-VGA	6 in. Mini-DisplayPort Source to VGA Cable Adapter (mDP M / HD15 F)
P139-06N-DP	6 in. Mini-DisplayPort Source to DisplayPort Cable Adapter (mDP M / DP F)
P581-006	6 ft. DisplayPort Source to DVI Display Cable (DP M / DVI-D Single-Link M)
P581-010	10 ft. DisplayPort Source to DVI Display Cable (DP M / DVI-D Single-Link M)
P583-003	3 ft. Mini-DisplayPort Source to DisplayPort Cable (DP M / mDP M)
P583-006	6 ft. Mini-DisplayPort Source to DisplayPort Cable (DP M / mDP M)
P583-010	10 ft. Mini-DisplayPort Source to DisplayPort Cable (DP M / mDP M)
P584-003	3 ft. Mini-DisplayPort Source to Mini-DisplayPort Cable (mDP M / mDP M)
P584-006	6 ft. Mini-DisplayPort Source to Mini-DisplayPort Cable (mDP M / mDP M)
P584-010	10 ft. Mini-DisplayPort Source to Mini-DisplayPort Cable (mDP M / mDP M)
P586-006-DVI	6 ft. Mini-DisplayPort Source to DVI Cable (mDP M / DVI-D M)
P586-006-HDMI	6 ft. Mini-DisplayPort Source to HDMI Cable (mDP M / HDMI M)
P586-006-VGA	6 ft. Mini-DisplayPort Source to VGA Cable (mDP M / HD15 M)



B121-000 DisplayPort Extender (front and back)



B156-002 DisplayPort Multi-Display Splitter/Expander (front and back)

DisplayPort Gender Changer (Changes a male DisplayPort connector to female.)	
P168-000	DisplayPort Male-to-Female Gender Changer (DP F/F)

DisplayPort Splitters	
B156-002	2-Port DisplayPort Multi-Display Splitter/Expander (DP F/2F) ⁽¹⁾
B156-002-DVI	2-Port DisplayPort to DVI Multi-Display Splitter/Expander (DP F / DVI-I 2F) ⁽¹⁾
B156-002-HDMI	2-Port DisplayPort to HDMI Multi-Display Splitter/Expander (DP F / HDMI 2F) ⁽¹⁾

DisplayPort Signal Boosters

- Boost DisplayPort signals for cable runs up to 150 ft.

DisplayPort Signal Boosters	
B121-000	DisplayPort In-Line Active Signal Booster. Supports cable runs up to 150 ft. and resolutions up to 1920 x 1080 @ 60Hz. Includes AC adapter. (DP F/F) ^(1,2,3)



P137-06N-DVI

(1) 1-year product warranty. (2) For maximum signal quality at distances over 100 ft., use cable made with 24 AWG wiring. (Available from Tripp Lite as a custom order.) (3) Unit must be located within 16 ft. of display.

Display-Optimized Cat5 (UTP) Cabling

- Superior performance for Over Cat5 (UTP) display applications
- 24 AWG solid-wire construction
- Lifetime product warranty

24 AWG Solid-Wire Cabling

- Superior performance for VGA, Analog Video, DVI and HDMI Over Cat5 display applications
- Patch cables and bulk cabling available

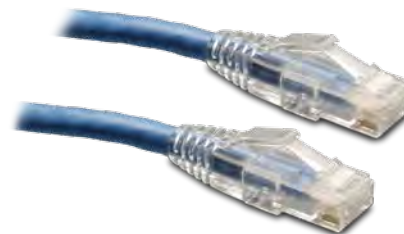

N202-xxx-BL Series

24 AWG Solid-Wire Patch Cables (RJ45 M/M)

N202-025-BL	25 ft. 24 AWG Solid-Wire Cat6 Patch Cable (Snagless, Blue)
N202-050-BL	50 ft. 24 AWG Solid-Wire Cat6 Patch Cable (Snagless, Blue)
N202-075-BL	75 ft. 24 AWG Solid-Wire Cat6 Patch Cable (Snagless, Blue)
N202-100-BL	100 ft. 24 AWG Solid-Wire Cat6 Patch Cable (Snagless, Blue)
N202-125-BL	125 ft. 24 AWG Solid-Wire Cat6 Patch Cable (Snagless, Blue)
N202-150-BL	150 ft. 24 AWG Solid-Wire Cat6 Patch Cable (Snagless, Blue)
N202-175-BL	175 ft. 24 AWG Solid-Wire Cat6 Patch Cable (Snagless, Blue)
N202-200-BL	200 ft. 24 AWG Solid-Wire Cat6 Patch Cable (Snagless, Blue)

24 AWG Solid-Wire Bulk Cabling

N022-01K-GY	1,000 ft. 24 AWG Solid-Wire Cat5e Cabling (Bulk Box, Gray)
N222-01K-GY	1,000 ft. 24 AWG Solid-Wire Cat6 Cabling (Bulk Box, Gray)
N222-01K-BL	1,000 ft. 24 AWG Solid-Wire Cat6 Cabling (Bulk Box, Blue)

Plenum-Rated 24 AWG Solid-Wire Bulk Cabling

N224-01K-GY	1,000 ft. Plenum-Rated 24 AWG Solid-Wire Cat6 Cabling (Bulk Box, Gray)
-------------	--



P524-01K Cabling (Bulk Box)

Zero-Skew 24 AWG Solid-Wire Cabling

- Maximum performance for long-run VGA and Analog Video Over Cat5 display applications

24 AWG Solid-Wire Zero-Skew Bulk Cabling

P524-01K	1,000 ft. Zero-Skew 24 AWG Solid-Wire UTP Cabling (Bulk Box, Red)
----------	---

Looking for Over Cat5 solutions?

VGA: pp. 6 – 7

Audio/Video: pp. 9 – 10

DVI: pp. 14 – 15

HDMI: pp. 20 – 21

Go to www.trippelite.com for the latest specifications and ordering information

Protect your valuable displays and sources!

UPS Systems

- Rackmount and tower UPS systems provide reliable battery backup with surge and line noise protection.
- Models with voltage regulation, expandable runtime, pure sine wave output, remote access capability, N+1 redundancy and energy-saving features are also available.

Power Distribution Units (PDUs)

- Tripp Lite makes a wide selection of basic, metered, monitored and switched Single- and 3-Phase PDUs in horizontal (1U/2U) and vertical (0U) form factors.



SUINT1500RTL2UA
SmartOnline® UPS System with Sine Wave Output



PDUMH20HVNET
Single-Phase Switched Power Distribution Unit with Built-in Web/Network Interface



SRW12US
SmartRack® 12U Wall-Mount Rack Enclosure



SRXCOOL12K
12,000 BTU Portable Air Conditioning Unit

Wall-Mount Rack Enclosure Cabinets

- Wall-mount rack enclosures from 5U to 26U provide convenient, locking, ventilated storage for rackmount and non-rackmount equipment that should be off the floor, out of the way and secure.

Cooling Solutions

- Portable air conditioning unit (**SRXCOOL12K**) provides up to 12,000 BTU of plug-and-play cooling power.
- Self-contained design does not require plumbing, a special outlet, a floor drain or emptying a water tank.

For Display Solutions Requiring a Global Presence...



The **B110-INT** International AC Adapter allows Tripp Lite's popular line of powered Over Cat5 devices to be used worldwide. Featuring a 4.5 m cord with BS1363, CEE 7/16 and AS3112 plug adapters, the B110-INT works with all UK, European and Australian power connections.

ABOUT TRIPP LITE

Since 1922, Tripp Lite has established a global reputation for quality manufacturing, superior value and excellent service. Tripp Lite makes more than 2,500 products to power, protect and connect electronic equipment, including UPS systems, replacement batteries, power distribution units, rack systems, cooling solutions, surge suppressors, KVM switches, cables, laptop accessories, power strips and inverters. Learn more at www.tripplite.com.



Tripp Lite World Headquarters 1111 W. 35th Street Chicago, IL 60609 USA, +1.773.869.1212

Tripp Lite Middle East: +971.4.887.1633 • infoem@tripplite.com

• **Tripp Lite Asia Pacific:** +972.54.2057646 • infoap@tripplite.com

Tripp Lite Eastern Europe: +36.1.203.7941 • infoeeu@tripplite.com

• **Tripp Lite East/West Africa:** +254.731.137.202 • infoa@tripplite.com

Tripp Lite South Africa: +27.82.8099.043 • infosas@tripplite.com

• **Tripp Lite Western Europe:** +33.1.70.61.77.85 • infoeu@tripplite.com

Tripp Lite United Kingdom: +44.01635.887396 • info-uk@tripplite.com