

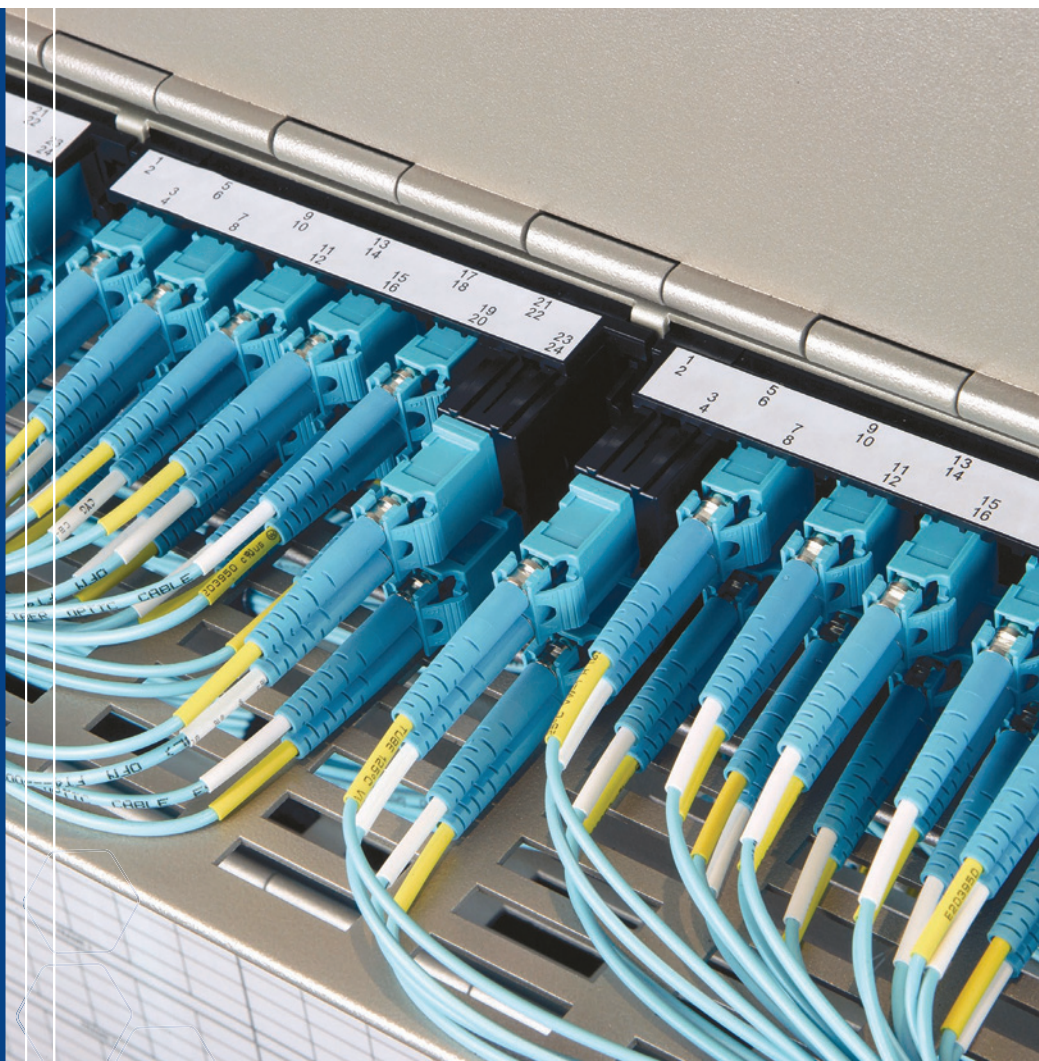

Belden® Optical Fiber Catalog



Our End-to-End Expertise
Your End-to-End Solution

Belden
FiberExpress®
Systems

Belden FiberExpress® Systems Reduce Complexity and Increase Flexibility

Involved in the development of optical fiber components for over 40 years, Belden is a leading supplier of high-quality, cost-effective optical fiber cabling systems. The FiberExpress (FX) Systems are the culmination of Belden's experience and expertise in a variety of applications, including data centers, premise and campus network backbone infrastructures, fiber-to-the-desk (FTTD) applications, and horizontal and centralized cabling systems. Guaranteed to meet or exceed all applicable TIA/EIA, ISO/IEC and IEEE standards, each end-to-end FX System is designed to offer reduced complexity, increased flexibility, and rapid installation.

LEED Point documents are available on several products, see specific product pages for LEED document retrieval instructions.



Introduction	2-3
FiberExpress Field Termination	4-8
FX Brilliance Universal Connectors	4
FX Brilliance Universal Installation Kits and Accessories	5
FX Pigtails.....	6-8
FiberExpress Patch Panel Systems	9 - 17
FX UHD Housing and Shelves.....	9
FX UHD and FX Ultra Cassettes.....	10-12
FX UHD and FX Ultra Frames.....	13
FX UHD and FX Ultra Splitter Cassettes and TAP Cassettes.....	14
FX UHD and FX Ultra Adapters and Accessories.....	15
FX UHD and FX Ultra Wall Mount and Accessories.....	16
FX Patch Rack Mount, Wall Mount Patch Panels, Adapter Strips and Accessories.....	17
FiberExpress Pre-Terminated Assemblies	18-27
FX Patch Cords.....	18-20
FX Hydra Patch Cords.....	21-22
FX MPO Trunk Assemblies.....	23-25
FX Multi-Fiber Cable Assemblies.....	26-27
FiberExpress Workstation Connectivity	28-29
FX Multi Box (M-Box) and MDVO Multimedia Outlet Box.....	28
Multi-User Outlet Box, MDVO Fiber Adapter Modules, KeyConnect Fiber Adapter Modules and Standard Duplex Fiber Adapters.....	29
FiberExpress Secure/Keyed LC System	30
FiberExpress Optical Fiber Cables	31-53
Fiber Cable Reference.....	31
FX Interconnect Cables.....	32
FX Breakout Cables.....	33
FX Distribution Cables.....	34-37
FX Armored Distribution Cables	38-41
FX Hybrid Distribution Cables	42
FX Reel-In-A-Box Packaging	43
FX uMini Distribution Cables.....	44-46
Single-Jacket, All Dielectric Loose Tube Cables.....	47-48
Double-Jacket, Armored Loose Tube Cables.....	49-50
Double-Jacket, Heavy-Duty Loose Tube Cables.....	51
Central Tube Cables.....	52
FX Drop Cables.....	53
Part Number Index	54-58
SmartPart Number Configurator	59
Customer Service and Other Belden Contacts	Back Cover

Faster.
Easier.
Better.



A Complete Approach to Fiber Optic Cabling

Belden FX Systems are available in a variety of performance levels to meet the value and price point for a wide variety of applications. Each system is uniquely color-coded for easy identification in the field.

The following is a recap of the five Belden FX Systems that are offered today:

Belden System	FX OM1	FX OM2	FX OM3	FX OM4	FX SM A1
Standard	OM1 - 62.5 µm Multimode Non-Bend Insensitive TIA-492AAAA ANSI/TIA-568-D.3 ISO/IEC 11801	OM2 - 50 µm Multimode Bend Insensitive TIA-492AAAB ANSI/TIA-568-D.3 ISO/IEC 11801	OM3 - 50 µm Multimode Bend Insensitive TIA-492AAAC ANSI/TIA-568-D.3 ISO/IEC 11801	OM4 - 50 µm Multimode Bend Insensitive TIA-492AAD ANSI/TIA-568-D.3 ISO/IEC 11801	OS2 - 9 µm Singlemode Bend Insensitive TIA-492CAAB ANSI/TIA-568-D.3 ISO/IEC 11801 ITU G.657.A1
Ethernet Applications	Legacy 1G up to 275 m	Not Recommended for New Designs	1G up to 550 m 10G up to 300m 40G/100G up to 100m	10G up to 400 m 40G/100G up to 150 m	10G up to 30/40 km 40G/100G up to 10/40 km
Fibre Channel Applications	Legacy 1G up to 300 m	Not Recommended for New Designs	4G up to 380 m 8G up to 300 m 16G up to 100 m	16G up to 125 m	4/8/16G up to 10 km
Fiber Cable Assemblies Jacket Color	Orange	Orange	Aqua	Erika Violet Aqua (optional)*	Yellow
Connector and Adaptor Color	Beige	Black	Aqua	Erika Violet Aqua (optional)*	Blue Green (APC)
Pre-Term Connector Loss	MPO-12 0.5 dB LC/SC/ST 0.25dB	MPO-12 0.5 dB LC/SC/ST 0.25dB	MPO-12 0.35 dB LC/SC/ST 0.25dB	MPO-12 0.2 dB LC/SC/ST 0.15dB	MPO-12 0.75 dB LC/SC/ST 0.35dB
Fiber Cable Loss	Tight Buffer (900 µm) 3.5 dB @ 850 nm 1.2 dB @ 1300 nm Enterprise Loose Tube (250 µm) 3.5 dB @ 850 nm 1.2 dB @ 1300nm	Tight Buffer (900 µm) 3.5 dB @ 850 nm 1.2 dB @ 1300 nm Enterprise Loose Tube (250 µm) 3.5 dB @ 850 nm 1.2 dB @ 1300nm	Tight Buffer (900 µm) 3.25 dB @ 850 nm 1.2 dB @ 1300 nm Enterprise Loose Tube (250 µm) 3.25 dB @ 850 nm 1.0 dB @ 1300nm	Tight Buffer (900 µm) 3.0 dB @ 850 nm 1.0 dB @ 1300 nm Enterprise Loose Tube (250 µm) 3.0 dB @ 850 nm 1.0 dB @ 1300nm	Tight Buffer (900 µm) 0.5 dB @ 1310nm 0.5 dB @ 1550 nm Enterprise Loose Tube (250 µm) 0.5 dB @ 1310nm 0.5 dB @ 1550 nm
Min. EMB (MHz-km)	N/A	N/A	2000 @ 850 nm	4700 @ 850 nm	N/A
Min. OFL Bandwidth (MHz-km)	200 @ 850 nm 500 @ 1300 nm	500 @ 850 nm 500 @ 1300 nm	1500 @ 850 nm 500 @ 1300 nm	3500 @ 850 nm 500 @ 1300 nm	N/A

* Belden Standard OM4 products use Erika Violet cable with Erika Violet connectors. Aqua OM4 cable and connectors are available as Tailored products by selecting OM4 fiber with the Aqua color code. Other combinations of fiber type and color will continue to use the default connector colors with the specified cable jacket color.

FiberExpress Field Termination FX Brilliance Universal Connectors



FX Brilliance Universal Connectors

Brilliant in design and universal in implementation, FX Brilliance Universal no-epoxy, no-polish, no-crimp field-installable connectors make fiber field termination faster, easier and better with our industry-leading design.

FASTER

- Faster fiber termination in as few as 5 seconds
- Faster installation proficiency through simple termination technique
- Faster 250 μ m direct installation eliminating break-out kits

EASIER

- Easier with no epoxy or polishing
- Easier no-crimp design
- Easier with duplex clips to hold TX/RX pairs together

BETTER

- Better termination yield with integrated VFL feedback
- Better universal cable support for 250 μ m, 900 μ m, 2 mm Jacketed, 3 mm Jacketed
- Better universal fiber support for OM1, OM2, OM3, OM4 as well as OS2

Three Simple Steps

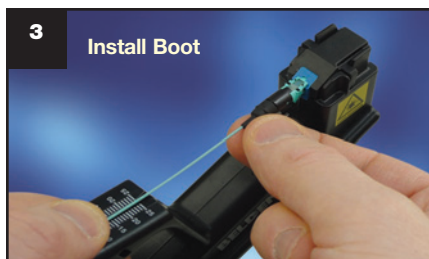

Connector Performance	Maximum Insertion Loss	Typical Insertion Loss	Return Loss
Multimode	0.5 dB	0.2 dB	25 dB
Singlemode UPC	0.5 dB	0.3 dB	50 dB
Singlemode APC	0.5 dB	0.3 dB	60 dB

Description	Belden Part Number		
	Multimode, OM1	Multimode, OM3/OM4 - Aqua	Multimode, OM4 - Erika Violet
LC with 900 μ m Boot, 25 per package	AX105200-B25	AX105202-B25	AX105252-B25
SC with 900 μ m Boot, 25 per package	AX105205-B25	AX105207-B25	AX105253-B25
ST with 900 μ m Boot, 25 per package	AX105210-B25	AX105212-B25	AX105254-B25

Replace -B25 with -S1 for sample 1 per package.

Description	Belden Part Number			
	Singlemode, OS2		Singlemode, OS2/APC	
	1 per package	25 per package	1 per package	25 per package
LC with 900 μ m Boot	AX105203-S1	AX105203-B25	-	-
SC with 900 μ m Boot	AX105208-S1	AX105208-B25	AX105209-S1	AX105209-B25
ST with 900 μ m Boot	AX105213-S1	AX105213-B25	-	-

FX Brilliance Universal includes a boot for 900 μ m Tight Buffered fiber. Boots for 2 mm/3 mm Jacketed fiber are sold separately.

Description	Belden Part Number
250 μ m Boot, 25 per package	FXBUB0250B25N
2 mm Jacketed Boot, 25 per package	AX105214-B25
3 mm Jacketed Boot, 25 per package	AX105215-B25

Description	Belden Part Number
LC Duplex Clip (Black), 25 per package	FXBUCLLDB25N
SC Duplex Clip (Black), 25 per package	FXBUCLSDB25N

Faster.
Easier.
Better.



FiberExpress Field Termination (continued) FX Brilliance Universal Installation Kits and Accessories

Improve Installer Comfort, Repeatability and Performance

Although termination of the FX Brilliance Universal connector can be done with no specialized tools, installation kits are available with all the tools necessary to prepare the fiber as well as to provide a stable work platform to achieve optimal installation results.

FX Brilliance Installation Kit

Description	Belden Part Number
Precision Installation Kit (Basic Kit, Fiber Preparation Tools, Precision Cleaver and Visual Fault Locator)	AX104271

FX Brilliance Accessories

Description	Belden Part Number
Precision Cleaver	AX104286
Precision Cleaver Replacement Blade (for FC-7 cleaver)	AX104293
Precision Cleaver Replacement Blade (for FC-7R cleaver)	AX104593
Support Handle with Adapters	AX104276
Support Handle LC Adapter	AX104289
Support Handle SC Adapter	AX104290
Support Handle ST Adapter	AX104291
Visual Fault Locator (VFL-250) with Adapter Cords	AX104283
Visual Fault Locator (VFL-125) LC-LC Adapter Cord	AX203567
Visual Fault Locator (VFL-125/250) LC-SC Adapter Cord (valid for ST also)	AX203568
Visual Fault Locator (VFL-250) SC-SC Adapter Cord (valid for ST also)	AX203569
Visual Fault Locator (VFL-125) LC-SC/APC Adapter Cord & Support Handle SC/APC Adapter	AX203895
Visual Fault Locator (VFL-250) SC-SC/APC Adapter Cord & Support Handle SC/APC Adapter	AX203930
Fiber/Cable Stripper	AX103151
Pen Marker	AX104279
Refurbishing Materials (80 alcohol wipes and a black pen marker)	AX100951
Safety Glasses	AX104282
Scissors	AX104280
Tweezers	AX104278
Waste Bottle	AX104281

Ensure Durable Rugged Installation on 250 µm Fiber

Field Breakout kits are available to provide a durable 900 µm coating for 250 µm fibers to ensure optimal retention, flex and twist support without sacrificing the outdoor performance of loose-tube cables or the small diameter of mini-distribution cables.

FX Breakout Kits

Description	Belden Part Number
Breakout Kit for 2.0 mm Subunits, 6-fiber, 1-Pack	AX101100
Breakout Kit for 3.0 mm Subunits, 12-fiber, 1-Pack	AX101101
Breakout kit for 5.2 mm Subunits (Central Tube), 6-fiber, 1-Pack	AX104695
Breakout kit for 5.2 mm Subunits (Central Tube), 12-fiber, 1-Pack	AX104696



AX104271, Precision Installation Kit



AX104286, Precision Cleaver



AX104276, Support Handle with Adapters

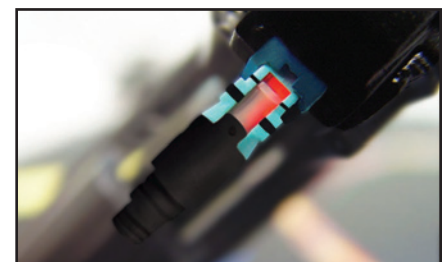

When used with the VFL, a light can be seen through the clear window on the connector body until a fiber has been properly terminated

i You can use the FX UHD Splice Cassette (see page 4) with the 250 µm Boot to eliminate the need to install a Break-out kit.

FiberExpress Field Termination (continued)

FX Pigtails

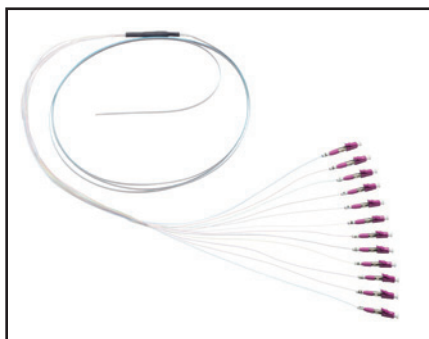

FT4LC250PR12, FX Mass-fusion Pigtail, OM4 Erika Violet, LC Simplex, 2 m

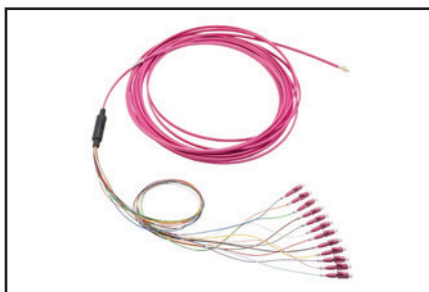

FT4LCRIBPS019ME, FX Mass-fusion Pigtail, OM4 Erika Violet, LC Simplex, 9 m

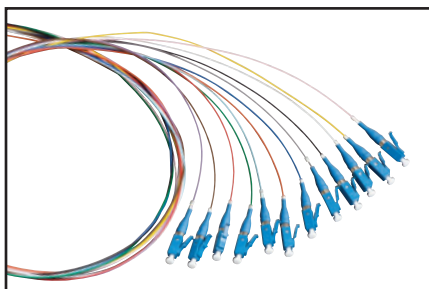

FTSLC900PR12, FX LC Color-coded Pigtail Kit, Singlemode

Established technology with a pedigree of resilience. Traditional fusion splice-on connectors with pigtails provide factory-polished performance with field-termination convenience within harsh environments.

FASTER

- Faster connector identification with color-coded pigtail kits
- Faster delivery with standard LC, SC or ST 2 meter pigtail kits
- Faster installation with Mass-Fusion pigtail kits

EASIER

- Easier field-termination with factory pre-terminated connectors
- Easier ordering with intuitive *SmartPart* numbers

BETTER

- Better quality with precision factory-polished connectors
- Better insertion loss at 0.2 dB MPO-12 and 0.15 dB Max IL OM4

Standard Performance

Description	FX OM1	FX OM3	FX OM4	FX SM	FX SM/APC
Cable Performance - LC/SC/ST					
IL Max. 850 nm/1300 nm (dB/Km)	3.5/1.2	3.25/1.2	3.0/1.2	–	–
IL Max. 1310 nm/1550 nm (dB/Km)	–	–	–	0.5/0.5	–
Fire Rating	OFN (<= 3 m) OFNP for Interconnect Ribbon 12-fiber (> 3 m) OFNR for all other cables (> 3 m)				
Cable Style	900 µm Color-coded fiber kit (6 or 12 colors from TIA-598) 900 µm single fiber OM1-Gray, OM3/OM4-Aqua, OS2-White 250 µm Bare ribbon fiber Interconnect Simplex/Duplex, 2 mm/3 mm cords Interconnect Ribbon 12-fiber cable				
Standard Length	2 meters				
Connector Performance - LC/SC/ST					
IL Max. (dB)	0.25	0.25	0.15	0.35	0.35
Polish - RL Typ. (dB)	PC - 30	PC - 30	PC - 30	UPC - 55	APC - 65

Description	FX OM1	FX OM3	FX OM4	FX SM	FX SM/APC
Cable Performance - MPO					
IL Max. 850 nm/1300 nm (dB/Km)	3.5/1.2	3.25/1.0	3.0/1.0	–	–
IL Max. 1310 nm/1550 nm (dB/Km)	–	–	–	0.5/0.5	–
Fire Rating	OFN (<= 3 m) OFNP (> 3 m)				
Cable Style	250 µm Bare ribbon fiber Interconnect Ribbon 12-fiber cable Interconnect Mini-Round 2 mm				
Standard Length	2 meters				
Connector Performance - MPO					
IL Max. (dB)	0.5	0.35	0.2	–	0.75
Polish - RL Typ. (dB)	PC - 30	PC - 30	PC - 30	–	APC - 60

The default fan-out is 0.5 m when there is a transition in a pigtail kit: 900 µm Color-coded fiber kit or 250 µm Bare Ribbon fiber (R06 or R12).

Faster.
Easier.
Better.



FiberExpress Field Termination (continued) FX Pigtails

Standard Mass-Fusion Pigtail Kits (Connector on 250 µm Ribbon)

Mass fusion splicing can fuse up to all 12 fibers in one ribbon at once. Mass fusion pigtails come with all 12 fibers terminated and a ribbonized open end. Splicers splice entire ribbons simultaneously.

Description	Belden Part Number				
	OM1	OM3	OM4	OS2	OS2/APC
MPO-12 (m)	–	FT3MM250PS01	FT4MM250PS01	–	FTSMM250PS01
LC	–	FT3LC250PR12	FT4LC250PR12	FTSLC250PR12	FTSLB250PR12
SC	FT1SC250PR12	FT3SC250PR12	–	FTSSC250PR12	FTSSB250PR12

Standard Mass-Fusion Color-coded Pigtail Kits contain a 12-fiber ribbon with a 0.5 m 900 µm fanout with 12 connectors, 2 m in total length.

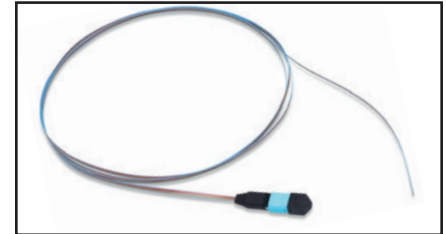

FT3MM250PS01, FX MPO Bare Ribbon Pigtail, OM3 Aqua, MPO(m), 2 m

Standard Pigtail Kits (Connector on 900 µm Fiber)

Description	Belden Part Number				
	OM1	OM3	OM4	OS2	OS2/APC
LC	–	FT3LC900PR12	FT4LC900PR12	FTSLC900PR12	FTSLB900PR12
SC	FT1SC900PR12	FT3SC900PR12	FT4SC900PR12	FTSSC900PR12	FTSSB900PR12
ST	FT1ST900PR12	FT3ST900PR12	–	FTSST900PR12	–

Standard Color-coded Pigtail Kits contain 12 color-coded 900 µm fibers, 2 m in length.

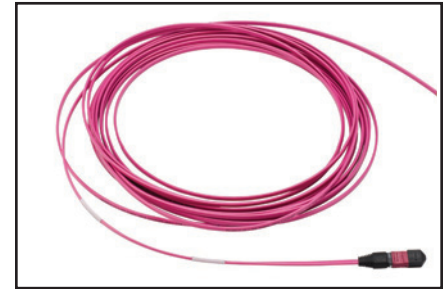

FT4MMRIBPS019ME, FX MPO Jacketed Ribbon Pigtail, OM4 Erika Violet, MPO(m), 9 m

Standard Single Pigtails (Connector on Tight buffer Fiber)

Description	Belden Part Number				
	OM1	OM3	OM4	OS2	OS2/APC
LC	–	FT3LC900PS01	FT4LC900PS01	FTSLC900PS01	FTSLB900PS01
SC	FT1SC900PS01	FT3SC900PS01	FT4SC900PS01	FTSSC900PS01	FTSSB900PS01
ST	FT1ST900PS01	FT3ST900PS01	–	FTSST900PS01	–

Standard Single 900 µm Tight Buffer Pigtails contain 1 unit, 2 m in length.

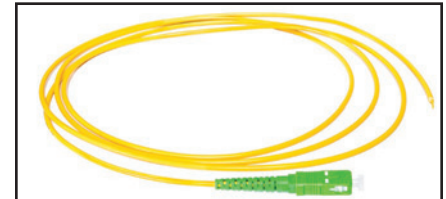

FTSSB3MMPS01, FX Pigtail, Jacketed Simplex 3.0 mm Cord, OS2 Yellow, SC/APC Simplex

Standard Single Pigtails (Connector on Jacketed Fiber)

Description	Belden Part Number				
	OM1	OM3	OM4	OS2	OS2/APC
MPO-12(m)	–	FT3MM3MMPS01	FT4MM3MMPS01	–	FTSMM3MMPS01
LC	–	FT3LC2MMPS01	FT4LC2MMPS01	FTSLC2MMPS01	FTSLB2MMPS01
LC Duplex	–	FT3LD2MMPS01	FT4LD2MMPS01	FTSLD2MMPS01	FTSLA2MMPS01
SC	FT1SC3MMPS01	FT3SC3MMPS01	FT4SC3MMPS01	FTSSC3MMPS01	FTSSB3MMPS01
SC Duplex	FT1SD3MMPS01	FT3SD3MMPS01	FT4SD3MMPS01	FTSSD3MMPS01	FTSSA3MMPS01
ST Simplex	FT1ST3MMPS01	FT3ST3MMPS01	–	FTSST3MMPS01	–

Standard Single-Jacketed Pigtails contain 1 unit, 2 m in length.



FT4LD2MMPS01, FX Pigtail, Jacketed Duplex 2.0 mm Cord, OM4 Erika Violet, LC Duplex

Fusion Splice Heat Shrink Protector Sleeves

Description	Belden Part Number
Heat Shrink Splice Protector Sleeves, 900 µm to 900 µm, 2.5 mm round x 60 mm long, 25/package	FXFUHS900AB25
Heat Shrink Splice Protector Sleeves, 900 µm to 250 µm, 2.0 mm round x 40 mm long, 25/package	FXFUHS9T2CB25
Heat Shrink Splice Protector Sleeves, 250 µm to 250 µm, 1.5 mm round x 40 mm long, 25/package	FXFUHS250DB25
Heat Shrink Splice Protector Sleeves, 250 µm 12-fiber Ribbon, oval x 40 mm long, 12/package	FXFUHSRIBEB12

See page 8, Tailored Pigtails - Building a SmartPart Number table, for more options.

 Mass-fusion pigtails drastically reduce the amount of labor time spent on fiber terminations (up to 50%) and increase maximum of fiber terminations per day (around 3.5 times more than traditional single splicing).

FiberExpress Field Termination (continued) FX Pigtails

Tailored Pigtails - Building a SmartPart Number

FX Field Termination

FT

1. Choose Fiber Type

3

Fiber Type	
1	OM1
3	OM3
4	OM4
S	OS2

2. Choose Connectors

LC

Connectors	
LD	LC Duplex
LC	LC Simplex
LA	LC/APC Duplex
LB	LC/APC Simplex
SD	SC Duplex
SC	SC Simplex
SA	SC/APC Duplex
SB	SC/APC Simplex
ST	ST
MM	MPO-12 (m)
MF	MPO-12 (f)

3. Choose Cable Type

900

Cable Type	
250	Bare Ribbon 250 μ m Fiber
RIB	Jacketed Ribbon
900	900 μ m Tight Buffer
2MM	2 mm Jacketed
3MM	3 mm Jacketed

4. Choose Product Family

P

Product Family	
P	Pigtails

5. Choose Packaging

R12

Packaging	
S01	Single Pack
R06	Rainbow 6 Pk
R12	Rainbow 12 Pk

6. Choose Length

3M

Length	
2M	
3M	
4M	
5M	
6M	
7M	
8M	
9M	

7. Choose Jacket/ Buffer Color

D

Buffer Color	
O	Orange
S	Gray
W	White
Y	Yellow
A	Aqua
E	Erika V.
D	Default Color

Use of Tailored part numbers:

Color - Default color (D) is only used with cable type (250 μ m or 900 μ m) and Packaging (R06 or R12)

Examples:

FT3LC900PR123MD - FX Field-Termination Pigtail, OM3, LC Simplex, Tight Buffer 900 μ m, Color-Coded 12-Fiber, 3 m

FTSST900PR125MY - FX Field-Termination Pigtail, OS2, ST, Tight Buffer 900 μ m, Color-Coded 12-Fiber, 5 m, Yellow Jacket

FT3MMRIBPS014MA - FX Field-Termination Pigtail, OM3, MPO-12 (M), Jacketed Ribbon, Single-Ended, 4 m, Aqua Jacket

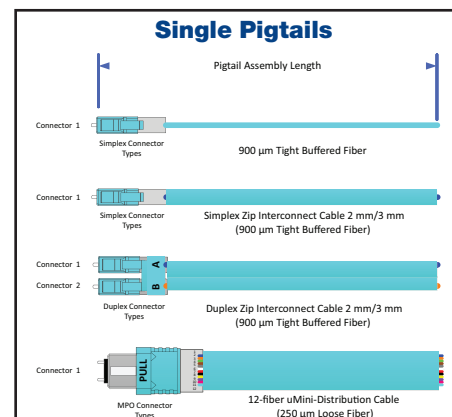
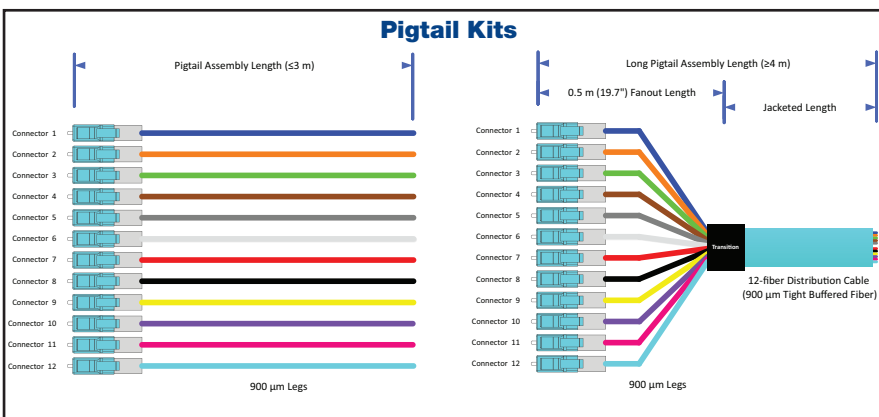
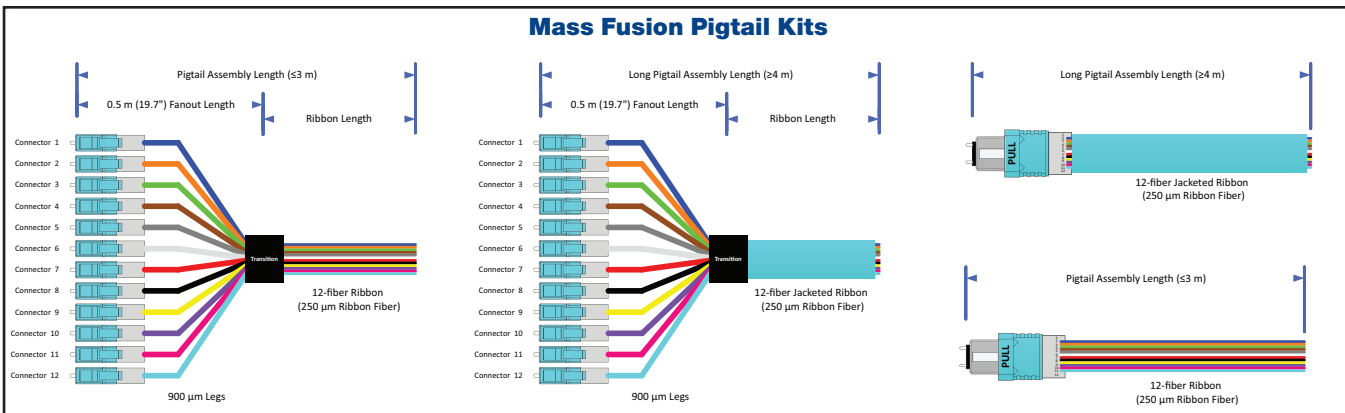

Please contact Belden for any help configuring/validating SmartPart Numbers or for any other custom Engineered solutions

Faster.
Easier.
Better.



FiberExpress Patch Panel Systems FX UHD Housings and Shelves

Elegantly simple yet uncompromisingly flexible. Ultra high-density rack-mount fiber connectivity system, crafted for effortless installation and maintenance.

FASTER

- Faster field-termination with high-accessibility sliding and tilting drawers
- Faster pre-term installation with simple fixed shelves and cassettes

EASIER

- Easier installation with tool-less removable drawers and lightweight housings
- Easier port identification with clear visible labeling
- Easier to configure with flexible port count LC, SC, ST and MPO modules

BETTER

- Better fiber protection with covered patch cord tray
- Better high density offering with 18-port modules for up to 72 LC Duplex ports per 1U
- Better visibility with light colored Titanium finish

FX UHD Housings

Feature-rich housings are fully enclosed to provide protection for exposed 250 μ m and 900 μ m fibers coupled with sliding and tilting drawers to speed up and simplify installation and maintenance.

Description	Number of Module Bays	Total LC Duplex/ MPO Ports using FX Ultra Frames and Cassettes	Total LC Duplex/ MPO Ports using FX UHD Frames and Cassettes	Belden Part Number	
				Titanium	Black
1U Housing with Front and Rear Cable Tray	4	48	72	AX104681	AX105563
2U Housing with Front and Rear Cable Tray	8	96	144	AX104682	AX105564
4U Housing with Front and Rear Cable Tray	16	192	288	AX104683	AX105565
4U 23" Housing with Front and Rear Cable Tray	20	240	360	AX105379	-
Optional 1U Splice Housing Kit, 144 splices (add up to 4 on the 4U Housing) ¹	N/A	N/A	N/A	AX104684	AX105678
Optional Patch Cord Tray Cover, 19" ²	N/A	N/A	N/A	AX105162	AX105672

1. Up to 4 splice housing kits can be added to 4U housings. Splice housing kits are only compatible with standard 19" rack mount housings.
2. Use with 1U or 4U housings to protect the contents of the topmost patch cord tray. Patch cord tray cover is included with 23" housings.

FX UHD Shelves, Single Cassette Holder

Entry-level cost effective solutions for pre-terminated systems.

Description	Number of Module Bays	Total LC Duplex/ MPO Ports using FX Ultra Frames and Cassettes	Total LC Duplex/ MPO Ports using FX UHD Frames and Cassettes	Belden Part Number	
				Titanium	Black
1U FX UHD Bezel	4	48	72	AX105813	AX105812
1U Standard Fixed Shelf	4	48	72	AX105164	AX105673
1U Recessed Fixed Shelf	4	48	72	AX105165	AX105674
4U Standard Fixed Shelf	10	120	180	AX105166	AX105675
4U Recessed Fixed Shelf	10	120	180	AX105167	AX105676
FX UHD Single & Double Cassette Holders				Magnetic	Non-Magnetic
Single Cassette Holder (Black Finish)	1	18	12	FXFUBRSHM	FXFUBRSHM
Double Cassette Holder (Black Finish)	1	36	24	FXFUBRDHM	FXFUBRDHS

See the FX UHD System Product Bulletin (PB500) for further options



Top: AX104681, FX Ultra HD 1U Patch Panel Housing
Bottom: AX104683, FX UHD 4U Patch Panel Housing (shown loaded)



AX104681, FX UHD Patch Panel 1U with Mounted Splice Housing Kit (AX104684)

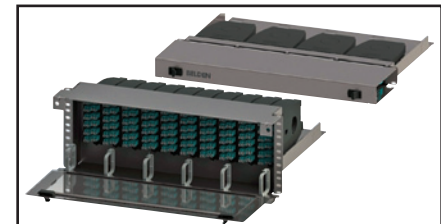

Top: AX105164, FX UHD 1U Patch Panel Standard Shelf
Bottom: AX105167, FX UHD 4U Patch Panel Recessed Shelf (shown loaded)



AX105813 FX UHD 1U Bezel



Top: FXFUBRSHM, FX UHD Single Cassette Holder with Magnetic Attachment
Bottom: FXFUBRDHM FX UHD Double Cassette Holder with Magnetic Attachment (Bottom)

FiberExpress Patch Panel Systems (continued) FX UHD and FX Ultra Cassettes



FC3H18LDMF, FX UHD Cassette, OS2, 18 Ports, MPO-12 (female), LC Duplex, Type-A, Blue Adapters



FC3U12LDMF1A, FX Ultra Cassette, OM3, 12 Ports, MPO-12 (female), LC Duplex, Type-A ALT, Aqua Adapters

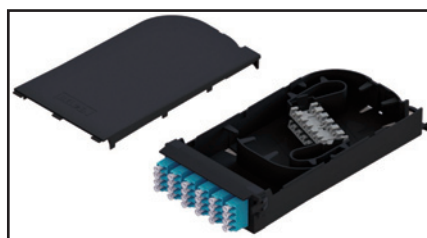

FC3H12LDFS, FX UHD Splice Cassette, OM3, 12 Ports, LC duplex, Aqua Adapters

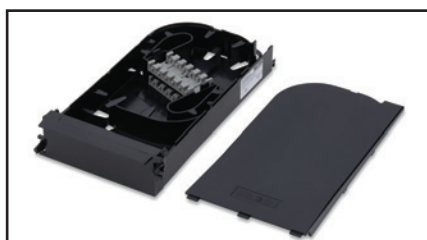

FCZH00BBFS, FX UHD Empty Splice Cassette

FX UHD and FX Ultra Cassettes

Featuring the highest density at 72 LC Duplex or MPO ports per 19" rack unit FX UHD family is the ideal choice for high-port count applications such as in the data center.

Unique 1" pull-out feature of the FX Ultra family provides a medium density solution with a superior ease of use for day-to-day MAC (moves, adds and changes) within the Enterprise or cross-connect within the data center.

Standard Type-A Cassettes (Base12)

Description			Belden Part Number				
Patch Ports (fibers)	Trunk Ports	Family	OM1 Beige Adapters	OM3 Aqua Adapters	OM4 Erika Violet Adapters	OS2 Blue Adapters	OS2/APC Green Adapters
LC Duplex to MPO-12(12f) Female							
18 (36)	3	FX UHD*	–	FC3H18LDMF	FC4H18LDMF	FCSH18LDMF	FCSH18LAMF
12 (24)	2	FX Ultra	FC1U12LDMF	FC3U12LDMF	FC4U12LDMF	FCSU12LDMF	FCSU12LAMF
SC Duplex to MPO-12(12f) Female							
6 (12)	1	FX Ultra	FC1U06SDMF	FC3U06SDMF	FC4U06SDMF	FCSU06SDMF	FCSU06SAMF
SC Simplex to MPO-12(12f) Female							
12 (12)	1	FX Ultra	–	–	–	FCSU12SCMF	FCSU12SBMF

*Optional HD Patch cord release tool AX104685

Standard Type-A-Alternate Cassettes (Base12)

Description			Belden Part Number				
Patch Ports (fibers)	Trunk Ports	Family	OM1 Beige Adapters	OM3 Aqua Adapters	OM4 Erika Violet Adapters	OS2 Blue Adapters	OS2/APC Green Adapters
LC Duplex to MPO-12(12f) Female							
18 (36)	3	FX UHD	–	FC3H18LDMF1A	FC4H18LDMF1E	FCSH18LDMF1B	FCSH18LAMF1G
12 (24)	2	FX Ultra	FC1U12LDMF1T	FC3U12LDMF1A	FC4U12LDMF1E	FCSU12LDMF1B	FCSU12LAMF1G
SC Duplex to MPO-12(12f) Female							
6 (12)	1	FX Ultra	FC1U06SDMF1T	FC3U06SDMF1A	FC4U06SDMF1E	FCSU06SDMF1B	FCSU06SAMF1G
SC Simplex to MPO-12(12f) Female							
12 (12)	1	FX Ultra	–	–	–	FCSU12SCMF1B	FCSU12SBMF1G

Standard Splice Cassettes

Description	Belden Part Number				
Patch Ports (fibers)	OM1 Beige Adapters	OM3 Aqua Adapters	OM4 Erika Violet Adapters	SM Blue Adapters	OS2/APC Green Adapters
MPO Type-A (Key-Up/Key-Down)					
12 (144)	FC1H12MPFS	FC3H12MPFS	FC4H12MPFS	–	FCSH12MPFS
LC Duplex					
12 (24)	FC1H12LDFS	FC3H12LDFS	FC4H12LDFS	FCSH12LDFS	FCSH12LAFS
SC Duplex					
6 (12)	FC1H06SDFS	FC3H06SDFS	FC4H06SDFS	FCSH06SDFS	–
SC Simplex					
12 (12)	–	–	–	–	FCSH12SBFS
ST (Metal Adapters)					
12 (12)	FCSH12STFS				
Splice Only (No Adapters)					
N/A (144)	FCZ00BBFS				

FX Brilliance Universal (page 4) or FX Pigtailed (page 6) and Heat Shrink Splice Protector Sleeves (page 7) sold separately.

Faster.
Easier.
Better.



FiberExpress Patch Panel Systems (continued) FX UHD and FX Ultra Cassettes

Standard FX UHD Angled Cassettes (Base12)

Description	Left			Right		
Patch Ports (fibers)	OM3 Aqua Adapters	OM4 Erika Violet Adapters	SM Blue Adapters	OM3 Aqua Adapters	OM4 Erika Violet Adapters	OS2 Blue Adapters
LC Duplex to MPO-12(12f) Female Type-A						
12(24)	FC3L12LDMF	FC4L12LDMF	FCSL12LDMF	FC3R12LDMF	FC4R12LDMF	FCSR12LDMF
LC Duplex to MPO-12 (12f) Female Type-A Alternate						
12(24)	FC3L12LDMF1A	FC4L12LDMF1E	FCSL12LDMF1B	FC3R12LDMF1A	FC4R12LDMF1E	FCSR12LDMF1B
SC Duplex to MPO-12(12f) Female Type-A						
6 (12)	FC3L06SDMF	FC4L06SDMF	FCSL06SDMF	FC3R06SDMF	FC4R06SDMF	FCSR06SDMF
SC Duplex to MPO-12(12f) Female Type-A Alternate						
6 (12)	FC3L06SDMF1A	FC4L06SDMF1E	FCSL06SDMF1B	FC3R06SDMF1A	FC4R06SDMF1E	FCSR06SDMF1B



FX UHD Angled Cassettes, 12 Ports, LC Duplex and 6 Ports, SC Duplex. See Tailored *SmartPart* numbers for Details.

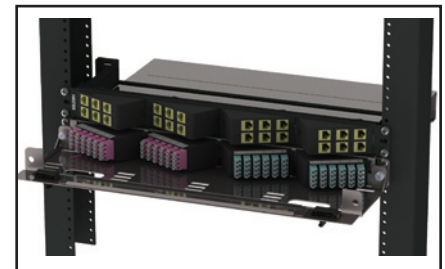

FX UHD Angled Cassettes (shown installed in FX UHD 1U Housing with Belden Angleflex Copper Patch Patch)

Tailored FX UHD and FX Ultra Cassettes (Base12)

Building a SmartPart Number

Fixed Letter Series	1. Choose Fiber Type	2. Choose Product Family	3. Choose Port Count (Patch Side)	4. Choose Connector (Patch Side)	5. Choose Connector (Trunk Side)	6. Choose Polarity (Trunk)	7. Choose Adapter Color
FC	3	U	03	LD	MM	A	A
Fiber Type	Product Family	Port Count (Patch Side)	Connector (Patch Side)	Connector (Trunk Side)	Polarity (Trunk)	Adapter Color	
1 OM1	H FX UHD	03	LD LC Duplex	MM MPO-12 (m)	A Type-A	T Beige	
3 OM3	U FX Ultra (1" Pull)	06	LA LC/APC Duplex	MF MPO-12 (f)	1 Type-A ALT.	N Black	
4 OM4	L FX U Angled Left	12	SD SC Duplex			A Aqua	
S OS2	R FX U Angled Right	18	SC SC Simplex			E Erika V.	
			SA SC/APC Duplex			B Blue	
			SB SC/APC Simplex			G Green	
			ST ST				

For further options contact Belden for custom Engineered solutions.

FiberExpress Patch Panel Systems (continued) FX UHD and FX Ultra Cassettes



FC3U034MMF, FX UHD Optimizer Cassette, OM3, Aqua Adapters



FCSU12LD4F, FX Ultra Cassette, OM3, 12 Ports, MPO-12 (female), LC Duplex, Type SR4 (Base8), Aqua Adapters

Belden FX UHD Base8 Cassettes

Optimized for SR4 and PSM4 based architectures like 40G and 100G Ethernet as well as Compute, Switch and Storage equipment with groupings of 4, 8 and 12 ports. Belden Base8 Cassettes optimize costs when used with Base8 MPO Trunks and Patch cords by eliminating dark fiber associated with SR4 & PSM4 architectures.

Standard SR4 Optimizer Cassettes (Base8)

Description			Belden Part Number		
Patch Ports (fibers)	Trunk Ports	Family	OM3 Aqua Adapters	OM4 Erika Violet Adapters	OS2/APC Green Adapters
MPO-12(8f) Male to MPO-12(12f) Female					
6 x MPO-12 (8f)	4 x MPO-12 (12f)	FX Ultra	FC3U064MMF	FC4U064MMF	FCSU064MMF
3 x MPO-12 (8f)	2 x MPO-12 (12f)	FX Ultra	FC3U034MMF	FC4U034MMF	FCSU034MMF

Standard SR4 Cassettes (Base8)

Description			Belden Part Number		
Patch Ports (fibers)	Trunk Ports	Family	OM3 Aqua Adapters	OM4 Erika Violet Adapters	OS2 Blue Adapters
LC Duplex to MPO-12(8f) Female					
16 (32)	4	FX UHD	FC3H16LD4F	FC4H16LD4F	FCSH16LD4F
12 (24)	3	FX Ultra	FC3U12LD4F	FC4U12LD4F	FCSU12LD4F
8 (16)	2	FX Ultra	FC3U08LD4F	FC4U08LD4F	FCSU08LD4F
4 (8)	1	FX Ultra	FC3U04LD4F	FC4U04LD4F	FCSU04LD4F

Standard SR4 Angled Cassettes (Base8)

Description	Left			Right		
	OM3 Aqua Adapters	OM4 Erika Violet Adapters	OS2 Blue Adapters	OM3 Aqua Adapters	OM4 Erika Violet Adapters	OS2 Blue Adapters
LC Duplex to MPO-12(8f) Female						
12 (24)	FC3L12LD4F	FC4L12LD4F	FCSL12LD4F	FC3L12LD4F	FC4L12LD4F	FCSL12LD4F

Tailored FX UHD and FX Ultra Cassettes (Base8)

Building a SmartPart Number

Fixed Letter Series	1. Choose Fiber Type	2. Choose Product Family	3. Choose Port Count (Patch Side)	4. Choose Connector (Patch Side)	5. Choose Connector (Trunk Side)	6. Choose Polarity (Trunk)	7. Choose Adapter Color
FC	3	U	04	LD	4M	4	A

Fiber Type	Product Family	Port Count (Patch Side)	Connector (Patch Side)	Connector (Trunk Side)	Polarity (Trunk)	Adapter Color
3 OM3	H FX UHD	04 4 Ports	LD LC Duplex	4M MPO-12 (8f) Male	4 SR4 (Base8)	A Aqua
4 OM4	U FX Ultra	08 8 Ports		4F MPO-12 (8f) Female		E Erika V.
S OS2	L FX U Angled Left	12 12 Ports				B Blue
	R FX U Angled Right	16 16 Ports				

For further options contact Belden for custom Engineered solutions.

Faster.
Easier.
Better.



FiberExpress Patch Panel Systems (continued) FX UHD and FX Ultra Frames

Standard FX UHD and FX Ultra Frames

Description		Belden Part Number				
Patch Ports (fibers)	Family	OM1 Beige Adapters	OM3 Aqua Adapters	OM4 Erika Violet Adapters	SM Blue Adapters	SM/APC Green Adapters
MPO Type-A (Key-Up/Key-Down)						
18	FX UHD	–	FF3H18MP	FF4H18MP	–	FFSH18MP
12	FX Ultra	–	FF3U12MP	FF4U12MP	–	FFSU12MP
LC Duplex						
18 (36)	FX UHD	–	FF3H18LD	FF4H18LD	FFSH18LD	FFSH18LA
12 (24)	FX Ultra	FF1U12LD	FF3U12LD	FF4U12LD	FFSU12LD	FFSU12LA
SC Duplex						
6 (12)	FX Ultra	FF1U06SD	FF3U06SD	FF4U06SD	FFSU06SD	FFSU06SA
SC Simplex						
12 (12)	FX Ultra	–	–	–	FFSU12SC	FFSU12SB
ST						
12 (12), Metal	FX Ultra	← FFSU12ST →				–

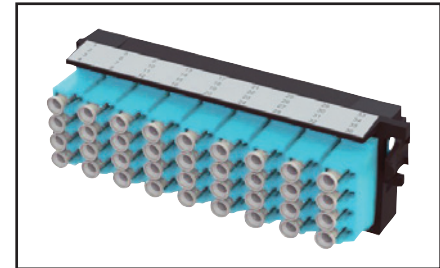

FF3H18LD, FX UHD Frame, OM3, 18 Ports, LC Duplex, Aqua Adapters

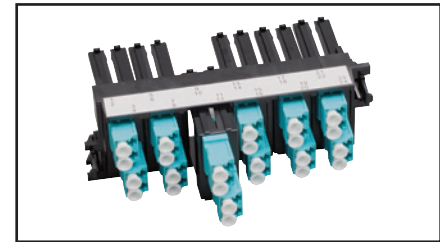

FF3U12LD, FX Ultra Frame, OM3, 12 Ports, LC Duplex, Aqua Adapters

Tailored FX UHD and FX Ultra Frames

Building a SmartPart Number

Fixed Letter Series	1. Choose Fiber Type	2. Choose Product Family	3. Choose Port Count	4. Choose Connector for Patch Side	5. Choose Adapter Color																																		
FF	3	H	18	LD	A																																		
	<table border="1"> <thead> <tr> <th>Fiber Type</th> <th>Product Family</th> </tr> </thead> <tbody> <tr> <td>1 OM1</td> <td>H FX UHD</td> </tr> <tr> <td>3 OM3</td> <td>U FX Ultra (1" Pull)</td> </tr> <tr> <td>4 OM4</td> <td></td> </tr> <tr> <td>S OS2</td> <td></td> </tr> </tbody> </table>	Fiber Type	Product Family	1 OM1	H FX UHD	3 OM3	U FX Ultra (1" Pull)	4 OM4		S OS2		<table border="1"> <thead> <tr> <th>Port Count (Patch Side)</th> </tr> </thead> <tbody> <tr> <td>03</td> </tr> <tr> <td>06</td> </tr> <tr> <td>12</td> </tr> <tr> <td>18</td> </tr> </tbody> </table>	Port Count (Patch Side)	03	06	12	18	<table border="1"> <thead> <tr> <th>Connector (Patch Side)</th> </tr> </thead> <tbody> <tr> <td>LD LC Duplex</td> </tr> <tr> <td>LA LC/APC Duplex</td> </tr> <tr> <td>LS LC Duplex w/Shutters</td> </tr> <tr> <td>SD SC Duplex</td> </tr> <tr> <td>SC SC Simplex</td> </tr> <tr> <td>SA SC/APC Duplex</td> </tr> <tr> <td>SB SC/APC Simplex</td> </tr> <tr> <td>SS SC Duplex w/ Shutters</td> </tr> <tr> <td>SR SC Simplex w/ Shutters</td> </tr> <tr> <td>ST ST</td> </tr> <tr> <td>MP MPO Up/Down</td> </tr> <tr> <td>MR MPO Up/Up</td> </tr> </tbody> </table>	Connector (Patch Side)	LD LC Duplex	LA LC/APC Duplex	LS LC Duplex w/Shutters	SD SC Duplex	SC SC Simplex	SA SC/APC Duplex	SB SC/APC Simplex	SS SC Duplex w/ Shutters	SR SC Simplex w/ Shutters	ST ST	MP MPO Up/Down	MR MPO Up/Up	<table border="1"> <thead> <tr> <th>Adapter Color</th> </tr> </thead> <tbody> <tr> <td>T Beige</td> </tr> <tr> <td>N Black</td> </tr> <tr> <td>A Aqua</td> </tr> <tr> <td>E Erika V.</td> </tr> <tr> <td>B Blue</td> </tr> <tr> <td>G Green</td> </tr> </tbody> </table>	Adapter Color	T Beige	N Black	A Aqua	E Erika V.	B Blue	G Green
Fiber Type	Product Family																																						
1 OM1	H FX UHD																																						
3 OM3	U FX Ultra (1" Pull)																																						
4 OM4																																							
S OS2																																							
Port Count (Patch Side)																																							
03																																							
06																																							
12																																							
18																																							
Connector (Patch Side)																																							
LD LC Duplex																																							
LA LC/APC Duplex																																							
LS LC Duplex w/Shutters																																							
SD SC Duplex																																							
SC SC Simplex																																							
SA SC/APC Duplex																																							
SB SC/APC Simplex																																							
SS SC Duplex w/ Shutters																																							
SR SC Simplex w/ Shutters																																							
ST ST																																							
MP MPO Up/Down																																							
MR MPO Up/Up																																							
Adapter Color																																							
T Beige																																							
N Black																																							
A Aqua																																							
E Erika V.																																							
B Blue																																							
G Green																																							

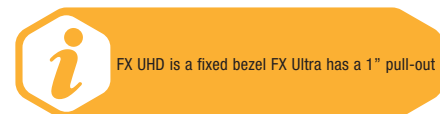

FiberExpress Patch Panel Systems (continued) FX UHD and FX Ultra Splitter Cassettes and TAP Cassettes



AX104681, FX UHD Housing (shown loaded from left to right with, FCSH12SBFS, FX UHD Splice Cassette, SCSH2116SLF, FX UHD Splitter Cassette, 2 x FCSH12LAFS, FX UHD Splice Cassettes)



SCSH2116SLF, FX UHD Splitter Cassette, OS2, Dual 1x16 Splitter, SC/APC Upstream Ports, LC/APC Downstream Ports



SCSU1208SLF, FX Ultra Splitter Cassette, OS2, Single 2x8 Splitter, SC/APC Upstream Ports, LC/APC Downstream Ports



TC4H044F4F4M, OM4 TAP Cassette, 4 Live A MPO (8f) Ports, 4 MPO (8f) TAP Ports

Splitter Cassette

Description (Upstream/Downstream)	Splitter	Belden Part Number
SC/APC to LC/APC	Single 2x8	SCSU1208SLF
SC/APC to LC/APC	Single 2x16	SCSU1216SLF
SC/APC to LC/APC	Dual 2x8	SCSU2208SLF
MPO/APC to LC/APC	Quad 2x8	SCSH4208MLF
LC/APC to LC/APC	Quad 1x8	SCSH4108LLF
LC/APC to LC/APC	Dual 2x16	SCSH2216LLF
SC/APC to LC/APC	Dual 1x16	SCSH2116SLF
SC/APC to LC/APC	Single 2x32	SCSH1232SLF

FX UHD and FX Ultra TAP (Traffic Analysis Port)

Belden's TAP cassettes allows for monitoring of communication over Fiber cables to ensure quality of service, and provide security/troubleshooting capabilities.

TAP Cassette

Belden Part Number			Number of Live A-Ports	TAP Ratio	Live A-Port	Live B-Port	TAP Port
OM4	OM4 (Aqua)	OM3					
TC4H06LDMFLD	TC4H06LDMFLD7A	TC3H06LDMFLD	6	70/30	LC Duplex	MPO Female (12f)	LC Duplex
TC4H02LDLDDL	TC4H02LDLDDL7A	TC3H02LDLDDL	2	70/30	LC Duplex	LC Duplex	LC Duplex
TC4H06LDMFMM	TC4H06LDMFMM7A	TC3H06LDMFMM	6	70/30	LC Duplex	MPO Female (12f)	MPO Male (12f)
TC4H044F4F4M	TC4H044F4F4M7A	TC3H044F4F4M	4	70/30	MPO Female (8f)	MPO Female (8f)	MPO Male (8f)

i Splitters beginning with the prefix "SCSU" represent Belden's FX Ultra cassette family. These cassettes feature our unique 1" pull-out feature that delivers superior ease of use for day-to-day MAC (moves, adds, and changes).

Faster.
Easier.
Better.



FiberExpress Patch Panel Systems (continued) FX UHD and FX Ultra Adapters and Accessories

Standard FX Ultra KeyConnect Frames

Patch Ports	Description	Belden Part Number
6	FX Ultra KeyConnect Frame 6-Port	FFZH06KC
8	FX Ultra KeyConnect Frame 8-Port	FFZH08KC

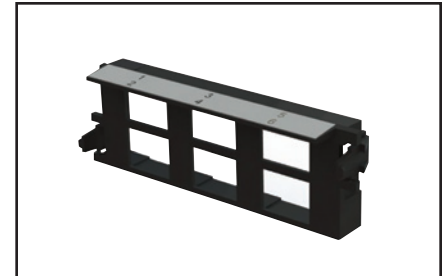

FFZH06KC, FX Ultra KeyConnect Frame, 6-Port

KeyConnect Fiber Modules

Description	Belden Part Number		
	Almond	Elec. White	Black
LC Duplex - OM3 (Aqua Adapter)	AX104937	AX104938	AX104939
LC Duplex - OM4 (Erika Violet Adapter)	AX105641-AL	AX105641-EW	AX105641-BK
SC Simplex OM1 (Beige Adapter)	AX102683	AX102684	AX102685
SC Simplex - OM3 (Aqua Adapter)	AX105643-AL	AX105643-EW	AX105643-BK
ST- Metal	AX102242	AX102243	AX102244

Standard Copper KeyConnect Adapters

Description	Belden Part Number		
	Black	Blue	White
10GX RJ45 Coupler	AX104024	AX104019	AX104023
10GX RJ45 Modular Jack	AX102283	AX102288	AX102282
CAT6+ RJ45 Coupler	AX104215	AX104210	AX104214
CAT6+ RJ45 Modular Jack	AX101321	AX101326	AX101320

Above adapters are for Black Bezels. Contact your local Belden representative for a complete listing of KeyConnect adapters in other colors.



AX104572, FX Color-coded Icon Kit, (shown on frame)

Standard FX UHD Accessories

Description	Belden Part Number
FX UHD Blank Plate	FFZH00BB
FX UHD Patch Cord Release Tool	AX104685
FX Ultra LC Duplex Color-coded Icon Kit	AX104572
FX UHD Fiber Management Spool kit, includes base plates and eight spool segments	AX105700
1U Rackmount Enclosure for Cable Tray Mounting	XPE-S0003
1U 19" to 23" Extender Bracket	9810-0100
2U 19" to 23" Extender Bracket	9811-0200
4U 19" to 23" Extender Bracket	9813-0400

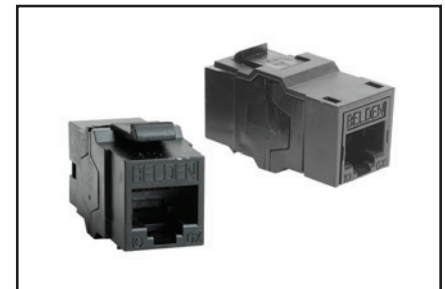

AX104024, 10GX RJ45 Coupler

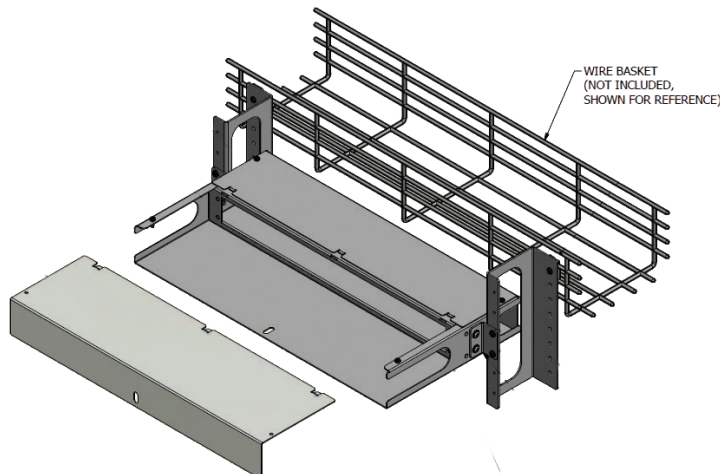

XPE-S0003, FX UHD Basket Hanger for 1U FX UHD Patch Panel Housings and Shelves.

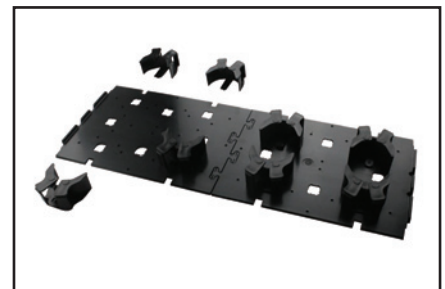

AX105700, FX UHD Fiber Management Spool Kit

FiberExpress Patch Panel Systems (continued)

FX UHD Wall Mount



AX106818, FX UHD Stackable Wall Mount Patch Panel

Clean, simple, lightweight wall mount unit that accepts all cassettes and frames from the FX UHD ecosystem. The FX UHD wall mount is a modular platform; A vertically stacked configuration creates an interconnect, while the patching spaces can be combined in a horizontal configuration to make a proper cross-connect. There are two separate compartments, one for the main service area (lockable) and one for the patching space. Ideal for MDUs and Passive Optical LAN applications.

FX UHD Wall Mount

Description	Belden Part Number
FX UHD Wall Mount Patch Panel, Black	AX106817
FX UHD Wall Mount Patch Panel, Gray	AX106818

4 cassettes; 4 frames; 48 fibers (SC, SCD, ST, LCD); 4 FXU Fusion Trays, 8-inch (AX103912)



AX103928, FX Ultra Stackable Wall Mount Patch Panel

FX Ultra Wall Mount and Accessories

Resolute protection while maintaining the utmost adaptability. Complete selection of fiber enclosures provides effortless security and protection while leveraging both the flexibility and density of the FX UHD frames and cassettes.

FASTER

- Faster installation with easy access and lightweight housing
- Faster installation with pre-terminated cassettes

EASIER

- Easier configuration with FX UHD and FX Ultra modules in LC, SC and ST
- Easier security with optical door lock
- Easier expansion with stackable design

BETTER

- Better with support for Pre-Term and Field-Term including splicing
- Better management with independent doors for trunk and patching sides
- Better density with up to 36 LC Duplex ports



AX103930, FX Ultra Wall Mount Splice Enclosure

FX Ultra Wall Mount

Description	Number of Module Bays	Splice Trays	Belden Part Number
Stackable Wall Mount Patch Panel, Black	2	2 x 8" (Up to 48-Splices)	AX103928
Stackable Wall Mount Splice Enclosure	0	4 x 10" (Up to 144-Splices)	AX103930

Splice trays sold separately



AX103928 and AX103932, FX Ultra Wall Mount Patch Panel with Spacer

FX Ultra Splice Trays

Description	Splices per Tray	Belden Part Number
8" Splice Tray	24	AX103912
10" Splice Tray	36	AX103913

All splice trays accommodate 2.5 mm OD single fiber splice protectors up to 80 mm in length or part number FXFUHS900AB25

FX Ultra Wall Mount Accessories

Description	Belden Part Number
2-inch Spacer, Black	AX103932
Door Lock Kit	AX103934

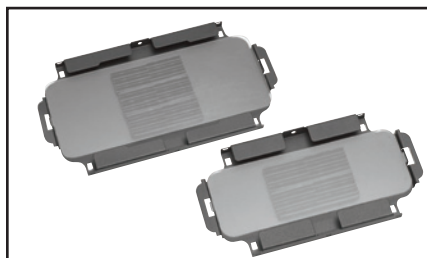

FX Ultra Splice Trays

Faster.
Easier.
Better.



FiberExpress Patch Panel Systems (continued) FX Patch Rack Mount, Wall Mount Patch Panels, Adapter Strips and Accessories

Economical yet effective. Low to medium density rack mount fiber panels with simple adapter strips are the mainstay for fiber field termination.

FASTER

- Faster access to rear side (trunk) connectivity without removing patch cords

EASIER

- Easier on the budget with economical adapter strips
- Easier access to the trunk side connectivity with swing out faceplate

BETTER

- Better support for mixed field-term connectivity including splicing
- Better use of valuable space through a compact footprint

Rack Mount Patch Panels

Description	Maximum Number of Adapter Strips	Splice Trays	Belden Part Number
1U Rack Mount	2	1 x 8" (Up to 24-Splices)	AX100041
2U Rack Mount	4	2 x 8" (Up to 48-Splices)	AX100068
3U Rack Mount (Rear Access)	4	2 x 8" (Up to 48-Splices)	AX104934
4U Rack Mount	8	4 x 8" (Up to 96-Splices)	AX100116

Wall Mount Patch Panels

Description	Maximum Number of Adapter Strips	Splice Trays	Belden Part Number
Small Wall-Mount	2	1 x 8" (Up to 24-Splices)	AX100495
Medium Wall-Mount	4	2 x 8" (Up to 48-Splices)	AX100540
Large Wall-Mount	8	4 x 8" (Up to 96-Splices)	AX100542

Standard Optical Fiber Adapter Strips

		Belden Part Number			
Patch Ports (fibers)	Family	OM1 Beige Adapters	OM3 Aqua Adapters	SM Blue Adapters	SM/APC Green Adapters
LC Duplex					
12 (24)	FX Patch	AX101741	–	AX101743	AX105561
6 (12)	FX Patch	AX101729	–	AX101731	AX105537
SC Duplex					
6 (12)	FX Patch	AX100098	–	AX101409	AC301420
3 (6)	FX Patch	AX100094	–	AX101407	–
SC Simplex					
12 (12)	FX Patch	–	–	AX100532	AC302349
ST					
12 (12)	FX Patch	← AX100528 →			–
6 (6)	FX Patch	← AX100534 →			–

Standard Optical Fiber Accessories

Description	Belden Part Number
FX Patch Blank Strip	AX100066
1U Front Cover, Smoked Plexiglas	AX100045
8" Splice Kit (Tray, Holders, Wiremarkers & Cover)	A0649869

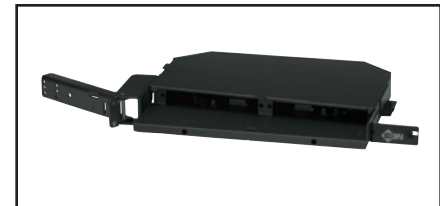

AX100041, FX 12/24 Port (1U) Rack Mount Patch Panel

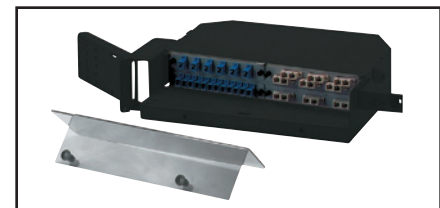

AX100068, FX 24/48 Port (2U) Rack Mount Patch Panel (shown loaded)



AX104934, FX (3U) Rack Mount Patch Panel (Rear Access) (shown loaded)



AX100116, FX 48/96 Port (4U) Rack Mount Patch Panel (shown loaded)



AX100495, Small Wall Mount

FiberExpress Pre-Terminated Assemblies FX Patch Cords



FX MPO-12(f) Patch Cords, Assortment

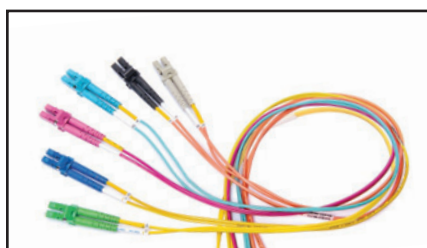

FX LC Duplex Patch Cords, Assortment

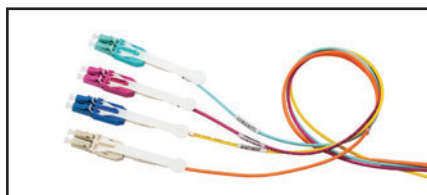

FX LC Duplex UHD Uniboot Patch Cords, Assortment

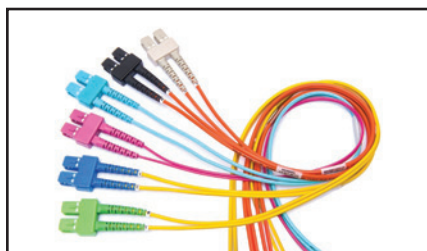

FX SC Duplex Patch Cords, Assortment

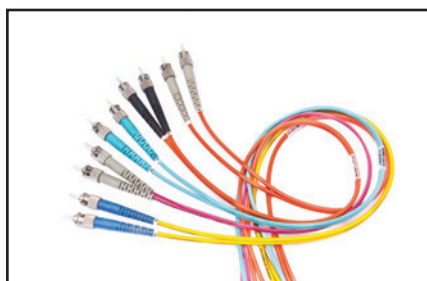

FX ST Patch Cords, Assortment

Uncomplicated, robust, versatile and conveniently available. Superior quality and performance FX patch cords deliver a robust design to withstand the rigours of daily use in both off-the-shelf standard configurations and rapid custom tailored installations.

FASTER

- Faster delivery with off-the shelf availability of standard items
- Faster identification of fiber type with Erika Violet for OM4 cable and connectors

EASIER

- Easier installation in dense cable trays with small diameter cord options
- Easier ordering with simple intelligent *SmartPart* Numbers
- Easier polarity management with industry leading easy-to-use duplex clips

BETTER

- Better architectural flexibility with low-loss OM4 0.2 dB MPO and 0.15 dB LC connectors
- Better ruggedization with larger diameter cord options
- Better flexibility with multiple connector options including LC, SC, ST and MPO
- Better quality through exhaustive design validation against TIA standards

FX Patch Cords - Standard Performance

Description	FX OM1	FX OM3	FX OM4	FX SM	FX SM/APC
Cable Performance - LC/SC/ST					
IL Max. 850 nm/1300 nm (dB/Km)	3.5/1.2	3.25/1.2	3.0/1.2	-	
IL Max. 1310 nm/1550 nm (dB/Km)	-	-	-	0.5/0.5	
Fire Rating	LC/SC/ST: Riser				
Cable Style	LC: Interconnect Duplex Zip 2 mm LC Uniboot: Interconnect Mini-Round 2 mm SC/ST/Hybrid: Interconnect Duplex Zip 3 mm				
Connector Performance - LC/SC/ST					
IL Max. (dB)	0.25	0.25	0.15	0.35	0.35
Polish - RL Typ. (dB)	PC - 30	PC - 30	PC - 30	UPC - 55	APC - 65
Polarity	A-T0-B / B-T0-A				
Cable Performance - MPO					
IL Max. 850 nm/1300 nm (dB/Km)	3.5/1.2	3.25/1.0	3.0/1.0	-	
IL Max. 1310 nm/1550 nm (dB/Km)	-	-	-	0.5/0.5	
Fire Rating	Plenum				
Cable Style	MPO-12: Interconnect Mini-Round 2 mm				
Connector Performance - MPO					
IL Max. (dB)	0.5	0.35	0.2	-	0.75
Polish - RL Typ. (dB)	PC - 30	PC - 30	PC - 30	-	APC - 60
Polarity	Type-B				

FX Accessory Duplex Clips

Description	Belden Part Number				
	OM1 Beige	OM3 Aqua	OM4 Erika Violet	OS2 Blue	OS2 Green
LC Duplex	FXFACLLDB25T	FXFACLLDB25A	FXFACLLDB25E	FXFACLLDB25B	FXFACLLDB25G
Mini-LC Duplex	FXFACLLMB25N (Black)				

Faster.
Easier.
Better.

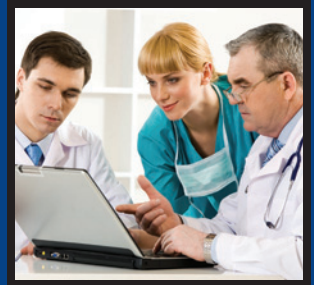

FiberExpress Pre-Terminated Assemblies (continued) FX Patch Cords

Standard FX Patch Cords

Length (m)	OM1 Beige/Orange	OM3 Aqua	OM4 Erika Violet	OS2 Blue/Yellow	OS2/APC Green/Yellow
MPO-12(8f) Female to MPO-12(8f) Female - Base8					
2	-	FP34F4F002M	FP44F4F002M	-	FPS4F4F002M
3	-	FP34F4F003M	FP44F4F003M	-	FPS4F4F003M
5	-	FP34F4F005M	FP44F4F005M	-	FPS4F4F005M
MPO-12(12f) Female to MPO-12(12f) Female - Base12					
2	-	FP3MFMF002M	FP4MFMF002M	-	FPSMFMF002M
3	-	FP3MFMF003M	FP4MFMF003M	-	FPSMFMF003M
5	-	FP3MFMF005M	FP4MFMF005M	-	FPSMFMF005M
MPO-24 Female to MPO-24 Female					
2	-	FP3NFNF002M	FP4NFNF002M	-	FPSNFNF002M
3	-	FP3NFNF003M	FP4NFNF003M	-	FPSNFNF003M
5	-	FP3NFNF005M	FP4NFNF005M	-	FPSNFNF005M
LC Duplex UHD Uniboot to LC Duplex UHD Uniboot					
2	-	FP3LULU002M	FP4LULU002M	FPSLULU002M	-
3	-	FP3LULU003M	FP4LULU003M	FPSLULU003M	-
5	-	FP3LULU005M	FP4LULU005M	FPSLULU005M	-
LC Duplex to LC Duplex					
2	FP1LDLD002M	FP3LDLD002M	FP4LDLD002M	FPSLDLD002M	FPSLALA002M
3	FP1LDLD003M	FP3LDLD003M	FP4LDLD003M	FPSLDLD003M	FPSLALA003M
5	FP1LDLD005M	FP3LDLD005M	FP4LDLD005M	FPSLDLD005M	FPSLALA005M
SC Duplex to SC Duplex					
2	FP1SDSD002M	FP3SDSD002M	FP4SDSD002M	FPSSDSD002M	FPSASA002M
3	FP1SDSD003M	FP3SDSD003M	FP4SDSD003M	FPSSDSD003M	FPSASA003M
5	FP1SDSD005M	FP3SDSD005M	FP4SDSD005M	FPSSDSD005M	FPSASA005M
ST to ST (Duplex Cord)					
2	FP1STST002M	FP3STST002M	FP4STST002M	FPSSTST002M	-
3	FP1STST003M	FP3STST003M	FP4STST003M	FPSSTST003M	-
5	FP1STST005M	FP3STST005M	FP4STST005M	FPSSTST005M	-
Hybrid: LC Duplex to SC Duplex					
2	FP1LDSD002M	FP3LDSD002M	FP4LDSD002M	FPSLDSD002M	FPSLASA002M
3	FP1LDSD003M	FP3LDSD003M	FP4LDSD003M	FPSLDSD003M	FPSLASA003M
5	FP1LDSD005M	FP3LDSD005M	FP4LDSD005M	FPSLDSD005M	FPSLASA005M
Hybrid: SC Duplex to ST					
2	FP1LDST002M	FP3LDST002M	-	FPSLDST002M	-
3	FP1LDST003M	FP3LDST003M	-	FPSLDST003M	-
5	FP1LDST005M	FP3LDST005M	-	FPSLDST005M	-
LC Simplex UHD to LC Simplex UHD, Simplex cord					
2	-	-	-	FPSLILIO02M	FPSLFLF002M
3	-	-	-	FPSLILIO03M	FPSLFLF003M
5	-	-	-	FPSLILIO05M	FPSLFLF005M



FP4LULU003M, LC Duplex UHD Uniboot to LC Duplex UHD Uniboot, OM4 Erika Violet



FP4LDLD003M, LC Duplex to LC Duplex, Duplex Zip Cord, OM4 Erika Violet

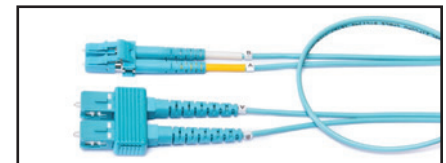

FP3LSDSD003M, Hybrid LC Duplex to SC Duplex, OM3 Aqua

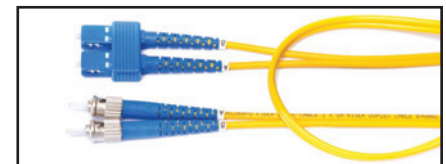

FPSSDST003M, Hybrid SC Duplex to ST, OS2 Blue



FPSLILIO05M, LC Simplex UHD to LC Simplex UHD, OS2 Yellow

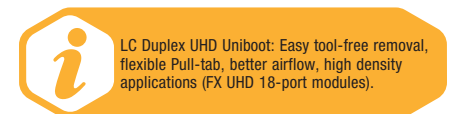

FiberExpress Pre-Terminated Assemblies (continued) FX Patch Cords

Standard FX Patch Cords

FX Patch Cord FP	1. Choose Fiber Type 3	2. Choose Connector 1 LD	3. Choose Connector 2 LD	4. Choose Length* 003M
	Fiber Type	Connector 1	Connector 2	Length*
	1 OM1	LD LC Duplex	LD LC Duplex	00M3 to 015M *use M as decimal
	3 OM3	LC LC/APC Duplex	LA LC/APC Duplex	
	4 OM4	LH LC Duplex UHD	LH LC Duplex UHD	
	S OS2	LI LC Duplex UHD	LI LC Simplex UHD	
		LU LC Duplex UHD Uniboot	LU LC Duplex UHD Uniboot	
		LE LC/APC Duplex UHD	LE LC/APC Duplex UHD	
		LF LC/APC Simplex UHD	LF LC/APC Simplex UHD	
		SD SC Duplex	SD SC Duplex	
		SA SC/APC Duplex	SA SC/APC Duplex	
		ST ST	ST ST	
		4F MPO-12 (F) Base 8	4F MPO-12 (F) Base 8	
		MF MPO-12 (F)	MF MPO-12 (F)	
		NF MPO-24 (f)	NF MPO-24 (f)	

Tailored FX Patch Cords

FX Patch Cord FP	1. Choose Fiber Type 3	2. Choose Connector 1 LD	3. Choose Connector 2 LD	4. Choose Length* 003M	5. Choose Fire Rating R	6. Choose Cable Construction 3	7. Choose Polarity X	8. Choose Jacket Color A
Fiber Type	Connector 1	Connector 2	Length*	Fire Rating	Cable Construction	Polarity	Jacket Color	
1 OM1	LD LC Duplex	LD LC Duplex	00M3 to 300M M Meters use M as decimal	R Riser	2 Duplex ZipCord 2.0 mm	X A/B (Cross)	O Orange	
2 OM2	LC LC Simplex	LC LC Simplex		P Plenum	3 Duplex ZipCord 3.0 mm	S A/A (Straight)	Y Yellow	
3 OM3	LM Mini-LC Duplex	LM Mini-LC Duplex		L LSZH	4 Simplex Cord 2.0 mm	A Type-A	A Aqua	
4 OM4	LA LC/APC Duplex	LA LC/APC Duplex			5 Simplex Cord 3.0 mm	B Type-B	E Erika V.	
S OS2	LB LC/APC Simplex	LB LC/APC Simplex			6 Round 2.0 mm	C Type-C		
	LH LC Duplex UHD	LH LC Duplex UHD			7 Round 3.0 mm			
	LI LC Simplex UHD	LI LC Simplex UHD						
	LU LC Duplex UHD Uniboot	LU LC Duplex UHD Uniboot						
	LE LC/APC Duplex UHD	LE LC/APC Duplex UHD						
	LF LC/APC Simplex UHD	LF LC/APC Simplex UHD						
	SD SC Duplex	SD SC Duplex						
	SC SC Simplex	SC SC Simplex						
	SA SC/APC Duplex	SA SC/APC Duplex						
	SB SC/APC Simplex	SB SC/APC Simplex						
	ST ST	ST ST						
	4M MPO-12 (M) Base 8	4M MPO-12 (M) Base 8						
	4F MPO-12 (F) Base 8	4F MPO-12 (F) Base 8						
	MM MPO-12 (M)	MM MPO-12 (M)						
	MF MPO-12 (F)	MF MPO-12 (F)						
	NM MPO-24 (m)	NM MPO-24 (m)						
	NF MPO-24 (f)	NF MPO-24 (f)						
	ZZ OPEN	ZZ OPEN						

Examples:
FP3LULU020MR6XA - FX Patch Cord, OM3, LC Duplex UHD Uniboot - LC Duplex UHD Uniboot, 20 m, OFNR, Round 2.0 mm, A-to-B, Aqua Jacket
FP4LDLD030MR2XE - FX Patch Cord, OM4, LC Duplex - LC Duplex, 30 m, OFNR, Duplex Zip 2.0 mm, A-to-B, Erika Violet Jacket
FP4LDLD030MR2XE - FX Patch Cord, OS2, SC Duplex - SC Duplex, 5 m, OFNP, Duplex Zip 3.0 mm, A-to-B, Yellow Jacket
FP3LDLH010MR2XA - FX Patch Cord, OM3, LC Duplex - LC Duplex UHD, 10 m, OFNR, Duplex Zip 2.0 mm, A-to-B, Aqua Jacket
FP4MFMF005MP6AE - FX Patch Cord, OM4, MPO-12 (F) - MPO-12 (F), 5 m, OFNP, Round 2.0 mm, Type-A, Erika Violet Jacket

Please contact Belden for any help configuring/validating SmartPart Numbers or for any other custom Engineered solutions

Faster.
Easier.
Better.



FiberExpress Pre-Terminated Assemblies (continued) FX Hydra Patch Cords

Uniquely suited within dense fixed environments. Compact alternative for statically configured patch cords and pre-term cassettes eliminates connection points to improve performance and alleviate space constraints.

FASTER

- Faster deployment at the switch with MPO to LC fanout construction

EASIER

- Easier upgradability from 10G to 40G or 100G with MPO connectivity

BETTER

- Better identification of fiber type with Erika Violet for OM4 cable and connectors
- Better airflow with small transition point construction



FP4LUMF002M, FX Hydra Patch Cord, OM4, MPO-12F (F) to 6 x LC Duplex UHD Uniboot, 2 m

FX Hydra Assemblies - Standard Performance

Description	FX OM3	FX OM4	FX SM	FX SM/APC
Cable Performance - LC/SC/ST				
IL Max. 850 nm/1300 nm (dB/Km)	3.25/1.0	3.0/1.0		–
IL Max. 1310 nm/1550 nm (dB/Km)	–	–		0.5/0.5
Fire Rating	Plenum			
Cable Style	MPO: Interconnect Mini-Round 3.0 mm LC Uniboot: Interconnect Mini-Round 2.0 mm LC: Interconnect Simplex Zip 2.0 mm			
Connector Performance - LC				
IL Max. (dB)	0.25	0.15	0.35	0.35
Polish - RL Typ. (dB)	PC - 30	PC - 30	UPC - 55	APC - 65
Fanout Length	0.5 m, In-Line			
Connector Performance - MPO				
IL Max. (dB)	0.35	0.2	–	0.75
Polish - RL Typ. (dB)	PC - 30	PC - 30	–	APC - 60
Polarity	Type-A			

See duplex clips on page 18



FP4LDMF002M, FX Hydra Patch Cord, OM4, MPO-12F (F) to 6 x LC Duplex, 2 m

Standard FX Hydra Assemblies

Description	OM3 Aqua	OM4 Erika Violet	OS2 Blue/Yellow
Base12 Duplex			
MPO-12(12f) Female to 6 x LC Duplex UHD Uniboot, 0.5 m In-Line Fanout, 2 m in length	FP3LUMF002M	FP4LUMF002M	FPSLUMF002M
MPO-12(12f) Female to 6 x LC Duplex UHD Uniboot, 0.5 m In-Line Fanout, 3 m in length	FP3LUMF003M	FP4LUMF003M	FPSLUMF003M
MPO-12(12f) Female to 6 x LC Duplex UHD Uniboot, 0.5 m In-Line Fanout, 5 m in length	FP3LUMF005M	FP4LUMF005M	FPSLUMF005M
Base8 Duplex for SR4 (QSFP+/QSFP28) Transceivers			
MPO-12(8f) Female to 4 x LC Duplex UHD Uniboot, 0.5 m In-Line Fanout, 2 m in length	FP3LU4F002M	FP4LU4F002M	FPSLU4F002M
MPO-12(8f) Female to 4 x LC Duplex UHD Uniboot, 0.5 m In-Line Fanout, 3 m in length	FP3LU4F003M	FP4LU4F003M	FPSLU4F003M
MPO-12(8f) Female to 4 x LC Duplex UHD Uniboot, 0.5 m In-Line Fanout, 5 m in length	FP3LU4F005M	FP4LU4F005M	FPSLU4F005M

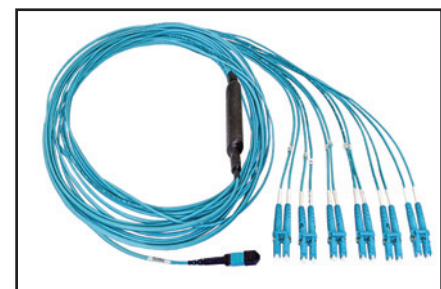

FP3LDMF002M, FX Hydra Patch Cord, OM3, MPO-12F (F) to 6 x LC Duplex, 2 m

FiberExpress Pre-Terminated Assemblies (continued) FX Hydra Patch Cords

Standard FX Hydra Patch Cords

FX Patch Cord: **FP**

1. Choose Fiber Type: **3**

2. Choose Connector 1: **LD**

3. Choose Connector 2: **MF**

4. Choose Length*: **003M**

Fiber Type	
3	OM3
4	OM4
S	OS2

Connector 1	
LD	LC Duplex
LM	Mini-LC Duplex
LA	LC/APC Duplex
LH	LC Duplex UHD
LU	LC Duplex UHD Uni
LE	LC/APC Duplex UHD

Connector 2	
MM	MPO-12 (m)
MF	MPO-12 (f)
4M	MPO-12 (M) Base 8
4F	MPO-12 (F) Base 8

Length*	
001M to 015M *use M as decimal	

Tailored FX Hydra Patch Cords

FX Patch Cord: **FP**

1. Choose Fiber Type: **3**

2. Choose Connector 1: **LD**

3. Choose Connector 2: **MF**

4. Choose Length: **003M**

5. Choose Fire Rating: **P**

6. Choose Cable Construction: **7**

7. Choose Polarity: **A**

8. Choose Jacket Color: **A**

Fiber Type	
1	OM1
2	OM2
3	OM3
4	OS4
S	OS2

Connector 1	
LD	LC Duplex
LC	LC Simplex
LM	Mini-LC Duplex
LA	LC/APC Duplex
LB	LC/APC Simplex
LH	LC-Duplex UHD
LJ	LC-Simplex UHD
LU	LC-Duplex UHD Uni
LE	LC/APC Duplex UHD
LF	LC/APC Simplex UHD
SD	SC Duplex
SC	SC Simplex
SA	SC/APC Duplex
SB	SC/APC Simplex
ST	ST

Connector 2	
MM	MPO-12 (m)
MF	MPO-12 (f) Female
4M	MPO-12 (M) Base 8
4F	MPO-12 (F) Base 8

Length	
001M to 300M *use M as decimal	

Fire Rating	
P	Plenum
L	LSZH

Cable Construction	
7	Round 3.0 mm

Polarity	
A	Type-A (Straight Polarity)
B	Type-B (Reversed Polarity)
4	SR4

Jacket Color	
O	Orange
Y	Yellow
A	Aqua
E	Erika V.

Examples:

FP3LDMF020MP7AA - FX Patch Cord, OM3, 6 x LC Duplex - MPO-12 (F), 20 m, OFNP, Round 3.0 mm, Type-A, Aqua Jacket

FP4LUMM010MP7AA - FX Patch Cord, OM4, 6 x LC Duplex UHD Uniboot - MPO-12 (M), 10 m, OFNP, Round 3.0 mm, Type-A, Aqua Jacket

FP5LHMF005MP7BY - FX Patch Cord, OM2, 6 x LC Duplex UHD - MPO-12 (F), 5 m, OFNP, Round 3.0 mm, Type-B, Yellow Jacket

FP3LDM005MP7BA - FX Patch Cord, OM3, 6 x LC Duplex - MPO-12 (M), 5 m, OFNP, Round 3.0 mm, Type-B, Aqua Jacket

FP4LDMF025MP7AE - FX Patch Cord, OM4, 6 x LC Duplex - MPO-12 (F), 25 m, OFNP, Round 3.0 mm, Type-A, Erika Violet Jacket

Please contact Belden for any help configuring/validating SmartPart Numbers or for any other custom Engineered solutions

FX Hydra Assembly SR4 Polarity MPO-12 8 Fiber (Base8)

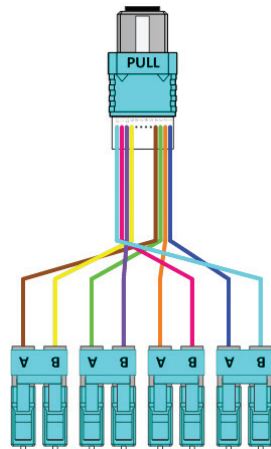

FX Hydra Assembly Type A Polarity MPO-12 12 Fiber (Base12)

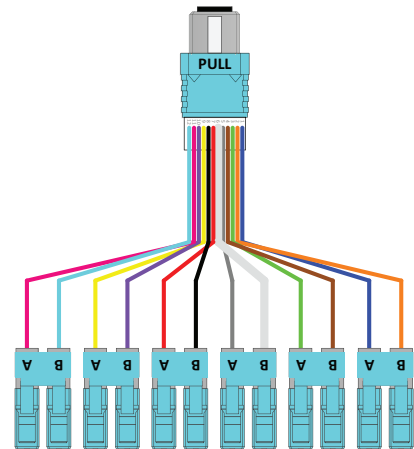

Faster.
Easier.
Better.



FiberExpress Pre-Terminated Assemblies (continued) FX MPO Trunk Assemblies

Innovative performance with ingrained simplicity. Industry-leading low-loss MPO Trunks are the foundation of Easier, Faster and Better pre-terminated fiber connectivity solutions revolutionizing the data center.

FASTER

- Faster identification of fiber type with Erika Violet for OM4 Cable, Connectors and Adapters
- Faster installation with pre-terminated solutions

EASIER

- Easier installation with 3-flange real and default pulling eye
- Easier ordering with simple intelligent *SmartPart* Numbers
- Easier upgradability to 40G and 100G with MPO pre-term solutions

BETTER

- Better architectural flexibility with high-performance 0.2 dB OM4 MPO connectors
- Better quality through exhaustive design validation against TIA standards
- Better contamination control with Data Center ready packaging



FM4MMB20025M, FX MPO Trunk, OM4, MPO-12 (Male to Male), Type-B, 2 x MPO-12 (24 fibers), 15 m, OFNP, uMini-Distribution, Fanout: 0.5 m x In-Line, Erika Violet Jacket



FM4MMB1010M, FX MPO Trunk, OM4, MPO-12 (Male to Male), Type-B, 1 x MPO-12 (12 fibers), 10 m, OFNP, Mini-Distribution 4.8 mm (Double-Jacket), Erika Violet Jacket

FX MPO Trunk Assemblies - Standard Performance

Description	FX OM1	FX OM3	FX OM4	FX SM
Cable Performance				
IL Max. 850 nm/1300 nm (dB/Km)	3.5/1.2	3.25/1.0	3.0/1.0	-
IL Max. 1310 nm/1550 nm (dB/Km)	-	-	-	0.35/0.25
Fire Rating	Plenum			
Cable Style	uMini-Distributon and Mini-Distribution cables			
Connector Performance - MPO-12				
IL Max. (dB)	0.5	0.35	0.2	0.75
Polish - RL Typ. (dB)	PC - 30	PC - 30	PC - 30	APC - 60
Fanout Length	0.5 m, In-Line			
Connector Performance - MPO-24				
IL Max. (dB)	0.5	0.35	0.35	0.75
Polish - RL Typ. (dB)	PC - 30	PC - 30	PC - 30	APC - 60

Pulling Eye Diameter

Description	12-Fiber	24-Fiber	36-Fiber	48-Fiber	72-Fiber	96-Fiber	144-Fiber
Installation Diameter - MPO-12 (Total Connectors)							
1 Connector per Bundle, 8 cm Bundle Stagger	1	2	3	4	6	8	12
1 Connector per Bundle, 8 cm Bundle Stagger		19.5 mm	19.5 mm	19.5 mm	19.5 mm	19.5 mm	19.5 mm
2 Connectors per Bundle, 8 cm Bundle Stagger				25.4 mm	25.4 mm	25.4 mm	25.4 mm
3 Connectors per Bundle, 8 cm Bundle Stagger					30.0 mm	30.0 mm	30.0 mm
4 Connectors per Bundle, 8 cm Bundle Stagger						31.7 mm	31.7 mm
6 Connectors per Bundle, 8 cm Bundle Stagger							38.1 mm
One Bundle, No Stagger (in-line)	19.5 mm	25.4 mm	30.0 mm	31.7 mm	38.1 mm	41.9 mm	50.8 mm

i Standard FX MPO Trunks 12F (Indoor) have a more robust cable construction using a Mini-Distribution cable (Double jacket 4.8 mm). They are designed for safe pulling, and to withstand the rigors of installation while providing sufficient support (wire basket support).

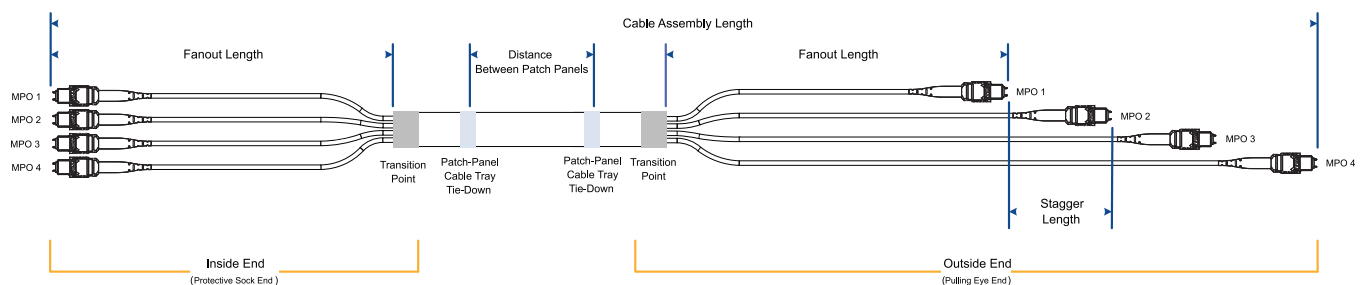

FiberExpress Pre-Terminated Assemblies (continued) FX MPO Trunk Assemblies

Standard FX MPO Trunks - Base 12

FX MPO Trunk	1. Choose Fiber Type	2. Choose Connectors	3. Connector Gender	4. Choose Polarity	5. Choose Connector Count	6. Choose Length
FM	3	M	M	B	3	010M

Fiber Type	Connectors	Connector Gender	Polarity (outside)	Connector Count	Length
3 OM3	M MPO-12(12F)	M Male to Male	A Type-A	1 12 Fibers	005M to 500M M Meters *use M as decimal
4 OM4		F Female to Female	B Type-B	2 24 Fibers	
S OS2		E Extension (M to F)	C Type-C	3 36 Fibers	
		P Male to Open		4 48 fibers	
		R Female to Open		6 72 Fibers	
				8 96 Fibers	
				D 144 Fibers	

Examples:

FM3MMB1010M - FX MPO Trunk OM3, MPO-12 (Male to Male), Type-B, 1 MPO (12 Fibers), 10 m, OFNP, Mini-Distribution 4.8 mm (Double-Jacket), Aqua Jacket.

FM4MMB4030M - FX MPO Trunk OM4, MPO-12 (Male to Male), Type-B, 4 MPO (48 Fibers), 30 m, OFNP, Mini-Distribution (2.0 mm Sub-Units) Fan-Out: 0.5 m In-Line, Erika Violet Jacket.

FMSMFAD025M - FX MPO Trunk OS2, MPO-12 (Female to Female), Type-A, 12 MPO (144 Fibers), 25 m, OFNP, Mini-Distribution (2.0 mm Sub-Units) Fan-Out: 0.5 m In-Line, Yellow Jacket.

Tailored FX MPO Trunks - Base12

FX MPO Trunk	1. Choose Fiber Type	2. Choose Connectors	3. Choose Connector Gender	4. Choose Polarity (outside)	5. Choose Connector Count (per side)	6. Choose Length	7. Choose Fire Rating	8. Choose Cable Construction	9. Choose Fan-Out Length & Geometry	10. Choose Jacket Color
FM	3	M	M	B	4	010M	P	M	E	A

Fiber Type	Connectors	Connector Gender	Polarity (outside)	Connector Count	Length	Fire Rating	Cable Construction	Fan-Out Geometry	Jacket Color
1 OM1	M MPO-12 (12F)	M Male to Male	A Type-A	1 12 Fibers	005M to 500M M Meters *use M as decimal	P Plenum	U uMini-D	D None (1 Conn.)	O Orange
2 OM2		F Female to Female	B Type-B	2 24 Fibers		I I/O Plenum		M Mini-D	D 0.5 m x In-Line (>2 Conn.)
3 OM3		E Extension (M to F)	C Type-C	3 36 Fibers		A Plenum Armored (AIA)		E 1.0 m x In-Line	Y Yellow
4 OM4		P Male to Open		4 48 Fibers		B Plenum I/O Armored (AIA)		F 1.5 m x In-Line	A Aqua
S OS2		R Female to Open		6 72 Fibers		L LSZH		G 2.0 m x In-Line	E Erika Violet
				8 96 Fibers			1 0.5 m x Stag 80 mm/1 conn.		
				D 144 Fibers			2 0.5 m x Stag 80 mm/2 conn.		
							3 0.5 m x Stag 80 mm/3 conn.		
							4 0.5 m x Stag 80 mm/4 conn.		
							N No Pulling Eye		
							B Pulling Eye at both ends		

Use of Tailored part numbers:

- Fiber Type: For any OM1 and OM2 trunk.
- Fire Rating: For any Plenum Armored, I/O Plenum, I/O Plenum Armored, LSZH trunks.
- Cable Construction:

M Mini-Distribution cable used for indoor Plenum 2F (1 conn.), for I/O Plenum, for Plenum Armored, for I/O Plenum Armored and LSZH.

U uMini-Distribution cable used for indoor Plenum=>24F (>=2 conn.).

- Fan-Out Length & Geometry: Different fan-out lengths and stagger options, No Pulling Eye, Pulling eye at both ends.

Examples:

FM3MMB1010MPMNA - FX MPO Trunk OM3, MPO-12 (Male to Male), Type-B, 1 MPO (12 Fibers), 10 m, OFNP, Mini-Distribution 4.8 mm (Double-Jacket), No Pulling Eye, Aqua Jacket.

FM4MMB4020MAMDE - FX MPO Trunk OM4, MPO-12 (Male to Male), Type-B, 4 MPO (48 Fibers), 20 m, OFCP, (Plenum Armored), Mini-Distribution (3.0 mm Sub-Units) Fan-Out: 0.5 m In-Line, Erika Violet Jacket.

FMSMFA2030MPM1Y - FX MPO Trunk OS2, MPO-12 (Female to Female), Type-A, 2 MPO (24 Fibers), 30 m, OFNP, Mini-Distribution (3.0 mm Sub-Units) Fan-Out: 0.5 m Staggered 80 mm/1 CONN, Yellow Jacket.

Please contact Belden for any help configuring/validating SmartPart Numbers or for any other custom Engineered solutions

Faster.
Easier.
Better.



FiberExpress Pre-Terminated Assemblies (continued) FX MPO Trunk Assemblies

Standard FX MPO Trunks - Base 8

FX MPO Trunk	1. Choose Fiber Type	2. Choose Connectors	3. Connector Gender	4. Choose Polarity	5. Choose Connector Count	6. Choose Length
FM	3	M	M	B	3	010M

Fiber Type	Connectors	Connector Gender	Polarity (outside)	Connector Count	Length
3 OM3	4 MPO-12 (8F)	M Male to Male	A Type-A	1 8 Fibers	005M to 500M M Meters <small>*use M as decimal</small>
4 OM4		F Female to Female	B Type-B	2 16 Fibers	
S OS2		E Extension (M to F)	C Type-C	3 24 Fibers	
		P Male to Open		4 32 Fibers	
		R Female to Open		6 48 Fibers	
				8 64 Fibers	
				D 96 Fibers	

Examples:

FM3MMB1010M - FX MPO Trunk OM3, MPO-12 Base 8 (Male to Male), Type-B, 1 MPO (8 Fibers), 10 m, OFNP, Mini-Distribution 4.8 mm (Double-Jacket), Aqua Jacket.

FMS4FAD025M - FX MPO Trunk OS2, MPO-12 Base 8 (Female to Female), Type-A, 12 MPO (96 Fibers), 25 m, OFNP, Mini-Distribution (2.0 mm Sub-Units) Fan-Out: 0.5 m In-Line, Yellow Jacket.

Tailored FX MPO Trunks - Base 8

FX MPO Trunk	1. Choose Fiber Type	2. Choose Connectors	3. Choose Connector Gender	4. Choose Polarity (outside)	5. Choose Connector Count (per side)	6. Choose Length	7. Choose Fire Rating	8. Choose Cable Construction	9. Choose Fan-Out Length & Geometry	10. Choose Jacket Color
FM	3	M	M	B	3	010M	P	M	E	A

Fiber Type	Connectors	Connector Gender	Polarity (outside)	Connector Count	Length	Fire Rating	Cable Construction	Fan-Out Geometry	Jacket Color
3 OM3	4 MPO-12 (8F)	M Male to Male	A Type-A	1 8 Fibers	005M to 500M M Meters <small>*use M as decimal</small>	P Plenum	U uMini-D	D None (1 Conn.)	O Orange
4 OM4		F Female to Female	B Type-B	2 16 Fibers		I I/O Plenum		D 0.5 m x In-Line (>2 Conn.)	
S OS2		E Extension (M to F)	C Type-C	3 24 Fibers		A Plenum Armored (AIA)	M Mini-D	E 1.0 m x In-Line	Y Yellow
		P Male to Open		4 32 Fibers	B Plenum I/O Armored (AIA)		F 1.5 m x In-Line	A Aqua	
		R Female to Open		6 48 Fibers	L LSZH		G 2.0 m x In-Line	E Erika Violet	
				8 64 Fibers			1 0.5 m x Stag 80mm/1 conn.		
				D 96 Fibers			2 0.5 m x Stag 80mm/2 conn.		
							3 0.5 m x Stag 80mm/3 conn.		
							4 0.5 m x Stag 80mm/4 conn.		
							N No Pulling Eye		
							B Pulling Eye at both ends		

Examples:

FM34MB1010MPMNA - FX MPO Trunk OM3, MPO-12 Base 8 (Male to Male), Type-B, 1 MPO (8 Fibers), 10 m, OFNP, Mini-Distribution 4.8 mm (Double-Jacket), No Pulling Eye, Aqua Jacket.

FM44MB4020MAMDE - FX MPO Trunk OM4, MPO-12 Base 8 (Male to Male), Type-B, 4 MPO (32 Fibers), 20 m, OFCP, (Plenum Armored), Mini-Distribution (3.0 mm Sub-Units) Fan-Out: 0.5 m In-Line, Erika Violet Jacket.

Please contact Belden for any help configuring/validating SmartPart Numbers or for any other custom Engineered solutions

FiberExpress Pre-Terminated Assemblies (continued) FX Multi-Fiber Cable Assemblies

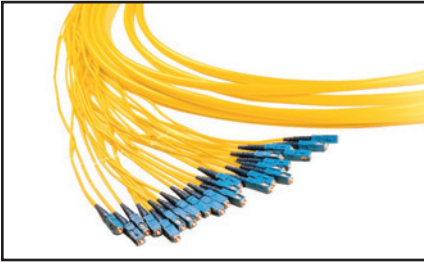

FX Multi-Fiber Cable Assembly

Superior consistent craftsmanship culminating in near instantaneous installation. Highly configurable multi-fiber pre-terminated cable assemblies are engineering for maximum performance and crafted ensuring superior quality.

FASTER

- Faster identification of fiber type with Erika Violet for OM4 cable, connectors and adapters
- Faster installation with pre-terminated solutions

EASIER

- Easier installation with 3-flange reel and default pulling eye
- Easier ordering with simple intelligent *SmartPart* Numbers

BETTER

- Better quality through exhaustive design validation against TIA standards
- Better flexibility through absolute customizability

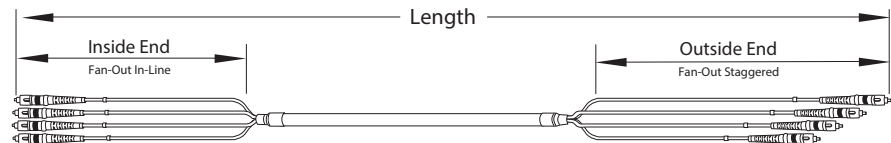

Product Engineering Code (PEC) - GUIDELINE

Use the following options to determine the Product Engineering code (PEC) and order custom combination of cable type, connectors and length required.

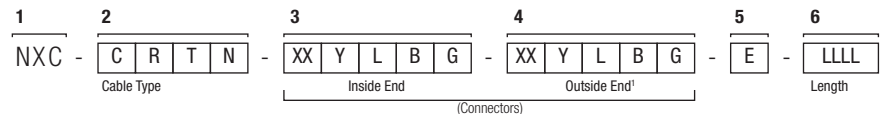

1 NXC identifies the product family for all fiber cable assemblies

2 Select Cable Type

C Cable Construction	R Fire Rating	T Fiber Type	N Fiber Count
M Distribution cable	R OFNR - Riser	M OM1 - 62.5 μm Multimode	6 6 Fibers
P Breakout 2.0 mm units	P OFNP - Plenum	F OM3 - 50 μm Multimode	L 12 Fibers
U Mini-distribution ²	B Plenum Indoor Armored	K OM4 (EV) - 50 μm Multimode	X 24 Fibers Sub-units
X uMini-distribution ²	D Outdoor	G OM4 (Aqua) - 50 μm Multimode	C 24 Fibers Non-terminated ³
	E Indoor / Outdoor Plenum	S OS2 - Singlemode	V 48 Fibers
			T 72 Fibers
			M 96 Fibers
			Z 144 Fibers

Faster.
Easier.
Better.



FiberExpress Pre-Terminated Assemblies (continued) FX Multi-Fiber Cable Assemblies

3 and 4 Inside End and Outside End (Connectors)

XX Connectors	Y Polish / Performance Level
LC LC Simplex	P PC - Physical Contact Multimode
LD LC Duplex	U UPC - Ultra Physical Contact Singlemode
LU LC Duplex UHD Uniboot	A APC - Angled Polish Contact Singlemode
LI LC Simplex UHD	Z Not applicable ⁴
LH LC Duplex UHD	
SC SC Simplex	
SD SC Duplex	
ST ST	
PH 12-fiber MPO female	
PG 12-fiber MPO male	
LM mSFP (Mini LC)	
ZZ OPEN ⁴	

Fan-out

L Fan-Out Length	B Fan-Out Construction	G Fan-Out Geometry	E Pulling Eye
C 0.5 m	B 900 µm Tight buffer	N In line or None	O At Outside end ⁵
F 1 m	E 2.0 mm jacket	A Staggered 25 mm	N None
G 2 m	G 3.0 mm jacket	B Staggered 50 mm	
N None ⁴	N None ⁴		

5 Pulling Eye

6 Length

LLLL is the length from tip to tip in meters: 0001, 0005, 0015, 0100, etc.

Examples:

PEC Code	Description
NXC-MRFL-LCPFBN-LCPFBN-O-0015	Multi-Fiber cable assembly, Distribution cable, Riser, OM3(50 µm), 12 fibers, LC/PC - LC/PC, Fan-out: 1 m - 900 µm - In line, with pulling eye, 15 m
NXC-UPFV-LDPFEN-PGPFBN-N-0020	Multi-Fiber cable assembly, Mini-distribution cable, Plenum, OM3 (50 µm), 48 fibers, LC Duplex/PC - MPO (m)/PC, Fan-out: 1 m - 2.0 mm(LC) & 3.0 mm (MPO) - In Line, No pulling eye, 20 m

Please contact Belden to validate your PEC Code and for any other fiber cable assembly combinations not available in this guideline.

Notes:

1. Outside end refers to the pulling side.
2. uMini-distribution cable is a round cable with 2 mm sub-units of 12 loose fibers each. Mini-distribution cable is a round cable with 3 mm sub-units of 12 loose fibers each. They are mainly used for MPO assemblies.
3. Single-Jacket design. It's only used for Distribution cable.
4. Only for Outside End. It's used for pigtailed.
5. Pulling eye is strongly recommended for assemblies longer than 10 m.

Fanout Options

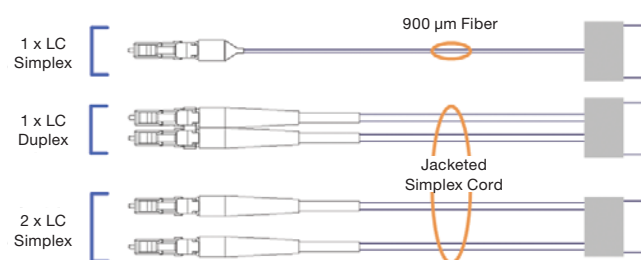

Stagger Options

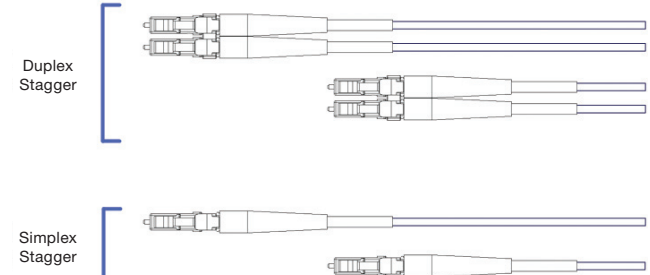

FiberExpress Workstation Connectivity FX Multi Box (M-Box) and MDVO Multimedia Outlet Box

Strategically placed connectivity through overt design. Compact low-port count field-term or pre-term distributed consolidation points minimizing installation time by maximizing trunk capacity.



FWSWBF04SB, FX W-Box, 4 x SC/APC Simplex

FASTER

- Faster installation with a variety of surface mount options

EASIER

- Easier distribution of low port count connectivity and breakouts with self-contained designs
- Easier field-termination with easily accessible consolidation points

BETTER

- Better options for pre-term and field-term including splicing

FX Wall Box (W-Box)

Protect and manage field-terminated fiber within a compact easily mounted termination box supporting both Mechanical Splice and Fusion Splice termination techniques.



FW3MBP06LD, FX M-Box Pre-Term, 6 x LC Duplex, 1 MPO-12(f), OM3

Description	Belden Part Number			
	OM3 Aqua	OM4 Erika Violet	OS2 Blue	OS2/APC Green
FX Wall-Box, 1x SC Simplex	–	–	FWSWBF01SC	FWSWBF01SB
FX Wall-Box, 2x SC Simplex	–	–	FWSWBF02SC	FWSWBF02SB
FX Wall-Box, 4x SC Simplex	–	–	FWSWBF04SC	FWSWBF04SB

FX Multi Box (M-Box)

Extremely compact, the feature rich M-Box is ideally suited for floor box and consolidation point applications. Supporting pre-terminated MPO-12(f) connectivity with an integrated fanout to LC, 1G and 10G Ethernet can be quickly deployed and re-deployed eliminating field termination. When the need arises additional versions of the M-Box are fully equipped to handle and protect field termination including both mechanical splice and pigtail fusion splicing techniques.

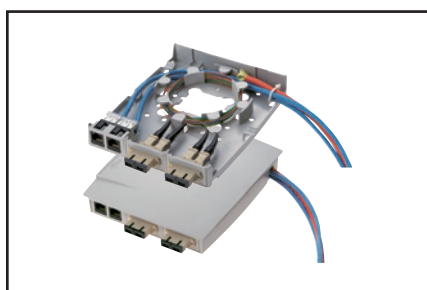

A0643206, MDVO Multimedia Outlet Box (shown terminated)

Description	Belden Part Number			
	OM3 Aqua	OM4 Erika Violet	OS2 Blue	OS2/APC Green
FX Multi-Box Pre-Term MPO-12(f) to 6 x LC Duplex	FW3MBP06LD	FW4MBP06LD	FWSMBP06LD	FWSMBP06LA
FX Multi-Box Field-Term, (with Pigtails)	FW3MBS06LD	FW4MBS06LD	FWSMBS06LD	FWSMBS06LA
FX Multi-Box Field-Term, (without Pigtails)	FW3MBF06LD	FW4MBF06LD	FWSMBF06LD	FWSMBF06LA

MDVO Multimedia Outlet Box

The MDVO Multimedia Outlet Box brings unique versatility for multimedia work area installations. The box design provides cable management and helps maintain cable bend radius. The low profile design and side-entry of the outlet box offers better protection for patch cords. The outlet box can accept up to six MDVO-style modules or three SC Duplex footprint adapters.

The MDVO Multimedia Outlet Box can be mounted directly on the wall or attached to standard electrical boxes. Included with the MDVO Multimedia box are three 1-port SC Duplex footprint mounting bezels and three 2-port MDVO adapters.

Description	Belden Part Number	
	Almond	White
MDVO Multimedia Outlet Box, 6-Port	A0643206	A0643207

*See the Belden copper catalog for a larger selection.

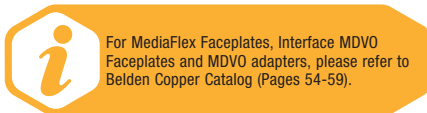

Faster.
Easier.
Better.



FiberExpress Workstation Connectivity (continued)

Multi-User Outlet Box, MDVO Fiber Adapter Modules, KeyConnect Fiber Adapter Modules and Standard Duplex Fiber Adapters

Multi-User Outlet Box

The Multi-User Outlet Box is a versatile box that can be used in many different applications. The outlet box can accommodate up to 24 connections of any type: UTP, fiber or coax. The outlet box is ideal for use as a multi-user telecommunications assembly, or simply as a high-density multimedia telecommunications outlet. The Multi-User Outlet Box can also be used as a wall mounted patch panel in confined areas, such as shallow rooms and cabinets.

Description	Belden Part Number		
	Almond	Elec. White	Black
Multi-User Outlet Box, 24-MDVO Ports (Empty)	AX100220	AX100221	AX100222
Multi-User KeyConnect 12-Port Adapter Strip	-	-	AX104615
Multi-User MDVO 12-Port Adapter Strip	-	-	AX100223



AX100222, Multi-User Outlet Box (shown here with optional modules)

MDVO Fiber Adapter Modules

Description	Belden Part Number		
	Almond	Elec. White	Black
LC Duplex - OM3 (Aqua Adapter)	AX105505-AL	AX105505-WH	AX105505-BK
SC Simplex - OM3 (Aqua Adapter)	AX105697-AL	AX105697-WH	AX105697-BK

All MDVO Adapter Modules listed above come in quantities of 25 per package
Please contact Belden for any help configuring/validating *SmartPart* Numbers or for any other custom Engineered solutions

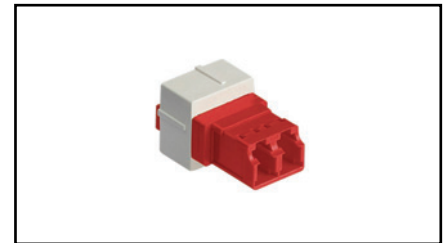

AX102101, OM4 MDVO Adapter Module with LC Keyed Red Adapter, White Holder

KeyConnect Fiber Adapter Modules

Description	Belden Part Number		
	Almond	Elec. White	Black
LC Duplex - OM3 (Aqua Adapter)	AX104937	AX104938	AX104939
LC Duplex - OM4 (Erika Violet Adapter)	AX105641-AL	AX105641-EW	AX105641-BK
SC Simplex OM1 (Beige Adapter)	AX102683	AX102684	AX102685
SC Simplex - OM3 (Aqua Adapter)	AX105643-AL	AX105643-EW	AX105643-BK
ST- Metal	AX102242	AX102243	AX102244

All KeyConnect Adapter Modules listed above come in quantities of 25 per package
Please contact Belden for any help configuring/validating *SmartPart* Numbers or for any other custom Engineered solutions



AX104939, KeyConnect Adapter, LC Duplex, OM3 (Aqua Adapter), Black Holder

Standard Duplex Footprint Fiber Adapters

Description	Belden Part Number			
	OM3 Aqua	OM4 Erika Violet	OS2 Blue	OS2/APC Green
SC Duplex, Flangeless	AX105691-B25	AX105692-B25	AX105002-B25	AX105646-B25
SC Duplex w/Shutters, Flangeless	-	-	AX105693-B25	AX105694-B25

Refer to the Belden copper catalog for a larger selection of workstation connectivity options.

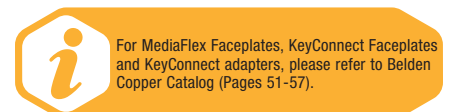

FiberExpress Secure/Keyed LC System FX Secure/Keyed LC System

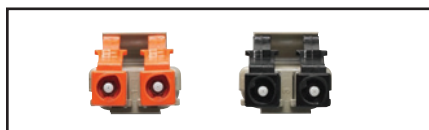

FX Secure/Keyed LC System



FX Brilliance Connectors



FX Secured/Keyed LC Ultra Cassette



FX Secure/Keyed LC Manager Module

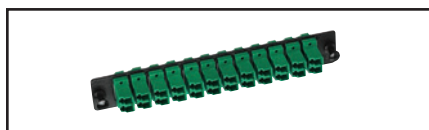

FX Secure/Keyed LC Adapter Strip

The FX Secure/Keyed LC System allows for physical segregation of network segments in secure fiber cabling infrastructures. All Secure/Keyed LC products are available with 12 different keying options each carrying a different color to facilitate network administration. The keying detail inside the connector is highly tamper-resistant and cannot be reproduced inside a standard LC connector to violate the network security. All products comply with the FOCIS 10 standard and optical performance exceeds all industry standards for SFF connectors.

The Secure/Keyed LC Adapter Modules, Frames, Cassettes and Adapter Strips can be used in all mounting hardware for workstation area, Consolidation Point or Telecom Room applications. The Secure/Keyed LC FX Manager Modules can be used in 19- and 23-inch FX Manager Shelves to provide a high-density management system.

The Secure/Keyed LC FX Ultra Frames and Cassettes can be used with the FX UHD Rack and FX Ultra Wall-mount Patch Panels to provide an Ultra high-density patching system that is easy to deploy, operate and maintain, while ensuring maximum uptime, uninterrupted availability and superior performance.

The Secure/Keyed LC Patch Cords and Pigtails are offered in Multimode 62.5 μm (OM1), laser-optimized 50 μm (OM3 and OM4) and Singlemode (OS2) for the most demanding network performance.

The Secure/Keyed LC Brilliance Universal Field Installable Connectors are available in Multimode 50 μm laser-optimized (OM4, OM3 compatible) and Singlemode (OS2) fiber versions.

FX Secure/Keyed LC System

Description	Splices
LC Key1	Red
LC Key2	Green
LC Key3	Yellow
LC Key4	Black
LC Key5	Orange
LC Key6	Blue
LC Key7	Violet
LC Key8	Rose
LC Key9	Aqua
LC KeyA	Brown
LC KeyB	Slate
LC KeyC	White

For additional details, please refer to the Secure/Keyed LC System Product Bulletin PB275.

Faster.
Easier.
Better.



FiberExpress Optic Cables Introduction

The optical fiber cables featured in this section have been expanded to meet advances in technology and the demands of both commercial and industrial applications. Refer to page 3 for selecting a fiber type, color coding information, and optical specifications. Belden's extensive line of indoor and outdoor cable products is offered in tight buffer and loose tube designs. Armored, burial, and ruggedized designs are suited to a host of industrial environments. For each product design, items for OM1, OM2, OM3, OM4, and OS2 (Singlemode) items have been developed.

Belden fiber products are third party tested by either ETL or UL and approved for use according to the National Electric Code.

Customer Service

Many fiber designs are available from stock through our Distributors. For your new or custom application that you do not locate in this section, contact Customer Service at 1-800-Belden-1 (800.235.3361) for additional information or to request a quote. Further product and technical information is also available on our web site at www.belden.com.



Jacket Color Chart

Cable Type		Jacket Color
Indoor Cables: Interconnect, Breakout, Distribution, Mini-Distribution and Tray Optic		
OM1 & OM2		Orange
OM3		Aqua
OM4		Erika Violet (Standard) Aqua (Optional)
OS2		Yellow
Hybrid Indoor Cables: Breakout, Distribution & Mini-Distribution		
Primary Fiber Type	Secondary Fiber Type	Jacket Color
OS2	OM1	Orange
OS2	OM3	Aqua
OS2	OM4	Erika Violet (Standard)
OM3	OM1	Aqua
OM4	OM1	Erika Violet (Standard) Aqua (Optional)
Indoor/Outdoor & Outdoor Cables: Distribution, Loose Tube, OSP		
OM1, OM2, OM3, OM4, OS2		Black
Specialty Cables: Tactical		
OM1, OM2, OM3, OM4, OS2		Black

See page 3, FX Systems chart for technical performance.

The part numbers in the following pages represent standard fiber cables, additional constructions are available, please contact your Belden representative for more information.



Documents contributing to LEED points are available at info.belden.com/leed-credits

FiberExpress Interconnect Cables Tight Buffer – Riser & Plenum Rated

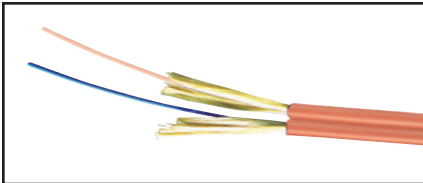

Duplex Optical Fiber Interconnect Cable

Supple and compact yet undoubtedly resilient. Small form factor FX interconnect cables provide the right combination of flexibility, small size and robustness needed to withstand the rigours of daily patching without sacrificing density.

Applications:

- Patching
- Inside Cabinets
- Workstation Equipment Connections

Specifications

Bend Radius (vs. Cable OD)

Installation	15 x OD
Operation	10 x OD

Temperature Range

Storage	-40°C to 70°C (-40°F to 158°F)
Installation	0°C to 50°C (32°F to 122°F)
Operation	-20°C to 70°C (-4°F to 158°F)

Legend

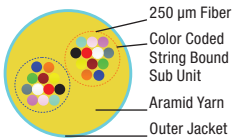

Compliance

- TIA/EIA-568-C.3
- ISO/IEC 11801, 2nd Edition
- Telcordia GR-409-CORE
- RoHS II 2011/65/EU
- REACH EC1907-2006
- NEC/CEC OFNR/OFN FT.4 (RISER - PVC)
- NEC/CEC OFNP/OFN FT.6 (PLENUM - PVC or PVDF)
- IEC 60332-3-24, IEC 61034-2, IEC 60754-1&2 (LSZH - FRPE)
- ICEA S-83-596

Zip Cord (900µm Fiber)

Description	Construction	Fiber Count	Fiber	Cable OD		Weight		Tensile Strength			
				mm	in.	Kg/km	lb/1000 ft.	Operation		Installation	
Simplex		1	900 µm TB	2.0	0.08	4	3	66	15	220	50
		1		3.0	0.11	7	5				
Duplex Zip		2	900 µm TB	2.0 x 4.0	0.08 x 0.16	7	5	66	15	220	50
		2		3.0 x 5.8	0.11 x 0.22	16	11				

Standard Configurations

Fiber Count	Belden Part Number		
	OM3 Aqua	OM4 Erika Violet	OS2 Yellow
Simplex 2.0 mm - Riser			
1	FI3I001RB	FI4I001RB	FISI001RB
Simplex 3.0 mm - Riser			
1	FI3I001RC	FI4I001RC	FISI001RC
Duplex 2.0 mm - Riser			
2	FI3I002RB	FI4I002RB	FISI002RB
Duplex 3.0 mm - Riser			
2	FI3I002RC	FI4I002RC	FISI002RC

For an exhaustive selection contact Belden customer service or your local Belden Representative for more details.

Mini Round (250 µm Fiber)

Description	Construction	Fiber Count	Fiber	Cable OD		Weight		Tensile Strength			
				mm	in.	Kg/km	lb/1000 ft.	Operation		Installation	
Duplex Mini-Round		2	250 µm	2.0	0.08	3.4	2.3	133	30	445	100
Mini-Round 8f		8	250 µm	2.0	0.08	3.4	2.3	133	30	445	100
Mini-Round 12f		12	250 µm	2.0	0.08	3.4	2.3	133	30	445	100

Standard Configurations

Fiber Count	Belden Part Number		
	OM3 Aqua	OM4 Erika Violet	OS2 Yellow
Mini-Round 2.0 mm - Plenum			
2	FI3I002P0	FI4I002P0	FISI002P0
8	FI3I008P0	FI4I008P0	FISI008P0
12	FI3I012P0	FI4I012P0	FISI012P0

Faster.
Easier.
Better.



FiberExpress Breakout Cables Tight Buffer — Indoor Riser, Plenum & LSZH Rated

Robust terminations in demanding environments. All the ease of 900 μm tight buffered termination with only one fiber per sub-unit enables the ultimate bond between the connector and the cables' Aramid yarns resulting in unmatched strength and durability.

Applications:

- Horizontal distribution for Fiber-to-the-desk
- In-building backbone
- Factory floor automation
- Broadcast and A/V in-building installations

Additional Options

- 2.5 mm and 2.9 mm Subunits
- MSHA (Mining) Approvals

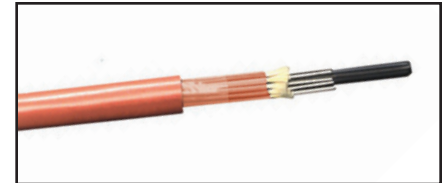

Optical Fiber Breakout Cable

Description	Construction	Fiber Count	Fiber	Sub-Unit OD	Cable OD		Weight		Tensile Strength			
					mm	in.	Kg/km	lb/1000 ft.	Operation		Installation	
									N	lbs-f	N	lbs-f
Color-coded Sub-Units		2	900 μm TB	2.0	6.6	0.26	36	24	400	90	800	180
		4	900 μm TB	2.0	8.2	0.32	52	35	755	170	1535	345
		6	900 μm TB	2.0	9.1	0.36	80	54	1025	230	2070	465
		8			10.3	0.41	103	69	1335	300	2670	600
		10			11.6	0.46	128	86				
		12			13.1	0.51	164	110				

Above specifications provide a general representation for the product family. Improved specifications may exist for Riser, Plenum or LSZH constructions. Consult individual technical data sheets for exact specifications.

Specifications

Bend Radius (vs. Cable OD)

Installation	15 x OD
Operation	10 x OD

Temperature Range

Storage	-40°C to 70°C (-40°F to 158°F)
Installation (Plenum/LSZH)	0°C to 60°C 32°F to 140°F
Installation (Riser)	-10°C to 60°C (14°F to 140°F)
Operation (Plenum/LSZH)	0°C to 70°C (32°F to 158°F)
Operation (Riser)	-20°C to 70°C (-4°F to 158°F)

Fiber Count	Belden Part Number			
	OM1 Orange	OM3 Aqua	OM4 Erika Violet	OS2 Yellow
Plenum				
2	F1B002PB	F3B002PB	F4B002PB	F5B002PB
4	F1B004PB	F3B004PB	F4B004PB	F5B004PB
6	F1B006PB	F3B006PB	F4B006PB	F5B006PB
12	F1B012PB	F3B012PB	F4B012PB	F5B012PB
LSZH/Riser				
2	F1B002LB	F3B002LB	F4B002LB	F5B002LB
4	F1B004LB	F3B004LB	F4B004LB	F5B004LB
6	F1B006LB	F3B006LB	F4B006LB	F5B006LB
12	F1B012LB	F3B012LB	F4B012LB	F5B012LB

For an exhaustive selection contact Belden customer service or your local Belden Representative for more details.

Legend

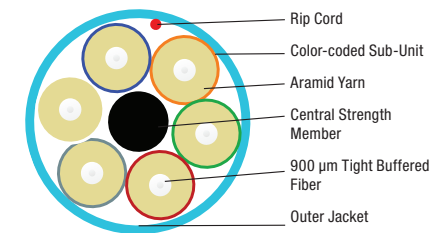

Compliance

- TIA/EIA-568-C.3
- ISO/IEC 11801, 2nd Edition
- Telcordia GR-409-CORE
- RoHS II 2011/65/EU
- REACH EC1907-2006
- NEC/CEC OFNR/OFN FT.4 (RISER - PVC)
- NEC/CEC OFNR/OFN FT.4 (LSZH - FRPE)
- NEC/CEC OFNP/OFN FT.6 (PLENUM - PVC or PVDF)
- ICEA S-83-596

FiberExpress Distribution Cables Tight Buffer – Indoor Riser & Plenum Rated

Fast installation, easy termination.
Sub-unitized cables provide easy routing and 900 μm tight-buffered fiber supporter fast and robust field-termination.

Applications:

- Horizontal distribution for Fiber-to-the-desk
- In-building backbone
- Factory floor automation
- Data Center EDA areas

Additional Options

- MSHA (Mining) Approvals

Indoor Specifications

Bend Radius (vs. Cable OD)

Installation	15 x OD
Operation	10 x OD

Temperature Range

Storage	-40°C to 70°C (-40°C to 158°F)
Installation (Plenum/LSZH)	0°C to 60°C (32°F to 140°F)
Installation (Riser)	-10°C to 60°C (14°F to 140°F)
Operation (Plenum/LSZH)	0°C to 70°C (32°F to 158°F)
Operation (Riser)	-20°C to 70°C (-4°F to 158°F)

Legend

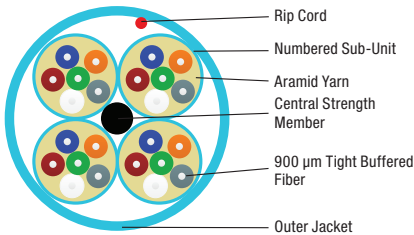

Compliance

- TIA/EIA-568-C.3
- ISO/IEC 11801, 2nd Edition
- Telcordia GR-409-CORE
- RoHS II 2011/65/EU
- REACH EC1907-2006
- NEC/CEC OFNR/OFN FT.4 (RISER - PVC)
- NEC/CEC OFNR/OFN FT.4 (LSZH - FRPE)
- NEC/CEC OFNP/OFN FT.6 (PLENUM - PVC or PVDF)
- ICEA S-83-596

Description	Construction	Fiber Count	Fiber	Sub-Unit OD	Cable OD				Tensile Strength							
					mm		in.		Kg/km		lb/1000 ft.		Operation		Installation	
					mm	in.	Kg/km	lb/1000 ft.	N	lbs-f	N	lbs-f				
Non-Unitized		2	900 μm TB	N/A	4.8	0.19	22	15	222	50	556	125				
		4			4.8	0.19	25	17	222	50	556	125				
		6	900 μm TB	N/A	5.8	0.23	36	24	334	75	667	150				
		8														
		10														
		12														
	16	900 μm TB	N/A	8.8	0.35	64	43	556	125	1112	250					
	24															
Unitized 6-Fiber Sub-Units		24	900 μm TB	4.5	13.1	0.52	145	97	1001	225	2002	450				
		36			16.0	0.63	221	148	1668	375	3336	750				
Unitized 12-Fiber Sub-Units		36	900 μm TB	5.5	14.1	0.56	162	109	1001	225	2002	450				
		48			15.5	0.61	207	139	1423	320	2847	640				
	72	19.0			0.75	321	216	2002	450	4226	950					
	96	22.8			0.90	536	360	2780	625	5560	1250					
	144	25.4			1.00	602	404	4226	950	8452	1900					

Above specifications provide a general representation for the product family. Improved specifications may exist for Riser, Plenum or LSZH constructions. Consult individual technical data sheets for exact specifications.

Faster.
Easier.
Better.



FiberExpress Distribution Cables (continued)
Tight Buffer — Indoor Riser & Plenum Rated

Standard Indoor Configurations

Fiber Count	Belden Part Number			
	OM1 Orange	OM3 Aqua	OM4 Erika Violet	OS2 Yellow
Non-Unitized - Riser				
2	F1D002R9	F3D002R9	F4D002R9	FISD002R9
6	F1D006R9	F3D006R9	F4D006R9	FISD006R9
12	F1D012R9	F3D012R9	F4D012R9	FISD012R9
24	F1D024R9	F3D024R9	F4D024R9	FISD024R9
Non-Unitized - Plenum				
2	F1D002P9	F3D002P9	F4D002P9	FISD002P9
6	F1D006P9	F3D006P9	F4D006P9	FISD006P9
12	F1D012P9	F3D012P9	F4D012P9	FISD012P9
24	F1D024P9	F3D024P9	F4D024P9	FISD024P9
Unitized 6 Fiber subunits riser				
24	F1D024RJ	F3D024RJ	F4D024RJ	FISD024RJ
Unitized 6 Fiber subunits plenum				
24	F1D024PJ	F3D024PJ	F4D024PJ	FISD024PJ
Unitized 12 Fiber subunits plenum				
36	F1D036PK	F3D036PK	F4D036PK	FISD036PK
48	F1D048PK	F3D048PK	F4D048PK	FISD048PK
72	F1D072PK	F3D072PK	F4D072PK	FISD072PK
96	F1D096PK	F3D096PK	F4D096PK	FISD096PK
144	F1D144PK	F3D144PK	F4D144PK	FISD144PK

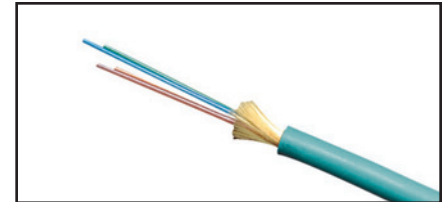

Optical Fiber Distribution Cable

For an exhaustive selection contact Belden customer service or your local Belden Representative for more details.

FiberExpress Distribution Cables (continued) Tight Buffer – Indoor/Outdoor Riser, Plenum & LSZH Rated

Indoor/Outdoor Specifications

- Environmental Protection
 - UV Resistant Jacket
 - Moisture Resistant Jacket
 - Fungus Resistant Jacket
 - Water Blocking Aramid
 - Water Blocking Tape

Additional Options

- MSHA (Mining) Approvals

Indoor/Outdoor Specifications

Bend Radius (vs. Cable OD)

Installation	20 x OD
Operation	10 x OD

Temperature Range

Storage	-40°C to 70°C (-40 to 158°F)
Installation	-20 to 70°C (-4 to 158°F)
Operation	-40 to 70°C (-40 to 158°F)

Legend

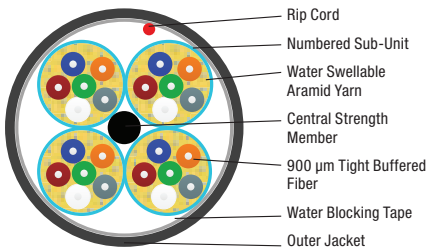

Compliance

- TIA/EIA-568-C.3
- ISO/IEC 11801, 2nd Edition
- Telcordia GR-20-CORE
- RoHS II 2011/65/EU
- REACH EC1907-2006
- NEC/CEC OFNR/OFN FT.4 (RISER - PVC)
- NEC/CEC OFNR/OFN FT.4 (LSZH - FRPE)
- NEC/CEC OFNP/OFN FT.6 (PLENUM - PVC or PVDF)
- ICEA S-104-696

Description	Construction	Fiber Count	Fiber	Sub-Unit OD	Cable OD		Weight		Tensile Strength			
					mm	in.	Kg/km	lb/1000 ft.	Operation		Installation	
									N	lbs-f	N	lbs-f
Non-Unitized		2	900 µm TB	N/A	4.8	0.19	22	15	222	50	556	125
		4	900 µm TB	N/A	4.8	0.19	25	17	222	50	556	125
		6					31	21				
		8			5.8	0.23	36	24	334	75	667	150
		10					39	26				
		12					43	29				
16	8.8	0.35	64	43	556	125	1112	250				
24			80	54								
Unitized 6-Fiber Sub-Units		24	900 µm TB	4.5	13.1	0.52	145	97	1001	225	2002	450
		36			16.0	0.63	221	148	1668	375	3336	750
Unitized 12-Fiber Sub-Units		36	900 µm TB	5.5	14.1	0.56	162	109	1001	225	2002	450
		48			15.5	0.61	207	139	1423	320	2847	640
		72			19.0	0.75	321	216	2002	450	4226	950
		96			22.8	0.90	536	360	2780	625	5560	1250
		144			25.4	1.00	602	404	4226	950	8452	1900

Above specifications provide a general representation for the product family. Improved specifications may exist for Riser, Plenum or LSZH constructions. Consult individual technical data sheets for exact specifications.

Faster.
Easier.
Better.



FiberExpress Distribution Cables (continued)
Tight Buffer — Indoor/Outdoor Riser, Plenum & LSZH Rated

Standard Indoor/Outdoor Configurations

Fiber Count	Belden Part Number			
	OM1 Black	OM3 Black	OM4 Black	OS2 Black
Non-Unitized - Riser/LSZH				
2	FD1D002L9	FD3D002L9	FD4D002L9	FSD002L9
6	FD1D006L9	FD3D006L9	FD4D006L9	FSD006L9
12	FD1D012L9	FD3D012L9	FD4D012L9	FSD012L9
24	FD1D024L9	FD3D024L9	FD4D024L9	FSD024L9
Non-Unitized - Riser				
2	FD1D002R9	FD3D002R9	FD4D002R9	FSD002R9
6	FD1D006R9	FD3D006R9	FD4D006R9	FSD006R9
12	FD1D012R9	FD3D012R9	FD4D012R9	FSD012R9
24	FD1D024R9	FD3D024R9	FD4D024R9	FSD024R9
Non-Unitized Plenum				
2	FD1D002P9	FD3D002P9	FD4D002P9	FSD002P9
6	FD1D006P9	FD3D006P9	FD4D006P9	FSD006P9
12	FD1D012P9	FD3D012P9	FD4D012P9	FSD012P9
24	FD1D024P9	FD3D024P9	FD4D024P9	FSD024P9
Unitized 6-Fiber Sub-Units - Riser				
24	FD1D024RJ	FD3D024RJ	FD4D024RJ	FSD024RJ
Unitized 6-Fiber Sub-Units - Plenum				
24	FD1D024PJ	FD3D024PJ	FD4D024PJ	FSD024PJ
Unitized 12-Fiber Sub-Units - Riser/LSZH				
48	FD1D048LK	FD3D048LK	FD4D048LK	FSD048LK
72	FD1D072LK	FD3D072LK	FD4D072LK	FSD072LK
96	FD1D096LK	FD3D096LK	FD4D096LK	FSD096LK
144	FD1D144LK	FD3D144LK	FD4D144LK	FSD144LK
Unitized 12-Fiber Sub-Units - Plenum				
48	FD1D048PK	FD3D048PK	FD4D048PK	FSD048PK
72	FD1D072PK	FD3D072PK	FD4D072PK	FSD072PK
96	FD1D096PK	FD3D096PK	FD4D096PK	FSD096PK
144	FD1D144PK	FD3D144PK	FD4D144PK	FSD144PK

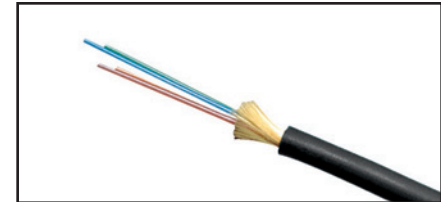

Optical Fiber Distribution Cable, Indoor/Outdoor

For an exhaustive selection contact Belden customer service or your local Belden Representative for more details.

FiberExpress Armored Distribution Cables Tight Buffer – Indoor, Riser and Plenum Rated

Heightened Protection with simple termination. Augmenting the easy termination of Distribution cable with interlocking armor to provide an elevated resistance to cutting, crushing and the gnawing of rodents all while eliminating the additional expense of innerduct.

Applications:

- Campus/Inter Building
- Telecom Trunks
- Industrial
- Rugged Environments

Indoor Specifications

Bend Radius (vs. Cable OD)

Installation	20 x OD
Operation	15 x OD

Temperature Range

Storage	-40°C to 70°C (-40°F to 158°F)
Installation (Plenum/LSZH)	0°C to 60°C (32°F to 140°F)
Installation (Riser)	-10°C to 60°C (14°F to 140°F)
Operation (Plenum/LSZH)	0°C to 70°C (32°F to 158°F)
Operation (Riser)	-20°C to 70°C (-4°F to 158°F)

Legend

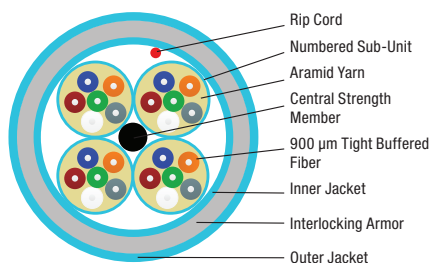

Description	Construction	Fiber Count	Fiber	Sub-Unit OD	Cable OD		Weight		Tensile Strength			
					mm	in.	Kg/km	lb/1000 ft.	Operation		Installation	
									N	lbs-f	N	lbs-f
Non-Unitized		6	900 μm TB	N/A	14.5	0.57	189	127	360	81	1201	270
		12			15.7	0.62	150	223	400	90	1334	300
		24			17.0	0.67	335	225				
Unitized 6-Fiber Sub-Units		24	900 μm TB	4.5	21.5	0.85	391	263	890	200	2700	600
		36			25.3	1.00	548	368				
Unitized 12-Fiber Sub-Units		48	900 μm TB	5.5	24.6	0.97	540	363	890	200	2700	600
		72			27.8	1.09	716	481				
		96			32.5	1.28	930	625				
		144			35.6	1.40	1005	675				

Above specifications provide a general representation for the product family. Improved specifications may exist for Riser, Plenum or LSZH constructions. Consult individual technical data sheets for exact specifications.

Compliance

- TIA/EIA-568-C.3
- ISO/IEC 11801, 2nd Edition
- Telcordia GR-409-CORE
- RoHS II 2011/65/EU
- REACH EC1907-2006
- NEC/CEC OFNR/OFN FT.4 (RISER - PVC)
- NEC/CEC OFNR/OFN FT.4 (LSZH - FRPE)
- NEC/CEC OFNP/OFN FT.6 (PLENUM - PVC or PVDF)
- ICEA S-83-596

Faster.
Easier.
Better.



FiberExpress Armored Distribution Cables (continued)
Tight Buffer — Indoor Riser & Plenum Rated

Standard Indoor Armored Configurations

Fiber Count	Belden Part Number			
	OM1 Orange	OM3 Aqua	OM4 Erika Violet	OS2 Yellow
Non-Unitized Riser				
6	F1D006F9	F3D006F9	F4D006F9	FISD006F9
12	F1D012F9	F3D012F9	F4D012F9	FISD012F9
24	F1D024F9	F3D024F9	F4D024F9	FISD024F9
Non-unitized Plenum				
6	F1D006A9	F3D006A9	F4D006A9	FISD006A9
12	F1D012A9	F3D012A9	F4D012A9	FISD012A9
24	F1D024A9	F3D024A9	F4D024A9	FISD024A9
Unitized 6 fiber sub-units plenum				
24	F1D024AJ	F3D024AJ	F4D024AJ	FISD024AJ
Unitized 12 fiber sub-units plenum				
48	F1D048AK	F3D048AK	F4D048AK	FISD048AK
72	F1D072AK	F3D072AK	F4D072AK	FISD072AK
96	F1D096AK	F3D096AK	F4D096AK	FISD096AK
144	F1D144AK	F3D144AK	F4D144AK	FISD144AK

For an exhaustive selection contact Belden customer service or your local Belden Representative for more details.

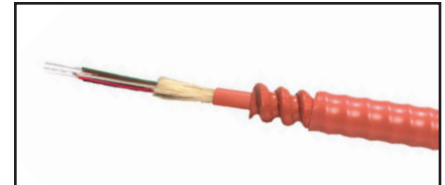

Armored Optical Fiber Distribution Cable

FiberExpress Armored Distribution Cables (continued) Tight Buffer – Indoor/Outdoor, Riser and Plenum Rated

Indoor/Outdoor Specifications

- Environmental Protection
 - UV Resistant Jacket
 - Moisture Resistant Jacket
 - Fungus Resistant Jacket
 - Water Blocking Aramid
 - Water Blocking Tape

Additional Options

- MSHA (Mining) Approvals

Indoor/Outdoor Specifications

Bend Radius (vs. Cable OD)

Installation	20 x OD
Operation	15 x OD

Temperature Range

Storage	-40°C to 70°C (-40°F to 158°F)
Installation	-20°C to 70°C (-4°F to 158°F)
Operation	-40°C to 70°C (-40°F to 158°F)

Legend

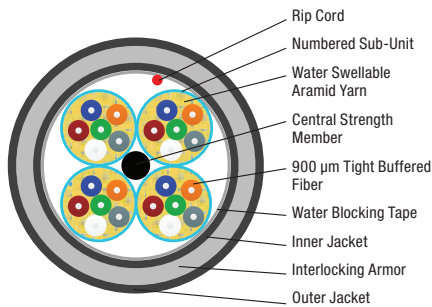

Description	Construction	Fiber Count	Fiber	Sub-Unit OD	Cable OD		Weight		Tensile Strength			
					mm	in.	Kg/km	lb/1000 ft.	Operation		Installation	
									N	lbs-f	N	lbs-f
Non-Unitized		6	900 µm TB	N/A	14.5	0.57	189	127	360	81	1201	270
		12			15.7	0.62	150	223	400	90	1334	300
		24			17.0	0.67	335	225				
Unitized 6-Fiber Sub-Units		24	900 µm TB	4.5	21.5	0.85	391	263	890	200	2700	600
		36			25.3	1.00	548	368				
Unitized 12-Fiber Sub-Units		48	900 µm TB	5.5	24.6	0.97	540	363				
		72			27.8	1.09	716	481				
		96			32.5	1.28	930	625	890	200	2700	600
		144			35.6	1.40	1005	675				

Above specifications provide a general representation for the product family. Improved specifications may exist for Riser, Plenum or LSZH constructions. Consult individual technical data sheets for exact specifications.

Compliance

- TIA/EIA-568-C.3
- ISO/IEC 11801, 2nd Edition
- Telcordia GR-20-CORE
- RoHS II 2011/65/EU
- REACH EC1907-2006
- NEC/CEC OFNR/OFN FT.4 (RISER - PVC)
- NEC/CEC OFNR/OFN FT.4 (LSZH - FRPE)
- NEC/CEC OFNP/OFN FT.6 (PLENUM - PVC or PVDF)
- ICEA S-104-696

Faster.
Easier.
Better.



FiberExpress Armored Distribution Cables (continued)
Tight Buffer — Indoor/Outdoor, Riser & Plenum Rated

Standard Indoor / Outdoor Armored Configurations

Fiber Count	Belden Part Number			
	OM1 Black	OM3 Black	OM4 Black	OS2 Black
Non-Unitized Riser				
6	FD1D006F9	FD3D006F9	FD4D006F9	FDSD006F9
12	FD1D012F9	FD3D012F9	FD4D012F9	FDSD012F9
24	FD1D024F9	FD3D024F9	FD4D024F9	FDSD024F9
Non-unitized Plenum				
6	FD1D006A9	FD3D006A9	FD4D006A9	FDSD006A9
12	FD1D012A9	FD3D012A9	FD4D012A9	FDSD012A9
24	FD1D024A9	FD3D024A9	FD4D024A9	FDSD024A9
Unitized 6 fiber sub-units plenum				
24	FD1D024AJ	FD3D024AJ	FD4D024AJ	FDSD024AJ
Unitized 12 fiber sub-units plenum				
48	FD1D048AK	FD3D048AK	FD4D048AK	FDSD048AK
72	FD1D072AK	FD3D072AK	FD4D072AK	FDSD072AK
96	FD1D096AK	FD3D096AK	FD4D096AK	FDSD096AK
144	FD1D144AK	FD3D144AK	FD4D144AK	FDSD144AK

For an exhaustive selection contact Belden customer service or your local Belden Representative for more details.

FiberExpress Hybrid Distribution Cables Tight Buffer – Indoor/Outdoor, Riser and Plenum Rated

Hybrid cables combine multiple grades of fiber in a single unitized cable easily supporting various applications in a single cable which minimize installation labor.

Applications

- In building backbones
- Factory floor automation
- Broadcast and A/V in-building installation

Additional Options

- Breakout Cable
- uMini-Distribution Cable
- 2-fiber to 144-fiber constructions
- Additional fiber grade combinations

Standard Hybrid Cable Color

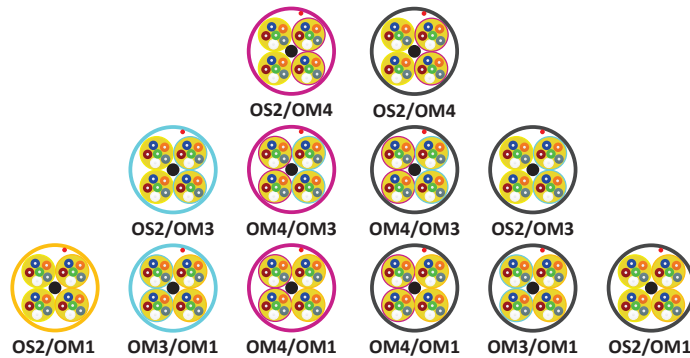

Standard Hybrid Distribution Configurations

Building a SmartPart Number

<p>1. Choose FX Fiber Cable</p> <div style="border: 1px solid black; padding: 5px; text-align: center; width: 40px; margin: 0 auto;">FI</div> <table border="1" style="width: 100%; border-collapse: collapse;"> <thead> <tr> <th colspan="2">FX Fiber Cable</th> </tr> </thead> <tbody> <tr> <td>FI</td> <td>Indoor Cable</td> </tr> <tr> <td>FD</td> <td>Indoor/Outdoor Cable</td> </tr> </tbody> </table>	FX Fiber Cable		FI	Indoor Cable	FD	Indoor/Outdoor Cable	<p>2. Choose Fiber Grade (Primary/Secondary)</p> <div style="border: 1px solid black; padding: 5px; text-align: center; width: 40px; margin: 0 auto;">H</div> <table border="1" style="width: 100%; border-collapse: collapse;"> <thead> <tr> <th colspan="2">Fiber Grade (PRI/SEC)</th> </tr> </thead> <tbody> <tr> <td>E</td> <td>OS2/OM4</td> </tr> <tr> <td>H</td> <td>OS2/OM3</td> </tr> <tr> <td>F</td> <td>OS2/OM1</td> </tr> <tr> <td>K</td> <td>OM4/OM1</td> </tr> <tr> <td>M</td> <td>OM3/OM1</td> </tr> </tbody> </table>	Fiber Grade (PRI/SEC)		E	OS2/OM4	H	OS2/OM3	F	OS2/OM1	K	OM4/OM1	M	OM3/OM1	<p>3. Choose Family</p> <div style="border: 1px solid black; padding: 5px; text-align: center; width: 40px; margin: 0 auto;">D</div> <table border="1" style="width: 100%; border-collapse: collapse;"> <thead> <tr> <th colspan="2">Family</th> </tr> </thead> <tbody> <tr> <td>D</td> <td>Distribution</td> </tr> </tbody> </table>	Family		D	Distribution	<p>4. Choose Fiber Configuration</p> <div style="border: 1px solid black; padding: 5px; text-align: center; width: 60px; margin: 0 auto;">H22</div> <table border="1" style="width: 100%; border-collapse: collapse;"> <thead> <tr> <th colspan="2">Fiber Configuration</th> </tr> </thead> <tbody> <tr> <td>H13</td> <td>4 Subunits, 1 Primary Subunit, 3 Secondary subunits</td> </tr> <tr> <td>H22</td> <td>4 Subunits, 2 Primary Subunits, 2 Secondary Subunits</td> </tr> <tr> <td>H31</td> <td>4 Subunits, 3 Primary Subunits, 1 Secondary Subunit</td> </tr> </tbody> </table>	Fiber Configuration		H13	4 Subunits, 1 Primary Subunit, 3 Secondary subunits	H22	4 Subunits, 2 Primary Subunits, 2 Secondary Subunits	H31	4 Subunits, 3 Primary Subunits, 1 Secondary Subunit	<p>5. Choose Flammability Rating and Protection</p> <div style="border: 1px solid black; padding: 5px; text-align: center; width: 40px; margin: 0 auto;">P</div> <table border="1" style="width: 100%; border-collapse: collapse;"> <thead> <tr> <th colspan="2">Flammability Rating and Protection</th> </tr> </thead> <tbody> <tr> <td colspan="2">Plenum Group</td> </tr> <tr> <td>P</td> <td>Plenum (OFNP)</td> </tr> <tr> <td>A</td> <td>Plenum Interlocked Aluminum Armor (OFCP)</td> </tr> <tr> <td colspan="2">Riser Group</td> </tr> <tr> <td>R</td> <td>Riser (OFNR)</td> </tr> <tr> <td>F</td> <td>Riser Interlocked Aluminum Armor (OFCR)</td> </tr> </tbody> </table>	Flammability Rating and Protection		Plenum Group		P	Plenum (OFNP)	A	Plenum Interlocked Aluminum Armor (OFCP)	Riser Group		R	Riser (OFNR)	F	Riser Interlocked Aluminum Armor (OFCR)	<p>6. Choose Subunit Type/Configuration</p> <div style="border: 1px solid black; padding: 5px; text-align: center; width: 40px; margin: 0 auto;">J</div> <table border="1" style="width: 100%; border-collapse: collapse;"> <thead> <tr> <th colspan="2">Subunit Type/Configuration</th> </tr> </thead> <tbody> <tr> <td>J</td> <td>4.5 mm Subunit, 6 x 900 μm Fiber</td> </tr> <tr> <td>K</td> <td>5.5 mm Subunit, 12 x 900 μm Fiber</td> </tr> </tbody> </table>	Subunit Type/Configuration		J	4.5 mm Subunit, 6 x 900 μm Fiber	K	5.5 mm Subunit, 12 x 900 μm Fiber
FX Fiber Cable																																																							
FI	Indoor Cable																																																						
FD	Indoor/Outdoor Cable																																																						
Fiber Grade (PRI/SEC)																																																							
E	OS2/OM4																																																						
H	OS2/OM3																																																						
F	OS2/OM1																																																						
K	OM4/OM1																																																						
M	OM3/OM1																																																						
Family																																																							
D	Distribution																																																						
Fiber Configuration																																																							
H13	4 Subunits, 1 Primary Subunit, 3 Secondary subunits																																																						
H22	4 Subunits, 2 Primary Subunits, 2 Secondary Subunits																																																						
H31	4 Subunits, 3 Primary Subunits, 1 Secondary Subunit																																																						
Flammability Rating and Protection																																																							
Plenum Group																																																							
P	Plenum (OFNP)																																																						
A	Plenum Interlocked Aluminum Armor (OFCP)																																																						
Riser Group																																																							
R	Riser (OFNR)																																																						
F	Riser Interlocked Aluminum Armor (OFCR)																																																						
Subunit Type/Configuration																																																							
J	4.5 mm Subunit, 6 x 900 μm Fiber																																																						
K	5.5 mm Subunit, 12 x 900 μm Fiber																																																						

For an exhaustive selection contact Belden customer service or your local Belden Representative for more details.

Examples:

FIHDH22PJ - Unitized – 6 fiber subunits and for FDEDH31AK's description to say Unitized 12 fiber subunits.

FDEDH31AK - FX Indoor/Outdoor Cable, Hybrid Distribution Tight Buffered Cable, Unitized, 48 fiber (36 fiber OS2, 12 fiber OM4), Plenum Armored, Black Jacket

Faster.
Easier.
Better.



FiberExpress Reel-In-A-Box Packaging Breakout, Distribution and Mini-Distribution, Indoor Riser & Plenum Rated

Lightweight and easy to handle Belden Reel-In-A-Box simplifies fiber cable payout. Rugged box construction and locking reel hub ensures both the box and fiber arrive on the job site intact and the adjustable hub tension always results in the optimal pulling condition.

Applications

- In building backbone
- Horizontal distribution for Fiber-to-the-desk
- Passive Optical Networking / Passive Optical LAN
- Broadcast and A/V in-building installations

Reel-In-A-Box Sizes

- 500 ft. (152 m) per box
- 1000 ft. (305 m) per box

Additional Options

- Interconnect Cable (page 34)
 - Simplex, Duplex and Mini-Round
- Breakout Cable (page 35)
 - Up to 4 fibers
- Indoor Distribution Cable (page 36)
 - Up to 12 fibers
- Indoor/Outdoor Distribution Cable (page 38)
 - Up to 12 fibers
- Indoor uMini-Distribution Cable (page 46)
 - Up to 12 fibers

Standard Configurations

Fiber Count	Belden Part Number			
	OM1 Orange	OM3 Aqua	OM4 Erika Violet	OS2 Yellow
1000 ft. Box – Interconnect (3 mm Zip Cord), Plenum				
1	F11001PCOBK	F13001PCABK	F14001PCEBK	F1S001PCYBK
2	F11002PCOBK	F13002PCABK	F14002PCEBK	F1S002PCYBK
1000 ft. Box – Breakout, Plenum				
2	F1B002PB0BK	F13B002PBABK	F14B002PBEBK	F1SB002PB0YBK
4	F1B004PB0BK	F13B004PBABK	F14B004PBEBK	F1SB004PB0YBK
1000 ft. Box – Distribution, Plenum				
2	F1D002P90BK	F13D002P9ABK	F14D002P9EBK	F1SD002P9YBK
4	F1D004P90BK	F13D004P9ABK	F14D004P9EBK	F1SD004P9YBK
6	F1D006P90BK	F13D006P9ABK	F14D006P9EBK	F1SD006P9YBK
12	F1D012P90BK	F13D012P9ABK	F14D012P9EBK	F1SD012P9YBK
1000 ft. Box – uMini-Distribution, Plenum				
12	F1M012P20BK	F13M012P2ABK	F14M012P2EBK	F1SM012P2YBK

For an exhaustive selection contact Belden customer service or your local Belden Representative for more details.



FiberExpress uMini Distribution Cables Indoor Riser & Plenum Rated

Reduce diameter and prepare for the future. 250 µm sub-unitized fiber provides the basis for MPO terminations while reducing size and weight all while maintaining compatibility with traditional LC/SC/ST terminations utilizing simple break out kits

or labor saving mass fusion splicing.

Applications:

- In-building backbone
- Data Centers
- Broadcast and AV in-building installations

Indoor Specifications

Bend Radius (vs. Cable OD)

Installation	15 x OD
Operation	10 x OD

Temperature Range

Storage	-40°C to 70°C (-40°F to 158°F)
Installation (Plenum/LSZH)	0°C to 60°C (32°F to 140°F)
Installation (Riser)	-10°C to 60°C (14°F to 140°F)
Operation (Plenum/LSZH)	0°C to 70°C (32°F to 158°F)
Operation (Riser)	-20°C to 70°C (-4°F to 158°F)

Legend

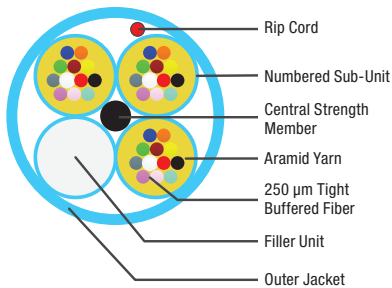

Compliance

- TIA/EIA-568-C.3
- ISO/IEC 11801, 2nd Edition
- Telcordia GR-409-CORE
- RoHS II 2011/65/EU
- REACH EC1907-2006
- NEC/CEC OFNR/OFN FT.4 (RISER - PVC)
- NEC/CEC OFNR/OFN FT.4 (LSZH - FRPE)
- NEC/CEC OFNP/OFN FT.6 (PLENUM - PVC or PVDF)
- ICEA S-83-596

Base12

Name	Construction	Fiber Count	Fiber	Sub-Unit OD	Cable OD		Weight		Tensile Strength lsb-f			
					mm	mm	in.	Kg/km	lb/1000 ft.	Operation		Installation
Indoor uMini-Distribution Cable												
Non-Unitized		12	250 µm	N/A	3.0	0.12	9	6	200.3	45	445	100
Unitized 12-Fiber Sub-Units		12	250 µm	2.0	3.0	0.18	11	7	200.3	45	668	150
		24			6.5	0.26	38	26				
		36										
		48										
		72										
		96										
	144	9.9	0.39	80.5	54.1							

Above specifications provide a general representation for the product family. Improved specifications may exist for Riser, Plenum or LSZH constructions. Consult individual technical data sheets for exact specifications.

Standard Indoor Configurations

Fiber Count	Belden Part Number		
	OM3 Aqua	OM4 Erika Violet	OS2 Yellow
Non-unitized - Plenum			
12	FI3M012P2	FI4M012P2	FISM012P2
Double-Jacket Unitized - Plenum			
12	FI3M012P0	FI4M012P0	FISM012P0
Unitized - Plenum			
24	FI3M024P1	FI4M024P1	FISM024P1
36	FI3M036P1	FI4M036P1	FISM036P1
48	FI3M048P1	FI4M048P1	FISM048P1
72	FI3M072P1	FI4M072P1	FISM072P1
144	FI3M144P1	FI4M144P1	FISM144P1

For an exhaustive selection contact Belden customer service or your local Belden Representative for more details.

Faster.
Easier.
Better.



FiberExpress uMini Distribution Cables Indoor Riser & Plenum Rated

Base8

Name	Construction	Fiber Count	Fiber	Sub-Unit OD			Cable OD		Weight		Tensile Strength lsb-f			
				mm	mm	in.	Kg/km	lb/1000 ft.	Operation		Installation			
									N	lbs-f	N	lbs-f		
Indoor uMini-Distribution Cable														
Non-Unitized		8	250 µm	N/A	3.0	0.12	9	6	200.3	50	445	100		
Unitized 8-Fiber Sub-Units		8	250 µm	3.0	4.8	0.18	11	7	200.3	45	668	150		
Unitized 8-Fiber Sub-Units		24	250 µm	2.0	6.5	0.26	38	26	200.3	45	668	150		
		32												
		48												
		64												
		96												

Above specifications provide a general representation for the product family. Improved specifications may exist for Riser, Plenum or LSZH constructions. Consult individual technical data sheets for exact specifications.

Fiber Count	Belden Part Number		
	OM3 Aqua	OM4 Erika Violet	OS2 Yellow
Non-Unitized Plenum			
8	FI3M008P2	FI4M008P2	FISM008P2
Double Jacket Unitized - Plenum			
8	FI3M008P8	FI4M008P8	FISM008P8
Unitized Plenum			
24	FI3M024P8	FI4M024P8	FISM024P8
32	FI3M032P8	FI4M032P8	FISM032P8
48	FI3M048P8	FI4M048P8	FISM048P8
64	FI3M064P8	FI4M064P8	FISM064P8
96	FI3M096P8	FI4M096P8	FISM096P8

For an exhaustive selection contact Belden customer service or your local Belden Representative for more details.

Indoor Specifications

Bend Radius (vs. Cable OD)

Installation	15 x OD
Operation	10 x OD

Temperature Range

Storage	-40°C to 70°C (-40°F to 158°F)
Installation (Plenum/LSZH)	0°C to 60°C (32°F to 140°F)
Installation (Riser)	-10°C to 60°C (14°F to 140°F)
Operation (Plenum/LSZH)	0°C to 70°C (32°F to 158°F)
Operation (Riser)	-20°C to 70°C (-4°F to 158°F)

Legend

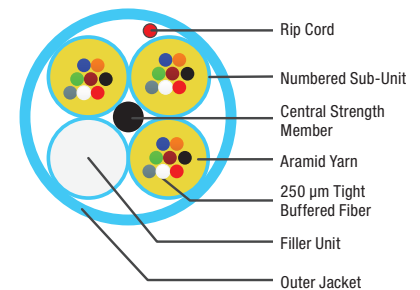

Compliance

- TIA/EIA-568-C.3
- ISO/IEC 11801, 2nd Edition
- Telcordia GR-409-CORE
- RoHS II 2011/65/EU
- REACH EC1907-2006
- NEC/CEC OFNR/OFN FT.4 (RISER - PVC)
- NEC/CEC OFNR/OFN FT.4 (LSZH - FRPE)
- NEC/CEC OFNP/OFN FT.6 (PLENUM - PVC or PVDF)
- ICEA S-83-596

Single-Jacket, All Dielectric Loose Tube Cables Loose Tube – Outdoor

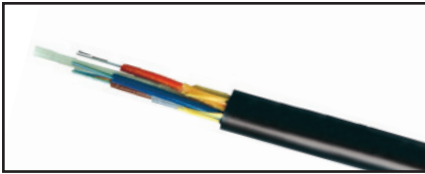

Gel-Filled or Dry Blocked buffer tubes prevent water migration. Full dielectric construction, no grounding required. Available with up to 144 fibers. Length markings in meters for easy determination of cable length.

Applications:

- Medium to high fiber count requirements
- Inter-building duct installations
- Lashed aerial
- Industrial outside plant (OSP Type)

Jacket Specifications

Jacket Material	Outdoor	PE
Buffer Tube		PBT
Strength Member		Aramid Yarn
Central Strength Member		E-Glass
Color Code (Buffer)		Per TIA/EIA 598-B
Jacket Color		Black

Specifications

Temperature Range (Outdoor Series)		
Storage		-40°C to 75°C
Operating		-40°C to 70°C
Min. Bend Radius		
Installation		20 x OD
Long Term		15 x OD

Legend

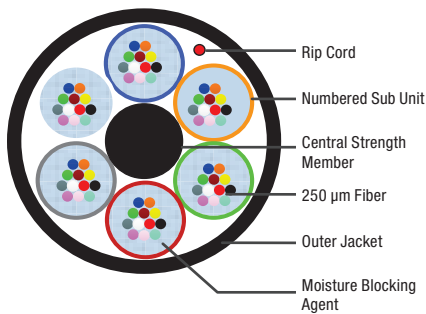

Compliance

- TIA/EIA-568-C.3
- ICEA S-87-640
- GR-20-CORE

Name	Construction	Fiber Count	Cable OD		Weight		Tensile Strength lsb-f			
			mm	in.	Kg/km	lb/1000 ft.	Installation		Operation	
							N	lbs-f	N	lbs-f
Unitized 6-Fiber Sub-Units		6	10.5	0.41	87	59	2700	600	890	200
Unitized 12-Fiber Sub-Units		12	10.5	0.41	87	59	2700	600	890	200
		24								
		36								
		48								
Unitized 12-Fiber Sub-Units		72	11.5	0.45	106	71	2700	600	890	200
		96	13.2	0.52	136	91				

Above specifications provide a general representation for the product family. Improved specifications may exist for Riser, Plenum or LSZH constructions. Consult individual technical data sheets for exact specifications.

Fiber Count	Belden Part Number				
	OM1	OM2	OM3	OM4	OS2
Outside Plant – Gel Filled Buffer Tubes					
6	FS1L006NF	FS2L006NF	FS3L006NF	FS4L006NF	FSSL006NF
12	FS1L012NG	FS2L012NG	FS3L012NG	FS4L012NG	FSSL012NG
24	FS1L024NG	FS2L024NG	FS3L024NG	FS4L024NG	FSSL024NG
36	FS1L036NG	FS2L036NG	FS3L036NG	FS4L036NG	FSSL036NG
48	FS1L048NG	FS2L048NG	FS3L048NG	FS4L048NG	FSSL048NG
72	FS1L072NG	FS2L072NG	FS3L072NG	FS4L072NG	FSSL072NG
96	FS1L096NG	FS2L096NG	FS3L096NG	FS4L096NG	FSSL096NG
144	FS1L144NG	FS2L144NG	FS3L144NG	FS4L144NG	FSSL144NG
Outside Plant – Dry Buffer Tubes					
6	FS1L006NC	FS2L006NC	FS3L006NC	FS4L006NC	FSSL006NC
12	FS1L012ND	FS2L012ND	FS3L012ND	FS4L012ND	FSSL012ND
24	FS1L024ND	FS2L024ND	FS3L024ND	FS4L024ND	FSSL024ND
36	FS1L036ND	FS2L036ND	FS3L036ND	FS4L036ND	FSSL036ND
48	FS1L048ND	FS2L048ND	FS3L048ND	FS4L048ND	FSSL048ND
72	FS1L072ND	FS2L072ND	FS3L072ND	FS4L072ND	FSSL072ND
96	FS1L096ND	FS2L096ND	FS3L096ND	FS4L096ND	FSSL096ND
144	FS1L144ND	FS2L144ND	FS3L144ND	FS4L144ND	FSSL144ND

Faster.
Easier.
Better.

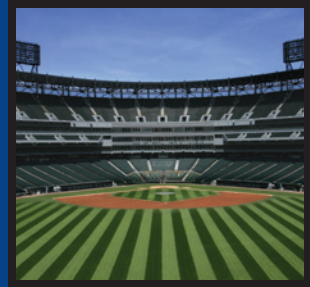

Single-Jacket, All Dielectric Loose Tube Cables (continued) Loose Tube – Indoor/Outdoor Riser

Gel-Filled or Dry Blocked buffer tubes prevent water migration. All-dielectric strength member. Available as Riser rated cable, thereby eliminating the need for service entrance splicing to in-building cable. Full dielectric construction, no grounding required. Available with up to 144 fibers. Length markings in meters for easy determination of cable length.

Applications:

- Medium to high fiber count requirements
- Inter-building duct installations
- Lashed aerial
- Indoor/outdoor

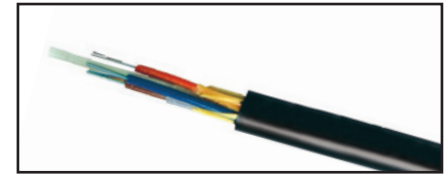

Name	Construction	Fiber Count	Cable OD		Weight		Tensile Strength lsb-f																									
			mm	in.	Kg/km	lb/1000 ft.	Installation		Operation																							
							N	lbs-f	N	lbs-f																						
Unitized 6-Fiber Sub-Units		6	12.9	0.51	164	110	2700	600	890	200																						
											Unitized 12-Fiber Sub-Units		12	12.9	0.51	164	110	2700	600	890	200											
													24																			
													36																			
Unitized 12-Fiber Sub-Units		72	13.7	0.54	190	128	2700	600	890	200																						
											Unitized 12-Fiber Sub-Units		96	15.5	0.61	237	159	2700	600	890	200											
																						Unitized 12-Fiber Sub-Units		144	19.3	0.76	361	243	2700	600	890	200

Above specifications provide a general representation for the product family. Improved specifications may exist for Riser, Plenum or LSZH constructions. Consult individual technical data sheets for exact specifications.

No. of Fibers	No. of Fibers Per Bundle	Smart Part to Legacy Part Number Cross				
		OM1	OM2	OM3	OM4	OS2
Riser (NEC/CEC OFNR/OFN FT.4) Indoor/Outdoor – Gel Filled Buffer Tubes						
6	6	FD1L006RF	FD2L006RF	FD3L006RF	FD4L006RF	FDSL006RF
12	12	FD1L012RG	FD2L012RG	FD3L012RG	FD4L012RG	FDSL012RG
24	12	FD1L024RG	FD2L024RG	FD3L024RG	FD4L024RG	FDSL024RG
36	12	FD1L036RG	FD2L036RG	FD3L036RG	FD4L036RG	FDSL036RG
48	12	FD1L048RG	FD2L048RG	FD3L048RG	FD4L048RG	FDSL048RG
72	12	FD1L072RG	FD2L072RG	FD3L072RG	FD4L072RG	FDSL072RG
96	12	FD1L096RG	FD2L096RG	FD3L096RG	FD4L096RG	FDSL096RG
144	12	FD1L144RG	FD2L144RG	FD3L144RG	FD4L144RG	FDSL144RG
Riser (NEC/CEC OFNR/OFN FT.4) Indoor/Outdoor – Dry Buffer Tubes						
6	6	FD1L006RC	FD2L006RC	FD3L006RC	FD4L006RC	FDSL006RC
12	12	FD1L012RD	FD2L012RD	FD3L012RD	FD4L012RD	FDSL012RD
24	12	FD1L024RD	FD2L024RD	FD3L024RD	FD4L024RD	FDSL024RD
36	12	FD1L036RD	FD2L036RD	FD3L036RD	FD4L036RD	FDSL036RD
48	12	FD1L048RD	FD2L048RD	FD3L048RD	FD4L048RD	FDSL048RD
72	12	FD1L072RD	FD2L072RD	FD3L072RD	FD4L072RD	FDSL072RD
96	12	FD1L096RD	FD2L096RD	FD3L096RD	FD4L096RD	FDSL096RD
144	12	FD1L144RD	FD2L144RD	FD3L144RD	FD4L144RD	FDSL144RD

Jacket Specifications

Jacket Material	Riser	PVC
Buffer Tube		PBT
Strength Member		Aramid Yarn
Central Strength Member		E-Glass
Color Code (Buffer)		Per TIA/EIA 598-B
Jacket Color		Black

Ratings

Riser	UL Type	OFNR
	cUL Type	OFN FT4
	Flame Resistance	UL 1666

Specifications

Min. Bend Radius	Installation	20 x OD
	Long Term	15 x OD
Temperature Range (Riser Series)	Storage	-40°C to 75°C
	Operating	-40°C to 70°C

Legend

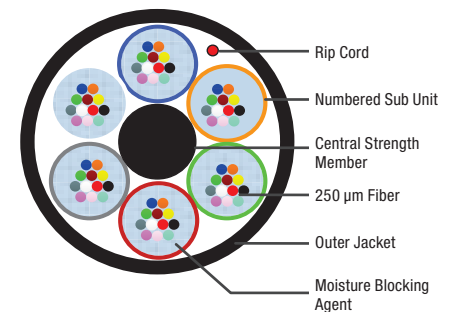

Compliance

- TIA/EIA-568-C.3
- ICEA S-104-696
- GR-20-CORE

Single-Jacket, Single Armor Loose Tube Cables Loose Tube – Outdoor

Gel-Filled or Dry Blocked buffer tubes prevent water migration. Available as Riser rated cable, thereby eliminating the need for service entrance splicing to in-building cable. Rodent resistant. Available in sizes up to 144 fibers. Length markings in meters for easy determination of cable length.

Applications:

- Direct burial
- Low to high fiber count requirements
- Inter-building duct installations
- Industrial outside plant (OSP Type)

Jacket Specifications

Jacket Material	PE
Outdoor	PE
Riser	PVC
Buffer Tube	Thermoplastic
Strength Member	Aramid Yarn
Central Strength Member	E-Glass
Armor	Corrugated Steel Tape
Color Code (Buffer)	Per TIA/EIA 598-B
Jacket Color	Black

Specifications

Temperature Range (Outdoor)	
Storage	-40°C to 75°C
Operating	-40°C to 70°C
Min. Bend Radius	
Installation	20 x OD
Long Term	15 x OD

Legend

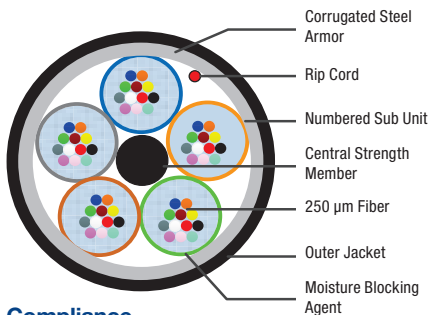

Compliance

- TIA/EIA-568-C.3
- ICEA S-87-640
- GR-20-CORE

Name	Construction	Fiber Count	Cable OD		Weight		Tensile Strength lsb-f			
			mm	in.	Kg/km	lb/1000 ft.	Installation		Operation	
							N	lbs-f	N	lbs-f
Unitized 6-Fiber Sub-Units		6	13.2	0.52	140	94	2700	600	800	180
Unitized 12-Fiber Sub-Units		12	13.2	0.52	140	94	2700	600	800	180
		24								
		36								
		48								
		72	14	0.55	161	108				
		96	15.8	0.62	193	130				
		144	19.6	0.77	285	192				

Above specifications provide a general representation for the product family. Improved specifications may exist for Riser, Plenum or LSZH constructions. Consult individual technical data sheets for exact specifications.

No. of Fibers	No. of Fibers Per Bundle	Belden Part Number				
		OM1	OM2	OM3	OM4	OS2
Outside Plant – Gel Filled Buffer Tubes						
6	6	FS1L0066F	FS2L0066F	FS3L0066F	FS4L0066F	FSSL0066F
12	12	FS1L0126G	FS2L0126G	FS3L0126G	FS4L0126G	FSSL0126G
24	12	FS1L0246G	FS2L0246G	FS3L0246G	FS4L0246G	FSSL0246G
48	12	FS1L0486G	FS2L0486G	FS3L0486G	FS4L0486G	FSSL0486G
72	12	FS1L0726G	FS2L0726G	FS3L0726G	FS4L0726G	FSSL0726G
96	12	FS1L0966G	FS2L0966G	FS3L0966G	FS4L0966G	FSSL0966G
144	12	FS1L1446G	FS2L1446G	FS3L1446G	FS4L1446G	FSSL1446G
Outside Plant – Dry Buffer Tubes						
6	6	FS1L0066C	FS2L0066C	FS3L0066C	FS4L0066C	FSSL0066C
12	12	FS1L0126D	FS2L0126D	FS3L0126D	FS4L0126D	FSSL0126D
24	12	FS1L0246D	FS2L0246D	FS3L0246D	FS4L0246D	FSSL0246D
48	12	FS1L0486D	FS2L0486D	FS3L0486D	FS4L0486D	FSSL0486D
72	12	FS1L0726D	FS2L0726D	FS3L0726D	FS4L0726D	FSSL0726D
96	12	FS1L0966D	FS2L0966D	FS3L0966D	FS4L0966D	FSSL0966D
144	12	FS1L1446D	FS2L1446D	FS3L1446D	FS4L1446D	FSSL1446D

Faster.
Easier.
Better.

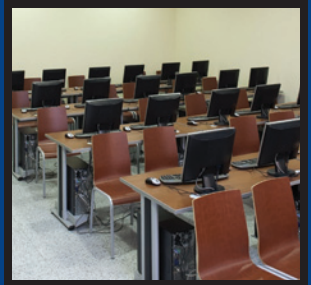

Double-Jacket, Armored Loose Tube Cables Loose Tube – Outdoor

Gel-filled buffer tubes prevent water migration. Available as Riser rated cable, thereby eliminating the need for service entrance splicing to in-building cable. Rodent resistant. Available in sizes up to 216 fibers. Length markings in meters for easy determination of cable length.

Applications:

- Direct burial
- Low to high fiber count requirements
- Inter-building duct installations
- Industrial outside plant (OSP Type)

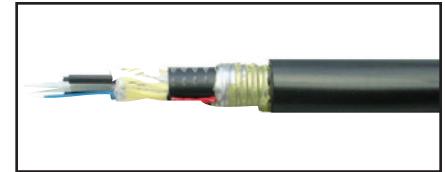

Name	Construction	Fiber Count	Cable OD		Weight		Tensile Strength lsb-f			
			mm	in.	Kg/km	lb/1000 ft.	Installation		Operation	
							N	lbs-f	N	lbs-f
Unitized 6-Fiber Sub-Units		6	15.5	0.62	200	134	2670	600	890	200
Unitized 12-Fiber Sub-Units		12	15.5	0.62	200	134	2670	600	890	200
		24								
		36								
		48								
		72	16.4	0.65	206	138				
	96	18.2	0.72	254	170					
	144	22.9	0.9	385	259					

Above specifications provide a general representation for the product family. Improved specifications may exist for Riser, Plenum or LSZH constructions. Consult individual technical data sheets for exact specifications.

No. of Fibers	No. of Fibers Per Bundle	Belden Part Number				
		OM1	OM2	OM3	OM4	OS2
Outdoor						
6	6	FS1H0066F	FS2H0066F	FS3H0066F	FS4H0066F	FSSH0066F
12	12	FS1H0126G	FS2H0126G	FS3H0126G	FS4H0126G	FSSH0126G
24	12	FS1H0246G	FS2H0246G	FS3H0246G	FS4H0246G	FSSH0246G
36	12	FS1H0366G	FS2H0366G	FS3H0366G	FS4H0366G	FSSH0366G
48	12	FS1H0486G	FS2H0486G	FS3H0486G	FS4H0486G	FSSH0486G
72	12	FS1H0726G	FS2H0726G	FS3H0726G	FS4H0726G	FSSH0726G
96	12	FS1H0966G	FS2H0966G	FS3H0966G	FS4H0966G	FSSH0966G
144	12	FS1H1446G	FS2H1446G	FS3H1446G	FS4H1446G	FSSH1446G

Jacket Specifications

Jacket Material	
Outdoor	PE
Riser	PVC
Buffer Tube	Thermoplastic
Strength Member	Aramid Yarn
Central Strength Member	E-Glass
Armor	Corrugated Steel Tape
Color Code (Buffer)	Per TIA/EIA 598-B
Jacket Color	Black

Specifications

Temperature Range (Outdoor)	
Storage	-40°C to 75°C
Operating	-40°C to 70°C
Min. Bend Radius	
Installation	20 x OD
Long Term	15 x OD

Legend

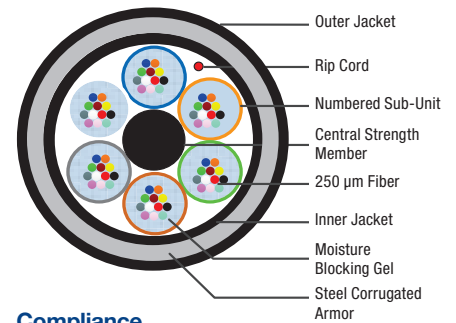

Compliance

- TIA/EIA-568-C.3
- ICEA S-87-640
- GR-20-CORE

Double-Jacket, Armored Loose Tube Cables (continued) Loose Tube – Indoor/Outdoor Riser Rated

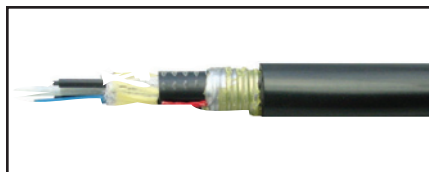

Gel-filled buffer tubes prevent water migration. Available as Riser rated cable, thereby eliminating the need for service entrance splicing to in-building cable. Rodent resistant. Available in sizes up to 216 fibers. Length markings in meters for easy determination of cable length.

Applications:

- Direct burial
- Low to high fiber count requirements
- Inter-building duct installations
- Indoor/outdoor

Jacket Specifications

Jacket Material	PVC
Riser	
Buffer Tube	Thermoplastic
Strength Member	Aramid Yarn
Central Strength Member	E-Glass
Armor	Corrugated Steel Tape
Color Code (Buffer)	Per TIA/EIA 598-B
Jacket Color	Black

Ratings

Riser	OFCR
--------------	------

Specifications

Temperature Range (Riser)

Storage	-40°C to 80°C
Operating	-40°C to 70°C

Min. Bend Radius

Installation	20 x OD
Long Term	15 x OD

Legend

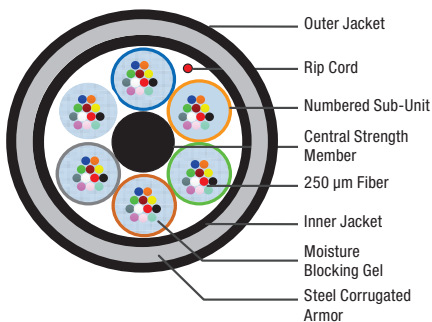

Compliance

- TIA/EIA-568-C.3
- ICEA S-104-696
- GR-20-CORE

Name	Construction	Fiber Count	Cable OD		Weight		Tensile Strength lsb-f			
			mm	in.	Kg/km	lb/1000 ft.	Installation		Operation	
							N	lbs-f	N	lbs-f
Unitized 6-Fiber Sub-Units		6	13.7	0.54	205	138	2700	600	890	200
Unitized 12-Fiber Sub-Units		12	13.7	0.54	205	138	2700	600	890	200
		24								
		36								
		48								
		72	16.8	0.66	256	172				
		96	17.8	0.7	307	206				
		144	22.4	0.88	449	302				

Above specifications provide a general representation for the product family. Improved specifications may exist for Riser, Plenum or LSZH constructions. Consult individual technical data sheets for exact specifications.

No. of Fibers	No. of Fibers Per Bundle	Belden Part Number				
		OM1	OM2	OM3	OM4	OS2
Riser (NEC/CEC OFCR/OFC FT.4) Indoor/Outdoor						
6	6	FD1H0065F	FD2H0065F	FD3H0065F	FD4H0065F	FDSH0065F
12	12	FD1H0125G	FD2H0125G	FD3H0125G	FD4H0125G	FDSH0125G
24	12	FD1H0245G	FD2H0245G	FD3H0245G	FD4H0245G	FDSH0245G
36	12	FD1H0365G	FD2H0365G	FD3H0365G	FD4H0365G	FDSH0365G
48	12	FD1H0485G	FD2H0485G	FD3H0485G	FD4H0485G	FDSH0485G
72	12	FD1H0725G	FD2H0725G	FD3H0725G	FD4H0725G	FDSH0725G
96	12	FD1H0965G	FD2H0965G	FD3H0965G	FD4H0965G	FDSH0965G
144	12	FD1H1445G	FD2H1445G	FD3H1445G	FD4H1445G	FDSH1445G

Faster.
Easier.
Better.



Double-Jacket, Heavy-Duty Loose Tube Cables Loose Tube – Outdoor

Gel-filled buffer tubes prevent water migration. Available with up to 216 fibers.

Applications:

- Direct burial
- Harsh environments
- Applications requiring good ozone-, moisture- and weather-resistance

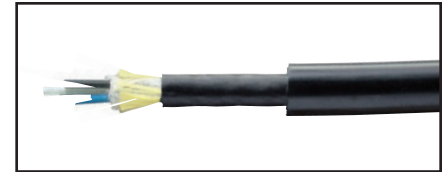

Name	Construction	Fiber Count	Cable OD		Weight		Tensile Strength lsb-f				
			mm	in.	Kg/km	lb/1000 ft.	Installation		Operation		
							N	lbs-f	N	lbs-f	
Unitized 12-Fiber Sub-Units		2	12.5	0.49	125	84	2700	600	890	200	
		4									
		6									
Unitized 12-Fiber Sub-Units		12	12.5	0.49	125	84	2700	600	890	200	
		24									
		36									
		48									
		72	13.4	0.53	144	97					
			96	15.2	0.6	180					121
			144	19	0.75	274					184

Above specifications provide a general representation for the product family. Improved specifications may exist for Riser, Plenum or LSZH constructions. Consult individual technical data sheets for exact specifications.

No. of Fibers	No. of Fibers Per Bundle	Belden Part Number				
		OM1	OM2	OM3	OM4	OS2
Outdoor						
2	2	FS1H002NF	FS2H002NF	FS3H002NF	FS4H002NF	FSSH002NF
4	4	FS1H004NF	FS2H004NF	FS3H004NF	FS4H004NF	FSSH004NF
6	6	FS1H006NF	FS2H006NF	FS3H006NF	FS4H006NF	FSSH006NF
8	8	FS1H008NG	FS2H008NG	FS3H008NG	FS4H008NG	FSSH008NG
12	12	FS1H012NG	FS2H012NG	FS3H012NG	FS4H012NG	FSSH012NG
18	12	FS1H018NG	FS2H018NG	FS3H018NG	FS4H018NG	FSSH018NG
24	12	FS1H024NG	FS2H024NG	FS3H024NG	FS4H024NG	FSSH024NG
36	12	FS1H036NG	FS2H036NG	FS3H036NG	FS4H036NG	FSSH036NG
48	12	FS1H048NG	FS2H048NG	FS3H048NG	FS4H048NG	FSSH048NG
72	12	FS1H072NG	FS2H072NG	FS3H072NG	FS4H072NG	FSSH072NG
96	12	FS1H096NG	FS2H096NG	FS3H096NG	FS4H096NG	FSSH096NG
144	12	FS1H144NG	FS2H144NG	FS3H144NG	FS4H144NG	FSSH144NG
216	12	FS1H216NG	FS2H216NG	FS3H216NG	FS4H216NG	FSSH216NG

Jacket Specifications

Jacket Material	Outdoor	PE
Buffer Tube		PBT
Strength Member		Aramid Yarn
Central Strength Member		E-Glass
Core Wrap		Water Swellable Tape
Color Code (Buffer)		Per TIA/EIA 598-B
Jacket Color		Black

Specifications

Temperature Range		
Storage		-40°C to 75°C
Operating		-40°C to 70°C
Min. Bend Radius		
Installation		20 x OD
Long Term		15 x OD

Legend

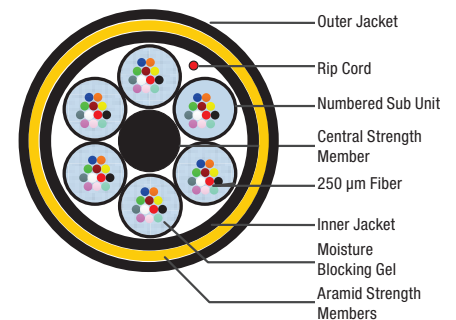

Compliance

- TIA/EIA-568-C.3
- ICEA S-87-640
- GR-20-CORE

Central Tube Cables

Loose Tube – Outdoor, and Outdoor Armored



Economical option for low fiber counts. Quick and easy end preparation. Fully waterblocked with gel-filled buffer tube. No rods – easy handling. Crush, impact and abrasion resistant.

Applications:

- Campus OSP backbones
- Drop cable
- Telecommunications and data trunk
- Direct burial (armored only)
- Lashed aerial

Jacket Specifications

Jacket Material	PE
Buffer Tube	PBT
Core Wrap	Water Swellable Tape
Strength Member	Fiberglass
Armor	Corrugated Steel Tape
Color Code (Buffer)	Per TIA/EIA 598-B
Jacket Color	Black

Specifications

Temperature Range	
Storage	-40°C to 75°C
Operating	-40°C to 70°C
Min. Bend Radius	
Installation	20 x OD
Long Term	15 x OD

Legend

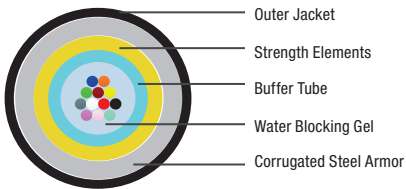

Compliance

- TIA/EIA-568-C.3
- GR-20-CORE
- ICEA S-87-640

Name	Construction	Fiber Count	Cable OD		Weight		Tensile Strength lsb-f			
			mm	in.	Kg/km	lb/1000 ft.	Installation		Operation	
Outdoor										
Single Subunit		2	7.8	0.31	50	34	2700	600	890	200
		4								
		6								
		8								
		12								
24										

Above specifications provide a general representation for the product family. Improved specifications may exist for Riser, Plenum or LSZH constructions. Consult individual technical data sheets for exact specifications.

No. of Fibers	Belden Part Number				
	OM1	OM2	OM3	OM4	OS2
Outdoor					
2	FS1C002N0	FS2C002N0	FS3C002N0	FS4C002N0	FSSC002N0
4	FS1C004N0	FS2C004N0	FS3C004N0	FS4C004N0	FSSC004N0
6	FS1C006N0	FS2C006N0	FS3C006N0	FS4C006N0	FSSC006N0
8	FS1C008N0	FS2C008N0	FS3C008N0	FS4C008N0	FSSC008N0
10	FS1C010N0	FS2C010N0	FS3C010N0	FS4C010N0	FSSC010N0
12	FS1C012N0	FS2C012N0	FS3C012N0	FS4C012N0	FSSC012N0

Name	Construction	Fiber Count	Cable OD		Weight		Tensile Strength lsb-f			
			mm	in.	Kg/km	lb/1000 ft.	Installation		Operation	
Outdoor Armored										
Single Subunit		2	12.2	0.48	140	95	2700	600	890	200
		4								
		6								
		8								
		12								
24										

Above specifications provide a general representation for the product family. Improved specifications may exist for Riser, Plenum or LSZH constructions. Consult individual technical data sheets for exact specifications.

No. of Fibers	Belden Part Number				
	OM1	OM2	OM3	OM4	OS2
Outdoor Armored					
2	FS1C00260	FS2C00260	FS3C00260	FS4C00260	FSSC00260
4	FS1C00460	FS2C00460	FS3C00460	FS4C00460	FSSC00460
6	FS1C00660	FS2C00660	FS3C00660	FS4C00660	FSSC00660
8	FS1C00860	FS2C00860	FS3C00860	FS4C00860	FSSC00860
10	FS1C01060	FS2C01060	FS3C01060	FS4C01060	FSSC01060
12	FS1C01260	FS2C01260	FS3C01260	FS4C01260	FSSC01260

Faster.
Easier.
Better.



FiberExpress Drop Cables Tight Buffer - Indoor/Outdoor Riser

Fast installation, easy termination. Cables provide easy routing and 900 µm tight-buffered fiber support fast and robust field terminations. Ideal for fiber to the subscriber applications.

Indoor/Outdoor Specifications:

*Environmental Protection

- UV Resistant Jacket
- Moisture Resistant Jacket
- Fungus Resistant Jacket
- Water blocking aramid

Name	Construction	Fiber Count	Cable OD		Weight		Tensile Strength lsb-f			
			mm	in.	Kg/km	lb/1000 ft.	Operation		Installation	
							N	lbs-f	N	lbs-f
1 Fiber Drop Cable		1	4.8	0.19	21	14	200	40	445	100

Above specifications provide a general representation for the product family. Improved specifications may exist for Riser, Plenum or LSZH constructions. Consult individual technical data sheets for exact specifications.

Fiber Count	Belden Part Number	
	Black	White
Drop cable with ITU G.657.B3 Glass – Riser		
1	FDCP001R9	FDCP001R9W
Drop cable with ITU G.657.B3 Glass – Riser – 450m Reel-In-A-Box Put-Up		
1	FDCP001R9NBY	FDCP001R9WBY

Specifications

Temperature Range

Storage	-40°C to 75°C
Operating	-40°C to 70°C

Min. Bend Radius

Installation	0.2" (5 mm)
Long Term	0.2" (5 mm)

Temperature Range

Temperature Range

Storage	-40°C to 75°C
Operating	-40°C to 70°C

Legend

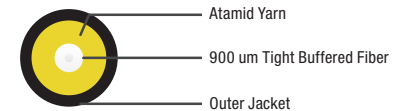

Compliance

- TIA/EIA-568-C.3
- ICEA-S-104-696
- G(ETL)US TYPE OFNR
- CSA OFN FT4
- TPR.9424

Part Number Index

Part No.	Page	Part No.	Page	Part No.	Page	Part No.	Page	Part No.	Page
A0643206	28	AX103930	16	AX105207-B25	4	AX106818	16	FC4L12LDMF1E	11
A0643207	28	AX103932	16	AX105208-B25	4	AX203567	5	FC4R06SDMF	11
A0649869	17	AX103934	16	AX105208-S1	4	AX203568	5	FC4R06SDMF1E	11
AC301420	17	AX104019	15	AX105209-B25	4	AX203569	5	FC4R12LDMF	11
AC302349	17	AX104023	15	AX105209-S1	4	AX203895	5	FC4R12LDMF1E	11
AX100041	17	AX104024	15	AX105210-B25	4	AX203930	5	FC4U04LD4F	12
AX100045	17	AX104210	15	AX105212-B25	4	FC1H06SDFS	10	FC4U06SDMF	10
AX100066	17	AX104214	15	AX105213-B25	4	FC1H12LDFS	10	FC4U06SDMF1E	10
AX100068	17	AX104215	15	AX105213-S1	4	FC1H12MPFS	10	FC4U08LD4F	12
AX100094	17	AX104271	5	AX105214-B25	4	FC1U06SDMF	10	FC4U12LD4F	12
AX100098	17	AX104276	5	AX105215-B25	4	FC1U06SDMF1T	10	FC4U12LDMF	10
AX100116	17	AX104278	5	AX105252-B25	4	FC1U12LDMF	10	FC4U12LDMF1E	10
AX100220	29	AX104279	5	AX105253-B25	4	FC1U12LDMF1T	10	FC4U034MMF	12
AX100221	29	AX104280	5	AX105254-B25	4	FC3H06SDFS	10	FC4U064MMF	12
AX100222	29	AX104281	5	AX105379	9	FC3H12LDFS	10	FCSH06SDFS	10
AX100223	29	AX104282	5	AX105505-AL	29	FC3H12MPFS	10	FCSH12LAFS	10
AX100495	17	AX104283	5	AX105505-BK	29	FC3H16LD4F	12	FCSH12LDFS	10
AX100528	17	AX104286	5	AX105505-WH	29	FC3H18LDMF	10	FCSH12MPFS	10
AX100532	17	AX104289	5	AX105537	17	FC3H18LDMF1A	10	FCSH12SBFS	10
AX100534	17	AX104290	5	AX105561	17	FC3L06SDMF	11	FCSH12STFS	10
AX100540	17	AX104291	5	AX105563	9	FC3L06SDMF1A	11	FCSH16LD4F	12
AX100542	17	AX104293	5	AX105564	9	FC3L12LD4F	12	FCSH18LDMF	10
AX100951	5	AX104572	15	AX105565	9	FC3L12LDMF	11	FCSH18LDMF1G	10
AX101100	5	AX104593	5	AX105641-AL	15, 29	FC3L12LDMF1A	11	FCSH18LDMF	10
AX101101	5	AX104615	29	AX105641-BK	15, 29	FC3R06SDMF	11	FCSH18LDMF1B	10
AX101320	15	AX104681	9	AX105641-EW	15, 29	FC3R06SDMF1A	11	FCSL06SDMF	11
AX101321	15	AX104682	9	AX105643-AL	15, 29	FC3R12LDMF	11	FCSL06SDMF1B	11
AX101326	15	AX104683	9	AX105643-BK	15, 29	FC3R12LDMF1A	11	FCSL12LD4F	12
AX101407	17	AX104684	9	AX105643-EW	15, 29	FC3U04LD4F	12	FCSL12LDMF	11
AX101409	17	AX104685	10, 15	AX105646-B25	29	FC3U06SDMF	10	FCSL12LDMF1B	11
AX101729	17	AX104695	5	AX105672	9	FC3U06SDMF1A	10	FCSR06SDMF	11
AX101731	17	AX104696	5	AX105673	9	FC3U08LD4F	12	FCSR06SDMF1B	11
AX101741	17	AX104934	17	AX105674	9	FC3U12LD4F	12	FCSR12LDMF	11
AX101743	17	AX104937	15, 29	AX105675	9	FC3U12LDMF	10	FCSR12LDMF1B	11
AX102242	15, 29	AX104938	15, 29	AX105676	9	FC3U12LDMF1A	10	FCSU04LD4F	12
AX102243	15, 29	AX104939	15, 29	AX105678	9	FC3U034MMF	12	FCSU06SAMF	10
AX102244	15, 29	AX105002-B25	29	AX105691-B25	29	FC3U064MMF	12	FCSU06SAMF1G	10
AX102282	15	AX105162	9	AX105692-B25	29	FC4H06SDFS	10	FCSU06SDMF	10
AX102283	15	AX105164	9	AX105693-B25	29	FC4H12LDFS	10	FCSU06SDMF1B	10
AX102288	15	AX105165	9	AX105694-B25	29	FC4H12MPFS	10	FCSU08LD4F	12
AX102683	15, 29	AX105166	9	AX105697-AL	29	FC4H16LD4F	12	FCSU12LAMF	10
AX102684	15, 29	AX105167	9	AX105697-BK	29	FC4H18LDMF	10	FCSU12LAMF1G	10
AX102685	15, 29	AX105200-B25	4	AX105697-WH	29	FC4H18LDMF1E	10	FCSU12LD4F	12
AX103151	5	AX105202-B25	4	AX105700	15	FC4L06SDMF	11	FCSU12LDMF	10
AX103912	16	AX105203-B25	4	AX105812	9	FC4L06SDMF1E	11	FCSU12LDMF1B	10
AX103913	16	AX105203-S1	4	AX105813	9	FC4L12LD4F	12	FCSU12SBMF	10
AX103928	16	AX105205-B25	4	AX106817	16	FC4L12LDMF	11	FCSU12SBMF1G	10

Faster.
Easier.
Better.

Part No.	Page	Part No.	Page	Part No.	Page	Part No.	Page	Part No.	Page
FCSU12SCMF	10	FD1L012RG	47	FD3D012R9	37	FD4D006F9	41	FD4L096RD	47
FCSU12SCMF1B	10	FD1L024RD	47	FD3D024A9	41	FD4D006L9	37	FD4L096RG	47
FCSU034MMF	12	FD1L024RG	47	FD3D024AJ	41	FD4D006P9	37	FD4L144RD	47
FCSU064MMF	12	FD1L036RD	47	FD3D024F9	41	FD4D006R9	37	FD4L144RG	47
FCZ00BBFS	10	FD1L036RG	47	FD3D024L9	37	FD4D012A9	41	FDCP001R9	53
FD1D002L9	37	FD1L048RD	47	FD3D024P9	37	FD4D012F9	41	FDCP001R9NBY	53
FD1D002P9	37	FD1L048RG	47	FD3D024PJ	37	FD4D012L9	37	FDCP001R9W	53
FD1D002R9	37	FD1L072RD	47	FD3D024R9	37	FD4D012P9	37	FDCP001R9WBY	53
FD1D006A9	41	FD1L072RG	47	FD3D024RJ	37	FD4D012R9	37	FSDS002L9	37
FD1D006F9	41	FD1L096RD	47	FD3D024RK	41	FD4D024A9	41	FSDS002P9	37
FD1D006L9	37	FD1L096RG	47	FD3D048LK	37	FD4D024AJ	41	FSDS002R9	37
FD1D006P9	37	FD1L144RD	47	FD3D048PK	37	FD4D024F9	41	FSDS006A9	41
FD1D006R9	37	FD1L144RG	47	FD3D072AK	41	FD4D024L9	37	FSDS006F9	41
FD1D012A9	41	FD2H0065F	50	FD3D072LK	37	FD4D024P9	37	FSDS006L9	37
FD1D012F9	41	FD2H0125G	50	FD3D072PK	37	FD4D024PJ	37	FSDS006P9	37
FD1D012L9	37	FD2H0245G	50	FD3D096AK	41	FD4D024R9	37	FSDS006R9	37
FD1D012P9	37	FD2H0365G	50	FD3D096LK	37	FD4D024RJ	37	FSDS012A9	41
FD1D012R9	37	FD2H0485G	50	FD3D096PK	37	FD4D048AK	41	FSDS012F9	41
FD1D024A9	41	FD2H0725G	50	FD3D144AK	41	FD4D048LK	37	FSDS012L9	37
FD1D024AJ	41	FD2H0965G	50	FD3D144LK	37	FD4D048PK	37	FSDS012P9	37
FD1D024F9	41	FD2H1445G	50	FD3D144PK	37	FD4D072AK	41	FSDS012R9	37
FD1D024L9	37	FD2L006RC	47	FD3H0065F	50	FD4D072LK	37	FSDS024A9	41
FD1D024P9	37	FD2L006RF	47	FD3H0125G	50	FD4D072PK	37	FSDS024AJ	41
FD1D024PJ	37	FD2L012RD	47	FD3H0245G	50	FD4D096AK	41	FSDS024F9	41
FD1D024R9	37	FD2L012RG	47	FD3H0365G	50	FD4D096LK	37	FSDS024L9	37
FD1D024RJ	37	FD2L024RD	47	FD3H0485G	50	FD4D096PK	37	FSDS024P9	37
FD1D048AK	41	FD2L024RG	47	FD3H0725G	50	FD4D144AK	41	FSDS024PJ	37
FD1D048LK	37	FD2L036RD	47	FD3H0965G	50	FD4D144LK	37	FSDS024R9	37
FD1D048PK	37	FD2L036RG	47	FD3H1445G	50	FD4D144PK	37	FSDS024RJ	37
FD1D072AK	41	FD2L048RD	47	FD3L006RC	47	FD4H0065F	50	FSDS048AK	41
FD1D072LK	37	FD2L048RG	47	FD3L006RF	47	FD4H0125G	50	FSDS048LK	37
FD1D072PK	37	FD2L072RD	47	FD3L012RD	47	FD4H0245G	50	FSDS048PK	37
FD1D096AK	41	FD2L072RG	47	FD3L012RG	47	FD4H0365G	50	FSDS072AK	41
FD1D096LK	37	FD2L096RD	47	FD3L024RD	47	FD4H0485G	50	FSDS072LK	37
FD1D096PK	37	FD2L096RG	47	FD3L024RG	47	FD4H0725G	50	FSDS072PK	37
FD1D144AK	41	FD2L144RD	47	FD3L036RD	47	FD4H0965G	50	FSDS096AK	41
FD1D144LK	37	FD2L144RG	47	FD3L036RG	47	FD4H1445G	50	FSDS096LK	37
FD1D144PK	37	FD3D002L9	37	FD3L048RD	47	FD4L006RC	47	FSDS096PK	37
FD1H0065F	50	FD3D002P9	37	FD3L048RG	47	FD4L006RF	47	FSDS144AK	41
FD1H0125G	50	FD3D002R9	37	FD3L072RD	47	FD4L012RD	47	FSDS144LK	37
FD1H0245G	50	FD3D006A9	41	FD3L072RG	47	FD4L012RG	47	FSDS144PK	37
FD1H0365G	50	FD3D006F9	41	FD3L096RD	47	FD4L024RD	47	FSDS0065F	50
FD1H0485G	50	FD3D006L9	37	FD3L096RG	47	FD4L024RG	47	FSDS0125G	50
FD1H0725G	50	FD3D006P9	37	FD3L144RD	47	FD4L036RD	47	FSDS0245G	50
FD1H0965G	50	FD3D006R9	37	FD3L144RG	47	FD4L036RG	47	FSDS0365G	50
FD1H1445G	50	FD3D012A9	41	FD4D002L9	37	FD4L048RD	47	FSDS0485G	50
FD1L006RC	47	FD3D012F9	41	FD4D002P9	37	FD4L048RG	47	FSDS0725G	50
FD1L006RF	47	FD3D012L9	37	FD4D002R9	37	FD4L072RD	47	FSDS0965G	50
FD1L012RD	47	FD3D012P9	37	FD4D006A9	41	FD4L072RG	47	FSDS1445G	50

Part No.	Page	Part No.	Page	Part No.	Page	Part No.	Page	Part No.	Page
FDSL006RC	47	FI1B006LB	33	FI3D002P9ABK	43	FI3M048P8	45	FI4I002P0	32
FDSL006RF	47	FI1B006PB	33	FI3D002R9	35	FI3M064P8	45	FI4I002PCEBK	43
FDSL012RD	47	FI1B012LB	33	FI3D004P9ABK	43	FI3M072P1	44	FI4I002RB	32
FDSL012RG	47	FI1B012PB	33	FI3D006A9	39	FI3M096P8	45	FI4I002RC	32
FDSL024RD	47	FI1D002P9	35	FI3D006F9	39	FI3M144P1	44	FI4I008P0	32
FDSL024RG	47	FI1D002P90BK	43	FI3D006P9	35	FI4B002LB	33	FI4I012P0	32
FDSL036RD	47	FI1D002R9	35	FI3D006P9ABK	43	FI4B002PB	33	FI4M008P2	45
FDSL036RG	47	FI1D004P90BK	43	FI3D006R9	35	FI4B002PBEBK	43	FI4M008P8	45
FDSL048RD	47	FI1D006A9	39	FI3D012A9	39	FI4B004LB	33	FI4M012P0	44
FDSL048RG	47	FI1D006F9	39	FI3D012F9	39	FI4B004PB	33	FI4M012P2	44
FDSL072RD	47	FI1D006P9	35	FI3D012P9	35	FI4B004PBEBK	43	FI4M012P2EBK	43
FDSL072RG	47	FI1D006P90BK	43	FI3D012P9ABK	43	FI4B006LB	33	FI4M024P1	44
FDSL096RD	47	FI1D006R9	35	FI3D012R9	35	FI4B006PB	33	FI4M024P8	45
FDSL096RG	47	FI1D012A9	39	FI3D024A9	39	FI4B012LB	33	FI4M032P8	45
FDSL144RD	47	FI1D012F9	39	FI3D024AJ	39	FI4B012PB	33	FI4M036P1	44
FDSL144RG	47	FI1D012P9	35	FI3D024F9	39	FI4D002P9	35	FI4M048P1	44
FF1U06SD	13	FI1D012P90BK	43	FI3D024P9	35	FI4D002P9EBK	43	FI4M048P8	45
FF1U12LD	13	FI1D012R9	35	FI3D024P9	35	FI4D002R9	35	FI4M064P8	45
FF3H18LD	13	FI1D024A9	39	FI3D024R9	35	FI4D004P9EBK	43	FI4M072P1	44
FF3H18MP	13	FI1D024AJ	39	FI3D024R9	35	FI4D006A9	39	FI4M096P8	45
FF3U06SD	13	FI1D024F9	39	FI3D024R9	35	FI4D006F9	39	FI4M144P1	44
FF3U12LD	13	FI1D024P9	35	FI3D024R9	35	FI4D006P9	35	FISB002LB	33
FF3U12MP	13	FI1D024P9	35	FI3D024R9	35	FI4D006P9EBK	43	FISB002PB	33
FF4H18LD	13	FI1D024R9	35	FI3D024R9	35	FI4D006R9	35	FISB002PBYBK	43
FF4H18MP	13	FI1D024R9	35	FI3D024R9	35	FI4D012A9	39	FISB004LB	33
FF4U06SD	13	FI1D024R9	35	FI3D024R9	35	FI4D012A9	39	FISB004LB	33
FF4U12LD	13	FI1D036PK	35	FI3D024R9	35	FI4D012F9	39	FISB004PB	33
FF4U12MP	13	FI1D048AK	39	FI3D024R9	35	FI4D012P9	35	FISB004PBYBK	43
FFSH18LA	13	FI1D048PK	35	FI3D024R9	35	FI4D012P9	35	FISB006LB	33
FFSH18LD	13	FI1D072AK	39	FI3D048AK	39	FI4D012P9EBK	43	FISB006PB	33
FFSH18MP	13	FI1D072PK	35	FI3D048PK	35	FI4D012R9	35	FISB012LB	33
FFSU06SA	13	FI1D096AK	39	FI3D072AK	39	FI4D024A9	39	FISB012LB	33
FFSU06SD	13	FI1D096PK	35	FI3D096AK	39	FI4D024AJ	39	FISB012PB	33
FFSU12LA	13	FI1D144AK	39	FI3D096PK	35	FI4D024F9	39	FISD002P9	35
FFSU12LD	13	FI1D144PK	35	FI3D144AK	39	FI4D024P9	35	FISD002P9YBK	43
FFSU12MP	13	FI1I001PC0BK	43	FI3D144PK	35	FI4D024P9	35	FISD002R9	35
FFSU12SB	13	FI1I002PC0BK	43	FI3D144PK	35	FI4D024P9	35	FISD004P9YBK	43
FFSU12SC	13	FI1M012P20BK	43	FI3I001PCABK	43	FI4D024P9	35	FISD006A9	39
FFSU12ST	13	FI3B002LB	33	FI3I001RB	32	FI4D024R9	35	FISD006F9	39
FFZH00BB	15	FI3B002PB	33	FI3I001RC	32	FI4D024R9	35	FISD006P9	35
FFZH06KC	15	FI3B002PBABK	43	FI3I002P0	32	FI4D024R9	35	FISD006P9YBK	43
FFZH08KC	15	FI3B004LB	33	FI3I002P0	32	FI4D024R9	35	FISD006R9	35
FI1B002LB	33	FI3B004PB	33	FI3I002PCABK	43	FI4D024R9	35	FISD012A9	39
FI1B002PB	33	FI3B004PBABK	43	FI3I002RB	32	FI4D024R9	35	FISD012F9	39
FI1B002PBOBK	43	FI3B006LB	33	FI3I002RC	32	FI4D024R9	35	FISD012P9	35
FI1B004LB	33	FI3B012LB	33	FI3I008P0	32	FI4D024R9	35	FISD012P9YBK	43
FI1B004PB	33	FI3B012PB	33	FI3I008P0	32	FI4D036PK	35	FISD012R9	35
FI1B004PBOBK	43	FI3D002P9	35	FI3I012P0	32	FI4D048AK	39	FISD024A9	39
				FI3M008P2	45	FI4D048PK	35	FISD024AJ	39
				FI3M008P8	45	FI4D072AK	39	FISD024F9	39
				FI3M012P0	44	FI4D072PK	35		
				FI3M012P2	44	FI4D096AK	39		
				FI3M012P2ABK	43	FI4D096PK	35		
				FI3M024P1	44	FI4D144AK	39		
				FI3M024P8	45	FI4D144PK	35		
				FI3M032P8	45	FI4I001PCEBK	43		
				FI3M036P1	44	FI4I001RB	32		
				FI3M048P1	44	FI4I001RC	32		

Faster.
Easier.
Better.

Part No.	Page	Part No.	Page	Part No.	Page	Part No.	Page	Part No.	Page
FISD024P9	35	FP1SDSD005M	19	FP4LUMF005M	21	FPSLULU005M	19	FS1L024ND	46
FISD024PJ	35	FP1STST002M	19	FP4MFMF002M	19	FPSLUMF002M	21	FS1L024NG	46
FISD024R9	35	FP1STST003M	19	FP4MFMF003M	19	FPSLUMF003M	21	FS1L036ND	46
FISD024RJ	35	FP1STST005M	19	FP4MFMF005M	19	FPSLUMF005M	21	FS1L036NG	46
FISD036PK	35	FP3LDDL002M	19	FP4NFN002M	19	FPSMFMF002M	19	FS1L048ND	46
FISD048AK	39	FP3LDDL003M	19	FP4NFN003M	19	FPSMFMF003M	19	FS1L048NG	46
FISD048PK	35	FP3LDDL005M	19	FP4NFN005M	19	FPSMFMF005M	19	FS1L072ND	46
FISD072AK	39	FP3LSD002M	19	FP4SDSD002M	19	FPSNFN002M	19	FS1L072NG	46
FISD072PK	35	FP3LSD003M	19	FP4SDSD003M	19	FPSNFN003M	19	FS1L096ND	46
FISD096AK	39	FP3LSD005M	19	FP4SDSD005M	19	FPSNFN005M	19	FS1L096NG	46
FISD096PK	35	FP3LDST002M	19	FP4STST002M	19	FPSSASA002M	19	FS1L144ND	46
FISD144AK	39	FP3LDST003M	19	FP4STST003M	19	FPSSASA003M	19	FS1L144NG	46
FISD144PK	35	FP3LDST005M	19	FP4STST005M	19	FPSSASA005M	19	FS2C002N0	52
FISI001PCYBK	43	FP3LU4F002M	21	FP34F4F002M	19	FPSSSDSD002M	19	FS2C004N0	52
FISI001RB	32	FP3LU4F003M	21	FP34F4F003M	19	FPSSSDSD003M	19	FS2C006N0	52
FISI001RC	32	FP3LU4F005M	21	FP34F4F005M	19	FPSSSDSD005M	19	FS2C008N0	52
FISI002P0	32	FP3LULU002M	19	FP44F4F002M	19	FPSSTST002M	19	FS2C010N0	52
FISI002PCYBK	43	FP3LULU003M	19	FP44F4F003M	19	FPSSTST003M	19	FS2C012N0	52
FISI002RB	32	FP3LULU005M	19	FP44F4F005M	19	FPSSTST005M	19	FS2C00260	52
FISI002RC	32	FP3LUMF002M	21	FPS4F4F002M	19	FS1C002N0	52	FS2C00460	52
FISI008P0	32	FP3LUMF003M	21	FPS4F4F003M	19	FS1C004N0	52	FS2C00660	52
FISI012P0	32	FP3LUMF005M	21	FPS4F4F005M	19	FS1C006N0	52	FS2C00860	52
FISM008P2	45	FP3MFMF002M	19	FPSLALA002M	19	FS1C008N0	52	FS2C01060	52
FISM008P8	45	FP3MFMF003M	19	FPSLALA003M	19	FS1C010N0	52	FS2C01260	52
FISM012P0	44	FP3MFMF005M	19	FPSLALA005M	19	FS1C012N0	52	FS2H002NF	51
FISM012P2	44	FP3NFN002M	19	FPSLASA002M	19	FS1C00260	52	FS2H004NF	51
FISM012P2YBK	43	FP3NFN003M	19	FPSLASA003M	19	FS1C00460	52	FS2H006NF	51
FISM024P1	44	FP3NFN005M	19	FPSLASA005M	19	FS1C00660	52	FS2H008NG	51
FISM024P8	45	FP3SDSD002M	19	FPSLDDL002M	19	FS1C00860	52	FS2H012NG	51
FISM032P8	45	FP3SDSD003M	19	FPSLDDL003M	19	FS1C01060	52	FS2H018NG	51
FISM036P1	44	FP3SDSD005M	19	FPSLDDL005M	19	FS1C01260	52	FS2H024NG	51
FISM048P1	44	FP3STST002M	19	FPSLSDSD002M	19	FS1H002NF	51	FS2H036NG	51
FISM048P8	45	FP3STST003M	19	FPSLSDSD003M	19	FS1H004NF	51	FS2H048NG	51
FISM064P8	45	FP3STST005M	19	FPSLSDSD005M	19	FS1H006NF	51	FS2H072NG	51
FISM072P1	44	FP4LDDL002M	19	FPSLDST002M	19	FS1H008NG	51	FS2H096NG	51
FISM096P8	45	FP4LDDL003M	19	FPSLDST003M	19	FS1H012NG	51	FS2H144NG	51
FISM144P1	44	FP4LDDL005M	19	FPSLDST005M	19	FS1H018NG	51	FS2H216NG	51
FP1LDL002M	19	FP4LSD002M	19	FPSLFLF002M	19	FS1H024NG	51	FS2L006NC	46
FP1LDL003M	19	FP4LSD003M	19	FPSLFLF003M	19	FS1H036NG	51	FS2L006NF	46
FP1LDL005M	19	FP4LSD005M	19	FPSLFLF005M	19	FS1H048NG	51	FS2L012ND	46
FP1LSD002M	19	FP4LU4F002M	21	FPSLILI002M	19	FS1H072NG	51	FS2L012NG	46
FP1LSD003M	19	FP4LU4F003M	21	FPSLILI003M	19	FS1H096NG	51	FS2L024ND	46
FP1LSD005M	19	FP4LU4F005M	21	FPSLILI005M	19	FS1H144NG	51	FS2L024NG	46
FP1LDST002M	19	FP4LULU002M	19	FPSLU4F002M	21	FS1H216NG	51	FS2L036ND	46
FP1LDST003M	19	FP4LULU003M	19	FPSLU4F003M	21	FS1L006NC	46	FS2L036NG	46
FP1LDST005M	19	FP4LULU005M	19	FPSLU4F005M	21	FS1L006NF	46	FS2L048ND	46
FP1SDSD002M	19	FP4LUMF002M	21	FPSLULU002M	19	FS1L012ND	46	FS2L048NG	46
FP1SDSD003M	19	FP4LUMF003M	21	FPSLULU003M	19	FS1L012NG	46	FS2L072ND	46

Part No.	Page	Part No.	Page	Part No.	Page	Part No.	Page	Part No.	Page
FS2L072NG	46	FS4C010N0	52	FSSH002NF	51	FT3ST3MMPS01	7	FWSMBS06LA	28
FS2L096ND	46	FS4C012N0	52	FSSH004NF	51	FT3ST900PR12	7	FWSMBS06LD	28
FS2L096NG	46	FS4C00260	52	FSSH006NF	51	FT3ST900PS01	7	FWSWBF01SB	28
FS2L144ND	46	FS4C00460	52	FSSH008NG	51	FT4LC2MMPS01	7	FWSWBF01SC	28
FS2L144NG	46	FS4C00660	52	FSSH012NG	51	FT4LC250PR12	7	FWSWBF02SB	28
FS3C002N0	52	FS4C00860	52	FSSH018NG	51	FT4LC900PR12	7	FWSWBF02SC	28
FS3C004N0	52	FS4C01060	52	FSSH024NG	51	FT4LC900PS01	7	FWSWBF04SB	28
FS3C006N0	52	FS4C01260	52	FSSH036NG	51	FT4LD2MMPS01	7	FWSWBF04SC	28
FS3C008N0	52	FS4H002NF	51	FSSH048NG	51	FT4MM3MMPS01	7	FXBUBO250B25N	4
FS3C010N0	52	FS4H004NF	51	FSSH072NG	51	FT4MM250PS01	7	FXBUCLDB25N	4
FS3C012N0	52	FS4H006NF	51	FSSH096NG	51	FT4SC3MMPS01	7	FXBUCLDB25N	4
FS3C00260	52	FS4H008NG	51	FSSH144NG	51	FT4SC900PR12	7	FXFACLLDB25A	18
FS3C00460	52	FS4H012NG	51	FSSH216NG	51	FT4SC900PS01	7	FXFACLLDB25B	18
FS3C00660	52	FS4H018NG	51	FSSL006NC	46	FT4SD3MMPS01	7	FXFACLLDB25E	18
FS3C00860	52	FS4H024NG	51	FSSL006NF	46	FTSLA2MMPS01	7	FXFACLLDB25G	18
FS3C01060	52	FS4H036NG	51	FSSL012ND	46	FTSLB2MMPS01	7	FXFACLLDB25T	18
FS3C01260	52	FS4H048NG	51	FSSL012NG	46	FTSLB250PR12	7	FXFACLLMB25N	18
FS3H002NF	51	FS4H072NG	51	FSSL024ND	46	FTSLB900PR12	7	FXFUBRDHM	9
FS3H004NF	51	FS4H096NG	51	FSSL024NG	46	FTSLB900PS01	7	FXFUBRDHS	9
FS3H006NF	51	FS4H144NG	51	FSSL036ND	46	FTSLC2MMPS01	7	FXFUBRSHM	9
FS3H008NG	51	FS4H216NG	51	FSSL036NG	46	FTSLC250PR12	7	FXFUHS9T2CB25	7
FS3H012NG	51	FS4L006NC	46	FSSL048ND	46	FTSLC900PR12	7	FXFUHS250DB25	7
FS3H018NG	51	FS4L006NF	46	FSSL048NG	46	FTSLC900PS01	7	FXFUHS900AB25	7, 16
FS3H024NG	51	FS4L012ND	46	FSSL072ND	46	FTSLD2MMPS01	7	FXFUHSRIBEB12	7
FS3H036NG	51	FS4L012NG	46	FSSL072NG	46	FTSMM3MMPS01	7	SCSH1232SLF	14
FS3H048NG	51	FS4L024ND	46	FSSL096ND	46	FTSMM250PS01	7	SCSH2116SLF	14
FS3H072NG	51	FS4L024NG	46	FSSL096NG	46	FTSSA3MMPS01	7	SCSH2216LLF	14
FS3H096NG	51	FS4L036ND	46	FSSL144ND	46	FTSSB3MMPS01	7	SCSH4108LLF	14
FS3H144NG	51	FS4L036NG	46	FSSL144NG	46	FTSSB250PR12	7	SCSH4208MLF	14
FS3H216NG	51	FS4L048ND	46	FT13C3MMPS01	7	FTSSB900PR12	7	SCSU1208SLF	14
FS3L006NC	46	FS4L048NG	46	FT13C250PR12	7	FTSSB900PS01	7	SCSU1216SLF	14
FS3L006NF	46	FS4L072ND	46	FT13C900PR12	7	FTSSC3MMPS01	7	SCSU2208SLF	14
FS3L012ND	46	FS4L072NG	46	FT13C900PS01	7	FTSSC250PR12	7	TC3H02LDLDDL	14
FS3L012NG	46	FS4L096ND	46	FT1SD3MMPS01	7	FTSSC900PR12	7	TC3H06LDMFLD	14
FS3L024ND	46	FS4L096NG	46	FT1ST3MMPS01	7	FTSSC900PS01	7	TC3H06LDMFMM	14
FS3L024NG	46	FS4L144ND	46	FT1ST900PR12	7	FTSSD3MMPS01	7	TC3H044F4F4M	14
FS3L036ND	46	FS4L144NG	46	FT1ST900PS01	7	FTSST3MMPS01	7	TC4H02LDLDDL	14
FS3L036NG	46	FSSC002N0	52	FT3LC2MMPS01	7	FTSST900PR12	7	TC4H02LDLDDL7A	14
FS3L048ND	46	FSSC004N0	52	FT3LC250PR12	7	FTSST900PS01	7	TC4H06LDMFLD	14
FS3L048NG	46	FSSC006N0	52	FT3LC900PR12	7	FW3MBF06LD	28	TC4H06LDMFLD7A	14
FS3L072NG	46	FSSC008N0	52	FT3LC900PS01	7	FW3MBP06LD	28	TC4H06LDMFMM	14
FS3L096ND	46	FSSC010N0	52	FT3LD2MMPS01	7	FW3MBS06LD	28	TC4H06LDMFMM7A	14
FS3L096NG	46	FSSC012N0	52	FT3MM3MMPS01	7	FW4MBF06LD	28	TC4H044F4F4M	14
FS3L144ND	46	FSSC00260	52	FT3MM250PS01	7	FW4MBP06LD	28	TC4H044F4F4M7A	14
FS3L144NG	46	FSSC00460	52	FT3SC3MMPS01	7	FW4MBS06LD	28	XPE-S0003	15
FS4C002N0	52	FSSC00660	52	FT3SC250PR12	7	FWSMBF06LA	28	9810-0100	15
FS4C004N0	52	FSSC00860	52	FT3SC900PR12	7	FWSMBF06LD	28	9811-0200	15
FS4C006N0	52	FSSC01060	52	FT3SC900PS01	7	FWSMBP06LA	28	9813-0400	15
FS4C008N0	52	FSSC01260	52	FT3SD3MMPS01	7	FWSMBP06LD	28		

Faster.
Easier.
Better.

SmartPart Number Configurator

Fiber Optic Cable

To use the configuration matrices, make a selection from each category (some selections will require measurements) and combine to form a custom part number.

Part number example from configuration shown below:

F13B004PB

FI		3		B		004		P		B	
FX Fiber Cable		Fiber Type		Family		Fiber Count		Fire Rating & Protection		Subunit Type / Configuration	
Breakout Cable											
FI	Indoor Cable	1	OM1	B	Breakout	002	2 Fibers	Plenum Group		B	2.0 mm, 1 x 900 µm Fiber
FD	Indoor/Outdoor Cable	3	OM3			004	4 Fibers	P	Plenum (OFNP)		
		4	OM4			006	6 Fibers	A	Plenum Interlocked Aluminum Armor (OFCP)		
		S	OS2 (G.657.A1)			008	8 Fibers	Riser Group			
						010	10 Fibers	R	Riser (OFNR)		
						012	12 Fibers	F	Riser Interlocked Aluminum Armor (OFCR)		
Non-Unitized Distribution Cable											
FI	Indoor Cable	1	OM1	D	Distribution	002	2 Fibers	Plenum Group		9	900 µm Fiber
FD	Indoor/Outdoor Cable	3	OM3			004	4 Fibers	P	Plenum (OFNP)		
		4	OM4			006	6 Fibers	A	Plenum Interlocked Aluminum Armor (OFCP)		
		S	OS2 (G.657.A1)			012	12 Fibers	Riser Group			
						024	24 Fibers	R	Riser (OFNR)		
								F	Riser Interlocked Aluminum Armor (OFCR)		
Unitized Distribution Cable											
FI	Indoor Cable	1	OM1	D	Distribution	024	24 Fibers	Plenum Group		J	4.5 mm, 6 x 900 µm Fiber
FD	Indoor/Outdoor Cable	3	OM3			036	36 Fibers	P	Plenum (OFNP)	K	5.5 mm, 12 x 900 µm Fiber
		4	OM4			048	48 Fibers	A	Plenum Interlocked Aluminum Armor (OFCP)		
		S	OS2 (G.657.A1)			072	72 Fibers	Riser Group			
			Hybrid Assignments (Primary/Secondary)			096	96 Fibers	R	Riser (OFNR)		
		E	OS2/OM4			144	144 Fibers	F	Riser Interlocked Aluminum Armor (OFCR)		
		F	OS2/OM1			Hybrid Configurations					
		H	OS2/OM3			H31	4 Subunits				
		K	OM4/OM1			H22	4 Subunits				
		M	OM3/OM1			H13	4 Subunits				
Mini-Distribution Cable (Non-Unitized)											
FI	Indoor Cable	3	OM3	M	Mini-Distribution	012	12 Fibers	Plenum Group		0	250 µm Fiber
		4	OM4					P	Plenum (OFNP)	2	3.0 mm, 12 x 250 µm Fiber
		S	OS2 (G.657.A1)						A	Plenum Interlocked Aluminum Armor (OFCP)	
Mini-Distribution Cable (Unitized)											
FI	Indoor Cable	3	OM3	M	Mini-Distribution	024	24 Fibers	Plenum Group		1	2.0 mm, 12 x 250 µm Fiber
		4	OM4			036	36 Fibers	P	Plenum (OFNP)		
		S	OS2 (G.657.A1)			048	48 Fibers	A	Plenum Interlocked Aluminum Armor (OFCP)		
						072	72 Fibers	Riser Group			
						096	96 Fibers				
						144	144 Fibers				
Loose-Tube											
FI	Indoor Cable	1	OM1	L	Loose-Tube (Single-Jacket)	012	12 Fibers	CM		D	12 Fibers per Tube Dry
FS	Outdoor Cable	3	OM3			024	24 Fibers	N	CM (OFN)	G	12 Fibers per Tube Gel
		4	OM4			036	36 Fibers	6	CM Corrugated Steel Tape Armor		
		S	OS2 (G.657.A1)			048	48 Fibers	Riser Group			
						072	72 Fibers	R	Riser (OFNR)		
						096	96 Fibers	5	Riser Corrugated Steel Tape Armor (OFCR)		
						144	144 Fibers				

GLOBAL LOCATIONS

For worldwide Sales and Technical Support, visit: www.belden.com



UNITED STATES

Division Headquarters

401 Pennsylvania Parkway, #200
Indianapolis, IN
USA
Phone: (1)-317-818-6300
Inside Sales: 800-235-3361
Fax: (1)-317-818-6382
info@belden.com

CANADA

National Business Center

Belden Canada Inc.
2310 Alfred-Nobel
St-Laurent Quebec H4S 2B4
Canada
Phone: 514-822-2345
Fax: 514-822-7979
info@belden.com

MEXICO

Regional Office

Insurgentes Sur #1602
Piso 1 Oficina 102
Código Constructor Del.
Benito Juárez , C.P. 03940
Mexico
Phone: +52 55-5523-7733
Fax: +52 55-5528-8077
ventas.mexico@belden.com