

Acoustical tee

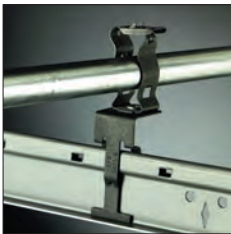
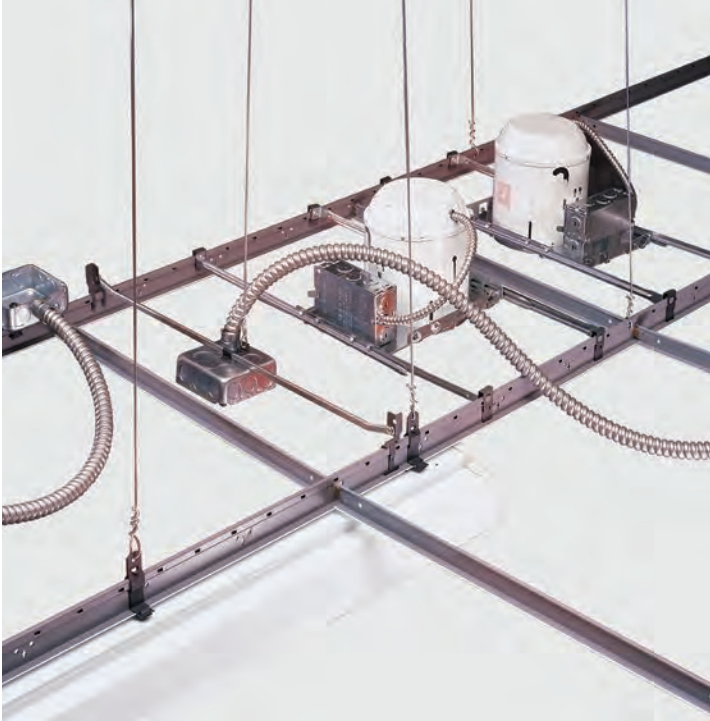

Acoustical Tee

*Read safety/installation instruction sheets in packages before use.
These products are designed for positioning only. No load rating.*

Acoustical tee

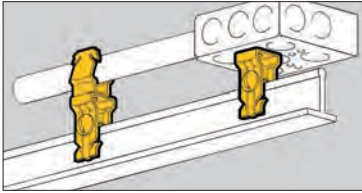

- Attaches to top of acoustical T-Bar with 1/4"-20 screw.
- Has 1/4"-20 thread impression for attachment to box or conduit fastener.
- **WARNING** Do not use for hanging acoustical tee.

T-Bar Support Fasteners



UPC/Part Number	Catalog Number	Description	Box Qty.
78101118090	BA14	T-Bar Support Clip	100

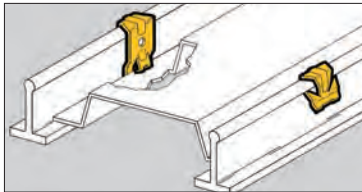

- Gives positive support for troffers and lay-in fixtures.
- Complies with NEC Article 410.16(C) for fixtures supported by suspended ceilings.
- Fits rectangular or round head T-Bars.
- Commonly known as "Hurricane Clip".

Troffer Fasteners



UPC/Part Number	Catalog Number	Description	Box Qty.
78101118095	BA15	For Straight Lip or Upturned Lip Fixtures	100
78205118209	BA15W	White, For Straight Lip or Upturned Lip Fixtures	100

Read safety/installation instruction sheets in packages before use. These products are designed for positioning only. No load rating.

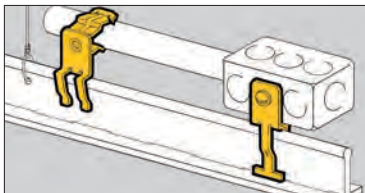

Side Mount T-Bar Fasteners

- A positive method for supporting vertical boxes, conduit or cable above T-Bar.
- Allows conduit to clear drop wires.
- **WARNING** Do not use for hanging acoustical tee.



BA5-4T

UPC/Part Number	Catalog Number	Description	Box Qty.
78101118095	BA5-4T	With 1/4"-20 Thread Impression	100



BG Series



BP Series

UPC/Part Number	Catalog Number	Conduit Size	Box Qty.
78101118410	BG-6-A5 *	3/8"	100
78101118465	BG-8-12-A5	1/2", 3/4"	100
78101118545	BG-16-A5	1"	100

Patent #4958792

78101119235	BP-8-A5	1/2" EMT	100
78101119335	BP-12-A5	3/4" EMT 1/2" IMC, Rigid	100
78101118545	BP-16-A5	1"EMT 3/4" IMC, Rigid	100

* BG-6 will accept the following range $\varnothing.420 - \varnothing.675$: 14/2 thru 10/4 MC/AC cable and 5/16" or 3/8" flexible conduit

Read safety/installation instruction sheets in packages before use. These products are designed for positioning only. No load rating.

Acoustical tee

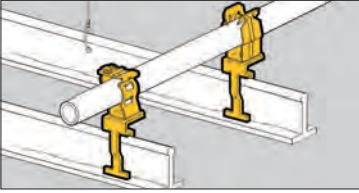

- A positive method for supporting horizontal boxes or conduit above T-Bar.
- Allows conduit to clear drop wires.
- **WARNING** Do not use for hanging acoustical tee.

Top Mount T-Bar Fasteners



UPC/Part Number	Catalog Number	Description	Box Qty.
78101118125	BA6-4T	With 1/4"-20 Thread Impression	100

Acoustical Tee



BG Series



BP Series

UPC/Part Number	Catalog Number	Conduit Size	Box Qty.
78101188540	BG-6-A6 *	3/8"	100
78101118470	BG-8-12-A6	1/2", 3/4"	100
78101118550	BG-16-A6	1"	100
Patent #4958792			
78101119240	BP-8-A6	1/2" EMT	100
78101119340	BP-12-A6	3/4" EMT 1/2" IMC, Rigid	100
78101119435	BP-16-A6	1"EMT 3/4" IMC, Rigid	100

* BG-6 will accept the following range $\varnothing.420 - \varnothing.675$: 14/2 thru 10/4 MC/AC cable and 5/16" or 3/8" flexible conduit

Read safety/installation instruction sheets in packages before use. These products are designed for positioning only. No load rating.

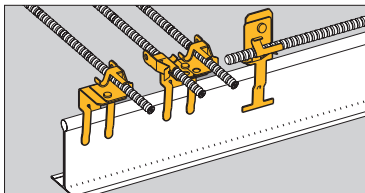

- A positive method for supporting cable or flexible conduit above T-Bar.
- Assemblies support MC, AC, sizes 14/2 through 10/3 or 3/8" FMC.

Top Mount T-Bar Fasteners



BX4-A6



BX4M-A6

UPC/Part Number	Catalog Number	Description	Box Qty.
78101101220	BX4-A6	Single Runs	100
78101101216	BX4M-A6	Double Runs	100

Note: Fasteners will rotate 360°.



BX4-A5



BX4M-A5

UPC/Part Number	Catalog Number	Description	Box Qty.
78101101187	BX4-A5	Single Runs	100
78101101211	BX4M-A5	Double Runs	100

Note: Fasteners will rotate 360°.

Read safety/installation instruction sheets in packages before use. These products are designed for positioning only. No load rating.

Acoustical tee

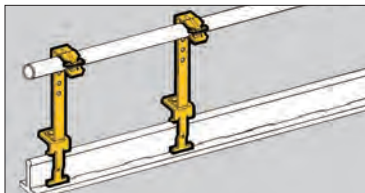

- Supports conduit and electrical boxes above T-Bar.
- Height adjusts from 4¼" to 7¼".
- Conduit fasteners can be attached at ¾" increments.
- BX4M-A28 supports cable or FMC above T-Bar.

Support Fasteners



BA28

BX4M-A28

UPC/Part Number	Catalog Number	Description	Box Qty.
78101118115	BA28	½" Holes Allow for Adjustment Between 4¼" and 7¼" at ¾" Increments	50
78101101211	BX4M-A28	Double Runs MC, AC, or FMC	25

Acoustical Tee



BP-12-A28

UPC/Part Number	Catalog Number	Conduit Size	Box Qty.
78101119230	BP-8-A28	½" EMT	100
78101119330	BP-12-A28	¾" EMT ½" IMC, Rigid	100
78101119425	BP-16-A28	1" EMT ¾" IMC, Rigid	100

Note: Adjustable BP Conduit Fastener is attached with screw in 7¼" top hole position.

Read safety/installation instruction sheets in packages before use. These products are designed for positioning only. No load rating.

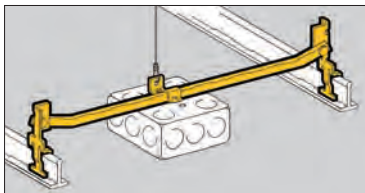

Electrical Box T-Bar Fasteners



BA12-20



- See BA50 for a stronger, more cost effective solution.
- Supports octagonal or square boxes.
- Allows for flush mounting or $\frac{3}{4}$ " offset for plaster ring.
- One BB27 box mounting clip with screw included with each hanger.
- Load Capacity: 20 lbs.
- For additional support, attach dropwire to BB27 box mounting clip.
- **WARNING** Do not use for hanging acoustical tee.

UPC/Part Number	Catalog Number	Description	Box Qty.
78101118080	BA12	Box Hanger 24" Span	50
78101118082	BA12-12	Box Hanger 12" Span	50
78101118085	BA12-20	Box Hanger 20" Span	50
78101118087	BA12-30	Box Hanger 30" Span	50



UPC/Part Number	Catalog Number	Description	Box Qty.
78101118170	BB27	Box Mounting Clip (with Screw)	100
78101101673	SRHMS $\frac{1}{4}$ x $\frac{3}{8}$	$\frac{1}{4}$ "-20 x $\frac{3}{8}$ " Slotted Round Head Machine Screw	50

Read safety/installation instruction sheets in packages before use.
These products are designed for positioning only. No load rating.

Acoustical tee

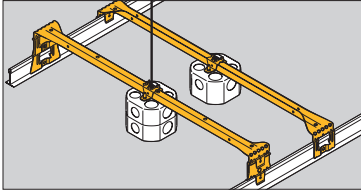

Heavy Duty Electrical Box Hanger



BA50 &
BA50CAN



BA50D &
BA50DCAN



BA50E



BA50C3T & BA50C4T

- Supports octagonal or square boxes on 24" span.
- Bendable ends mount 1½" or 2⅞" deep boxes without tools.
- Self-centering feature positions box on center.
- Includes BA50C4T Box Mounting Clip.
- Ultimate Static Load Capacity: 50 Lbs. (without dedicated dropwire)
- Static Load Capacity: 70 Lbs. (with dedicated dropwire) 35 Lbs. Canada
- Finish: Pre-Galvanized
- Consult factory for pre-fab box assemblies.
- Not for use with fans. See BA50F.

UPC/Part Number	Catalog Number	Description	Box Qty.
78101196490	BA50	Box Hanger	25
78205135905	BA50CAN *	Box Hanger	25
78101196491	BA50D	Box Hanger for Box w/ 1½" Extension	25
78205135906	BA50DCAN *	Box Hanger for Box w/ 1½" Extension	25
78205136570	BA50C4T	Box Mounting Clip with Hardware	25
78205136571	BA50C3T *	Box Mounting Clip with Hardware	25
78101196489	BA50E	Extender Brackets with Hardware	10 pair

* Canada Only

Read safety/installation instruction sheets in packages before use. These products are designed for positioning only. No load rating.

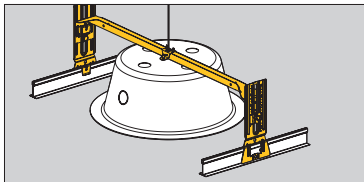

- Adjustable box support for suspended ceilings.
- Accommodates heights up to 8¾".
- Integral ruler enables height adjustments without measuring.

Adjustable Box Support



- Ideal for installation of speaker cases, emergency light fixtures, etc. in suspended ceilings.
- Static Load Capacity: 25 Lbs. without dedicated dropwire 70 Lbs. with dedicated dropwire 35 Lbs. (Canada) with dedicated dropwire
- Consult factory for pre-fab box assemblies.



UPC/Part Number	Catalog Number	Description	Box Qty.
78205118460	BA50A	Adjustable Box Hanger T-Bar	10

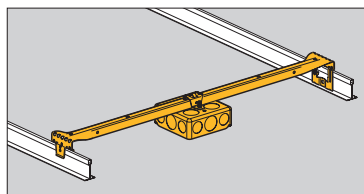

- Pre-assembled T-Bar fasteners speed installation.
- Boxes have ½" and ¾" knockouts.
- Loading not to exceed 50 lbs. in U.S.A. without independent support. 35 Lbs. in Canada
- 24" span

Electrical Box T-Bar Fasteners



BA50-OB



BA50-SB

UPC/Part Number	Catalog Number	Description	Box Qty.
78205124855	BA50-OB-24	1½" Deep Box to T-Bar Fastener	10
78205124856	BA50-OB-34	2⅛" Deep Box to T-Bar Fastener	10
78205124857	BA50-SB-24	1½" Deep Box to T-Bar Fastener	10
78205150954	BA50-SB-34	2⅛" Deep Box to T-Bar Fastener	10

Read safety/installation instruction sheets in packages before use. These products are designed for positioning only. No load rating.

Acoustical tee

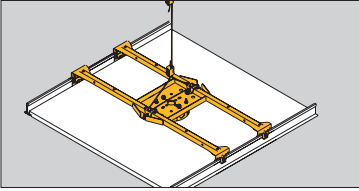

RediMount Fan Hanger

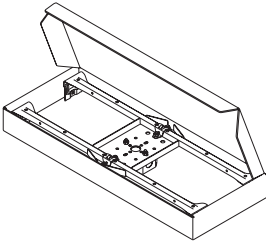

- Redi-mount™ features pre-assembled fan/fixture hanger installs on T-Bar in less than 30 seconds.
- Positions and secures fans and fixtures in suspended ceilings.
- Includes KwikWire™ cable and clamps which attach to mounting clips for easy installation.
- Recommended for use in seismic areas.
- UL Listed for fan support up to 70 lbs. or fixture support up to 90 lbs. 35 Lbs. Canada
- Finish: Pre-Galvanized.



UPC/Part Number	Catalog Number	Description	Box Qty.
78101196492	BA50F	Fan/Fixture Hanger Includes 4" x 1½" Deep Octagon Box	1

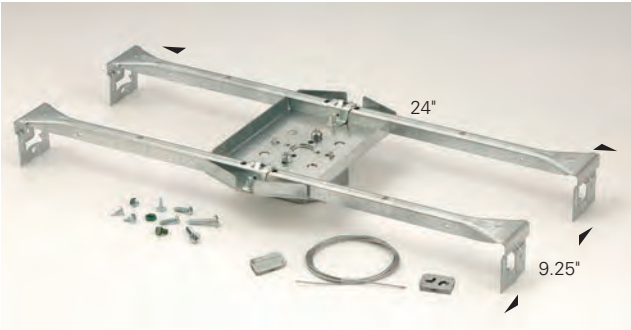

Read safety/installation instruction sheets in packages before use. These products are designed for positioning only. No load rating.

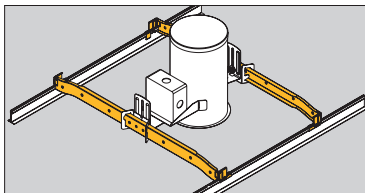

QuikFix Fastening System



- New QuikFix™ Fastening System mounts spec grade downlights 50% faster than "wire bound" installation methods.
- QuikFix System is pre-sized for 24" spacing.
- No tools required.
- Recommended for use in seismic areas.
- UL listed for fixture support up to 50 lbs.

UPC/Part Number	Catalog Number	Description	Box Qty.
78205199873	BA40	Fixture Bar	20 pair

Patent # 6286265

- Innovative design features offset bar hangers with integral locking tabs that secure downlights to T-Bar and prevent lifting or sliding.

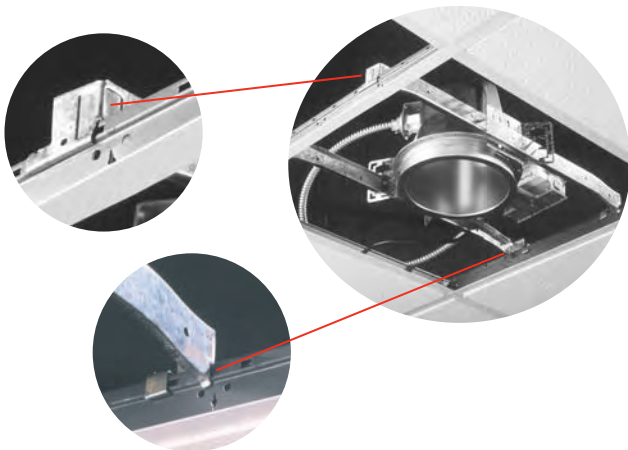

Read safety/installation instruction sheets in packages before use. These products are designed for positioning only. No load rating.

Acoustical tee

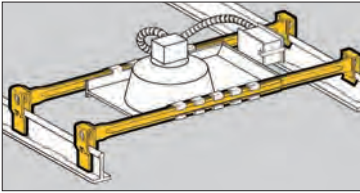

- Adjustable span from 20" to 30".
- Fits horizontal and vertical flanges.
- Fixture position is adjustable.
- No center clips or tools required.
- One set completes one fixture installation (four bars per set).

Light Fixture T-Bar Fasteners

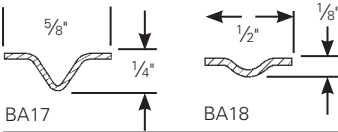

UPC/Part Number	Catalog Number	"High Hat" Fixtures	Box Qty.
78101118100	BA17 (Wide Bar)	CAPRI [†] R-9X, R-10C CAPRI [†] R-10X CAPRI [†] PR-751CX HALO ^{®†} H7, HALO ^{®†} H17 JUNO ^{®†} AP, APT JUNO ^{®†} IC, ICT, J, SC, TC THOMAS ^{®†} RI-IC	10 sets
78101118105	BA18 (Narrow Bar)	CAPRI [†] HSG LIGHTOLIER ^{®†} 711	10 sets

Acoustical Tee

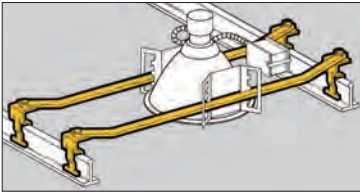

- Fixture position is adjustable within the span of the hanger.
- Fixed span of 24 inches for T-Bar applications.
- Requires only a screwdriver to install.
- One set completes one fixture installation (four bars per set).

Light Fixture T-Bar Fasteners



UPC/Part Number	Catalog Number	"High Hat" Fixtures	Box Qty.
78101118110	BA20 (Wide Bar)	Fits LIGHTOLIER ^{®†} CALCULITE ^{®†} Fixtures	10 sets

† All other trademarks are property of their respective owners.

Read safety/installation instruction sheets in packages before use.
These products are designed for positioning only. No load rating.



- Allows for independent suspension of fixtures.
- Fits most acoustical T-Bars.
- BA-4-WN wing nut included with all 1/4"-20 suspension hangers.
- Static Load Capacity: 65 Lbs.

Suspension Fasteners



BA1 BA1-T BA1-T-BN



UPC/Part Number	Catalog Number	T-Bar Size	Stud Size	Box Qty.
78101118065	BA1	15/16"	1/4"-20 x 5/8"	100
78101118070	BA1-24	15/16"	1/4"-20 x 1 1/2"	100
78101118075	BA1-32	15/16"	1/4"-20 x 2"	100
78101102891	BA1-T	15/16"	#8-32 x 5/8" with Pal Nut	100
78101102897	BA1-T-BN	15/16"	#8-32 x 5/8" with Brass Nut	100



BA1-9



BA1-95

UPC/Part Number	Catalog Number	T-Bar Size	Stud Size	Box Qty.
78205125585	BA1-9	9/16"	1/4"-20 x 5/8"	100
78205125587	BA1-95	9/16"	1/4"-20 x 5/8"	100

Read safety/installation instruction sheets in packages before use. These products are designed for positioning only. No load rating.

Acoustical tee

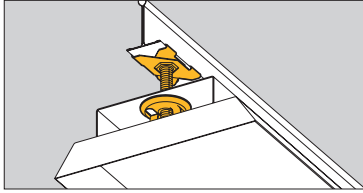

- Supports electrical fixtures from standard $1\frac{5}{16}$ " T-Bars.
- BA-4-WN wing nut included.
- $\frac{1}{4}$ "-20 stud available in varying lengths.
- Static Load Capacity: 50 Lbs.

T-Bar Scissor Fasteners



UPC/Part Number	Catalog Number	Stud Length	Box Qty.
78101104258	BAX-4-16	$\frac{5}{8}$ "	100
78101104262	BAX-4-16-24	$1\frac{1}{2}$ "	100
78101104263	BAX-4-16-32	2"	100
78101104264	BAX-4-16-48	3"	100

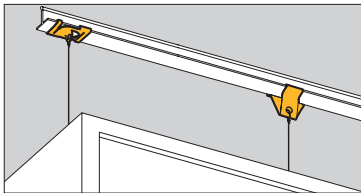

- BA-4-16-H supports signs from $1\frac{5}{16}$ " T-Bar.
- BA-4-16-H1 supports signs from $\frac{9}{16}$ " or $1\frac{5}{16}$ " T-Bar.
- Static Load Capacity: 40 Lbs.

Sign Hangers



BA-4-16-H



BA-4-16-H1

UPC/Part Number	Catalog Number	Stud Length	Box Qty.
78101118040	BA-4-16-H	Sign Hanger with White Finish	100
78101104449	BA-4-16-H1	Sign Hanger with Zinc Plated Finish	100

Read safety/installation instruction sheets in packages before use. These products are designed for positioning only. No load rating.

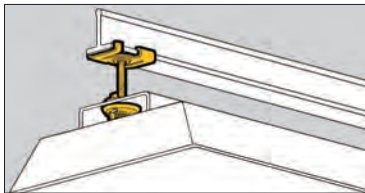

15/16" Twist Fasteners



BA-4-WN

- Supports electrical fixtures from 15/16" T-Bar.
- 1/4"-20 stud available in varying lengths.
- Includes BA-4-WN wing nut with impression.
- Static Load Capacity:
BA4-16 Series = 50 lbs.
BA4-WN Series = 100 lbs.

UPC/Part Number	Catalog Number	Finish	Stud Length	Box Qty.
78101118020	BA-4-16	Black	5/8"	100
78101118055	BA-4-16-W	White	5/8"	100
78101118025	BA-4-16-24	White	1 1/2"	100
78101118030	BA-4-16-32	White	2"	100
78101118035	BA-4-16-48	White	3"	100
78101118060	BA-4-WN	Black		100

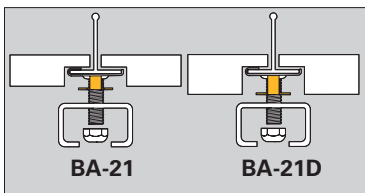

BA-21

BA-21D

T-Bar Spacers



BA-21



BA-21D

- T-Bar spacer provides flush mounting surface for tegular tile installations.
- Spacer must be used in combination with our BA-4-16 or BA-2-16 series fasteners.
- Finish: Zinc Plated

UPC/Part Number	Catalog Number	Description	Box Qty.
78101195575	BA-21	1/4" Spacer	100
78101199567	BA-21D	3/8" Spacer	100

Read safety/installation instruction sheets in packages before use. These products are designed for positioning only. No load rating.

Acoustical tee

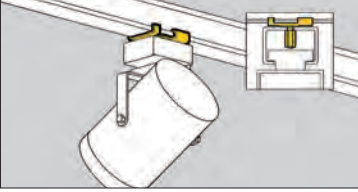

- Supports electrical fixtures from 1⁵/₁₆" T-Bar.
- #8-32 stud available in varying lengths.
- Static Load Capacity: 25 Lbs.

1⁵/₁₆" Twist Fasteners



UPC/Part Number	Catalog Number	Finish	Stud Length	Box Qty.
78101118000	BA-2-16	Black with Pal Nut	5/8"	100
78101104259	BA-2-16-7	Black with Pal Nut	7/16"	100
78101118010	BA-2-16-W	White with Pal Nut	5/8"	100
78101104261	BA-2-16-7-W	White with Pal Nut	7/16"	100



UPC/Part Number	Catalog Number	Finish	Stud Length	Box Qty.
78101118015	BA-2-16-BN	Black with Brass Nut	5/8"	100
78101104260	BA-2-16-7-BN	Black with Brass Nut	7/16"	100
78101118015	BA-2-16-WBN	White with Brass Nut	5/8"	100
78101199566	BA-2-16-7-WBN	White with Brass Nut	7/16"	100

Read safety/installation instruction sheets in packages before use. These products are designed for positioning only. No load rating.

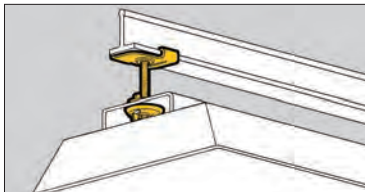

- Supports electrical fixtures from 9/16" T-Bar.
- Stud size: 1/4"-20 x 5/8".
- Static Load Capacity: 40 Lbs.

9/16" Twist Fasteners



UPC/Part Number	Catalog Number	Finish	Stud Length	Box Qty.
78101103458	BA-4-9	Black	5/8"	100
78101103461	BA-4-9-W	White	5/8"	100

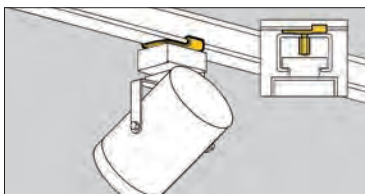

- Supports electrical fixtures and track lighting from 9/16" T-Bar.
- Stud size: #8-32 x length.
- Static Load Capacity: 25 Lbs.

9/16" Twist Fasteners



BA-2-9 Series with Pal Nut



BA-2-9-BN Series with Brass Nut

UPC/Part Number	Catalog Number	Finish	Stud Length	Box Qty.
78101103467	BA-2-9	Black	5/8"	100
78101103466	BA-2-9-7	Black	7/16"	100
78101103459	BA-2-9-W	White	5/8"	100
78101103465	BA-2-9-BN	Black	5/8"	100
78101103464	BA-2-9-7-BN	Black	7/16"	100
78101103460	BA-2-9-WBN	White	5/8"	100

Read safety/installation instruction sheets in packages before use. These products are designed for positioning only. No load rating.

Acoustical tee

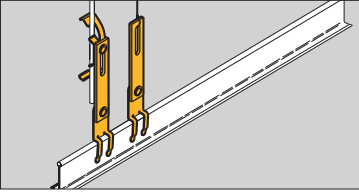

- Secures independent support wires to ceiling grid as required by NEC Article 300.11.
- Slotted design permits adjustment when securing rods.
- Bright yellow color, Per NEC 300.11 (A), is easily identified by inspectors.

Drop Wire/Rod Securing Clip



BA-311



BA-311-W2 Shown

UPC/Part Number	Catalog Number	Description	Box Qty.
78101199569	BA311	#12 thru #8 Wire	100
78101199570	BA311-W2	#12 thru 1/4" Plain or	100
78101199571	BA311-W6	3/8" Plain or Threaded Rod	100

Read safety/installation instruction sheets in packages before use. These products are designed for positioning only. No load rating.



Seismic Fixture Clamps

- BA-SFC Series provides seismic restraint for light fixtures within a suspended ceiling.
- BA-SFC reduces labor by attaching light fixtures to the T-bar frame and eliminating extra drop wires or chains.
- Load rating: 200 lbs.
- Provides positive attachment of fixtures to ceiling grid members, in compliance with ICBO Acceptance Criteria 184 (AC 184).
- Satisfies NEC 410.16(C) which requires positive attachment for secure fastening of luminaries.

UPC/Part Number	Catalog Number	Description	Box Qty.
78205145911	BA-SFC	Seismic Fixture Clamp attaches one standard 2' x 4' light fixture to T-Bar ceiling	25 sets (4 clamps per set)
78205145912	BA-SFC-E*	For attachment of two standard 2' x 4' light fixtures end-to-end onto T-Bar ceiling	25 sets (4 clamps per set)
78205145913	BA-SFC-S*	For attachment of two standard 2' x 4' light fixtures side-by-side onto T-Bar ceiling	25 sets (4 clamps per set)
78205145914	BA-SFC-CF*	For attachment of standard 2' x 2' light fixtures onto T-Bar	50 sets (2 clamps per set)
78205145915	BA-SFC-CFS	Seismic Fixture Clamp for reinforcement of main runner connection points	50 sets (2 clamps per set)

* BASFC is required to complete installation.

Read safety/installation instruction sheets in packages before use. These products are designed for positioning only. No load rating.

Seismic Fixture Clamps cont.



BA-SFC



BA-SFC-E



BA-SFC-S



BA-SFC-CF



BA-SFC-CFS

Single Fixture Installation

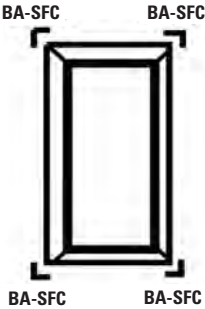

Parts Required:
1 pc. BA-SFC Installation Kit

Two Fixtures (Side by Side)

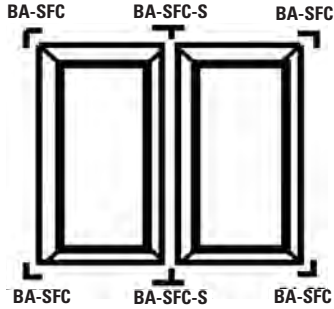

Parts Required:
1 pc. BA-SFC Installation Kit
1 pc. BA-SFC-S Installation Kit

Two Fixtures (End to End)

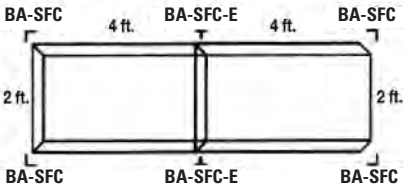

Parts Required:
1 pc. BA-SFC Installation Kit
1 pc. BA-SFC-E Installation Kit



*Read safety/installation instruction sheets in packages before use.
These products are designed for positioning only. No load rating.*