

NETGEAR[®]

Nighthawk X4S AC2200 Tri-Band WiFi Range Extender User Manual

Model EX7500

October 2017
202-11793-01

350 E. Plumeria Drive
San Jose, CA 95134
USA

Nighthawk X4S AC2200 Tri-Band WiFi Range Extender

Support

Thank you for purchasing this NETGEAR product. You can visit www.netgear.com/support to register your product, get help, access the latest downloads and user manuals, and join our community. We recommend that you use only official NETGEAR support resources.

Conformity

For the current EU Declaration of Conformity, visit http://kb.netgear.com/app/answers/detail/a_id/11621.

Compliance

For regulatory compliance information, visit <http://www.netgear.com/about/regulatory>.

See the regulatory compliance document before connecting the power supply.

Trademarks

© NETGEAR, Inc., NETGEAR and the NETGEAR Logo are trademarks of NETGEAR, Inc. Any non-NETGEAR trademarks are used for reference purposes only.

Contents

Chapter 1 Overview

Meet Your Extender.....	6
LEDs.....	6
Buttons.....	8
When to Use Your Extender.....	9
How the Extender Works.....	9

Chapter 2 Get Started

Install the WiFi Extender.....	11
Place the Extender and Apply Power.....	11
Connect to an Existing WiFi Network.....	11
Connect With WPS.....	11
Connect With the NETGEAR Installation Assistant.....	13
Connect a Device to the Extender Network.....	13
Connect a Device to the Extender Network Using WiFi.....	14
Connect a Device to the Extender Network Using WPS.....	14
Log In to the Extender After Installation.....	14
Run Smart Setup Installation.....	15

Chapter 3 Extender Network Settings

Enable or Disable One WiFi Name.....	17
Enable or Disable Smart Connect.....	17
View Connected Devices.....	18
View WiFi Settings.....	19
Change the WiFi Network Name.....	20
Turn Off the SSID Broadcast to Create a Hidden Network.....	21
Disable or Enable the WiFi Radios.....	21
Change the WiFi Speed.....	22
Use WPS to Add a Computer to the Extender's WiFi Network.....	23
Use WPS With the Push Button Method.....	23
Use WPS With the PIN Method.....	24
Deny Access to a Computer or WiFi Device.....	25
Set Up an Access Schedule.....	26
Change the Extender's Device Name.....	27
Set Up the Extender to Use a Static IP Address.....	28
Use the Extender With MAC Filtering or Access Control.....	29

Chapter 4 Maintain and Monitor the Extender

Change the Extender admin User Name and Password.....	31
Turn Password Protection Off and On.....	31
Recover a Forgotten User Name or Password.....	32
Automatically Adjust for Daylight Saving Time.....	33

Nighthawk X4S AC2200 Tri-Band WiFi Range Extender

Manually Set the Extender Clock.....	34
Back Up and Manage the Extender Configuration.....	35
Back Up the Configuration Settings.....	35
Restore the Configuration Settings.....	36
Return the Extender to Its Factory Default Settings.....	37
Use the Reset Button.....	37
Log In and Reset the Extender to Factory Settings.....	37
Update the Extender Firmware.....	38
Check for New Firmware and Update the Extender.....	38
Manually Upload Firmware to the Extender.....	39
Restart the Extender Remotely.....	40
Turn the Extender LEDs On or Off.....	41

Chapter 5 FAQs and Troubleshooting

FAQs.....	44
Cannot Connect to the Extender.....	45
Cannot Join a WiFi Network and Receive an Error Message.....	45
Cannot Access mywifiext.net.....	45
Find the Extender's IP Address.....	46

Appendix A Supplemental Information

Factory Default Settings.....	49
Technical and Environmental Specifications.....	50

The WiFi Range Extender boosts your existing network range and speed, delivering tri-band WiFi.

This chapter covers the following topics:

- *Meet Your Extender*
- *When to Use Your Extender*
- *How the Extender Works*

Note For more information about the topics covered in this manual, visit the support website at support.netgear.com.

Meet Your Extender

Before you install your extender, familiarize yourself with its LEDs and buttons.



LEDs





Figure 1. Front panel

Nighthawk X4S AC2200 Tri-Band WiFi Range Extender

The following table describes the LEDs.

Table 1. LED descriptions

LED	Description
Router Link LED 	This LED indicates the WiFi connection between the extender and the router. <ul style="list-style-type: none">• Solid blue. Best connection.• Solid amber. Good connection.• Solid red. Poor connection.• Off. No connection.• Blinking blue. The extender is resetting to its factory default settings.
Power LED 	<ul style="list-style-type: none">• Blinking blue. The extender is booting.• Solid blue. The extender is powered on.• Off. The extender is powered off.
2.4 GHz Client Link LED 	This LED indicates the connection between the extender and a 2.4 GHz WiFi client: <ul style="list-style-type: none">• Solid blue. Best connection.• Solid amber. Good connection.• Solid red. Poor connection.• Off. No connection.

Nighthawk X4S AC2200 Tri-Band WiFi Range Extender

Table 1. LED descriptions (Continued)

LED	Description
5 GHz Client Link LED 5GHz	This LED indicates the connection between the extender and a 5 GHz WiFi client: <ul style="list-style-type: none">• Solid blue. Best connection.• Solid amber. Good connection.• Solid red. Poor connection.• Off. No connection.
WPS LED 	<ul style="list-style-type: none">• Blinking blue. The extender is attempting to connect with a router or WPS-enabled device:• Solid blue. The extender is connected to a router or WPS-enabled device.• Off. The extender is not connected to a router or WPS-enabled device.

Buttons

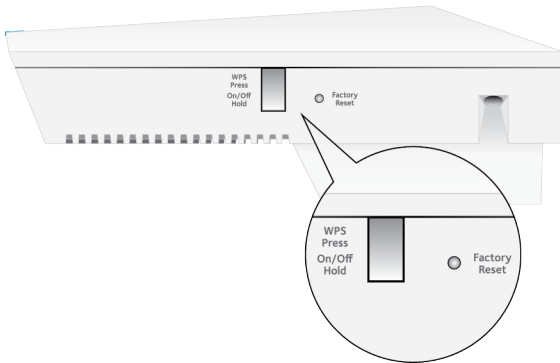

Figure 2. Extender buttons

The side panel contains the following buttons:

- **WPS/Power button.** This button acts as a **WPS** or **Power** button depending on how long you press it:
 - **WPS.** Press the button for less than five seconds to connect WPS-enabled device.
 - **Power.** Press the button for more than five seconds to turn the extender on or off.
- **Reset button.** Pressing the **Reset** button for about five seconds resets the extender.

When to Use Your Extender

We recommend that you connect through the extender network only when the WiFi device is in a “dead zone” where connection from the existing network is poor or nonexistent. Data traffic routed through the extender is inherently slower than traffic routed directly from the network.

How the Extender Works

The extender works like a bridge between a WiFi router (or a WiFi access point) and a WiFi device outside the range of the WiFi router. The extender performs two main jobs:

- The extender connects to a working WiFi network.
When the extender connects over WiFi to an existing network, it functions as a network client, similar to how a WiFi device connects to a network.
- The extender acts as an access point for WiFi devices.
The extender broadcasts its own WiFi network that WiFi devices can join. In its role as an access point, the extender performs tasks that WiFi routers do, such as broadcasting its network name (SSID).

The extender must do each of these jobs so that both ends of the bridge are in place.

This chapter covers the following topics:

- *Install the WiFi Extender*
- *Connect a Device to the Extender Network*
- *Log In to the Extender After Installation*
- *Run Smart Setup Installation*

Install the WiFi Extender

Place the extender, apply power, and connect the extender to your existing WiFi network.

Place the Extender and Apply Power

► **To place the extender and apply power:**

1. Place your extender in the same room as your WiFi router.
Proximity to the WiFi router is required only during the initial setup process.
2. Plug the extender into an electrical outlet.
3. Wait for the Power LED to light amber and then turn blue.
If the Power LED does not light, press the **WPS/Power** button on the extender for more than five seconds.

Connect to an Existing WiFi Network

To extend the range of your WiFi network, you must connect the extender to your existing WiFi network.

Note If your router's WiFi security is set to WPA enterprise or WPA2 enterprise, your extender can't connect to your router. You must change your router's WiFi security setting.

You can connect the extender in one of two ways:

- **Connect with WPS.** For more information, see [Connect With WPS](#) on page 11.

Note WPS does not support WEP network security or a hidden SSID network. If your router WiFi network uses WEP security or its SSID is hidden, follow the instructions in [Connect With the NETGEAR Installation Assistant](#) on page 13.

- **Connect with web browser setup.** For more information, see [Connect With the NETGEAR Installation Assistant](#) on page 13.

Connect With WPS

Wi-Fi Protected Setup (WPS) lets you join a secure WiFi network without typing the network name and password. For help with the **WPS** button on your WPS-enabled device, check the instructions or online help that came with that device. Some older equipment cannot use WPS.

Note WPS does not support WEP network security or a hidden SSID network. If your existing WiFi network uses WEP security or its SSID is hidden, follow the instructions in [Connect With the NETGEAR Installation Assistant](#) on page 13.

Nighthawk X4S AC2200 Tri-Band WiFi Range Extender

► To use WPS to connect the extender to your WiFi router:

1. Press the **WPS/Power** button on the extender.
The WPS LED blinks.
2. Within two minutes, press the **WPS** button on your router or access point.
When the extender connects to your existing WiFi network, the WPS LED on the extender lights solid blue.

If the Router Link LED lights blue, the connection between the router and extender is good. If the Router Link LED lights red, move the extender closer to the router and try again.

If your router supports the 2.4 GHz band only, the extender connects to your router's 2.4 GHz band. If your router supports the 5 GHz band only, the extender connects to your router's 5 GHz band. If your router supports the 2.4 GHz and 5 GHz band, the extender connects to your router's 5 GHz band.
3. If your router supports both the 2.4 GHz band and 5 GHz band and you want the extender to connect to both router's 2.4 GHz and 5 GHz bands, repeat Steps 1 and 2.
4. Unplug the extender and move it to a new location that is about halfway between your router and the area with a poor router WiFi signal.

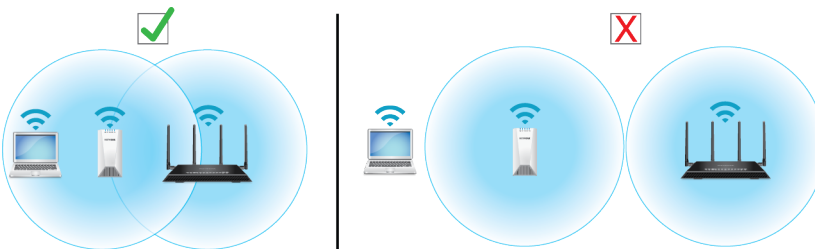

The location that you choose must be within the range of your existing WiFi router network.

5. Use the Router Link LED to help you choose a spot where the extender-to-router connection is optimal.
6. If the Router Link LED doesn't light amber or blue, plug the extender into an outlet closer to the router and try again.
Keep moving the extender to outlets closer to the router until the Router Link LED lights blue or amber.
7. Take your WiFi-enabled computer or mobile device to the location with poor WiFi router coverage.
8. Connect your WiFi-enabled computer or mobile device to the extended network.
Your extender uses the same WiFi network settings as your router for its 2.4 GHz and 5 GHz extended networks.

For example, if your extender connects to the router's 2.4 GHz WiFi band, your extender uses your router's 2.4 GHz WiFi settings for both its networks:

- **Router 2.4 GHz WiFi network name.** MyWiFiExample
- **Router 5 GHz WiFi network name.** MyWiFiExample-5G
- **Extended 2.4 GHz WiFi network name.** MyWiFiExample
- **Extended 5 GHz WiFi network name.** MyWiFiExample

If your extender connects to the router's 5 GHz WiFi band, your extender uses your router's 5 GHz WiFi settings for both its networks:

Nighthawk X4S AC2200 Tri-Band WiFi Range Extender

- **Router 2.4 GHz WiFi network name.** MyWiFiExample
- **Router 5 GHz WiFi network name.** MyWiFiExample-5G
- **Extended 2.4 GHz WiFi network name.** MyWiFiExample-5G
- **Extended 5 GHz WiFi network name.** MyWiFiExample-5G

Note Since your router and extended networks share the same WiFi network name, only one WiFi network name is broadcast.

Connect With the NETGEAR Installation Assistant

You can use the NETGEAR installation assistant to connect your extender to your existing WiFi router network. To use the NETGEAR installation assistant, you must launch a web browser on your computer or mobile device.

► To use the NETGEAR installation assistant to connect the extender to your WiFi router:

1. On your WiFi-enabled computer or mobile device, open the WiFi connection manager and locate and connect to the extender network called NETGEAR_EXT.
2. Launch web browser.
3. Enter **http://www.mywifiext.net**.
The NETGEAR installation assistant displays.
4. Follow the prompts to connect your extender to your existing WiFi network.
5. Unplug the extender and move it to a new location about halfway between your router and the area with a poor WiFi signal.

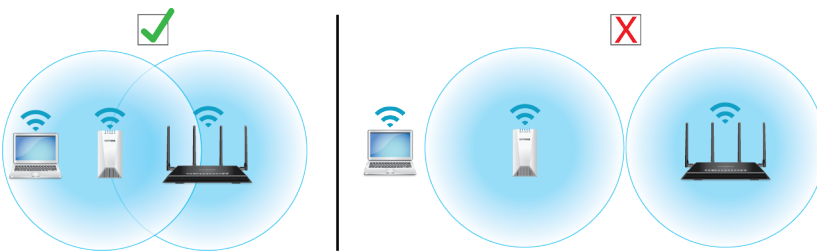

6. Use the Router Link LED to help you choose a spot where the extender-to-router connection is optimal.
7. If the Router Link LED doesn't light blue or amber, plug the extender into an outlet closer to the router and try again.
Keep moving the extender to outlets closer to the router until the Router Link LED lights blue or amber.
8. Reconnect your computer or mobile device to the new extender WiFi network.

Connect a Device to the Extender Network

After you complete the setup process, you can connect all your devices to the new extender network using a WiFi, wired, or WPS connection.

Connect a Device to the Extender Network Using WiFi

If you enabled the One WiFi Name feature, your extender uses the the same WiFi network name and password as your router.

▶ To connect to the extender WiFi network:

1. On your WiFi-enabled computer or mobile device, open the WiFi connection manager that manages your WiFi connections.
The WiFi connection manager scans for WiFi networks in your area.
2. Find and select your extender's WiFi network name (SSID) and enter your extender's WiFi password.
This is the SSID and password that you set up during the installation process. If you enabled the One WiFi Name feature, use your router's SSID and password.

Connect a Device to the Extender Network Using WPS

For help with the **WPS** button on your WPS-enabled device, check the instructions or online help that came with that device. Some older equipment cannot use WPS.

▶ To connect to the extender using a WPS connection:

1. Press the **WPS/Power** button on the extender for less than five seconds.
The WPS LED blinks blue.
2. Within two minutes, press the **WPS** button on your WPS-enabled device.
When the extender connects to your WPS-enabled device, the WPS LED lights solid blue.

Log In to the Extender After Installation

After installation, you can log in to the extender to view or change the extender's settings.

▶ To log in to the extender:

1. Launch a web browser from a computer or mobile device that is connected to your extender network.
2. Log in to your extender:
 - If you did not enable the One WiFi Name feature, enter **www.mywifiext.net** in the address field of the browser.
 - If you enabled the One WiFi Name feature, enter one of the following URLs:
 - **Windows-based computers.** <http://mywifiext>
 - **Mac computers and iOS devices.** <http://mywifiext.local>
 - **Android devices.** <http://<extender's IP address>> (for example, <http://192.168.1.3>)
For more information about how to find your extender's IP address, see [Find the Extender's IP Address](#) on page 46.

Run Smart Setup Installation

You can use Smart Setup to change the extender settings. This is an easy way to connect the extender to a different router or to change the extender WiFi network name (SSID) or WiFi password.

▶ To run Smart Setup:

1. Launch a web browser from a computer or mobile device that is connected to your extender network.
2. Log in to your extender:
 - If you did not enable the One WiFi Name feature, enter **www.mywifiext.net** in the address field of the browser.
 - If you enabled the One WiFi Name feature, enter one of the following URLs:
 - **Windows-based computers.** <http://mywifiext>
 - **Mac computers and iOS devices.** <http://mywifiext.local>
 - **Android devices.** <http://<extender's IP address>> (for example, <http://192.168.1.3>)For more information about how to find your extender's IP address, see [Find the Extender's IP Address](#) on page 46.

A login page displays.

3. Enter your admin email address and password and click the **LOG IN** button. The Status page displays.
4. Click the **SMART SETUP** button.
5. Follow the prompts.

This chapter covers the following topics:

- *Enable or Disable One WiFi Name*
- *Enable or Disable Smart Connect*
- *View Connected Devices*
- *View WiFi Settings*
- *Change the WiFi Network Name*
- *Turn Off the SSID Broadcast to Create a Hidden Network*
- *Disable or Enable the WiFi Radios*
- *Change the WiFi Speed*
- *Use WPS to Add a Computer to the Extender's WiFi Network*
- *Deny Access to a Computer or WiFi Device*
- *Set Up an Access Schedule*
- *Change the Extender's Device Name*
- *Set Up the Extender to Use a Static IP Address*
- *Use the Extender With MAC Filtering or Access Control*

Enable or Disable One WiFi Name

The One WiFi Name feature enables your extender to use the same WiFi network settings as your router.

► To enable or disable the One WiFi Name feature:

1. Launch a web browser from a computer or mobile device that is connected to your extender network.
2. Log in to your extender:
 - If you did not enable the One WiFi Name feature, enter **www.mywifiext.net** in the address field of the browser.
 - If you enabled the One WiFi Name feature, enter one of the following URLs:
 - **Windows-based computers.** <http://mywifiext>
 - **Mac computers and iOS devices.** <http://mywifiext.local>
 - **Android devices.** <http://<extender's IP address>> (for example, <http://192.168.1.3>)
For more information about how to find your extender's IP address, see [Find the Extender's IP Address](#) on page 46.

A login page displays.

3. Enter your admin email address and password and click the **LOG IN** button.
The Status page displays.
4. If your browser displays the **Menu** icon , click it.
The extender menu displays.
5. Select **Settings > Wireless**.
The WiFi Settings page displays.
6. To enable the One WiFi name feature, select the **Yes** radio button.
If this is the first time you're enabling the One WiFi Name feature, you must run the Smart Setup. Go to the Status page and click the **SMART SETUP** button to run the Smart Setup.
7. To disable the One WiFi Name feature, select the **No** radio button.
If you disable this feature, you can set a new SSID and password for the extender's 2.4 GHz and 5 GHz networks in the **Network Name (SSID)** and **WiFi Password** fields on this page.
8. Click the **SAVE** button.
Your settings are saved.

Enable or Disable Smart Connect

The Smart Connect feature allows your extender to use the same WiFi network name and password for its 2.4 GHz and 5 GHz networks.

► To enable or disable the Smart Connect feature:

1. Launch a web browser from a computer or mobile device that is connected to your extender network.
2. Log in to your extender:
 - If you did not enable the One WiFi Name feature, enter **www.mywifiext.net** in the address field of the browser.
 - If you enabled the One WiFi Name feature, enter one of the following URLs:
 - **Windows-based computers.** <http://mywifiext>
 - **Mac computers and iOS devices.** <http://mywifiext.local>
 - **Android devices.** <http://<extender's IP address>> (for example, <http://192.168.1.3>)
For more information about how to find your extender's IP address, see [Find the Extender's IP Address](#) on page 46.

A login page displays.

3. Enter your admin email address and password and click the **LOG IN** button.
The Status page displays.
4. If your browser displays the **Menu** icon , click it.
The extender menu displays.
5. Select **Settings > Wireless**.
The WiFi Settings page displays.
6. To enable the Smart Connect feature, select the **Yes** radio button.

Note For you to use this feature, the 2.4 GHz and 5 GHz networks must use the same SSID and password.

7. To disable the Smart Connect feature, select the **No** radio button.
If you disable this feature, you can set a new SSID and password for the extender's 2.4 GHz and 5 GHz networks in the **Network Name (SSID)** and **WiFi Password** fields on this page.
8. Click the **SAVE** button.
Your settings are saved.

View Connected Devices

You can view a list of devices that are connected to the extender network.

► To view connected devices:

1. Launch a web browser from a computer or mobile device that is connected to your extender network.
2. Log in to your extender:
 - If you did not enable the One WiFi Name feature, enter **www.mywifiext.net** in the address field of the browser.
 - If you enabled the One WiFi Name feature, enter one of the following URLs:
 - **Windows-based computers.** <http://mywifiext>
 - **Mac computers and iOS devices.** <http://mywifiext.local>
 - **Android devices.** <http://<extender's IP address>> (for example, <http://192.168.1.3>)
For more information about how to find your extender's IP address, see [Find the Extender's IP Address](#) on page 46.

A login page displays.

3. Enter your admin email address and password and click the **LOG IN** button.
The Status page displays.
4. If your browser displays the **Menu** icon , click it.
The extender menu displays.
5. Select **Settings > Connected Devices**.
The Connected Devices (WPS) page displays. The devices connected to the extender displays on the page.

View WiFi Settings

► To view the WiFi settings:

1. Launch a web browser from a computer or mobile device that is connected to your extender network.
2. Log in to your extender:
 - If you did not enable the One WiFi Name feature, enter **www.mywifiext.net** in the address field of the browser.
 - If you enabled the One WiFi Name feature, enter one of the following URLs:
 - **Windows-based computers.** <http://mywifiext>
 - **Mac computers and iOS devices.** <http://mywifiext.local>
 - **Android devices.** <http://<extender's IP address>> (for example, <http://192.168.1.3>)
For more information about how to find your extender's IP address, see [Find the Extender's IP Address](#) on page 46.

A login page displays.

3. Enter your admin email address and password and click the **LOG IN** button.
The Status page displays.
4. If your browser displays the **Menu** icon , click it.
The extender menu displays.
5. Select **Settings > Wireless**.
The WiFi Settings page displays.

Change the WiFi Network Name

► To change the WiFi network name:

1. Launch a web browser from a computer or mobile device that is connected to your extender network.
2. Log in to your extender:
 - If you did not enable the One WiFi Name feature, enter **www.mywifiext.net** in the address field of the browser.
 - If you enabled the One WiFi Name feature, enter one of the following URLs:
 - **Windows-based computers.** <http://mywifiext>
 - **Mac computers and iOS devices.** <http://mywifiext.local>
 - **Android devices.** <http://<extender's IP address>> (for example, <http://192.168.1.3>)
For more information about how to find your extender's IP address, see [Find the Extender's IP Address](#) on page 46.

A login page displays.

3. Enter your admin email address and password and click the **LOG IN** button.
The Status page displays.
4. If your browser displays the **Menu** icon , click it.
The extender menu displays.
5. Select **Settings > Wireless**.
The WiFi Settings page displays.
6. In each **Network Name (SSID)** field, type a network name.
7. Click the **SAVE** button.
Your settings are saved.

Turn Off the SSID Broadcast to Create a Hidden Network

By default, the extender broadcasts its WiFi signal so that its WiFi network names (SSIDs) are easy for you to find and connect to from your computer, tablet, or smartphone. You can turn off the SSID broadcast to create a hidden WiFi network. To connect to a hidden network you must know its SSID and password and manually enter them.

► To turn off the SSID broadcast to create a hidden network:

1. Launch a web browser from a computer or mobile device that is connected to your extender network.
2. Log in to your extender:
 - If you did not enable the One WiFi Name feature, enter **www.mywifiext.net** in the address field of the browser.
 - If you enabled the One WiFi Name feature, enter one of the following URLs:
 - **Windows-based computers.** <http://mywifiext>
 - **Mac computers and iOS devices.** <http://mywifiext.local>
 - **Android devices.** <http://<extender's IP address>> (for example, <http://192.168.1.3>)
For more information about how to find your extender's IP address, see [Find the Extender's IP Address](#) on page 46.

A login page displays.

3. Enter your admin email address and password and click the **LOG IN** button.
The Status page displays.
4. If your browser displays the **Menu** icon , click it.
The extender menu displays.
5. Select **Settings > Wireless**.
The WiFi Settings page displays.
6. Clear the **Broadcast the Network Name (SSID)** check box.
7. Click the **SAVE** button.
Your settings are saved.

Disable or Enable the WiFi Radios

By default, the extender's WiFi radios broadcast signals in the 2.4 GHz and 5 GHz bands. If you disable the WiFi radios, then no one can connect with WiFi to the extender.

► To enable or disable the WiFi radios:

1. Launch a web browser from a computer or mobile device that is connected to your extender network.
2. Log in to your extender:

Nighthawk X4S AC2200 Tri-Band WiFi Range Extender

- If you did not enable the One WiFi Name feature, enter **www.mywifiext.net** in the address field of the browser.
- If you enabled the One WiFi Name feature, enter one of the following URLs:
 - **Windows-based computers.** <http://mywifiext>
 - **Mac computers and iOS devices.** <http://mywifiext.local>
 - **Android devices.** <http://<extender's IP address>> (for example, <http://192.168.1.3>)
For more information about how to find your extender's IP address, see [Find the Extender's IP Address](#) on page 46.

A login page displays.

3. Enter your admin email address and password and click the **LOG IN** button.
The Status page displays.
4. If your browser displays the **Menu** icon , click it.
The extender menu displays.
5. Select **Settings > Wireless**.
The WiFi Settings page displays.
6. Select or clear the **Enable 2.4 GHz WiFi** check box.
7. Select or clear the **Enable 5 GHz WiFi** check box.
8. Click the **SAVE** button.
Your settings are saved.

Change the WiFi Speed

The 2.4 GHz network WiFi speed is set to a specific speed. You can change only the 5 GHz WiFi speed.

► To change the WiFi speed:

1. Launch a web browser from a computer or mobile device that is connected to your extender network.
2. Log in to your extender:
 - If you did not enable the One WiFi Name feature, enter **www.mywifiext.net** in the address field of the browser.
 - If you enabled the One WiFi Name feature, enter one of the following URLs:
 - **Windows-based computers.** <http://mywifiext>
 - **Mac computers and iOS devices.** <http://mywifiext.local>
 - **Android devices.** <http://<extender's IP address>> (for example, <http://192.168.1.3>)
For more information about how to find your extender's IP address, see [Find the Extender's IP Address](#) on page 46.

A login page displays.

3. Enter your admin email address and password and click the **LOG IN** button.
The Status page displays.
4. If your browser displays the **Menu** icon , click it.
The extender menu displays.
5. Select **Settings > Wireless**.
The WiFi Settings page displays.
6. In the 5 GHz network **WiFi Speed** menu, select a speed.
7. Click the **SAVE** button.
Your settings are saved.

Use WPS to Add a Computer to the Extender's WiFi Network

WPS (WiFi Protected Setup) lets you connect a computer or WiFi device to the extender's network without entering the WiFi network passphrase or key. Instead, you use a **WPS** button or enter a PIN to connect.

If you use the push button method, the WiFi device that you are trying to connect must include a physical button or a software button. If you use the PIN method, you must know the PIN of the WiFi device that you are trying to connect.

WPS supports WPA and WPA2 WiFi security. If your extender network is open (no WiFi security is set), connecting with WPS automatically sets WPA + WPA2 WiFi security on the extender network and generates a random passphrase. You can view this passphrase on the WiFi Settings page (for more information, see [View WiFi Settings](#) on page 19).

Use WPS With the Push Button Method

For you to use the push button method to connect a WiFi device to the extender's WiFi network, the WiFi device that you are trying to connect must include a physical **WPS** button or an onscreen **WPS** button that you can click.

► To use WPS to add a WPS-enabled device to the extender's WiFi network:

1. Launch a web browser from a computer or mobile device that is connected to your extender network.
2. Log in to your extender:
 - If you did not enable the One WiFi Name feature, enter **www.mywifiext.net** in the address field of the browser.
 - If you enabled the One WiFi Name feature, enter one of the following URLs:

Nighthawk X4S AC2200 Tri-Band WiFi Range Extender

- **Windows-based computers.** <http://mywifiext>
- **Mac computers and iOS devices.** <http://mywifiext.local>
- **Android devices.** <http://<extender's IP address>> (for example, <http://192.168.1.3>)
For more information about how to find your extender's IP address, see [Find the Extender's IP Address](#) on page 46.

A login page displays.

3. Enter your admin email address and password and click the **LOG IN** button.
The Status page displays.
4. If your browser displays the **Menu** icon , click it.
The extender menu displays.
5. Select **Settings > Do More > Connect Devices (WPS)**.
The Connected Devices (WPS) page displays.
6. Leave the **Push Button (recommended)** radio button selected.
7. Click the **WIFI PROTECTED SETUP (WPS)** button.
For two minutes, the extender attempts to add the computer or WiFi device to its WiFi network.
8. Within two minutes, go to the computer WiFi device and press or click its **WPS** button.
9. To verify that the WiFi device is connected to the extender's WiFi network, select **Settings > Connected Devices**.
The WiFi device displays onscreen.

Use WPS With the PIN Method

To use the PIN method to connect a WiFi device to the extender's WiFi network, you must know the PIN of the WiFi device that you are trying to connect.

► To add a computer or WiFi device to the extender's WiFi network:

1. Launch a web browser from a computer or mobile device that is connected to your extender network.
2. Log in to your extender:
 - If you did not enable the One WiFi Name feature, enter **www.mywifiext.net** in the address field of the browser.
 - If you enabled the One WiFi Name feature, enter one of the following URLs:
 - **Windows-based computers.** <http://mywifiext>
 - **Mac computers and iOS devices.** <http://mywifiext.local>
 - **Android devices.** <http://<extender's IP address>> (for example, <http://192.168.1.3>)
For more information about how to find your extender's IP address, see [Find the Extender's IP Address](#) on page 46.

Nighthawk X4S AC2200 Tri-Band WiFi Range Extender

A login page displays.

3. Enter your admin email address and password and click the **LOG IN** button.
The Status page displays.
4. If your browser displays the **Menu** icon , click it.
The extender menu displays.
5. Select **Settings > Do More > Connect Devices (WPS)**.
The Connect Devices (WPS) page displays.
6. Select the **PIN Number** radio button.
The page adjusts.
7. Type the PIN of the WiFi device in the field.
8. Click the **NEXT** button.
For four minutes, the extender attempts to find the computer or WiFi device.
9. Within four minutes, go to the WiFi device and use its WPS software to join the WiFi network.
10. To verify that the WiFi device is connected to the extender's WiFi network, select **Settings > Connected Devices**.
The WiFi device displays onscreen.

Deny Access to a Computer or WiFi Device

By default, access control is disabled so that it is easy for you to connect to the extender's WiFi networks.

You can deny network access to specific computers and WiFi devices based on their MAC addresses. Each network device is assigned a MAC address, which is a unique 12-character physical address, containing the hexadecimal characters 0–9, a–f, or A–F only, and separated by colons (for example, 00:09:AB:CD:EF:01). Typically, the MAC address is on the label of the WiFi device. If you cannot access the label, you can display the MAC address using the network configuration utilities of the computer. You might also find the MAC addresses on the Connected Devices page (see [View Connected Devices](#) on page 18).

► To use WiFi access control to deny access:

1. Launch a web browser from a computer or mobile device that is connected to your extender network.
2. Log in to your extender:
 - If you did not enable the One WiFi Name feature, enter **www.mywifiext.net** in the address field of the browser.
 - If you enabled the One WiFi Name feature, enter one of the following URLs:
 - **Windows-based computers.** <http://mywifiext>
 - **Mac computers and iOS devices.** <http://mywifiext.local>
 - **Android devices.** <http://<extender's IP address>> (for example, <http://192.168.1.3>)
For more information about how to find your extender's IP address, see [Find the Extender's IP Address](#) on page 46.

Nighthawk X4S AC2200 Tri-Band WiFi Range Extender

A login page displays.

3. Enter your admin email address and password and click the **LOG IN** button.
The Status page displays.
4. If your browser displays the **Menu** icon  , click it.
The extender menu displays.
5. Select **Settings > Connected Devices**.
The Connected Devices (WPS) page displays.
6. In the WiFi Devices section, select the **Enable Access Control** check box.
The WiFi devices table displays the names and MAC addresses of WiFi devices that are connected to the extender.
7. Select the **Deny** check box for the device.
8. Click the **SAVE** button.
Your settings are saved and that device cannot connect to the extender's WiFi network.

Set Up an Access Schedule

You can control access by all users during specific periods of the day. You can set up an access schedule that prevents Internet access through the extender network based on the times that you set.

► To set up an access schedule:

1. Launch a web browser from a computer or mobile device that is connected to your extender network.
2. Log in to your extender:
 - If you did not enable the One WiFi Name feature, enter **www.mywifiext.net** in the address field of the browser.
 - If you enabled the One WiFi Name feature, enter one of the following URLs:
 - **Windows-based computers.** <http://mywifiext>
 - **Mac computers and iOS devices.** <http://mywifiext.local>
 - **Android devices.** <http://<extender's IP address>> (for example, <http://192.168.1.3>)
For more information about how to find your extender's IP address, see [Find the Extender's IP Address](#) on page 46.

A login page displays.

3. Enter your admin email address and password and click the **LOG IN** button.
The Status page displays.
4. If your browser displays the **Menu** icon  , click it.
The extender menu displays.

5. Select **Do More > Access Schedule**.
The Access Schedule page displays.
6. Select the **Access Schedule On** radio button.
The page adjusts.
7. In the **Days** menu and the **Time** menu, select the day and time when you want to disable Internet access.
8. Click the **Add Time** button to add the time that you specified to the Scheduled Times table.
9. Click the **SAVE** button.
Your settings are saved.

Change the Extender's Device Name

The default device name is the extender's model number.

► To change the extender's device name:

1. Launch a web browser from a computer or mobile device that is connected to your extender network.
2. Log in to your extender:
 - If you did not enable the One WiFi Name feature, enter **www.mywifiext.net** in the address field of the browser.
 - If you enabled the One WiFi Name feature, enter one of the following URLs:
 - **Windows-based computers.** <http://mywifiext>
 - **Mac computers and iOS devices.** <http://mywifiext.local>
 - **Android devices.** <http://<extender's IP address>> (for example, <http://192.168.1.3>)
For more information about how to find your extender's IP address, see [Find the Extender's IP Address](#) on page 46.

A login page displays.

3. Enter your admin email address and password and click the **LOG IN** button.
The Status page displays.
4. If your browser displays the **Menu** icon , click it.
The extender menu displays.
5. Select **Settings > Wireless Settings**.
The WiFi Settings page displays.
6. Scroll down and click the **IP Address** heading.
The page expands.
7. In the **Device Name** field, type a name.
8. Click the **SAVE** button.

Your settings are saved.

Set Up the Extender to Use a Static IP Address

The extender comes set up to use a dynamic IP address, which is the correct setting for most home networks.

► To set up the extender to use a static IP address:

1. Launch a web browser from a computer or mobile device that is connected to your extender network.
2. Log in to your extender:
 - If you did not enable the One WiFi Name feature, enter **www.mywifiext.net** in the address field of the browser.
 - If you enabled the One WiFi Name feature, enter one of the following URLs:
 - **Windows-based computers.** <http://mywifiext>
 - **Mac computers and iOS devices.** <http://mywifiext.local>
 - **Android devices.** <http://<extender's IP address>> (for example, <http://192.168.1.3>)
For more information about how to find your extender's IP address, see [Find the Extender's IP Address](#) on page 46.

A login page displays.

3. Enter your admin email address and password and click the **LOG IN** button.
The Status page displays.
4. If your browser displays the **Menu** icon , click it.
The extender menu displays.
5. Select **Settings > Wireless Settings**.
The WiFi Settings page displays.
6. Scroll down and click the **IP Address** heading.
The page expands.
By default, the **Dynamically get IP Address from Router** radio button is selected.
7. Select the **Use Static IP Address** radio button.
8. Complete the fields to specify the IP network IP addresses.
9. Click the **SAVE** button.
Your settings are saved.

Use the Extender With MAC Filtering or Access Control

When the WiFi device connects through the extender to your router, the MAC address of the WiFi device that is shown on the router is translated to another MAC address. If your router's MAC filter, wireless access control, or ACL is enabled, the WiFi device connects to the extender but cannot get an IP address from the extender and cannot access the Internet. To allow the WiFi device to receive an IP address from the extender and access the Internet, you must provide the translated MAC address to the router.

► To add a translated MAC address to your router:

1. Launch a web browser from a computer or mobile device that is connected to your extender network.
2. Log in to your extender:
 - If you did not enable the One WiFi Name feature, enter **www.mywifiext.net** in the address field of the browser.
 - If you enabled the One WiFi Name feature, enter one of the following URLs:
 - **Windows-based computers.** <http://mywifiext>
 - **Mac computers and iOS devices.** <http://mywifiext.local>
 - **Android devices.** <http://<extender's IP address>> (for example, <http://192.168.1.3>)
For more information about how to find your extender's IP address, see [Find the Extender's IP Address](#) on page 46.

A login page displays.

3. Enter your admin email address and password and click the **LOG IN** button.
The Status page displays.
4. If your browser displays the **Menu** icon , click it.
The extender menu displays.
5. Select **Settings > Connected Devices**.
The Connected Devices section displays the MAC addresses and virtual MAC addresses for computers and WiFi devices that are connected to the extender network.
6. On the router, add the extender's virtual MAC address and all the virtual MAC addresses connected to the extender network to your router's MAC filter table.
7. Enable the router's MAC filter, wireless access control, or ACL.

This chapter covers the following topics:

- *Change the Extender admin User Name and Password*
- *Turn Password Protection Off and On*
- *Recover a Forgotten User Name or Password*
- *Automatically Adjust for Daylight Saving Time*
- *Manually Set the Extender Clock*
- *Back Up and Manage the Extender Configuration*
- *Return the Extender to Its Factory Default Settings*
- *Update the Extender Firmware*
- *Restart the Extender Remotely*
- *Turn the Extender LEDs On or Off*

Change the Extender admin User Name and Password

You can change the admin user name and password that you use to log in to the extender.

► To add an extender user:

1. Launch a web browser from a computer or mobile device that is connected to your extender network.
2. Log in to your extender:
 - If you did not enable the One WiFi Name feature, enter **www.mywifiext.net** in the address field of the browser.
 - If you enabled the One WiFi Name feature, enter one of the following URLs:
 - **Windows-based computers.** <http://mywifiext>
 - **Mac computers and iOS devices.** <http://mywifiext.local>
 - **Android devices.** <http://<extender's IP address>> (for example, <http://192.168.1.3>)
For more information about how to find your extender's IP address, see [Find the Extender's IP Address](#) on page 46.

A login page displays.

3. Enter your admin email address and password and click the **LOG IN** button.
The Status page displays.
4. If your browser displays the **Menu** icon , click it.
The extender menu displays.
5. Select **Settings > Password**.
The Password Settings page displays.
6. To change the admin user name, enter a new email address in the **New User Name** field.
7. To change the admin password, enter a new password in the **New Password** field and the **Verify Password** field.
8. Select questions and enter the answers.
9. Click the **SAVE** button.
Your settings are saved.

Turn Password Protection Off and On

We recommend that you leave password protection on to help keep your network secure. You can turn password protection off and on.

► To turn password protection off or on:

1. Launch a web browser from a computer or mobile device that is connected to your extender network.
2. Log in to your extender:
 - If you did not enable the One WiFi Name feature, enter **www.mywifiext.net** in the address field of the browser.
 - If you enabled the One WiFi Name feature, enter one of the following URLs:
 - **Windows-based computers.** <http://mywifiext>
 - **Mac computers and iOS devices.** <http://mywifiext.local>
 - **Android devices.** <http://<extender's IP address>> (for example, <http://192.168.1.3>)
For more information about how to find your extender's IP address, see [Find the Extender's IP Address](#) on page 46.

A login page displays.

3. Enter your admin email address and password and click the **LOG IN** button.
The Status page displays.
4. If your browser displays the **Menu** icon , click it.
The extender menu displays.
5. Select **Settings > Password**.
The Password Settings page displays.
6. Select the **Password Off** or **Password On** radio button.
7. Click the **SAVE** button.
Your settings are saved.

Recover a Forgotten User Name or Password

If you changed the password that you use to access the extender and you set up password recovery, you can recover your password if you lose it.

► To recover your password that you use to access the extender:

1. Launch a web browser from a computer or mobile device that is connected to your extender network.
2. Log in to your extender:
 - If you did not enable the One WiFi Name feature, enter **www.mywifiext.net** in the address field of the browser.
 - If you enabled the One WiFi Name feature, enter one of the following URLs:

Nighthawk X4S AC2200 Tri-Band WiFi Range Extender

- **Windows-based computers.** <http://mywifiext>
- **Mac computers and iOS devices.** <http://mywifiext.local>
- **Android devices.** <http://<extender's IP address>> (for example, <http://192.168.1.3>)
For more information about how to find your extender's IP address, see [Find the Extender's IP Address](#) on page 46.

A login page displays.

3. Click the **Username & Password Help** link.

A page displays requesting the answers to your security questions.

If you forgot the answers to your security questions, restore the extender's factory settings and set up your login credentials again. See [Return the Extender to Its Factory Default Settings](#) on page 37.

4. Enter the saved answers to your security questions.
5. Click the **NEXT** button.
Your admin email address and password are displayed.
6. Click the **BACK** button.
A login page displays.
7. Log in to the extender.

Automatically Adjust for Daylight Saving Time

► To set up the extender to automatically adjust for daylight saving time:

1. Launch a web browser from a computer or mobile device that is connected to your extender network.
2. Log in to your extender:
 - If you did not enable the One WiFi Name feature, enter **www.mywifiext.net** in the address field of the browser.
 - If you enabled the One WiFi Name feature, enter one of the following URLs:
 - **Windows-based computers.** <http://mywifiext>
 - **Mac computers and iOS devices.** <http://mywifiext.local>
 - **Android devices.** <http://<extender's IP address>> (for example, <http://192.168.1.3>)
For more information about how to find your extender's IP address, see [Find the Extender's IP Address](#) on page 46.

A login page displays.

3. Enter your admin email address and password and click the **LOG IN** button.
The Status page displays.
4. If your browser displays the **Menu** icon , click it.

The extender menu displays.

5. Select **Do More > Access Schedule**.
The Access Schedule page displays.
6. Select the **Automatically adjust for daylight savings** time check box.
7. Click the **SAVE** button.
Your settings are saved.

Manually Set the Extender Clock

If you turned on the access schedule, you can set the extender clock. The extender clock makes sure that the WiFi access schedules are accurate.

► To manually set the extender clock:

1. Launch a web browser from a computer or mobile device that is connected to your extender network.
2. Log in to your extender:
 - If you did not enable the One WiFi Name feature, enter **www.mywifiext.net** in the address field of the browser.
 - If you enabled the One WiFi Name feature, enter one of the following URLs:
 - **Windows-based computers.** <http://mywifiext>
 - **Mac computers and iOS devices.** <http://mywifiext.local>
 - **Android devices.** <http://<extender's IP address>> (for example, <http://192.168.1.3>)
For more information about how to find your extender's IP address, see [Find the Extender's IP Address](#) on page 46.

A login page displays.

3. Enter your admin email address and password and click the **LOG IN** button.
The Status page displays.
4. If your browser displays the **Menu** icon , click it.
The extender menu displays.
5. Select **Do More > Access Schedule**.
The Access Schedule page displays.
6. In the Extender Clock section, select the **Manual** radio button.
7. To specify the time, complete the fields or click the **Sync Clock** button to synchronize the extender time to the time on the computer or mobile device that you are using.
8. Click the **SAVE** button.
Your settings are saved.

Back Up and Manage the Extender Configuration

When the extender works correctly after initial setup, we recommend that you back up the extender configuration settings. After you back up the settings, if you change the extender configuration settings but are not content with the new settings, you can restore the extender configuration to the backed-up settings.

Back Up the Configuration Settings

You can back up the configuration file of the extender.

► To back up the extender configuration settings:

1. Launch a web browser from a computer or mobile device that is connected to your extender network.
2. Log in to your extender:
 - If you did not enable the One WiFi Name feature, enter **www.mywifiext.net** in the address field of the browser.
 - If you enabled the One WiFi Name feature, enter one of the following URLs:
 - **Windows-based computers.** <http://mywifiext>
 - **Mac computers and iOS devices.** <http://mywifiext.local>
 - **Android devices.** <http://<extender's IP address>> (for example, <http://192.168.1.3>)For more information about how to find your extender's IP address, see [Find the Extender's IP Address](#) on page 46.

A login page displays.

3. Enter your admin email address and password and click the **LOG IN** button.
The Status page displays.
4. If your browser displays the **Menu** icon , click it.
The extender menu displays.
5. Select **Settings > Other**.
The Other Settings page displays.
6. Click the **BACKUP** button.
Your browser extracts the configuration file from the extender. The backup file uses a `.cfg` extension.
7. If your browser is not set up to save downloaded files automatically, locate where you want to save the file.
8. Click the **OK** button.
The extender configuration settings are backed up.

Restore the Configuration Settings

You can restore the configuration settings of the extender to a previously saved configuration file.

▶ To restore the extender configuration settings:

1. Launch a web browser from a computer or mobile device that is connected to your extender network.
2. Log in to your extender:
 - If you did not enable the One WiFi Name feature, enter **www.mywifiext.net** in the address field of the browser.
 - If you enabled the One WiFi Name feature, enter one of the following URLs:
 - **Windows-based computers.** <http://mywifiext>
 - **Mac computers and iOS devices.** <http://mywifiext.local>
 - **Android devices.** <http://<extender's IP address>> (for example, <http://192.168.1.3>)For more information about how to find your extender's IP address, see [Find the Extender's IP Address](#) on page 46.

A login page displays.

3. Enter your admin email address and password and click the **LOG IN** button.
The Status page displays.
4. If your browser displays the **Menu** icon , click it.
The extender menu displays.
5. Select **Settings > Other**.
The Other Settings page displays.
6. Click the **BROWSE** button.
7. Locate and select the previously saved backup file.
The backup file uses a `.cfg` extension.



CAUTION:

After you click the **RESTORE** button, do not try to go online, turn off the extender, shut down the computer, or do anything else to the extender until it finishes restarting.

8. Click the **RESTORE** button.
A confirmation pop-up window opens.
9. Confirm your decision.
The extender configuration is restored and the extender restarts. This process takes about one minute.

Return the Extender to Its Factory Default Settings

Under some circumstances (for example, if you lose track of the changes that you made to the extender settings), you might want to erase the configuration and reset the extender to factory default settings.

To reset the extender to factory default settings, you can either use the **Reset** button on the back panel or log in to the extender and reset it.

Use the Reset Button



CAUTION:

This process erases any settings that you configured in the extender.

► **To use the Reset button to return the extender to its factory default settings:**

1. Insert a straightened paper clip into the hole of the **Reset** button and hold it for about seven seconds.
2. Release the button.



CAUTION:

Do not try to go online, turn off the extender, shut down the computer, or do anything else to the extender until it finishes restarting!

The extender resets and restarts. This process takes about one minute.

Log In and Reset the Extender to Factory Settings



CAUTION:

This process erases any settings that you configured in the extender.

► **To log in to the extender and reset the extender's factory settings:**

1. Launch a web browser from a computer or mobile device that is connected to your extender network.
2. Log in to your extender:
 - If you did not enable the One WiFi Name feature, enter **www.mywifiext.net** in the address field of the browser.
 - If you enabled the One WiFi Name feature, enter one of the following URLs:

Nighthawk X4S AC2200 Tri-Band WiFi Range Extender

- **Windows-based computers.** <http://mywifiext>
- **Mac computers and iOS devices.** <http://mywifiext.local>
- **Android devices.** <http://<extender's IP address>> (for example, <http://192.168.1.3>)
For more information about how to find your extender's IP address, see [Find the Extender's IP Address](#) on page 46.

A login page displays.

3. Enter your admin email address and password and click the **LOG IN** button.
The Status page displays.
4. If your browser displays the **Menu** icon , click it.
The extender menu displays.
5. Select **Settings > Other**.
The Other Settings page displays.



CAUTION:

After you click the **RESET** button, do not try to go online, turn off the extender, shut down the computer, or do anything else to the extender until it finishes restarting.

6. Click the **RESET** button.
A confirmation pop-up window opens.
7. Confirm your decision.
The extender returns to its factory settings and restarts. This process takes about one minute.

Update the Extender Firmware

You can log in to the extender and check to see if new firmware is available, or you can manually load a specific firmware version to your extender.

Check for New Firmware and Update the Extender

Unless you changed the settings in the Firmware Update page previously, the extender is set up to check for new firmware automatically at login.

► To check manually for new firmware and, if available, update the firmware:

1. Launch a web browser from a computer or mobile device that is connected to your extender network.
2. Log in to your extender:

Nighthawk X4S AC2200 Tri-Band WiFi Range Extender

- If you did not enable the One WiFi Name feature, enter **www.mywifiext.net** in the address field of the browser.
- If you enabled the One WiFi Name feature, enter one of the following URLs:
 - **Windows-based computers.** <http://mywifiext>
 - **Mac computers and iOS devices.** <http://mywifiext.local>
 - **Android devices.** <http://<extender's IP address>> (for example, <http://192.168.1.3>)
For more information about how to find your extender's IP address, see [Find the Extender's IP Address](#) on page 46.

A login page displays.

3. Enter your admin email address and password and click the **LOG IN** button.
The Status page displays.
4. If your browser displays the **Menu** icon , click it.
The extender menu displays.
5. Select **Firmware Update**.
The Firmware Update page displays.
6. Click the **CHECK ONLINE** button.
7. If new firmware is available, follow the onscreen prompts to update the firmware.

Note You might need to unzip the firmware file. The firmware update process takes about two minutes.

Manually Upload Firmware to the Extender

If you want to upload a specific firmware version, follow these instructions.

► To manually upload a firmware file to your extender:

1. Launch a web browser from a computer or mobile device that is connected to your extender network.
2. Log in to your extender:
 - If you did not enable the One WiFi Name feature, enter **www.mywifiext.net** in the address field of the browser.
 - If you enabled the One WiFi Name feature, enter one of the following URLs:
 - **Windows-based computers.** <http://mywifiext>
 - **Mac computers and iOS devices.** <http://mywifiext.local>
 - **Android devices.** <http://<extender's IP address>> (for example, <http://192.168.1.3>)

Maintain and Monitor the Extender

Nighthawk X4S AC2200 Tri-Band WiFi Range Extender

For more information about how to find your extender's IP address, see [Find the Extender's IP Address](#) on page 46.

A login page displays.

3. Enter your admin email address and password and click the **LOG IN** button. The Status page displays.
4. If your browser displays the **Menu** icon , click it. The extender menu displays.
5. Select **Firmware Update**. The Firmware Update page displays.
6. Click the **BROWSE** button.
7. Locate and select the new firmware file. The firmware file name ends with a `.chk` extension.



CAUTION:

After you click the **UPLOAD** button, do not try to go online, turn off the extender, shut down the computer, or do anything else to the extender until it finishes restarting.

8. Click the **UPLOAD** button. The firmware update starts and the extender restarts. The firmware update process takes about two minutes.

Restart the Extender Remotely

You can log in to the extender and restart it. When the extender restarts, all computers and WiFi devices that are connected to its WiFi network are automatically disconnected.

► To restart the extender remotely:

1. Launch a web browser from a computer or mobile device that is connected to your extender network.
2. Log in to your extender:
 - If you did not enable the One WiFi Name feature, enter **www.mywifiext.net** in the address field of the browser.
 - If you enabled the One WiFi Name feature, enter one of the following URLs:
 - **Windows-based computers.** `http://mywifiext`
 - **Mac computers and iOS devices.** `http://mywifiext.local`
 - **Android devices.** `http://<extender's IP address>` (for example, `http://192.168.1.3`)

Maintain and Monitor the Extender

Nighthawk X4S AC2200 Tri-Band WiFi Range Extender

For more information about how to find your extender's IP address, see [Find the Extender's IP Address](#) on page 46.

A login page displays.

3. Enter your admin email address and password and click the **LOG IN** button.
The Status page displays.
4. If your browser displays the **Menu** icon , click it.
The extender menu displays.
5. Select **Settings > Other**.
The Other Settings page displays.
6. Click the **RESTART** button and click the **Yes** button to confirm.
The extender restarts, which takes about two minutes.

Turn the Extender LEDs On or Off

You can turn the Router Link LED, 2.4 GHz Client Link LED, 5 GHz Client Link LED, and WPS LED on or off. If you turn the LEDs off, the Power LED remains lit.

► To turn the NETGEAR logo LED on or off:

1. Launch a web browser from a computer or mobile device that is connected to your extender network.
2. Log in to your extender:
 - If you did not enable the One WiFi Name feature, enter **www.mywifiext.net** in the address field of the browser.
 - If you enabled the One WiFi Name feature, enter one of the following URLs:
 - **Windows-based computers.** <http://mywifiext>
 - **Mac computers and iOS devices.** <http://mywifiext.local>
 - **Android devices.** <http://<extender's IP address>> (for example, <http://192.168.1.3>)
For more information about how to find your extender's IP address, see [Find the Extender's IP Address](#) on page 46.

A login page displays.

3. Enter your admin email address and password and click the **LOG IN** button.
The Status page displays.
4. If your browser displays the **Menu** icon , click it.
The extender menu displays.
5. Select **Do More > LED On/Off**.
The LED On/Off page displays.

Nighthawk X4S AC2200 Tri-Band WiFi Range Extender

6. To turn the LEDs on, select the **ON** radio button.
7. To turn the LEDs off, select the **OFF** radio button.
If you turn the LEDs off, the Power LED remains lit.
8. Click the **SAVE** button.
Your settings are saved.

This chapter covers the following topics:

- *FAQs*
- *Cannot Connect to the Extender*
- *Cannot Join a WiFi Network and Receive an Error Message*
- *Cannot Access mywifiext.net*
- *Find the Extender's IP Address*

FAQs

This section provides answers for difficulties you might experience with the extender.

The web browser setup keeps asking me for my network password (passphrase) or security key, and I am sure that I entered the correct password. What can I do?

The extender is probably placed at the borderline of the range covered by the router or access point. To improve your signal strength, move your extender closer to your router and make sure that the Router Link LED lights solid blue or amber.

The LED lights as follows:

- **Solid blue.** Best connection
- **Solid amber.** Good connection
- **Solid red.** Poor connection
- **Off.** No connection

If you are using WEP security, make sure that you are typing the network password in the correct field.

My router security is WEP, and I entered the wrong password or security key on the extender. I cannot access the extender anymore. What can I do?

The extender cannot check to see if the WEP password is correct. If you entered the wrong password, your WiFi-enabled computer or mobile device is not able to get the IP address from the extender. You must reset the extender to its factory default settings to get the IP address back.

I am connected to NETGEAR_EXT and launched a browser and I can't I see the web browser setup guide. What can I do?

Try these troubleshooting steps:

- Make sure that your computer is set up to use DHCP (most are).
- Make sure that the 2.4 GHz or 5 GHz Client Link LED is white and that you are using a valid IP address.
- Relaunch the web browser and enter **www.mywifiext.net** in the address field. Enter your admin email address and password and click the **LOG IN** button.
- If you are installing the extender as an access point, make sure that you are connecting your computer or WiFi device to the extender through a WiFi connection instead of an Ethernet connection.

I forgot my admin email address and password. What can I do?

On the login window, click the **Username & Password Help** link to answer the security questions that you set up during the initial setup. For more information, see [Recover a Forgotten User Name or Password](#) on page 32.

▶ To restore factory settings:

1. Use a sharp object such as a pen or paper clip to press and hold the **Reset** button on the extender for seven seconds until the Power LED lights amber.
2. Release the **Reset** button and wait for the extender to reboot. The extender resets and returns to the factory default settings.

Cannot Connect to the Extender

If you cannot connect to the extender, determine what prevents you from connecting:

- If you cannot access www.mywifiext.net, see [Cannot Access mywifiext.net](#) on page 45 for more information.
- If you forgot your user name or password, click the **Username & Password Help** link. For more information, see [FAQs](#) on page 44.
- If your browser displays an error page, include **http://** in the address field of your browser by typing **http://www.mywifiext.net**.
- If you already set up the extender but can no longer connect to it over WiFi, check to see if the Client Link LED is off.
- If you cannot get a WiFi connection working, you can use an Ethernet cable to connect your computer to the extender.

Cannot Join a WiFi Network and Receive an Error Message

To join a WiFi network, you must know its network name (also called the SSID) so that you can select it. If the network is secure, you must know the passphrase or key. If the extender does not connect to the network that you select, the cause might be one of the following:

- It is possible that you typed the network name, passphrase, or key incorrectly. Use Smart Setup (see [Run Smart Setup Installation](#) on page 15) to select a WiFi network and retype the passphrase or key. The passphrase or key is case-sensitive. For example, PASSWORD25 is not the same as Password25 or password25.
- If the extender cannot detect your WiFi network, check to see if your WiFi network is still working. Make sure that the WiFi router is turned on. If possible, move the extender closer to the WiFi router.
- If the extender Router Link LED is red, the WiFi connection between the WiFi router and the extender is poor. You can establish the best connection with a clear line of sight between the extender and the WiFi router. Make sure that no physical obstacles exist between the extender and the WiFi router, and try to move the extender closer to the WiFi router.

If you use Smart Setup, and the extender does not connect to the WiFi router, does not connect to the Internet, or cannot get an IP address from the WiFi router, Smart Setup displays a message to notify you that the extender is not configured.

To run Smart Setup again, click the **YES** button. To manually configure the extender, click the **NO, CONFIGURE MANUALLY** button.

Cannot Access mywifiext.net

When you try to access www.mywifiext.net to set up your extender, you might receive an error message that says you are not connected to the extender's WiFi network. This website is not a regular Internet website. It is a local web address used to log in to the extender web browser interface and view the extender's settings.

Your computer or mobile device must be connected to your extender network to access www.mywifiext.net.

Nighthawk X4S AC2200 Tri-Band WiFi Range Extender

Try these troubleshooting tips to connect to www.mywifiext.net:

- If you're trying to access www.mywifiext.net for the first time to set up your extender, see *Connect With the NETGEAR Installation Assistant* on page 13 and follow the instructions.
- After you connect your computer or mobile device to the extender network, make sure that the extender's 2.4 GHz or 5 GHz Client Link LED is solid blue.
If the 2.4 GHz or 5 GHz Client Link LED is not lit, open your computer's or mobile device's WiFi connection manager and make sure that your device is still connected to the extender network.
- Launch a web browser and enter the extender's default IP address, which is **192.168.1.250**.
If this IP address does not work, it is possible that your extender's IP address changed. You can log in to your router to view your extender's IP address. For more information, see *Find the Extender's IP Address* on page 46.
- If your extender and router use the same WiFi network name (SSID), enter **http<extender's IP address>** (for example, <http://192.168.1.3>).
For more information about how to find your extender's IP address, see *Find the Extender's IP Address* on page ?.
- Clear your web browser's cache and browsing history and try again.
For more information, see the help content for your web browser.
- Try using another web browser.
- Assign a static IP address to your computer.
Before you change any network settings, note your current default gateway (Windows) or router (Mac) address. Use the IP address **192.168.1.249** and the subnet mask **255.255.255.0**.
For more information, see your computer's documentation.

Find the Extender's IP Address

If your extender and router use the same WiFi network name (SSID) and you want to log in to your extender using an Android device, you must use the extender's IP address.

You can log in to your router to find your extender's IP address. If you own a NETGEAR router, use the following procedure to find the extender's IP address. If you do not own a NETGEAR router, see your router's documentation.

Note The following instructions might not apply to your NETGEAR router. For more information, see your NETGEAR router's user manual.

► To log in to your extender and find your extender's IP address:

1. Launch a web browser from a computer or mobile device that is connected to the router network.
2. Enter **http://www.routerlogin.net**.
A login window opens.
3. Enter the router admin user name and password.
The user name is **admin**. The password is the one that you specified the first time that you logged in. The user name and password are case-sensitive.
The BASIC Home page displays.

Nighthawk X4S AC2200 Tri-Band WiFi Range Extender

4. Select **Attached Devices**.

A list of devices connected to your router displays.

5. Find your extender in the list and note your extender's IP address.

Supplemental Information

A

This appendix covers the following topics:

- *Factory Default Settings*
- *Technical and Environmental Specifications*

Factory Default Settings

To reset the extender to factory default settings, you can use the **Reset** button on the side panel or you can log in and click the onscreen **RESET** button. For more information, see [Return the Extender to Its Factory Default Settings](#) on page 37.

The following table shows the factory default settings.

Table 2. Factory default settings

Feature	Default Settings
Smart Setup	Enabled
WiFi communication	Enabled
WiFi network name (SSID)	NETGEAR_EXT
Security	Disabled
Transmission speed	Auto ¹
Country/region	Varies by region
Operating mode	802.11a/b/g/n/ac
Data rate in the 2.4 GHz band	54 Mbps/173 Mbps/400 Mbps
Data rate in the 5 GHz 1 band	Disabled by default (When enabled the data rate is 54 Mbps/173 Mbps/400 Mbps/866 Mbps)
Data rate in the 5 GHz 2 band	Disabled by default (When enabled the data rate is 54 Mbps/347 Mbps/800 Mbps/1733 Mbps)
DHCP	Server and client are enabled

¹Maximum WiFi signal rate (IEEE Standard 802.11). Actual throughput can vary. Network conditions and environmental factors, including volume of network traffic, building materials and construction, and network overhead lower actual data throughput rate.

Technical and Environmental Specifications

The following table shows the technical and environmental specifications.

Table 3. Technical specifications

Technical Specifications	
Network protocol and standards compatibility	Data and routing protocols: TCP/IP, DHCP server and client, DNS relay
Physical specifications	<ul style="list-style-type: none"> • Dimensions: 83.8 x 76.2 x 161 cm (3.3 x 3.0 x 6.34 in.) • Weight: 306 g (0.67 lb)
Environmental	<ul style="list-style-type: none"> • Operating temperature: 32° to 104°F (0° to 40°C) • Operating humidity: 90% maximum relative humidity, noncondensing
Interface	802.11ac/n/a/g/b and 802.11k