



## SGFEB Series

Stand-alone Gigabit Ethernet Media and Rate Converter  
10/100/1000Base-T to 1000Base-SX/LX

User Guide

## Intellectual Property

© 2022, 2023 Lantronix, Inc. All rights reserved. No part of the contents of this publication may be transmitted or reproduced in any form or by any means without the written permission of Lantronix.

*Lantronix* is a registered trademark of Lantronix, Inc. in the United States and other countries. All other trademarks and trade names are the property of their respective holders.

Patented: <https://www.lantronix.com/legal/patents/>; additional patents pending.

## Warranty

For details on the Lantronix warranty policy, go to <http://www.lantronix.com/support/warranty>.

## Contacts

### Lantronix Corporate Headquarters

48 Discovery, Suite 250  
Irvine, CA 92618, USA  
Toll Free: 800-526-8766  
Phone: 949-453-3990  
Fax: 949-453-3995

### Technical Support

Online: <https://www.lantronix.com/technical-support/>

### Sales Offices

For a current list of our domestic and international sales offices, go to [www.lantronix.com/about/contact](http://www.lantronix.com/about/contact).

## Disclaimer

All information contained herein is provided "AS IS." Lantronix undertakes no obligation to update the information in this publication. Lantronix does not make, and specifically disclaims, all warranties of any kind (express, implied or otherwise) regarding title, non-infringement, fitness, quality, accuracy, completeness, usefulness, suitability or performance of the information provided herein. Lantronix shall have no liability whatsoever to any user for any damages, losses and causes of action (whether in contract or in tort or otherwise) in connection with the user's access or usage of any of the information or content contained herein. The information and specifications contained in this document are subject to change without notice. Transition Networks is now Lantronix. Some products/firmware items are still in process of being re-branded and may still reflect the Transition Networks name/logo.

## Revision History

Rev	Date	Description
A	2/3/15	Initial release.
B	3/23/15	Corrected SFP port number references and DIP switch description on page 7 and fiber cable specs on pages 2 and 16.
C	4-30-15	Update specs on pages 2, 4, 16, 20.
D	6/2/16	Update Port Isolation feature description. Add note that Half duplex is only an option in SFP versions.
E	7/26/23	Initial Lantronix re-brand.

## Contents

Introduction .....	4
Ordering Information.....	4
Optional Accessories (sold separately) .....	4
Power Supply Included .....	4
For More Information .....	5
Package Contents .....	7
Status LEDs .....	13
Fiber Status LEDs.....	13
Copper Status LEDs .....	13
Auto-Negotiation .....	14
Link Pass-Through (LPT).....	14
Full-Duplex Network.....	14
Half-Duplex Network (512-Bit Rule).....	14
AutoCross™ .....	14
Automatic Link Restoration .....	15
Far End Fault (FEF) .....	15
Remote Fault Detect (RFD) .....	15
Fiber Redundancy (Revertive / Non-revertive) .....	15
New Features.....	15
Port Isolation on 3-Port Models .....	16
Port Isolation on 4-Port Models .....	17
Cable Specifications .....	18
Copper Cable Specs.....	18
TP Port Specs .....	18
Fiber Cable Specs .....	19
Technical Specifications.....	20
Declaration of Conformity .....	24
CE .....	24
FCC.....	24
Canadian.....	24
European.....	25
RoHS, WEEE, and Environmental Programs .....	25
Product Registration .....	25

## Introduction

The SGFEB Series is a stand-alone media converter that provides an interface between 10/100/1000Base-T ports and 1000Base-SX/LX ports, allowing users to integrate fiber optic cabling into 10/100/1000 copper environments. Operating at Layer 2, the data link layer, this converter not only converts copper to fiber, it also provides rate conversion allowing legacy 10/100 copper devices to connect to 1000Base-SX/LX fiber.

## Ordering Information

SKU	Description
SGFEB1040-130	10/100/1000Base-T (RJ-45) [100 m/328 ft.] to 100/1000Base-X SFP Slot (empty)
SGFEB1013-130	10/100/1000Base-T (RJ-45) [100 m/328 ft.] to 1000Base-SX 850nm MM (SC) [62.5/125 um: 220 m/722 ft.] [50/125 um: 550 m/1804 ft.] Link Budget 7.5dB
SGFEB1039-130	10/100/1000Base-T (RJ-45) [100 m/328 ft.] to 1000Base-SX 850nm MM (LC) [62.5/125 um: 220 m/722 ft.] [50/125 um: 550 m/1804 ft.] Link Budget 8.0dB
SGFEB1024-130	10/100/1000Base-T (RJ-45) [100 m/328 ft.] to 1000Base-SX 1300nm Extended MM (62.5/125um fiber only) (SC) [up to 2km] Link Budget: 7.0db
SGFEB1014-130	10/100/1000Base-T (RJ-45) [100 m/328 ft.] to 1000Base-LX 1310nm SM (SC) [10 km/6.2 mi.] Link Budget 12.0dB
SGFEB1019-130	10/100/1000Base-T (RJ-45) [100 m/328 ft.] to 1000Base-LX 1310nm SM (LC) [10 km/6.2 mi.] Link Budget 10.5dB
SGFEB1040-230	(1) Port 10/100/1000Base-T (RJ-45) [100 m/328 ft.] to (2) Ports 100/1000Base-X SFP Slot (empty)
SGFEB1040-330	(2) Port 10/100/1000Base-T (RJ-45) [100 m/328 ft.] to (2) Ports 100/1000Base-X SFP Slot (empty)

## Optional Accessories (sold separately)

SKU	Description
<a href="#">SPS-2460-PS</a>	Wide Input (24 – 60VDC) Piggy-Back Power Supply for use with stand-alone Media Converters 3.25" wide.
<a href="#">SPS-2460-SA</a>	Wide Input (24 – 60VDC) Stand-Alone Power Supply for use with all stand-alone Media Converters.
<a href="#">25025</a>	12VDC@1.25A, 100-240VAC (~1.0A) Power Supply. Requires a country-specific power cord. Order as -xx to indicate country-specific power supply/cord. See ' <a href="#">Power Supply Included</a> ' below.
WMBD	DIN Rail Mount Bracket 5.0 inches (127 mm)
WMBL	Wall Mount Bracket 4.0 inches (102 mm)
E-MCR-05	12-Slot Media Converter Rack
RMS19-SA4-01	4-Slot Media Converter Shelf
SFP Modules	See the Lantronix Small Form Factor Pluggable (SFP) <a href="#">product page</a>

## Power Supply Included

To order the corresponding country specific power supply, add the extension from the list below to the end of the SKU; e.g., SGFEB1040-130-NA where -NA = North America, -LA = Latin America, -EU = Europe, -UK = United Kingdom, -SA = South Africa, -JP = Japan, -OZ = Australia, and -BR = Brazil.

## For More Information

For Lantronix Drivers, Firmware, Manuals, Product Notifications, Warranty Policy & Procedures, etc. go to the Lantronix [Technical Resource Center](#).

## Distances

The distances listed below are typical maximum cable distances. Actual distance depends on the physical characteristics of the network installation.

Part #	Copper Ports 10/100/1000-Base-T	Duplex Fiber-Optic Ports
SGFEB1013-130	One RJ-45 100 m (328 ft)	SC, 1000Base-SX, 850nm multimode 220m (OM1)/550m (OM2) (720/1,805 ft)
SGFEB1040-130	One RJ-45 100 m (328 ft)	One 100/1000 Base-X SFP slot (empty)
SGFEB1040-230	One RJ-45 100 m (328 ft)	Two 100/1000 Base-X SFP slots (empty)
SGFEB1040-330	Two RJ-45 100 m (328 ft)	Two 100/1000 Base-X SFP slots (empty)
SGFEB1039-130	One RJ-45 100 m (328 ft)	LC, 1000Base-SX, 850nm multimode 220m (OM1)/550m (OM2) 720/1805 ft.)
SGFEB1024-130	One RJ-45 100 m (328 ft)	SC, 1000Base-SX 1300nm Extended MM (62.5/125um fiber only) (SC) [up to 2km]
SGFEB1014-130	One RJ-45 100 m (328 ft)	SC, 1000Base-LX, 1310nm single mode 10km / 6.2 miles
SGFEB1019-130	One RJ-45 100 m (328 ft)	LC, 1000Base-LX, 1310nm single mode 10km / 6.2 miles

## Applications

- Integrate 1000Base-SX/LX Fiber into 10/100/1000 Copper environments
- Extend Network Distance
- Bridge legacy 10/100 devices to a Gigabit backbone

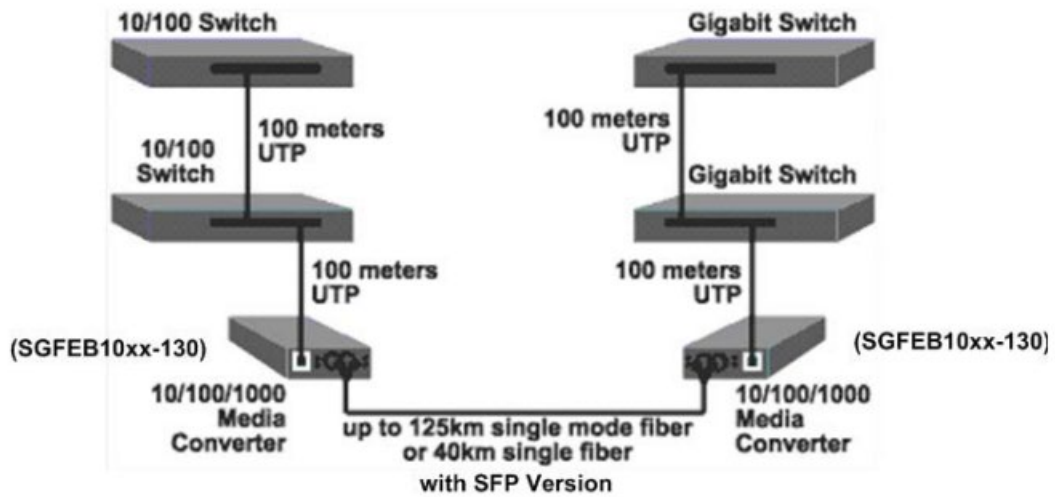

Generic Application

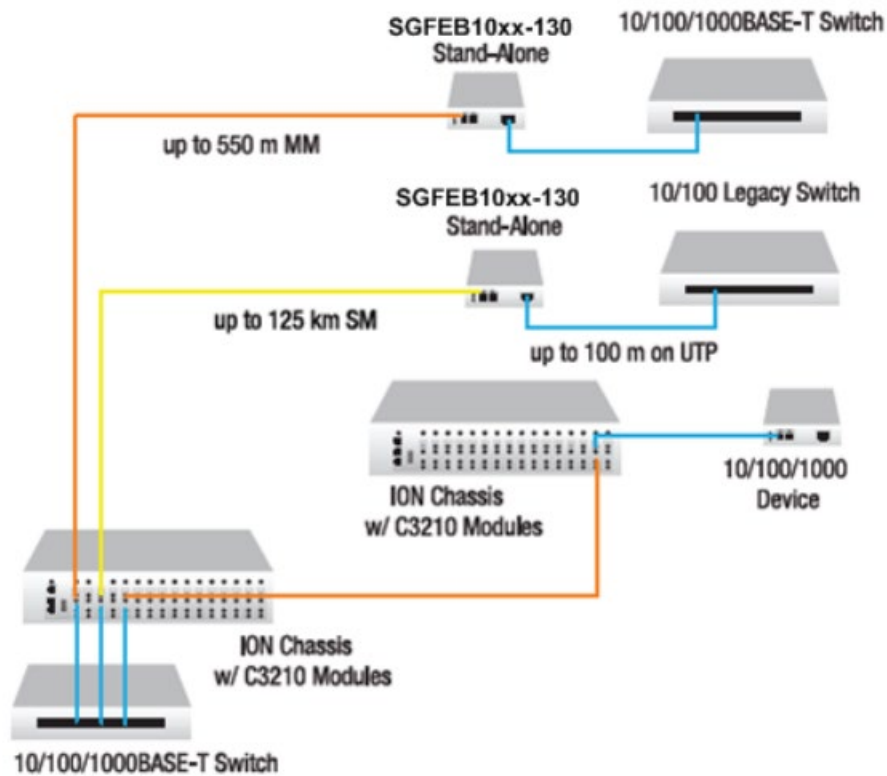

Lantronix ION Application

## Package Contents

Before you start installing the SGFEB, verify that the package contains the following items:

- One SGFEB Media Converter
- One Documentation Postcard
- One Power Supply with Changeable AC Plugs
- Four rubber feet

Please notify your sales representative immediately if any of the above items are missing or damaged.

## Installation

**Warning:** Before installing the SGFEB, make sure that proper electrical grounding procedures have been followed.

To install the SGFEB, perform the following steps:

1. Determine your Model number and related DIP Switch layout. See “[Configuration](#)” below.
1. Set the DIPs / Jumpers on the PCB. See either “[Two DIP Switch Layouts](#)” on page 9 or “[One DIP Switch Layouts](#)” on page 8.
2. Make the Power Connection. See “[Power Connection](#)” on page 10 below.
3. Determine your port connection types. See “[Port Locations](#)” on page 11 below.
4. Install and connect the copper cable as required. See “[Installing the RJ-45 Copper Cable](#)” on page 12.
5. Install and connect the fiber cable as required. See “[Installing the Fiber Cable](#)” on page 12.
6. Continue to the “[Operation](#)” section on page 13.

## Configuration

SGFEB models include one of two DIP switch layouts; either a single DIP switch or two DIP switches accessible through a cutout in the right side of the enclosure. Both DIP switch layouts are described in the following sections.

- Some SFP versions (SGFEB1040-230 and SGFEB1040-330) have two DIP switches.
- Other SFP versions and the Fixed optic version (SGFEB1040-130, SGFEB1013-130, SGFEB1014-130, SGFEB1019-130, and SGFEB1039-130) have one DIP switch.

The DIP Switch settings for both layouts are described and illustrated in the following sections.

## One DIP Switch Layouts

This layout has one six-position DIP Switch. The DIP switch is located on the right side of the SGFEB. Use a small, flat-blade screwdriver (or a similar device) to set the DIP switches according to your site requirements.



### A. 6-Position DIP switch:

- 1 - Twisted Pair Port (Port 2) Autonegotiation: Up = Enabled, Down = Disabled.
- 2 - Twisted Pair Port (Port 2) Speed: Up = 100Mbps, Down = 10Mbps (only for Autoneg disabled).
- 3 - Twisted Pair Port (Port 2) Duplex: Up = Full, Down = Half (only for Autoneg disabled).
- 4 - Link Pass Through (LPT) Up = Disabled, Down = Enabled) (TX to FX and FX to TX).
- 5, 6 SFP Port control: these DIP switch settings have no effect on fixed optics models.

5	6	Status
Up	Up	1000Base-X
Up	Down	SGMII Mode
Down	Up	100 Full Duplex
Down	Down	100 Half Duplex



## Two DIP Switch Layouts

This layout has one six-position DIP Switch and one four-position DIP Switch. The DIP switches are located on the right side of the SGFEB (SGFEB1040-230 or SGFEB1040-330). Use a small, flat-blade screwdriver (or a similar device) to set the DIP switches according to your site requirements.



The SGFEB version with two SFP ports supports two modes, controlled via DIP switches (Multi-port switch mode and Redundant fiber path mode).

### A. 6-Position DIP switch:

- 1 - Twisted Pair Port 2 Autonegotiation: Up = Enabled, Down = Disabled.
- 2 - Twisted Pair Port 2 Speed: Up = 100Mbps, Down = 10Mbps (only for Autoneg disabled).
- 3 - Twisted Pair Port 2 Duplex: Up = Full, Down = Half (only for Autoneg disabled).
- 4 - No affect; Link Pass Through does not apply to 3-port and 4-port models.
- 5, 6 (Port control): Port 1 (SFP)

5	6	Status
Up	Up	1000Base-X
Up	Down	SGMII Mode
Down	Up	100 Full Duplex
Down	Down	100 Half Duplex

**Note:** For multi-port switch mode and two twisted-pair port models, connecting two ports to a non-spanning tree enabled switch is not recommended.

**Note:** Port 4, if present, is permanently set for Auto-negotiate mode.

**4-Position DIP Switch** (on SFP versions, Port 3 populated) (default = all Up):

### Switches 1 and 2 (Fiber port 3):

5	6	Status
Up	Up	1000Base-X
Up	Down	SGMII Mode
Down	Up	100BaseFX Full Duplex
Down	Down	100BaseFX Half Duplex

### Switches 3 and 4:

5	6	Status
Up	Up	Multi-port switch mode
Up	Down	Fiber Redundancy Mode: Revertive
Down	Up	Fiber Redundancy Mode: Non-revertive
Down	Down	Port Isolation Enable

## Power Connection

Use the supplied AC power adapter to power the SGFEB standalone converter. To connect power to the SGFEB, do the following:

1. Connect the barrel connector on the power adapter cord to the power connector on the media converter shown below.



2. Plug the power adapter plug into AC power.



3. Verify that the media converter has powered UP—the power LED on the front panel is lit.

## Port Locations and Layouts

Port layouts and locations also vary by model number and PCB assembly as shown below.



**Note:** Port 1 and Port 2 always refer to Fiber port 1 and Copper port 1. Port 3 refers to a second Fiber port, and Port 4 refers to a second RJ45 (copper) port.

## Installing the RJ-45 Copper Cable

### 10/100/1000Base-T Copper Port:

1. Locate a 10/100/1000Base-TX compliant copper cable with male RJ-45 connectors installed at both ends.
2. Connect the RJ-45 connector at one end of the cable to the SGFEB's 10/100/1000Base-RJ-45 port.
3. Connect the RJ-45 connector at the other end of the cable to the 10/100/1000Base-RJ-45 port on the other device (switch, workstation, etc.).

**Note:** The AutoCross feature allows the use of either straight-through or crossover configuration cables.

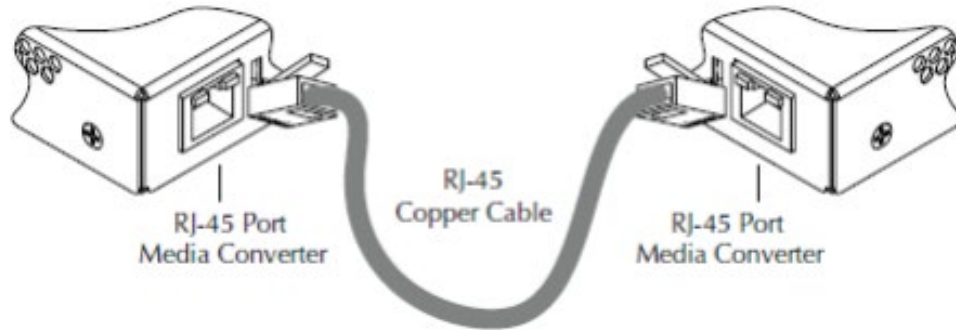

## Installing the Fiber Cable

### 1000Base-T Fiber Port:

1. Locate a 1000Base-X compliant fiber cable with male, two-stranded TX to RX connectors installed at both ends.
2. Connect the fiber cables to the media converter's 1000Base-X fiber port as described below:
  - Connect the male TX cable connector to the female TX connector.
  - Connect the male RX cable connector to the female RX connector.
3. Connect the fiber cables to the 1000Base-X fiber port on the other device (another media converter, hub, etc.) as described below:
  - Connect the male TX cable connector to the female RX connector.
  - Connect the male RX cable connector to the female TX connector.

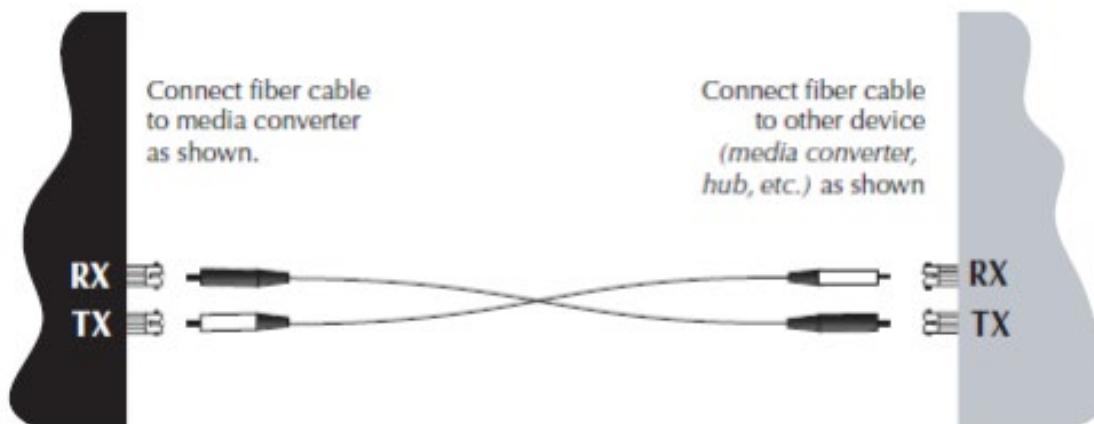

## Operation

### Status LEDs

Use the status LEDs to monitor SGFEB operations.



**PWR** (Power): On = Power is provided to the SGFEB.

### Fiber Status LEDs

The status LEDs for the 1000Base-SX/LX fiber connection (labeled LACT and DUP) are located under the fiber port (Port 1 and Port 3).

**LACT**: On (continuously lit) means a link has been established for the fiber connection.

Flashing means that the fiber connection is transmitting or receiving data.

**DUP**: On (continuously lit) means Full Duplex (FDX); Off means Half duplex (HDX). Note: Half duplex is only an option in SFP versions of this converter. If Half duplex on the fiber port is desired, it is configured by DIP switches #5 and #6 on the 6-position DIP switch.

### Copper Status LEDs

The status LEDs for the copper connection (port 2 and Port 4) are integrated into the RJ-45 port. These LEDs are not labeled.

#### TP Link / Activity / Duplex LED (upper left)

*Amber*: A link in half-duplex mode has been established for the copper connection.

*Flashing Amber*: The copper connection is transmitting or receiving data in half-duplex mode.

*Green*: A link in full-duplex mode has been established for the copper connection.

*Flashing Green*: The copper connection is transmitting or receiving data in full-duplex mode.

#### Speed LED (upper right)

*Off*: 10 Mbps operation.

*Amber*: 100 Mbps operation.

*Green*: 1000 Mbps operation.

## Product Features

### Auto-Negotiation

The Auto-Negotiation feature allows the SGFEB10xx to automatically configure itself to achieve the best possible mode of operation over a link. The media converter broadcasts its speed (10 Mb/s, 100 Mb/s, or 1000 Mb/s) and duplex capabilities (full or half) to the other devices and negotiates the best mode of operation. Auto-Negotiation allows quick and easy installation because the optimal link is established automatically. No user intervention is required to determine the best mode of operation.

A scenario where the media converter is linked to a non-negotiating device is a case where the user may want to disable Auto-Negotiation. In this instance, the mode of operation will drop to the least common denominator between the two devices (e.g. 100 Mb/s, half-duplex). Disabling this feature gives the user the ability to force the connection to the best mode of operation.

**Note:** The SGFEB10xx-13x supports 1000 Mbps fiber Auto-Negotiation.

### Link Pass-Through (LPT)

The Link Pass-Through feature allows the media converter to monitor both the fiber and copper RX (receive) ports for loss of signal. In the event of a loss of an RX signal (1), the media converter will automatically disable the TX (transmit) signal (2), thus, "passing through" the link loss (3). The far-end device is automatically notified of the link loss (4), which prevents the loss of valuable data unknowingly being transmitted over an invalid link. **Note** that LPT is an option on 2 port versions.

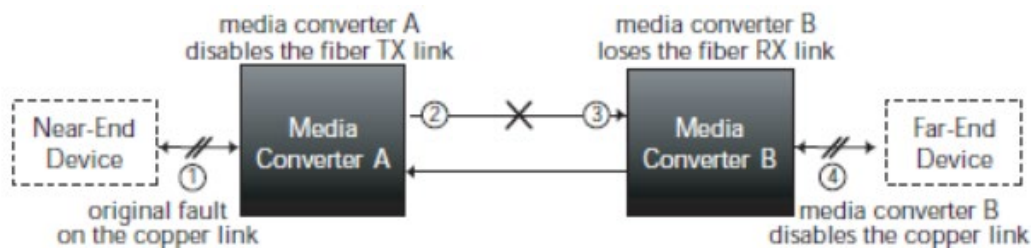

The LPT firmware algorithm will detect both fiber and Cu RX link loss; the link transmitter is disabled to propagate loss indication. Link Pass Through is a troubleshooting feature that allows the media converter to monitor both the fiber and copper RX ports for loss of signal. In the event of a loss of RX signal on one media port, the converter will automatically disable the TX signal of the other media port, thus "passing through" the link loss.

### Full-Duplex Network

In a full-duplex network, maximum cable lengths are determined by the type of cables that are used. See pages 3 and 4 for the cable specifications for the different SGFEB models. The 512-Bit Rule does not apply in a full-duplex network.

### Half-Duplex Network (512-Bit Rule)

In a half-duplex network, the maximum cable lengths are determined by the round trip delay limitations of each Fast Ethernet collision domain. (A collision domain is the longest path between any two terminal devices, e.g. a terminal, switch, or router.) The 512-Bit Rule determines the maximum length of cable permitted by calculating the round-trip delay in bit-times (BT) of a particular collision domain. If the result is less than or equal to 512 BT, the path is good.

### AutoCross™

The AutoCross feature allows either straight-through (MDI) or crossover (MDI-X) cables to be used when connecting to devices such as hubs, transceivers, or network interface cards (NICs). AutoCross determines the characteristics of the cable connection and automatically configures the unit to link up, regardless of the cable configuration.

### Automatic Link Restoration

The SGFEB will automatically restore the link between networked devices after a fault condition has been corrected. In contrast, products from competitors generally require the user to power down, then power up the converters after a fault condition has been corrected.

### Far End Fault (FEF)

The FEF feature applies to IEEE 802.3u 100Mbit Cu/Fiber rate only. The MAC may use FEF when Auto negotiation is disabled. When the MAC detects a PHY fault/TX loss link, a FEFI idle pattern is sent to the link partner TX (100BASE-FX only).

### Remote Fault Detect (RFD)

The RFD feature applies to 1000Mbps operation only. Remote Fault Detect (RFD) is a troubleshooting feature found on GigEthernet copper-to-fiber media converters. By enabling RFD on the remotely located media converter, the status of the fiber link will be monitored and any link failures will be reported back to the local converter. Should the remote converter lose its fiber RX signal, RFD will force the converter to shut down its fiber TX port. If Link Pass Through is enabled on both ends, then the copper ports will also be shut down to notify both end devices of the link failure.

### Fiber Redundancy (Revertive / Non-revertive)

Multiport versions provide 3 or 4 port switch functionality or provide redundant fiber links, with a switchover (failover) time of less than 1 second. In Revertive mode, after the failed link is recovered, it becomes the active link again (reverts to the failed link). In Non-revertive mode, after the failed link is recovered, the failed link does not become active again. The 4 port version does not support Fiber Redundancy mode but does support port isolation.

### New Features

1. Jumbo 10K frame support
2. 8k MAC addresses (vs 1k)
3. IEEE 802.3az
4. Multi-port mode default for multiple SFP assemblies.

## Port Isolation

The SGFEB -230 and -330 support Port Isolation. This function uses Port Isolation (Port Based VLAN) to disable the data paths between ports. This allows two customer-facing fiber ports and prevents each customer from seeing the other's traffic.

The Port Isolation (Port Based VLAN) feature creates a PVLAN (Private Virtual Local Area Network), but it does not use 802.1Q tags. The current Port Based VLAN implementation only forwards traffic to ports in a specific port's VLAN Table. Tagged and untagged traffic will move through the SGFEB unmodified.

Port isolation setup varies between models as shown and described below.

### Port Isolation on 3-Port Models

Port Isolation on 3-port devices sets up a port-based VLAN between the TP port and each Fiber port as shown below.

Port	Ports Traffic Forwarded To (VLAN Table)
1 (Fiber)	3
2 (Fiber)	3
3 (TP)	1, 2

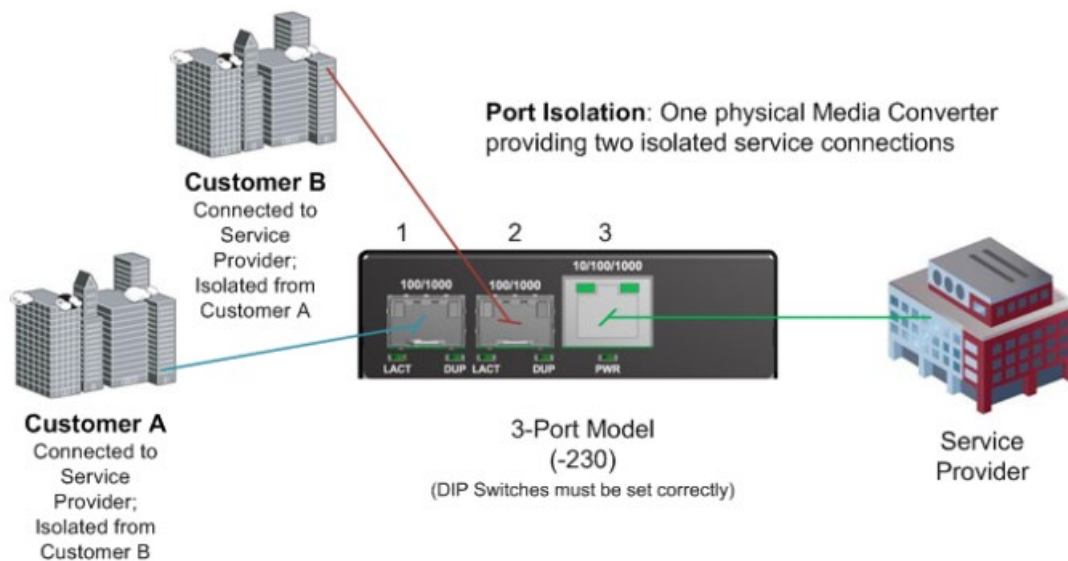



## Port Isolation on 4-Port Models

Port Isolation on 4-port devices sets up a private VLAN between ports 1 and 2, and a second Port Based VLAN between ports 3 and 4 (like having two independent converters).

Port	Ports Traffic Forwarded To (VLAN Table)
1 (Fiber)	2
2 (Fiber)	1
3 (TP)	4
4 (TP)	3

**Port Isolation: One physical Media Converter providing two logical connections**

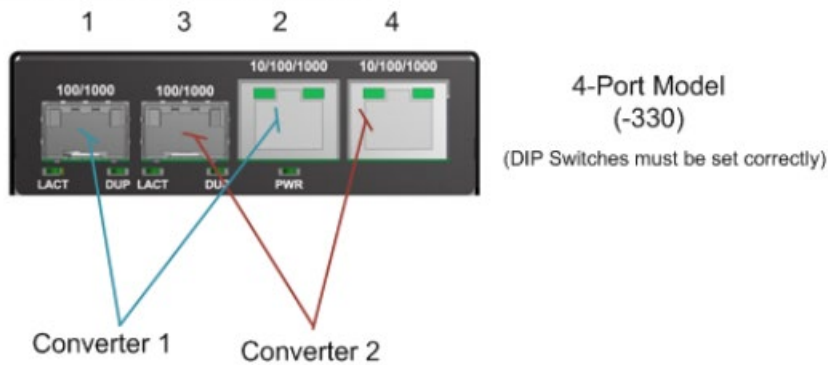

## Energy Efficient Ethernet (EEE)

Energy efficient Ethernet can significantly reduce the power consumption of the device over a period of time especially when there is a large amount of idle signals on the copper port. IEEE standard 802.3az which implements a Low Power Idle mode on copper interfaces with internal PHYs. SGFEB TP Ports have the EEE Low Power Idle mode enabled. Note that the Link LED remains lit when in low power mode. You can disable the 802.3az EEE function with a 2-pin header and a jumper (J13) on the board.

The SGFEB ships with EEE enabled; Jumper J13 has the jumper (shorting plug) uninstalled. Contact Tech Support to obtain the two-position jumper TN6907 if you want to disable EEE.

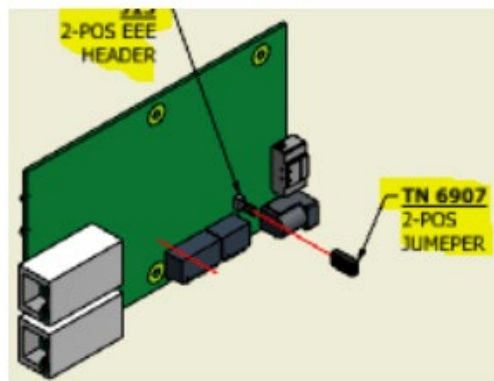

The amount of delay experienced while waiting for the copper interfaces to wake up and come out of low power idle mode is determined by the speed of the port:

$$\text{Delay} = \text{ASSERT TIME} + \text{WAKE TIME}$$

For 1000 Base, delay = 0 + 17us = 17us. For 100 Base, delay = 0 + 30us = 30us.

EEE Low Power Idle mode requires the copper port to advertise via the auto negotiation registers the ability to support EEE for both 1000Base-T and 100Base-T. Both local and remote ports must indicate they can support low power idle mode before the port can initiate a low power idle state.

During Auto-Negotiation the Port EEE capabilities are exchanged using the next page process to establish the speed and duplex information. Timer information with regards to tx\_idle, assert and wake cycles are set in SGFEB registers by the CPU. When a port egress queue remains empty for a specific period of time set by the EEE TX\_IDLE Timer register, then a low power state can be entered. The default setting for the TX\_IDLE is 2 milliseconds.

After the TX\_IDLE time the PHY will start the assert timer. The Assert timer will require the SGFEB to wait until the assert timer is zero before a wake up request can be processed. Currently the default Assert timer is set to 0, giving the PHY the ability to immediately start processing a request to leave the low power idle state. The PHY then enters low power idle mode. This mode is defined by a 22.35mili-seconds quiet period followed by a 210us refresh pulse. Then once a port sends a packet and the egress queue is no longer empty a wake up period is needed for the PHY to return to full operation. The default wake times are set to 17 micro-seconds for 1000Base and 30 micro-seconds for 100Base. During this wakeup time the packet will continue to buffer in the egress queue until the wake up timer has completed at this point port traffic will begin to flow as normal.

The SGFEB can also support a reduced power mode for 10Base-T in which it modifies the copper media transmit waveform to achieve power consumption savings.

## Cable Specifications

The physical characteristics must meet or exceed IEEE 802.3™ specifications.

### Copper Cable Specs

Category 5 (minimum requirement) STP or UTP

Gauge: 24 to 22 AWG

Attenuation: 22.0 dB /100 m @ 100 MHz

Maximum Cable Distance: 100 meters (328 ft)

- Straight-through OR crossover twisted-pair cable may be used.
- Shielded (STP) OR unshielded twisted-pair (UTP) cable may be used.
- All pin pairs (1&2, 3&6, 4&5, 7&8) are active pins in a Gigabit Ethernet network.
- Use only dedicated wire pairs for the active pins: (e.g., blue/white & white/blue, orange/white, white/orange, etc.)
- Do not use flat or silver satin wire.

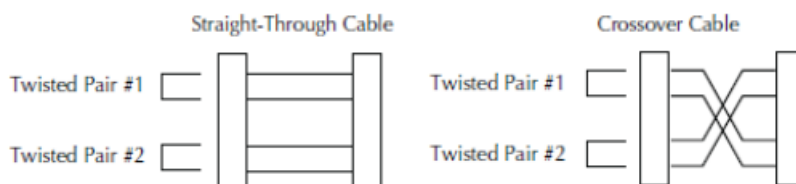

### TP Port Specs

1000BaseT Twisted Pair Ports:

- Connector: RJ45
- MDI/MDI-X selection: Automatic

## Fiber Cable Specs

The fiber optic transmitters on these devices meet Class I Laser safety requirements per IEC-825/CDRH standards and comply with 21 CFR1040.10 and 21CFR1040.11.

Bit Error Rate: <math>10^{-9}</math>  
Single mode fiber: 9  $\mu\text{m}$   
Multimode fiber: 62.5/125  $\mu\text{m}$   
Multimode fiber: 50/125  $\mu\text{m}$

### **SGFEB1013-130** 850nm multimode

Fiber Optic Transmitter Power: min: -9.5 dBm max: -4.0 dBm  
Fiber Optic Receiver Sensitivity: min: -17.0 dBm max: 0.0 dBm  
Link Budget: 7.5 dB

### **SGFEB1039-130** 850nm multimode (LC)

Fiber Optic Transmitter Power: min: -9.0 dBm max: -4.0 dBm  
Fiber Optic Receiver Sensitivity: min: -17.0 dBm max: -3.0 dBm  
Link Budget: 8.0 dB

### **SGFEB1024-130** 1300nm Extended MM (SC)

Fiber Optic Transmitter Power: min: -10.0 dBm max: -3.0 dBm  
Fiber Optic Receiver Sensitivity: min: -17.0 dBm max: -3.0 dBm  
Link Budget: 7.0db

### **SGFEB1014-130** 1310nm SM (SC)

Fiber Optic Transmitter Power: min: -9.0 dBm max: -3.0 dBm  
Fiber Optic Receiver Sensitivity: min: dBm -21.0 dBm max: -3.0 dBm  
Link Budget: 12.0 dB

### **SGFEB1019-130** 1310nm SM (LC)

Fiber Optic Transmitter Power: min: -9.5 dBm max: -3.0 dBm  
Fiber Optic Receiver Sensitivity: min: -20.0 dBm max: -3.0 dBm  
Link Budget: 10.5 dB

## Technical Specifications

The SGFEB was designed to meet these specifications.

### Standards

IEEE 802.3, IEEE 802.3ab, IEEE 802.3u, IEEE 802.3z, IEEE 802.3az

### Data Rates

Copper: 10/100/1000 Mbps

Fiber: 1000 Mbps, 100 Mbps also supported via SFP port

**Filtering Addresses:** 8K MAC addresses

**Max Frame Size:** 10,260 byte Jumbo Frames

### Dip Switches

Two Port Models

Switch 1: TP1 – Auto-Negotiation Enable / Disable

Switch 2: TP1 – Force 100Mbps or 10Mbps with switch 1 disabled

Switch 3: TP1 – Force Full or Half-Duplex with switch 1 disabled

Switch 4: Link Pass Through Enable / Disable

Switch 5 & 6: Controls Fiber SFP port for 1000M, 100M, or SGMII

Multiport Models with additional 4 position dip-switch

Switch 1 & 2: Controls the 2nd Fiber SFP port for 1000M, 100M, or SGMII

Switch 3 & 4: Fiber Redundancy Enable/Disable, Revertive Mode, and Fiber P2/P3 blocking

### Status LEDs

PWR (Power): On = Power is provided to converter

LACT (Fiber Link/Activity): On = Link, Blink = Activity

RJ-45 Upper Left (TP Link/Activity/Duplex): Green = Link Full-Duplex, Blink = Activity, Amber = Link Half-Duplex, Blink = Activity

RJ-45 Upper Right (Speed): Green = 1000Mbps, Amber = 100Mbps, Off = 10Mbps

### Dimensions

Width: 3.25" [82 mm] x Depth: 4.8" [122 mm] x Height: 1" [25 mm]

**Power Consumption:** 2.2 Watts

**Power Input:** 7.5 to 24 VDC, Provided by wide input AC Wall Mount Adapter

### Environment

Operating: 0°C to 50°C

Storage: -15°C to 65° C

Humidity: 5% to 95% (non-condensing)

Altitude: 0 – 10,000 ft.

**Weight:** 2 lbs. [0.90 kg]

### MTBF

Greater than 250,000 MIL-HDBK-217F Hours.

Greater than 687,500 Bellcore Hours

When bundled with a typical 50,000 hour power supply:

Greater than 41,660 MIL-HDBK-217F Hours

Greater than 114,580 Bellcore Hours

### Certifications

EN55022 Class A, EN55024, FCC Class A, CE Mark

Safety: Wall Mounted Power Supply: UL Listed, UL60950 and CSA Certified

**Warranty:** Lifetime

## Warnings

**WARNING:** Visible and invisible laser radiation when open. Do not stare into the beam or view the beam directly with optical instruments. Failure to observe this warning could result in an eye injury or blindness.

**WARNING:** Use of controls, adjustments or the performance of procedures other than those specified herein may result in hazardous radiation exposure.

Copper based media ports, e.g., Twisted Pair (TP) Ethernet, USB, RS232, RS422, RS485, DS1, DS3, Video Coax, etc., are intended to be connected to intra-building (inside plant) link segments that are not subject to lightening transients or power faults.

Copper based media ports, e.g., Twisted Pair (TP) Ethernet, USB, RS232, RS422, RS485, DS1, DS3, Video Coax, etc., are NOT to be connected to inter-building (outside plant) link segments that are subject to lightening transients or power faults.



**Warning** Class 1 laser product.



**Warning** Invisible laser radiation may be emitted from disconnected fibers or connectors. Do not stare into beams or view directly with optical instruments.



**Warning** Use of controls, adjustments, or performing procedures other than those specified may result in hazardous radiation exposure.

### Laser safety standards:

- Class 1 LASER PRODUCT (IEC 60825-1 2001-01)
- Class I LASER PRODUCT (complies with 21 CFR 1040.10 and 1040.11 except for deviations pursuant to Laser Notice 50, dated July 26, 2001)

All fiber-optic ports have been tested and comply with the Class 1 limits of IEC 60825-1 and Class I limits of 21 CFR 1040.10.

**Waarschuwing** Klasse-1 laser produkt.

**Varoitus** Luokan 1 lasertuote.

**Attention** Produit laser de classe 1.

**Warnung** Laserprodukt der Klasse 1.

**Avvertenza** Prodotto laser di Classe 1.

**Advarsel** Laserprodukt av klasse 1.

**Aviso** Produto laser de classe 1.

**¡Advertencia!** Producto láser Clase I.

**Varning!** Laserprodukt av klass 1.

**Aviso** Produto a laser de classe 1.

**Advarsel** Klasse 1 laserprodukt.

## Model Number Cross Reference

The table below shows the various SGFEB models and related data.

New Model #	EOL Model #	Description	Port Config
<b>SGFEB1013-130</b>	SGFEB1013-120	10/100/1000BT TO 1000BX, SC MM, 850NM	RJ - 1x9
<b>SGFEB1014-130</b>	SGFEB1014-120	10/100/1000BT TO 1000BX, SC SM, 10KM	RJ - 1x9
	SGFEB1015-120	10/100/1000BT TO 1000BX, SC LH SM, 25KM	RJ - 1x9
	SGFEB1017-120	10/100/1000BT TO 1000BX, SC SM LW, 65KM	RJ - 1x9
<b>SGFEB1019-130</b>	--	10/100/1000Base-T RJ-45 to 1000Base-LX SM LC	RJ - 2x5
<b>SGFEB1024-130</b>	SGFEB1024-120	10/100/1000BT TO 1000BX, SC EXT MM	RJ - 1x9
<b>SGFEB1029-130</b>	SGFEB1029-120	10/100/1000BT TO 1000BX, 1310/1550, SC, 20KM BiDi	RJ - 1x9
<b>SGFEB1029-131</b>	SGFEB1029-121	10/100/1000BT TO 1000BX, 1550/1310, SC, 20KM BiDi	RJ - 1x9
	SGFEB1029-122	10/100/1000BT TO 1000BX, 1310/1550, SC, 40KM BiDi	RJ - 1x9
	SGFEB1029-123	10/100/1000BT TO 1000BX, 1550/1310, SC, 40KM BiDi	RJ - 1x9
	SGFEB1029-126	10/100/1000BT TO 1000BX, 1510/1590, 80KM BiDi	RJ - 1x9
	SGFEB1029-127	10/100/1000BT TO 1000BX, 1590/1510, 80KM BiDi	RJ - 1x9
	SGFEB1035-120	10/100/1000BT TO 1000BX, SC SM XXL, 120KM	RJ - 1x9
<b>SGFEB1039-130</b>	SGFEB1039-120	10/100/1000BT TO 1000BX, SINGLE SFP MM LC (not fixed optic, rather SFP bundled with TN-SFP-SX)	RJ - 2x5
<b>SGFEB1040-130</b>	SGFEB1040-120	10/100/1000BT TO 1000BX, SINGLE SFP	RJ - Single SFP
<b>SGFEB1040-230</b>	SGFEB1040-140	10/100/1000BT TO 1000BX, SFP	RJ - Dual SFP
	SGFEB4040-180	10/100/1000BT TO 1000BX, SFP	3 x SFP
<b>SGFEB1040-330</b>	--	10/100/1000BT TO 1000BX, SFP	2 RJ to 2 SFP

## Troubleshooting

### 1. Is the PWR (power) LED lit?

NO

- Is the power adapter the proper type of voltage and cycle frequency for the AC outlet?
- Is the power adapter properly installed in the media converter and in the outlet?
- If power LED blinking, may indicate incorrect or faulty power supply.

YES

- Proceed to step 2.

2. Verify DIP switch settings on pages 6 and 7. RJ45 port may auto-negotiate speed and duplex with the link partner if enabled, otherwise it is defined by the DIP switch. Fiber port speed and duplex are DIP switch defined only.

### 3. Is the Duplex LED lit Amber or green?

NO

- Check the copper cables for proper connection.

YES - Amber

- The media converter has selected half-duplex mode. If this is not the correct mode, disconnect and reconnect the copper cable to restart the negotiation process.
- Proceed to step 4.

YES - Green

- The media converter has selected full-duplex mode. If this is not the correct mode, disconnect and reconnect the copper cable to restart the negotiation process.
- Proceed to step 4.

### 4. Is the LACT LED lit?

NO

- Check the fiber cables for proper connection.
- Verify that the TX and RX cables on the media converter are connected to the RX and TX ports, respectively, on the other device.

YES

- Proceed to step 5.

### 5. Is the Speed LED lit?

NO

- The media converter has selected 10 Mb/s operation. If this is not the correct speed, disconnect and reconnect the copper cable to restart the negotiation process.

YES - Flashing Amber

- The media converter has selected 100 Mb/s speed. If not the correct speed, disconnect and reconnect the copper cable to re-negotiate.
- Contact Tech Support; see Contact Us below.

YES - Flashing Green

- The media converter has selected 1000 Mb/s operation. If this is not the correct speed, disconnect and reconnect the copper cable to re-negotiate.

### 6. Contact Tech Support; see Contact Us below.

See “[Status LEDs](#)” on page 11 for LED descriptions.

## Compliance Information

### Declaration of Conformity

Manufacture's Name: Lantronics, Inc.  
Manufacture's Address: 48 Discovery, Suite 250, Irvine, California 92618 USA

Declares that the product(s): SGFEB Series: SGFEBxxxx-xxx

Conforms to the following Product Regulations:  
FCC Part 15 Class A, EN 55022:2010, EN 55024:2010  
Directive 2004/108/EC  
Low-Voltage Directive 2006/95/EC  
IEC/EN 60950-1  
EMC Directive 89/336/EEC

With the technical construction on file at the above address, this product carries the CE Mark

I, the undersigned, hereby declare that the equipment specified above conforms to the above Directive(s) and Standard(s).

Place: Irvine, California

Date: July 24, 2023

Signature: *Eric Bass*

Full Name: Eric Bass

Position: Vice President of Engineering

### CE Mark

#### FCC regulations

This equipment has been tested and found to comply with the limits for a Class A digital device, pursuant to Part 15 of the FCC rules. These limits are designed to provide reasonable protection against harmful interference when the equipment is operated in a commercial environment. This equipment generates, uses and can radiate radio frequency energy and, if not installed and used in accordance with the instruction manual, may cause harmful interference to radio communications.

Operation of this equipment in a residential area is likely to cause harmful interference, in which case the user will be required to correct the interference at the user's own expense.

#### Canadian regulations

This digital apparatus does not exceed the Class A limits for radio noise for digital apparatus set out on the radio interference regulations of the Canadian Department of Communications.

Le présent appareil numérique n'émet pas de bruits radioélectriques dépassant les limites applicables aux appareils numériques de la Class A prescrites dans le Règlement sur le brouillage radioélectrique édicté par le ministère des Communications du Canada.



## European regulations

### Warning

This is a Class A product. In a domestic environment this product may cause radio interference in which case the user may be required to take adequate measures.

### Achtung !

Dieses ist ein Gerät der Funkstörgrenzwertklasse A. In Wohnbereichen können bei Betrieb dieses Gerätes Rundfunkstörungen auftreten. In diesem Fall ist der Benutzer für Gegenmaßnahmen verantwortlich.

### Attention !

Ceci est un produit de Classe A. Dans un environnement domestique, ce produit risque de créer des interférences radioélectriques, il appartiendra alors à l'utilisateur de prendre les mesures spécifiques appropriées.

In accordance with European Union Directive 2002/96/EC of the European Parliament and of the Council of 27 January 2003, Lantronix will accept post usage returns of this product for proper disposal. The contact information for this activity can be found in the 'Contact Us' portion of this document.

**CAUTION:** RJ connectors are NOT INTENDED FOR CONNECTION TO THE PUBLIC TELEPHONE NETWORK. Failure to observe this caution could result in damage to the public telephone network.

Der Anschluss dieses Gerätes an ein öffentliches Telekommunikationsnetz in den EGMitgliedstaaten verstösst gegen die jeweiligen einzelstaatlichen Gesetze zur Anwendung der Richtlinie 91/263/EWG zur Angleichung der Rechtsvorschriften der Mitgliedstaaten über Telekommunikationsendeinrichtungen einschliesslich der gegenseitigen Anerkennung ihrer Konformität

## RoHS, WEEE, and Environmental Programs

See <https://www.lantronix.com/legal/rohs/>

## Product Registration

Registering your product will allow you to receive notifications for product recalls, software updates, documentation updates, product updates, and new launches. Registering your Lantronix products is not required for you to benefit from Lantronix' standard product warranty and Lantronix' outstanding Technical Support. Please register online at <https://www.lantronix.com/product-registration/>.

**Lantronix Corporate Headquarters**

48 Discovery, Suite 250  
Irvine, CA 92618, USA  
Toll Free: 800-526-8766  
Phone: 949-453-3990  
Fax: 949-453-3995

**Technical Support**

Online: <https://www.lantronix.com/technical-support/>

**Sales Offices**

For a current list of our domestic and international sales offices, go to the Lantronix web site at [www.lantronix.com/about/contact](http://www.lantronix.com/about/contact).