

AZM4 / AZM8 / AZMP4 / AZMP8

AZM4/8 Atmosphere™ Signal Processor AZMP4/8 Atmosphere™ Signal Processor and Amplifier



Features

- 4 (AZM4) & 8 (AZM8) Independently Controlled Zone Models
- Web UI – Works on Any Operating System and Any Web Browser Including: Windows, Mac, Android, iOS, Linux. Optimized for Use on Chrome and Safari.
- Plug and Play Intelligent Wall Plate Accessories
- Accessory Data + Audio Digital Bus – RJ45-Unshielded Cat 5e/6 Wire Runs up to 1000ft
- Daisy Chain up to 8 Accessories per Port - 2 Ports on AZM4, 4 Ports on AZM8
- Supports up to 16 Accessories per AZM
- Accessory Self-Heal
- Input Source Types: Mono, Stereo
- Output Zone Types: Mono, Mono+Sub, Stereo, Stereo+Sub
- Room combine
- Bell scheduler - Up to 10 unique ring lists with 50 bells each
- Event scheduler - Recall Scenes, Routines, Messages, GPO, Room Combine, Bells
- Message player - 1GB, 1GB of on-board storage
- Integrated .wav File Message Player
- GPIO - Recall Scenes, Routines, Messages, GPO, Room Combine, Bells
- Adaptive Ambient Noise Compensation
- Loud Noise Detection
- Input Auto-Gain Audio Control
- Virtual Wall Controllers for Mobile Devices, with QR Code Set-up - no App Required
- Tilter Filter™ Room EQ Adjustment Tool
- AtlasIED Speaker Presets
- Intuitive Calendar Format Event Scheduler
- Printable Dynamic System Diagram
- Third Party Control
- Simple, Streamlined Workflow for All Skill Levels

Applications

- Restaurant / Bars
- Corporate Centers
- Education
- Industrial
- Houses of Worship
- Hospitality Suites
- Offices

General Description

The AtlasIED Atmosphere AZM/AZMP platform was developed to meet the highest standards of design, quality, and value that our customers have come to expect from AtlasIED. We believe you will find this platform highly flexible to address a variety of applications while being refreshingly simple to deploy.

The AZM4 features a 8 input / 4 output configuration with 4 mic/line inputs, 2 RCA mono-summed inputs and 4 balanced output zones. In addition, 2 Atmosphere Accessory ports (non-IP, RJ45) each allow for 1 audio accessory (A-XLR, A-RCA, A-BT, or X-ZPS), bringing the total audio I/O count to 8 in by 4 out.

The AZM8 features a 14 input / 8 output configuration with 6 mic/line inputs, 4 RCA mono-summed inputs and 8 balanced zones. In addition, 4 Atmosphere Accessory ports (non-IP, RJ45) each allow for 1 audio accessory (A-XLR, A-RCA, A-BT, or X-ZPS), bringing the total audio I/O count to 14 in by 8 out.

Seven plug and play smart accessories expand the AZM/AZMP's capabilities and allow for future scalability. Accessories include three audio input accessories: balanced mic/line XLR (A-XLR), RCA with 3.5mm (A-RCA), and Bluetooth® (A-BT). Also available are two controllers: single zone volume control (C-V) and advanced multi-zone controller with volume control, source select, scene recall, message recall (C-ZSV), as well as an ambient noise sensor for automatic Ambient Noise Compensation and Loud Noise Detection (X-ANS). Any control accessory can be daisy chained onto a single cable run and assigned to any zone, reducing installation time and complexity.

The 4.3" touchscreen X-ZPS Paging Station, connected by one of the accessory ports (1 X-ZPS per accessory port), provides zone paging, all call, and custom group paging features combined with a high-quality, gooseneck microphone. The X-ZPS also serves as a system controller for volume, source selection, message recall, and more

In addition to the processor-only models, the line-up features powered versions of the processors that further reduce integration and commissioning time. With the ability to power-share between channels (channels 1-4 and channels 5-8) the AZMP series can scale to the size of the zone which results in efficient system design. All amp channels utilize a self test strategy that provides assurance that both the AZMP and connected loudspeakers are working as designed.

System				
Type	AZM4/8 - Signal Processor AZMP4/8 - Signal Processor and Amplifier			
Power Requirements/Consumption				
Main Requirements	100 - 240 VAC, 50 - 60 Hz (C14 Mains Inlet Connector)			
Consumption	AZMP4 Maximum = 310W (290W with no accessories) AZMP8 Maximum = 590W (550W with no accessories)			
Audio Inputs	AZM4	AZM8	AZMP4	AZM8
Mic / Line Inputs	4 (Euroblock)	6 (Euroblock)	4 (Euroblock)	6 (Euroblock)
RCA	2 (mono-summed)	4 (mono-summed)	2 (mono-summed)	4 (mono-summed)
Line Outputs	4 (Euroblock)	8 (Euroblock)	2 (Euroblock)	2 (Euroblock)
General Purpose Inputs	6 (Euroblock)	6 (Euroblock)	6 (Euroblock)	6 (Euroblock)
Amplified RJ45 Output Ports	0	0	2	4
Amplified Outputs	0	0	4	8
High Priority Inputs	1 (Euroblock)	1 (Euroblock)	1 (Euroblock)	1 (Euroblock)
General Purpose Outputs	2 (Euroblock)	2 (Euroblock)	2 (Euroblock)	2 (Euroblock)
Accessory Ports	2 (RJ45)	4 (RJ45)	2 (RJ45)	4 (RJ45)
Network Port	1 (RJ45)	1 (RJ45)	1 (RJ45)	1 (RJ45)
Balanced Mic / Line Inputs	Connector Type: 3.5mm Pitch Euroblock Color: Green Sensitivity: +4dBu with Gain Set to 0dB Input Gain: 0 - 60dB in 6dB Steps Phantom Power Voltage: +48VDC 10mA Accepts Unbalanced Inputs: Yes Maximum Input Level: +20dBu (7.72 Vrms) with Gain Set to 0dB Input Impedance: 3.9kΩ EIN: -125dBu with 150Ω Source Impedance and 20kHz BW CMRR: Typically 65dB at 1kHz Maximum Cable Size: 18AWG Minimum Cable Size: 24AWG			
RCA	Right Channel Color: Red Left Channel Color: White Type: Mono-summed Pairs Sensitivity: -10dBV Maximum Input: 2.4 Vrms (7.6dBV / 9.8dBu) for Both Inputs Driven and 4.78 Vrms (13.6dBV / 15.8dBu) for a Single Input			
Audio Outputs				
Balanced Line Outputs	Connector Type: 3.5mm Pitch Euroblock Color: Orange Maximum Output Level: +20dBu (7.75 Vrms) Maximum Cable Size: 18AWG Minimum Cable Size: 24AWG			
Audio Performance - Line Inputs				
THD+N	<0.01% at 0dBu Input / Output with 0dB Gain at 1kHz			
Frequency Response	±0.5dB 20Hz - 20kHz			
Dynamic Range (S/N)	>108dB Unweighted 20Hz - 20kHz, > 110dB "A" Weighted			
Crosstalk	>-78dB at 1kHz			
Latency	Euroblock Input or RCA Input to Euroblock Output: 4.9 ms Accessory Input A/C to Euroblock Output: 5.9 ms Accessory Input B/D to Euroblock Output: 6.7 ms			
Maximum Hardware Gain	60dB			
Audio Performance - Powered Outputs				
Signal to Noise Ratio	105dB			
THD Maximum (1W to 100W, 1KHZ)	0.02%			
THD Maximum (100W to 600W, 1KHZ)	0.20%			
Maximum Output Current	10A			
Maximum Output Voltage	100Vrms			
Protection	Short, Thermal, HF, and DC			
* = 3dB down at 20Hz (24dB BW HPF implemented) and +/-0.5dB up to 20kHz				

©2023 Atlas Sound L.P. The Atlas "Circle-A", Soundolier, and Atlas Sound are trademarks of Atlas Sound L.P. IED is a Registered Trademark of Innovative Electronic Designs LLC. All rights reserved. All other Trademarks are property of their respective owners. No endorsement is implied. Due to continual product development, specifications are subject to change without notice. ATSO07275 RevA 1/23

Input Processing					
EQ	-12dB/oct 8Hz Filter, PEQ, Low / High Shelf, Notch, LP / HP (BW 6, 12, 24, dB/oct)				
Dynamics	Gate, De-Esser, Compressor, Auto Gain				
Other	Gain, 4x Mixer (All Inputs)				
Output Processing					
EQ	PEQ, Tilter Filter, Low / High Shelf, Notch, Crossover LP / HP (BW 6, 12, 18, 24, and LR12, LR24), Speaker Tuning EQ Presets, Tone Control				
Dynamics	Ambient Noise Compensation, Noise Detection, Priority Router				
Frequency Response (8Ω)*	+/-0.5dB				
Crosstalk (1kHz)	-70dB				
Other	Delay (500 ms), Gain				
Masking	White or Pink Noise Source, Preset EQ Curves, 20 Band Perfect Fit GEQ (100Hz - 8kHz, Tilter Filter™, HPF (BW6, BW12), LPF (BW6, BW12), Enhanced Privacy Gain, (-12dB to +12dB), 7 Day Scheduler, Commissioning Ramp Scheduler (maximum of 30 days)				
Other Connections					
General Purpose Inputs	Contact Closure: Normally Open Capable of Internal Pull-up to 5VDC via User Interface Voltage Input: 0 - 12VDC (1.3VDC Trigger Voltage)				
High Priority Input	Contact Closure: Normally Open Capable of Internal Pull-up to 5VDC via User Interface Voltage Input: 0 - 12VDC (1.3VDC Trigger Voltage)				
General Purpose Outputs	Source Current: 10mA at 2VDC Maximum Sink Current: 180mA Maximum Sink Voltage: 24VDC				
Accessory Ports	Maximum Accessories per Port: 8 Maximum Accessories per AZM: 16 Maximum Bus Length: 1000ft Maximum Audio Wall Plates per Port: 1				
Ethernet	10/100Mbps				
Mechanical					
Airflow	Front to Back				
Operating Ambient Temperature Range	0° - 40°C				
Cooling System	Forced Air with Side and Back Panel Venting				
Energy Consumption		AZM4	AZM8	AZMP4	AZMP8
Max		130 BTU / Hr	256 BTU / Hr		
No Accessories		75 BTU / Hr	127 BTU / Hr		
Front Panel					
Screen	128 x 128 Color TFT Normally White, 1.45"				
Encoder	24 Detent, Push Button				
Light Bar	RGB (Blue = On, Red = Flashing Red)				
WiFi					
Type	802.11 b/g/n 2.4GHz				
Free Air Range	60ft				
Dimensions and Weight		AZM4	AZM8	AZMP4	AZMP8
Rack Mount Requirements		1 RU, 19"	2 RU, 19"		
Dimensions (with Rack Ears) - Unit		W 19" x H 1.75" x D 11.7" (483mm x 45mm x 297mm)	W 19" x H 1.7" x D 15.03" (382mm x 43mm x 432mm)	W 19" x H 3.45" x D 15.03" (382mm x 88mm x 432mm)	
Dimensions - Shipping		(W 13.5" x H 4.75" x D 14" (343mm x 121mm x 356mm)	W 22" x H 4.75" x D 14" (559mm x 121mm x 356mm)	W 23.25" x H 4.75" x D 19.75" (591mm x 121mm x 502mm)	W 23.25" x H 7" x D 19.75" (591mm x 178mm x 502mm)
Weight - Unit		4.735 lbs (2.148kg)	8.330 lbs (3.778kg)	13 lbs (5.9)	19.7 lbs (8.9kg)
Weight - Shipping		7.3 lbs (3.3kg)	18.45 lbs (8.4 kg)	18.45 lbs (8.45kg)	26.75 lbs (12.1kg)
Agency Approvals					
Safety	Conforms to: ANSI / UL 62368-1 Certified to: CAN / CSA C22.2 #6236				
FCC / ISED	Part 15 (Class B) (US), ICES-003 (Canada)				

Optional Accessories	
C-V / C-V-EU	Control Type: 24 Detents 360° Continuous Push Button Encoder Light Ring: RGB (Mute, Signal, Locate) Dimensions: 1.78" x 4.2" x 1.9" C-V Minimum Box Depth: 2.25"; C-V-EU Minimum Box Depth: 45mm EU Accessory includes optional box spacer plate. Minimum back box depth using included spacer = 30mm.
C-ZSV / C-ZSV-EU	Control Type: 24 Detents 360° Continuous Push Button Encoder Light Ring: RGB (Mute, Signal, Locate) Screen: 128 x 128 Color TFT C-ZSV Dimensions: 1.78" x 4.2" x 1.9"; C-ZSV-EU Dimensions: 3.46" x 4.49" x 1.86" C-ZSV Minimum Box Depth: 2.25"; C-ZSV-EU Minimum Box Depth: 45mm EU Accessory includes optional box spacer plate. Minimum back box depth using included spacer = 30mm.
A-RCA / A-RCA-EU	Right Channel Color: Red Left Channel Color: White Sensitivity: -10dBV (Same as AZM) Maximum Input Voltage: +8dBu Output Type: Mono Indicator: Green = Signal Presence, Red = Clip, Blue = Locate Dimensions: 1.78" x 4.2" x 1.5" A-RCA Minimum Box Depth: 2.25"; A-RCA-EU Minimum Box Depth: 45mm EU Accessory includes optional box spacer plate. Minimum back box depth using included spacer = 30mm.
A-XLR / A-XLR-EU	Sensitivity: +4dBu (Same as AZM Balanced Inputs) Connector Type: XLR (Female) Retaining Clip: Yes Phantom Power Voltage: +48VDC 10mA Accepts Unbalanced Inputs: Yes Input Gain: 0 - 60dB Maximum Voltage Input: +20dBu Input Impedance: 3.4kΩ EIN: 117dBu at 150Ω, 20kHz BW CMRR: Typically 50dB at 1kHz Indicator: Green = Signal Presence, Red = Clip, Blue = Locate A-XLR Dimensions: 1.79" x 4.20" x 2.1"; A-XLR-EU Dimensions: 3.46" x 4.49" x 2.1" A-XLR Minimum Box Depth: 3"; A-XLR-EU Minimum Box Depth: 55mm EU Accessory includes optional box spacer plate. Minimum back box depth using included spacer = 40mm.
A-BT / A-BT-EU	BT Standard: V4.2 Audio Profile: A2DP Open Air Range: 60ft Output Type: Mono NFC: Tap-to-Pair Indicator: Green = Paired, Red = Error, Blue = Pairing Mode Button: Pairs and Unpairs Devices Dimensions: 1.78" x 4.2" x 1.4" A-BT Minimum Box Depth: 2.25"; A-BT-EU Minimum Box Depth: 45mm EU Accessory includes optional box spacer plate. Minimum back box depth using included spacer = 30mm.
X-ANS / X-ANS-EU	Data Returned to AZM: Non-audio Calibration: RMS, A-weighted, SPL Range: 30 - 110dB SPL Indicator: Blue = Locate Dimensions: 1.78" x 4.2" x 1.4" X-ANS Minimum Box Depth: 2.25"; X-ANS-EU Minimum Box Depth: 45mm EU Accessory includes optional box spacer plate. Minimum back box depth using included spacer = 30mm.
X-ZPS	Screen Type: 4.3" TFT capacitive touch Mic Connector: Neutrik brand female XLR Mic Input Sensitivity: +4dBu XLR Retaining Clip: Yes Phantom Power: +48VDC 10mA Input Gain Range: 0 - 60dB Maximum Voltage Input: +20dBu Input Impedance: 3.4kΩ EIN: 117dBu at 150Ω, 20kHz BW CMRR: Typically 50dB at 1kHz Included Mic Polar Pattern: Cardioid SPL Maximum: 120dB Frequency Response: 70Hz - 16kHz Dynamic Range: >90 dB Light Ring: RGB Dimensions: 3.33" x 3.78" x 8.53" Housing Type: Cast aluminum Mounting: Table top or snap in plate

©2023 Atlas Sound L.P. The Atlas "Circle-A", Soundolier, and Atlas Sound are trademarks of Atlas Sound L.P. IED is a Registered Trademark of Innovative Electronic Designs LLC. All rights reserved. All other Trademarks are property of their respective owners. No endorsement is implied. Due to continual product development, specifications are subject to change without notice. ATIS007275 RevA 1/23

AZMP4 and AZMP8 Amplified Output Specs

The AZMP4 and AZMP8 both utilize ground-up, internally developed amplifier power sharing technology that allows for efficient use of available power and avoiding system overdesign due to traditional amplifier power ratings. The technology works in banks of 4 channels and has the ability to shift all available power supply power to a single channel or programmatically divide the available power supply power in any proportion to all channels. The technology does not simply rely on correct complex load calculations to divide power up but actively shapes the power to mimic the desired amplifier size per channel. Additionally, each output has the ability to independently operate in either HI-Z mode (25V, 48V, 70V, and 100V) or LOW-Z mode (4Ω or 8Ω). This methodology allows the amplifier to match the system design rather than the system design matching a convenient amp selection.

Output Options

Each amp channel can be assigned to traditional Euroblock connectors (5mm pitch) and/or an RJ45 connector that can be used with the SHS mini product line. When the RJ45 connector is utilized, the current is automatically limited to 1 Amp to protect the attached cable.

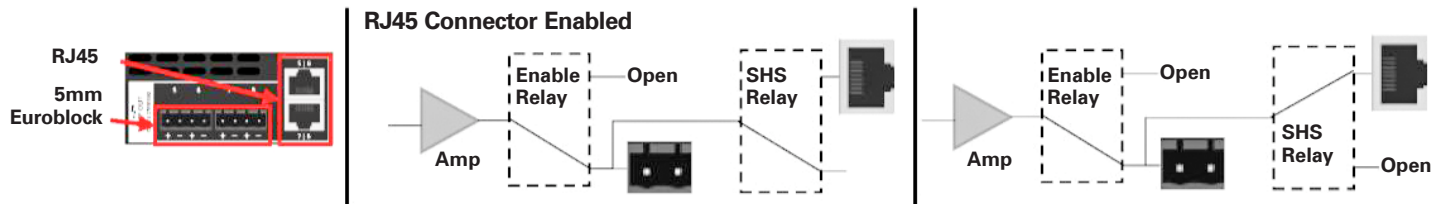

Self Test

Every AZMP has the ability to run an automated self diagnostic test that can highlight potential internal system issues (fan operation, relays, live faults, thermal issues, and power supply) and external system failures (loudspeaker failures based on changes in impedance and line voltage issues). A convenient scheduler feature allows the self diagnostic test to be defined and run on a regular basis. If any of the tests return a failed result the AZMP (internet connection required) can send an email notification to the party responsible for system maintenance.

Power Sharing

The total power available for each bank of four channels is 615W. This can be split in 5W increments between all four channels (maximum power allowed to send to a single channel is 600W).

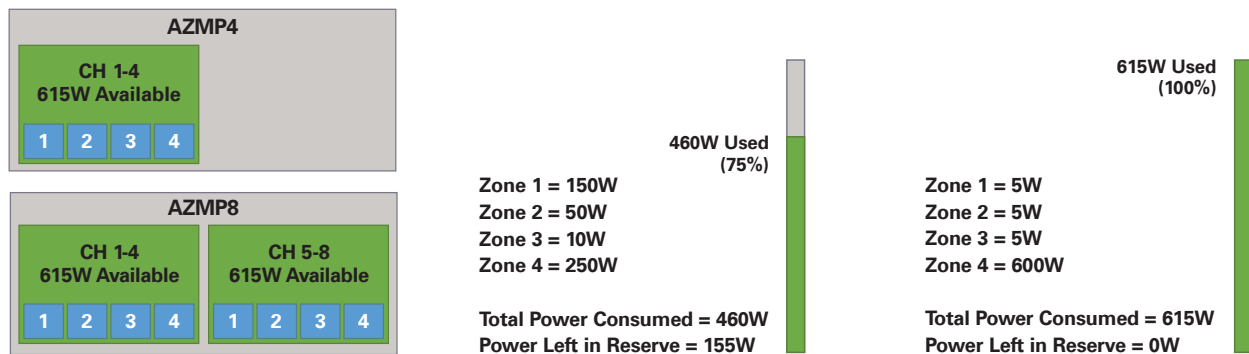

Amplifier Power Specs

Due to the extreme flexibility of the amplifier the below specification chart is limited to the maximum single channel driven and a balanced (150W/CH) all channels drive scenarios.

Single Channel Driven

Time	4Ω	8Ω	25V	48V	70V	100V
CAF Max Power*	400	600	250	480	600	600
Continuous	33	65	65	65	100	100
Masking**	17	32	32	32	50	50

SHS Output

Time	4Ω	8Ω	25V	48V	70V	100V
CAF Max Power*	5	10	25	50	70	100
Continuous	5	10	25	50	70	100
Masking**	5	10	25	32	32	50

All Channels Evenly Driven (150W)

Time	4Ω	8Ω	25V	48V	70V	100V
CAF Max Power*	150	150	150	150	150	150
Continuous	33	65	65	65	65	65
Masking**	17	32	32	32	32	32

* = 15s continuous at 1kHz and rated THD%

** = Recommended maximum power when used in masking applications

Dimensional Drawings

AZM4

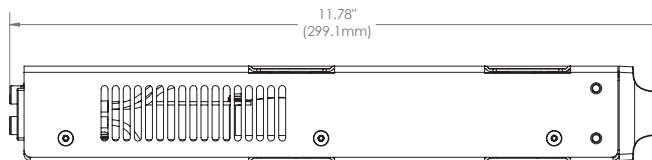
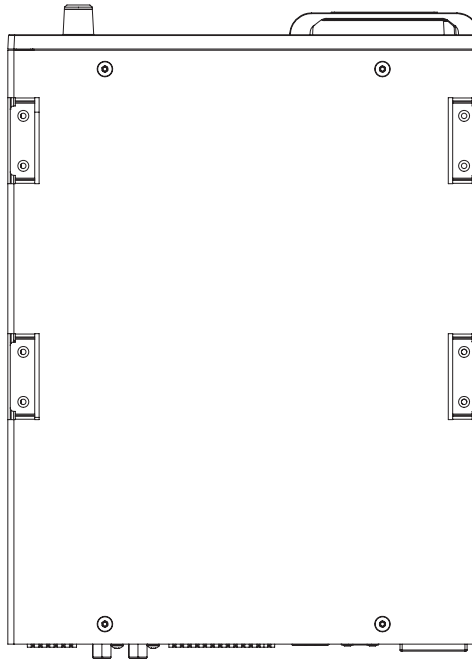
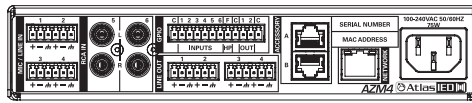
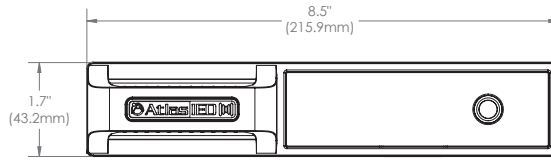

Dimensional Drawings

AZM8

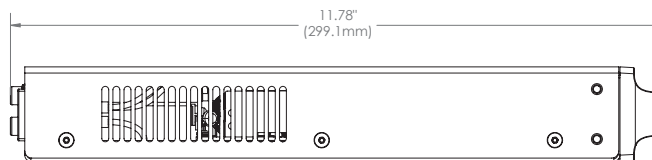
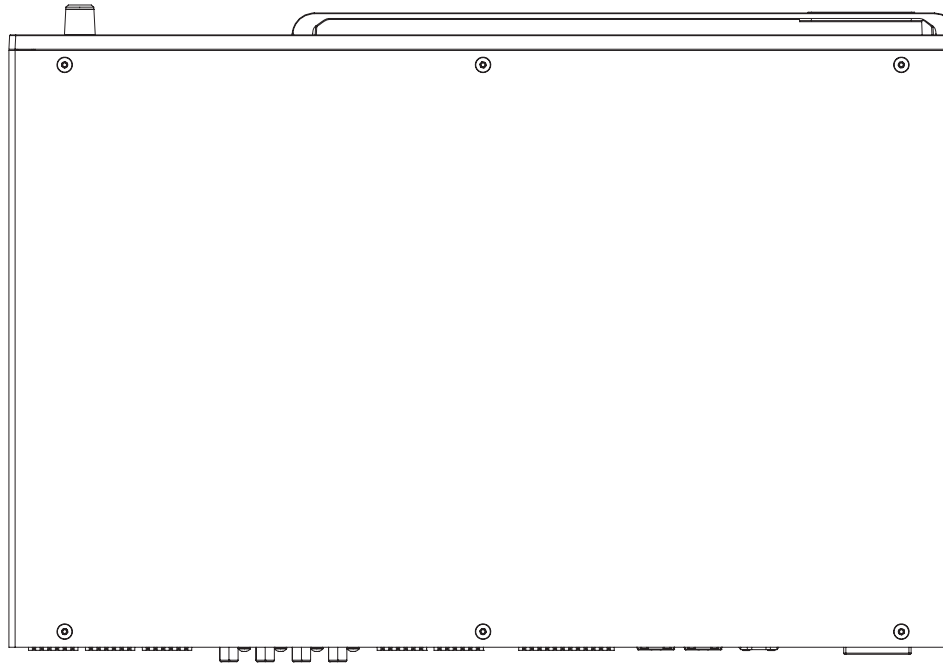
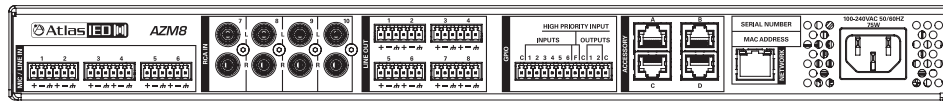
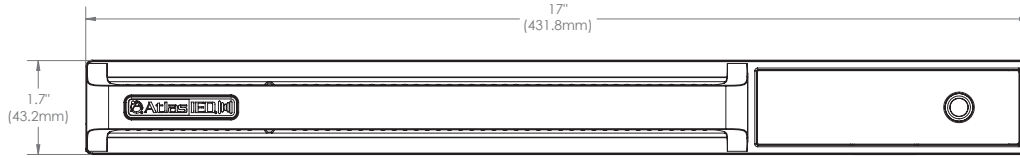

Dimensional Drawings

AZMP4

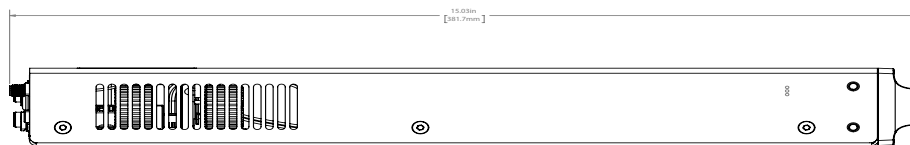
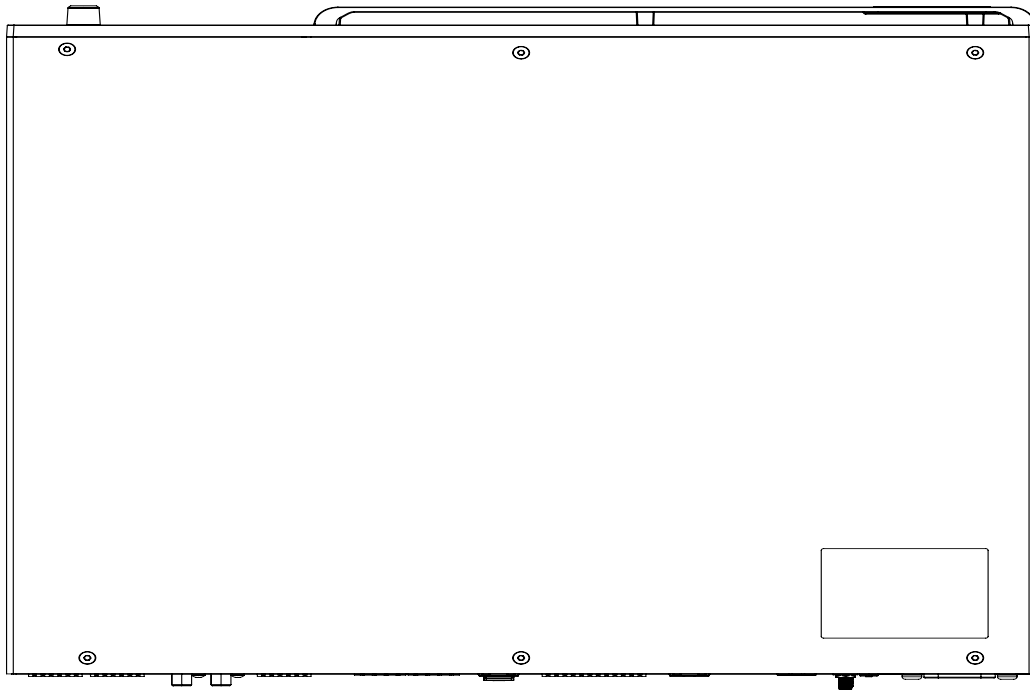
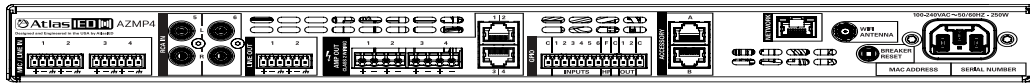
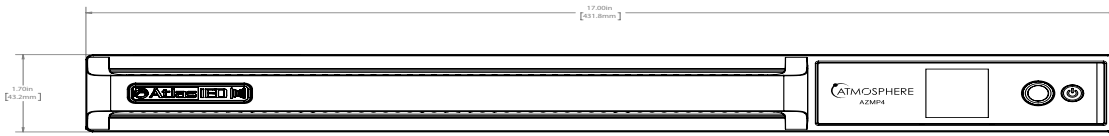

Dimensional Drawings

AZMP8

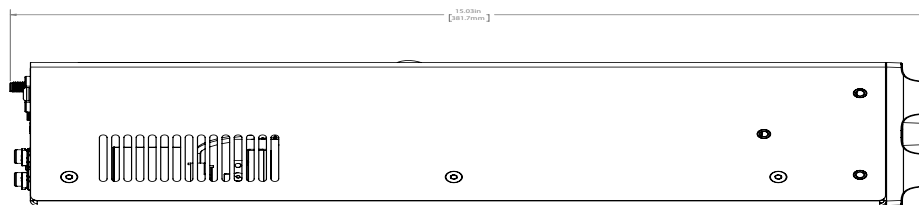
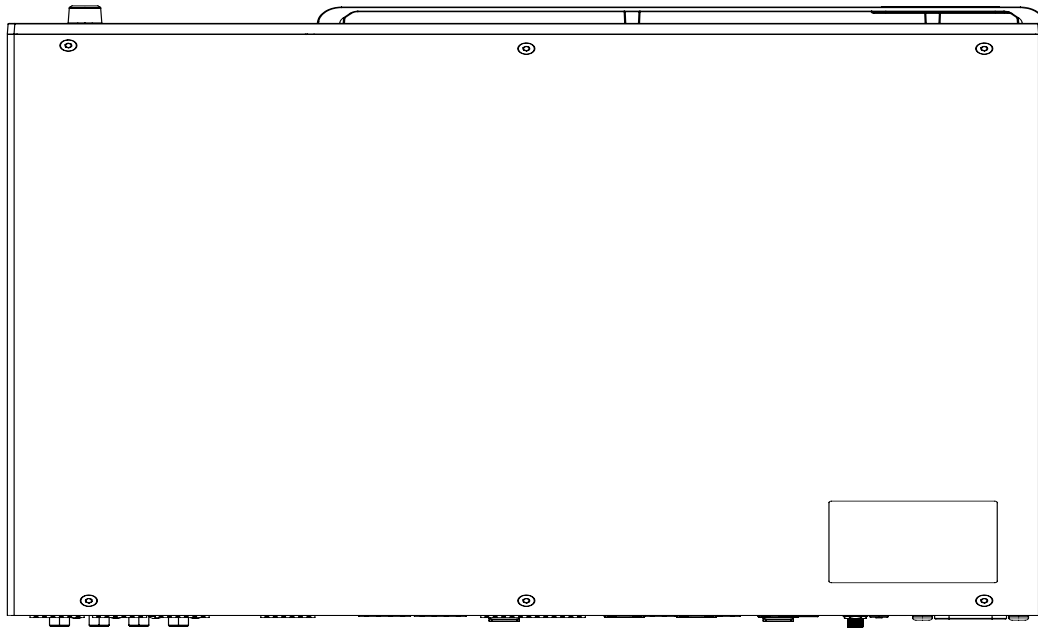
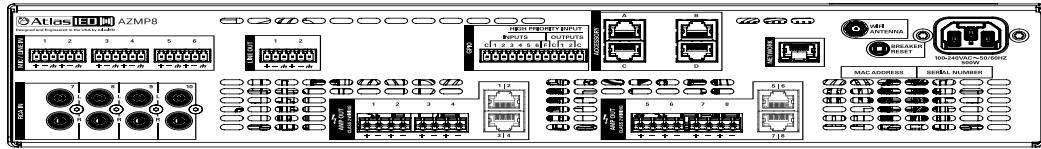
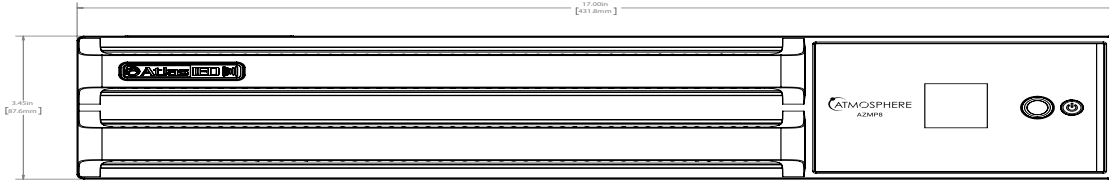

Dimensional Drawings

C-V, C-ZSV, A-RCA, A-BT, and X-ANS share the same dimensions

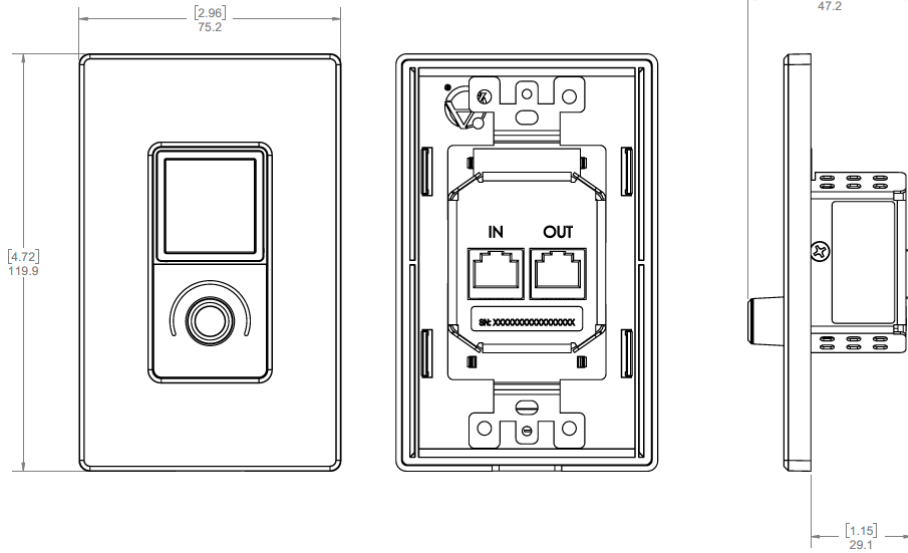

A-XLR

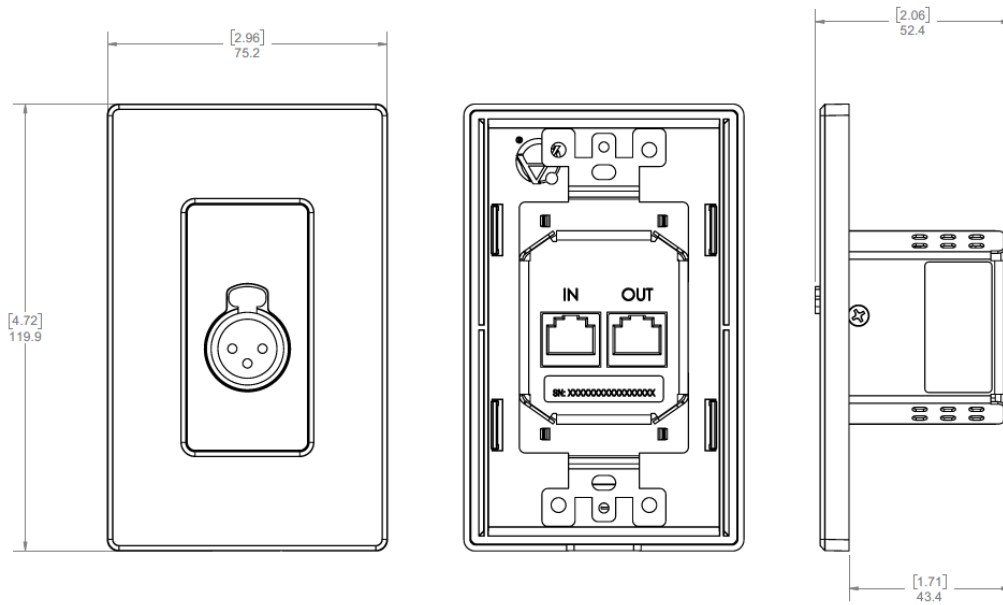

Dimensional Drawings

C-V-EU, C-ZSV-EU, A-RCA-EU, A-BT-EU, and X-ANS-EU share the same dimensions

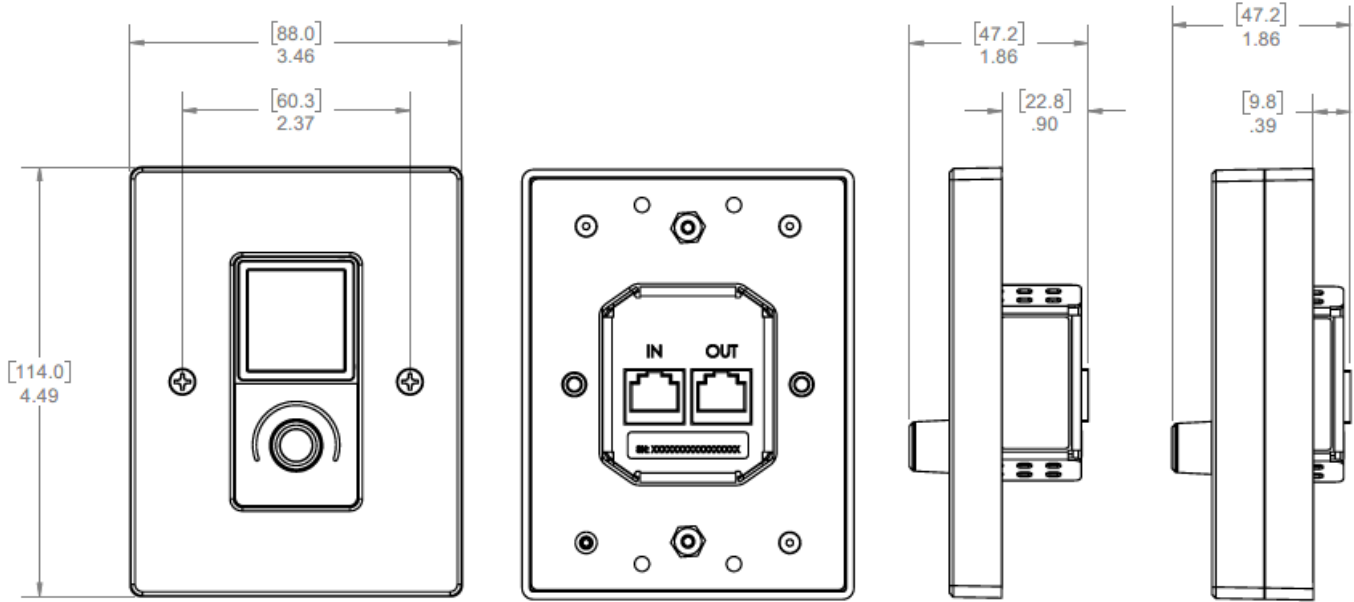

A-XLR-EU

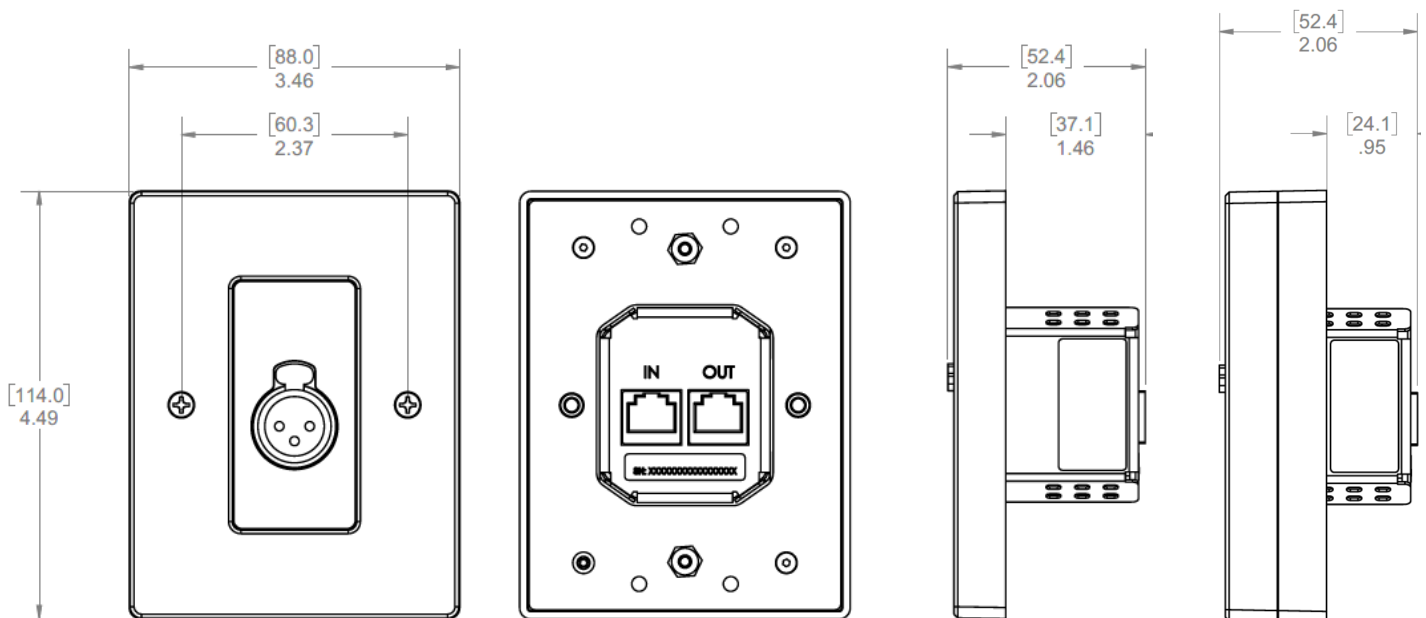

Dimensional Drawings

X-ZPS

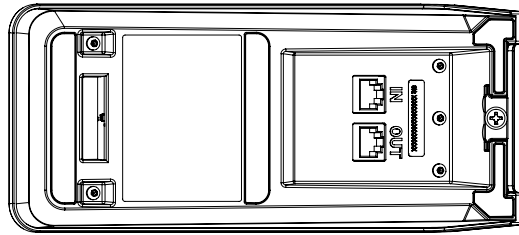
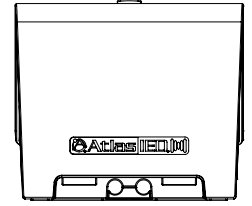
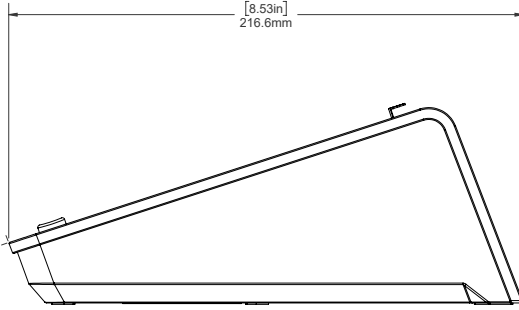
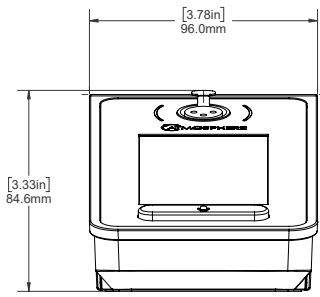

X-ZPS with desk mount installed

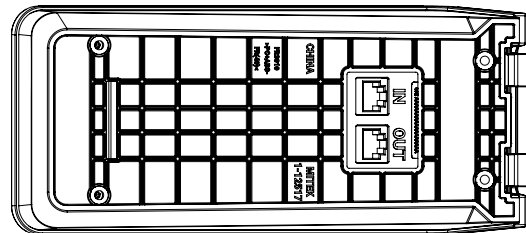
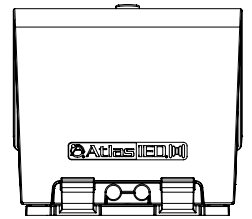
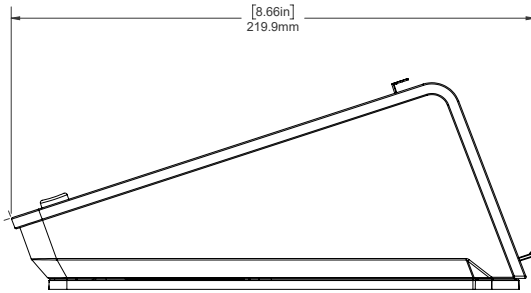
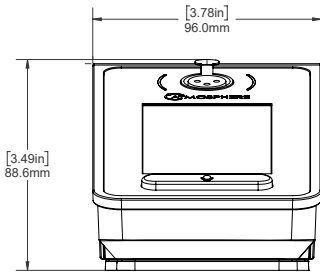

©2023 Atlas Sound L.P. The Atlas "Circle A", Soundolier, and Atlas Sound are trademarks of Atlas Sound L.P. IED is a Registered Trademark of Innovative Electronic Designs LLC. All rights reserved. All other Trademarks are property of their respective owners. No endorsement is implied. Due to continual product development, specifications are subject to change without notice. ATIS007275 RevA 1/23

Dimensional Drawings

X-ZPS with 16" gooseneck mic installed

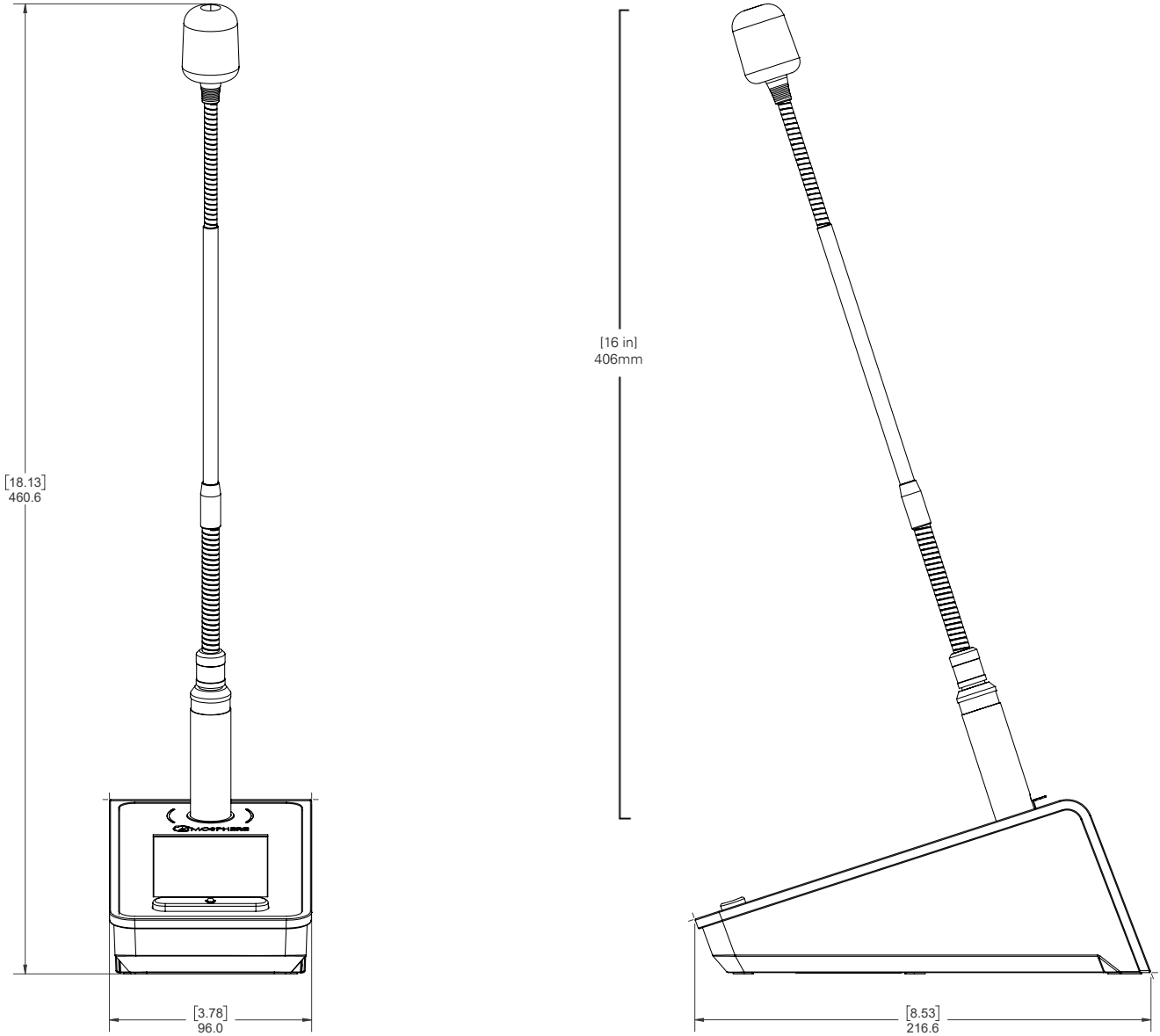

Architect and Engineer Specifications

AtlasIED Atmosphere™ AZM4 – V3.0

The audio zone processor shall be a six input by four output configuration networked device suitable for digitally selecting, combining, mixing, routing, and processing audio signals from up to eight analog sources with optional accessories. It shall send these mixed, routed, and processed signals to as many as four monaural balanced line-level outputs, from which the signals would typically be amplified and played over loudspeakers in respective zones of a business or other venue.

The front panel shall have a dynamic bar-graph or clock display showing the assigned IP address and each of the Zone output levels (default). A Menu Navigation encoder control knob shall be available to configure and interrogate settings and faults directly. It shall also be used to perform a Factory Reset. The far-right side of the front panel shall have a Status LED bar that lights Solid Blue when in normal operation and Flashes Red when a Fault is detected.

The rear panel shall have four 3-way 3.5mm Euroblock balanced mic or line level inputs and two RCA stereo summed inputs. The four Line level outputs shall have four 3-way 3.5mm Euroblocks. The rear panel shall also have six General Purpose Inputs, one High Priority input, two outputs, and 3 common ports on a 12-position Euroblock. GPI ports shall be configurable in settings for contact closure (NO) or 0-12VDC with 1.3VDC minimum trigger voltage. GPO ports shall have source current of 10ma at 2VDC, maximum sink current of 180ma, and maximum sink voltage of 24VDC.

The audio zone processor shall provide a web browser-based intuitive GUI (Graphic User Interface) for configuring sources, zones, and easy setup of processor controls and DSP settings. The GUI shall be accessible by network over a wired LAN, WiFi, or set as a Hot-Spot, with configurable security levels. The GUI shall have an overview dashboard for monitoring with quick links to settings pages for adjusting functions in real time. GUI individual setup page categories shall include: Dashboard, Sources, Zones, Messages, GPIO, Scenes, Routines, Accessories, Scheduler, Diagrams, and Settings.

Sources shall have an ADD SOURCE selection that allows user to Name and configure source type, Mono or Stereo, and select an available Input port or Lt-Rt-ports, and a Color for visual reference. Input ports shall include: Mic-Line, RCA, and Audio Accessories on A and B port.

Each of the Balanced Mic/Line Sources shall have an editable Name window, dynamic bar-graph-display with fader and simulated LED “active” indicators for Gate, De Ess, and Comp, an input Mute, and a Link to open the input respective DSP GUI pages. The GUI shall have pages for GENERAL Settings that include: Preamp Gain of 0-60dB with +4dB sensitivity = 0dB; +48V Phantom; 12dB/Oct HPF, and additional DSP settings pages for Gate, De-Esser, Compressor, Equalizer (4-Band), and Auto-Gain. The page shall have a link to the source setup page.

Each of the -10dBV-RCA stereo summed Sources shall have an editable Name window, dynamic bar-graph-display, fader, an input mute, and a Link to the input respective GUI page for GENERAL Settings (Input Gain), and DSP settings (Same as Mic/Line). Two physical inputs (Mic-Line, RCA, or wall plate) shall be required to configure Stereo to Zones.

The Sources section shall provide GUI pages for Audio Wall Plate sources which will become Active when an Audio Wall Plate is terminated to the respective A or B RJ45 buss port. Once assigned to a Source, General Settings and DSP settings pages shall identify the type of audio Wall Plate and display the appropriate DSP.

The Sources section shall also provide four “Mixes” inputs each allowing a selection of any ten inputs to be combined into a sub-mix to provide a single audio fader adjustment for the group. Each of the four “Mixes” can be named and appear in the source list for selection by a zone output.

In addition, the Sources section shall include a signal oscillator configurable as Freq selectable-Sine wave, white noise, or pink noise. Controls shall be Enable (ON/OFF), Output Level, and shall be available in the source list at all outputs for assignment to zones.

Each of the Zones shall have an editable Name window, Input Source select, dynamic bar-graph-display with fader and simulated LED “active” indicators for Limiter, Mute, and a Link to the input respective DSP pages. The GUI shall have pages for GENERAL Settings that include Input Priority setup; AtlasIED Speaker Preset select; output Delay adjust; and DSP settings pages for Priority, Crossover, Equalizer, ANC (Ambient Noise Compensation), Noise Detection, and Limiter. The page shall have a link to the source setup page.

Up to 25 mobile devices shall be capable of being used as virtual zone controllers by scanning a QR code with an on-network device. The accessories settings page shall provide access to settings of connected accessories, graphic depiction of connected accessories and their order, the ability to rename accessories, a trigger for the locate function on the accessories, the ability to enable or disable the self-heal function, a link to adding placeholder devices, a QR code preview for devices that are capable, and a link to the front panel configuration page. After configuring, a QR Code shall display in the GUI and can also be printed. A wall-mount frame for printed QR code shall be included.

The audio processor shall have the ability to combine zones to create a zone group (Room Combine) that is controllable from all assigned wall controllers and virtual wall controllers. Groups created shall be able to include one to four zones. Zones within the group shall have an assigned zone level offset of -20dB to +20dB.

The audio processor shall have an onboard bell scheduler. The bell scheduler shall have the ability to hold up to ten ring lists with each containing up to fifty ring events. Each ring event shall have opt-in capability for each zone and group that has been created within the system. Each ring event shall allow the selection of a separate audio file to be played, recall of a routine, recall of a scene, recall of a GPO preset, combine a room, or uncombine room. The bell scheduler shall be able to accommodate multi-week bell schedule patterns as well as exception days.

Each created zone shall have a link to a masking control page when opted in under the Add Zone setup page. The page shall include an enable toggle control, toggle control for pink and white noise, a masking gain slider control, a Tilter Filter™ slider control, a low pass enable control, and a low pass enable control. There shall be a method to reduce or increase the masking gain by up to 12dB. A 20 band GEQ with a single slider control per band shall be available to shape the noise source. There shall be a link to a 7-day scheduler that allows for the masking system to be turned off/on via a ramp process for opted in days. The scheduler day shall also provide settings to commission a system by ramping the target gain up over a timeframe of up to 30 days and set a start date/time to begin the commissioning process.

In addition, the audio zone processor shall have six Plug and Play smart Wall Plate optional accessories and a touchscreen paging station to expand the capabilities and allow for scalability. Two RJ45 digital bus ports shall be available on the rear panel to terminate accessories using up to 1000’ of Cat5e/6 non-shielded cable. One Audio Wall Plate is allowed per port and any control accessory shall be capable of daisy chaining on a single cable digital bus and assigned to any zone. A maximum of sixteen total accessories shall be possible with a reduced number when the touch screen paging station is used. Accessories shall include 3 x Audio Inputs; balanced Mic / Line XLR, dual RCA stereo summed with 3.5mm, and mono summed or stereo Bluetooth® audio wall plate inputs;

Architect and Engineer Specifications

AtlasIED Atmosphere™ AZM4 – V3.0 (continued)

2 x Controllers; Volume Controls, Volume Controls with Source Select, Scene Recall, GPO Trigger, Routine Recall, Daily Bell Schedule Selection, 1 x Ambient Noise Sensor for Zone Ambient Noise Compensation control, and a touch screen, table-mount paging mic station. The X-ZPS Paging Station accessory, connected by one of the accessory ports (1 X-ZPS per accessory port), shall provide all call, preset groups, zone control, action recall that includes; routine recall, scene recall, GPO preset recall, message recall, bell schedule change, preset groups, and other features combined with a high-quality, gooseneck microphone.

The audio multi-zone mixer shall be a 1RU-1.75"H x ½ rack wide (8.5") x 11.7" deep chassis with rack ears, hardware, and 1RU-19" full rack width adapter included. AC mains shall be 100-240 VAC, 50-60Hz - C14 Mains Inlet Connector; Max Energy Consumption (with Accessories) =130 BTU/hour; Frequency response shall be: +/-5dB 20Hz-20kHz > 110dB "A" weighted; S/N >108dB unweighted, >110dB "A" weighted. Max Bal-Line Output Level = +20dBu (7.75Vrms).

The audio zone processor shall be an AtlasIED Atmosphere™ AZM4.

Architect and Engineer Specifications

AtlasIED Atmosphere™ AZM8 – V3.0

The audio zone processor shall be a ten input by eight output configuration networked device suitable for digitally selecting, combining, mixing, routing, and processing audio signals from up to ten analog sources with optional accessories. It shall send these mixed, routed, and processed signals to as many as eight monaural balanced line-level outputs, from which the signals would typically be amplified and played over loudspeakers in respective zones of a business or other venue.

The front panel shall have a dynamic bar-graph or clock display showing the assigned IP address and each of the Zone output levels (default). A Menu Navigation encoder control knob shall be available to configure and interrogate settings and faults directly. It shall also be used to perform a Factory Reset. The far-right side of the front panel shall have a Status LED bar that lights Solid Blue when in normal operation and Flashes Red when a Fault is detected.

The rear panel shall have six 3-way 3.5mm Euroblock balanced mic or line level inputs and four RCA stereo summed inputs. The eight Line level outputs shall have eight 3-way 3.5mm Euroblocks. The rear panel shall also have six General Purpose Inputs, one High Priority input, two outputs, and 3 common ports on a 12-position Euroblock. GPI ports shall be configurable in settings for contact closure (NO) or 0-12VDC with 1.3VDC minimum trigger voltage. GPO ports shall have source current of 10ma at 2VDC, maximum sink current of 180ma, and maximum sink voltage of 24VDC.

The audio zone processor shall provide a web browser-based intuitive GUI (Graphic User Interface) for configuring sources, zones, and easy setup of processor controls and DSP settings. The GUI shall be accessible by network over a wired LAN, WiFi, or set as a Hot-Spot, with configurable security levels. The GUI shall have an overview dashboard for monitoring with quick links to settings pages for adjusting functions in real time. GUI individual setup page categories shall include: Dashboard, Sources, Zones, Messages, GPIO, Scenes, Routines, Accessories, Scheduler, Diagrams, and Settings.

Sources shall have an ADD SOURCE selection that allows user to Name and configure source type, Mono or Stereo, and select an available Input port or Lt-Rt-ports, and a Color for visual reference. Input ports shall include: Mic-Line, RCA, and Audio Accessories on A, B, C, or D ports.

Each of the Balanced Mic/Line Sources shall have an editable Name window, dynamic bar-graph-display with fader and simulated LED “active” indicators for Gate, De Ess, and Comp, an input Mute, and a Link to open the input respective DSP GUI pages. The GUI shall have pages for GENERAL Settings that include: Preamp Gain of 0-60dB with +4dB sensitivity = 0dB; +48V Phantom; 12dB/Oct HPF, and additional DSP settings pages for Gate, De-Esser, Compressor, Equalizer (4-Band), and Auto-Gain. The page shall have a link to the source setup page.

Each of the -10dBV-RCA stereo summed Sources shall have an editable Name window, dynamic bar-graph-display, fader, an input Mute, and a Link to the input respective GUI page for GENERAL Settings (Input Gain), and DSP settings (Same as Mic/Line). Two physical inputs (Mic-Line, RCA, or wall plate) shall be required to configure Stereo to Zones.

The Sources section shall provide GUI pages for Audio Wall Plate sources which will become Active when an Audio Wall Plate is terminated to the respective A, B, C, or D RJ45 buss port. Once assigned to a Source, General Settings and DSP settings pages shall identify the type of audio Wall Plate and display the appropriate DSP.

The Sources section shall also provide four “Mixes” inputs each allowing a selection of any fourteen inputs to be combined into a sub-mix to provide a single audio fader adjustment for the group. Each of the four “Mixes” can be named and appear in the source list for selection by a zone output.

In addition, the Sources section shall include a signal oscillator configurable as Freq selectable-Sine wave, white noise, or pink noise. Controls shall be Enable (ON/OFF), Output Level, and shall be available in the source list at all outputs for assignment to zones.

Each of the Zones shall have an editable Name window, Input Source select, dynamic bar-graph-display with fader and simulated LED “active” indicators for Limiter and Priority, Mute, and a Link to the input respective DSP pages. The GUI shall have pages for GENERAL Settings that include Input Priority setup; AtlasIED Speaker Preset select; output Delay adjust; and DSP settings pages for Priority, Crossover, Equalizer, ANC (Ambient Noise Compensation), Noise Detection, and Limiter. The page shall have a link to the source setup page.

Up to 25 mobile devices shall be capable of being used as virtual zone controllers by scanning a QR code with an on-network device. The accessories settings page shall provide access to settings of connected accessories, graphic depiction of connected accessories and their order, the ability to rename accessories, a trigger for the locate function on the accessories, the ability to enable or disable the self-heal function, a link to adding placeholder devices, a QR code preview for devices that are capable, and a link to the front panel configuration page. After configuring screen capable accessories, a QR Code shall display in the GUI and can also be printed. A wall-mount frame for printed QR code shall be included.

The audio processor shall have the ability to combine zones to create a zone group (Room Combine) that is controllable from all assigned wall controllers and virtual wall controllers. Groups created shall be able to include one to four zones. Zones within the group shall have an assigned zone level offset of -20dB to +20dB.

The audio processor shall have an onboard bell scheduler. The bell scheduler shall have the ability to hold up to ten ring lists with each containing up to fifty ring events. Each ring event shall have opt-in capability for each zone and group that has been created within the system. Each ring event shall allow the selection of a separate audio file to be played, recall of a routine, recall of a scene, recall of a GPO preset, combine a room, or uncombine a room. The bell scheduler shall be able to accommodate multi-week bell schedule patterns as well as exception days.

Each created zone shall have a link to a masking control page when opted in under the Add Zone setup page. The page shall include an enable toggle control, toggle control for pink and white noise, a masking gain slider control, a Tilter Filter™ slider control, a low pass enable control, and a low pass enable control. There shall be a method to reduce or increase the masking gain by up to 12dB. A 20 band GEQ with a single slider control per band shall be available to shape the noise source. There shall be a link to a 7-day scheduler that allows for the masking system to be turned off/on via a ramp process for opted in days. The scheduler day shall also provide settings to commission a system by ramping the target gain up over a timeframe of up to 30 days and set a start date/time to begin the commissioning process.

In addition, the audio zone processor shall have six Plug and Play smart Wall Plate optional accessories and a touch screen paging station to expand the capabilities and allow for scalability. Four RJ45 digital bus ports shall be available on the rear panel to terminate accessories using up to 1000’ of Cat5e/6 non-shielded cable. One Audio Wall Plate is allowed per port and any control accessory shall be capable of daisy chaining on a single cable digital bus and assigned to any zone. A maximum of sixteen total accessories shall be possible with a reduced number when the touch screen paging station is used. Accessories shall include 3 x Audio Inputs; balanced Mic / Line XLR, dual RCA stereo summed with 3.5mm, and mono summed or stereo Bluetooth® audio wall plate inputs;

Architect and Engineer Specifications

AtlasIED Atmosphere™ AZM8 – V3.0 (continued)

2 x Controllers; Volume Controls, Volume Controls with Source Select, Scene Recall, GPO Trigger, Routine Recall, Daily Bell Schedule Selection, 1 x Ambient Noise Sensor for Zone Ambient Noise Compensation control, and a touch screen table-mount paging mic station. The X-ZPS Paging Station accessory, connected by one of the accessory ports (1 X-ZPS per accessory port), shall provide all call, creation of dynamic paging groups, zone control, action recall that includes; routine recall, scene recall, GPO preset recall, message recall, bell schedule change, preset groups, and other features combined with a high-quality, gooseneck microphone.

The audio multi-zone mixer shall be a 1RU-1.75" H x 19"W x 11.7" deep chassis with rack ears hardware included. AC mains shall be 100-240 VAC, 50-60Hz - C14 Mains Inlet Connector; Max Energy Consumption (with Accessories) =256 BTU/hour; Frequency response shall be: +/-5dB 20Hz-20kHz > 110dB "A" weighted; S/N >108dB unweighted, >110dB "A" weighted. Max Bal-Line Output Level = +20dBu (7.75Vrms).

The audio zone processor shall be an AtlasIED Atmosphere™ AZM8

Architect and Engineer Specifications

AtlasIED Atmosphere™ AZMP4 – V3.0

The audio zone system shall be a six input by four output configuration networked device suitable for digitally selecting, combining, mixing, routing, and processing audio signals from up to six analog sources with optional accessories. It shall send these four mixed, routed, and processed signals to any combination of the available four amplified or two monaural line outputs from which the signals would typically be played over loudspeakers in respective zones of a business or other venue.

The front panel shall have a dynamic bar-graph or clock display showing the assigned IP address and each of the Zone output levels (default). A Menu Navigation encoder control knob shall be available to configure and interrogate settings and faults directly. It shall also be used to perform a Factory Reset. The far-right side of the front panel shall have a Status LED bar that lights Solid Blue when in normal operation and Flashes Red when a Fault is detected.

The rear panel shall have four 3-way 3.5mm Euroblock balanced mic or line level inputs and two RCA stereo summed inputs. The four amplified outputs shall have two 4-way 5mm Euroblocks and the two line outputs shall utilize a single 6-way 3.5mm Euroblock connector. The amplified outputs shall be routed to RJ45 connectors and enabled via the web UI. Each channel pair shall (1-2, 3-4) be routed to a single RJ45 connector.

The rear panel shall also have six General Purpose Inputs, one High Priority input, two outputs, and 3 common ground ports on a 12-position Euroblock. GPI ports shall be configurable in settings for contact closure (NO) or 0-12VDC with 1.3VDC minimum trigger voltage. GPO ports shall have source current of 10ma at 2VDC, maximum sink current of 180ma, and maximum sink voltage of 24VDC.

The audio zone processor shall provide a web browser-based intuitive GUI (Graphic User Interface) for configuring sources, zones, and easy setup of processor controls and DSP settings. The GUI shall be accessible by network over a wired LAN, WiFi, or set as a Hot-Spot, with configurable security levels. The GUI shall have an overview dashboard for monitoring with quick links to settings pages for adjusting functions in real time. GUI individual setup page categories shall include: Dashboard, Sources, Zones, Messages, GPIO, Scenes, Routines, Accessories, Scheduler, Diagrams, and Settings.

Sources shall have an ADD SOURCE selection that allows user to Name and configure source type, Mono or Stereo, and select an available Input port or Lt-Rt-ports, and a Color for visual reference. Input ports shall include: Mic-Line, RCA, and Audio Accessories on A and B port.

Each of the Balanced Mic/Line Sources shall have an editable Name window, dynamic bar-graph-display with fader and simulated LED “active” indicators for Gate, De Ess, and Comp, an input Mute, and a Link to open the input respective DSP GUI pages. The GUI shall have pages for GENERAL Settings that include: Preamp Gain of 0-60dB with +4dB sensitivity = 0dB; +48V Phantom; 12dB/Oct HPF, and additional DSP settings pages for Gate, De-Esser, Compressor, Equalizer (4-Band), and Auto-Gain. The page shall have a link to the source setup page.

Each of the -10dBV-RCA stereo summed Sources shall have an editable Name window, dynamic bar-graph-display, fader, an input mute, and a Link to the input respective GUI page for GENERAL Settings (Input Gain), and DSP settings (Same as Mic/Line). Two physical inputs (Mic-Line, RCA, or wall plate) shall be required to configure Stereo to Zones.

The Sources section shall provide GUI pages for Audio Wall Plate sources which will become Active when an Audio Wall Plate is terminated to the respective A or B RJ45 buss port. Once assigned to a Source, General Settings and DSP settings pages shall identify the type of audio Wall Plate and display the appropriate DSP.

The Sources section shall also provide four “Mixes” inputs each allowing a selection of any ten inputs to be combined into a sub-mix to provide a single audio fader adjustment for the group. Each of the four “Mixes” can be named and appear in the source list for selection by a zone output.

In addition, the Sources section shall include a signal oscillator configurable as Freq selectable-Sine wave, white noise, or pink noise. Controls shall be Enable (ON/OFF), Output Level, and shall be available in the source list at all outputs for assignment to zones.

Each of the Zones shall have an editable Name window, Input Source select, dynamic bar-graph-display with fader and simulated LED “active” indicators for Limiter and Priority, Mute, and a Link to the input respective DSP pages. The GUI shall have pages for GENERAL Settings that include Input Priority setup; AtlasIED Speaker voicing Preset select; output Delay adjust; and DSP settings pages for Priority, Crossover, Equalizer, ANC (Ambient Noise Compensation), Noise Detection, Limiter, and Amplifier. The page shall have a link to the source setup page.

Up to 25 mobile devices shall be capable of being used as virtual zone controllers by scanning a QR code with an on-network device. The accessories settings page shall provide access to settings of connected accessories, graphic depiction of connected accessories and their order, the ability to rename accessories, a trigger for the locate function on the accessories, the ability to enable or disable the self-heal function, a link to adding placeholder devices, a QR code preview for devices that are capable, and a link to the front panel configuration page. After configuring screen capable accessories, a QR Code shall display in the GUI and can also be printed. A wall-mount frame for printed QR code shall be included.

The audio processor shall have the ability to combine zones to create a zone group (Room Combine) that is controllable from all assigned wall controllers and virtual wall controllers. Groups created shall be able to include one to four zones. Zones within the group shall have an assigned zone level offset of -20dB to +20dB.

The audio processor shall have an onboard bell scheduler. The bell scheduler shall have the ability to hold up to ten ring lists with each containing up to fifty ring events. Each ring event shall have opt-in capability for each zone and group that has been created within the system. Each ring event shall allow the selection of a separate audio file to be played, recall of a routine, recall of a scene, recall of a GPO preset, combine a room, or uncombine a room. The bell scheduler shall be able to accommodate multi-week bell schedule patterns as well as exception days.

Each created zone shall have a link to a masking control page when opted in under the Add Zone setup page. The page shall include an enable toggle control, toggle control for pink and white noise, a masking gain slider control, a Tilter Filter™ slider control, a low pass enable control, and a low pass enable control. There shall be a method to reduce or increase the masking gain by up to 12dB. A 20 band GEQ with a single slider control per band shall be available to shape the noise source. There shall be a link to a 7-day scheduler that allows for the masking system to be turned off/on via a ramp process for opted in days. The scheduler day shall also provide settings to commission a system by ramping the target gain up over a timeframe of up to 30 days and set a start date/time to begin the commissioning process.

In addition, the audio zone processor shall have six Plug and Play smart Wall Plate optional accessories and a touch screen paging station to expand the capabilities and allow for scalability. Two RJ45 digital bus ports shall be available on the rear panel to terminate accessories using up to 1000' of Cat5e/6 non-shielded cable. One Audio Wall Plate is allowed

Architect and Engineer Specifications

AtlasIED Atmosphere™ AZMP4 – V3.0 (continued)

per port and any control accessory shall be capable of daisy chaining on a single cable digital bus and assigned to any zone. A maximum of sixteen total accessories shall be possible with a reduced number when the touch screen paging station is used. Accessories shall include 3 x Audio Inputs; balanced Mic / Line XLR, dual RCA stereo summed with 3.5mm, and mono summed or stereo Bluetooth® audio wall plate inputs; 2 x Controllers; Volume Controls, Volume Controls with Source Select, Scene Recall, GPO Trigger, Routine Recall, Daily Bell Schedule Selection, and 1 x Ambient Noise Sensor for Zone Ambient Noise Compensation control, and a touch screen table mount paging mic station. The X-ZPS Paging Station accessory, connected by one of the accessory ports (1 X-ZPS per accessory port), shall provide all call, creation of dynamic paging groups, zone control, action recall that include; routine recall, scene recall, GPO preset recall, message recall, bell schedule change, preset groups, and other features combined with a high-quality, gooseneck microphone.

All powered outputs shall be capable of delivering up to 600W as measured using CAF standards. Each bank of four powered outputs shall be capable of delivering a combined 615W as measured using CAF standards. Each powered output shall have the ability to drive low impedance loads ranging from 4Ω to 8Ω and constant voltage loads ranging from 25V to 100V. Each amp channel load setting shall be configurable independently. The available 615W shall be split amongst the banks of four amplified outputs (1-4) in increments of 5W. The amplified outputs shall have the ability to read the load impedance in real time. Each amplified output shall be able to enter a standby by mode that reduces energy consumption based on threshold and hold time controls. The amplified outputs shall be protected against short circuit, HF, DC inputs, and thermal overload. All amplified outputs shall have the ability to perform a self-test that includes, power supply, AC line, relay, fan, temperature, fault, and loudspeaker impedance checks. The self-test shall have the ability to be scheduled on a weekly or monthly basis.

The audio multi-zone system shall be a 1RU-1.70" H x full rack wide (19" x 15.03" deep chassis with rack ears. AC mains shall be 100-240 VAC, 50-60Hz - C14 Mains Inlet Connector; Max Energy Consumption (all amplified channels idle, no audio passing, and no accessories) = 160 BTU/hour; Frequency response for line outputs shall be: +/- 5dB 20Hz-20kHz > 110dB "A" weighted; S/N > 108dB unweighted, > 110dB "A" weighted. Max Bal-Line Output Level = +20dBu (7.75Vrms).

The audio zone system shall be an AtlasIED Atmosphere™ AZMP4.

Architect and Engineer Specifications

AtlasIED Atmosphere™ AZMP8 – V3.0

The audio zone system shall be a ten input by eight output configuration networked device suitable for digitally selecting, combining, mixing, routing, and processing audio signals from up to ten analog sources with optional accessories. It shall send these eight mixed, routed, and processed signals to any combination of the available eight amplified or two monaural line outputs from which the signals would typically be played over loudspeakers in respective zones of a business or other venue.

The front panel shall have a dynamic bar-graph or clock display showing the assigned IP address and each of the Zone output levels (default). A Menu Navigation encoder control knob shall be available to configure and interrogate settings and faults directly. It shall also be used to perform a Factory Reset.

The far-right side of the front panel shall have a Status LED bar that lights Solid Blue when in normal operation and Flashes Red when a Fault is detected.

The rear panel shall have six 3-way 3.5mm Euroblock balanced mic or line level inputs and four RCA stereo summed inputs. The eight amplified outputs shall have four 4-way 5mm Euroblocks and the two line outputs shall utilize a single 6-way 3.5mm Euroblock connector. The amplified outputs shall be routed to RJ45 connectors and enabled via the web UI. Each channel pair shall (1-2, 3-4, 5-6, 7-8) be routed to a single RJ45 connector.

The rear panel shall also have six General Purpose Inputs, one High Priority input, two outputs, and 3 common ports on a 12-position Euroblock. GPI ports shall be configurable in settings for contact closure (NO) or 0-12VDC with 1.3VDC minimum trigger voltage. GPO ports shall have source current of 10ma at 2VDC, maximum sink current of 180ma, and maximum sink voltage of 24VDC.

The audio zone processor shall provide a web browser based intuitive GUI (Graphic User Interface) for configuring sources, zones, and easy setup of processor controls and DSP settings. The GUI shall be accessible by network over a wired LAN, WiFi, or set as a Hot-Spot, with configurable security levels. The GUI shall have an overview dashboard for monitoring with quick links to settings pages for adjusting functions in real time. GUI individual setup page categories shall include: Dashboard, Sources, Zones, Messages, GPIO, Scenes, Routines, Accessories, Scheduler, Diagrams, and Settings.

Sources shall have an ADD SOURCE selection that allows user to Name and configure source type, Mono or Stereo, and select an available Input port or Lt-Rt-ports, and a Color for visual reference. Input ports shall include: Mic-Line, RCA, and Audio Accessories on A and B port.

Each of the Balanced Mic/Line Sources shall have an editable Name window, dynamic bar-graph-display with fader and simulated LED “active” indicators for Gate, De Ess, and Comp, an input Mute, and a Link to open the input respective DSP GUI pages. The GUI shall have pages for GENERAL Settings that include: Preamp Gain of 0-60dB with +4dB sensitivity = 0dB; +48V Phantom; 12dB/Oct HPF, and additional DSP settings pages for Gate, De-Esser, Compressor, Equalizer (4-Band), and Auto-Gain. The page shall have a link to the source setup page.

Each of the -10dBV-RCA stereo summed Sources shall have an editable Name window, dynamic bar-graph-display, fader, an input mute, and a Link to the input respective GUI page for GENERAL Settings (Input Gain), and DSP settings (Same as Mic/Line). Two physical inputs (Mic-Line, RCA, or wall plate) shall be required to configure Stereo to Zones.

The Sources section shall provide GUI pages for Audio Wall Plate sources which will become Active when an Audio Wall Plate is

terminated to the respective A, B, C, or D RJ45 buss port. Once assigned to a Source, General Settings and DSP settings pages shall identify the type of audio Wall Plate and display the appropriate DSP.

The Sources section shall also provide four “Mixes” inputs each allowing a selection of any fourteen inputs to be combined into a sub-mix to provide a single audio fader adjustment for the group. Each of the four “Mixes” can be named and appear in the source list for selection by a zone output.

In addition, the Sources section shall include a signal oscillator configurable as Freq selectable-Sine wave, white noise, or pink noise. Controls shall be Enable (ON/OFF), Output Level, and shall be available in the source list at all outputs for assignment to zones. Each of the Zones shall have an editable Name window, Input Source select, dynamic bar-graph-display with fader and simulated LED “active” indicators for Limiter and Priority, Mute, and a Link to the input respective DSP pages. The GUI shall have pages for GENERAL Settings that include Input Priority setup; AtlasIED Speaker voicing Preset select; output Delay adjust; and DSP settings pages for Priority, Crossover, Equalizer, ANC (Ambient Noise Compensation), Noise Detection, Limiter, and Amplifier. The page shall have a link to the source setup page.

Up to 25 mobile devices shall be capable of being used as virtual zone controllers by scanning a QR code with an on-network device. The accessories settings page shall provide access to settings of connected accessories, graphic depiction of connected accessories and their order, the ability to rename accessories, a trigger for the locate function on the accessories, the ability to enable or disable the self-heal function, a link to adding placeholder devices, a QR code preview for devices that are capable, and a link to the front panel configuration page. After configuring screen capable accessories, a QR Code shall display in the GUI and can also be printed. A wall-mount frame for printed QR code shall be included.

The audio processor shall have the ability to combine zones to create a zone group (Room Combine) that is controllable from all assigned wall controllers and virtual wall controllers. Groups created shall be able to include one to four zones. Zones within the group shall have an assigned zone level offset of -20dB to +20dB.

The audio processor shall have an onboard bell scheduler. The bell scheduler shall have the ability to hold up to ten ring lists with each containing up to fifty ring events. Each ring event shall have opt-in capability for each zone and group that has been created within the system. Each ring event shall allow the selection of a separate audio file to be played, recall of a routine, recall of a scene, recall of a GPO preset, combine a room, or uncombine a room. The bell scheduler shall be able to accommodate multi-week bell schedule patterns as well as exception days.

Each created zone shall have a link to a masking control page when opted in under the Add Zone setup page. The page shall include an enable toggle control, toggle control for pink and white noise, a masking gain slider control, a Tilter Filter™ slider control, a low pass enable control, and a low pass enable control. There shall be a method to reduce or increase the masking gain by up to 12dB. A 20 band GEQ with a single slider control per band shall be available to shape the noise source. There shall be a link to a 7-day scheduler that allows for the masking system to be turned off/on via a ramp process for opted in days. The scheduler day shall also provide settings to commission a system by ramping the target gain up over a timeframe of up to 30 days and set a start date/time to begin the commissioning process.

Architect and Engineer Specifications

AtlasIED Atmosphere™ AZMP8 – V3.0 (continued)

In addition, the audio zone processor shall have six Plug and Play smart Wall Plate optional accessories and a touch screen paging station to expand the capabilities and allow for scalability. Two RJ45 digital bus ports shall be available on the rear panel to terminate accessories using up to 1000' of Cat5e/6 non-shielded cable. One Audio Wall Plate is allowed per port and any control accessory shall be capable of daisy chaining on a single cable digital bus and assigned to any zone. A maximum of sixteen total accessories shall be possible with a reduced number when the touch screen paging station is used. Accessories shall include 3 x Audio Inputs; balanced Mic / Line XLR, dual RCA stereo summed with 3.5mm, and mono summed or stereo Bluetooth® audio wall plate inputs; 2 x Controllers; Volume Controls, Volume Controls with Source Select, Scene Recall, GPO Trigger, Routine Recall, Daily Bell Schedule Selection, and 1 x Ambient Noise Sensor for Zone Ambient Noise Compensation control, and a touch screen table mount paging mic station. The X-ZPS Paging Station accessory, connected by one of the accessory ports (1 X-ZPS per accessory port), shall provide all call, creation of dynamic paging groups, zone control, action recall that include; routine recall, scene recall, GPO preset recall, message recall, bell schedule change, preset groups, other and features combined with a high-quality, gooseneck microphone.

All powered outputs shall be capable of delivering up to 600W as measured using CAF standards. Each bank of four powered outputs shall be capable of delivering a combined 615W as measured using CAF standards. Each powered output shall have the ability to drive low impedance loads ranging from 4Ω to 8Ω and constant voltage loads ranging from 25V to 100V. Each amp channel load setting shall be configurable independently. The available 615W shall be split amongst the banks of four amplified outputs (1-4) in increments of 5W. The amplified outputs shall have the ability to read the load impedance in real time. Each amplified output shall be able to enter a standby by mode that reduces energy consumption based on threshold and hold time controls. The amplified outputs shall be protected against short circuit, HF, DC inputs, and thermal overload. All amplified outputs shall have the ability to perform a self-test that includes, power supply, AC line, relay, fan, temperature, fault, and loudspeaker impedance checks. The self-test shall have the ability to be scheduled on a weekly or monthly basis.

The audio multi-zone system shall be a 2RU-3.45"H x full rack wide (19") x 15.03" deep chassis with rack ears. AC mains shall be 100-240 VAC, 50-60Hz - C14 Mains Inlet Connector; Max Energy Consumption (all amplified channels idle, no audio passing, and no accessories) = 280 BTU/ hour; Frequency response for line outputs shall be: +/- .5dB 20Hz-20kHz > 110dB "A" weighted; S/N >108dB unweighted, >110dB "A" weighted. Max Bal-Line Output Level = +20dBu (7.75Vrms).

The audio zone system shall be an AtlasIED Atmosphere™ AZMP8.