

# DRYWALL/STUCCO/SHEET ROCKS CEILING ASSEMBLY

## The Quick and Easy Way to Install the OWI TB (Tile Bridge) and the Backcan Enclosure with a 6-1/2" or 5-1/4" OWI In-Ceiling Speaker.

1. Position the enclosure over the speaker hole and align it with the screw holes in the tile bridge. Insert and tighten 4 screws through the enclosure into the holes on top of the tile bridge.

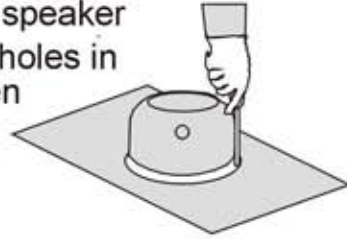

2. Insert and tighten four screws to attach the tile bridge to the beam.

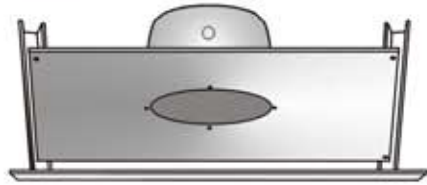

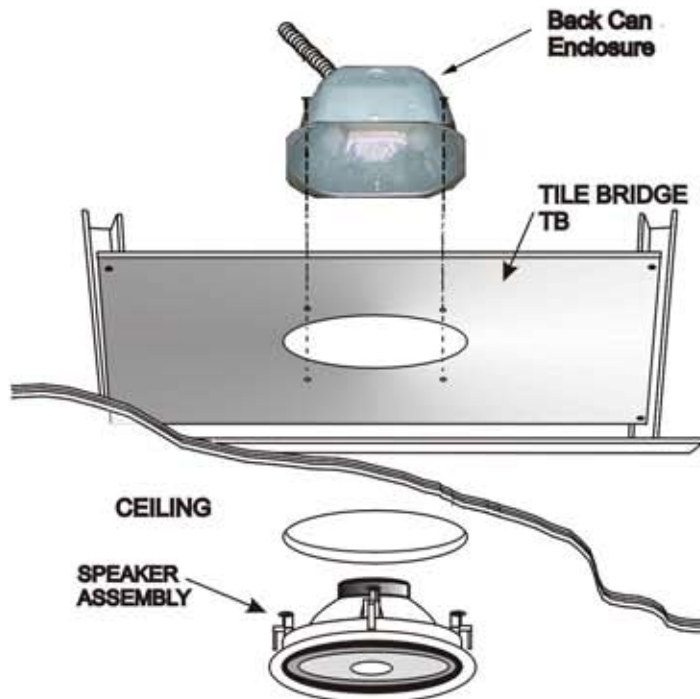
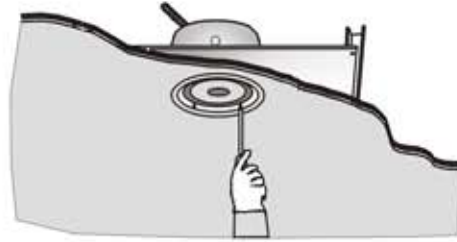

3. After hole is cut in the ceiling, connect the wires and install the speaker by tightening the screws of the four clamps.



**OWI INCORPORATED**  
17141 Kingsview Avenue, Carson, CA 90746-1207 USA  
Tel: 310.515.1900 Fax: 310.515.1606  
Email: [info@owi-inc.com](mailto:info@owi-inc.com) Website: [www.owi-inc.com](http://www.owi-inc.com)

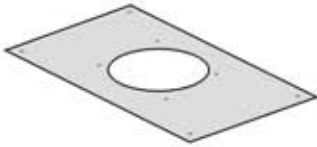
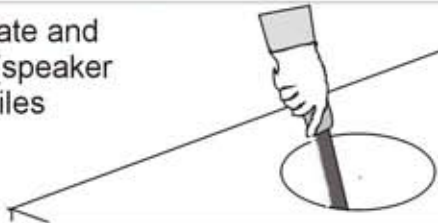
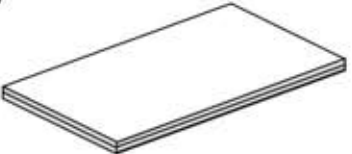
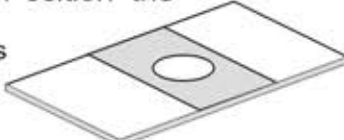
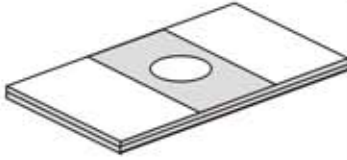
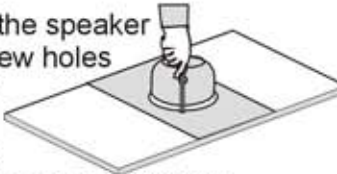

**The Quick and Easy Way to Install the OWI TB (Tile Bridge) and the Backcan Enclosure with a 6-1/2" or 5-1/4" OWI In-Ceiling Speaker.**  
**The TB will work on a 2' X 4', 2' X 2' lay-in type ceilings.**

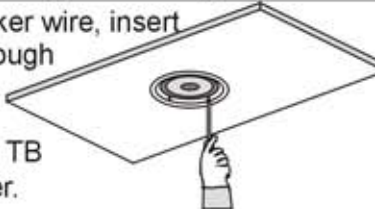
<p>1. Use one tile bridge (TB) as a template to make cut outs for all the ceiling tiles.</p> 	<p>5. Remove the template and saw out the circle (speaker hole). Set ceiling tiles aside.</p> 
<p>2. To save time, cut 2 ceiling tiles at the same time. Lay the ceiling tile face to face.</p> 	<p>6. Place one ceiling tile face down on the floor or on top of a table. Position the TB tile bridge across the tile with the speaker holes coinciding with each other.</p> 
<p>3. After finding the center of the ceiling tile, position the tile bridge template across the tile.</p> 	<p>7. Position the enclosure over the speaker hole and align it with the screw holes in the tile bridge. Insert and tighten 4 screws through the enclosure into the holes on top of the tile bridge through the ceiling tile.</p> 
<p>4. Draw a circle using the speaker hole of the template (tile bridge).</p> 	<p>8. After connecting the speaker wire, insert the speaker assembly through the hole and tighten the screws of the 4 clamps. The 4 clamps will hold the TB and the ceiling tile together.</p> 

**TEE BAR CEILING ASSEMBLY**

