

TF-AMS5AV2E Multisensor IP Camera Quick Installation Guide

Accessories

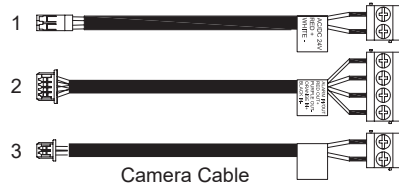
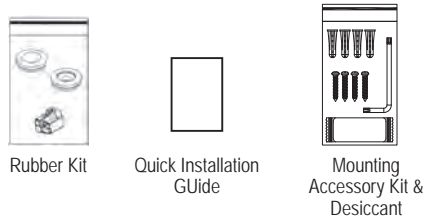

1	Power (24VAC,60VA /24VDC,30W)
2	Alarm
3	Audio (2 cables)

Dimensions

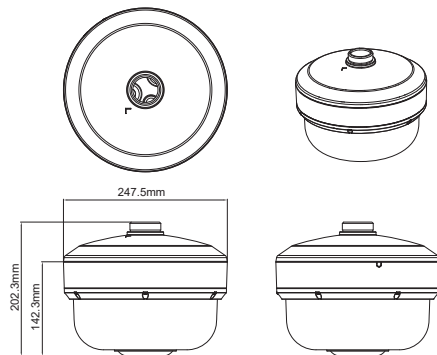

Wall Mount Bracket Assembly

1. Loosen the 6 anti-drop screws on the top cover and open it.



2. Remove and discard the protective EPE from the lens modules.

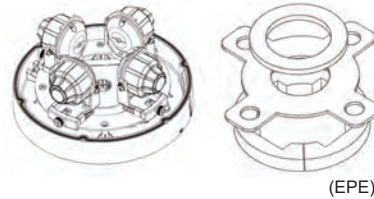

3. Add a desiccant to the recommended position as below.

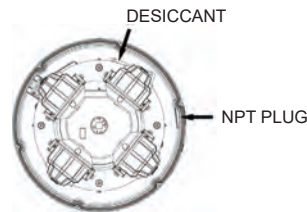

4. Plug the spring cable back to the top cover. Then lock the 6 anti-drop screws on the top cover.

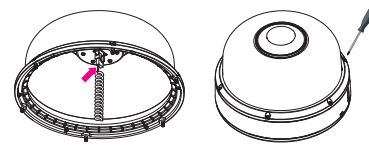

5. Loosen the anti-drop screw on the lateral side of the bottom cover.

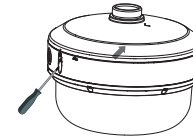

6. Rotate the cap (▽) from LOCK to OPEN in order to remove the cap.

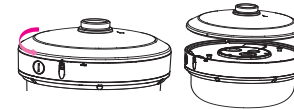

7. Loosen the 3 anti-drop screws on the bottom plate and open it.

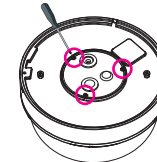

8. Prepare the network cable and wire it through the grommet on the bottom plate.

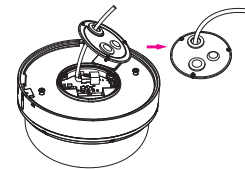

9. Place the bottom plate back to the camera and lock the 3 anti-drop screws to secure it.

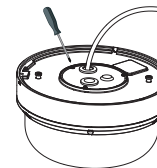

10. Align the bottom cap to the bracket handle and rotate it until it is fixed on the wall mount bracket.

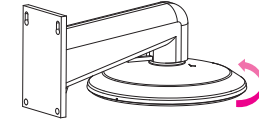

11. Fasten the safety wire on the hook.

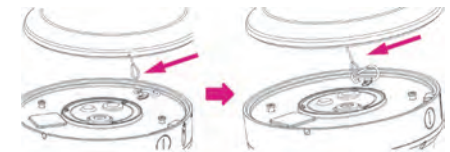

12. Rotate the camera from OPEN to LOCK in order to fix the camera. The ▽ mark should be aligned with the LOCK (□) mark.

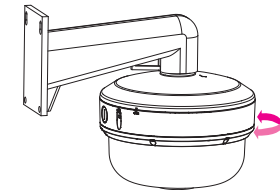

13. Lock the anti-drop screw on the lateral side of the bottom cover to fix the camera.

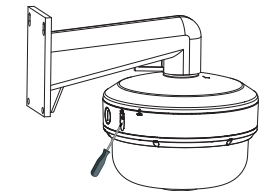

TF-AMS5AV2E Multisensor IP Camera Quick Installation Guide

Pendant Mount Installation (TP- PCPDMB)

1. Rotate the screw with the appropriate tool on the base of the pendant mount to lock it in place.

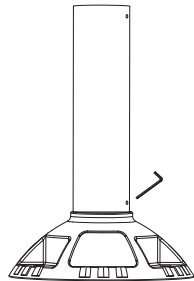

2. Choose a desired installation location and use a driller to drill 3 holes on the surface for securing the pendant mount. Insert 3 screw anchors into the holes and secure the pendant mount to the surface using the screws for the anchors.

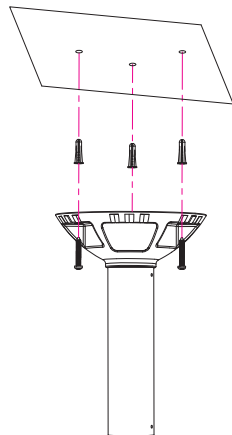

3. Fasten the safety wire on the hook.

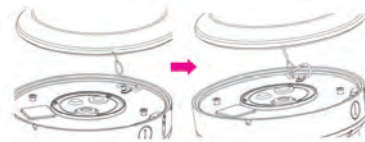

4. Wire the pigtail cable inside the pendant mount bracket. Align the bottom cap of the camera to the bracket handle and rotate it until it is fixed on the pendant mount bracket. Then secure the camera in place with the screw using the appropriate tool.

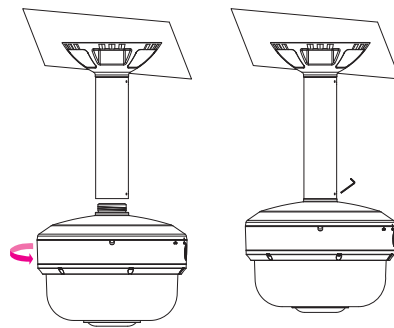

Ceiling Mount

1. Place the positioning label at the desired installation location on the ceiling and use a driller to drill the marker ⊕ symbol in order to allow the screw on the camera to pass through the drilled hole.

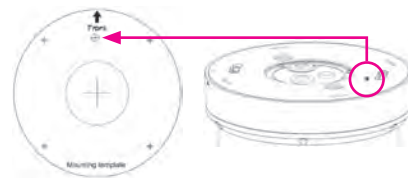

2. Loosen the 4 screws on the plate.

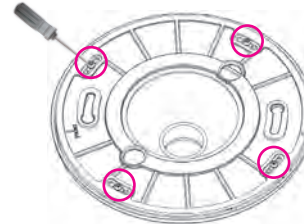

3. Use a driller to drill 4 holes on the surface where the positioning label is placed. Insert 4 screw anchors into the holes and secure the plate to the ceiling using the screws for the anchors.

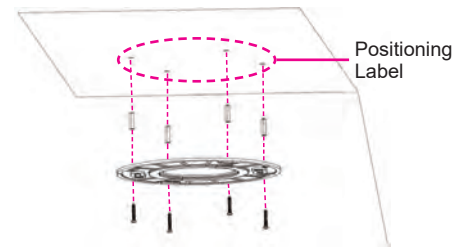

4. Put the camera on the plate.



5. Fasten the safety wire on the hook.

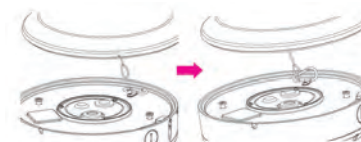

6. Please note that the OPEN ■ mark should be aligned with the screw hole on the plate. (There is only 1 screw hole on the plate for easy recognition.)



7. Twist the camera counterclockwise until it is secured firmly in place. Then fix the camera on the ceiling with the screw.

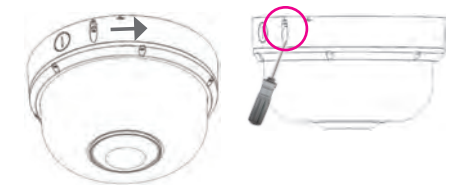

Reset Button

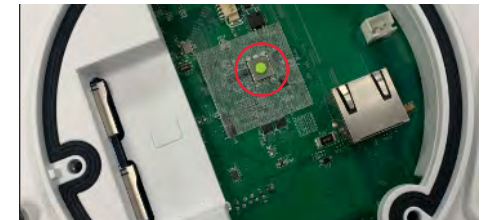

Troubleshooting

If the camera cannot be reached:

1. Ensure POE power delivers at least 30W. Standard IEEE802.3af is insufficient at 15.4W .
2. Place the PC on the same LAN as the camera, and then use the IP Finder to search
3. Try putting the PC and the camera on a closed network without a DHCP server and reboot the camera. Change the PC IP address to 192.168.1.x, then try to reach 192.168.1.168.

TF-AMS5AV2E Multisensor IP Camera Quick Installation Guide

Camera Setup

The TF-AMS5AV2E camera is intended to be used with a Turing NVR & bridge to go on to the Turing Vision.

1. From a Windows PC, download the Turing Smart Utility from the Turing Vision website turing.ai.
2. Make sure the PC is physically connected to the same LAN as the camera and the NVR.
3. Run the Smart Utility. Check the "Other" box to look for the IP address of the TF-AMS5AV2E

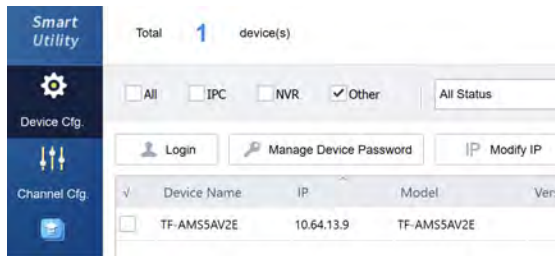

4. If there is no DHCP server or router present, you may access the camera using the default 192.168.1.168 IP address. Make sure your PC is on the same subnet as the camera IP.
5. Using your browser, connect to the camera's IP address. Login using the default credentials:

Username: admin

Password: 123456

6. Use the Setup icon on the top left corner on the web page to make changes to camera settings.



Connecting to the NVR

Each of the cameras is added to the NVR separately as a different channel.

1. In the NVR's Cameras > Camera menu, click on "Add"

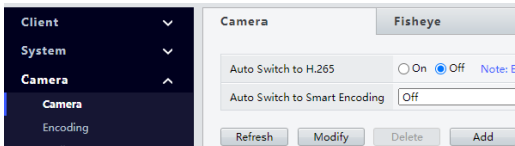

2. Enter the camera's IP address, username and password accordingly. Choose "ONVIF" for Protocol.
3. Choose "4" for Total Camera Number. Check all 4 for Select Camera. Click Save to continue. The first 4 available NVR channels will now be populated by each of the four multisensor cameras.

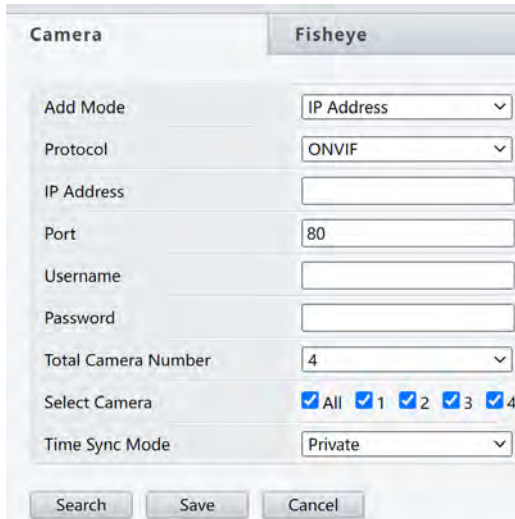

Adding Cameras to Turing Vision

Refer to the NVR's Smart Installation guide and Vision setup guides for details.

1. Follow the NVR and bridge's Smart Installation guide to create your Turing Vision account.
2. In Settings > Camera Settings, add camera with the button on the top right corner.



3. Follow the instructions past Create Site, Add Bridge, and Add Recorder steps.
4. At the "Add Cameras" Step, a snapshot preview should become available for any new camera not already on the Vision Account. Click "Add Cameras" to add them to the account.

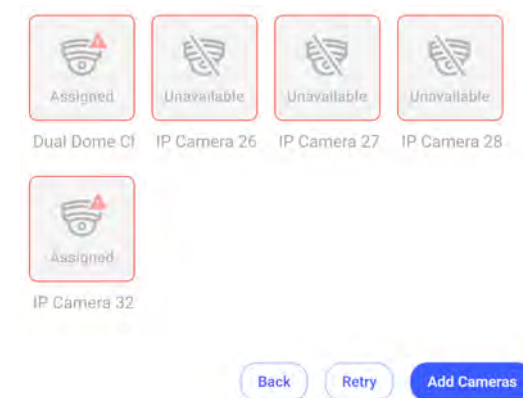

TF-AMS5AV2E Multisensor IP Camera Quick Installation Guide

Lens Position for 180°/270°/360° View

Designed Chain ring with different lens views for manual adjustment

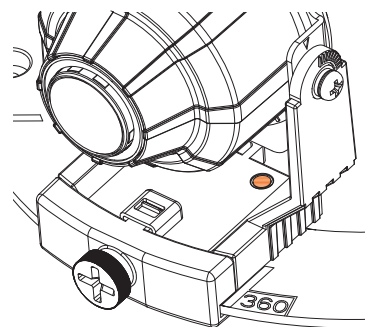
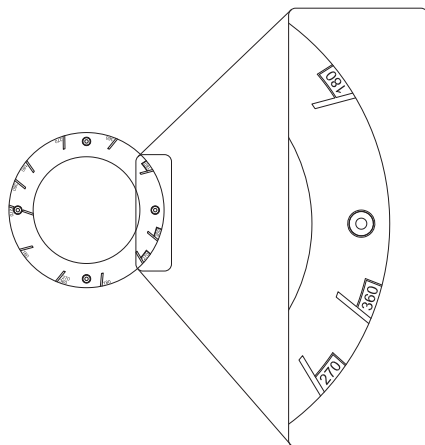

Adjust the main camera position to align it with the yellow dot indicated above on the chain ring (360-degree).

180 Wide

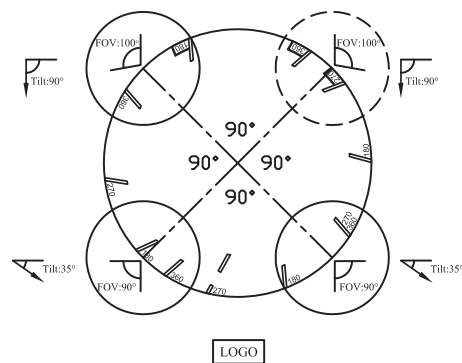

270 Corner

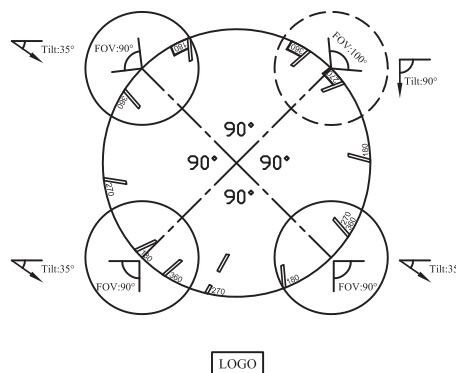

360

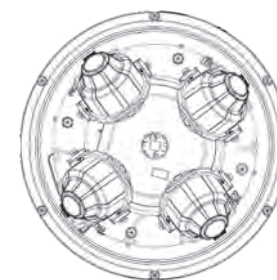
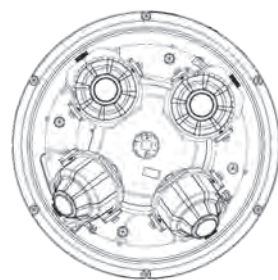
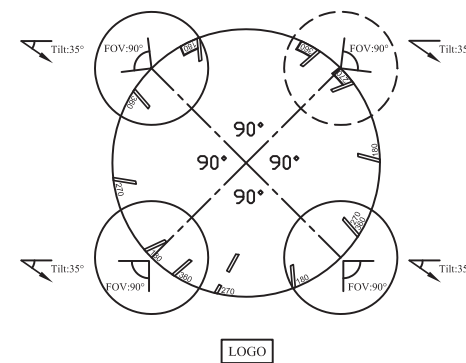

TF-AMS5AV2E Multisensor IP Camera Quick Installation Guide

270 Wide

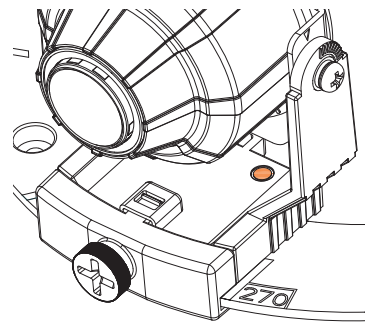
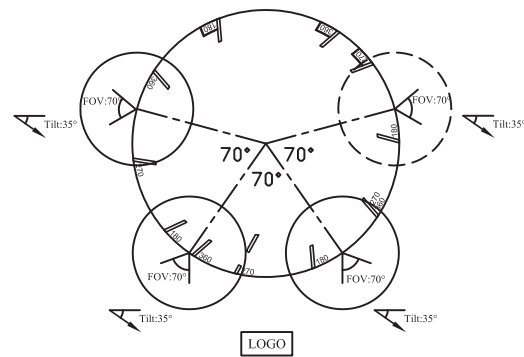

Adjust the main camera position to align it with the yellow dot indicated above on the chain ring (270-degree).

180 Tele

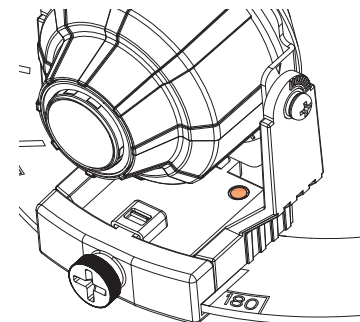
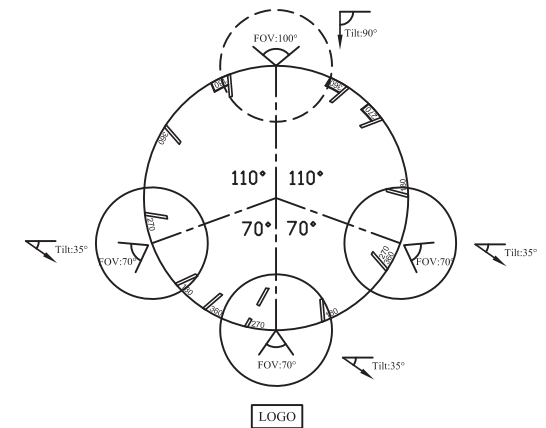

Adjust the main camera position to align it with the yellow dot indicated above on the chain ring (180-degree).

