

User's Guide

**TRENDNET**<sup>®</sup>



**14 dBi WiFi AC867 Outdoor Directional PoE Access Point  
14 dBi WiFi AC867 Outdoor PoE  
Preconfigured Point-to-Point Bridge Kit**

**TEW-840APB0 / TEW-840APB02K**

## Contents

<b>Product Overview .....</b>	<b>1</b>
Package Contents .....	1
Features .....	1
Product Hardware Features.....	3
<b>Primary Product Application.....</b>	<b>5</b>
Application Diagram .....	5
<b>Minimum Installation Requirements .....</b>	<b>6</b>
<b>Wireless Installation Tips .....</b>	<b>6</b>
<b>Model Differences .....</b>	<b>7</b>
TEW-840APBO .....	7
TEW-840APBO2K .....	7
<b>TEW-840APBO Setup &amp; Installation .....</b>	<b>8</b>
Note the WiFi MAC Addresses.....	8
TEW-840APBO #1 .....	9
TEW-840APBO #2 .....	13
Confirm Connectivity .....	15
Pole Mount Installation .....	16
Completed Installation Reference .....	17
<b>TEW-840APBO2K Setup and Installation .....</b>	<b>18</b>
Setup and Confirm Connectivity .....	19
Pole Mount Installation .....	22
Completed Installation Reference .....	23
<b>Channel Access Method .....</b>	<b>24</b>
Carrier-Sense Multiple Access with Collision Avoidance (CSMA/CA) .....	24
Time-Division Multiple Access (TDMA).....	24

<b>Application Modes .....</b>	<b>25</b>
Access Point (AP) .....	25
Client Bridge .....	25
WDS Access Point (WiFi Distribution System) .....	26
WDS Station.....	26
WDS Bridge ( <i>CSMA ONLY</i> ) .....	27
<b>Accessing your access point management page .....</b>	<b>28</b>
Access your access point management page .....	28
<b>Overview .....</b>	<b>29</b>
Device Status .....	29
Connections .....	31
Real-time .....	31
<b>Network .....</b>	<b>32</b>
Basic.....	32
Wireless .....	33
<b>Management .....</b>	<b>38</b>
Advanced .....	38
Time Zone .....	39
WiFi Scheduler.....	40
Tools .....	41
<b>System Manager .....</b>	<b>43</b>
Account.....	43
Firmware .....	43
System Log.....	45
Log Out .....	45
<b>Technical Specifications .....</b>	<b>46</b>
<b>Appendix .....</b>	<b>48</b>

## Product Overview



**TEW-840APBO**



**TEW-840APBO2K**

### Package Contents

**TEW-840APBO** package includes:

- TEW-840APBO
- Quick Installation Guide
- Proprietary/Passive PoE injector (24V DC, 0.6A)
- Mounting hardware

**TEW-840APBO2K** package includes:

- 2 x TEW-840APBO
- Quick Installation Guide
- Proprietary/Passive PoE injectors (24V DC, 0.6A)
- Mounting hardware

If any package contents are missing or damaged, please contact the retail store, online retailer, or reseller/distributor from which the product was purchased.

### Features

TRENDnet's 14 dBi WiFi AC867 Outdoor Directional PoE Access Point, model TEW-840APBO, is designed for point-to-point WiFi bridging applications. The outdoor wireless access point supports a variety of installation scenarios with Access Point, WDS Bridge, WDS Access Point, WDS Station, and Client Bridge modes. The IP56 rated housing is designed for outdoor environments, and includes wall and pole mounting hardware. MU-MIMO technology processes multiple data streams simultaneously, increasing real-time WiFi performance on the outdoor wireless access point when multiple devices access the network.

TRENDnet's 14 dBi WiFi AC867 Outdoor PoE Preconfigured Point-to-Point Bridge Kit, model TEW-840APBO2K, provides long-range wireless AC867 point-to-point connectivity. This preconfigured outdoor WiFi bridge kit provides installers the simplest way to create a long-distance wireless point-to-point bridge. The outdoor WiFi bridge kit conveniently links two locations together with wireless AC speed and performance.

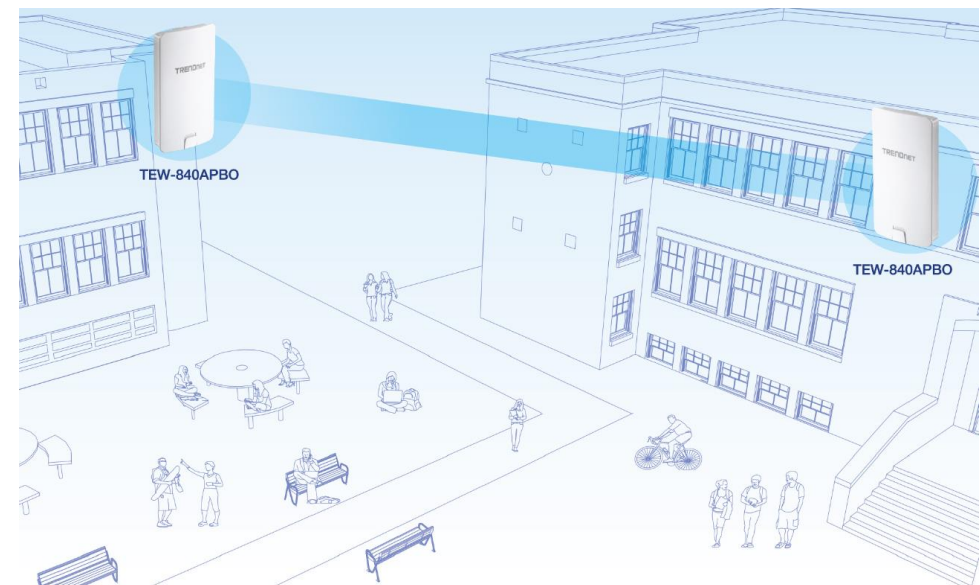

## Preconfigured Kit (*TEW-840APBO2K ONLY*)

Reduce installation and setup time with this preconfigured and pre-encrypted long-range outdoor WiFi bridge kit

## Wireless Modes

Supports Access Point, WDS Bridge, WDS Access Point, WDS Station, and Client Bridge modes.

## WiFi AC867 (5GHz)

Compliant with 802.11a/n/ac 5GHz technology with data rates up to 867Mbps\*

## Outdoor Rated

Durable enclosure with an IP56 outdoor weather rating

## Directional Antenna

Built in 14 dBi directional antenna

## PoE Power Adapter

Proprietary PoE power adapter(s) included

## Encrypted Wireless

Support for wireless encryption of up to WPA2

## Mounting Hardware

Pole and wall mount hardware included

## LED Indicators

LEDs convey wireless link quality

\*Effective wireless coverage may vary depending on the wireless device's output power, antenna gain, antenna alignment, receiving sensitivity, and radio interference. Additionally environmental factors such as weather conditions, physical obstacles, and other considerations may affect performance. For optimal results, we recommended consulting a professional installer for site survey, safety precautions, and proper installation.

\*\*Maximum wireless signal rates are referenced from IEEE 802.11 theoretical specifications. Actual data throughput and coverage will vary depending on interference, network traffic, building materials and other conditions. For maximum performance of up to 867Mbps use with an 867Mbps 802.11ac wireless adapter. Multi-User MIMO (MU-MIMO) requires the use of multiple MU-MIMO enabled wireless adapters.

**Product Hardware Features**

Front View



IP56 Weather Rated Housing with built-in directional sector antenna

Back View (Closed)



LED indicators

Bottom View (Open)



Mounting point

LED indicators

Reset button

Gigabit LAN2 port

IP56 weather rated

Gigabit PoE-in LAN1 port



PoE Power Adapters

- **Gigabit PoE-in LAN1 Port** – This gigabit Ethernet interface will be used to power the access point through the PoE port on proprietary PoE injector and provide gigabit network connectivity to the access point.
- **Gigabit LAN2 Port** – This gigabit Ethernet interface is a secondary gigabit LAN port interface and can be used to also access the access point. The LAN2 port and LAN1 (PoE) port are bridged.
- **Power (PWR) LED** – When the LED is ON, this will indicate that the device is receiving power and OFF if the device is not receiving power.

- **LAN1 LED** – When the LED is ON, this indicates an active network connection to the LAN port on the proprietary PoE injector. When the LED is BLINKING, this indicates data is being transmitted or received on the LAN1 port. The LED is OFF when there is no active network connection to the LAN port on the proprietary PoE injector.
- **LAN2 LED** - When the LED is ON, this indicates an active network connection to the LAN2 port. When the LED is BLINKING, this indicates data is being transmitted or received on the LAN2 port. If the LED is OFF, there is no active network connection to the LAN2 port.
- **WLAN LED** – When the LED is ON, the wireless radio on the device is on. When the LED is OFF, the wireless radio on the device has been disabled.
- **Connection Quality Indicators (WDS station only)** – These LEDs will indicate the wireless connection quality to the WDS Access Point when in WDS station mode.
- **Reset Button** – The reset button resets the access point to factory default settings. Using a paper clip, push and hold the reset button for 15 sec. and release. The LEDs will flash when the device reset has been initiated.
- **PoE Power Adapter Reset Button** – The included PoE injector also has a reset button to reset the access point to factory default. Using a paper clip, push and hold the reset button for 15 sec. and release. The LEDs will flash when the device reset has been initiated.

#### Important Note:

It is recommended to use RJ-45 cables without any additional caps, molded caps, or boots specifically on the connector side that will be connected to the access point LAN1 (PoE) port to avoid any cable fitment issues inside the access point enclosure.

- **Proprietary PoE Power Adapters**

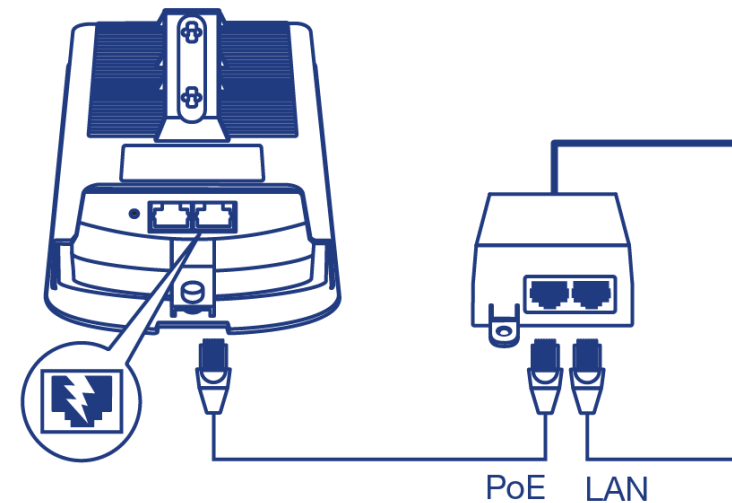

#### Important Note:

The access point **does not** support standard IEEE 802.3at/af PoE/PoE+. Only the included proprietary PoE injector may be used to supply power to the access point. For safety, use only the included PoE injector to supply power to the access point.

- **POWER IN** – Connect the included power cord to this input and the other end into an AC power source to supply power to the injector.
- **PoE** – Connect an Ethernet RJ-45 cable to this output and the other side to the device LAN1 (PoE) port to supply power to the device. Please note that the RJ-45 Ethernet cable between the proprietary PoE injector and the LAN1 (PoE) port of the access points supports a maximum length of up to 60 m (197 ft.). RJ-45 Ethernet cables longer than the maximum length specified may result in insufficient power to the device, intermittent connectivity/power loss, and unstable physical link.
- **LAN** – Connect an Ethernet RJ-45 cable to this input and connect the other to your network or directly to a computer for initial device setup.

## Primary Product Application

The intended purpose and application for this product is to extend network connectivity across long physical distances outside of an area or building that lacks local connectivity using point-to-point wireless bridge capability using 802.11 standards. Essentially, two access points configured in point-to-point bridge capability can connect/link the two physical locations or buildings together through an encryption wireless connection. Although this product supports multiple wireless modes, the basic installation will only cover the primary application of point to point wireless connectivity in WDS (Wireless Distribution System) Mode using AES encryption for security.

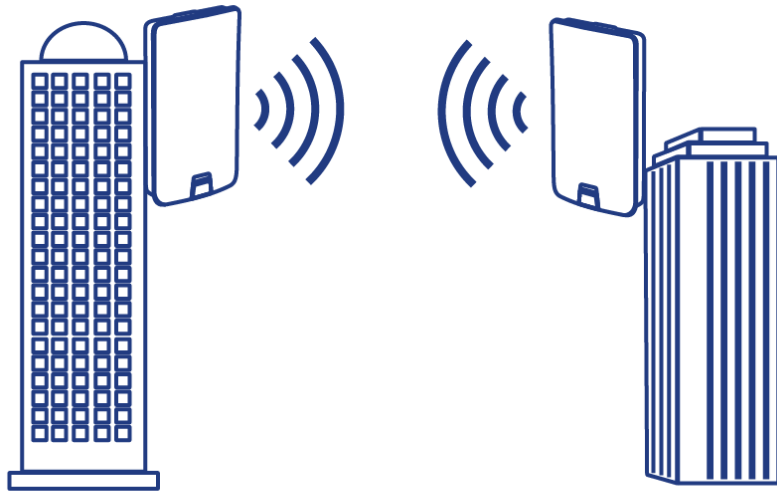

## Application Diagram

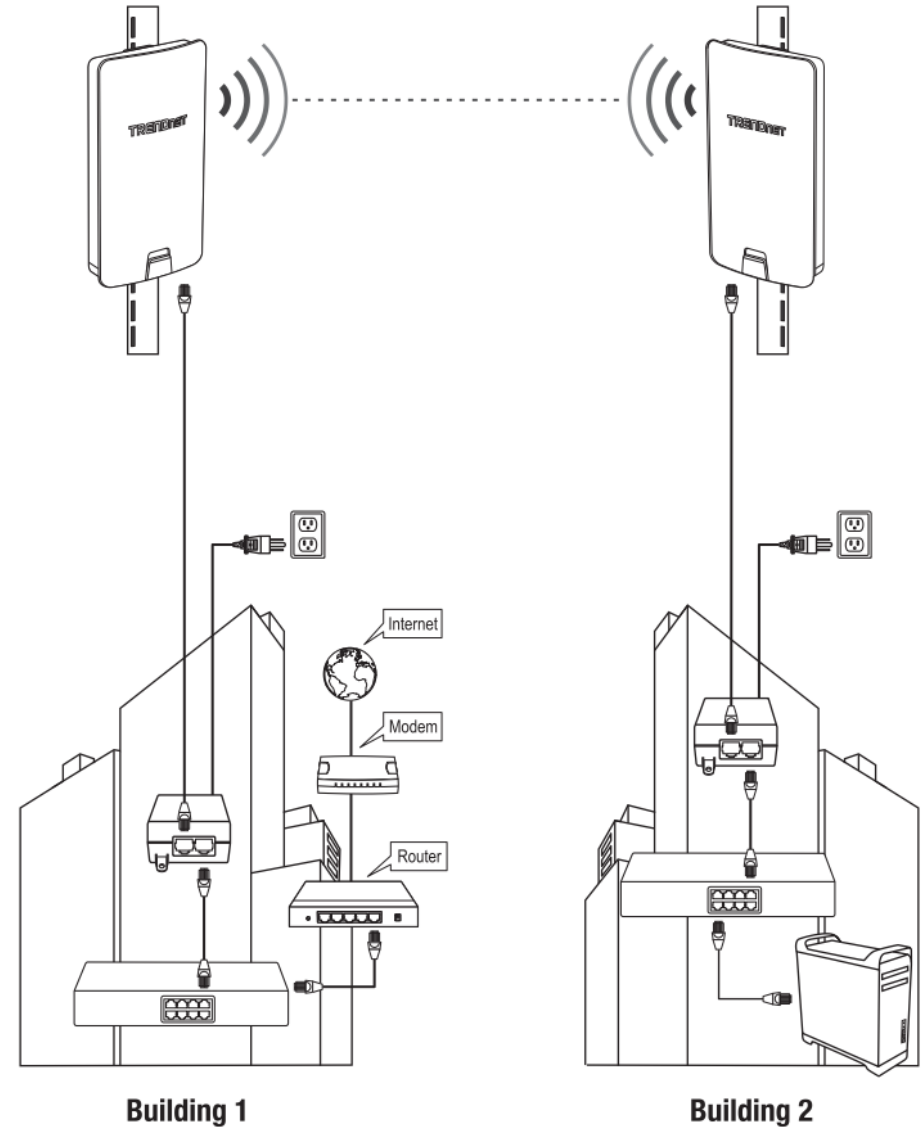

The example application displays two TEW-840APBO access points establishing a wireless link between each other, one configured in WDS Access point, the other in WDS station; allowing for network connectivity between two buildings over a point-to-point wireless link.



## Minimum Installation Requirements

- Computer with RJ-45 Ethernet port and web browser
- 2 x RJ-45 Ethernet cables (not included) per TEW-840APBO
- Additional TRENDnet TEW-840APBO or TEW-841APBO (For TEW-840APBO single unit only, TEW-840APBO2K model includes two preconfigured units)

For wall mounting only (included wall mounting kit for drywall installations only)

- Philips driver bit or screwdriver
- Power drill/driver (for mounting anchors)
- 7/16 in (2.75 mm) straight drill bit for hard wood or 3/32 in (2.35 mm) bit for soft wood (for mounting screws)
- 11/16 in (4.3 mm) straight drill bit for hard wood or 5/32 in (4 mm) bit for soft wood (if required for drywall anchors)

## Wireless Installation Tips

There are a number of factors that can impact the range of wireless devices.

1. Adjust your wireless devices so that the signal is traveling in a straight path, rather than at an angle. The more material the signal has to pass through the more signal you will lose.
2. Keep the number of obstructions to a minimum. Each obstruction can reduce the range of a wireless device. Position the wireless devices in a manner that will minimize the amount of obstructions between them.
3. Building materials can have a large impact on your wireless signal. In an indoor environment, try to position the wireless devices so that the signal passes through less dense material such as dry wall. Dense materials like metal, solid wood, glass or even furniture may block or degrade the signal.
4. Antenna orientation can also have a large impact on your wireless signal. Use the wireless adapter's site survey tool to determine the best antenna orientation for your wireless devices.
5. Interference from devices that produce RF (radio frequency) noise can also impact your signal. Position your wireless devices away from anything that generates RF noise, such as microwaves, radios and baby monitors.

If you are still experiencing low or no signal consider repositioning the wireless devices or installing additional access points. The use of higher gain antennas may also provide the necessary coverage depending on the environment. Please note to use the wireless connection quality indicators during installation to determine the optimal positioning when mounting your access points.



## Model Differences

### TEW-840APBO

#### Single Unit Model

The single access point requires another TRENDnet TEW-840APBO or a TEW-841APBO to create a WDS link.

#### Important Note:

Purchasing this model requires the access points to be properly configured to establish the wireless link/bridged connection to each other and verifying connectivity first before mounting the access points in their desired locations.

#### Single Unit Default Settings

LAN IP Address: 192.168.10.100  
 LAN Subnet Mask: 255.255.255.0  
 Channel Access Method: CSMA/CA  
 Mode: Access Point (AP) Mode  
 WPA2 Encryption Key: <predefined>  
 User: admin  
 Password: admin

### TEW-840APBO2K

#### Preconfigured Bridge Kit Model

The two access points in the kit model are preconfigured to establish a WDS bridged connection to each using a unique WPA2 encryption key. For convenience, a unique predefined administrator password is also assigned. The predefined WPA2 encryption key and administrator password can be found on the included wireless settings sticker or on the device label.

#### Important Note:

Purchasing this model does not require any additional configuration to establish the wireless link/bridged connection between the two access points but it is strongly recommended that you verify connectivity first between the two access points first before mounting them in their desired locations.

#### Preconfigured Kit Default Settings

TEW-840APBO #1	TEW-840APBO #2
LAN IP Address: 192.168.10.50	LAN IP Address: 192.168.10.51
LAN Subnet Mask: 255.255.255.0	LAN Subnet Mask: 255.255.255.0
Channel Access Method: TDMA	Channel Access Method: TDMA
Mode: WDS Access Point Mode	Mode: WDS Station Mode
WDS WPA2 Encryption Key: <predefined>	WDS WPA2 Encryption Key: <predefined>
User: admin	User: admin
Password: <predefined>	Password: <predefined>

#### Wireless Setting Stickers for Kit TEW-840APBO2K

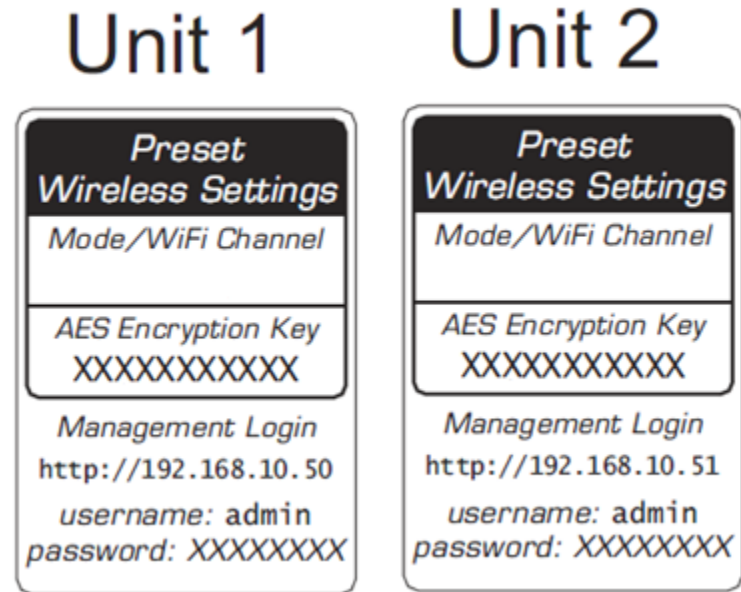

## TEW-840APBO Setup & Installation

The following installation procedure assumes you are setting up and installing two TRENDnet **TEW-840APBO** access points using **TDMA** channel access method in **WDS Access Point/Station** point-to-point configuration. For more information, please see "[Channel Access Method](#)" on page 25.

**Note:** This example installation procedure will be demonstrated using the following example network information:

Example Router Settings:

Router/Default Gateway IP Address: 192.168.10.1

Subnet Mask: 255.255.255.0

Using the above information, we will configure the TEW-840APBO access points will be configured with the following settings:

	TEW-840APBO #1	TEW-840APBO #2
IP Address	192.168.10.50	192.168.10.51
Netmask (Subnet Mask)	255.255.255.0	255.255.255.0
IP Gateway (Default Gateway)	192.168.10.1	192.168.10.1
Primary DNS	192.168.10.1	192.168.10.1
Wireless Channel (Default)	48	48
Channel Access Method	TDMA	TDMA
Mode	WDS Access Point	WDS Station
WDS Encryption	WPA2	WPA2

**Note:** In this installation procedure example, we will assume the WiFi MAC addresses:

	TEW-840APBO #1	TEW-840APBO #2
WiFi MAC Address	00:11:22:33:44:00	00:11:22:33:44:11

### Note the WiFi MAC Addresses

1. Remove the cover of the access points by pulling and holding the tab outwards (as shown in the picture below) and sliding the cover downwards, away from the access point.

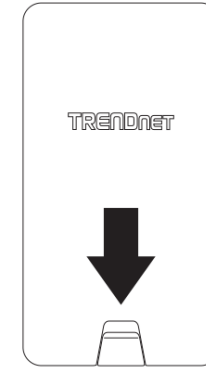

Pull and hold tab

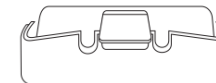

2. Write down the WiFi SSID, WPA2 Key, and WiFi MAC address of each access point. The MAC address can be found on the back label, and the SSID and WPA2 Key can be found on the inside of the device cover where the Ethernet LAN ports are located (pictured below).

Model: TEW-840APBO /A  
 IP Address: 192.168.10.100  
 Subnet Mask: 255.255.255.0  
 User Name: admin  
 Password: admin  
 Mode: WDS AP  
 SSID: TRENDnet840\_XXXX  
 WPA2 Key: 840XXXXXXXXX  
 Default Channel: 48

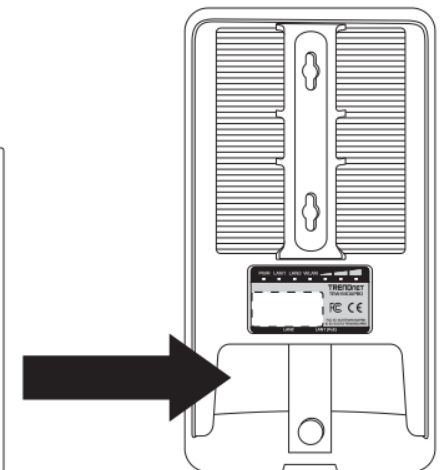

**TEW-840APBO #1**

- Using a RJ-45 network cable, connect one end of the cable to the **LAN1 (PoE)** port and ensure the cable is lined up with the Cable Guides before closing the cover. **(note: this RJ-45 network cable cannot exceed 60m)**

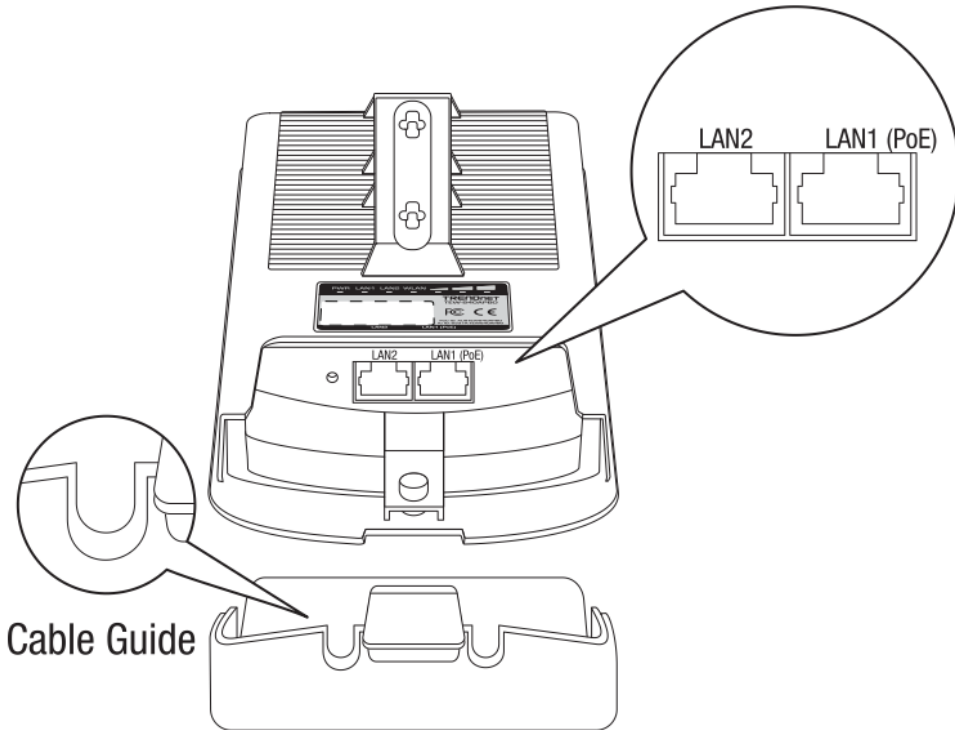

- Connect the other end of the RJ-45 network cable to the **PoE** port on the included PoE injector. **(note: this RJ-45 network cable cannot exceed 60m)**
- Using another RJ-45 network cable, connect one end to the **LAN** port on the included PoE injector.
- Connect the other end of the RJ-45 network cable to your computer's Ethernet port.
- Attach the power cord to the PoE injector and plug the connected power cord into a power outlet.

- Confirm the device is powered on through the LED indicators.

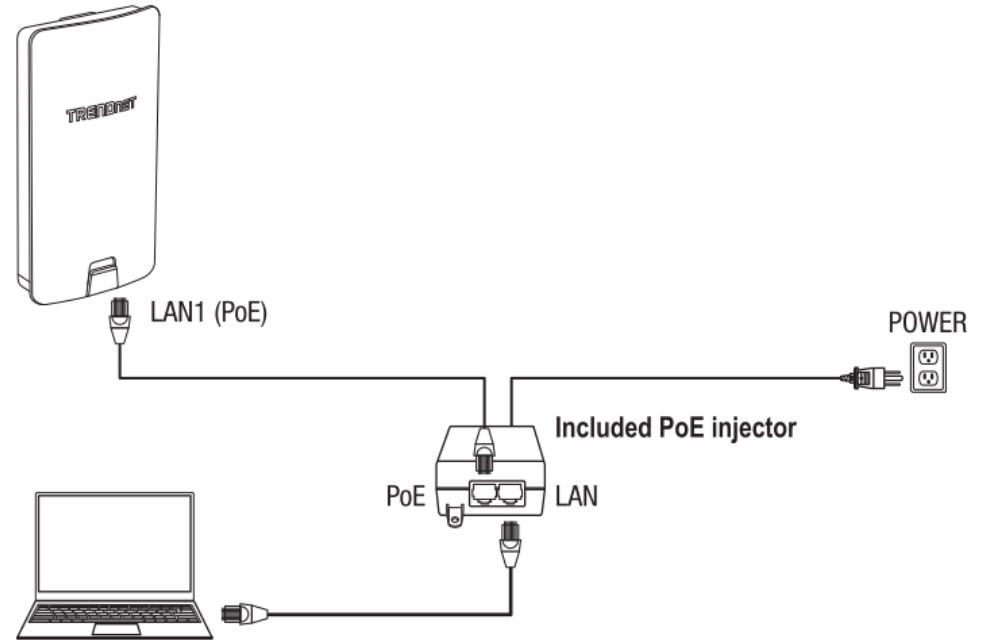

- Assign a static IP address to your computer's network adapter in the subnet of 192.168.10.x (e.g. 192.168.10.10) and subnet mask of 255.255.255.0.

**Note:** For information on how to statically assign your IP address, see the Appendix section.

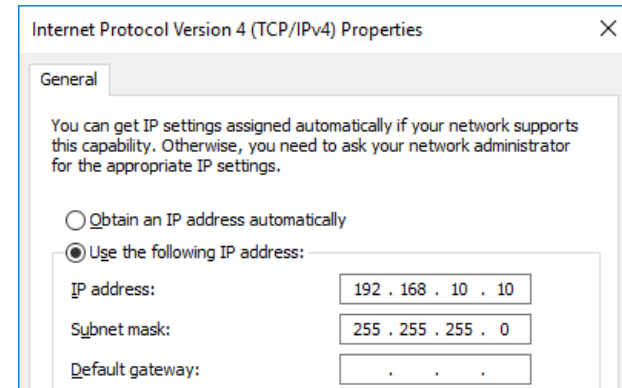

8. Open your web browser and type in the default IP address of the access point in the address bar, then press **Enter**. The default IP address of the access point is 192.168.10.100.

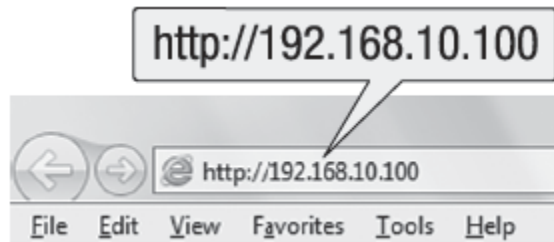

9. When prompted, login to the access point management page using the default user name and password settings.
- User Name: admin
  - Password: admin

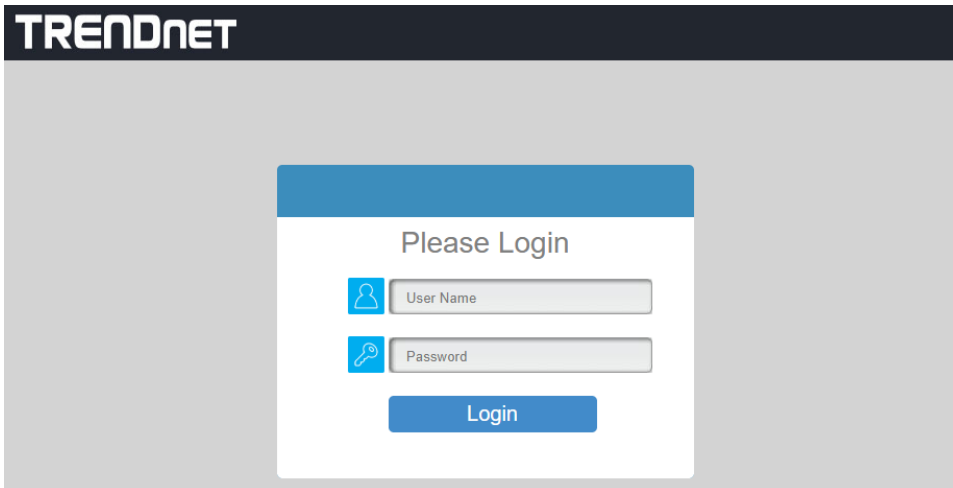

10. Click on the **Account** tab under **System Manager** Category at the bottom of the left menu.

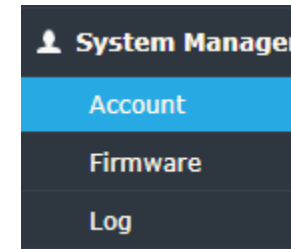

11. Change the default administrator password by first entering the default password (admin), then typing in the new password in the fields provided and then click the **Apply** button at the bottom of the page.
- Note: Clicking the green "refresh" button will display hidden characters typed in the field.*

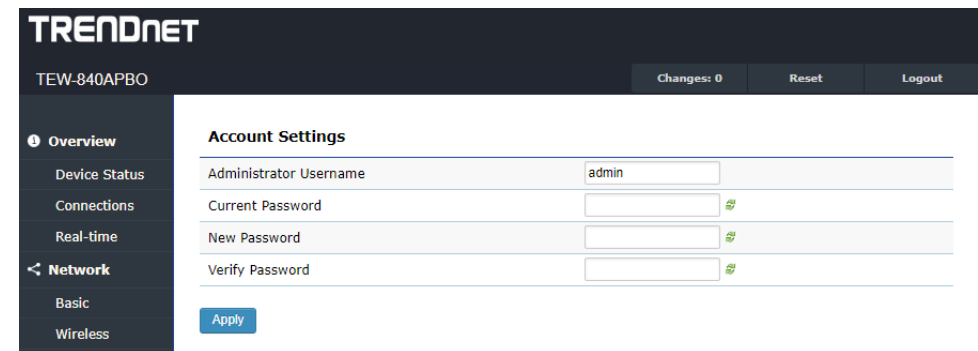

12. Upon clicking apply, you will return to the login screen. Please enter the newly configured credentials to log back in.

13. Click on the **Basic** tab under **Network** category in the left hand menu.

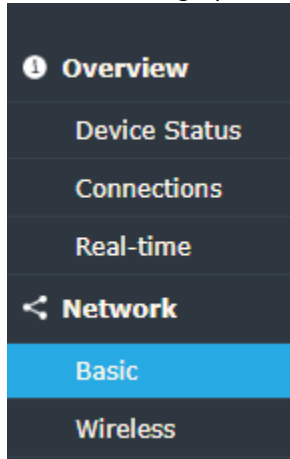

14. Under the IPv4 Settings section, select **Static IP** and enter the IP Address **192.168.10.50**, Subnet Mask **255.255.255.0**, Gateway **192.168.10.1**, then click **Save** at the bottom of the page.

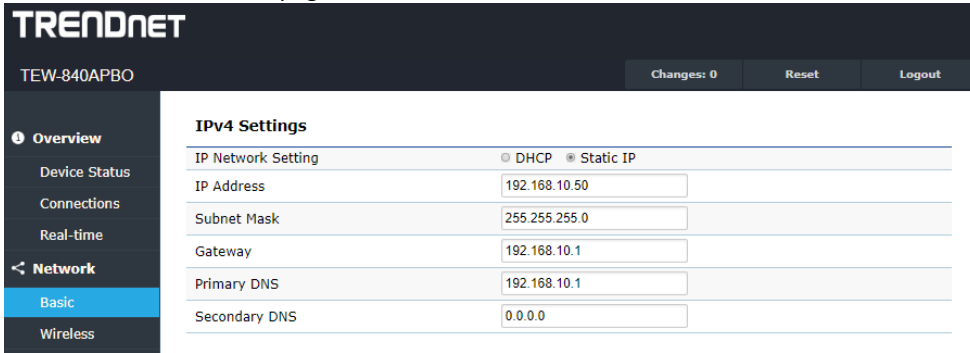

15. The page should now have two indicators regarding pending changes:

- Top right menu of the page:

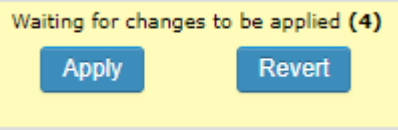
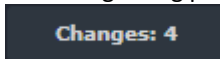

- Bottom right of the page:

**Note:** Settings configured on the Access Point are not applied until you click apply changes. In order to minimize time spent waiting for the Access Point to reboot when applying settings, we recommend configuring all necessary settings and changes prior to apply & reboot of the device.

16. Click on the **Wireless** tab under **Network** category in the left hand menu.

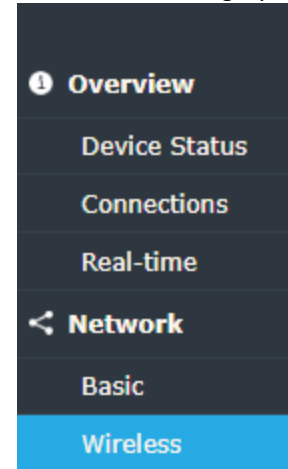

17. Select **TDMA** under **Channel Access Mode**.

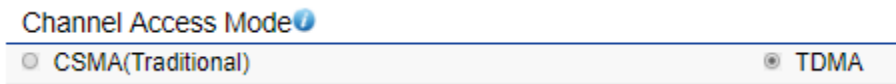

18. Click on the **Operation Mode** field and in the drop-down list click on **WDS Access Point**.

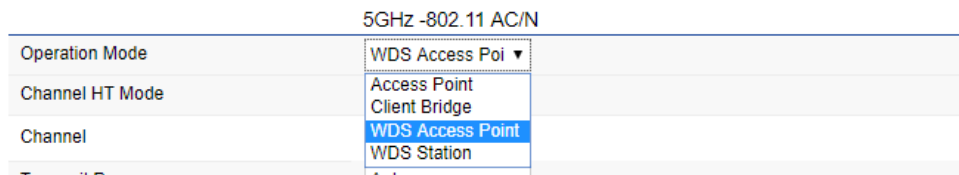

19. Click **Configuration** for **Channel**.



- Within the new popup window, please select and take note of which channel this access point is set to broadcast at then click **Save**. **Default: Ch. 48** (note, the greyed out channel is the currently selected channel).

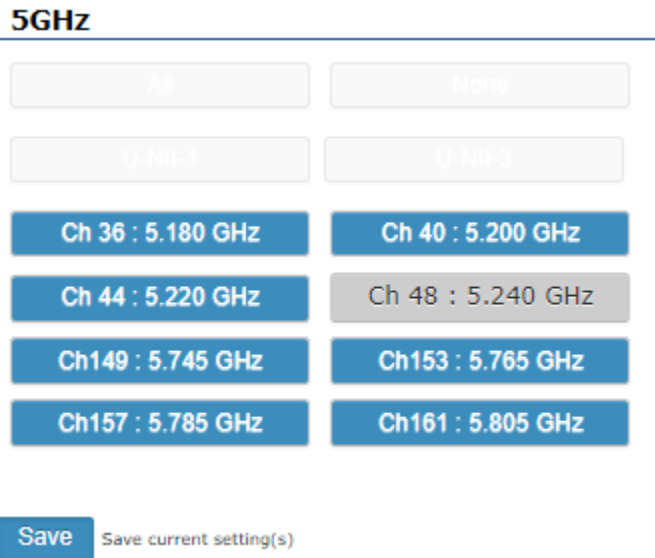

20. Scroll down on the previous page (**Wireless** tab under the **Networking** category) and identify the **Wireless Settings – 5GHz** section, click on **Edit** to configure the WDS AP settings. A new window will open for wireless settings configuration.

Wireless Settings - 5GHz

Purpose	SSID	Edit	Security	Hidden SSID	Client Isolation	VLAN Isolation	L2 Isolation	VLAN ID
TDMA	TRENDnet840_0009	<b>Edit</b>	WPA2/PSK AES	<input type="checkbox"/>	<input type="checkbox"/>	<input type="checkbox"/>	<input type="checkbox"/>	51

- Within the new popup window, please select and take note of the **Security Mode**, **Encryption**, and **Passphrase** then click **Save**.  
**Default: WPA2-PSK, AES, <predefined>**

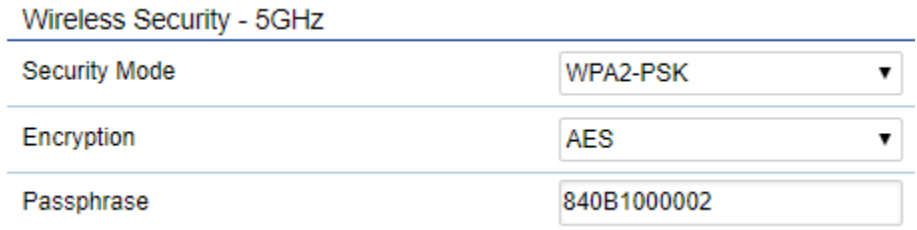

**Note:** Certain browsers and popup blockers may block the configuration popup windows. Check to make sure there is nothing blocking the window from appearing if you do not see it.

21. Scroll down on the previous page (**Wireless** tab under the **Networking** category) and click **Save**.

### MAKE SURE THE CHANGES TO THE CONFIGURATIONS ARE APPLIED

- Click **Changes** **Changes: 4** from the top right menu bar, and click **Apply**.

OR

- Click **Apply** **Apply** on the bottom right of any page:

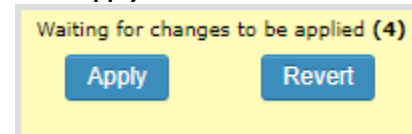

**TEW-840APBO #2**

When configuring TEW-840APBO #2, **repeat all steps up to step 14** in previous section when configuring [TEW-840APBO #1](#).

Assuming steps 1-14 from previous section....

15. Under the IPv4 Settings section, select **Static IP** and enter the IP Address **192.168.10.51**, Subnet Mask **255.255.255.0**, Gateway **192.168.10.1**, then click **Save** at the bottom of the page.

The screenshot shows the 'IPv4 Settings' page in the Trendnet web interface. The 'IP Network Setting' is set to 'Static IP'. The following fields are filled: IP Address (192.168.10.51), Subnet Mask (255.255.255.0), Gateway (192.168.10.1), Primary DNS (192.168.10.1), and Secondary DNS (0.0.0.0). The left sidebar shows the 'Network' menu with 'Wireless' selected.

16. The page should now have two indicators regarding pending changes:

- Top right menu of the page:

Changes: 4

- Bottom right of the page:

Waiting for changes to be applied (4)

Apply Revert

**Note:** Settings configured on the Access Point are not applied until you click apply changes. In order to minimize time spent waiting for the Access Point to reboot when applying settings, we recommend configuring all necessary settings and changes prior to apply & reboot of the device.

17. Click on the **Wireless** tab under **Network** category in the left hand menu.

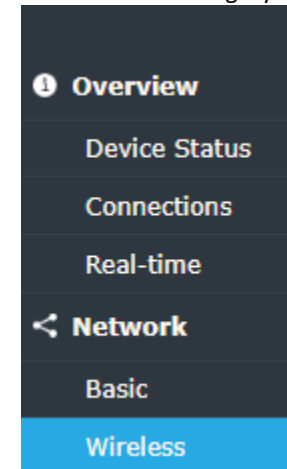

18. Select **TDMA** under **Channel Access Mode**.

#### Channel Access Mode ⓘ

CSMA(Traditional)  TDMA

19. Click on the **Operation Mode** field and in the drop-down list click on **WDS Station**.

The screenshot shows the 'Channel Access Mode' configuration page. The 'Operation Mode' dropdown menu is open, and 'WDS Station' is selected. The channel is set to '5GHz -802.11 AC/N'.

Operation Mode	WDS Station
Channel HT Mode	Access Point
Channel	Client Bridge
Transmit Power	WDS Access Point
	WDS Station
	Auto



20. Click **Configuration** for **Channel**.



- Within the new popup window, please select the channel which was selected in when configuring [TEW-840APBO #1](#) then click **Save**. (*Note: the greyed out channel is the currently selected channel*).

**5GHz**



**Save** Save current setting(s)

21. Scroll down on the previous page (**Wireless** tab under the **Networking** category) and identify the **Wireless Settings – 5GHz** section, click on **Edit** to configure the WDS station settings. A new window will open for wireless settings configuration.

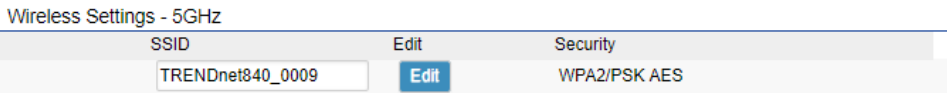

**Note:** Certain browsers and popup blockers may block the configuration popup windows. Check to make sure there is nothing blocking the window from appearing if you do not see it.

- Within the new popup window, click **Device Discovery** then select the correct radio, or manually enter the BSSID MAC and SSID of those in configured for [TEW-840APBO #1](#).

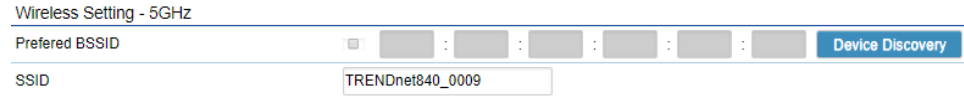

- Additionally, configure the **Security Mode**, **Encryption**, and **Passphrase** to match those configured for [TEW-840APBO #1](#) then click **Save**.

**Wireless Security - 5GHz**

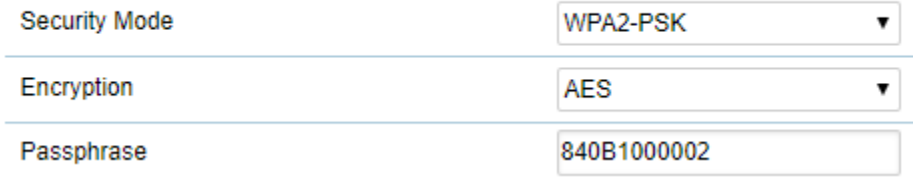

22. Scroll down on the previous page (**Wireless** tab under the **Networking** category) and click **Save**.

**MAKE SURE THE CHANGES TO THE CONFIGURATIONS ARE APPLIED**

- Click **Changes** **Changes: 4** from the top right menu bar, and click **Apply**.

**OR**

- Click **Apply** **Apply** on the bottom right of any page:

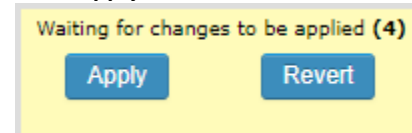

### Confirm Connectivity

1. Leave your computer connected to TEW-840APBO #2 and keep the access point management page open.
2. Make sure both TEW-840APBO #1 and TEW-840APBO #2 access point are powered on and approximately 15 ft. (5 m) apart from one another with the front of access points directly facing each other.

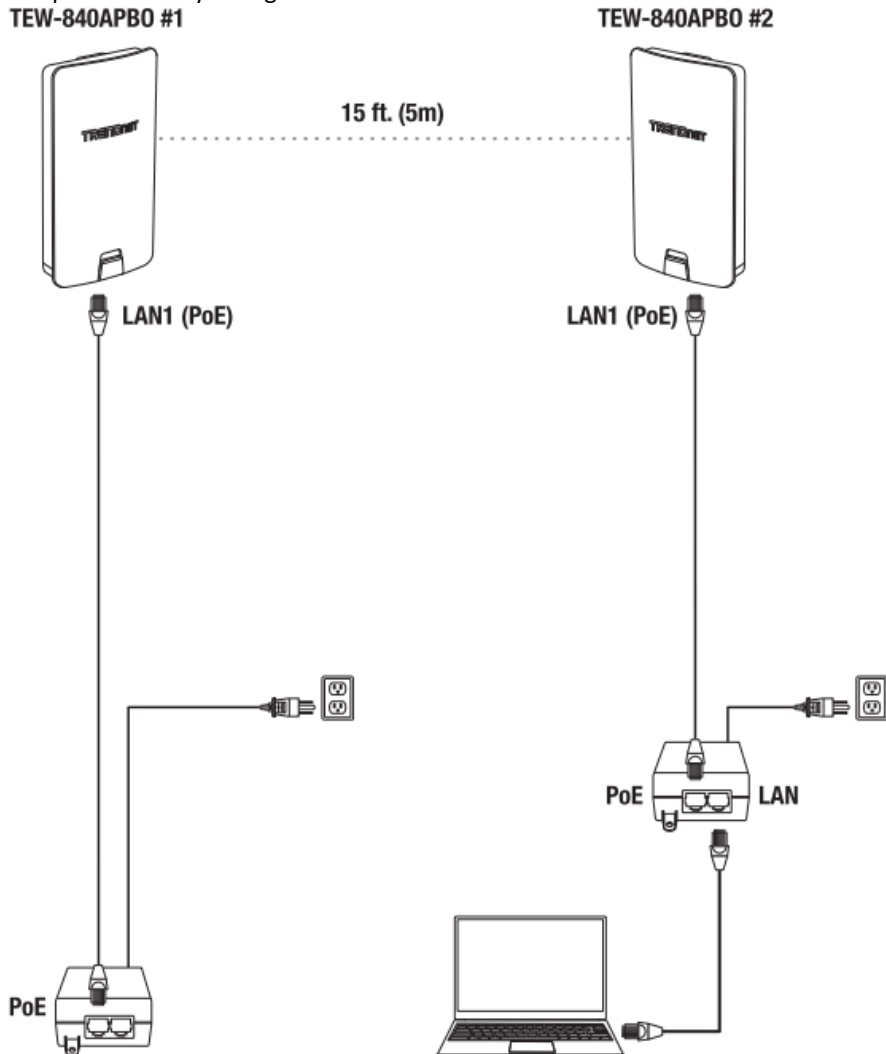

3. To verify connectivity, in the TEW-840APBO #2 access point management page, Click on the **Tools** tab under **Management** category in the left hand menu.

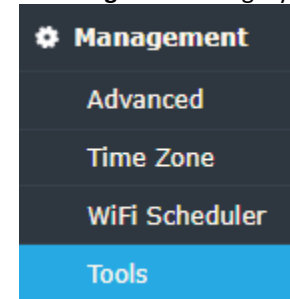

4. The first tab, **Ping**, will automatically be selected. In the **Target IP/Domain Name** field, enter the IP address **192.168.10.50**. Then click **Ping**. The first tab, **Ping**, will automatically be selected. In the **Target IP/Domain Name** field, enter the IP address **192.168.10.50**. Then click **Ping**.
5. Ping replies and 0% packet loss will indicate a successful WDS point to point bridge has been established between the two access points as shown below.

#### Ping Test Parameters

Target IP / Domain Name	<input type="text" value="192.168.10.50"/>
Ping Packet Size	<input type="text" value="64"/> Bytes
Number of Pings	<input type="text" value="4"/>

```

PING 192.168.10.50 (192.168.10.50): 64 data bytes
72 bytes from 192.168.10.50: seq=0 ttl=64 time=4.221 ms
72 bytes from 192.168.10.50: seq=1 ttl=64 time=4.010 ms
72 bytes from 192.168.10.50: seq=2 ttl=64 time=3.008 ms
72 bytes from 192.168.10.50: seq=3 ttl=64 time=2.841 ms

--- 192.168.10.50 ping statistics ---
4 packets transmitted, 4 packets received, 0% packet loss
round-trip min/avg/max = 2.841/3.519/4.221 ms
    
```

6. You can also check the status of the wireless point to point bridge between the two access points in the **Connections** tab under **Overview** category in the left hand menu.

**Note:** If the connectivity test fails, wait for about 1 minute and try again. Make sure there are no obstacles between two access points and that they are not too close together.

## Pole Mount Installation

1. Reinstall the cover by lining up the guides into the notches as shown and push until the cover clips into place and is secured. The cover includes cable openings to route the connected Ethernet cable(s) when installing.

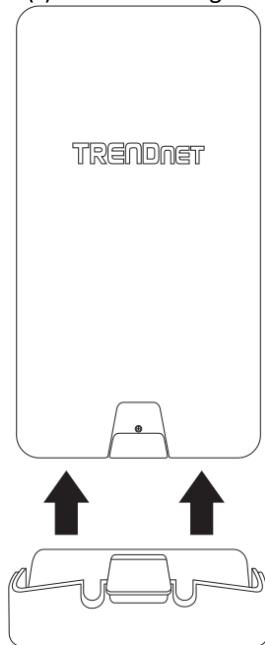

2. Insert the included fasteners through the holes located at the back of the access point.

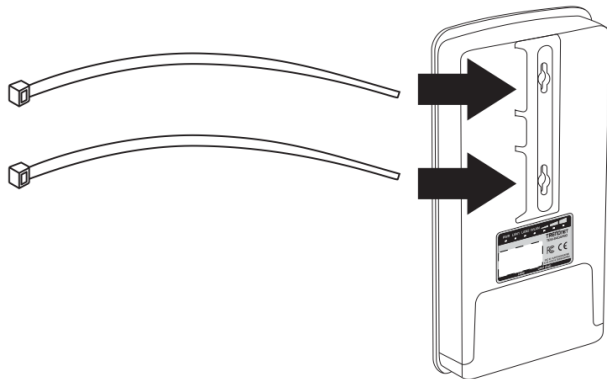

3. Wrap the fasteners around the pole where the access point will be installed. On the fasteners, insert the open end into the locking mechanism and pull tight until the point is secured.

**Note:** When set to **WDS station** mode, the TEW-840APBO features WiFi signal strength connectivity LEDs located on the back of the access point to assist in determining the optimal mounting position. (Red = Good, Orange = Better, Green = Best)

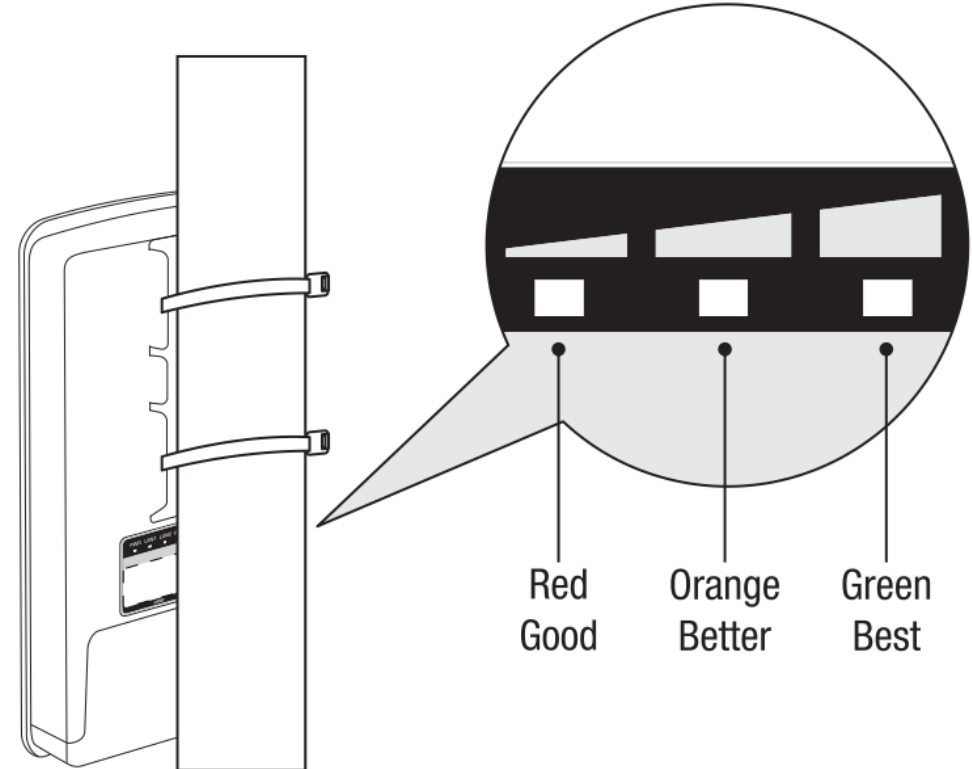

4. After the access points are properly mounted RJ-45 cables from each access point PoE injector to your network.

**Completed Installation Reference**

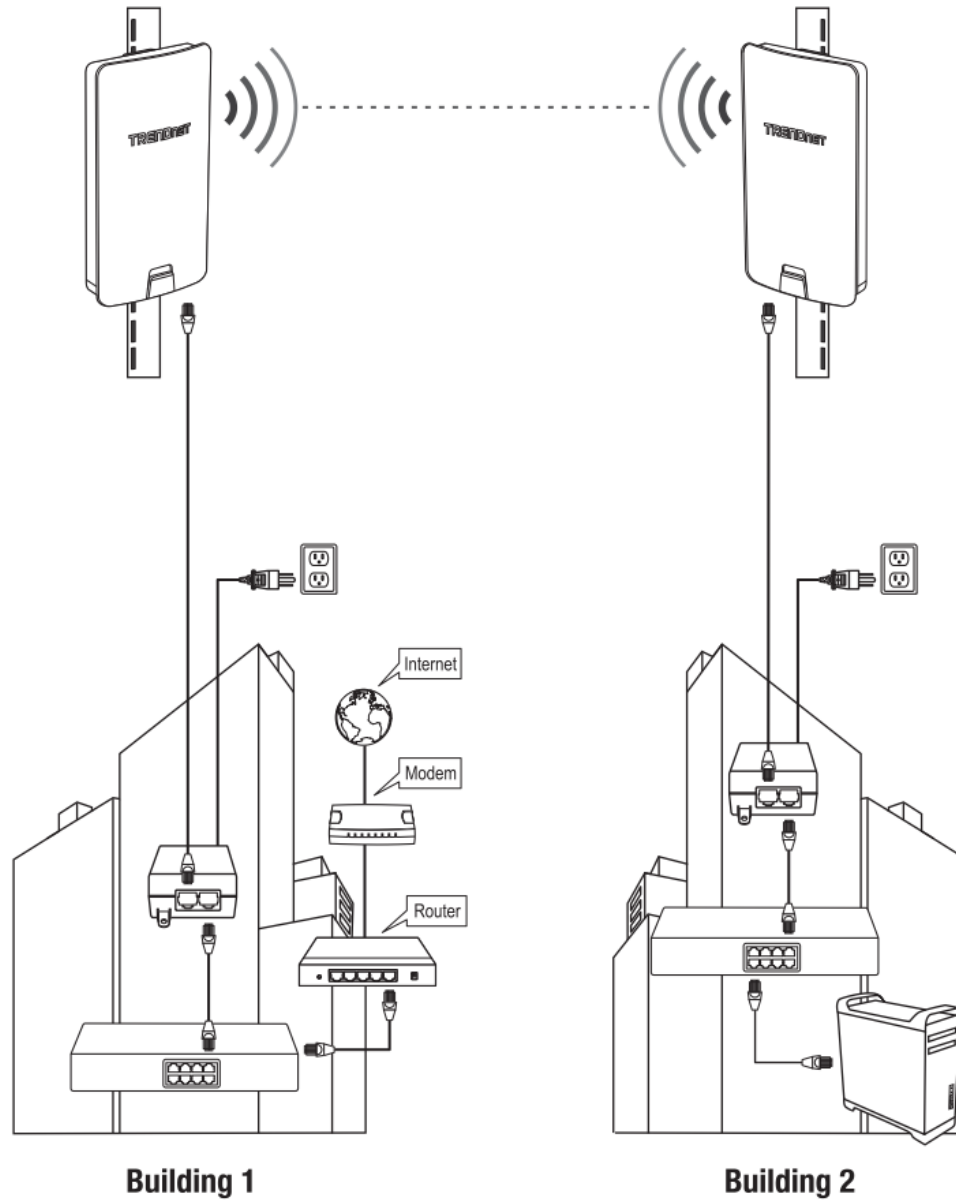

## TEW-840APBO2K Setup and Installation

When purchasing the point-to-point bridge kit, mode **TEW-840ABPO2K**, by default, the TEW-840APBO access points are preconfigured to establish a point-to-point wireless connection using **TDMA** channel access method in **WDS Access Point/Station**. For convenience, a unique predefined admin password has already been assigned to both access points. You can find the preconfigured access point settings on the wireless sticker or on the device label on the back of the unit. No additional configuration is required.

### Unit 1

**Preset  
Wireless Settings**

---

*Mode/WiFi Channel*

---

*AES Encryption Key*  
XXXXXXXXXX

---

*Management Login*  
http://192.168.10.50  
username: admin  
password: XXXXXXXX

### Unit 2

**Preset  
Wireless Settings**

---

*Mode/WiFi Channel*

---

*AES Encryption Key*  
XXXXXXXXXX

---

*Management Login*  
http://192.168.10.51  
username: admin  
password: XXXXXXXX

On the device label located inside, you can also find the preconfigured default settings of each access point.

### Unit 1

**AP1**

Model: TEW-840APBO /A  
 IP Address: 192.168.10.50  
 Subnet Mask: 255.255.255.0  
 User Name: admin  
 Password: XXXXXXXX  
 AP1 Mode: WDS AP  
 AP1 SSID: TRENDnet840\_XXXX  
 AP1 WPA2 Key: 840XXXXXXXXX  
 Default Channel: 48

### Unit 2

**AP2**

Model: TEW-840APBO /A  
 IP Address: 192.168.10.51  
 Subnet Mask: 255.255.255.0  
 User Name: admin  
 Password: XXXXXXXX  
 AP2 Mode: WDS Station  
 AP1 SSID: TRENDnet840\_XXXX  
 AP1 WPA2 Key: 840XXXXXXXXX  
 Default Channel: 48

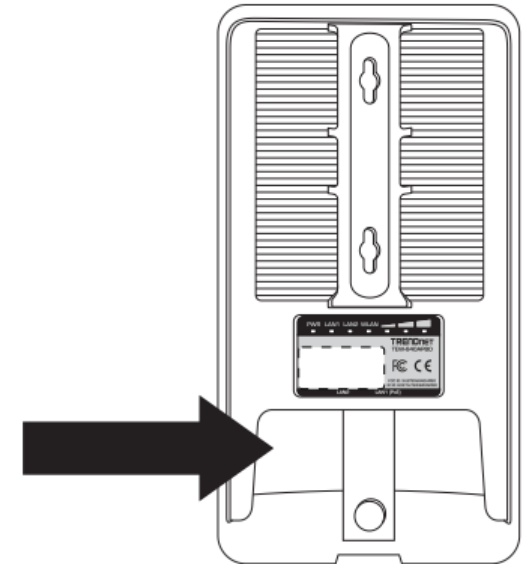

The TEW-840APBO access points will be preconfigured with the following settings:

	TEW-840APBO #1	TEW-840APBO #2
IP Address	192.168.10.50	192.168.10.51
Netmask (Subnet Mask)	255.255.255.0	255.255.255.0
IP Gateway (Default Gateway)	192.168.10.1	192.168.10.1
Primary DNS	192.168.10.1	192.168.10.1
Wireless Channel (Default)	48	48
Channel Access Method	TDMA	TDMA
Mode	WDS Access Point	WDS Station
WDS Encryption	WPA2	WPA2

## Setup and Confirm Connectivity

1. Remove the cover of the access points by pulling and holding the tab outwards (as shown in the picture below) and sliding the cover downwards, away from the access point.

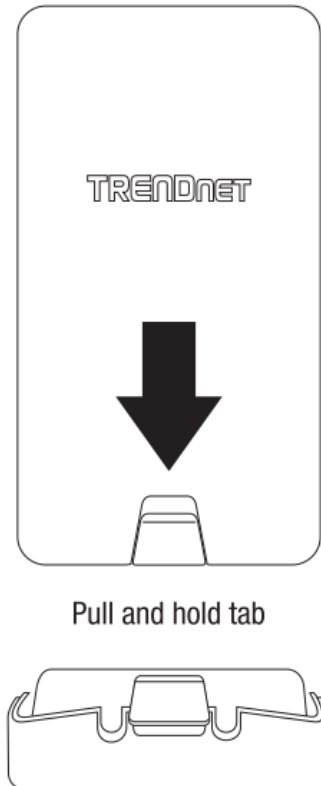

2. Using a RJ-45 network cable, connect one end of the cable to the **LAN1 (PoE)** port and ensure the cable is lined up with the Cable Guides before closing the cover. **(note: this RJ-45 network cable cannot exceed 60m)**

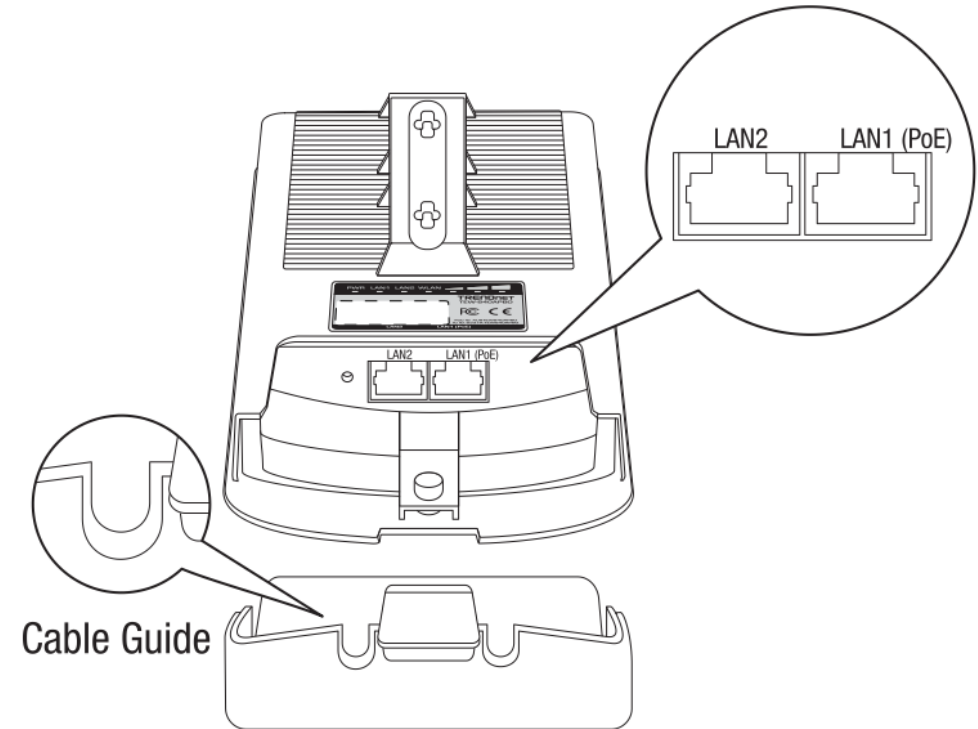

3. Connect the other end of the RJ-45 network cable to the **PoE** port on the included PoE injector. **(note: this RJ-45 network cable cannot exceed 60m)**
4. Using another RJ-45 network cable, connect one end to the **LAN** port on the included PoE injector.
5. Connect the other end of the RJ-45 network cable to your computer's Ethernet port.
6. Attach the power cord to the PoE injector and plug the connected power cord into a power outlet.

7. Confirm the device is powered on through the LED indicators.

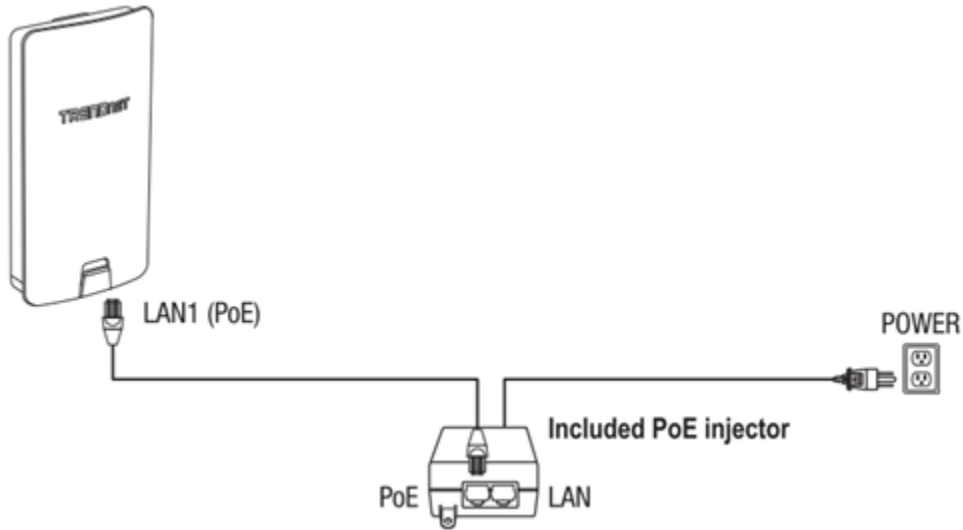

**Note:** Repeat steps 1-7 to power on and connect the second access point.

8. Assign a static IP address to your computer's network adapter in the subnet of 192.168.10.x (e.g. 192.168.10.10) and subnet mask of 255.255.255.0.

**Note:** For information on how to statically assign your IP address, see the Appendix section.

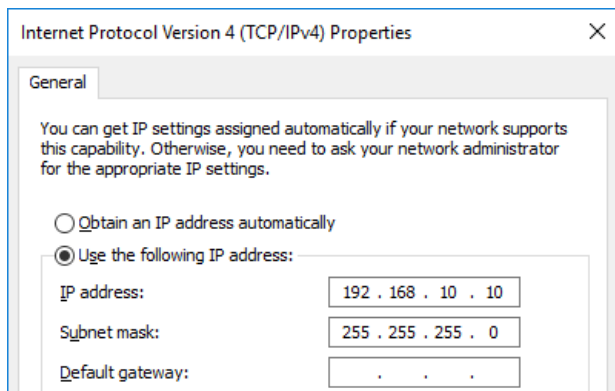

9. Using another network cable, connect one end to the LAN port on the included PoE injector for either the first or second access point.

10. Connect the other end of the network cable to your computer's Ethernet port.

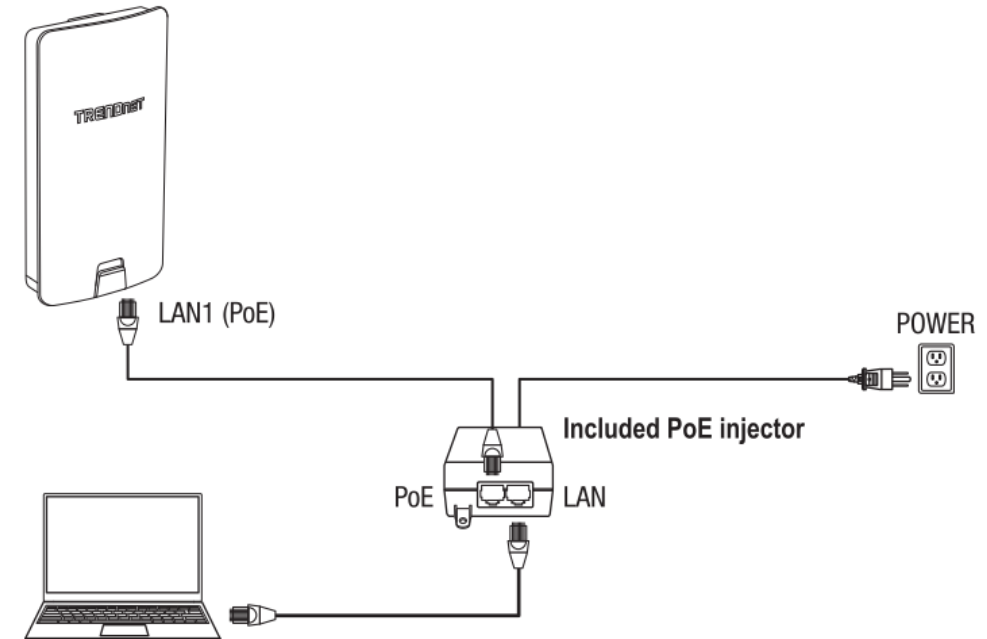



11. Make sure both access points are powered on approximately 15 ft. (5 m) apart from one another with front of access points directly facing each other.

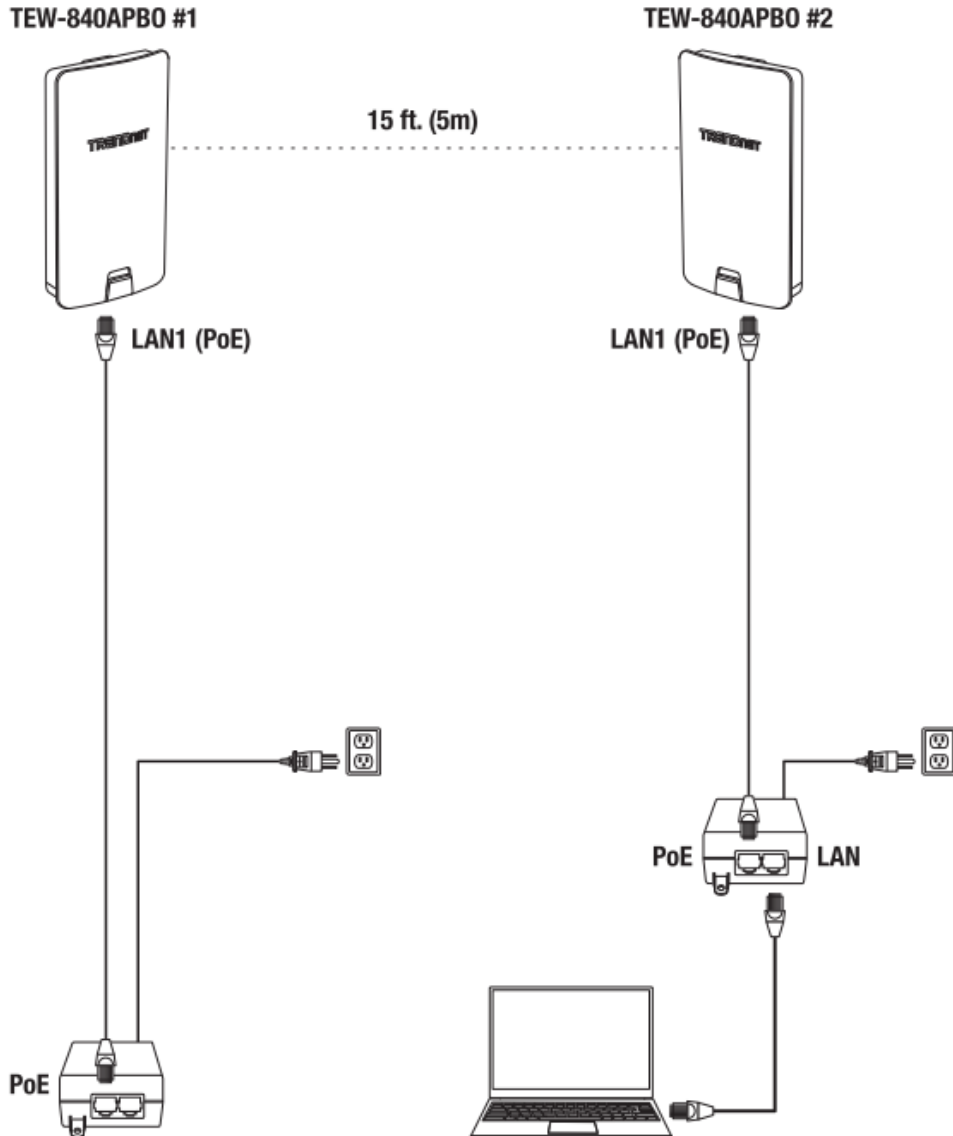

12. To verify connectivity on your computer, open a command prompt or terminal application window and type in the following commands.

- `ping 192.168.10.50`
- `<Press Enter and wait for result>`
- `ping 192.168.10.51`
- `<Press Enter and wait for result>`

**Note:** In Windows®, you can use the Command Prompt application and in Mac®, you can use the Terminal application to run the commands for connectivity testing.

A successful connectivity test will appear similar to the result below for each access point. Ping replies and 0% packet loss will indicate a successful point to point bridge connection between the two access points.

```
C:\WINDOWS\system32>ping 192.168.10.50

Pinging 192.168.10.50 with 32 bytes of data:
Reply from 192.168.10.50: bytes=32 time<1ms TTL=64
Reply from 192.168.10.50: bytes=32 time<1ms TTL=64
Reply from 192.168.10.50: bytes=32 time=1ms TTL=64
Reply from 192.168.10.50: bytes=32 time<1ms TTL=64

Ping statistics for 192.168.10.50:
    Packets: Sent = 4, Received = 4, Lost = 0 (0% loss),
    Approximate round trip times in milli-seconds:
        Minimum = 0ms, Maximum = 1ms, Average = 0ms

C:\WINDOWS\system32>ping 192.168.10.51

Pinging 192.168.10.51 with 32 bytes of data:
Reply from 192.168.10.51: bytes=32 time=2ms TTL=64
Reply from 192.168.10.51: bytes=32 time=3ms TTL=64
Reply from 192.168.10.51: bytes=32 time=2ms TTL=64
Reply from 192.168.10.51: bytes=32 time=5ms TTL=64

Ping statistics for 192.168.10.51:
    Packets: Sent = 4, Received = 4, Lost = 0 (0% loss),
    Approximate round trip times in milli-seconds:
        Minimum = 2ms, Maximum = 5ms, Average = 3ms
```

**Note:** If the connectivity test fails, wait for about 1 minute and try again. Make sure there are no obstacles between two access points and that they are not too close together.

## Pole Mount Installation

1. Reinstall the cover by lining up the guides into the notches as shown and push until the cover clips into place and is secured. The cover includes cable openings to route the connected Ethernet cable(s) when installing.

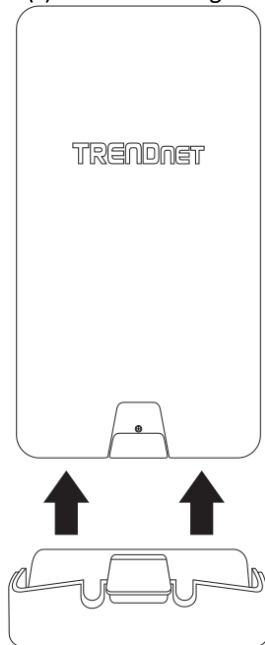

2. Insert the included fasteners through the holes located at the back of the access point.

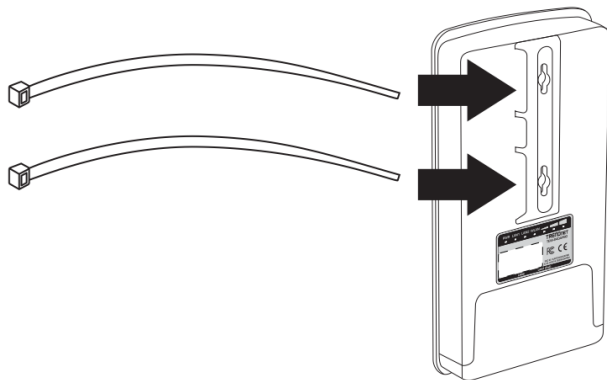

3. Wrap the fasteners around the pole where the access point will be installed. On the fasteners, insert the open end into the locking mechanism and pull tight until the point is secured.

**Note:** When set to **WDS station** mode, the TEW-840APBO features WiFi signal strength connectivity LEDs located on the back of the access point to assist in determining the optimal mounting position. (Red = Good, Orange = Better, Green = Best)

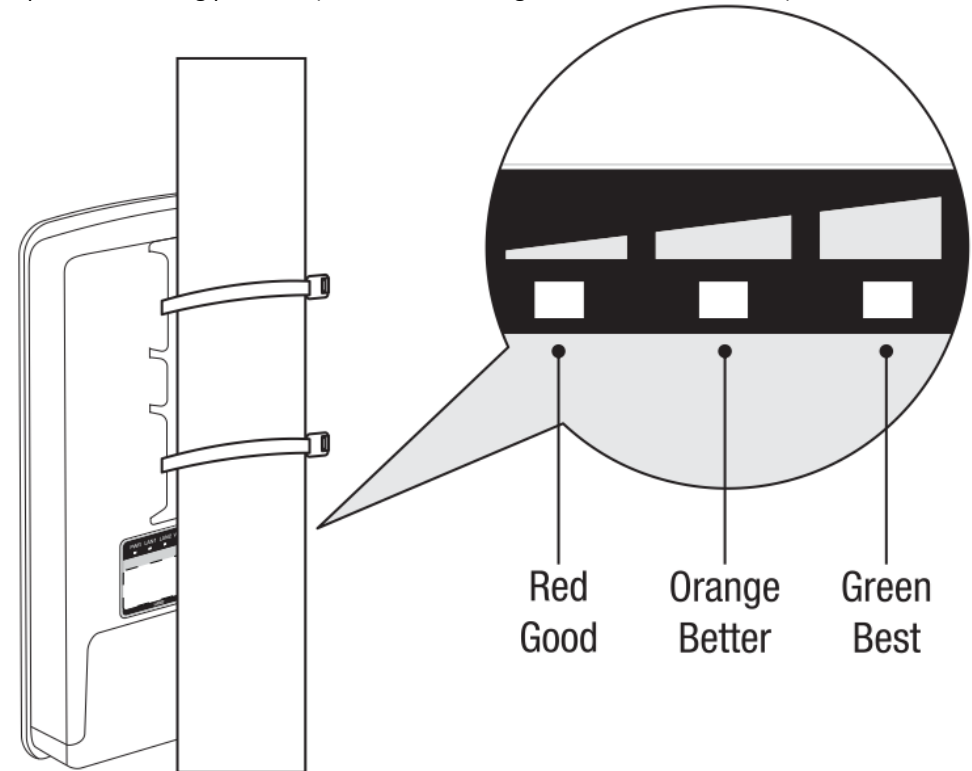

4. After the access points are properly mounted RJ-45 cables from each access point PoE injector to your network.

**Completed Installation Reference**

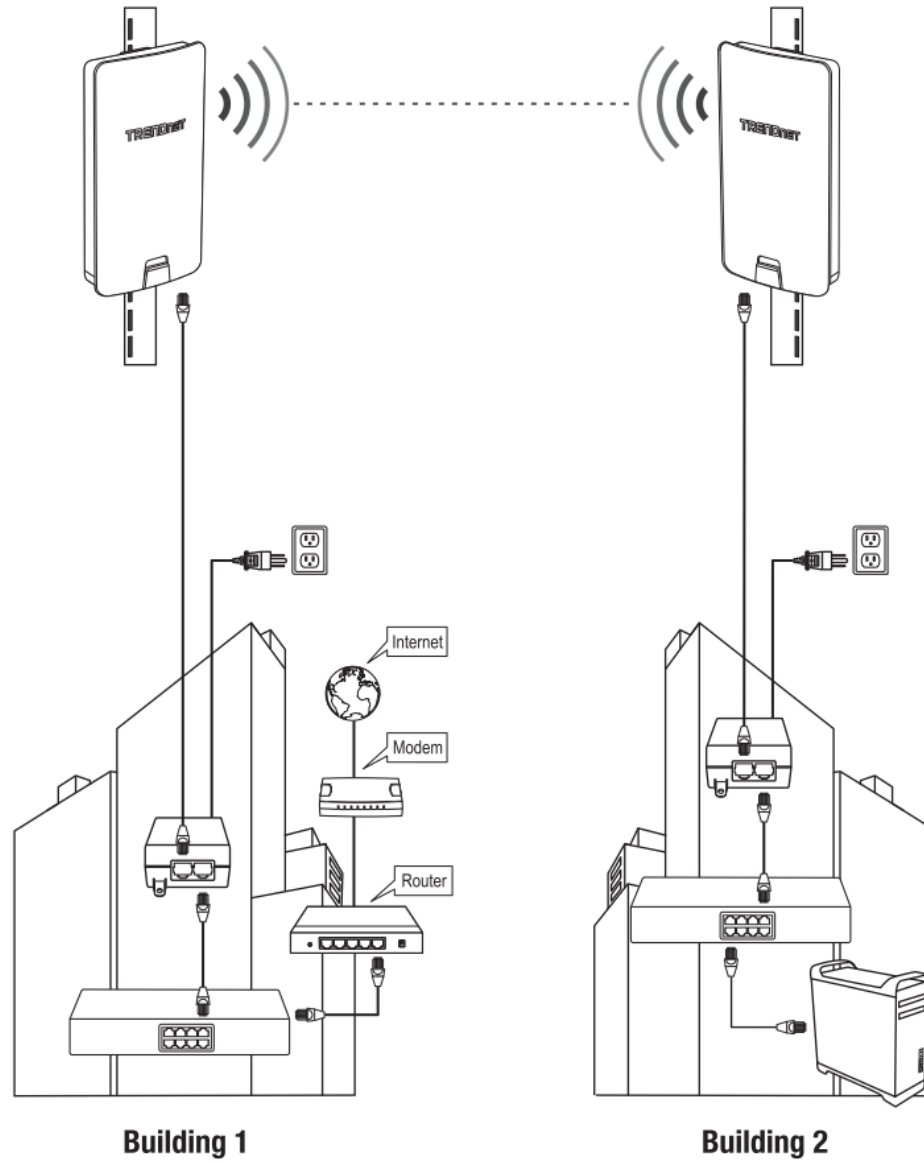

## Channel Access Method

In wireless networking, **Channel Access Method**, or **Multiple Access Method**, refers to the method used to enable simultaneous isolated communications between multiple devices all sharing the same “communication medium” of wireless radio airspace. TRENDnet's **TEW-840APBO** and **TEW-840APBO2K** support two methods of channel access: **Carrier-Sense Multiple Access with Collision Avoidance (CSMA/CA)**, shortened to just **CSMA**) and **Time-Division Multiple Access (TDMA)**.

The different methods can be found under **Network > Wireless > Channel Access Mode** in the access point web management page.

### Carrier-Sense Multiple Access with Collision Avoidance (CSMA/CA)

**CSMA/CA** (Carrier Sense Multiple Access with Collision Avoidance) is the standard access mode used in 802.11 networks and is used for both access points and client device/station connectivity.

Due to allowing connections without any beacon packets and synchronization, CSMA/CA is better suited for environments with several networks in parallel.

Consequently, due to an increase in interference and energy consumption, CSMA/CA causes higher collision rates and decreases network throughput in a dense network when compared with TDMA. Retransmissions resulting from collisions are another factor in terms of network throughput and energy consumption.

- Industry standard.
- Simple, distributed, burden-less channel access method.
- Allows for fair sharing of network resources between contending nodes, at the cost of optimal quality of service and a guaranteed balance – especially when quantity of contending nodes increases.
- **Example:** IEEE 802.11 WiFi

### Time-Division Multiple Access (TDMA)

**TDMA** (Time Division Multiple Access) is a proprietary access method that can provide significant benefits in performance and capacity in 802.11 point-to-point and point-to-multipoint bridge applications between wireless access points.

Through the use of dynamic time slot allocation to client/station access points, TDMA can eliminate data collisions and manage airtime more efficiently for active and inactive client/station access points when compared to the conventional CSMA.

Consequently, due to the very precise duty cycling requiring each sensor to wait their respective turn before communicating, TDMA has an increased communication delay when the network traffic is low when compared to CSMA/CA. Additionally, TDMA is unable to avoid inter-network interference as well as CSMA is.

- Proprietary
- Centralized, scheduled, managed, planned channel access method.
- Guarantees your target quality of service and balanced network shares among all your nodes, at the cost of inter-network interference from other networks running in parallel.
- **Example:** **TEW-840APBO2K**

## Application Modes

Although the access point is intended to be used for primarily WDS point-to-point bridging, the access point offers other operating modes. The access point multiple mode system which can be configured either in client bridge mode or as an access point. It also can be used as a WDS (Wireless Distribution System) link for Ethernet network expansion. This section explains the different modes the device has available, **Access Point (AP)**, **Client Bridge**, **WDS Access Point**, **WDS Station**, and **WDS Bridge (CSMA only)**.

The different operation modes can be found under **Network > Wireless > Operation Mode** in the access point web management page.

### Access Point (AP)

An **access point** can be either a main, relay or remote base station. A main base station is typically connected to a wired network via an Ethernet port. A relay base station relays data between main base stations and relay stations or remote base stations with clients. A remote base station is the end point to accept connections from wireless clients and pass data upstream to a network wirelessly.

#### Example: Access Point

- It can be deployed as a traditional fixed wireless access point.

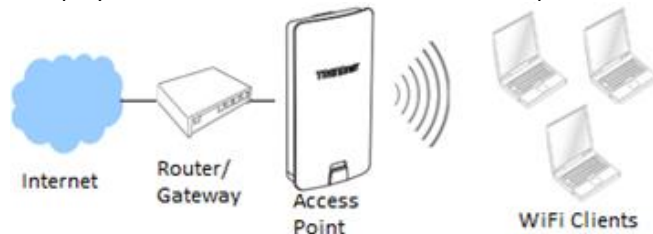

### Client Bridge

**Client bridge** mode enables the device to essentially act as a wireless client while bridging the LAN ports on the device. In this mode, the AP functions similarly to that of a wireless client or station such as mobile phone, tablet, or notebook computer. The wired ports LAN1 (PoE) and LAN2 are logically bridged to the wireless interface. The wired clients of access point are in the same subnet from Main Base.

#### Example: AP with Client Bridge mode

- It can be deployed as a wireless client (with wired LAN) to a wireless access point.

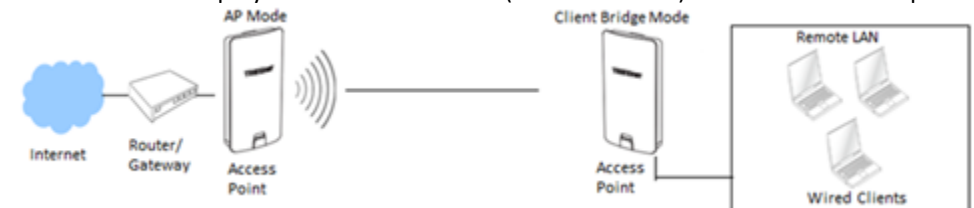

## WDS Access Point (WiFi Distribution System)

**WDS Access Point mode** (also known as **WDS AP + Client Bridge mode**) allows the unit to broadcast a publically visible WiFi Network with a WDS backbone simultaneously bridged to another WDS AP or WDS Bridge. With ports LAN1 (PoE) and LAN2 logically bridged to the wireless interface, allowing the wired and wireless clients of access point to be in the same subnet from Main Base Station.

**Note:** Each TEW-840APBO in WDS Access Point mode can establish a WDS network with up to **4 other** access points.

### Example: 2x WDS Access Point

- It can be deployed as a traditional fixed wireless access point and establish WDS bridging to an upstream access point to expand a network.

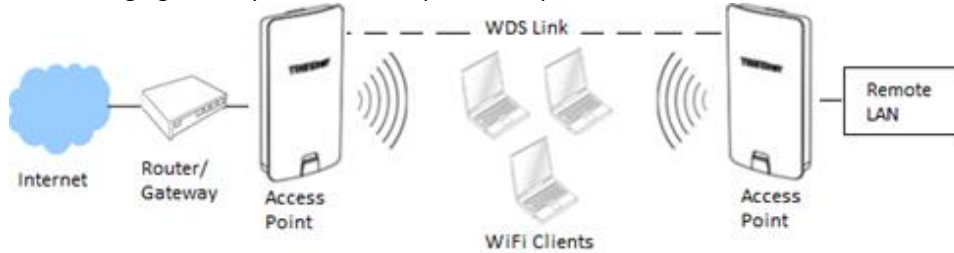

## WDS Station

In **WDS Station mode** (also known as **WDS Client Bridge mode**), the device acts as a client to any standard wireless connection with ports LAN1 (PoE) and LAN2 logically bridged to the wireless interface, allowing the wired clients of the device to be in the same subnet from Main Base Station. The main advantage of WDS Station compared to Client Bridge mode is WDS station additionally ensures the integrity of WDS link in terms of MAC address transparency, allowing for daisy chained networking. Each WDS AP can sustain as many WDS Station connections as needed due to the WDS Stations not needing WDS Link Settings and are not limited by MAC addresses in WDS Link protocols.

### Example: WDS Access Point with 2 WDS Stations

- It can be deployed as a WDS Station bridging to an upstream access point to expand a network. Due to the MAC transparency and no maximum number of WDS Links, it can be daisy-chained and also support point-to-multipoint installations.

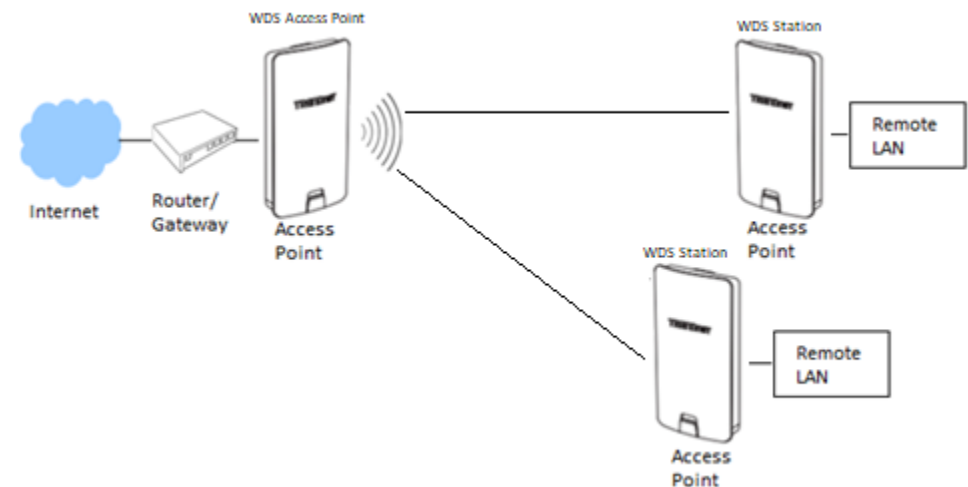

## WDS Bridge *(CSMA ONLY)*

This is the primary application mode for WDS connections within the networking industry. The built-in high gain directional antenna makes this access point an ideal solution for establishing a single WDS point-to-point wireless bridge or link between two physical locations that are a great distance from one another.

**Note:** Each TEW-840APBO in WDS Bridge mode can establish a WDS network with up to **8 other** access points.

### Example 1: Point-to-Point



### Example 2 : Point-to-Multi-Point

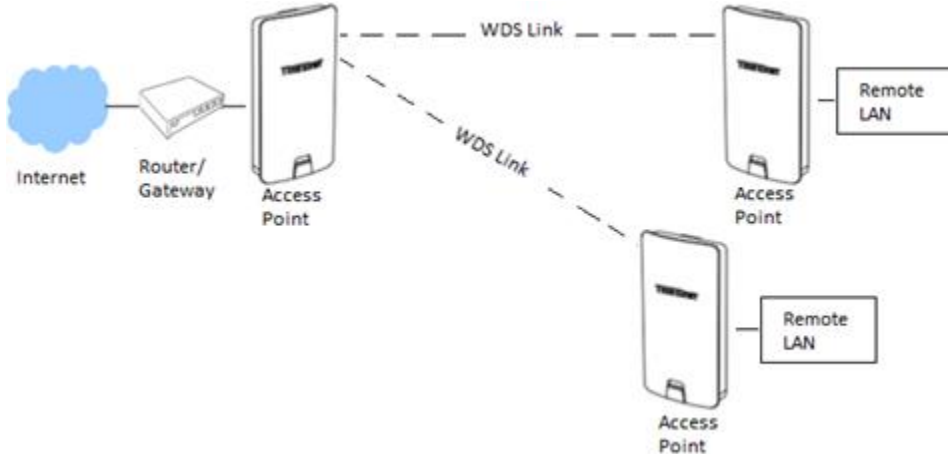



## Accessing your access point management page

### Access your access point management page

**Note:** TEW-840APBO Users: Your access point management page default IP address <http://192.168.10.100> is accessed through the use of your Internet web browser (e.g. Internet Explorer®, Firefox®, Chrome™, Safari®, and Opera™) and will be referenced frequently in this User's Guide.

TEW-840APBO2K Users: Your access point management page default IP addresses are <http://192.168.10.50> and <http://192.168.10.51>. Additionally, the pre-defined user name and password will be unique. This information will be printed on both the wireless settings stickers and device label located inside the access point enclosure.

#### Unit 1

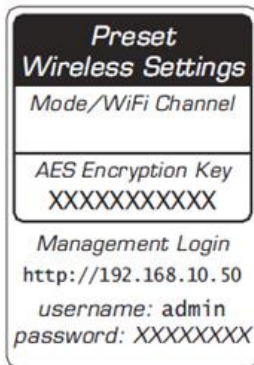

#### Unit 2

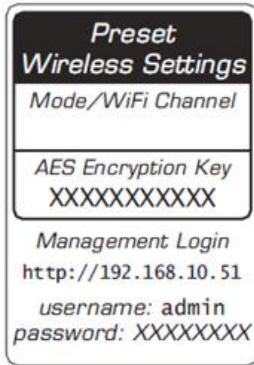

Model: TEW-840APBO /A  
 IP Address: 192.168.10.100  
 Subnet Mask: 255.255.255.0  
 User Name: admin  
 Password: admin  
 Mode: WDS AP  
 SSID: TRENDnet840\_XXXX  
 WPA2 Key: 840XXXXXXXXX  
 Default Channel: 48

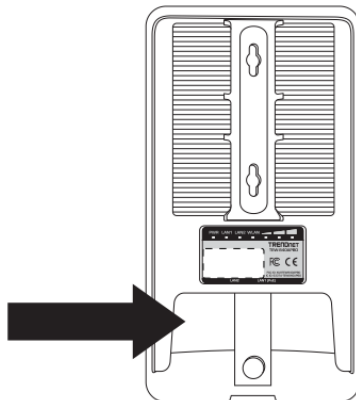

If you have changed the default IP address, you will need to ensure that your computer is configured with IP address settings in the same subnet as the as the access point in order to access the access point management page. Also, make sure your access point is powered on through the included PoE injector and your computer is connected to the gigabit DATA IN port on injector or connect to LAN2 Ethernet port. (Ex. Access Point IP address changed to 192.168.0.100 / 255.255.255.0, example computer address 192.168.0.25 / 255.255.255.0).

1. Open your web browser and go to the address <http://192.168.10.100> (TEW-840APBO) or <http://192.168.10.50> and <http://192.168.10.51> (TEW-840APBO2K). Your access point will prompt you for a user name and password.



2. TEW-840APBO Users: By default, the user name is *admin* and password is *admin*. TEW-840APBO2K Users: You can also find the wireless settings sticker included with the access points and on the device inside the access point enclosure. Enter your **Username** and **Password**, then click **Login**.

**Note:** If you have changed the password already such as in the Setup Wizard, you will need to login using the new password. User Name and Password are case sensitive.

## TRENDNET

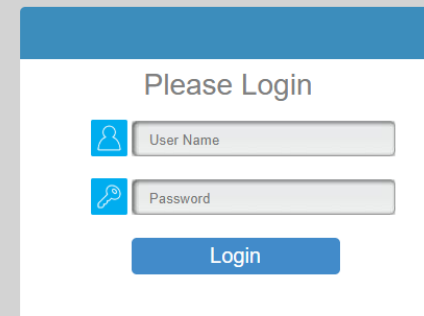

## Overview

### Device Status

Overview > Device Status

This page will display the AP system summary information such as the device name, serial number, system time, firmware version, MAC, IPv4/IPv6 address settings, WiFi information, etc.

1. Log into your access point management page (see "[Access your access point management page](#)" on page 29).
2. Click on **Device Status** from the left side menu. To refresh the page, click **Refresh** at the bottom of the page.

#### Device Information

- **Device Name** – Displays the identifying device name of your access point. This information can be modified under the **Network > Wireless** section.
- **Serial Number** – Displays the serial number assigned during manufacturing process.
- **MAC Address**– Displays the MAC address for both the access point's LAN and WLAN radio.
- **Country** – Displays the country of the access point
- **Current Local Time** – Displays the current time assigned to the access point. This information can be modified under the **Management > Time Zone** section.
- **Uptime** – Displays the time the access point has been powered on.
- **Firmware Version** – Displays the current firmware of the access point
- **Management VLAN ID** – Displays the currently VLAN ID status.

#### Device Information

Device Name	TEW-840APBO
Serial Number	EP9DKA8B1000194
MAC Address	
- LAN	3C:8C:F8:FD:B4:E4
- Wireless LAN - 5GHz	3C:8C:F8:FD:B4:E5
Country	USA
Current Local Time	Tue Sep 3 16:04:25 2019
Uptime	1d 23h 58m 11s
Firmware Version	v1.0.0.9
Management VLAN ID	Untagged

#### Memory Information

- This section displays the access point's memory or RAM usage status.

#### Memory Information

Total Available	76664 kB / 126316 kB (60%)
Free	44052 kB / 126316 kB (34%)
Cached	24436 kB / 126316 kB (19%)
Buffered	8176 kB / 126316 kB (6%)

#### LAN Information IPv4

- **IP Address** – Displays the IPv4 address assigned to the access point. This can be modified under the **Network > Basic** section.
- **Subnet Mask** – Displays the current IPv4 subnet mask assigned to your access point.
- **Gateway** – Displays the current gateway address assigned to your access point.
- **Primary DNS** – Displays the primary Domain Name Server (DNS) assigned to your access point.
- **Secondary DNS** – Displays the secondary Domain Name Server (DNS) assigned to your access point.
- **DHCP Client** – Displays the status of the DHCP client.
- **Spanning Tree Protocol (STP)** – Displays the status of the STP.

#### LAN Information - IPv4

IP Address	192.168.10.50
Subnet Mask	255.255.255.0
Gateway	192.168.10.1
Primary DNS	192.168.10.1
Secondary DNS	0.0.0.0
DHCP Client	Disable
Spanning Tree Protocol(STP)	Disable

**LAN Information IPv6**

- **IP Address** – Displays the IPv6 address assigned to the access point. This can be modified under the **Network > Basic** section.
- **Link-Local Address** – Displays the current Link-Local address and prefix length assigned to your access point.
- **Gateway** – Displays the current gateway address assigned to your access point.
- **Primary DNS** – Displays the primary Domain Name Server (DNS) assigned to your access point.
- **Secondary DNS** – Displays the secondary Domain Name Server (DNS) assigned to your access point.

**LAN Information - IPv6**

IP Address	2600:8802:6700:b74:3e8c:f8ff:fedd:b4e4
Link-Local Address	fe80::3e8c:f8ff:fedd:b4e4
Gateway	fe80::3e8c:f8ff:fef3:85b6
Primary DNS	N/A
Secondary DNS	N/A

**Wireless LAN Information – 5GHz**

- **Operation Mode** – Displays the operation mode that the access point is currently set.
- **Wireless Mode** – Displays the IEEE 802.11 protocol the access point's wireless radio is broadcasting on.
- **Channel Bandwidth** – Displays the bandwidth (in MHz) that the access point's radio is using
- **Channel** – Displays the channel that the 5GHz radio is using.
- The table below displays the Profile #, SSID, Security, VID, and 802.1Q status of all radios currently being broadcasted.

**Wireless LAN Information - 5GHz**

Operation Mode	WDS Access Point			
Wireless Mode	802.11 N/AC			
Channel Bandwidth	80 MHz			
Channel	5.240 GHz(Channel 48)			
Profile	SSID	Security	VID	802.1Q
#1	TRENDnet840_B4E5	WPA2/PSK AES	51	Disable
#2	TRENDnet840_B4E5_8	WPA2/PSK AES	58	Disable

**Statistics**

- Displays the data usage (RX, TX) of each interface, and their respective SSIDs.

**Statistics**

SSID	MAC	RX(Packets)	TX(Packets)
Ethernet	3C:8C:F8:FD:B4:E4	34.13 MB(336768 Pkts.)	43.29 MB(189709 Pkts.)
TRENDnet840_B4E5_8	3C:8C:F8:FD:B4:E5	0.00 B(0 Pkts.)	33.92 MB(293371 Pkts.)
TRENDnet840_B4E5	42:8C:F8:FD:B4:E5	41.72 MB(189709 Pkts.)	41.44 MB(382650 Pkts.)

3. Click **Refresh** at the bottom of the page to refresh the page.



## Connections

Overview > Connections

This page will display all active connections that have been established with the access point.

1. Log into your access point management page (see "[Access your access point management page](#)" on page 29).
2. Click on **Connections** from the left side menu. To **Kick** a client connection, click Kick to the right of the listing. To refresh the page, click **Refresh** at the bottom of the page.
  - **WDS Link List** – Displays connections established using **WDS Bridge only**.
  - **Connection List** – Display all other wireless connections.

**Note:** WDS Link will only populate when the access point is in CSMA/CA and using WDS Bridge. For more information, please see "[Channel Access Method](#)" on page 25.

### WDS Link List - 5GHz

WDS Link ID#	MAC Address	Link Status	RSSI(dBm)
--------------	-------------	-------------	-----------

### Connection List - 5GHz

SSID	MAC Address	TX	RX	RSSI	Block
TRENDnet840_B4E5	3c:8c:f8:fd:b4:e7	42 KB	32 KB	-44dBm	<a href="#">Kick</a>

## Real-time

Overview > Real-time

This page displays CPU Load and Traffic utilization of the access point in Real-time.

1. Log into your access point management page (see "[Access your access point management page](#)" on page 29).
2. Click on **Real-time** from the left side menu.
  - **Load** – Displays the CPU usage %.
  - **Traffic** – Display the traffic data broken down per configured interface of the access point.

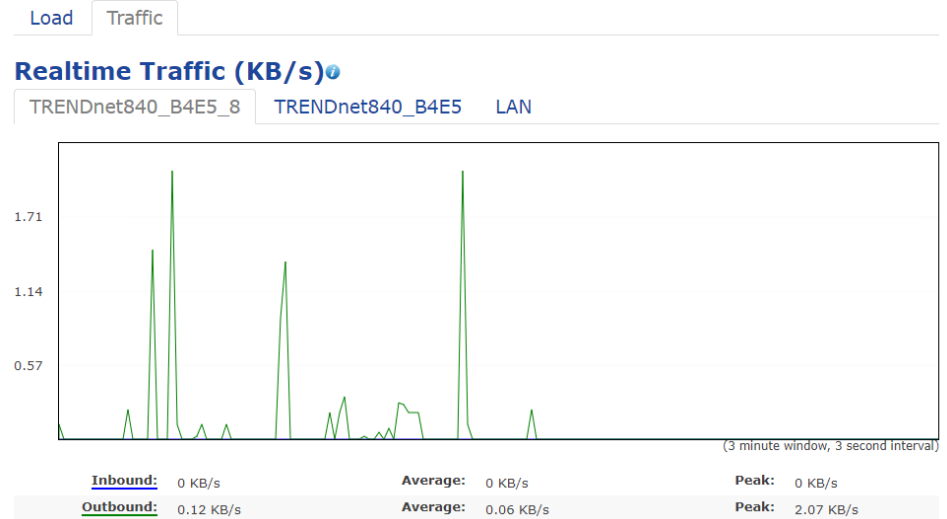

## Network

### Basic

Network > Basic

This page allows configuration of the access point's IPv4, IPv6, and Spanning Tree Protocol settings.

1. Log into your access point management page (see "[Access your access point management page](#)" on page 29).
2. Click on **Basic** under **Network** from the left side menu. Please note, when clicking **Save**, the settings are saved but not applied yet.

#### IPv4 Settings

- **IP Network Setting** – Select either **DHCP** or **Static IP**. *Default: Static*
- **IP Address** – Enter the desired IPv4 address if above setting is set to static IP.
- **Subnet Mask** – Enter the desired IPv4 subnet mask.
- **Gateway** – Enter the desired IPv4 Gateway.
- **Primary DNS** – Enter the desired primary Domain Name Server (DNS).
- **Secondary DNS** – Enter the desired secondary Domain Name Server (DNS).

##### IPv4 Settings

IP Network Setting	<input type="radio"/> DHCP <input checked="" type="radio"/> Static IP
IP Address	<input type="text" value="192.168.10.50"/>
Subnet Mask	<input type="text" value="255.255.255.0"/>
Gateway	<input type="text" value="192.168.10.1"/>
Primary DNS	<input type="text" value="192.168.10.1"/>
Secondary DNS	<input type="text" value="0.0.0.0"/>

#### IPv6 Settings

- **Link-local Address** – Check the box to enable IPv6 Link-local Address setting.
- **IP Address** – Enter the desired IPv6 address.
- **Subnet Prefix Length** – Enter the desired IPv6 subnet prefix length.
- **Gateway** – Enter the desired IPv6 Gateway.
- **Primary DNS** – Enter the desired primary Domain Name Server (DNS).
- **Secondary DNS** – Enter the desired secondary Domain Name Server (DNS).

<b>IPv6 Settings</b>	<input checked="" type="checkbox"/> <b>Link-local Address</b>
IP Address	<input type="text"/>
Subnet Prefix Length	<input type="text"/>
Gateway	<input type="text"/>
Primary DNS	<input type="text"/>
Secondary DNS	<input type="text"/>

#### Spanning Tree Protocol (STP) Settings

- **Status** – Select either to **Enable** or **Disable** STP. *Default: Disabled*
- **Hello Time** – Enter the desired hello time (in seconds)
- **Max Age** – Enter the desired max age (in seconds).
- **Forward Delay** – Enter the desired forward delay (in seconds).
- **Priority** – Enter the desired priority of this STP configuration.



##### Spanning Tree Protocol (STP) Settings

Status	<input type="radio"/> Enable <input checked="" type="radio"/> Disable
Hello Time	<input type="text" value="2"/> seconds (1-10)
Max Age	<input type="text" value="20"/> seconds (6-40)
Forward Delay	<input type="text" value="15"/> seconds (4-30)
Priority	<input type="text" value="32768"/> (0-65535)

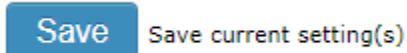
- Click **Save** at the bottom of the page to save your settings.

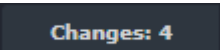

## MAKE SURE THE CHANGES TO THE CONFIGURATIONS ARE APPLIED

- Click **Changes**  from the top right menu bar, and click **Apply** .

OR

- Click **Apply**  on the bottom right of any page:

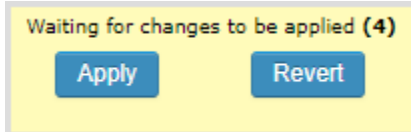

## Wireless

*Network > Wireless*

This page allows configuration of all wireless settings of the access point.

For more information on the differences between the modes, see "[Channel Access Method](#)" on page 25 and "[Application Mode](#)" on page 26.

- Log into your access point management page (see "[Access your access point management page](#)" on page 29).
- Click on **Wireless** under **Network** from the left side menu. Please note, when clicking **Save**, the settings are saved but not applied yet.

### Wireless Settings

- Device Name** – Enter the desired name for this device. If changing the name.

Wireless Settings

Device Name

### Channel Access Mode

- Select **CSMA (Traditional)** or **TDMA** for the channel access mode.
- TDMA**, proprietary, only works with **TEW-840APBO** for WDS bridging.
- CSMA** compatible with industry standards.
- For more information, see "[Channel Access Method](#)" on page 25.

Channel Access Mode 

CSMA(Traditional)

TDMA

5GHz-802.11AC/N

**Note:** The following section will have different options bases on chosen Channel Access Mode and Operation Mode of the access point.

The following example screenshot is of **CSMA** in **Access Point** mode.

5GHz -802.11 AC/N	
Operation Mode	Access Point ▼
Channel HT Mode	80MHz(AC Only) ▼
Channel	<b>Configuration</b>
Transmit Power	Auto ▼
Bit Rate ⓘ	<b>Configuration</b>
Client Limits ⓘ	127 <input checked="" type="radio"/> Enable <input type="radio"/> Disable
AP Detection	<b>Scan</b>
Distance (0-10km)	1 (0.6miles)
AP Time Slot ⓘ	Auto ▼
Station Priority ⓘ	High ▼

- **Operation Mode** – Select the desired operation mode from the drop down, **Access Point**, **Client Bridge**, **WDS Access Point**, **WDS Station**, or **WDS Bridge (CSMA only)**. For more information, see “[Application Mode](#)” on page 26.
- **Channel HT Mode** – Select the desired channel HT mode from the dropdown; **80MHz (AC Only)**, **40MHz**, or **20MHz**.
- **Channel** – Click **Configuration**, and select the channel from the pop-up window. **GREY options are selected, and BLUE options are not selected**. Click **Save** to save the channel, and switch back **\*\*if the pop-up window does not appear, please disable the browser's ad/pop-up blocker\*\***

5GHz

All	None
U-NII-1	U-NII-3
Ch 36 : 5.180 GHz	Ch 40 : 5.200 GHz
Ch 44 : 5.220 GHz	Ch 48 : 5.240 GHz
Ch149 : 5.745 GHz	Ch153 : 5.765 GHz
Ch157 : 5.785 GHz	Ch161 : 5.805 GHz

**Save** Save current setting(s)

- **Transmit Power** – Select the desired transmit power from the dropdown.
- **Bit Rate** – Click **Configuration**, and select the bitrate using the slider in the pop-up window. **\*\*if the pop-up window does not appear, please disable the browser's ad/pop-up blocker\*\***

5GHz

Minimum bitrate (Mbps)

Lower Data Rate Higher Data Rate

**Save** Save current setting(s)

- **Client Limits (CSMA Access Point Mode only)**– Enter the desired number of maximum clients and select **Enable/Disable**
- **AP Detection** – Click **Scan** to commence a network site survey of the surrounding access points.
- **Distance** – Enter in the distance (0-10 in km) between the access points. The equivalent distance measured in miles is to the right of the field for your convenience.
- **AP Time Slot** – In **TDMA** mode, the access point will assign time slots for each client's data transmission. The higher the value, the faster the data transmission.
- **Station Priority** – In **TDMA** mode, the client bridge/WDS station's data transmission is prioritized by data. A higher level means a longer transmission time. (the time ratio is 10:5:1 for High:Medium:Low)



**Wireless Settings – 5GHz**

**Note:** The following section will have different options bases on chosen Channel Access Mode and Operation Mode of the access point. Not all menu options will apply.

**For Access Point and WDS Access Point modes:**

- **Enabled** – Check the box to **enable** this wireless radio. Deselected box indicates radio is off.
- **SSID** – The SSID of the radio.
- **Edit** – To edit the SSID settings, click **Edit**. *\*\*if the pop-up window does not appear, please disable the browser's ad/pop-up blocker\*\**
- **Security** – Displays the security type assigned to this SSID.
- **Hidden SSID** – Check the box to hide this SSID name from broadcasting.
- **Client Isolation** – Check the box to block communication between associated clients under the same WLAN.
- **VLAN Isolation** – When this option is selected with a specified VLAN ID in the SSID profile, all traffic associated with this SSID will be tagged with this VLAN ID upon entering the LAN Bridge.
- **L2 Isolation** – Check the box to isolate on a layer-2 basis.

Wireless Settings - 5GHz

Enabled	SSID	Edit	Security	Hidden SSID	Client Isolation	VLAN Isolation	L2 Isolation	VLAN ID
<input checked="" type="checkbox"/>	TRENDnet840_B4E5	<a href="#">Edit</a>	WPA2/PSK AES	<input type="checkbox"/>	<input type="checkbox"/>	<input type="checkbox"/>	<input type="checkbox"/>	51
<input type="checkbox"/>	TRENDnet840_B4E5_2	<a href="#">Edit</a>	None	<input type="checkbox"/>	<input type="checkbox"/>	<input type="checkbox"/>	<input type="checkbox"/>	52
<input type="checkbox"/>	TRENDnet840_B4E5_3	<a href="#">Edit</a>	None	<input type="checkbox"/>	<input type="checkbox"/>	<input type="checkbox"/>	<input type="checkbox"/>	53
<input type="checkbox"/>	TRENDnet840_B4E5_4	<a href="#">Edit</a>	None	<input type="checkbox"/>	<input type="checkbox"/>	<input type="checkbox"/>	<input type="checkbox"/>	54
<input type="checkbox"/>	TRENDnet840_B4E5_5	<a href="#">Edit</a>	None	<input type="checkbox"/>	<input type="checkbox"/>	<input type="checkbox"/>	<input type="checkbox"/>	55
<input type="checkbox"/>	TRENDnet840_B4E5_6	<a href="#">Edit</a>	None	<input type="checkbox"/>	<input type="checkbox"/>	<input type="checkbox"/>	<input type="checkbox"/>	56
<input type="checkbox"/>	TRENDnet840_B4E5_7	<a href="#">Edit</a>	None	<input type="checkbox"/>	<input type="checkbox"/>	<input type="checkbox"/>	<input type="checkbox"/>	57

**Note:** CSMA Access Point mode can have 8 radios, CSMA WDS Access Point can have 4, TDMA AP and WDS AP only can have 1.

**Management Interface (TDMA AP and WDS AP Only)**

- This interface is for wireless clients to wireless connect to and manage the AP when the AP is set to TDMA. A secondary wireless radio is required in order for standard 802.11 wireless devices to connect to it.

Clicking **Edit** from above, **Wireless Settings**.

- **Security Mode** – Select the mode from the dropdown menu.
- **Encryption** – Select the mode from the dropdown menu.
- **Passphrase** – Enter the Wi-Fi passphrase in this field.
- **Group Key Update Interval** – Enter the time between group key updates.
- **Fast Roaming** (access point mode only) – Check **Enable** to enable fast roaming.
- **Wireless MAC Filter** – Select from the ACL dropdown to allow or deny, and enter in the MAC Address.
- **Wireless Traffic Shaping** – Select **Enable** to enable this feature. Enter in the desired limits and then press **save**.

Wireless Security - 5GHz

Security Mode: WPA2-PSK

Encryption: AES

Passphrase: 840B1000194

Group Key Update Interval: 3600

Fast Roaming

Enable Fast Roaming:  Enable  Disable

Wireless MAC Filter

ACL Mode: Disabled

No. : : : : : : : [Add](#)

No. MAC Address

Wireless Traffic Shaping

Enable Traffic Shaping:  Enable  Disable

Download Limit: 100 Mbps (1-999)  Per User

Upload Limit: 100 Mbps (1-999)  Per User

[Save](#) Save current setting(s)

**Guest Network (CSMA AP and WDS AP Only)**

- **Enable** – Check the box to enable the Guest Network SSID.
- **SSID** – The SSID of the radio.
- **Edit** – To edit the SSID settings, click **Edit**. *\*\*if the pop-up window does not appear, please disable the browser's ad/pop-up blocker\*\* the edit menu is same as above, only missing the "Wireless Traffic Shaping" section.*
- **Security** – Displays the security type assigned to this SSID.
- **Hidden SSID** – Check the box to hide this SSID name from broadcasting.
- **Client Isolation** – Check the box to block communication between associated clients under the same WLAN
- **Manual IP Settings**
  - **IP Address** – Enter the IP address to assign as the "Gateway" for this guest SSID.
  - **Subnet Mask** – Enter the subnet mask for the "Gateway" for this guest SSID.
- **Automatic DHCP Server Settings**
  - **Starting IP Address** – Enter the starting IP address in the DHCP range to be assigned for this guest network.
  - **Ending IP Address** – Enter the starting IP address in the DHCP range to be assigned for this guest network.
  - **WINS Server IP** – Enter the IP address for the external WINS Server for name resolution.

Guest Network Settings

Enabled	SSID	Edit	Security	Hidden SSID	Client Isolation
<input checked="" type="checkbox"/>	TRENDnet840-5GHz_Gues	<a href="#">Edit</a>	None	<input type="checkbox"/>	<input checked="" type="checkbox"/>

Manual IP Settings

- IP Address	<input type="text" value="192.168.200.1"/>
- Subnet Mask	<input type="text" value="255.255.255.0"/>

Automatic DHCP Server Settings

- Starting IP Address	<input type="text" value="192.168.200.100"/>
- Ending IP Address	<input type="text" value="192.168.200.200"/>
- WINS Server IP	<input type="text" value="0.0.0.0"/>

**For Client Bridge and WDS Station modes:**

- **SSID** – Displays the SSID currently configured.
- **Edit** – Click **Edit** to modify settings. *\*\*if the pop-up window does not appear, please disable the browser's ad/pop-up blocker\*\**
  - **Preferred BSSID** - Enter the MAC address, or click device discovery.
  - **Wireless Security** – Select and enter in the security settings for the SSID you are trying to connect to.
  - **Save** – Click **Save** to return to the previous page.

Wireless Setting - 5GHz

Preferred BSSID  [Device Discovery](#)

SSID

---

Wireless Security - 5GHz

Security Mode

[Save](#) Save current setting(s)

**For CSMA WDS settings:**

**Note:** WDS Bridge supports up to 8 WDS links, WDS AP supports up to 4 WDS links.

- **Security** – Select and enter the security settings used for the WDS link.
- **MAC Address** – Enter the MAC address for the WDS link and select **Enable**.

WDS Link Settings - 5GHz

Security

WEP Key  40/64-bit(10 hex digits)

AES Passphrase  (8-63 ASCII characters or 64 hexadecimal digits)

MAC Address	Mode
<input type="text" value=""/> : <input type="text" value=""/> : <input type="text" value=""/> : <input type="text" value=""/> : <input type="text" value=""/> : <input type="text" value=""/>	<input type="text" value="Disable"/>
<input type="text" value=""/> : <input type="text" value=""/> : <input type="text" value=""/> : <input type="text" value=""/> : <input type="text" value=""/> : <input type="text" value=""/>	<input type="text" value="Disable"/>
<input type="text" value=""/> : <input type="text" value=""/> : <input type="text" value=""/> : <input type="text" value=""/> : <input type="text" value=""/> : <input type="text" value=""/>	<input type="text" value="Disable"/>
<input type="text" value=""/> : <input type="text" value=""/> : <input type="text" value=""/> : <input type="text" value=""/> : <input type="text" value=""/> : <input type="text" value=""/>	<input type="text" value="Disable"/>
<input type="text" value=""/> : <input type="text" value=""/> : <input type="text" value=""/> : <input type="text" value=""/> : <input type="text" value=""/> : <input type="text" value=""/>	<input type="text" value="Disable"/>
<input type="text" value=""/> : <input type="text" value=""/> : <input type="text" value=""/> : <input type="text" value=""/> : <input type="text" value=""/> : <input type="text" value=""/>	<input type="text" value="Disable"/>
<input type="text" value=""/> : <input type="text" value=""/> : <input type="text" value=""/> : <input type="text" value=""/> : <input type="text" value=""/> : <input type="text" value=""/>	<input type="text" value="Disable"/>
<input type="text" value=""/> : <input type="text" value=""/> : <input type="text" value=""/> : <input type="text" value=""/> : <input type="text" value=""/> : <input type="text" value=""/>	<input type="text" value="Disable"/>

**RSSI Threshold (CSMA Access Point Mode Only)**

- **Status** – Select **Enable** to enable the RSSI threshold feature.
- **RSSI** – Enter the RSSI threshold to trigger the AP to encourage the client to switch to another AP with a stronger signal. The more negative the number, the weaker the signal strength. A “-100dBm” is essentially an empty signal strength.

RSSI Threshold

---

Status  Enable  Disable

RSSI  dBm (Range: -100dBm ~ -60dBm)

**Management VLAN Settings:** When enabled with a specified VLAN ID, the device will only allow management interface access with the specified VLAN ID.

- **Status** – Select **Enable** to enable this feature then enter in the VLAN ID. .

Management VLAN Settings

---

Status  Enable  Disable

**Caution:** If you encounter disconnection issue during the configuration process, verify that the switch and the DHCP server can support the new VLAN ID and then connect to the new IP address.

3. Click **Save** at the bottom of the page to save your settings.

Save current setting(s)

**MAKE SURE THE CHANGES TO THE CONFIGURATIONS ARE APPLIED**

- Click **Changes** from the top right menu bar, and click **Apply** .

OR

- Click **Apply** on the bottom right of any page:

Waiting for changes to be applied (4)

## Management

### Advanced

Management > Advanced

This page contains the SNMP, CLI, Telnet, SSH, and Email Alert configurations.

1. Log into your access point management page (see "[Access your access point management page](#)" on page 29).
2. Click on **Advanced** under **Management** from the left side menu.

#### SNMP Settings

- **Status** – Select **Enable** to enable SNMP. *Default: Disabled*
- **Contact** – Enter the **Contact** for the SNMP in this field.
- **Location** – Enter the **Location** for the SNMP in this field.
- **Port** – Enter the **Port** for the SNMP in this field.
- **Community Name (Read Only)** – Enter the community name designated with **Read Only** permissions.
- **Community Name (Read Write)** – Enter the community name designated with **Read Write** permissions.
- **Trap Destination**
  - **Port** – Enter the port number for the SNMP trap destination.
  - **IP Address** – Enter the IP address for the SNMP trap destination.
  - **Community Name** – Enter the community name for the SNMP trap destination (defined above).
- **SNMPv3 Settings**
  - **Status** – Select **Enable** to enable SNMPv3.
  - **Username** – Enter the username for the SNMPv3.
  - **Authorized Protocol** – Select the authorized protocol for the SNMPv3.
  - **Authorized Key** – Enter the key for the protocol specified above for SNMPv3.
  - **Private Protocol** – Select the private protocol for the SNMPv3.
  - **Private Key** – Enter the private key for the protocol specified above for SNMPv3.
  - **Engine ID** – Enter the engine ID.

#### SNMP Settings

Status	<input type="radio"/> Enable <input checked="" type="radio"/> Disable
Contact	<input type="text"/>
Location	<input type="text"/>
Port	<input type="text" value="161"/>
Community Name (Read Only)	<input type="text" value="public"/>
Community Name (Read Write)	<input type="text" value="private"/>
Trap Destination	
- Port	<input type="text" value="162"/>
- IP Address	<input type="text"/>
- Community Name	<input type="text" value="public"/>
SNMPv3 Settings	
- Status	<input type="radio"/> Enable <input checked="" type="radio"/> Disable
- Username	<input type="text" value="admin"/> (1-31 Characters)
- Authorized Protocol	<input type="text" value="MD5"/>
- Authorized Key	<input type="text" value="12345678"/> (8-32 Characters)
- Private Protocol	<input type="text" value="DES"/>
- Private Key	<input type="text" value="12345678"/> (8-32 Characters)
- Engine ID	<input type="text"/>

#### CLI Settings

- **Status** – Select **Enable** to enable **Telnet Command Line Interface**. *Default: Disabled*

#### SSH Settings

- **Status** – Select **Enable** to enable **Secure Shell Interface**. *Default: Disabled*

#### CLI Setting

Status	<input type="radio"/> Enable <input checked="" type="radio"/> Disable
--------	---

#### SSH Setting

Status	<input type="radio"/> Enable <input checked="" type="radio"/> Disable
--------	---

## Email Alert

- **Status** – Select **Enable** to enable the **Email Alert**
- **From** – Enter the sender of the email alert.
- **To** – Enter the destination receiver email alert.
- **Subject** – Enter the subject to be displayed on the email alert.
- **Email Account**
  - **Username** – Enter the username for the email address.
  - **Password** – Enter the password for the email address.
  - **SMTP Server** – Enter the SMTP Server and its respective port for the email address.
  - **Security Mode** – Select the security mode from the dropdown.
  - **Send Test Mail** – Click this button to send a test email as configured.

### Email Alert

Status	<input type="checkbox"/> Enable
- From	<input type="text"/>
- To	<input type="text"/>
- Subject	<input type="text" value="[Email-Alert][TEW-840APBO][3]"/>
Email Account	
- Username	<input type="text"/>
- Password	<input type="password"/> 
- SMTP Server	<input type="text"/> Port: <input type="text" value="25"/>
- Security Mode	<input type="text" value="None"/> <input type="button" value="Send Test Mail"/>

3. Click **Apply** to apply the settings configured.

## Time Zone

*Management > Time Zone*

This page configures the time settings for the access point.

1. Log into your access point management page (see "[Access your access point management page](#)" on page 29).
2. Click on **Time Zone** under **Management** from the left side menu.

### Date and Time Settings

- **Manually Set Date and Time** – Check the box to manually set the date and time, then enter in the time below. Or click the **Synchronize with PC** to synchronize the time with your current computer's time.
- **Automatically Get Date and Time** – Check the box to automatically get the date and time from the NTP server filled in the field below.

### Date and Time Settings

Manually Set Date and Time

Date:  /  /

Time:  :  (24-Hour)

Automatically Get Date and Time

NTP Server:

### Time Zone

- **Time Zone** – Select your time zone from the drop down.
- **Enable Daylight Saving** – Check the box to enable automatic daylight savings time adjustment, then adjust the fields accordingly.

### Time Zone

Time Zone:

Enable Daylight Saving

Start:

End:

3. Click **Apply** to apply the settings.

### WiFi Scheduler

Management > WiFi Scheduler

This page configures the auto reboot and WiFi schedule.

1. Log into your access point management page (see "[Access your access point management page](#)" on page 29).
2. Click on **WiFi Scheduler** under **Management** from the left side menu.

#### Auto Reboot Setting

- **Status** – Check the box to enable the automatic reboot on the access point.
- **Timer** – Check the box next to the day or days of the week to power cycle the access point. Then set the time in 24:00 format.

#### Auto Reboot Setting

Status	<input type="radio"/> Enable <input checked="" type="radio"/> Disable
Timer	<input type="checkbox"/> Sunday <input type="checkbox"/> Monday <input type="checkbox"/> Tuesday <input type="checkbox"/> Wednesday <input type="checkbox"/> Thursday <input type="checkbox"/> Friday <input type="checkbox"/> Saturday
	0 : 0

#### Wi-Fi Scheduler

- **Status** – Check the box to enable the Wi-Fi scheduler. This enables specific date and times when the Wi-Fi radio will be on.
- **Wireless Radio** – Click the drop down to select which wireless radio to schedule.
- **SSID Selection** – Click the drop down and select which SSID to apply the schedule to.
- **Schedule Templates** – Click the drop down and select a template, or choose custom schedule and set the hours on the table below.

#### Wi-Fi Scheduler

Status	<input checked="" type="radio"/> Enable <input type="radio"/> Disable <small>NOTE: Please assure that the Time Zone Settings is synced with your local time when enabling the Wi-Fi Scheduler</small>
Wireless Radio	5GHz
SSID Selection	TRENDnet840_B4E5
Schedule Templates	Choose a template

3. Click **Save** at the bottom of the page to save your settings.

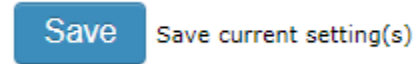

### MAKE SURE THE CHANGES TO THE CONFIGURATIONS ARE APPLIED

- Click **Changes** from the top right menu bar, and click **Apply** .

OR

- Click **Apply** on the bottom right of any page:

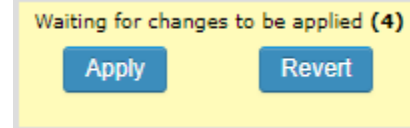

## Tools

Management > Tools

This page contains a selection of useful tools.

1. Log into your access point management page (see "[Access your access point management page](#)" on page 29).
2. Click on **Tools** under **Management** from the left side menu.

### Ping

- **Target IP / Domain Name** – Enter the IP address or domain name of the ping target.
- **Ping Packet Size** – Specify the ping packet size. Standard ping size is 32 Bytes.
- **Number of Pings** – Specify the number of pings. Standard ping test is 4 pings.
- Press **Start** to begin the test.

#### Ping Test Parameters

Target IP / Domain Name	<input type="text"/>
Ping Packet Size	<input type="text" value="64"/> Bytes
Number of Pings	<input type="text" value="4"/>
<b>Start</b>	

### Traceroute

- **Target IP / Domain Name** – Enter the IP address or domain name of the traceroute target.
- Press **Start** to begin the test.

#### Traceroute Test Parameters

Target IP / Domain Name	<input type="text" value="www.google.com"/>
<b>Start</b>	
<pre>traceroute to www.google.com (172.217.6.164), 30 hops max, 38 byte packets  1  192.168.10.1  0.625 ms  2  10.83.80.1  11.363 ms</pre>	

### Nslookup

- **Target IP / Domain Name** – Enter the IP address or domain name of the name resolution test target.
- Press **Start** to begin the test.

#### Nslookup Test Parameters

Target IP / Domain Name	<input type="text" value="www.google.com"/>
<b>Start</b>	
<pre>Server: 127.0.0.1 Address 1: 127.0.0.1 localhost  Name: www.google.com Address 1: 2607:f8b0:4000:806::2004 dfw28s22-in-x04.1e100.net Address 2: 172.217.6.164 dfw25s17-in-f4.1e100.net</pre>	

### Speed Test Parameters

- **Target IP / Domain Name** – Enter the IP address or domain name of the endpoint of the speed test.
- **Time Period** – Specify the duration of the speed test.
- **Check Interval** – Specify the interval between connectivity checks.
- **IPv4 Port** – Enter the IPv4 Port for the destination endpoint of the speed test.
- **IPv6 Port** – Enter the IPv6 Port for the destination endpoint of the speed test.
- Press **Start** to begin the test.

#### Speed Test Parameters

Target IP / Domain Name	<input type="text"/>
Time Period	<input type="text" value="20"/> Sec
Check Interval	<input type="text" value="5"/> Sec
IPv4 Port	<input type="text" value="5201"/>
IPv6 Port	<input type="text" value="60001"/>
<b>Start</b>	

**LED**

- **Power** – Select **Enable** to turn on the LED. *Default: Enable*
- **LAN** – Select **Enable** to turn on the LED. *Default: Enable*
- **WLAN-5GHz** – Select **Enable** to turn on the LED. *Default: Enable*
- Press **Apply** to apply the LED settings.

**LED Control**

Power	<input checked="" type="radio"/> Enable <input type="radio"/> Disable
LAN	<input checked="" type="radio"/> Enable <input type="radio"/> Disable
WLAN-5GHz	<input checked="" type="radio"/> Enable <input type="radio"/> Disable

**Apply** Apply saved settings to take effect

**Device Discovery**

- **Scan** – Click **Scan** to commence a device discovery. The device details will populate after the scan.

**Device Discovery**

Device Name	Operation Mode	IP Address	System MAC Address	Firmware Version
TEW-840APBO	AP/WDS BR	192.168.10.51	3C:8C:F8:FD:00:0A	1.0.0

**Scan**



## System Manager

### Account

*System Manager > Account*



This section allows configurations of the account passwords.

1. Log into your access point management page (see "[Access your access point management page](#)" on page 29).
2. Click on **Account** under **System Manager** from the left side menu.

#### Account

- **Administrator Username** – Enter the administrator username if you would like to change it.
- **Current Password** – Enter your current password to apply edits to this page.
- **New Password** – Enter the new password you would like to change to.
- **Verify Password** – Enter the same password you in the previous step.

#### Account Settings

Administrator Username	<input type="text" value="admin"/>
Current Password	<input type="password"/> 
New Password	<input type="password"/> 
Verify Password	<input type="password"/> 

**Apply**

3. Click **Apply** to apply the changes on this page.

### Firmware

*System Manager > Firmware*

TRENDnet may periodically release firmware upgrades that may add features or fix problems associated with your TRENDnet device and date/version. To check if there is a firmware upgrade available for your device, please check your TRENDnet model and version using the link. <http://www.trendnet.com/downloads/>

In addition, it is also important to verify if the latest firmware version is newer than the one your AP is currently running. To identify the firmware that is currently loaded on your AP, log in to the AP, click on Overview > Device Status. The firmware version and date used by the AP will be displayed. If there is a newer version available, also review the release notes to check if there were any new features you may want or if any problems were fixed that you may have been experiencing.

1. If a firmware upgrade is available, download the firmware to your computer.
2. Unzip the file to a folder on your computer.

#### Please note the following:

- Do not interrupt the firmware upgrade process. Do not turn off the device or press the Reset button during the upgrade.
- If you are upgrade the firmware using a laptop computer, ensure that the laptop is connected to a power source or ensure that the battery is fully charged.
- Disable sleep mode on your computer as this may interrupt the firmware upgrade process.
- Do not upgrade the firmware using a wireless connection, only using a wired network connection.
- Any interruptions during the firmware upgrade process may permanently damage your router.

This section allows configurations of the device firmware and backup configurations.

3. Log into your access point management page (see "[Access your access point management page](#)" on page 29).
4. Click on **Firmware** under **System Manager** from the left side menu.

**Firmware Upgrade**

- **Current Firmware Version** – Displays the current firmware applied to the device.
- **Choose File** – Click this button to browse your local computer for the firmware file.
- **Upload** – Click this button to begin uploading the chosen firmware to the device.

**Firmware Upgrade**

Current Firmware Version: 1.0.0.9

Select the new firmware from your hard disk.

Choose File No file chosen Upload

**Flash Firmware – Verify**

- Following uploading the firmware, you will be prompted to verify and proceed with the firmware upgrade. Click **Proceed** to begin the firmware upgrade procedure.

**Flash Firmware - Verify**

The flash image was uploaded. Below is the checksum and file size listed, compare them with the original file to ensure data integrity. Click "Proceed" below to start the flash procedure.

- Checksum: b987d5a8529c726d75078ab20b17785d
- Size: 11.81 MB

Cancel Proceed

**Backup/Restore Settings**

**Note:** User Default replaces factory default whenever resets are applied through the GUI. To reset to factory default after User Default has been set, must select reset to FACTORY DEFAULT settings, or use the physical Reset button located on the device itself or the included PoE Injector.

- **Factory Setting**
  - **Backup Setting** – Click **Export** to export the **CURRENT** configurations as a file downloaded to your computer.
  - **Restore New Setting** – Click **Choose File** to browse your computer for a configuration file to apply to the device. Click **Import** to import the chosen **configuration** file.
  - **Reset to Default** – Click **Reset** to reset the device to **Factory Default**
- **User Setting**
  - **Back Up Setting as Default** – Click **Backup** to set the current configuration as the **User Default**.
  - **Restore to User Default** – Click **Restore** to restore the configuration to the **User Defined Default**.

**Backup/Restore Settings**

Factory Setting

- Backup Setting Export

- Restore New Setting Choose File No file chosen Import

- Reset to Default Reset

User Setting

- Back Up Setting as Default Backup

- Restore to User Default Restore

- **Warning:** This feature will overwrite the factory default setting with your current AP settings. Pressing the physical reset button or reset on GUI will restore to factory settings.

A similar menu can be found by clicking **Reset** at top right of all GUI screen.

**Reboot the device**

**Caution:** Pressing this button will cause the device to reboot.

Reboot the device

**Restore the device to default settings**

**Caution:** All settings will be cleared and reset to either factory default or user default.

Restore to Factory Default Restore to User Default

## System Log

System Manager > Log

This section contains the system logs for troubleshooting.

1. Log into your access point management page (see "[Access your access point management page](#)" on page 29).
2. Click on **Log** under **System Manager** from the left side menu.

### System Log

- **Status** – Click **Enable** to enable to system log.
- **Log Type** – Click the dropdown and select the type of logs to display.
- **Refresh** – Click **Refresh** to refresh the logs.
- **Clear** – Click **Clear** to clear the logs.
- **Remote Log** – Click **Enable** to output the logs to a remote server.
- **Log Server IP Address** – Enter the IP Address for the remote log server.

### System Log

Status	<input checked="" type="radio"/> Enable <input type="radio"/> Disable
Log type	ALL <span>▼</span>
<input type="button" value="Refresh"/> <input type="button" value="Clear"/>	Cleared
Remote Log	<input type="radio"/> Enable <input checked="" type="radio"/> Disable
Log Server IP Address	<input type="text"/>
<input type="button" value="Apply"/>	Apply saved settings to take effect

3. Click on **Apply** to apply the log settings.

## Log Out

To log out of the access point, click logout from the top right menu from any screen, then click **OK** on the pop-up dialog box.

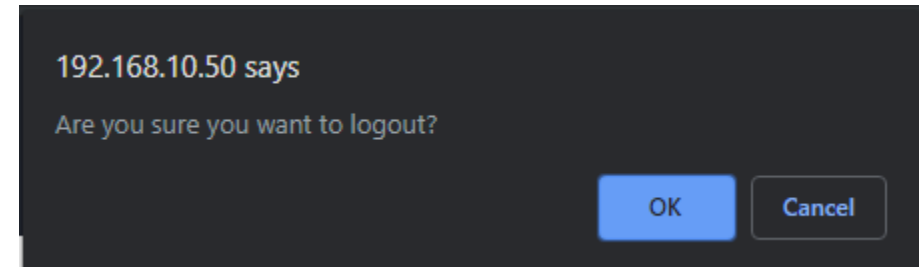

## Technical Specifications

### Standards

- IEEE 802.3
- IEEE 802.3u
- IEEE 802.3ab
- IEEE 802.1d
- IEEE 802.1Q VLAN
- IEEE 802.1X network based authentication
- IEEE 802.11d
- IEEE 802.11e
- IEEE 802.11h
- IEEE 802.11i
- IEEE 802.11a
- IEEE 802.11r
- IEEE 802.11k
- IEEE 802.11n (5GHz up to 300Mbps @ 64QAM)
- IEEE 802.11ac Wave 2 MU-MIMO (5GHz up to 867Mbps @ 256QAM)

### Hardware Interface

- 1 x Gigabit PoE-in LAN1 port (proprietary PoE max. cable length 60m (197 ft.))
- 1 x Gigabit LAN2 port
- LED indicators
- Reset button

### Special Features

- IP56 weather rated
- 802.1Q VLAN
- WiFi scheduling
- Scheduled auto reboot
- CSMA/TDMA support

### Access Control

- Wireless AP mode encryption: WPA2-PSK, WPA2-Enterprise
- Wireless WDS bridge mode encryption (CSMA): WEP, AES
- Wireless WDS AP/Station encryption (CSMA/TDMA): WPA2-PSK, WPA2-Enterprise
- Access Controls: MAC (AP & WDS AP mode only), Layer 2 isolation, client Isolation
- Client limit
- Bandwidth limit (download/upload) per SSID or per client
- RSSI Threshold

### QoS

- WMM

### Operation Modes

- Access Point (AP)
- WDS Access Point
- WDS Bridge (CSMA mode only)
- WDS Station
- Client Bridge

### SSID

- Up to 7 SSIDs
- 802.1Q VLAN assignment per SSID

### Management/Monitoring

- Web management (HTTP)
- CLI management (Telnet, SSHv2)
- SNMP v2c/v3
- IPv4 (DHCP/static IP), IPv6 (link-local, static IP, DHCPv6) assignment
- Email alert
- Upgrade firmware
- Backup/restore configuration
- Internal logging
- External syslog

- Scheduled automatic reboot
- Restore to factory defaults
- Ping test
- Traceroute
- Nslookup
- NTP
- Management VLAN ID
- Schedule radio on/off per SSID
- Real time traffic monitor
- Real time CPU load monitor
- Device discovery (Point to point AP connections only)
- Speed test (Point to point AP connections only)
- LED control

#### Frequency

- FCC: 5.150GHz – 5.250GHz, 5.725GHz – 5.850GHz

#### Wireless Channels

- 5 GHz: FCC: 36, 40, 44, 48, 149, 153, 157, 161, 165

#### Modulation

- 802.11a: OFDM with BPSK, QPSK and 16/64-QAM
- 802.11n (5GHz): BPSK, QPSK, 16-QAM, 64-QAM with OFDM
- 802.11ac: OFDM with BPSK, QPSK and 16/64/256-QAM

#### Media Access Protocol

- CSMA/CA with ACK mode
- TDMA (Point to point AP connections only)

#### Antenna Gain

- 14 dBi internal patch antenna

#### Wireless Output Power (max output power without antenna gain)

- 802.11a: FCC: 23 dBm (max.) / IC: **23** dBm (max.)
- 802.11n (5GHz): FCC: 22 dBm (max.) / IC: **22** dBm (max.)
- 802.11ac: FCC: 22 dBm (max.) / IC: **22** dBm (max.)

#### Receiving Sensitivity (per chain)

- 802.11a: -71 dBm (typical) @ 54Mbps

- 802.11n (5GHz): -66 dBm (typical) @ 300Mbps
- 802.11ac: -55 dBm (typical) @ 867Mbps

#### Power

- Input: 100 – 240V AC, 50/60Hz, 0.4A
- Output: 24V DC, 0.6A proprietary/passive PoE injector
- Max. Consumption: 9.5W

#### Surge Protection

- Line to ground: 2kV

#### ESD Protection

- Contact: 4kV
- Air: 8kV

#### Operating Temperature

- -22° – 60° C (7.6° – 140° F)

#### Operating Humidity

- Max. 90 % non-condensing

#### Certifications

- FCC
- IC

#### Dimensions

- 185 x 100 x 35mm (7.3 x 3.9 x 1.4 in.)

#### Weight

- 268g (0.6 lbs.)

#### Warranty

- 3 year

#### Disclaimer

\* Effective wireless coverage may vary depending on the wireless device's output power, antenna gain, antenna alignment, receiving sensitivity, and radio interference. Additionally, environmental factors such as weather conditions, physical obstacles, and other considerations may affect performance. For optimal results, we recommended consulting a professional installer for site survey, safety precautions, and proper installation.

## Appendix

### How to find your IP address?

**Note:** Please note that although the following procedures provided to follow for your operating system on configuring your network settings can be used as general guidelines, however, it is strongly recommended that you consult your computer or operating system manufacturer directly for assistance on the proper procedure for configuring network settings.

#### Command Prompt Method

##### **Windows 2000/XP/Vista/7/8.1/10**

1. On your keyboard, press **Windows Logo+R** keys simultaneously to bring up the Run dialog box.
2. In the dialog box, type **cmd** to bring up the command prompt.
3. In the command prompt, type **ipconfig /all** to display your IP address settings.

##### **MAC OS X**

1. Navigate to your **Applications** folder and open **Utilities**.
2. Double-click on **Terminal** to launch the command prompt.
3. In the command prompt, type **ipconfig getifaddr <en0 or en1>** to display the wired or wireless IP address settings.

**Note:** **en0** is typically the wired Ethernet and **en1** is typically the wireless Airport interface.

#### Graphical Method

##### **MAC OS 10.6/10.5**

1. From the Apple menu, select **System Preferences**.
2. In System Preferences, from the **View** menu, select **Network**.
3. In the Network preference window, click a network port (e.g., Ethernet, AirPort, modem). If you are connected, you'll see your IP address settings under "Status:"

##### **MAC OS 10.4**

1. From the Apple menu, select **Location**, and then **Network Preferences**.
2. In the Network Preference window, next to "Show:", select **Network Status**. You'll see your network status and your IP address settings displayed.

**Note:** If you are experiencing difficulties, please contact your computer or operating system manufacturer for assistance.

### How to configure your network settings to obtain an IP address automatically or use DHCP?

**Note:** Please note that although the following procedures provided to follow for your operating system on configuring your network settings can be used as general guidelines, however, it is strongly recommended that you consult your computer or operating system manufacturer directly for assistance on the proper procedure for configuring network settings.

#### **Windows 7/8.1/10**

- a. Go into the **Control Panel**, click **Network and Sharing Center**.
- b. Click **Change Adapter Settings**, right-click the **Local Area Connection** icon.
- c. Then click **Properties** and click **Internet Protocol Version 4 (TCP/IPv4)**.
- d. Then click **Obtain an IP address automatically** and click **OK**.

#### **Windows Vista**

- a. Go into the **Control Panel**, click **Network and Internet**.
- b. Click **Manage Network Connections**, right-click the **Local Area Connection** icon and click **Properties**.
- c. Click **Internet Protocol Version (TCP/IPv4)** and then click **Properties**.
- d. Then click **Obtain an IP address automatically** and click **OK**.

#### **Windows XP/2000**

- a. Go into the **Control Panel**, double-click the **Network Connections** icon
- b. Right-click the **Local Area Connection** icon and the click **Properties**.
- c. Click **Internet Protocol (TCP/IP)** and click **Properties**.
- d. Then click **Obtain an IP address automatically** and click **OK**.

#### **MAC OS 10.4/10.5/10.6**

- a. From the **Apple**, drop-down list, select **System Preferences**.
- b. Click the **Network** icon.
- c. From the **Location** drop-down list, select **Automatic**.
- d. Select and view your Ethernet connection.
  - In MAC OS 10.4, from the **Show** drop-down list, select **Built-in Ethernet** and select the **TCP/IP** tab.
  - In MAC OS 10.5/10.6, in the left column, select **Ethernet**.
- e. Configure TCP/IP to use DHCP.

In MAC 10.4, from the **Configure IPv4**, drop-down list, select **Using DHCP** and click the **Apply Now** button.

In MAC 10.5, from the **Configure** drop-down list, select **Using DHCP** and click the **Apply** button.

In MAC 10.6, from the **Configure** drop-down list, select **Using DHCP** and click the **Apply** button.

f. Restart your computer.

**Note:** *If you are experiencing difficulties, please contact your computer or operating system manufacturer for assistance.*

#### How to configure your network settings to use a static IP address?

**Note:** *Please note that although the following procedures provided to follow for your operating system on configuring your network settings can be used as general guidelines, however, it is strongly recommended that you consult your computer or operating system manufacturer directly for assistance on the proper procedure for configuring network settings.*

#### Windows 7/8.1/10

- a. Go into the **Control Panel**, click **Network and Sharing Center**.
- b. Click **Change Adapter Settings**, right-click the **Local Area Connection** icon.
- c. Then click **Properties** and click **Internet Protocol Version 4 (TCP/IPv4)**.
- d. Then click **Use the following IP address**, and assign your network adapter a static IP address. Click **OK**

#### Windows Vista

- a. Go into the **Control Panel**, click **Network and Internet**.
- b. Click **Manage Network Connections**, right-click the **Local Area Connection** icon and click **Properties**.
- c. Click **Internet Protocol Version (TCP/IPv4)** and then click **Properties**.
- d. Then click **Use the following IP address**, and assign your network adapter a static IP address. Click **OK**

#### Windows XP/2000

- a. Go into the **Control Panel**, double-click the **Network Connections** icon
- b. Right-click the **Local Area Connection** icon and the click **Properties**.
- c. Click **Internet Protocol (TCP/IP)** and click **Properties**.

d. Then click **Use the following IP address**, and assign your network adapter a static IP address. Click **OK**

#### MAC OS 10.4/10.5/10.6

- a. From the **Apple**, drop-down list, select **System Preferences**.
- b. Click the **Network** icon.
- c. From the **Location** drop-down list, select **Automatic**.
- d. Select and view your Ethernet connection.

#### How to find your MAC address?

In Windows 2000/XP/Vista/7/8,

Your computer MAC addresses are also displayed in this window, however, you can type **getmac -v** to display the MAC addresses only.

In MAC OS 10.4,

1. **Apple Menu > System Preferences > Network**
2. From the **Show** menu, select **Built-in Ethernet**.
3. On the **Ethernet** tab, the **Ethernet ID** is your MAC Address.

In MAC OS 10.5/10.6,

1. **Apple Menu > System Preferences > Network**
2. Select **Ethernet** from the list on the left.
3. Click the **Advanced** button.
3. On the **Ethernet** tab, the **Ethernet ID** is your MAC Address.



**How do I use the ping tool to check for network device connectivity?****Windows 2000/XP/Vista/7/8.1/10**

1. On your keyboard, press **Windows Logo+R** keys simultaneously to bring up the Run dialog box.
2. In the dialog box, type **cmd** to bring up the command prompt.
3. In the command prompt, type **ping <ip\_address>** with the *<ip\_address>* being the IP address you want ping and check for connectivity.

**Example:** Usage of ping command and successful replies from device.

```
C:\Users>ping 192.168.10.100
```

```
Pinging 192.168.10.100 with 32 bytes of data:
```

```
Reply from 192.168.10.100: bytes=32 time<1ms TTL=64
```

```
Reply from 192.168.10.100: bytes=32 time<1ms TTL=64
```

```
Reply from 192.168.10.100: bytes=32 time<1ms TTL=64
```

```
Reply from 192.168.10.100: bytes=32 time<1ms TTL=64
```

Ping statistics for 192.168.10.100:

```
Packets: Sent = 4, Received = 4, Lost = 0 (0% loss),
```

Approximate round trip times in milli-seconds:

```
Minimum = 0ms, Maximum = 0ms, Average = 0ms
```

**MAC OS X**



1. Navigate to your **Applications** folder and open **Utilities**.
2. Double-click on **Terminal** to launch the command prompt.
3. In the command prompt, type **ping -c <#> <ip\_address>** with the *<#>* ping being the number of time you want to ping and the *<ip\_address>* being the IP address you want ping and check for connectivity.

**Example:** ping -c 4 192.168.10.100

**How to connect to a wireless network using the built-in Windows utility?**

**Note:** Please note that although the following procedures provided to follow for your operating system on configuring your network settings can be used as general guidelines, however, it is strongly recommended that you consult your computer or operating system manufacturer directly for assistance on the proper procedure for connecting to a wireless network using the built-in utility.

**Windows 7/8.1/10**

1. Open Connect to a Network by clicking the network icon ( or ) in the notification area.
2. In the list of available wireless networks, click the wireless network you would like to connect to, then click **Connect**.
4. You may be prompted to enter a security key in order to connect to the network.
5. Enter in the security key corresponding to the wireless network, and click **OK**.

**Windows Vista**

1. Open Connect to a Network by clicking the **Start Button**  and then click **Connect To**.
2. In the **Show** list, click **Wireless**.
3. In the list of available wireless networks, click the wireless network you would like to connect to, then click **Connect**.
4. You may be prompted to enter a security key in order to connect to the network.
5. Enter in the security key corresponding to the wireless network, and click **OK**.

**Windows XP**

1. Right-click the network icon in the notification area, then click **View Available Wireless Networks**.
2. In **Connect to a Network**, under **Available Networks**, click the wireless network you would like to connect to.
3. You may be prompted to enter a security key in order to connect to the network.
4. Enter in the security key corresponding to the wireless network, and click **Connect**.



### Federal Communication Commission Interference Statement

This equipment has been tested and found to comply with the limits for a Class B digital device, pursuant to Part 15 of the FCC Rules. These limits are designed to provide reasonable protection against harmful interference in a residential installation. This equipment generates, uses and can radiate radio frequency energy and, if not installed and used in accordance with the instructions, may cause harmful interference to radio communications. However, there is no guarantee that interference will not occur in a particular installation. If this equipment does cause harmful interference to radio or television reception, which can be determined by turning the equipment off and on, the user is encouraged to try to correct the interference by one of the following measures:

- Reorient or relocate the receiving antenna.
- Increase the separation between the equipment and receiver.
- Connect the equipment into an outlet on a circuit different from that to which the receiver is connected.
- Consult the dealer or an experienced radio/TV technician for help.



FCC Caution: Any changes or modifications not expressly approved by the party responsible for compliance could void the user's authority to operate this equipment.

This device complies with Part 15 of the FCC Rules. Operation is subject to the following two conditions: (1) This device may not cause harmful interference, and (2) this device must accept any interference received, including interference that may cause undesired operation.

#### IMPORTANT NOTE:

##### Radiation Exposure Statement:

This equipment complies with FCC radiation exposure limits set forth for an uncontrolled environment. This equipment should be installed and operated with minimum distance 20cm between the radiator & your body.

This transmitter must not be co-located or operating in conjunction with any other antenna or transmitter.

Country Code selection feature to be disabled for products marketed to the US/CANADA

### Industry Canada Statement

This device complies with Industry Canada license-exempt RSS standard(s). Operation is subject to the following two conditions: (1) this device may not cause interference, and (2) this device must accept any interference, including interference that may cause undesired operation of the device.

*Le présent appareil est conforme aux CNR d'Industrie Canada applicables aux appareils radio exempts de licence. L'exploitation est autorisée aux deux conditions suivantes : (1) l'appareil ne doit pas produire de brouillage, et (2) l'utilisateur de l'appareil doit accepter tout brouillage radioélectrique subi, même si le brouillage est susceptible d'en compromettre le fonctionnement.*

##### Radiation Exposure Statement:

This equipment complies with IC radiation exposure limits set forth for an uncontrolled environment. This equipment should be installed and operated with minimum distance 20cm between the radiator & your body.

##### Déclaration d'exposition aux radiations:

Cet équipement est conforme aux limites d'exposition aux rayonnements IC établies pour un environnement non contrôlé. Cet équipement doit être installé et utilisé avec un minimum de 20 cm de distance entre la source de rayonnement et votre corps.

## Limited Warranty

---

TRENDnet warrants only to the original purchaser of this product from a TRENDnet authorized reseller or distributor that this product will be free from defects in material and workmanship under normal use and service. This limited warranty is non-transferable and does not apply to any purchaser who bought the product from a reseller or distributor not authorized by TRENDnet, including but not limited to purchases from Internet auction sites.

### Limited Warranty

TRENDnet warrants its products against defects in material and workmanship, under normal use and service. Specific warranty periods are listed on each of the respective product pages on the TRENDnet website.

- AC/DC Power Adapter, Cooling Fan, and Power Supply carry a one-year warranty.

### Limited Lifetime Warranty

TRENDnet offers a limited lifetime warranty for all of its metal-enclosed network switches that have been purchased in the United States/Canada on or after 1/1/2015.

- Cooling fan and internal power supply carry a one-year warranty

To obtain an RMA, the ORIGINAL PURCHASER must show Proof of Purchase and return the unit to the address provided. The customer is responsible for any shipping-related costs that may occur. Replacement goods will be shipped back to the customer at TRENDnet's expense.

Upon receiving the RMA unit, TRENDnet may repair the unit using refurbished parts. In the event that the RMA unit needs to be replaced, TRENDnet may replace it with a refurbished product of the same or comparable model.

In the event that, after evaluation, TRENDnet cannot replace the defective product or there is no comparable model available, we will refund the depreciated value of the product.

If a product does not operate as warranted during the applicable warranty period, TRENDnet shall reserve the right, at its expense, to repair or replace the defective product or part and deliver an equivalent product or part to the customer. The repair/replacement unit's warranty continues from the original date of purchase. All products that are replaced become the property of TRENDnet. Replacement products may be new or reconditioned. TRENDnet does not issue refunds or credit. Please contact the point-of-purchase for their return policies.

TRENDnet shall not be responsible for any software, firmware, information, or memory data of customer contained in, stored on, or integrated with any products returned to TRENDnet pursuant to any warranty.

There are no user serviceable parts inside the product. Do not remove or attempt to service the product by any unauthorized service center. This warranty is voided if (i) the product has been modified or repaired by any unauthorized service center, (ii) the product was subject to accident, abuse, or improper use, or (iii) the product was subject to conditions more severe than those specified in the manual.

Warranty service may be obtained by contacting TRENDnet within the applicable warranty period and providing a copy of the dated proof of the purchase. Upon proper submission of required documentation, a Return Material Authorization (RMA) number will be issued. An RMA number is required in order to initiate warranty service support for all TRENDnet products. Products that are sent to TRENDnet for RMA service must have the RMA number marked on the outside of return packages and sent to TRENDnet prepaid, insured and packaged appropriately for safe shipment. International customers

shipping from outside of the USA and Canada are responsible for any return shipping and/or customs charges, including but not limited to, duty, tax, and other fees.

**Refurbished product:** Refurbished products carry a 90-day warranty after date of purchase. Please retain the dated sales receipt with purchase price clearly visible as evidence of the original purchaser's date of purchase. Replacement products may be refurbished or contain refurbished materials. If TRENDnet, by its sole determination, is unable to replace the defective product, we will offer a refund for the depreciated value of the product.

**WARRANTIES EXCLUSIVE:** IF THE TRENDNET PRODUCT DOES NOT OPERATE AS WARRANTED ABOVE, THE CUSTOMER'S SOLE REMEDY SHALL BE, AT TRENDNET'S OPTION, REPAIR OR REPLACE. THE FOREGOING WARRANTIES AND REMEDIES ARE EXCLUSIVE AND ARE IN LIEU OF ALL OTHER WARRANTIES, EXPRESSED OR IMPLIED, EITHER IN FACT OR BY OPERATION OF LAW, STATUTORY OR OTHERWISE, INCLUDING WARRANTIES OF MERCHANTABILITY AND FITNESS FOR A PARTICULAR PURPOSE. TRENDNET NEITHER ASSUMES NOR AUTHORIZES ANY OTHER PERSON TO ASSUME FOR IT ANY OTHER LIABILITY IN CONNECTION WITH THE SALE, INSTALLATION, MAINTENANCE, OR USE OF TRENDNET'S PRODUCTS.

TRENDNET SHALL NOT BE LIABLE UNDER THIS WARRANTY IF ITS TESTING AND EXAMINATION DISCLOSE THAT THE ALLEGED DEFECT IN THE PRODUCT DOES NOT EXIST OR WAS CAUSED BY CUSTOMER'S OR ANY THIRD PERSON'S MISUSE, NEGLIGENCE, IMPROPER INSTALLATION OR TESTING, UNAUTHORIZED ATTEMPTS TO REPAIR OR MODIFY, OR ANY OTHER CAUSE BEYOND THE RANGE OF THE INTENDED USE, OR BY ACCIDENT, FIRE, LIGHTNING, OR OTHER HAZARD.

LIMITATION OF LIABILITY: TO THE FULL EXTENT ALLOWED BY LAW, TRENDNET ALSO EXCLUDES FOR ITSELF AND ITS SUPPLIERS ANY LIABILITY, WHETHER BASED IN

CONTRACT OR TORT (INCLUDING NEGLIGENCE), FOR INCIDENTAL, CONSEQUENTIAL, INDIRECT, SPECIAL, OR PUNITIVE DAMAGES OF ANY KIND, OR FOR LOSS OF REVENUE OR PROFITS, LOSS OF BUSINESS, LOSS OF INFORMATION OR DATE, OR OTHER FINANCIAL LOSS ARISING OUT OF OR IN CONNECTION WITH THE SALE, INSTALLATION, MAINTENANCE, USE, PERFORMANCE, FAILURE, OR INTERRUPTION OF THE POSSIBILITY OF SUCH DAMAGES, AND LIMITS ITS LIABILITY TO REPAIR, REPLACEMENT, OR REFUND OF THE PURCHASE PRICE PAID, AT TRENDNET'S OPTION. THIS DISCLAIMER OF LIABILITY FOR DAMAGES WILL NOT BE AFFECTED IF ANY REMEDY PROVIDED HEREIN SHALL FAIL OF ITS ESSENTIAL PURPOSE.

**Governing Law:** This Limited Warranty shall be governed by the laws of the state of California.

Some TRENDnet products include software code written by third party developers. These codes are subject to the GNU General Public License ("GPL") or GNU Lesser General Public License ("LGPL").

Visit <http://www.trendnet.com/gpl> or the support section on <http://www.trendnet.com> and search for the desired TRENDnet product to access to the GPL Code or LGPL Code. These codes are distributed WITHOUT WARRANTY and are subject to the copyrights of the developers. TRENDnet does not provide technical support for these codes. Please visit <http://www.gnu.org/licenses/gpl.txt> or <http://www.gnu.org/licenses/lgpl.txt> for specific terms of each license.

PWP07172015v3

2016/12/12



## Product Warranty Registration

Please take a moment to register your product online.  
Go to TRENDnet's website at <http://www.trendnet.com/register>

TRENDnet  
20675 Manhattan Place  
Torrance, CA 90501. USA