

NETGEAR®

User Manual

Insight Managed WiFi 6 AX3000 Access Point

WAX618

January 2023
202-12641-01

NETGEAR, Inc.

350 E. Plumeria Drive
San Jose, CA 95134, USA

Support and Community

Visit [netgear.com/support](https://www.netgear.com/support) to get your questions answered and access the latest downloads.

You can also check out our NETGEAR Community for helpful advice at community.netgear.com.

Regulatory and Legal

Si ce produit est vendu au Canada, vous pouvez accéder à ce document en français canadien à <https://www.netgear.com/support/download/>.

(If this product is sold in Canada, you can access this document in Canadian French at <https://www.netgear.com/support/download/>.)

For regulatory compliance information including the EU Declaration of Conformity, visit <https://www.netgear.com/about/regulatory/>.

See the regulatory compliance document before connecting the power supply.

For NETGEAR's Privacy Policy, visit <https://www.netgear.com/about/privacy-policy>.

By using this device, you are agreeing to NETGEAR's Terms and Conditions at <https://www.netgear.com/about/terms-and-conditions>. If you do not agree, return the device to your place of purchase within your return period.

Do not use this device outdoors. The PoE source is intended for intra building connection only.

Applicable to 6 GHz devices only: Only use the device indoors. The operation of 6 GHz devices is prohibited on oil platforms, cars, trains, boats, and aircraft, except that operation of this device is permitted in large aircraft while flying above 10,000 feet. Operation of transmitters in the 5.925-7.125 GHz band is prohibited for control of or communications with unmanned aircraft systems.

Trademarks

© NETGEAR, Inc., NETGEAR, and the NETGEAR Logo are trademarks of NETGEAR, Inc. Any non-NETGEAR trademarks are used for reference purposes only.

Revision History

Publication Part Number	Publish Date	Comments
202-12641-01	January 2023	First publication.

Contents

Chapter 1 Introduction

- About the local browser user interface and NETGEAR Insight.....9
- Additional documentation.....9

Chapter 2 Hardware Overview

- Unpack the access point..... 11
- Top panel with LEDs..... 11
- Hardware interfaces..... 13
- Access point label..... 14
- Safety instructions and warnings for an indoor access point..... 15

Chapter 3 Install the Access Point in Your Network and Access It for Initial Configuration

- Position your access point for best performance..... 19
- Set up and connect the access point to your network..... 20
- Connect to the access point for initial configuration..... 21
 - Connect over the Internet using the NETGEAR Insight Cloud Portal..... 22
 - Connect over WiFi using the NETGEAR Insight app..... 24
 - Connect over WiFi to the local browser UI for initial configuration..... 26
 - Connect over the LAN to the local browser UI for initial configuration..... 31
 - Configure the access point offline using a directly connected computer..... 36
- Log in to the access point after initial setup..... 41
- What to do if you get a browser security warning..... 42

Chapter 4 Install the Access Point in an Insight Instant Mesh WiFi Network

- What are a root and a node?..... 45
- What is an Insight Instant Mesh WiFi network?..... 46
- Requirements for placing a node in a mesh WiFi network..... 47
- Access the NETGEAR Insight Cloud Portal to set up or manage an Insight Instant Mesh WiFi network..... 48

Connect the access point as a node to a root using the Cloud Portal.....49
Install the NETGEAR Insight app to manage an Insight Instant Mesh WiFi network.....52
Connect the access point as a node to a root using the Insight app.....53

Chapter 5 Manage the Basic WiFi Features for a WiFi network

Set up an open or secure WiFi network.....58
View or change the settings of a WiFi network.....67
Remove a WiFi network.....68
Hide or broadcast the SSID for a WiFi network.....69
Change the VLAN ID for a WiFi network.....70
Change the authentication and encryption for a WiFi network....71
Enable or disable PMF for a WiFi network.....75
Set up Multi PSK for a WiFi network.....76
Disable or enable a WiFi network or set up a WiFi activity schedule.....79
Enable or disable band steering with 802.11k RRM and 802.11v WiFi network management.....81

Chapter 6 Manage the Basic Radio Features

Manage the basic WiFi settings for the radios.....84
Turn a radio on or off.....87
Change the WiFi mode for a radio.....88
Change the channel width for a radio.....90
Change the guard interval for a radio.....91
Change the output power for a radio.....93
Change the channel for a radio.....94
Manage Quality of Service for a WiFi radio.....95

Chapter 7 Set Up and Manage a Captive Portal

Set up a click-through captive portal for a WiFi network.....98
Set up an external captive portal for a WiFi network.....101
Register and configure Facebook Wi-Fi for the access point....104
Set up a Facebook Wi-Fi captive portal for a WiFi network.....106
Unregister the access point from Facebook Wi-Fi.....107

Chapter 8 Manage Access and Security

Block specific URLs and keywords for Internet access.....110
Manage user accounts.....112
 Add a user account.....112
 Change the time-out period for a user session.....113
 Change the settings for a user account.....114

- Remove a user account..... 115
- Manage local MAC access control lists..... 116
 - Manually set up a MAC access control List..... 117
 - Import an existing MAC access control list..... 120
- Manage neighbor AP detection..... 123
 - Enable neighbor access point detection and move access points to the Known AP List..... 124
 - Import an existing neighbor access point list in the Known AP List..... 126
- Set up RADIUS servers..... 129
- Enable L2 security..... 131

Chapter 9 Manage the Local Area Network and IP Settings

- Disable the DHCP client and specify a fixed IP address..... 134
- Enable the DHCP client..... 135
- Set the 802.1Q VLAN and management VLAN..... 137
- Set an existing domain name..... 139
- Enable or disable Spanning Tree Protocol..... 140
- Enable or disable the network integrity check function..... 141
- Enable or disable IGMP snooping..... 142
- Enable or disable Ethernet LLDP..... 143
- Enable or disable UPnP..... 144
- Manage the multicast DNS gateway..... 145
 - Enable the multicast DNS gateway and add a policy..... 146
 - Change or remove a multicast DNS policy..... 147

Chapter 10 Manage and Maintain the Access Point

- Change the management mode to NETGEAR Insight or Web-browser..... 150
- Change the country or region of operation..... 152
- Change the admin user account password..... 153
- Change the system name..... 154
- Specify a custom NTP server..... 155
- Set the time zone..... 156
- Manage the syslog settings..... 157
- Manage the firmware of the access point..... 158
 - Let the access point check for new firmware and update the firmware..... 159
 - Manually download firmware and update the access point... 160
 - Revert to the backup firmware..... 162
 - Use an SFTP server to update the access point..... 163
- Manage the configuration file of the access point..... 165
 - Back up the access point configuration..... 165
 - Restore the access point configuration..... 166

Reboot the access point from the local browser UI.....	168
Schedule the access point to reboot.....	169
Return the access point to its factory default settings.....	170
Use the Reset button to reset the access point.....	170
Use the local browser UI to reset the access point.....	171
Enable SNMP and manage the SNMP settings.....	172
Manage the LEDs.....	174
Manage the Energy Efficiency Mode.....	175

Chapter 11 Monitor the Access Point and the Network

Display the access point Internet, IP, and system settings.....	178
Display the WiFi radio settings.....	181
Display unknown and known neighbor access points.....	184
Display client distribution, connected clients, and client trends.	186
View WiFi and Ethernet traffic, traffic and ARP statistics, and channel utilization.....	189
View or download tracked URLs.....	191
View, save, download, or clear the logs.....	193
View a WiFi bridge connection.....	195
View alarms and notifications.....	196

Chapter 12 Manage the Advanced WiFi Features for a WiFi network

Set NAT mode or Bridge mode for addressing and traffic.....	199
Enable or disable client isolation for a WiFi network.....	200
Enable or disable URL tracking for a WiFi network.....	202
Change the format of the DHCP offer messages in a WiFi network.....	204
Select a MAC ACL for a WiFi network.....	205
Set bandwidth rate limits for a WiFi network.....	207
Configure advanced rate selection for a WiFi network.....	208

Chapter 13 Set up a WiFi Bridge

WiFi base station, WiFi repeater, and WiFi bridge requirements.	214
Set up a WiFi bridge between access points.....	215

Chapter 14 Manage the Advanced Radio Features

Manage the advanced WiFi settings for the radios.....	219
Manage the maximum number of clients for a radio.....	222
Manage the broadcast and multicast settings for a radio.....	223
Manage load balancing for the radios.....	225
Manage sticky clients.....	227
Manage the ARP proxy.....	229

Chapter 15 Diagnostics and Troubleshooting

Perform a ping test.....	231
Capture WiFi and Ethernet packets.....	232
Quick tips for WiFi troubleshooting.....	235
Troubleshoot with the LEDs.....	236
Power/Cloud LED remains off.....	237
Power/Cloud LED remains solid amber.....	237
Power/Cloud LED is blinking amber slowly, continuously.....	238
The access point functions as a PoE PD and the Power/Cloud LED remains solid amber.....	238
Power/Cloud LED does not light blue in the NETGEAR Insight management mode.....	239
Power/Cloud LED does not stop blinking amber, green, and blue.....	240
2.4G or 5G WLAN LED is off.....	240
The node and root cannot connect.....	241
Troubleshoot WiFi connectivity for a WiFi client device.....	242
Troubleshoot Internet browsing.....	243
You cannot log in to the access point over a LAN connection....	244
Changes are not saved.....	245
You enter the wrong password and can no longer log in to the access point.....	245
Troubleshoot your network using the ping utility.....	246
Test the LAN path to your access point.....	246
Test the path from your computer to a remote device.....	247

Appendix A Factory Default Settings and Technical Specifications

Factory default settings.....	249
Technical specifications.....	253

Appendix B Mount the Access Point to a Wall or Ceiling

Mounting parts.....	256
Mount the access point on a wall.....	257
Mount the access point to a T-bar.....	258
Unmount the access point.....	262

1

Introduction

This manual is for the following NETGEAR Insight Managed WiFi 6 AX3000 Access Point model WAX618.

Model WAX618, in this manual referred to as the access point, support IEEE 802.11ax, four (2+2) streams of WiFi 6, and dual-band concurrent operation at 2.4 GHz and 5 GHz with a combined throughput of 3000 Mbps (600 Mbps at 2.4 GHz and 2400 Mbps at 5 GHz). The 5 GHz radio supports 160 MHz bandwidth.

The access point functions as a Power over Ethernet plus (PoE+) powered device (PD) in an existing network connected to a PoE+ switch. Model WAX618 supports an optional power adapter for connection to a regular switch. The PoE+ Ethernet port supports a high speed up to 2.5 Gbps.

This chapter contains the following sections:

- [About the local browser user interface and NETGEAR Insight](#)
- [Additional documentation](#)

Note: For more information about the topics that are covered in this manual, visit the support website at netgear.com/support/.

Note: Firmware updates with new features and bug fixes are made available from time to time at netgear.com/support/download/. Enter your model number to check for and download new firmware manually. If the features or behavior of your product does not match what is described in this manual, you might need to update the firmware.

Note: In this manual, *WiFi network* means the same as SSID (service set identifier or WiFi network name) or VAP (virtual access point). That is, when we refer to a WiFi network we mean an individual SSID or VAP.

About the local browser user interface and NETGEAR Insight

This user manual describes the local browser user interface (UI), which you use if the access point functions as a standalone access point.

NETGEAR Insight remote management offers additional features and add-on services that are not available in standalone mode. For NETGEAR Insight Premium and Insight Pro subscribers, the access point supports the NETGEAR Insight Cloud Portal and Insight app:

- **Insight Cloud Portal:** Lets you configure and manage the access point remotely through the portal of the Insight cloud-based management platform.
- **Insight app:** Lets you configure and manage the access point remotely from your iOS or Android mobile device and connects to the Insight cloud-based management platform.

For information about the NETGEAR Insight Cloud Portal and Insight app, visit the following pages:

- netgear.com/business/services/insight/subscription
- netgear.com/support/product/insight.aspx
- kb.netgear.com/000061848

If you install the access point as a NETGEAR Insight managed device, the settings for features that you can manage through the Insight Cloud Portal and Insight app are masked out in the local browser UI. However, using the local browser UI, you can still manage the settings for certain features that might not yet be supported in Insight.

Additional documentation

The following documents are available at netgear.com/support/download/:

- Installation guide
- Data sheet

For information about the NETGEAR Insight Cloud Portal and Insight app, visit netgear.com/business/services/insight/subscription and see the NETGEAR knowledge base at netgear.com/support/product/insight.aspx.

2

Hardware Overview

The NETGEAR Insight Managed WiFi 6 AX3000 Access Point model WAX618 is an indoor access point that supports the 2.4 GHz and 5 GHz WiFi bands.

The chapter contains the following sections:

- [Unpack the access point](#)
- [Top panel with LEDs](#)
- [Hardware interfaces](#)
- [Access point label](#)
- [Safety instructions and warnings for an indoor access point](#)

Unpack the access point

The package contains the following items:

- NETGEAR WAX618 access point
- Mounting plate
- Metal bracket with T-bar lock, lock screw, and 4 short screws
- 3 tall screws and anchors for wall mounting
- Installation guide

Note: Model WAX618 ships without a power adapter. Model WAX618AP ships *with* a power adapter (the type of power adapter varies by region). If you ordered model WAX618 but prefer to use the access point without a PoE+ connection, you can order a power adapter separately.

For information about the mounting options, see [Mount the Access Point to a Wall or Ceiling](#) on page 255.

Top panel with LEDs

The LEDs that provide the status of the access point are located on the top panel of the access point.



Figure 1. Top panel with LEDs

Insight Managed WiFi 6 AX3000 Access Point Model WAX618

Table 1. LED descriptions















LED Icon	Color	Description
Power/Cloud LED 		Solid amber initially and then blinking amber slowly: The access point is starting or in the process of getting an IP address.
		Solid green: The access point started up and functions either as a standalone access point or as an Insight discovered access point that is not connected to the Insight cloud-based management platform.
		Solid blue: The access point functions in Insight mode and is connected to the Insight cloud-based management platform.
		Blinking amber fast: The access point is updating firmware or is being reset to factory default settings.
		Blinking multicolor: The access point is functioning as a node in an Insight Instant Mesh WiFi Network and the mesh setup is in progress.
		Solid amber during operation: The PoE power that the access point received is not at the 802.3at (PoE+) level.
		Off: No power is supplied to the access point.
LAN LED 		Solid green: A 2.5 Gbps Ethernet link is detected on the LAN port.
		Blinking green: 2.5 Gbps traffic activity is detected on the LAN port.
		Solid amber: An Ethernet link at a speed lower than 2.5 Gbps is detected on the LAN port.
		Blinking amber: Traffic activity at a speed lower than 2.5 Gbps is detected on the LAN port.
		Off: Either no Ethernet device is connected to the LAN port or no Ethernet link is detected.
2.4 GHz WLAN LED 2.4GHz		Solid green: The 2.4 GHz WiFi radio is on but no clients are connected.
		Solid blue: One or more WLAN clients are connected to the 2.4 GHz WiFi radio.
		Blinking blue: Traffic is detected on the 2.4 GHz WiFi radio.
		Off: The 2.4 GHz WiFi radio is off.

Table 1. LED descriptions (Continued)

LED Icon	Color	Description
<div style="font-size: 2em; font-weight: bold; margin-bottom: 10px;">5GHz</div>	●	Solid green: The 5 GHz WiFi radio is on but no clients are connected.
	●	Solid blue: One or more WLAN clients are connected to the 5 GHz WiFi radio.
	✶	Blinking blue: Traffic is detected on the 5 GHz WiFi radio.
	Off	Off: The 5 GHz WiFi radio is off.

Note: For information about troubleshooting with the LEDs, see [Troubleshoot with the LEDs](#) on page 236.

Hardware interfaces

The bottom panel of the access point provides the DC power connector for an optional power adapter, **Reset** button, LAN/PoE+ port.

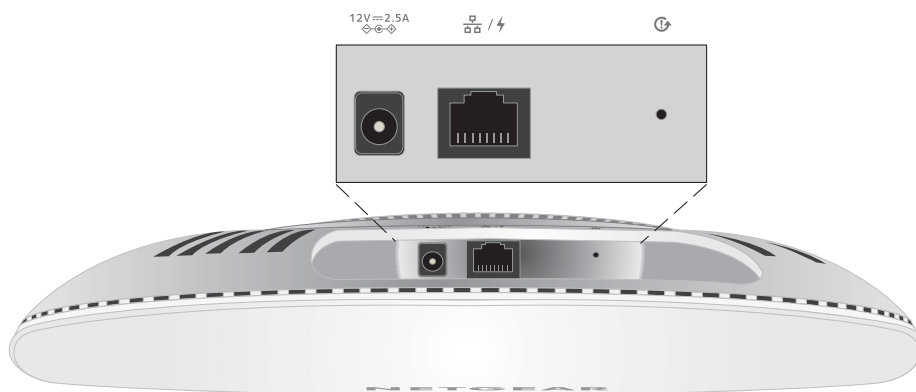

Figure 2. Hardware interfaces

The bottom panel contains the following components:

- **DC power connector:** If you do not use a PoE+ switch to provide power to the access point, connect an optional power adapter to the DC power connector.
- **LAN/PoE+ port:** Use the LAN/PoE+ Gigabit Ethernet RJ-45 LAN port to connect the access point to a PoE+ switch, or if you use an optional power adapter, to a non-PoE switch.

If connected to 2.5 Gbps equipment, the LAN PoE+ port supports Ethernet speeds up to 2.5 Gbps within your LAN. If your Internet connection, modem, router, and switch support a speed of 2.5 Gbps, the access point’s Internet connection also

functions at 2.5 Gbps. Otherwise, the Internet connection functions at 1 Gbps, which is a common speed.

For more information about the LAN/PoE+ port connection, see [Set up and connect the access point to your network](#) on page 20.

- **Reset button:** You can use the **Reset** button to restart the access point or to reset the access point to its factory default settings. To restart the access point, press the **Reset** button for about two seconds. To reset the access point to factory default settings, press the **Reset** button for 10 seconds or longer.

Note: If you added the access point to a NETGEAR Insight network location, you must first use the Insight Cloud Portal or Insight app to remove the access point from your Insight network location before the factory default settings function of the **Reset** button is available. For more information, see [Use the Reset button to reset the access point](#) on page 170.

Access point label

The access point label on the bottom panel shows the QR code, serial number, MAC address, setup WiFi network name (SSID), and network key (password) of the access point.

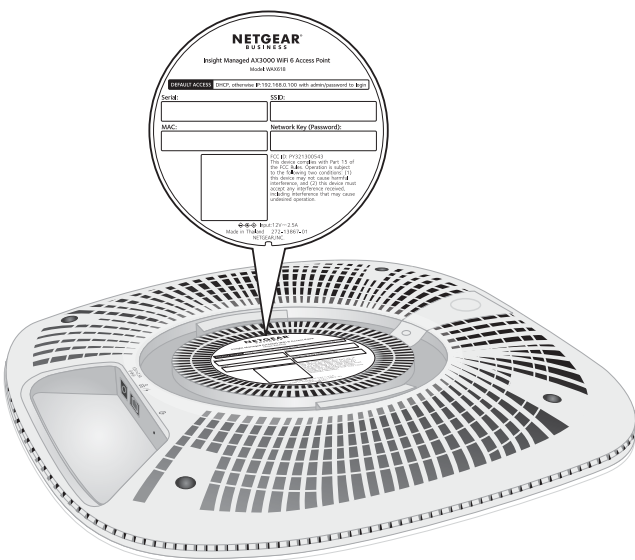

Figure 3. Access point label location

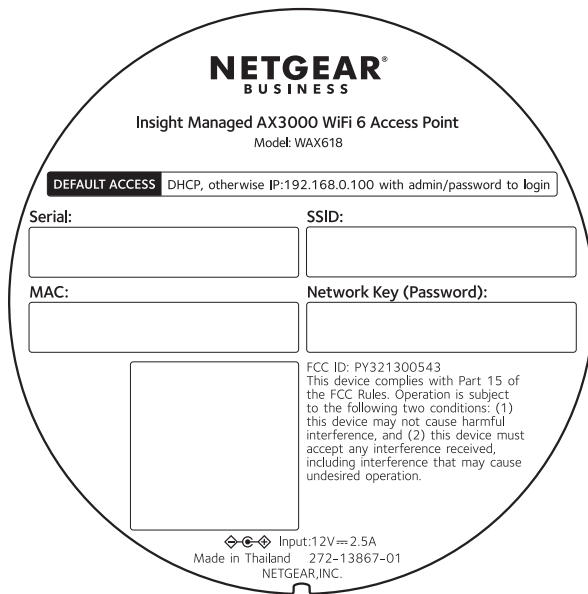

Figure 4. Access point label

Safety instructions and warnings for an indoor access point

Use the following safety guidelines to ensure your own personal safety and to help protect your system from potential damage.

To reduce the risk of bodily injury, electrical shock, fire, and damage to the equipment, observe the following precautions:

- This product is designed for indoor use only in a temperature-controlled and humidity-controlled environment. Note the following:
 - For more information about the environment in which this product must operate, see the environmental specifications in the appendix or the data sheet.
 - If you want to connect the product over an Ethernet cable to a device located outdoors, the outdoor device must be properly grounded and surge protected, and you must install an Ethernet surge protector inline between the indoor product and the outdoor device. Failure to do so can damage the product.
 - Before connecting the product to outdoor cables or wired outdoor devices, see <https://kb.netgear.com/000057103> for additional safety and warranty information.

Failure to follow these guidelines can result in damage to your NETGEAR product, which might not be covered by NETGEAR's warranty, to the extent permissible by applicable law.

- Do not service the product except as explained in your product documentation. Some devices should never be opened.
- If any of the following conditions occur, unplug the product from its power source, and then replace the part or contact your trained service provider:
 - Depending on your product, the power adapter, power adapter cable, power adapter plug, or PoE Ethernet cable is damaged.
 - An object fell into the product.
 - The product was exposed to water.
 - The product was dropped or damaged.
 - The product does not operate correctly when you follow the operating instructions.
- Keep the product away from radiators and heat sources. Also, do not block cooling vents.
- Do not spill food or liquids on your product components, and never operate the product in a wet environment. If the product gets wet, see the appropriate section in your troubleshooting guide, or contact your trained service provider.
- Do not push any objects into the openings of your product. Doing so can cause fire or electric shock by shorting out interior components.
- Use the product only with approved equipment.
- If applicable to your product, allow the product to cool before removing covers or touching internal components.
- Be sure that devices that are attached over Ethernet cables are electrically rated to operate with the power available in your location.
- Depending on your product, use only the supplied power adapter or an Ethernet cable that provides PoE.
If your product uses a power adapter:
 - If you were not provided with a power adapter, contact your local NETGEAR reseller.
 - The power adapter must be rated for the product and for the voltage and current marked on the product electrical ratings label.
- To help prevent electric shock, plug any system and peripheral power cables into properly grounded power outlets.

Insight Managed WiFi 6 AX3000 Access Point Model WAX618

- If applicable to your product, the peripheral power cables are equipped with three-prong plugs to help ensure proper grounding. Do not use adapter plugs or remove the grounding prong from a cable. If you must use an extension cable, use a three-wire cable with properly grounded plugs.
- Observe extension cable and power strip ratings. Make sure that the total ampere rating of all products plugged into the extension cable or power strip does not exceed 80 percent of the ampere ratings limit for the extension cable or power strip.
- To help protect your system from sudden, transient increases and decreases in electrical power, use a surge suppressor, line conditioner, or uninterruptible power supply (UPS).
- Position system cables, power adapter cables, and PoE Ethernet cables carefully. Route cables so that they cannot be stepped on or tripped over. Be sure that nothing rests on any cables.
- Do not modify power adapters, power adapter cables, or plugs. Consult a licensed electrician or your power company for site modifications.
- Always follow your local and national wiring rules.

3

Install the Access Point in Your Network and Access It for Initial Configuration

This chapter describes how you can install and access the access point in your network.

The chapter contains the following sections:

- [Position your access point for best performance](#)
- [Set up and connect the access point to your network](#)
- [Connect to the access point for initial configuration](#)
- [Log in to the access point after initial setup](#)
- [What to do if you get a browser security warning](#)

CAUTION: This device must be professionally installed. It is the installer's responsibility to follow local country regulations, including operations within legal frequency channels, output power, and DFS requirements. The vendor, reseller, or distributor is not responsible for illegal wireless operations. For more details, see the device's terms and conditions.

Note: In this manual, *WiFi network* means the same as SSID (service set identifier or WiFi network name) or VAP (virtual access point). That is, when we refer to a WiFi network we mean an individual SSID or VAP.

Position your access point for best performance

Before you install and mount your access point as described in the installation guide or an appendix to this manual, consider how you can position the access point for best performance.

WiFi clients that are within the access point WiFi range can connect to the WiFi network. However, the WiFi range can vary significantly depending on the physical placement of your access point. For example, the thickness, density, and number of walls the WiFi signal passes through can limit the range.

Additionally, other WiFi devices in and around your office, home, yard, or campus, might affect your access point's signal. WiFi devices can be other access points, routers, repeaters, WiFi range extenders, and any other devices that emit WiFi signals to provide network access.

Tips for positioning your access point:

- Place your access point near the center of the area where the WiFi clients operate. A line of sight between the access point and the WiFi clients is not required for good performance.
- If you use a power adapter, make sure that the access point is within reach of an AC power outlet.
- Place the access point in an elevated location, minimizing the number of walls and ceilings between the access point and the WiFi clients.
- Place the access point away from electrical devices such as these:
 - Ceiling fans
 - Home security systems
 - Microwaves
 - Computers
 - Bases of cordless phones
 - 2.4 GHz and 5.8 GHz cordless phones
- Place the access point away from large metal surfaces, large glass surfaces, insulated walls, and items such as these:
 - Solid metal doors
 - Aluminum studs
 - Fish tanks

- Mirrors
- Brick
- Concrete

If you are using adjacent standalone access points, use different radio frequency channels to reduce interference. For more information, see [Change the channel for a radio](#) on page 94.

Set up and connect the access point to your network

You can connect the access point to a Power over Ethernet plus (PoE+, 802.3at) switch in your network. The switch must be connected to a network router that is connected to the Internet. If you use a PoE+ connection, the access point does not require a power adapter.

Note: Depending on the product ordered, the package might not include a power adapter. You power up the access point by connecting it to a PoE+ switch. If you ordered a package without a power adapter but do not want to use a PoE+ connection, you can still order a power adapter as an option.

If connected to 2.5 Gbps equipment, the access point LAN PoE+ port supports Ethernet speeds up to 2.5 Gbps within your LAN. The following figure show a NETGEAR MS510TXUP switch, which supports speeds of 2.5 Gbps and higher, as well as PoE+. If your Internet connection, modem, router, and switch support a speed of 2.5 Gbps, the access point's Internet connection also functions at 2.5 Gbps. Otherwise, the Internet connection functions at 1 Gbps, which is a common speed.

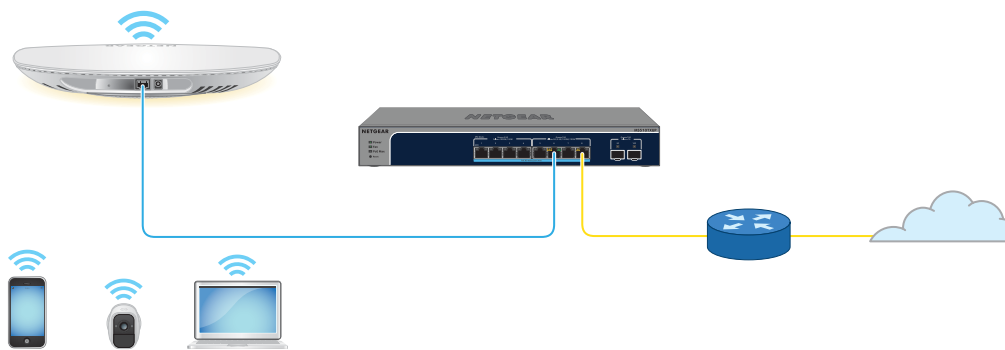

Figure 5. Set up the access point with a PoE+ connection to your network

To set up the access point with an Ethernet connection to your network:

1. Connect an Ethernet cable to the LAN 1/PoE+ port on the access point.
2. Connect the other end of the Ethernet cable to a port on a switch that is connected to your network and to the Internet.

The access point requires 802.3at (PoE+) input.

Note: For optimal functioning, make sure that you use an 802.3at (PoE+) switch and not an 802.3af (PoE) switch. If the Power LED remains solid amber after the access point starts up, the access point might receive insufficient PoE power. For more information, see [The access point functions as a PoE PD and the Power/Cloud LED remains solid amber](#) on page 238.

While the access point is starting or in the process of getting an IP address from a DHCP server (or router functioning as a DHCP server) in your network, the Power/Cloud LED initially lights solid amber, and then blinks amber slowly. After about two minutes, the Power/Cloud LED turns solid green or solid blue and the access point is ready for you to perform the initial configuration.

For information about accessing the access point for initial configuration, see [Connect to the access point for initial configuration](#) on page 21.

Connect to the access point for initial configuration

After you set up the access point, you can use several methods to connect to it for initial configuration.

For remote management of the access point (and of multiple devices and networks), you can use the NETGEAR Insight Cloud Portal on a computer or tablet or the NETGEAR Insight app on an iOS or Android mobile device. If you use the access point in a standalone configuration, you can use the local browser UI on a computer or tablet. For more information, see [About the local browser user interface and NETGEAR Insight](#) on page 9.

For information about using the Insight Cloud Portal or Insight app, see one of the following sections:

- [Connect over the Internet using the NETGEAR Insight Cloud Portal](#) on page 22
- [Connect over WiFi using the NETGEAR Insight app](#) on page 24

For information about using the local browser UI, see one of the following sections:

- [Connect over WiFi to the local browser UI for initial configuration](#) on page 26
- [Connect over the LAN to the local browser UI for initial configuration](#) on page 31
- [Configure the access point offline using a directly connected computer](#) on page 36

Note: If your network does not include a DHCP server (or a router that functions as a DHCP server) and you do not perform the initial configuration of the access point as described in one of these sections, you can connect only five clients to the access point and the access point can provide an IP address to only five clients. To prevent this situation, make sure that you perform the initial configuration of the access point.

Connect over the Internet using the NETGEAR Insight Cloud Portal

The Insight Cloud Portal is available for Insight Premium or Insight Pro subscribers. To use the NETGEAR Insight Cloud Portal to configure and manage the access point, the access point must already be connected to the Internet.

For more information about the Insight Cloud Portal, visit the following pages:

- netgear.com/business/services/insight/subscription
- netgear.com/support/product/insight.aspx
- kb.netgear.com/000061848

Your NETGEAR account is also your Insight account. Your NETGEAR account credentials let you log in as an Insight Premium user, or if you upgrade to an Insight Pro account, as an Insight Pro user.

To connect to the access point over the Internet through the Insight Cloud Portal:

1. Make sure that the access point is connected to the Internet.
2. On a computer or tablet, visit insight.netgear.com.
The NETGEAR Account Login page displays.
3. If you do not already have an Insight account, you can create an account now.
For information about creating an Insight Premium account or upgrading to an Insight Pro account, visit kb.netgear.com/000044343.
4. Enter the email address and password for your NETGEAR account and click the NETGEAR **Sign In** button.
5. Only if you are an Insight Pro user, select the organization to which you want to add the access point.

6. Add a new network location where you want to add the access point, or select an existing network location.
7. Click the **+ (Add Device)** button.

Note: If you are an Insight Pro user, you can either add a single device or you can add multiple Insight managed devices by uploading a device list as a CSV file.

8. In the Add New Device pop-up page, enter the access point's serial number and MAC address, and then click **Go**.

The serial number and MAC address are on the access point label.

9. After Insight verifies that the access point is a valid product, you can optionally change the device name of the access point, and then click **Next**.

When the access point is successfully added to the portal, a page displays a confirmation that setup is in progress.

Note: If the access point is online but Insight does not detect the access point, the firewall at the physical location where the access point is located might prevent communication with the Insight cloud. In that situation, add port and DNS entries for outbound access to the firewall. For more information, see kb.netgear.com/000062467.

The access point automatically updates to the latest Insight firmware and Insight location configuration. This might take up to 10 minutes, during which time the access point will restart.

The access point is now an Insight managed device that is connected to the Insight cloud-based management platform. If the Power/Cloud LED was solid green, it lights solid blue.

You can use the Insight Cloud Portal or Insight app to configure and manage the access point.

Note: If you add the access point to a NETGEAR Insight network location and manage the access point through the Insight Cloud Portal or Insight app, the admin password for the access point changes. That is, after you add the access point to an Insight network location, the Insight network password for that location replaces the admin password. To access the local browser UI, you must then enter the Insight network password and not the admin password. If you later decide to remove the access point from the Insight network location or change the management mode to Web-browser mode (see [Change the management mode to NETGEAR Insight or Web-browser](#) on page 150), you must continue to use the Insight network password to access the local browser UI until you manually change the admin password on the access point.

Connect over WiFi using the NETGEAR Insight app

The NETGEAR Insight app is available for Insight Premium and Insight Pro subscribers. You can install the NETGEAR Insight app on an iOS or Android mobile device and set up the access point (and perform many other tasks as well).

For more information about the Insight app, visit the following pages:

- netgear.com/business/services/insight/subscription
- netgear.com/support/product/insight.aspx
- kb.netgear.com/000061848

Your NETGEAR account is also your Insight account. Your NETGEAR account credentials let you log in as an Insight Premium user, or if you upgrade to an Insight Pro account, as an Insight Pro user.

To connect to the access point over WiFi using an iOS or Android mobile device:

1. On your mobile device, go to the app store, search for NETGEAR Insight, and download the Insight app.



2. On your mobile device, connect over WiFi to the access point's setup WiFi network using one of the following methods:
 - **Scan the QR code:** Scan the QR code on the access point label on the bottom of the access point to connect to the setup WiFi network.
 - **Connect manually:** The setup WiFi network is on the access point label and is shown in the format NETGEARxxxxxx-SETUP, where xxxxxx is the last six hexadecimal digits of the access point's MAC address. The default password is **sharedsecret**.
3. Launch the Insight app.
4. If you do not already have an Insight account, you can create an account now. For information about creating an Insight Premium account or upgrading to an Insight Pro account, visit kb.netgear.com/000044343.
5. Enter the email address and password for your NETGEAR account and tap **LOG IN**.

6. Add a new network location where you want to add the access point by tapping the **Next** button, and then tapping **OK**.

You can also select an existing network location.

The device admin password that you entered for the new network location replaces the existing admin password on all devices that you add to the network location.

In most situations, Insight detects the access point automatically, which can take several minutes.

7. To add the access point to your network location, do one of the following:
 - If the access point is automatically detected and listed in the Insight Manageable Devices section, tap the icon for the access point, and then tap the **ADD DEVICE** button.
 - If the access point is not automatically detected, or you prefer to use another method to add the access point, tap the **+** icon in the top bar, and do one of the following:
 - Tap the **SCAN BARCODE OR QR CODE** button, and then scan the access point's code, which is on the access point label.
 - Tap the **Enter Serial Number and MAC Address** link, and then manually enter the access point's serial number and MAC address, which are on the access point label.

8. If prompted, name the access point and tap the **Next** button.

The access point automatically updates to the latest Insight firmware and Insight location configuration. This might take up to 10 minutes, during which time the access point will restart.

The access point is now an Insight-managed device that is connected to the Insight cloud-based management platform. If the Power/Cloud LED was solid green, it lights solid blue.

You can use the Insight Cloud Portal or Insight app to configure and manage the access point.

Note: If you add the access point to a NETGEAR Insight network location and manage the access point through the Insight Cloud Portal or Insight app, the admin password for the access point changes. That is, the Insight network password for that location replaces the admin password. To access the local browser UI, you must then enter the Insight network password and not the admin password. If you later decide to remove the access point from the Insight network location or change the management mode to Web-browser mode (see [Change the management mode to NETGEAR Insight or Web-browser](#) on page 150), you must continue to use the Insight network password to access the local browser UI until you manually change the admin password on the access point.

Connect over WiFi to the local browser UI for initial configuration

This section describes how to connect to the access point for the first time over WiFi using a WiFi-enabled computer or mobile device (without using the NETGEAR Insight app) and complete the initial configuration.

To connect over WiFi to the local browser UI for initial configuration:

1. From your computer or mobile device, connect over WiFi to the access point's setup WiFi network using one of the following methods:
 - **Scan the QR code:** Scan the QR code on the access point label on the bottom of the access point to connect to the setup WiFi network.
 - **Connect manually:** The setup WiFi network is on the access point label and is shown in the format NETGEARxxxxxx-SETUP, where xxxxxx is the last six hexadecimal digits of the access point's MAC address. The default password is **sharedsecret**.
2. On the computer or mobile device, launch a web browser and, in the address bar, enter **http://aplogin.net**.

Note: You can use **http://aplogin.net** only during initial setup of the access point.



Your browser might display a security warning because of the self-signed certificate on the access point, which is expected behavior. You can proceed, or add an

Insight Managed WiFi 6 AX3000 Access Point Model WAX618

exception for the security warning. For more information, see [What to do if you get a browser security warning](#) on page 42.

3. Enter the access point user name and default password.

The user name is **admin**. The default password is **password**. The user name and password are case-sensitive.



4. Select the **Web-browser** radio button.

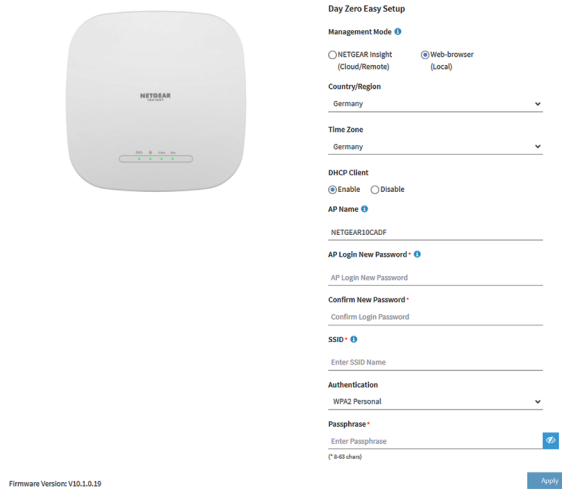

Note: After you save the basic settings that are shown on the page, the Day Zero Easy Setup page no longer displays when you log in. Instead, the login page displays. After you log in, the Dashboard page displays.

5. To let the access point check for the latest firmware, click the **Check for Upgrade** button (the button is not shown in the previous figure).

If new firmware is available for the access point, we recommend that you upgrade the firmware. After the firmware upgrade completes, the access point restarts. When the access point is ready, go back to [Step 1](#) of this procedure.

6. Enter the settings that are described in the following table.

Insight Managed WiFi 6 AX3000 Access Point Model WAX618

Setting	Description
Country/Region	<p>From the menu, select the country and region in which the access point is operating.</p> <p>Note: Make sure that the country is set to the location where the device is operating. You are responsible for complying with the local, regional, and national regulations that are set for channels, power levels, and frequency ranges.</p> <p>Note: It might not be legal to operate the access point in a region other than the regions listed in the menu. If your country or region is not listed, check with your local government agency.</p>
Time Zone	<p>From the menu, select the time zone for the country and region in which the access point is operating.</p>
DHCP Client	<p>By default, the DHCP client of the access point allows the access point to receive an IP address from a DHCP server (or router that functions as a DHCP server) in your network. To set up the access point with a static (fixed) IP address, do the following:</p> <ol style="list-style-type: none">Select the Disable radio button. Additional fields display.Specify the IP address, IP subnet mask, IP address of the default gateway, and IP address of the DNS server.
AP Name	<p>As an option, enter a new name for the access point. The name must contain alphanumeric characters, must contain at least one alphabetical character, cannot be longer than 15 characters, and can contain hyphens but cannot start or end with a hyphen.</p> <p>By default, the access point name is Netgearxxxxxx, in which xxxxxx represents the last six hexadecimal digits of the access point's MAC address.</p>
AP Login New Password	<p>Enter a new admin password. This is the password that you must use to log in to the access point's local browser UI. (It is <i>not</i> the password that you use for WiFi access.)</p> <p>The password must be 8 to 63 characters in length and must contain at least one uppercase letter, one lowercase letter, and one number. The following special characters are allowed: ! @ # \$ % ^ & * ()</p> <p>Save the password for future use.</p>

(Continued)

Setting	Description
Confirm New Password	Enter exactly the same password that you entered in the AP Login New Password field.
SSID	You cannot use the setup SSID for regular operation. The setup SSID is for initial setup only. Enter a new name with a maximum of 32 characters. You can use a combination of alphanumeric and special characters, except for quotation marks (") and a backslash (\).

- From the **Authentication** menu, select one of the following authentication types for the WiFi network, and, if applicable, set a new passphrase (network key or WiFi password) for the WiFi network:
 - Open:** Clients are not authenticated, traffic is not encrypted, and 802.11w (PMF) is automatically disabled. This setting does not provide any security and is not appropriate for most situations.
 If you select **Open** from the menu, the **Enhanced Open** check box displays and the **Allow Devices to Connect with Open** check box can display:
 - Enhanced Open:** If you select the **Enhanced Open** check box, the WiFi enhanced open feature is enabled. This feature is based on opportunistic wireless encryption (OWE). The encryption is set to CCM mode protocol (CCMP) and 802.11w (PMF) is automatically set to mandatory.
 - Allow Clients to Authenticate using Legacy Open (OWE Transition Mode):** If you select the **Enhanced Open** check box, the **Allow Clients to Authenticate using Legacy Open (OWE Transition Mode)** check box displays. If you select this check box, the WiFi network can accept both clients that support the WiFi enhanced open feature and clients that do not. For clients that do not support the WiFi open enhanced feature, traffic is not encrypted. If you do not select this check box, the WiFi network can only accept clients that support the WiFi enhanced open feature.
 - WPA2 Personal:** This option allows only WiFi clients that support WPA2 to connect to the SSID. Select this option if all WiFi clients are capable of supporting WPA2. This option uses AES encryption. In the **Passphrase** field, enter a new passphrase for the WiFi network.
 - WPA2/WPA Personal:** This option allows both WPA and WPA2 WiFi clients to connect to the SSID. This option uses TKIP and AES encryption. Broadcast packets use TKIP. For unicast (that is, point-to-point) transmissions, WPA clients use TKIP and WPA2 clients use AES. In the **Passphrase** field, enter a new passphrase for the WiFi network.

- **WPA3 Personal:** This option allows only WiFi clients that support WPA3 to connect to the SSID. Select this option if all WiFi clients are capable of supporting WPA3. This option uses SAE encryption. In the **Passphrase** field, enter a new passphrase for the WiFi network.
- **WPA3/WPA2 Personal:** This option allows both WPA2 and WPA3 WiFi clients to connect to the SSID. This option uses AES and SAE encryption. WPA2 clients use AES and WPA3 clients use SAE. In the **Passphrase** field, enter a new passphrase for the WiFi network.

Note: After you complete the setup process, you can set up WPA2 Enterprise or WPA3 Enterprise security with RADIUS servers. For more information, see [Change the authentication and encryption for a WiFi network](#) on page 71.

8. Click the **Apply** button.

Your settings are saved. A pop-up window displays the IP address and the new WiFi network and password (passphrase).

If you specified a static IP address, save the IP address information because you must enter the IP address when you log in again.

You are disconnected from the access point. If you changed the default country, the access point restarts.

9. Reconnect over WiFi to the access point's WiFi network using the new SSID and passphrase that you just defined on the Day Zero Easy Setup page.

10. Enter the access point IP address in the address bar of your browser.

If you changed the IP address, enter the IP address that you specified in [Step 6](#).

Your browser might display a security warning because of the self-signed certificate on the access point, which is expected behavior. You can proceed, or add an exception for the security warning. For more information, see [What to do if you get a browser security warning](#) on page 42.

A login window displays.

11. Enter the access point user name and password.

The user name is **admin**. The password is the one that you just defined on the Day Zero Easy Setup page. The user name and password are case-sensitive.

The Dashboard page displays. You can now customize the access point settings for your network environment.

Connect over the LAN to the local browser UI for initial configuration

The following procedure assumes that your network includes a DHCP server (or router that functions as a DHCP server) and that the access point and your computer are on the same LAN. By default, the access point functions as a DHCP client.

To connect over the LAN to the local browser UI for initial configuration:

1. To determine the IP address that the DHCP server assigned to the access point, access the DHCP server or use an IP network scanner.
If you use a Windows-based computer, launch File Explorer (or Windows Explorer), select **Network** from the Navigation pane, right-click the access point device icon, and select **Properties** to display the IP address.

Note: You can also use the NETGEAR Insight app to discover the IP address that is assigned to the access point. For more information, see [Connect over WiFi using the NETGEAR Insight app](#) on page 24.

2. On the computer, launch a web browser and, in the address bar, enter the IP address that is assigned to the access point.



Your browser might display a security warning because of the self-signed certificate on the access point, which is expected behavior. You can proceed, or add an exception for the security warning. For more information, see [What to do if you get a browser security warning](#) on page 42.

3. Enter the access point user name and default password.

Insight Managed WiFi 6 AX3000 Access Point Model WAX618

The user name is **admin**. The default password is **password**. The user name and password are case-sensitive.



4. Select the **Web-browser** radio button.

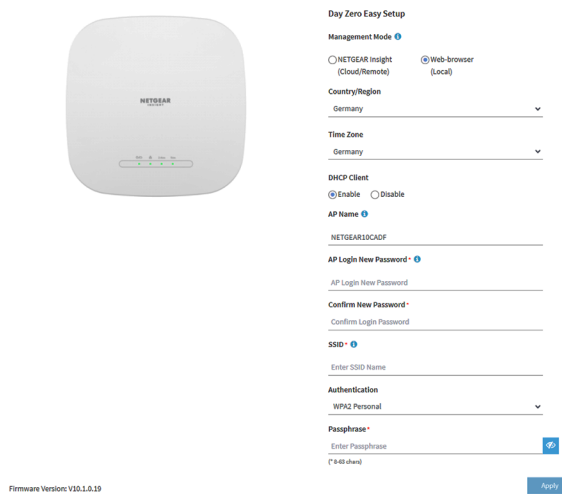

Note: After you save the basic settings that are shown on the page, the Day Zero Easy Setup page no longer displays when you log in. Instead, a login window displays. After you log in, the Dashboard page displays.

5. To let the access point check for the latest firmware, click the **Check for Upgrade** button (the button is not shown in the previous figure).
If new firmware is available for the access point, we recommend that you upgrade the firmware. After the firmware upgrade completes, the access point restarts. When the access point is ready, depending on your situation, go back to [Step 2](#) or [Step 3](#) of this procedure.
6. Enter the settings that are described in the following table.

Insight Managed WiFi 6 AX3000 Access Point Model WAX618

Setting	Description
Country/Region	<p>From the menu, select the country and region in which the access point is operating.</p> <p>Note: Make sure that the country is set to the location where the device is operating. You are responsible for complying with the local, regional, and national regulations that are set for channels, power levels, and frequency ranges.</p> <p>Note: It might not be legal to operate the access point in a region other than the regions listed in the menu. If your country or region is not listed, check with your local government agency.</p>
Time Zone	<p>From the menu, select the time zone for the country and region in which the access point is operating.</p>
DHCP Client	<p>By default, the DHCP client of the access point allows the access point to receive an IP address from a DHCP server (or router that functions as a DHCP server) in your network. To set up the access point with a static (fixed) IP address, do the following:</p> <ol style="list-style-type: none">Select the Disable radio button. Additional fields display.Specify the IP address, IP subnet mask, IP address of the default gateway, and IP address of the DNS server.
AP Name	<p>As an option, enter a new name for the access point. The name must contain alphanumeric characters, must contain at least one alphabetical character, cannot be longer than 15 characters, and can contain hyphens but cannot start or end with a hyphen.</p> <p>By default, the access point name is Netgearxxxxxx, in which xxxxxx represents the last six hexadecimal digits of the access point's MAC address.</p>
AP Login New Password	<p>Enter a new admin password. This is the password that you must use to log in to the access point's local browser UI. (It is <i>not</i> the password that you use for WiFi access.)</p> <p>The password must be 8 to 63 characters in length and must contain at least one uppercase letter, one lowercase letter, and one number. The following special characters are allowed: ! @ # \$ % ^ & * ()</p> <p>Save the password for future use.</p>

(Continued)

Setting	Description
Confirm New Password	Enter exactly the same password that you entered in the AP Login New Password field.
SSID	You cannot use the setup SSID for regular operation. The setup SSID is for initial setup only. Enter a new name with a maximum of 32 characters. You can use a combination of alphanumeric and special characters, except for quotation marks (") and a backslash (\).

- From the **Authentication** menu, select one of the following authentication types for the WiFi network, and, if applicable, set a new passphrase (network key or WiFi password) for the WiFi network:
 - Open:** Clients are not authenticated, traffic is not encrypted, and 802.11w (PMF) is automatically disabled. This setting does not provide any security and is not appropriate for most situations.
 If you select **Open** from the menu, the **Enhanced Open** check box displays and the **Allow Devices to Connect with Open** check box can display:
 - Enhanced Open:** If you select the **Enhanced Open** check box, the WiFi enhanced open feature is enabled. This feature is based on opportunistic wireless encryption (OWE). The encryption is set to CCM mode protocol (CCMP) and 802.11w (PMF) is automatically set to mandatory.
 - Allow Clients to Authenticate using Legacy Open (OWE Transition Mode):** If you select the **Enhanced Open** check box, the **Allow Clients to Authenticate using Legacy Open (OWE Transition Mode)** check box displays. If you select this check box, the WiFi network can accept both clients that support the WiFi enhanced open feature and clients that do not. For clients that do not support the WiFi open enhanced feature, traffic is not encrypted. If you do not select this check box, the WiFi network can only accept clients that support the WiFi enhanced open feature.
 - WPA2 Personal:** This option allows only WiFi clients that support WPA2 to connect to the SSID. Select this option if all WiFi clients are capable of supporting WPA2. This option uses AES encryption. In the **Passphrase** field, enter a new passphrase for the WiFi network.
 - WPA2/WPA Personal:** This option allows both WPA and WPA2 WiFi clients to connect to the SSID. This option uses TKIP and AES encryption. Broadcast packets use TKIP. For unicast (that is, point-to-point) transmissions, WPA clients use TKIP and WPA2 clients use AES. In the **Passphrase** field, enter a new passphrase for the WiFi network.

- **WPA3 Personal:** This option allows only WiFi clients that support WPA3 to connect to the SSID. Select this option if all WiFi clients are capable of supporting WPA3. This option uses SAE encryption. In the **Passphrase** field, enter a new passphrase for the WiFi network.
- **WPA3/WPA2 Personal:** This option allows both WPA2 and WPA3 WiFi clients to connect to the SSID. This option uses AES and SAE encryption. WPA2 clients use AES and WPA3 clients use SAE. In the **Passphrase** field, enter a new passphrase for the WiFi network.

Note: After you complete the setup process, you can set up WPA2 Enterprise or WPA3 Enterprise security with RADIUS servers. For more information, see [Change the authentication and encryption for a WiFi network](#) on page 71.

8. Click the **Apply** button.

Your settings are saved. A pop-up window displays the IP address and the new WiFi network and password (passphrase).

If you specified a static IP address, save the IP address information because you must enter the IP address when you log in again.

If you changed the default country, the access point restarts.

Note: Do not close the page!

After a short period, the Dashboard page displays automatically. If the Dashboard page does not display, for example, because you assigned a static IP address, see the next step.

You can now customize the access point settings for your network environment.

9. If the Dashboard does not display automatically, do the following:
 - a. Take one of the following actions:
 - If you assigned a static IP address to the access point, enter the IP address that you specified in [Step 6](#) in the address bar of the web browser.
 - If you did not assign a static IP address, reenter the IP address that is displayed in the address bar of the web browser. If that does not work, write down the IP address, close the web browser, launch the web browser again, and then reenter the IP address in the address bar of the web browser.
 - If you did not assign a static IP address and you closed the page so that you cannot see the IP address of the access point, use an IP scanner tool, use a network discovery tool, or access the DHCP server to discover the IP address of the access point in your network.

Note: You can also use the NETGEAR Insight app to discover the IP address that is assigned to the access point. For more information, see [Connect over WiFi using the NETGEAR Insight app](#) on page 24.

Then, launch a browser and enter the IP address in the address bar of the web browser.

Your browser might display a security warning because of the self-signed certificate on the access point, which is expected behavior. You can proceed, or add an exception for the security warning. For more information, see [What to do if you get a browser security warning](#) on page 42.

A login window displays.

- b. Enter the access point user name and password.

The user name is **admin**. The password is the one that you just defined on the Day Zero Easy Setup page. The user name and password are case-sensitive. The Dashboard page displays. You can now customize the access point settings for your network environment.

Configure the access point offline using a directly connected computer

You can take the access point offline (that is, disconnect it from your network), connect a computer through an Ethernet cable to the LAN 2 port of the access point, and connect to the access point over its default IP address so that you can configure it offline. After you complete the configuration, you can bring the access point online.

Note: Because the access point is not connected to a PoE+ switch, you can use this configuration method only if you have a power adapter for the access point.

To connect to the access point using a computer that is connected to a LAN/PoE+ port of the access point:

1. Record the IP address and subnet mask of your computer so that you can reinstate these IP address settings later.
2. Temporarily change the IP address on your computer to 192.168.0.210 with 255.255.255.0 as the subnet mask.

(You can actually use any IP address in the 192.168.0.2–192.168.0.254 range, with the exception of IP address 192.168.0.100, which is the default IP address of the access point.)

For more information about changing the IP address on your computer, see the help or documentation for your computer.

3. Use an Ethernet cable to connect your computer to the LAN/PoE+ port on the access point.
4. On the computer, launch a web browser and enter **192.168.0.100** in the address bar.



Your browser might display a security warning because of the self-signed certificate on the access point, which is expected behavior. You can proceed, or add an exception for the security warning. For more information, see [What to do if you get a browser security warning](#) on page 42.

5. Enter the access point user name and default password.

The user name is **admin**. The default password is **password**. The user name and password are case-sensitive.



- Select the **Web-browser** radio button.

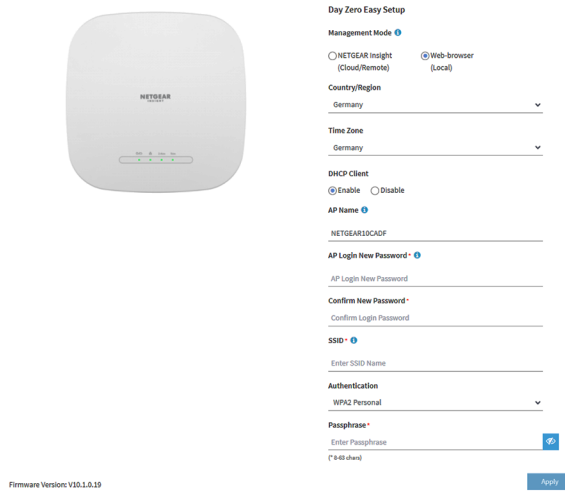

Note: After you save the basic settings that are shown on the page, the Day Zero Easy Setup page no longer displays when you log in. Instead, a login window displays. After you log in, the Dashboard page displays.

- To let the access point check for the latest firmware, click the **Check for Upgrade** button (the button is not shown in the previous figure).
If new firmware is available for the access point, we recommend that you upgrade the firmware. After the firmware upgrade completes, the access point restarts. When the access point is ready, depending on your situation, go back to [Step 4](#) or [Step 5](#) of this procedure.
- Enter the settings that are described in the following table.

Setting	Description
Country/Region	From the menu, select the country and region in which the access point is operating. Note: Make sure that the country is set to the location where the device is operating. You are responsible for complying with the local, regional, and national regulations that are set for channels, power levels, and frequency ranges. Note: It might not be legal to operate the access point in a region other than the regions listed in the menu. If your country or region is not listed, check with your local government agency.
Time Zone	From the menu, select the time zone for the country and region in which the access point is operating.

(Continued)

Setting	Description
DHCP Client	<p>By default, the DHCP client of the access point allows the access point to receive an IP address from a DHCP server (or router that functions as a DHCP server) in your network. To set up the access point with a static (fixed) IP address, do the following:</p> <ol style="list-style-type: none"> Select the Disable radio button. Additional fields display. Specify the IP address, IP subnet mask, IP address of the default gateway, and IP address of the DNS server.
AP Name	<p>As an option, enter a new name for the access point. The name must contain alphanumeric characters, must contain at least one alphabetical character, cannot be longer than 15 characters, and can contain hyphens but cannot start or end with a hyphen.</p> <p>By default, the access point name is Netgearxxxxxx, in which xxxxxx represents the last six hexadecimal digits of the access point's MAC address.</p>
AP Login New Password	<p>Enter a new admin password. This is the password that you must use to log in to the access point's local browser UI. (It is <i>not</i> the password that you use for WiFi access.)</p> <p>The password must be 8 to 63 characters in length and must contain at least one uppercase letter, one lowercase letter, and one number. The following special characters are allowed: ! @ # \$ % ^ & * ()</p> <p>Save the password for future use.</p>
Confirm New Password	<p>Enter exactly the same password that you entered in the AP Login New Password field.</p>
SSID	<p>You cannot use the setup SSID for regular operation. The setup SSID is for initial setup only. Enter a new name with a maximum of 32 characters. You can use a combination of alphanumeric and special characters, except for quotation marks (") and a backslash (\).</p>

- From the **Authentication** menu, select one of the following authentication types for the WiFi network, and, if applicable, set a new passphrase (network key or WiFi password) for the WiFi network:
 - Open:** Clients are not authenticated, traffic is not encrypted, and 802.11w (PMF) is automatically disabled. This setting does not provide any security and is not appropriate for most situations.
If you select **Open** from the menu, the **Enhanced Open** check box displays and the **Allow Devices to Connect with Open** check box *can* display:
 - **Enhanced Open:** If you select the **Enhanced Open** check box, the WiFi enhanced open feature is enabled. This feature is based on opportunistic

wireless encryption (OWE). The encryption is set to CCM mode protocol (CCMP) and 802.11w (PMF) is automatically set to mandatory.

- **Allow Clients to Authenticate using Legacy Open (OWE Transition Mode):** If you select the **Enhanced Open** check box, the **Allow Clients to Authenticate using Legacy Open (OWE Transition Mode)** check box displays. If you select this check box, the WiFi network can accept both clients that support the WiFi enhanced open feature and clients that do not. For clients that do not support the WiFi open enhanced feature, traffic is not encrypted. If you do not select this check box, the WiFi network can only accept clients that support the WiFi enhanced open feature.
- **WPA2 Personal:** This option allows only WiFi clients that support WPA2 to connect to the SSID. Select this option if all WiFi clients are capable of supporting WPA2. This option uses AES encryption. In the **Passphrase** field, enter a new passphrase for the WiFi network.
- **WPA2/WPA Personal:** This option allows both WPA and WPA2 WiFi clients to connect to the SSID. This option uses TKIP and AES encryption. Broadcast packets use TKIP. For unicast (that is, point-to-point) transmissions, WPA clients use TKIP and WPA2 clients use AES. In the **Passphrase** field, enter a new passphrase for the WiFi network.
- **WPA3 Personal:** This option allows only WiFi clients that support WPA3 to connect to the SSID. Select this option if all WiFi clients are capable of supporting WPA3. This option uses SAE encryption. In the **Passphrase** field, enter a new passphrase for the WiFi network.
- **WPA3/WPA2 Personal:** This option allows both WPA2 and WPA3 WiFi clients to connect to the SSID. This option uses AES and SAE encryption. WPA2 clients use AES and WPA3 clients use SAE. In the **Passphrase** field, enter a new passphrase for the WiFi network.

Note: After you complete the setup process, you can set up WPA2 Enterprise or WPA3 Enterprise security with RADIUS servers. For more information, see [Change the authentication and encryption for a WiFi network](#) on page 71.

10. Click the **Apply** button.

Your settings are saved. A pop-up window displays the IP address and the new WiFi network and password (passphrase).

If you specified a static IP address, save the IP address information because you must enter the IP address when you log in again.

You are disconnected from the access point. If you changed the default country, the access point restarts.

11. After a few minutes, if the login window does not display automatically, enter **192.168.0.100** in the address bar of your browser.

If you changed the IP address, enter the IP address that you specified in [Step 8](#).

Your browser might display a security warning because of the self-signed certificate on the access point, which is expected behavior. You can proceed, or add an exception for the security warning. For more information, see [What to do if you get a browser security warning](#) on page 42.

A login window displays.

12. Enter the access point user name and password.

The user name is **admin**. The password is the one that you just defined on the Day Zero Easy Setup page. The user name and password are case-sensitive.

The Dashboard page displays. You can now customize the access point settings for your network environment.

13. After you complete the setup process, or both the setup and customization process, you can change the computer back to its original IP address settings.

Log in to the access point after initial setup

After initial setup, the access point is ready for use and you can change the settings and monitor the traffic.

To log in to the access point's local browser UI:

1. Launch a web browser from a computer that is connected to the same network as the access point or directly to the access point through an Ethernet cable or WiFi connection.

2. Enter the IP address that is assigned to the access point.

A login window displays.

If your browser displays a security warning, you can proceed, or add an exception for the security warning. For more information, see [What to do if you get a browser security warning](#) on page 42.

3. Enter the access point user name and password.

The user name is **admin**. The password is the one that you specified. The user name and password are case-sensitive.

If you previously added the access point to a NETGEAR Insight network location and managed the access point through the Insight Cloud Portal or Insight app, enter the Insight network password for that location. For more information, see [Connect over WiFi using the NETGEAR Insight app](#) on page 24.

The Dashboard page displays.

The following figure shows the upper part of the Dashboard page.

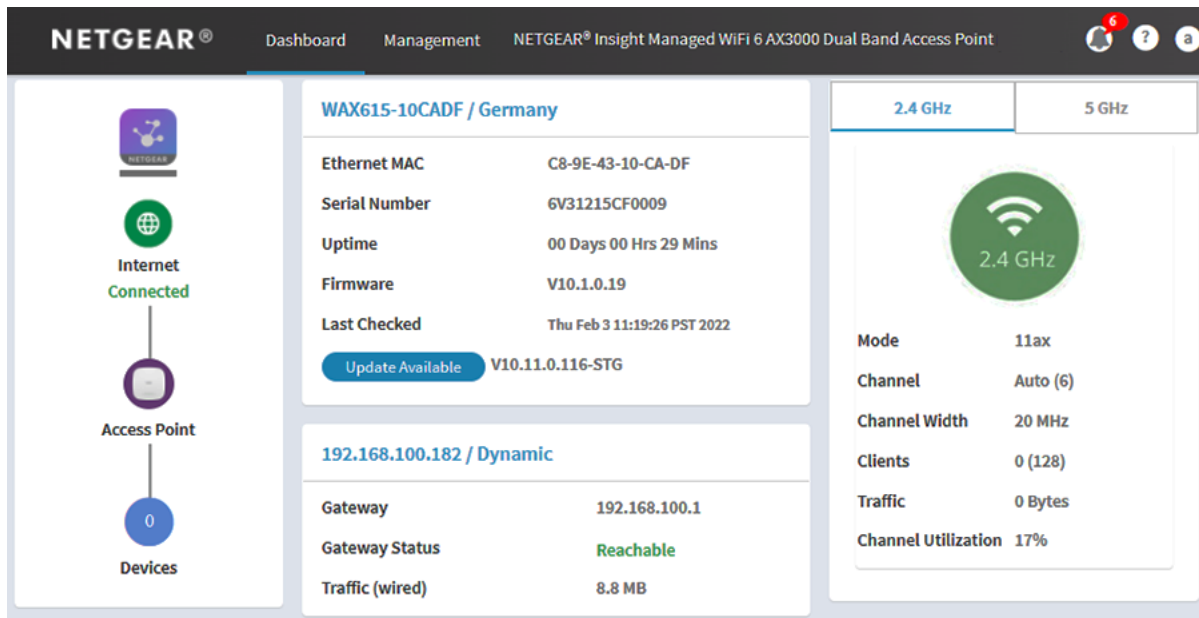

The Dashboard page displays various panes that let you see the status of your access point at a glance. For more information about the Dashboard page and its various panes, see [Monitor the Access Point and the Network](#) on page 177.

What to do if you get a browser security warning

When you enter the IP address that is assigned to the access point in the address field of your browser, a security warning might display because of the self-signed certificate on the device. This is expected behavior. You can proceed, or add an exception for the security warning.

To proceed with a security warning or add an exception for a security warning:

- **Google Chrome:** Click the **ADVANCED** link. Then, click the **Proceed to x.x.x.x (unsafe)** link, in which x.x.x.x represents the domain name or IP address of the device.
- **Apple Safari:** Click the **Show Details** button. Then, click the **visit this website** link. If a warning pop-up window displays, click the **Visit Website** button. If another pop-up window displays to let you confirm changes to your certificate trust settings, enter your Mac user name and password and click the **Update Setting** button.

- **Mozilla Firefox:** Click the **ADVANCED** button. Then, click the **Add Exception** button. In the pop-up window that displays, click the **Confirm Security Exception** button.
- **Microsoft Edge:** Select **Details > Go on to the webpage**.
- **Microsoft Internet Explorer:** Click the **Continue to this website (not recommended)** link.

4

Install the Access Point in an Insight Instant Mesh WiFi Network

In addition to functioning as a regular standalone access point, the access point can function in an Insight Instant Mesh WiFi network as either a root access point (which we refer to as a *root*) or a node access point (which we refer to as a *node*).

This chapter describes how you can use the NETGEAR Insight Cloud Portal or Insight app to connect the access point to a root so that you can let the access point function as a node in an Insight Instant Mesh WiFi network. The NETGEAR Insight Cloud Portal and Insight app are available for Insight Premium and Insight Pro subscribers.

Note: To set up a node in a NETGEAR Insight Instant Mesh WiFi network with a connection to a root, you must use either the NETGEAR Insight Cloud Portal or Insight app. You cannot use the local browser UI to set up a mesh WiFi connection to a root.

For information about how you can manage and monitor the node with the Insight Cloud Portal and Insight app, visit netgear.com/insight. The Insight Cloud Portal and Insight app have embedded help and are documented in multiple knowledge base articles that you can access by visiting netgear.com/support.

The chapter contains the following sections:

- [What are a root and a node?](#)
- [What is an Insight Instant Mesh WiFi network?](#)
- [Requirements for placing a node in a mesh WiFi network](#)
- [Access the NETGEAR Insight Cloud Portal to set up or manage an Insight Instant Mesh WiFi network](#)
- [Connect the access point as a node to a root using the Cloud Portal](#)
- [Install the NETGEAR Insight app to manage an Insight Instant Mesh WiFi network](#)
- [Connect the access point as a node to a root using the Insight app](#)

Note: In this manual, *WiFi network* means the same as SSID (service set identifier or WiFi network name) or VAP (virtual access point). That is, when we refer to a WiFi network we mean an individual SSID or VAP.

What are a root and a node?

The access point can function in an Insight Instant Mesh WiFi network as a root or node:

- **Root:** A mesh-capable access point that you set up with a wired connection to your network to create a gateway to one or more mesh-capable access points that function as nodes. On the root, use the Ethernet port for the connection to your network. A root can service multiple nodes simultaneously.
- **Node:** A mesh-capable access point with a WiFi backhaul connection to a root that provides Internet connectivity. The node is not connected to your network over a wired connection but over a WiFi connection.

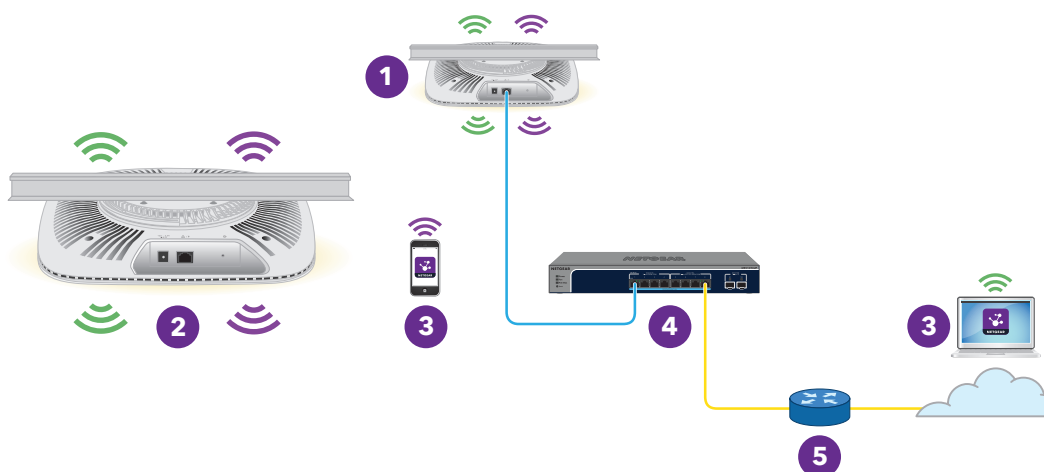

Figure 6. Mesh network with a node and a wired root

Number or Icon and Description

- 1 A root that is connected over Ethernet to a network switch.
- 2 A node that is connected over a 5 GHz backhaul WiFi connection to the root.
- 3 A mobile phone with the Insight app or either a computer or a tablet with access to the Insight Cloud Portal. The Insight Cloud Portal or Insight app lets you configure and manage the node in the Insight Instant Mesh WiFi network.
- 4 A network switch.
- 5 A network router that is connected to the Internet.

(Continued)

Number or Icon and Description
 Broadcast in the 2.4 GHz radio band.
 Broadcast in the 5 GHz radio band.

What is an Insight Instant Mesh WiFi network?

A mesh WiFi network consists of at least one mesh-capable root and one or more nodes that connect to the root over WiFi (see [What are a root and a node?](#) on page 45). The root is connected over Ethernet to a router or Internet gateway and provides Internet access to its nodes. The root and nodes work together to cover a potentially large area with WiFi network, which is the mesh network.

A mesh network can be a good solution if you want to bring WiFi to the following environments:

- Nearby rooms where cabling is not available (in line of sight and in range of the current WiFi reception)
- Neighboring office buildings (in line of sight and in range of the current WiFi reception)
- Any environment in which you cannot run cables

In the mesh WiFi network, the node connects to the root over a WiFi connection and broadcasts (extends) the WiFi network to the WiFi clients:

- **Backhaul connection:** The WiFi connection between the root and the node is referred to as the backhaul connection.
- **Fronthaul connection:** The WiFi connection between the node and its WiFi clients is referred to as the fronthaul connection.

In a NETGEAR Insight Instant Mesh WiFi network, you must use the Insight Cloud Portal or Insight app to set up the mesh WiFi connection between the root and the node. That is, you cannot do so through the local browser UI of either the root or the node. In a network with multiple roots, NETGEAR Insight automatically connects the node to the root with the strongest WiFi signal.

Although the node broadcasts the same WiFi network or networks as the root, you can also set up a WiFi network on the node, which then can be broadcast by the root and other nodes in the mesh network.

The access point can broadcast on the 5 GHz band (the preferred band for the backhaul connection) and the 2.4 GHz band. Depending on the WiFi capability of the WiFi client, any band can provide the fronthaul connection.

Requirements for placing a node in a mesh WiFi network

The following are the requirements for placing a node in an Insight Instant Mesh WiFi network:

- The existing WiFi network must include at least one mesh-capable access point that runs the latest firmware version. On the root, use one Ethernet port for the connection to your network.
- The node must be in factory default state. If you previously used the node in your network, reset the access point to factory default settings.
- The node must be within range of the WiFi signal of a root so that it can sync with the root. During setup, for a reliable WiFi connection, place the node less than 25 feet (7.5 m), in a line of sight with minimal obstacles from the closest root.
- You must use the NETGEAR Insight Cloud Portal or Insight app to install the node in the existing WiFi network.

The following NETGEAR access point models can function either as a root or as a node:

- WAX610
- WAX610Y (Although this model can function as a node, you can power it through PoE only.)
- WAX615
- WAX618
- WAX620
- WAX625
- WAX630
- WAX630E
- WAC564
- WAC540

Note: In a mesh WiFi network with WAX610, WAX610Y, WAX615, WAX618, WAX620, WAX625, WAX630, or WAX630E models *and* WAC540 or WAC564 models, the WAC540 and WAC564 models must run firmware version 9.5 or a later version.

In the near future, more NETGEAR models might be added to the previous list.

Access the NETGEAR Insight Cloud Portal to set up or manage an Insight Instant Mesh WiFi network

The NETGEAR Insight Cloud Portal is available for Insight Premium and Insight Pro subscribers.

After you install the access point in an Insight Instant Mesh WiFi network, you can use the Insight Cloud Portal to set up a mesh WiFi connection and configure, manage, and monitor the access point.

For more information about the NETGEAR Insight Cloud Portal, visit the following pages:

- netgear.com/business/services/insight/subscription
- netgear.com/support/product/insight.aspx
- kb.netgear.com/000061848

To connect to the access point over the Internet through the Insight Cloud Portal:

1. On a computer or tablet, visit insight.netgear.com.
The NETGEAR Account Login page displays.
2. If you do not already have an Insight account, you can create an account now.
For information about creating an Insight Premium account or upgrading to an Insight Pro account, visit kb.netgear.com/000044343.
3. Enter the email address and password for your NETGEAR account and click the NETGEAR **Sign In** button.

You can now set up the access point mesh WiFi connection. For more information, see kb.netgear.com/000061304.

Connect the access point as a node to a root using the Cloud Portal

The NETGEAR Insight Cloud Portal is available for Insight Premium and Insight Pro subscribers.

You can use the Insight Cloud Portal to connect the access point as a node to a root. The root must be set up with a wired connection to a router or Internet gateway so that the root can provide Internet connectivity to the node.

For more information about the Insight Cloud Portal and the configuration and management options that are available through the Insight Cloud Portal, visit netgear.com/insight. The Insight Cloud Portal has embedded help and is documented in multiple knowledge base articles that you can access by visiting netgear.com/support.

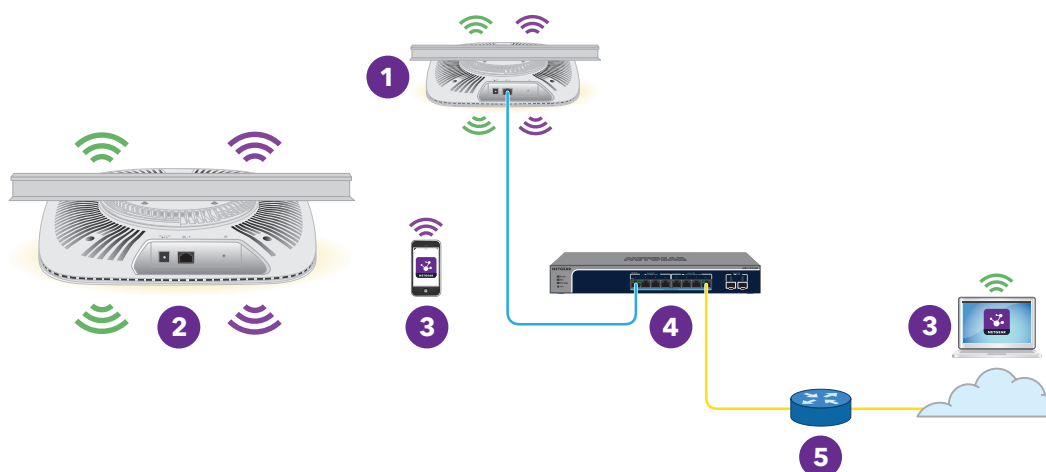





Figure 7. Connect the node to a wired root

Number or Icon and Description
<p>1 A root that is connected over Ethernet to a network switch.</p>
<p>2 A node that is connected over a 5 GHz backhaul WiFi connection to the root.</p>
<p>3 A mobile phone with the Insight app or either a computer or a tablet with access to the Insight Cloud Portal. The Insight Cloud Portal or Insight app lets you configure and manage the node in the Insight Instant Mesh WiFi network.</p>
<p>4 A network switch.</p>

(Continued)

Number or Icon and Description
 A network router that is connected to the Internet.
 Broadcast in the 2.4 GHz radio band.
 Broadcast in the 5 GHz radio band.

The node can use any band to establish the backhaul connection to the root and the fronthaul connection to WiFi clients. However, after the backhaul connection is established, if both the root and the node can support the 5 GHz band, the node automatically switches to the 5 GHz band as the preferred band for its backhaul connection. Using the Insight Cloud Portal, you can change the backhaul settings.

To use the Insight Cloud Portal to connect the node to a root in an existing WiFi network:

1. Make sure that the mesh mode for the Insight network location is set to Auto.
For more information, visit kb.netgear.com/000064932.
2. Make sure that the mesh mode for the root is set to Auto.
For more information, visit kb.netgear.com/000064931.
3. Make sure that node is in factory default state.
If you previously used the access point in your network, reset the access point to factory default settings.
4. For a reliable WiFi connection, place the node less than 25 feet (7.5 m), in a line of sight with minimal obstacles from the closest root.
5. Connect the node to a power source.
The Power/Cloud LED of the node lights amber and then lights green.

Note: To prevent a network loop, connect the node to a PoE+ switch that is *not* connected to the same network as the root or to the Internet. You can also use an optional power adapter.

6. Access the Insight Cloud Portal by visiting insight.netgear.com, enter your NETGEAR email address and password, and click the **NETGEAR Sign In** button.
7. Only if you are an Insight Pro user, select the organization to which you want to add the node.

8. Select the location to which you want to add the node.
9. Click the **+ (Add Device)** button.
10. In the Add New Device pop-up page, enter the node's serial number and MAC address, and then click **Go**.

Insight detects the node automatically. This process might take a few minutes.

The node attempts to detect and connect to the root that provides the strongest WiFi signal in the Insight Instant Mesh WiFi network.

Note: The initial connection and configuration process might take up to 10 minutes. The node might restart during the configuration process.

11. Wait for the node to go through the initial connection and configuration process and for the Power/Cloud LED to stop blinking amber, green, and blue and to light solid blue.

Note: The initial connection and configuration process might take up to 10 minutes. The node might restart during the configuration process.

The Power/Cloud LED lights as follows during the initial connection and configuration process:

- **Blinking green:** The node is attempting to detect a root.
- **Solid green:** The node is making its first connection with the root that provides the strongest WiFi signal.
- **Blinking amber slowly:** The node is contacting the network router or DHCP server to receive an IP address.
If the Power/Cloud LED does not stop blinking amber, see [Power/Cloud LED is blinking amber slowly, continuously](#) on page 238.
- **Blinking amber, green, and blue:** The node is being configured as a managed device in the Insight Instant Mesh WiFi network.
If the Power/Cloud LED does not stop blinking amber, green, and blue, see [Power/Cloud LED does not stop blinking amber, green, and blue](#) on page 240.

When the configuration is complete, the Power/Cloud LED lights as follows:

- **Solid blue:** The configuration is complete and the node is ready for operation. The node functions in the Insight Instant Mesh WiFi network and is connected to the Insight cloud.

The node is automatically configured to broadcast (extend) the root's WiFi network.

If you are experiencing difficulty connecting the node with a root, see [The node and root cannot connect](#) on page 241.

For information about accessing, managing, and monitoring the node with the NETGEAR Insight Cloud Portal and Insight app, visit netgear.com/insight. The Insight Cloud Portal and Insight app have embedded help and are documented in multiple knowledge base articles that you can access by visiting netgear.com/support.

Install the NETGEAR Insight app to manage an Insight Instant Mesh WiFi network

The NETGEAR Insight app is available for Insight Premium and Insight Pro subscribers.

Before you can add the access point to an Insight Instant Mesh WiFi network using the NETGEAR Insight app, you must install the app on an iOS or Android mobile device.

For more information about the NETGEAR Insight app, visit the following pages:

- netgear.com/business/services/insight/subscription
- netgear.com/support/product/insight.aspx
- kb.netgear.com/000061848

To install the Insight app to manage an Insight Instant Mesh WiFi network:

1. On your mobile device, go to the app store, search for NETGEAR Insight, and download the Insight app.



2. Launch the Insight app.
3. If you do not already have an Insight account, you can create an account now. For information about creating an Insight Premium account or upgrading to an Insight Pro account, visit kb.netgear.com/000044343.
4. Enter the email address and password for your NETGEAR account and tap **LOG IN**.

You can now set up the access point mesh WiFi connection (see [Connect the access point as a node to a root using the Insight app](#) on page 53).

Connect the access point as a node to a root using the Insight app

You can use the NETGEAR Insight app to connect the access point as a node to a root. The root must be set up with a wired connection to a router or Internet gateway so that the root can provide Internet connectivity to the node.

For more information about the Insight app and the configuration and management options that are available through the Insight app, visit netgear.com/insight. The Insight app has embedded help and is documented in multiple knowledge base articles that you can access by visiting netgear.com/support.

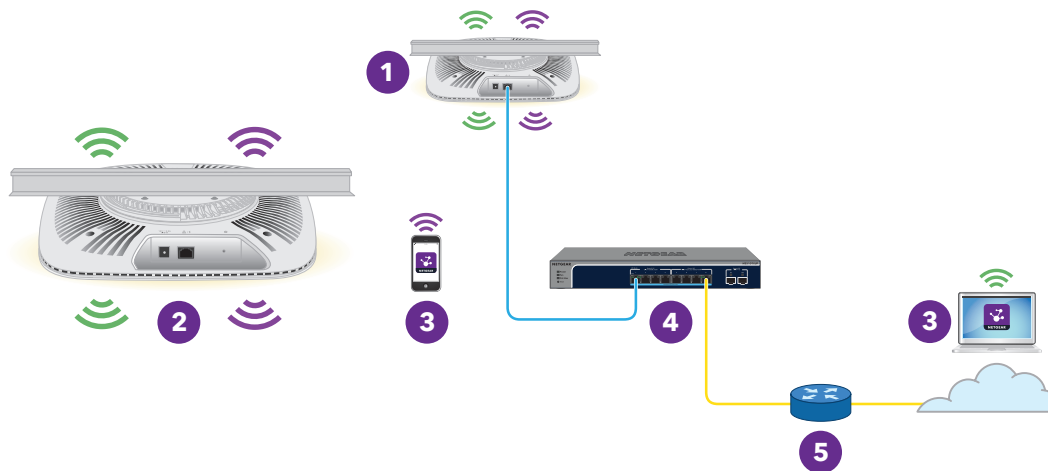

Figure 8. Connect the node to a wired root

Number or Icon and Description
<p>1 A root that is connected over Ethernet to a network switch.</p>
<p>2 A node that is connected over a 5 GHz backhaul WiFi connection to the root.</p>
<p>3 A mobile phone with the Insight app or either a computer or a tablet with access to the Insight Cloud Portal. The Insight Cloud Portal or Insight app lets you configure and manage the node in the Insight Instant Mesh WiFi network.</p>
<p>4 A network switch.</p>
<p>5 A network router that is connected to the Internet.</p>

(Continued)

Number or Icon and Description
 Broadcast in the 2.4 GHz radio band.
 Broadcast in the 5 GHz radio band.

The node can use any band to establish the backhaul connection to the root and the fronthaul connection to WiFi clients. However, after the backhaul connection is established, if both the root and the node can support the 5 GHz band, the node automatically switches to the 5 GHz band as the preferred band for its backhaul connection. Using the Insight Cloud Portal, you can change the backhaul settings.

To use the NETGEAR Insight app to connect the node to a root in an existing WiFi network:

1. Make sure that the mesh mode for the Insight network location is set to Auto.
For more information, visit kb.netgear.com/000064932.
You cannot use the Insight app to change the mesh mode for the Insight network location. You must use the Cloud Portal. For all other steps in this procedure, you *can* use the Insight app.
2. Make sure that the mesh mode for the root is set to Auto.
For more information, visit kb.netgear.com/000064929.
3. Make sure that node is in factory default state.
If you previously used the access point in your network, reset the access point to factory default settings.
4. For a reliable WiFi connection, place the node less than 25 feet (7.5 m), in a line of sight with minimal obstacles from the closest root.
5. Connect the node to a power source.
The Power/Cloud LED of the node lights amber and then lights green.

Note: To prevent a network loop, connect the node to a PoE+ switch that is *not* connected to the same network as the root or to the Internet. You can also use an optional power adapter.
6. Connect your mobile device to the existing WiFi network that includes one or more roots.
7. Launch the Insight app and sign in to your account.

8. Select the Insight network location with the root.
In most situations, the Insight app detects the node automatically. This process might take a few minutes.
9. Do one of the following to add the node to the Insight network location:
 - **Automatically detected:** If the node is automatically detected and listed in the Insight Manageable Devices section, tap the icon for the node, and then tap the **ADD DEVICE** button.
 - **Not automatically detected:** If the node is not automatically detected, do the following:
 - a. Tap the **+** icon in the top bar.
 - b. Do one of the following:
 - Tap the **SCAN BARCODE OR QR CODE** button, and then scan the node's code.
 - Tap the **Enter Serial Number and MAC address** link, and then manually enter the node's serial number and MAC address.
 - c. If prompted, name the node and tap the **Next** button.

The node attempts to detect and connect to the root that provides the strongest WiFi signal in the Insight Instant Mesh WiFi network.

Note: The initial connection and configuration process might take up to 10 minutes. The node might restart during the configuration process.

10. Wait for the node to go through the initial connection and configuration process and for the Power/Cloud LED to stop blinking amber, green, and blue and to light solid blue.

Note: The initial connection and configuration process might take up to 10 minutes. The node might restart during the configuration process.

The Power/Cloud LED lights as follows during the initial connection and configuration process:

- **Blinking green:** The node is attempting to detect a root.
- **Solid green:** The node is making its first connection with the root that provides the strongest WiFi signal.
- **Blinking amber slowly:** The node is contacting the network router or DHCP server to receive an IP address.

If the Power/Cloud LED does not stop blinking amber, see [Power/Cloud LED is blinking amber slowly, continuously](#) on page 238.

- **Blinking amber, green, and blue:** The node is being configured as a managed device in the Insight Instant Mesh WiFi network. If the Power/Cloud LED does not stop blinking amber, green, and blue, see [Power/Cloud LED does not stop blinking amber, green, and blue](#) on page 240.

When the configuration is complete, the Power/Cloud LED lights as follows:

- **Solid blue:** The configuration is complete and the node is ready for operation. The node functions in the Insight Instant Mesh WiFi network and is connected to the Insight cloud.

The node is automatically configured to broadcast (extend) the root's WiFi network.

If you are experiencing difficulty connecting the node with a root, see [The node and root cannot connect](#) on page 241.

For information about accessing, managing, and monitoring the node with the NETGEAR Insight Cloud Portal and Insight app, visit netgear.com/insight. The Insight Cloud Portal and Insight app have embedded help and are documented in multiple knowledge base articles that you can access by visiting netgear.com/support.

5

Manage the Basic WiFi Features for a WiFi network

The access point can support eight WiFi networks, each with its own unique WiFi settings, including WiFi security. This chapter describes how you can manage the basic WiFi features for a WiFi network.

For information about the advanced WiFi features for a WiFi network, see [Manage the Advanced WiFi Features for a WiFi network](#) on page 198.

The chapter includes the following sections:

- [Set up an open or secure WiFi network](#)
- [View or change the settings of a WiFi network](#)
- [Remove a WiFi network](#)
- [Hide or broadcast the SSID for a WiFi network](#)
- [Change the VLAN ID for a WiFi network](#)
- [Change the authentication and encryption for a WiFi network](#)
- [Enable or disable PMF for a WiFi network](#)
- [Set up Multi PSK for a WiFi network](#)
- [Disable or enable a WiFi network or set up a WiFi activity schedule](#)
- [Enable or disable band steering with 802.11k RRM and 802.11v WiFi network management](#)

Note: If you want to change the settings of a WiFi network on the access point, use a wired connection to avoid being disconnected when the new WiFi settings take effect.

Note: In this manual, *WiFi network* means the same as SSID (service set identifier or WiFi network name) or VAP (virtual access point). That is, when we refer to a WiFi network we mean an individual SSID or VAP.

Set up an open or secure WiFi network

The access point provides one setup SSID that is enabled by default and that broadcasts on the 2.4 GHz band and the 5 GHz band. This is the SSID that you renamed and for which you set a new passphrase when you initially connected to the access point. We also refer to this SSID as the default WiFi network, and it is displayed as SSID1 in the local browser UI. You can add more SSIDs: The access point can support a total of eight SSIDs.

The access point can simultaneously support the 2.4 GHz band for 802.11b/g/n/ax WiFi devices and the 5 GHz band for 802.11a/na/ac/ax WiFi devices. Each band supports two WiFi streams for a total of four WiFi streams.

SSID stands for service set identifier, which is the WiFi network name. When you create a new SSID, you are defining the settings for a new WiFi network, also referred to as virtual access point (VAP). That means that the access point supports up to eight WiFi networks or VAPs.

If you plan to use WPA2 Enterprise security or WPA3 Enterprise security for your WiFi network, first set up RADIUS servers (see [Set up RADIUS servers](#) on page 129). Note that WPA2 Enterprise security and WPA3 Enterprise security are not compatible with a multicast DNS (mDNS) gateway (see [Manage the multicast DNS gateway](#) on page 145).

To set up a WiFi network:

1. Launch a web browser from a computer that is connected to the same network as the access point or directly to the access point through an Ethernet cable or WiFi connection.

2. Enter the IP address that is assigned to the access point.
A login window displays.

If your browser displays a security warning, you can proceed, or add an exception for the security warning. For more information, see [What to do if you get a browser security warning](#) on page 42.

3. Enter the access point user name and password.

The user name is **admin**. The password is the one that you specified. The user name and password are case-sensitive.

If you previously added the access point to a NETGEAR Insight network location and managed the access point through the Insight Cloud Portal or Insight app, enter the Insight network password for that location. For more information, see [Connect over WiFi using the NETGEAR Insight app](#) on page 24.

The Dashboard page displays.

4. Select **Management > Configuration > Wireless > Basic**.

The page that displays lets you select and add an SSID.

- Click the **+** button to the left of Add SSID.

The screenshot shows the configuration page for SSID2 on a NETGEAR-2 device. The settings are as follows:

- Wireless Network Name (SSID):** NETGEAR-2
- Broadcast SSID:** Yes No
- VLAN ID:** 1
- Authentication:** WPA2 Personal
- Passphrase:** [Masked]
- 802.11w (PMF):** Mandatory Optional Disable
- Multi PSK:** Enable Disable
- Schedule:** Always ON Always OFF Custom
- Band:** 2.4 GHz 5 GHz Both
- Band Steering / 802.11 k/v:** Enable Disable
- Advanced:** > Advanced
- Advanced Rate Selection:** > Advanced Rate Selection

Buttons for Cancel and Apply are visible at the bottom.

The previous figure shows SSID2 as an example.

- Specify the WiFi network name (SSID), select whether the SSID is broadcast, and specify the VLAN ID as described in the following table.

Setting	Description
Wireless Network Name (SSID)	The SSID is the WiFi network name of the VAP. Enter a name for the SSID with a maximum of 32 characters. You can use a combination of alphanumeric and special characters, except for quotation marks (") and a backslash (\). For a WiFi device to be able to connect to the VAP, the SSID on the WiFi device must match the SSID of the VAP.
Broadcast SSID	By default, the VAP broadcasts its SSID so that WiFi clients can detect the SSID in their scanned network lists. To turn off the SSID broadcast, select the No radio button. Turning off the SSID broadcast provides additional WiFi security, but users must know the SSID to be able to join the VAP.
VLAN ID	You can enter the VLAN ID that must be associated with the VAP. By default, the VLAN ID is 1. This VLAN ID is not the same as the 802.1Q VLAN ID that is used for the wired network (see Set the 802.1Q VLAN and management VLAN on page 137).

7. Specify the WiFi security by selecting an option from the **Authentication** menu and, if applicable, by specifying a passphrase in the **Passphrase** field or selecting an option from the **Encryption** menu:
- **Open:** A legacy open WiFi network does not provide any security. Any WiFi device can join the network. We recommend that you do *not* use a legacy open WiFi network but configure WiFi security. However, a legacy open network might be appropriate for a WiFi hotspot.
If you select **Open** from the **Authentication** menu, the **Enhanced Open** check box displays.
 - **Enhanced Open check box cleared:** The WiFi network is a legacy open network without any security. This is the default option for an open network. Clients are not authenticated, traffic is not encrypted, and 802.11w (PMF) is automatically disabled (see [Step 8](#)).
 - **Enhanced Open check box selected:** The WiFi enhanced open feature is enabled. This feature is based on opportunistic wireless encryption (OWE). The encryption is set to CCM mode protocol (CCMP) and 802.11w (PMF) is automatically set to mandatory (see [Step 8](#)). If you select the **Enhanced Open** check box, the **Allow Devices to Connect with Open** check box displays. If you select the **Allow Devices to Connect with Open** check box, the WiFi network can accept both clients that support the WiFi enhanced open feature and clients that do not. For clients that do not support the WiFi open enhanced feature, traffic is not encrypted. If you clear the **Allow Devices to Connect with Open** check box, the WiFi network can only accept clients that support the WiFi enhanced open feature.
 - **WPA2 Personal:** This option, which is the same as WPA2-PSK, is the default setting and uses AES encryption. This type of security enables only WiFi devices that support WPA2 to join the VAP.
WPA2 provides a secure connection but some legacy WiFi devices do not detect WPA2 and support only WPA. If your network includes such older devices, select **WPA2/WPA Personal** authentication.
In the **Passphrase** field, enter a phrase of 8 to 63 characters. To join the VAP, a user must enter this passphrase. To view the passphrase in clear text, click the eye icon.
 - **WPA2/WPA Personal:** This option, which is the same as WPA2-PSK/WPA-PSK, enables WiFi devices that support either WPA2 or WPA to join the VAP. This option uses AES and TKIP encryption.
WPA-PSK (which uses TKIP) is less secure than WPA2-PSK (which uses AES) and limits the speed of WiFi devices to 54 Mbps.
In the **Passphrase** field, enter a phrase of 8 to 63 characters. To join the VAP, a user must enter this passphrase. To view the passphrase in clear text, click the eye icon.

- **WPA2 Enterprise:** This enterprise-level security uses RADIUS for centralized Authentication, Authorization, and Accounting (AAA) management. For WPA2 Enterprise security to function, you must set up RADIUS servers (see [Set up RADIUS servers](#) on page 129).

From the **Encryption** menu, select the data encryption mode:

- **TKIP + AES.** This type of data encryption enables WiFi devices that support either WPA or WPA2 to join the access point's WiFi network. This is the default mode.
- **AES.** This type of data encryption provides a secure connection but some older WiFi devices do not detect WPA2 and support only WPA. Therefore, if your network includes such older devices, select **TKIP + AES** encryption.

When you select **WPA2 Enterprise** authentication, the **Dynamic VLAN** radio buttons display:

- **Enable:** The RADIUS server can assign a VLAN ID to clients. If the RADIUS server does not do so, the clients are automatically assigned the VLAN ID that you configured for the SSID.
- **Disable:** The clients are assigned the VLAN ID that you configured for the SSID. This is the default setting.

- **WPA3 Personal:** This option is the most secure personal authentication option. WPA3 uses SAE encryption and enables only WiFi devices that support WPA3 to join the VAP. If you select this option, 802.11w (PMF) is automatically set to mandatory (see [Step 8](#)).

WPA3 provides a secure connection but some legacy WiFi devices do not detect WPA3 and support only WPA2. If your network also includes WPA2 devices, select **WPA3/WPA2 Personal** authentication.

In the **Passphrase** field, enter a phrase of 8 to 63 characters. To join the VAP, a user must enter this passphrase. To view the passphrase in clear text, click the eye icon.

- **WPA3/WPA2 Personal:** This option, which is the same as WPA3/WPA2-PSK, enables WiFi devices that support either WPA3 or WPA2 to join the VAP. This option uses SAE and AES encryption.

WPA2-PSK (which uses AES) is less secure than WPA3 (which uses SAE).

In the **Passphrase** field, enter a phrase of 8 to 63 characters. To join the VAP, a user must enter this passphrase. To view the passphrase in clear text, click the eye icon.

- **WPA3 Enterprise:** This enterprise-level security uses RADIUS for centralized Authentication, Authorization, and Accounting (AAA) management. For WPA3 Enterprise security to function, you must set up RADIUS servers (see [Set up RADIUS](#)

[servers](#) on page 129). If you select this option, 802.11w (PMF) is automatically set to mandatory (see [Step 8](#)).

When you select WPA3 Enterprise security, the encryption is automatically set to GCMP256, which is a 256-bit encryption protocol.

When you select **WPA3 Enterprise** authentication, the **Dynamic VLAN** radio buttons display:

- **Enable:** The RADIUS server can assign a VLAN ID to clients. If the RADIUS server does not do so, the clients are automatically assigned the VLAN ID that you configured for the SSID.
- **Disable:** The clients are assigned the VLAN ID that you configured for the SSID. This is the default setting.

8. Optionally, enable 802.11w Protected Management Frames (PMF).

Protected Management Frames (PMF), according to the 802.11w standard, is a security feature that protects unicast and multicast management frames from being intercepted and changed for malicious purposes. The type of authentication that you select determines if this feature is mandatory, optional, or disabled. You can also set it manually.

- **Mandatory:** This option requires devices to use PMF. Devices that do not support PMF cannot connect to the WiFi network. If you select Enhanced Open authentication, WPA3 Personal authentication, or WPA3 Enterprise authentication, the radio button for PMF is set to **Mandatory**, and you cannot change it.
- **Optional:** This option lets the access point automatically activate PMF based on whether devices can support PMF. If you select WPA3/WPA2 Personal authentication, the radio button for PMF is set to **Optional**, but you can change it.
- **Disable:** This option disables PMF. If you select Open, WPA2 Personal, WPA2/WPA Personal, or WPA2 Enterprise authentication, the radio button for PMF is set to **Disabled**, but you can change it (except for Open authentication).

9. Optionally, enable Multi Pre-Shared Key (PSK), which lets you segregate the WiFi network into different VLANs, each accessible with a unique passphrase.

Multi PSK is supported only if the WiFi security is WPA2 Personal or WPA2/WPA Personal.

In a way, Multi PSK lets you create different sub WiFi networks on the WiFi network that you are setting up.

Although you can also configure this feature while you set up a WiFi network, this feature is more complex and therefore described separately. For more information, see [Set up Multi PSK for a WiFi network](#) on page 76.

10. Optionally, disable the WiFi broadcast or set up a WiFi activity schedule by selecting one of the following radio buttons:

- **Always ON:** When you set up an SSID, you are creating a new VAP. By default, the new VAP is enabled and the **Always ON** radio button is selected.
- **Always OFF:** Select this radio button to set up the SSID but temporarily disable the VAP.
- **Custom:** Select this radio button to set up a broadcast schedule. An icon displays to the right of the radio button. Do the following:
 - a. Click the icon next to the radio button.
A pop-up window displays.
 - b. Either select a predefined time from the **Preset** menu or select custom time blocks by clicking the time blocks.
A blue color for a time block indicates that the VAP will be enabled (on). A gray color for a time block indicates that the VAP will be disabled (off).
 - c. Click the **Done** button.
The pop-up window closes.

For each SSID, you can create a single custom schedule. In that schedule, for each day from 12:00 a.m. to 11:59 p.m., you specify the time or times that the VAP is disabled.

11. Optionally, select a single radio band only.

Select a radio button for a single band (**2.4 GHz** or **5 GHz**) or keep the default selection. By default, the **Both** radio button is selected, which lets the access point broadcast the SSID on both bands.

12. Optionally, enable band steering with 802.11k radio resource management (RRM) and 802.11v WiFi network management.

By default, band steering with 802.11k RRM and 802.11v WiFi network management is disabled for the VAP.

To enable band steering with 802.11k RRM and 802.11v WiFi network management, select the **Enable** radio button. Doing so allows the access point, under certain channel conditions, to steer WiFi devices that are dual-band capable to the 2.4 GHz or 5 GHz band of the VAP. Compared to the 2.4 GHz band, generally more channels and bandwidth are available in the 5 GHz band, causing less interference and allowing for a better user experience.

802.11k RRM and 802.11v WiFi network management affect the network in the following ways:

- **802.11k RRM:** This feature lets the access point and 802.11k-aware clients dynamically measure the available radio resources. In an 802.11k-enabled

network, access points and clients can send neighbor reports, beacon reports, and link measurement reports to each other, allowing 802.11k-aware clients to automatically select the best access point for initial connection or for roaming.

- **802.11v WiFi network management:** This feature lets the access point steer its WiFi clients to the 2.4 GHz or 5 GHz band, based on the access point’s channel load.

The access point sets the received signal strength indicator (RSSI) threshold automatically. (That is, you cannot configure the RSSI threshold manually.)

13. To set the addressing and traffic mode, configure client isolation, configure URL tracking, configure if a DHCP Offer message is unicast or broadcast, or do all of this, scroll down and click the **> Advanced** tab.

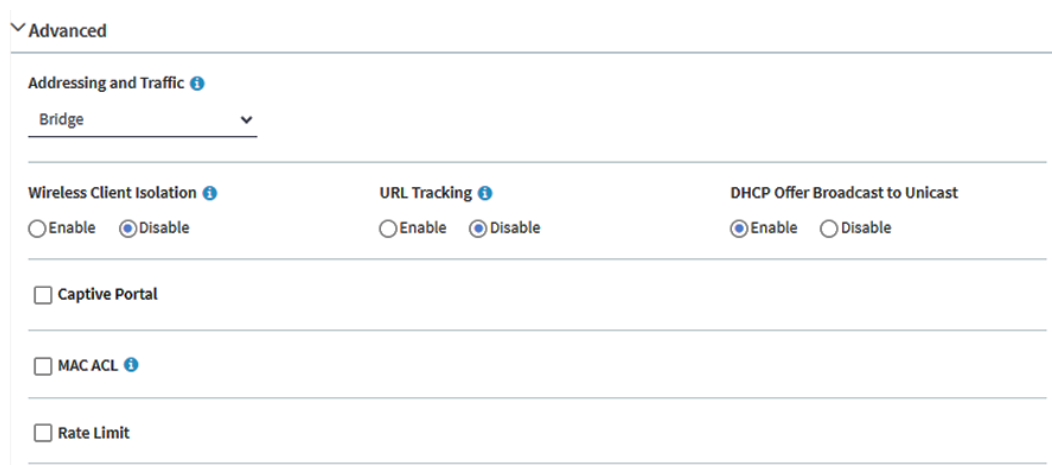

14. Optionally, set the NAT mode or Bridge mode for addressing and traffic.

By default, the addressing and traffic mode of the access point is Bridge mode, which means that WiFi clients receive IP addresses from a DHCP server (or a router that functions as a DHCP server) in your network. This is usually the same DHCP server that assigns an IP address to the access point itself.

You can also set NAT mode, which enables the access point’s DHCP server for WiFi clients. The access point’s DHCP server assigns an IP address in a different range from the IP address of the access point itself. NAT mode and Multi PSK (see [Step 9](#)) are mutually incompatible.

From the **Addressing and Traffic** menu, select the addressing and traffic mode:

- **Bridge:** The WiFi clients receive their IP addresses from the DHCP server in the same network as the access point. This is the default mode.
- **NAT:** WiFi clients receive their IP addresses from a private DHCP address pool on the access point. If you select this mode, by default, the WLAN network address is 172.31.0.0. This means that WiFi clients are assigned an IP address in the range

from 172.31.0.2 to 172.31.3.254. The IP address of the default DNS server for the WLAN is 8.8.8.8. To change the default range for the DHCP address pool, the default DNS server, or both, do the following:

- a. In the **Network Address** field, enter a network address that is different from the network address for the access point. For example, if the access point's IP address is in the range from 192.168.0.1 to 192.168.0.254 (a common IP address range), enter a network address that is different from 192.168.0.0.
- b. In the **DNS** field, enter the IP address for the DNS server that you want to use. This IP address must be different from the WLAN network address that you set in the previous step.

15. Optionally, configure WiFi client isolation.

By default, client isolation is disabled for the VAP, and the **Disable** radio button is selected. Client isolation and Multi PSK (see [Step 9](#)) are mutually incompatible.

To block communication between WiFi clients that are associated with the same SSID or different SSIDs on the access point, select the **Enable** radio button.

When you select the **Enable** radio button, the following check boxes display:

- **Allow Access to AP UI:** If the management VLAN and WiFi network VLAN are identical (by default, both are VLAN 1) and you enable client isolation, the **Allow Access to AP UI** check box displays. By default, this check box is selected, allowing an admin user to access the local browser UI over the WiFi network. If you clear the **Allow Access to AP UI** check box, an admin user cannot access the local browser UI over the WiFi network.
If the management VLAN and WiFi network VLAN are identical (which they are by default), an admin user can always access the local browser UI over a wired network connection.
- **Allow access to devices listed below:** You can specify static IP addresses or domains (that resolve to static IP addresses) of network devices that are exempt from isolation so that clients are allowed to reach them. For more information, see [Enable or disable client isolation for a WiFi network](#) on page 200.

16. Optionally, enable URL tracking.

By default, URL tracking is disabled, and the **Disable** radio button is selected. To enable URL tracking for all URLs that are requested by WiFi clients that are connected to the SSID, select the **Enable** radio button.

For information about how to view the tracked URLs per SSID or per WiFi client, see [View or download tracked URLs](#) on page 191.

17. Optionally, change the DHCP Offer message settings.

When a device tries to associate with the WiFi network and negotiates an IP address, the access point converts the broadcast DHCP offer message that it receives from the DHCP server to a unicast message, and forwards it to the device. This is the default option (that is, the **Enable** radio button is selected). To disable this option so that the access point does *not* convert the broadcast DHCP offer messages to unicast messages, select the **Disable** radio button.

18. To configure a captive portal, a MAC ACL, and bandwidth rate limits, see the information in the following sections:

- [Set Up and Manage a Captive Portal](#) on page 97
Captive portals and Multi PSK (see [Step 9](#)) are mutually incompatible.
- [Manage local MAC access control lists](#) on page 116 and [Select a MAC ACL for a WiFi network](#) on page 205
- [Set bandwidth rate limits for a WiFi network](#) on page 207

Although you can also configure these features while you set up a WiFi network, these features are more complex and therefore described separately.

19. To configure advance rate selection, see [Configure advanced rate selection for a WiFi network](#) on page 208.

20. Click the **Apply** button.

Your settings are saved.

21. Make sure that you can connect to the new WiFi network.

If you cannot connect to the new WiFi network, check the following:

- If your WiFi-enabled computer or mobile device is already connected to another WiFi network in your area, disconnect it from that WiFi network and connect it to the correct WiFi network. Some WiFi devices automatically connect to the first open network without WiFi security that they discover.
- If your WiFi-enabled computer or mobile device is trying to connect to your network with its old settings (before you changed the settings), update the WiFi network selection in your WiFi-enabled computer or mobile device to match the current settings for your network.
- Does your WiFi device display as a connected client? (See [Display client distribution, connected clients, and client trends](#) on page 186.) If it does, it is connected to the network.
- Are you using the correct WiFi network name (SSID) and password?
- If the WiFi authentication and encryption is set to WPA3 Personal, make sure that the WiFi adapter device driver is updated to the latest version on your WiFi-enabled computer or mobile device.

View or change the settings of a WiFi network

You can view or change the settings of the default WiFi network (SSID or VAP) or any custom WiFi network. The default WiFi network is the SSID that you renamed and for which you set a new passphrase when you initially connected to the access point. This SSID is displayed as SSID1 in the local browser UI.

To view or change the settings of a WiFi network:

1. Launch a web browser from a computer that is connected to the same network as the access point or directly to the access point through an Ethernet cable or WiFi connection.

2. Enter the IP address that is assigned to the access point.

A login window displays.

If your browser displays a security warning, you can proceed, or add an exception for the security warning. For more information, see [What to do if you get a browser security warning](#) on page 42.

3. Enter the access point user name and password.

The user name is **admin**. The password is the one that you specified. The user name and password are case-sensitive.

If you previously added the access point to a NETGEAR Insight network location and managed the access point through the Insight Cloud Portal or Insight app, enter the Insight network password for that location. For more information, see [Connect over WiFi using the NETGEAR Insight app](#) on page 24.

The Dashboard page displays.

4. Select **Management > Configuration > Wireless > Basic**.

The page that displays lets you select an SSID.

5. Click the ► button to the left of the SSID.

The settings for the selected SSID display.

6. Change the settings of the WiFi network as needed.

For detailed descriptions of the settings, see [Set up an open or secure WiFi network](#) on page 58.

7. If you made changes, click the **Apply** button.

Your settings are saved.

8. If you made changes, make sure that you can reconnect over WiFi to the network with its new settings.

If you cannot connect over WiFi, check the following:

- If your WiFi-enabled computer or mobile device is already connected to another WiFi network in your area, disconnect it from that WiFi network and connect it to the correct WiFi network. Some WiFi devices automatically connect to the first open network without WiFi security that they discover.
- If your WiFi-enabled computer or mobile device is trying to connect to your network with its old settings (before you changed the settings), update the WiFi network selection in your WiFi-enabled computer or mobile device to match the current settings for your network.
- Does your WiFi device display as a connected client? (See [Display client distribution, connected clients, and client trends](#) on page 186.) If it does, it is connected to the network.
- Are you using the correct WiFi network name (SSID) and password?

Remove a WiFi network

You can remove a custom WiFi network (SSID or VAP) that you no longer need. You cannot remove the default WiFi network. The default WiFi network is the SSID that you renamed and for which you set a new passphrase when you initially connected to the access point. This SSID is displayed as SSID1 in the local browser UI.

To remove a WiFi network:

1. Launch a web browser from a computer that is connected to the same network as the access point or directly to the access point through an Ethernet cable or WiFi connection.

2. Enter the IP address that is assigned to the access point.

A login window displays.

If your browser displays a security warning, you can proceed, or add an exception for the security warning. For more information, see [What to do if you get a browser security warning](#) on page 42.

3. Enter the access point user name and password.

The user name is **admin**. The password is the one that you specified. The user name and password are case-sensitive.

If you previously added the access point to a NETGEAR Insight network location and managed the access point through the Insight Cloud Portal or Insight app, enter the Insight network password for that location. For more information, see [Connect over WiFi using the NETGEAR Insight app](#) on page 24.

The Dashboard page displays.

4. Select **Management > Configuration > Wireless > Basic**.

The page that displays lets you select an SSID.

5. Click the trash can icon to the right of the SSID.

A warning pop-up window displays.

6. Click the **Delete** button.

The pop-window closes and the WiFi network is removed.

Hide or broadcast the SSID for a WiFi network

By default, a WiFi network (SSID or VAP) broadcasts its network name (also referred to as the SSID) so that WiFi clients can detect the SSID in their scanned network lists. For additional security, you can turn off the SSID broadcast and hide the SSID so that users must know the SSID to be able to join the WiFi network.

Note: If you set up a wireless distribution system (WDS; see [Set up a WiFi Bridge](#) on page 213), you must keep the SSID broadcast enabled.

To hide or broadcast the network name for a WiFi network:

1. Launch a web browser from a computer that is connected to the same network as the access point or directly to the access point through an Ethernet cable or WiFi connection.

2. Enter the IP address that is assigned to the access point.

A login window displays.

If your browser displays a security warning, you can proceed, or add an exception for the security warning. For more information, see [What to do if you get a browser security warning](#) on page 42.

3. Enter the access point user name and password.

The user name is **admin**. The password is the one that you specified. The user name and password are case-sensitive.

If you previously added the access point to a NETGEAR Insight network location and managed the access point through the Insight Cloud Portal or Insight app, enter the Insight network password for that location. For more information, see [Connect over WiFi using the NETGEAR Insight app](#) on page 24.

The Dashboard page displays.

4. Select **Management > Configuration > Wireless > Basic**.
The page that displays lets you select an SSID.
5. Click the ► button to the left of the SSID.
The settings for the selected SSID display.
6. Under Broadcast SSID, select one of the following radio buttons:
 - **No**: The SSID is hidden for the WiFi network.
 - **Yes**: The SSID is broadcast for the WiFi network.
7. Click the **Apply** button.
Your settings are saved.

Change the VLAN ID for a WiFi network

The VLAN ID for a WiFi network is not the same as the 802.1Q VLAN ID that is used for the wired network (see [Set the 802.1Q VLAN and management VLAN](#) on page 137).

CAUTION: Before you change the VLAN ID, be sure that the VLAN is configured on the network switch and the DHCP server and that the access point and its clients can get IP addresses over the new VLAN.

To change the VLAN ID for a WiFi network:

1. Launch a web browser from a computer that is connected to the same network as the access point or directly to the access point through an Ethernet cable or WiFi connection.
2. Enter the IP address that is assigned to the access point.
A login window displays.
If your browser displays a security warning, you can proceed, or add an exception for the security warning. For more information, see [What to do if you get a browser security warning](#) on page 42.
3. Enter the access point user name and password.
The user name is **admin**. The password is the one that you specified. The user name and password are case-sensitive.
If you previously added the access point to a NETGEAR Insight network location and managed the access point through the Insight Cloud Portal or Insight app, enter the

Insight network password for that location. For more information, see [Connect over WiFi using the NETGEAR Insight app](#) on page 24.

The Dashboard page displays.

4. Select **Management > Configuration > Wireless > Basic**.

The page that displays lets you select an SSID.

5. Click the ► button to the left of the SSID.

The settings for the selected SSID display.

6. In the **VLAN ID** field, enter a ID (that is, a number).

By default, the VLAN ID for a WiFi network is 1.

7. Click the **Apply** button.

Your settings are saved.

Change the authentication and encryption for a WiFi network

You can change the authentication and encryption of the default WiFi network (SSID or VAP) or any custom WiFi network. The default WiFi network is the SSID that you renamed and for which you set a new passphrase when you initially connected to the access point. This SSID is displayed as SSID1 in the local browser UI.

Before you change the authentication and encryption, consider the types of clients that must be able to connect to the WiFi network. WPA3 provides a more secure connection than WPA2, but many WiFi devices might not yet detect WPA3 and support only WPA2. Similarly, WPA2 provides a more secure connection than WPA, but some legacy WiFi devices do not detect WPA2 and support only WPA.

If you plan to use WPA2 Enterprise security or WPA3 Enterprise security for your WiFi network, first set up RADIUS servers (see [Set up RADIUS servers](#) on page 129).

To change the authentication and encryption for a WiFi network:

1. Launch a web browser from a computer that is connected to the same network as the access point or directly to the access point through an Ethernet cable or WiFi connection.
2. Enter the IP address that is assigned to the access point.
A login window displays.

If your browser displays a security warning, you can proceed, or add an exception for the security warning. For more information, see [What to do if you get a browser security warning](#) on page 42.

3. Enter the access point user name and password.

The user name is **admin**. The password is the one that you specified. The user name and password are case-sensitive.

If you previously added the access point to a NETGEAR Insight network location and managed the access point through the Insight Cloud Portal or Insight app, enter the Insight network password for that location. For more information, see [Connect over WiFi using the NETGEAR Insight app](#) on page 24.

The Dashboard page displays.

4. Select **Management > Configuration > Wireless > Basic**.

The page that displays lets you select and add an SSID.

5. Click the **+** button to the left of Add SSID.

The settings for the selected SSID display.

6. From the **Authentication** menu, select one of the following authentication types for the WiFi network, and, if applicable, set a new passphrase (network key or WiFi password) in the **Passphrase** field or select an option from the **Encryption** menu:

- **Open:** A legacy open WiFi network does not provide any security. Any WiFi device can join the network. We recommend that you do *not* use a legacy open WiFi network but configure WiFi security. However, a legacy open network might be appropriate for a WiFi hotspot.

If you select **Open** from the **Authentication** menu, the **Enhanced Open** check box displays:

- **Enhanced Open check box cleared:** The WiFi network is a legacy open network without any security. This is the default option for an open network. Clients are not authenticated, traffic is not encrypted, and 802.11w (PMF) is automatically disabled (see [Enable or disable PMF for a WiFi network](#) on page 75).
- **Enhanced Open check box selected:** The WiFi enhanced open feature is enabled. This feature is based on opportunistic wireless encryption (OWE). The encryption is set to CCM mode protocol (CCMP) and 802.11w (PMF) is automatically set to mandatory (see [Enable or disable PMF for a WiFi network](#) on page 75).

If you select the **Enhanced Open** check box, the **Allow Devices to Connect with Open** check box displays.

If you select the **Allow Devices to Connect with Open** check box, the WiFi network can accept both clients that support the WiFi enhanced open feature

and clients that do not. For clients that do not support the WiFi open enhanced feature, traffic is not encrypted.

If you clear the **Allow Devices to Connect with Open** check box, the WiFi network can only accept clients that support the WiFi enhanced open feature.

- **WPA2 Personal:** This option, which is the same as WPA2-PSK, is the default setting and uses AES encryption. This type of security enables only WiFi devices that support WPA2 to join the VAP.
WPA2 provides a more secure connection than WPA but some legacy WiFi devices do not detect WPA2 and support only WPA. If your network includes such older devices, select **WPA2/WPA Personal** authentication.
In the **Password** field, enter a phrase of 8 to 63 characters. To join the VAP, a user must enter this passphrase. To view the passphrase in clear text, click the eye icon.
- **WPA2/WPA Personal:** This option, which is the same as WPA2-PSK/WPA-PSK, enables WiFi devices that support either WPA2 or WPA to join the VAP. This option uses AES and TKIP encryption.
WPA-PSK (which uses TKIP) is less secure than WPA2-PSK (which uses AES) and limits the speed of WiFi devices to 54 Mbps.
In the **Password** field, enter a phrase of 8 to 63 characters. To join the VAP, a user must enter this passphrase. To view the passphrase in clear text, click the eye icon.
- **WPA2 Enterprise:** This enterprise-level security uses RADIUS for centralized Authentication, Authorization, and Accounting (AAA) management. For WPA2 Enterprise security to function, you must set up RADIUS servers (see [Set up RADIUS servers](#) on page 129).
From the **Encryption** menu, select the data encryption mode:
 - **TKIP + AES:** This type of data encryption enables WiFi devices that support either WPA or WPA2 to join the access point's WiFi network. This is the default mode.
 - **AES:** This type of data encryption provides a secure connection but some older WiFi devices do not detect WPA2 and support only WPA. Therefore, if your network includes such older devices, select **TKIP + AES** encryption.

When you select **WPA2 Enterprise** authentication, the **Dynamic VLAN** radio buttons display:

- **Enable:** The RADIUS server can assign a VLAN ID to clients. If the RADIUS server does not do so, the clients are automatically assigned the VLAN ID that you configured for the SSID.
- **Disable:** The clients are assigned the VLAN ID that you configured for the SSID. This is the default setting.

- **WPA3 Personal:** This option is the most secure personal authentication option. WPA3 uses SAE encryption and enables only WiFi devices that support WPA3 to join the VAP. If you select this option, 802.11w (PMF) is automatically set to mandatory (see [Enable or disable PMF for a WiFi network](#) on page 75). WPA3 provides a more secure connection than WPA2 but many WiFi devices might not yet detect WPA3 and support only WPA2. If your network also includes WPA2 devices, select **WPA3/WPA2 Personal** authentication. In the **Passphrase** field, enter a phrase of 8 to 63 characters. To join the VAP, a user must enter this passphrase. To view the passphrase in clear text, click the eye icon.
- **WPA3/WPA2 Personal:** This option, which is the same as WPA3/WPA2-PSK, enables WiFi devices that support either WPA3 or WPA2 to join the VAP. This option uses SAE and AES encryption. WPA2-PSK (which uses AES) is less secure than WPA3 (which uses SAE). In the **Passphrase** field, enter a phrase of 8 to 63 characters. To join the VAP, a user must enter this passphrase. To view the passphrase in clear text, click the eye icon.
- **WPA3 Enterprise:** This enterprise-level security uses RADIUS for centralized Authentication, Authorization, and Accounting (AAA) management. For WPA3 Enterprise security to function, you must set up RADIUS servers (see [Set up RADIUS servers](#) on page 129). If you select this option, 802.11w (PMF) is automatically set to mandatory (see [Enable or disable PMF for a WiFi network](#) on page 75). When you select WPA3 Enterprise security, the encryption is automatically set to GCMP256, which is a 256-bit encryption protocol. When you select **WPA3 Enterprise** authentication, the **Dynamic VLAN** radio buttons display:
 - **Enable:** The RADIUS server can assign a VLAN ID to clients. If the RADIUS server does not do so, the clients are automatically assigned the VLAN ID that you configured for the SSID.
 - **Disable:** The clients are assigned the VLAN ID that you configured for the SSID. This is the default setting.

7. Click the **Apply** button.

Your settings are saved.

8. Make sure that you can connect to the new WiFi network.

If you cannot connect to the new WiFi network, check the following:

- If your WiFi-enabled computer or mobile device is already connected to another WiFi network in your area, disconnect it from that WiFi network and connect it to the correct WiFi network. Some WiFi devices automatically connect to the first open network without WiFi security that they discover.

- If your WiFi-enabled computer or mobile device is trying to connect to your network with its old settings (before you changed the settings), update the WiFi network selection in your WiFi-enabled computer or mobile device to match the current settings for your network.
- Does your WiFi device display as a connected client? (See [Display client distribution, connected clients, and client trends](#) on page 186.) If it does, it is connected to the network.
- Are you using the correct WiFi network name (SSID) and password?
- If you changed the WiFi authentication and encryption to WPA3 Personal, make sure that the WiFi adapter device driver is updated to the latest version on your WiFi-enabled computer or mobile device.

Enable or disable PMF for a WiFi network

Protected Management Frames (PMF), according to the 802.11w standard, is a security feature that protects unicast and multicast management frames from being intercepted and changed for malicious purposes. The type of authentication that you select determines if this feature is mandatory, optional, or disabled. You can also set it manually.

To enable or disable PMF for a WiFi network:

1. Launch a web browser from a computer that is connected to the same network as the access point or directly to the access point through an Ethernet cable or WiFi connection.

2. Enter the IP address that is assigned to the access point.

A login window displays.

If your browser displays a security warning, you can proceed, or add an exception for the security warning. For more information, see [What to do if you get a browser security warning](#) on page 42.

3. Enter the access point user name and password.

The user name is **admin**. The password is the one that you specified. The user name and password are case-sensitive.

If you previously added the access point to a NETGEAR Insight network location and managed the access point through the Insight Cloud Portal or Insight app, enter the Insight network password for that location. For more information, see [Connect over WiFi using the NETGEAR Insight app](#) on page 24.

The Dashboard page displays.

4. Select **Management > Configuration > Wireless > Basic**.

The page that displays lets you select an SSID.

5. Click the ► button to the left of the SSID.
The settings for the selected SSID display.
6. Under 802.11w (PMF), select one of the following radio buttons:
 - **Mandatory:** Requires devices to use PMF. Devices that do not support PMF cannot connect to the WiFi network. If you select Enhanced Open authentication, WPA3 Personal authentication, or WPA3 Enterprise authentication, the radio button for PMF is set to **Mandatory**, and you cannot change it.
 - **Optional:** Lets the access point automatically activate PMF based on whether devices can support PMF. If you select WPA3/WPA2 Personal authentication, the radio button for PMF is set to **Optional**, but you can change it.
 - **Disable:** PMF is disabled for the WiFi network. If you select Open, WPA2 Personal, WPA2/WPA Personal, or WPA2 Enterprise authentication, the radio button for PMF is set to **Disabled**, but you can change it (except for Open authentication).
7. Click the **Apply** button.
Your settings are saved.

Set up Multi PSK for a WiFi network

Multi Pre-Shared Key (PSK) lets you segregate a single WiFi network into different VLANs, each accessible with a unique passphrase. In a way, Multi PSK lets you create different sub WiFi networks on a single WiFi network. When connecting to the WiFi network, the passphrase that a user enters determines the VLAN that the WiFi client is placed in.

In addition to a VLAN and passphrase, you can associate a key identifier with the VLAN-to-passphrase mapping. The key identifier lets you identify the VLANs in the WiFi network for network monitoring purposes. For example, when you display WiFi clients, the key identifier can also display (see [Display client distribution, connected clients, and client trends](#) on page 186).

As examples of key identifiers, you could use terms such as corporatenetwork_22, corporatenetwork_23, and corporatenetwork_24. These key identifiers (or the associated VLAN IDs) are not visible to a user trying to connect to the WiFi network: the user sees the SSID and enters the passphrase.

If you enable Multi PSK, the WiFi network's passphrase and VLAN are replaced by the passphrases and VLANs that are part of the Multi PSK configuration.

Note: Multi PSK is supported only if the WiFi security is WPA2 Personal or WPA2/WPA Personal. To configure Multi PSK on the default WiFi network (displayed as SSID1 in the local browser UI), which is the WiFi network that you defined when you initially connected to the access point, you must first change the WiFi security to WPA2 Personal or WPA2/WPA Personal.

In addition, the following restrictions apply to Multi PSK:

- You can configure Multi PSK on a maximum of four WiFi networks.
- Each WiFi network on which you configure Multi PSK can support a maximum of eight VLAN-to-passphrase mappings. (Within each WiFi network, each passphrase and key identifier must be unique.) The access point can support a maximum of 32 Multi PSK VLAN-to-passphrase mappings. For example, four WiFi networks each can support eight Multi PSK VLAN-to-passphrase mappings.
- Within a Multi PSK on a single WiFi network, you can map the same VLAN ID to different passphrases. You can also use the same VLAN ID for Multi PSK in different WiFi networks.
- If inter-VLAN routing is disabled in the network that the access point is connected to, the following applies:
 - WiFi clients that are connected to different VLANs on the same WiFi network (that is, the WiFi clients use different passphrases to connect to the same WiFi network) cannot communicate with each other and remain isolated.
 - WiFi clients that are connected to the *same* VLAN on different WiFi networks *can* communicate with each other.
- Multi PSK and the following features are mutually exclusive:
 - Captive portal (see [Set Up and Manage a Captive Portal](#) on page 97)
 - mDNS gateway (see [Manage the multicast DNS gateway](#) on page 145)
 - NAT mode (see [Set NAT mode or Bridge mode for addressing and traffic](#) on page 199)
 - Client isolation (see [Enable or disable client isolation for a WiFi network](#) on page 200)

To set up Multi PSK for a WiFi network:

1. Launch a web browser from a computer that is connected to the same network as the access point or directly to the access point through an Ethernet cable or WiFi connection.
2. Enter the IP address that is assigned to the access point.
A login window displays.

If your browser displays a security warning, you can proceed, or add an exception for the security warning. For more information, see [What to do if you get a browser security warning](#) on page 42.

3. Enter the access point user name and password.

The user name is **admin**. The password is the one that you specified. The user name and password are case-sensitive.

If you previously added the access point to a NETGEAR Insight network location and managed the access point through the Insight Cloud Portal or Insight app, enter the Insight network password for that location. For more information, see [Connect over WiFi using the NETGEAR Insight app](#) on page 24.

The Dashboard page displays.

4. Select **Management > Configuration > Wireless > Basic**.

The page that displays lets you select an SSID.

5. Click the ► button to the left of the SSID.

The settings for the selected SSID display.







You cannot configure Multi PSK on the default WiFi network (displayed as SSID1 in the local browser UI), which is the WiFi network that you defined when you initially connected to the access point.

6. Select the Multi PSK **Enable** radio button.

The following figure shows examples.

Multi PSK ⓘ

Enable Disable

VLAN ID	Passphrase	Key Identifier	
22 	corporatenetwork_22	
23 	corporatenetwork_23	
24 	corporatenetwork_24	

+ Add New Passphrase

7. Click the + button to the left of Add New Passphrase.

The page adjusts.

8. Configure the Multi PSK settings:
 - **VLAN ID:** The VLAN ID, which is the VLAN that a WiFi client becomes a member of.
 - **Passphrase:** The unique passphrase (WiFi password) that a user must enter to let the WiFi client connect to the associated VLAN of the WiFi network.
 - **Key Identifier:** The phrase or term that lets you identify the VLAN in the WiFi network for monitoring purposes. The maximum length is 30 alphanumeric characters, including the following special characters: hyphen (-) and underscore (_).
9. To add another Multi PSK entry, click the **+** button to the left of Add New Passphrase and repeat the previous step.

To remove a Multi PSK entry, click the trash can icon to the right of the entry.
10. Click the **Apply** button.

Your settings are saved.

Disable or enable a WiFi network or set up a WiFi activity schedule

You can temporarily disable a WiFi network (SSID or VAP), you can reenabling the WiFi network, or you can set up a schedule that specifies when the WiFi network is active.

Scheduling a WiFi network is a green feature that allows you to turn off the WiFi network during scheduled vacations, office shutdowns, on evenings, or on weekends.

For each WiFi network, you can create a single custom schedule. In that schedule, for each day from 12:00 a.m. to 11:59 p.m., you specify the time or times that the VAP is disabled.

To disable or enable a WiFi network or set up a WiFi activity schedule:

1. Launch a web browser from a computer that is connected to the same network as the access point or directly to the access point through an Ethernet cable or WiFi connection.

2. Enter the IP address that is assigned to the access point.

A login window displays.

If your browser displays a security warning, you can proceed, or add an exception for the security warning. For more information, see [What to do if you get a browser security warning](#) on page 42.

3. Enter the access point user name and password.

The user name is **admin**. The password is the one that you specified. The user name and password are case-sensitive.

If you previously added the access point to a NETGEAR Insight network location and managed the access point through the Insight Cloud Portal or Insight app, enter the Insight network password for that location. For more information, see [Connect over WiFi using the NETGEAR Insight app](#) on page 24.

The Dashboard page displays.

4. Select **Management > Configuration > Wireless > Basic**.

The page that displays lets you select an SSID.

5. Click the **>** button to the left of the SSID.

The settings for the selected SSID display.

6. Under Schedule, select one of the following radio buttons:

- **Always ON:** The WiFi network is enabled.
- **Always OFF:** The WiFi network is disabled.
- **Custom:** The WiFi network is enabled or disabled according to a schedule that you must set up.
An icon displays to the right of the radio button.

7. If you selected **Custom** in the previous step, do the following:

- a. Click the icon next to the radio button.

A pop-up window displays.

- b. Either select a predefined time from the **Preset** menu or select custom time blocks by clicking the time blocks.

A blue color for a time block indicates that the WiFi network will be enabled (on).

A gray color for a time block indicates that the WiFi network will be disabled (off).

- c. Click the **Done** button.

The pop-up window closes.

8. Click the **Apply** button.

Your settings are saved.

Enable or disable band steering with 802.11k RRM and 802.11v WiFi network management

Band steering lets the access point identify the WiFi devices that are dual-band capable and steer those devices to the 2.4 GHz or 5 GHz band of a WiFi network (SSID or VAP). Compared to the 2.4 GHz band, generally more channels and bandwidth are available in the 5 GHz band, causing less interference and allowing for a better user experience. Band steering includes 802.11k radio resource management (RRM) and 802.11v WiFi network management. By default, band steering is disabled.

802.11k RRM and 802.11v WiFi network management affect the network in the following ways:qq

- **802.11k RRM:** This feature lets the access point and 802.11k-aware clients dynamically measure the available radio resources. In an 802.11k-enabled network, access points and clients can send neighbor reports, beacon reports, and link measurement reports to each other, allowing 802.11k-aware clients to automatically select the best access point for initial connection or for roaming.
- **802.11v WiFi network management:** This feature lets the access point steer its WiFi clients to the 2.4 GHz or 5 GHz band, based on the access point's channel load. In an environment with multiple access points, 802.11v WiFi network management helps WiFi clients that are roaming to select the best access point.

The access point sets the received signal strength indicator (RSSI) threshold automatically. (That is, you cannot configure the RSSI threshold manually.)

To enable or disable band steering with 802.11k RRM and 802.11v WiFi network management for a WiFi network:

1. Launch a web browser from a computer that is connected to the same network as the access point or directly to the access point through an Ethernet cable or WiFi connection.
2. Enter the IP address that is assigned to the access point.
A login window displays.

If your browser displays a security warning, you can proceed, or add an exception for the security warning. For more information, see [What to do if you get a browser security warning](#) on page 42.

3. Enter the access point user name and password.

The user name is **admin**. The password is the one that you specified. The user name and password are case-sensitive.

If you previously added the access point to a NETGEAR Insight network location and managed the access point through the Insight Cloud Portal or Insight app, enter the

Insight network password for that location. For more information, see [Connect over WiFi using the NETGEAR Insight app](#) on page 24.

The Dashboard page displays.

4. Select **Management > Configuration > Wireless > Basic**.

The page that displays lets you select an SSID.

5. Click the **>** button to the left of the SSID.

The settings for the selected SSID display.

6. Under Band Steering / 802.11 k/v, select one of the following radio buttons:

- **Disable:** Band steering is disabled for the VAP. This is the default setting.
- **Enabled:** Under certain channel conditions, the access point steers WiFi devices that are dual-band capable to the 2.4 GHz or 5 GHz band of the VAP.

7. Click the **Apply** button.

Your settings are saved.

6

Manage the Basic Radio Features

This chapter describes how you can manage the basic radio features of the access point. For information about the advanced radio features, see [Manage the Advanced Radio Features](#) on page 218.

CAUTION: If you change a radio feature on the 2.4 GHz radio, the change affects all WiFi networks that broadcast on the 2.4 GHz radio. Similarly, if you change a radio feature on the 5 GHz radio, the change affects all WiFi networks that broadcast on the 5 GHz radio. If the change is not specific to one radio, the change affects *all* WiFi networks on the access point.

The chapter includes the following sections:

- [Manage the basic WiFi settings for the radios](#)
- [Turn a radio on or off](#)
- [Change the WiFi mode for a radio](#)
- [Change the channel width for a radio](#)
- [Change the guard interval for a radio](#)
- [Change the output power for a radio](#)
- [Change the channel for a radio](#)
- [Manage Quality of Service for a WiFi radio](#)

Note: If you want to change the radio settings, use a wired connection to avoid being disconnected when the new radio settings take effect.

Note: In this manual, *WiFi network* means the same as SSID (service set identifier or WiFi network name) or VAP (virtual access point). That is, when we refer to a WiFi network we mean an individual SSID or VAP.

Manage the basic WiFi settings for the radios

The basic WiFi settings for each radio apply to all WiFi networks (VAPs or SSIDs) that are configured on the radio. You can specify the radio settings for the 2.4 GHz and 5 GHz radios individually.

To manage the basic WiFi settings for the radios:

1. Launch a web browser from a computer that is connected to the same network as the access point or directly to the access point through an Ethernet cable or WiFi connection.

2. Enter the IP address that is assigned to the access point.

A login window displays.

If your browser displays a security warning, you can proceed, or add an exception for the security warning. For more information, see [What to do if you get a browser security warning](#) on page 42.

3. Enter the access point user name and password.

The user name is **admin**. The password is the one that you specified. The user name and password are case-sensitive.

If you previously added the access point to a NETGEAR Insight network location and managed the access point through the Insight Cloud Portal or Insight app, enter the Insight network password for that location. For more information, see [Connect over WiFi using the NETGEAR Insight app](#) on page 24.

The Dashboard page displays.

4. Select **Management > Configuration > Wireless > Basic > Wireless Settings**.

The screenshot displays the configuration interface for the wireless settings. It is divided into two main sections: 2.4 GHz and 5 GHz. Each section has a 'Turn Radio ON' checkbox, which is checked in both. Under 'Wireless Mode', there are radio buttons for 11b, 11bg, 11ng, and 11ax. In the 2.4 GHz section, 11ax is selected. In the 5 GHz section, 11ax is also selected. 'Channel Width' is set to 20 MHz for 2.4 GHz and 40 MHz for 5 GHz. 'Guard Interval' is set to Long-800 ns for both. 'Output Power' is set to 100%(Max) for both. 'Channel' is set to Auto for both. At the bottom, there are 'Cancel' and 'Apply' buttons.

The following descriptions apply to both radios, but you can specify the radio settings for the 2.4 GHz and 5 GHz radios individually.

5. Configure the following settings:

- **Turn Radio ON:** By default, the **Turn Radio ON** check box is selected and the radio broadcasts. Turning off a radio disables WiFi access for the band, which can be helpful during configuration, network tuning, or troubleshooting.
- **Wireless Mode:**
Select one of the following wireless modes (WiFi modes) for the 2.4 GHz radio:
 - **11ax:** 802.11ax, 802.11ng, 802.11bg, and 802.11b WiFi clients can connect to the access point. This is the default setting.
 - **11ng:** 802.11ax, 802.11ng, 802.11bg, and 802.11b WiFi clients can connect to the access point. However, the speed of 802.11ax clients is limited to the maximum speed that is supported by 802.11ng (about 400 Mbps).
 - **11bg:** 802.11ax, 802.11ng, 802.11bg, and 802.11b WiFi clients can connect to the access point. However, the speed of 802.11ax and 802.11ng clients is limited to the maximum speed that is supported by 802.11bg (about 54 Mbps).
 - **11b:** 802.11ax, 802.11ng, 802.11bg, and 802.11b WiFi clients can connect to the access point. However, the speed of 802.11ax, 802.11n, and 802.11bg clients is limited to the maximum speed that is supported by 802.11b (about 11 Mbps).

Select one of the following wireless modes (WiFi modes) for the 5 GHz radio:

- **11ax:** 802.11ax, 802.11ac, 802.11na, and 802.11a WiFi clients can connect to the access point. This is the default setting.
 - **11ac:** 802.11ax, 802.11ac, 802.11na, and 802.11a WiFi clients can connect to the access point. However, the speed of 802.11ax clients is limited to the maximum speed that is supported by 802.11ac (about 867 Mbps).
 - **11na:** 802.11ax, 802.11ac, 802.11na, and 802.11a WiFi clients can connect to the access point. However, the speed of 802.11ax and 802.11ac clients is limited to the maximum speed that is supported by 802.11na (about 450 Mbps).
 - **11a:** 802.11ax, 802.11ac, 802.11na, and 802.11a WiFi clients can connect to the access point. However, the speed of 802.11ax, 802.11ac, 802.11na clients is limited to the maximum speed that is supported by 802.11a (up to about 54 Mbps).
- **Channel Width:** From the menu, select the channel width for the radio. Your selection from the **Wireless Mode** menu determines if you can set the channel width, and if so, which channel widths are available. Use the following guidelines:
 - A wider channel improves the performance (no or minimal interference and better data rates).
 - The 802.11n specification allows a 40 MHz-wide channel in addition to the legacy 20 MHz channel that is available with other modes.
 - The 802.11ac specification allows an 80 MHz-wide channel in addition to the 20 MHz and 40 MHz channels that are available with other modes.
 - The 802.11ax specification for the 5 GHz radio allows a 160 MHz-wide channel in addition to the 20 MHz, 40 MHz, and 80 MHz channels that are available with other WiFi modes.
 - The 40 MHz, 80 MHz, and 160 MHz channels enable higher data rates but leave fewer channels available for use on the 5 GHz radio.

For more information, see [Change the channel width for a radio](#) on page 90.

- **Guard Interval:** From the menu, select the transmission power of the radio. You can select **100%(Max)**, **50%**, **25%**, **12.5%**, or **4%(Min)**. The default is 100%(Max).

Note: If two or more access points are operating in the same area and on the same channel, interference can occur. In this situation, you might want to decrease the output power for the access point. Make sure that you comply with the regulatory requirements for total radio frequency (RF) output power in your country.

- **Channel:** From the menu, select the WiFi channel for the radio. The available WiFi channels and frequencies depend on the country that you selected for the access point and on the radio. The default is Auto, which enables a radio to automatically select the most suitable channel.

Note: You do not need to change the WiFi channel unless you experience interference (which is indicated by lost connections).

Note: If you use multiple access points, reduce interference by selecting different channels for adjacent access points. We recommend a channel spacing of four channels between adjacent access points (for example, in the 2.4 GHz band, use channels 1 and 5, or 6 and 10).

6. Click the **Apply** button.

A warning pop-up window displays.

7. Click the **OK** button.

The pop-up window closes and your settings are saved. The radio or radios restart and WiFi clients might need to reconnect.

Turn a radio on or off

By default, both the 2.4 GHz and 5 GHz radios broadcast. Turning off a radio disables WiFi access for the associated band, which affects all WiFi networks (VAPs or SSIDs) in that band. Turning off a radio can be helpful during configuration, network tuning, or troubleshooting.

To turn a radio on or off:

1. Launch a web browser from a computer that is connected to the same network as the access point or directly to the access point through an Ethernet cable or WiFi connection.

2. Enter the IP address that is assigned to the access point.

A login window displays.

If your browser displays a security warning, you can proceed, or add an exception for the security warning. For more information, see [What to do if you get a browser security warning](#) on page 42.

3. Enter the access point user name and password.

The user name is **admin**. The password is the one that you specified. The user name and password are case-sensitive.

If you previously added the access point to a NETGEAR Insight network location and managed the access point through the Insight Cloud Portal or Insight app, enter the Insight network password for that location. For more information, see [Connect over WiFi using the NETGEAR Insight app](#) on page 24.

The Dashboard page displays.

4. Select **Management > Configuration > Wireless > Basic > Wireless Settings**.

The Wireless Settings page displays.

5. Take one of the following actions:

- **Turn a radio on:** Select the **Turn Radio ON** check box for the radio.
- **Turn a radio off:** Clear the **Turn Radio ON** check box for the radio.

6. Click the **Apply** button.

A warning pop-up window displays.

7. Click the **OK** button.

The pop-up window closes and your settings are saved. The radio or radios restart and WiFi clients might need to reconnect.

Change the WiFi mode for a radio

By default, all types of WiFi clients can access a WiFi network on the access point, that is, the WiFi modes on the access point support 802.11ax, 802.11ac, 802.11na, 802.11ng, 802.11bg, 802.11b, and 802.11a clients. You can change the WiFi modes to limit access to certain types of clients.

To change the WiFi mode for a radio:

1. Launch a web browser from a computer that is connected to the same network as the access point or directly to the access point through an Ethernet cable or WiFi connection.

2. Enter the IP address that is assigned to the access point.

A login window displays.

If your browser displays a security warning, you can proceed, or add an exception for the security warning. For more information, see [What to do if you get a browser security warning](#) on page 42.

3. Enter the access point user name and password.

The user name is **admin**. The password is the one that you specified. The user name and password are case-sensitive.

If you previously added the access point to a NETGEAR Insight network location and managed the access point through the Insight Cloud Portal or Insight app, enter the Insight network password for that location. For more information, see [Connect over WiFi using the NETGEAR Insight app](#) on page 24.

The Dashboard page displays.

4. Select **Management > Configuration > Wireless > Basic > Wireless Settings**.

The Wireless Settings page displays.

5. Select the WiFi mode for the radio:

- **2.4 GHz radio:** Select one of the following WiFi modes for the 2.4 GHz radio:
 - **11ax:** 802.11ax, 802.11ng, 802.11bg, and 802.11b WiFi clients can connect to the access point. This is the default setting.
 - **11ng:** 802.11ax, 802.11ng, 802.11bg, and 802.11b WiFi clients can connect to the access point. However, the speed of 802.11ax clients is limited to the maximum speed that is supported by 802.11ng (about 400 Mbps).
 - **11bg:** 802.11ax, 802.11ng, 802.11bg, and 802.11b WiFi clients can connect to the access point. However, the speed of 802.11ax and 802.11ng clients is limited to the maximum speed that is supported by 802.11bg (about 54 Mbps).
 - **11b:** 802.11ax, 802.11ng, 802.11bg, and 802.11b WiFi clients can connect to the access point. However, the speed of 802.11ax, 802.11n, and 802.11bg clients is limited to the maximum speed that is supported by 802.11b (about 11 Mbps).
- **5 GHz radio:** Select one of the following WiFi modes for the 5 GHz radio:
 - **11ax:** 802.11ax, 802.11ac, 802.11na, and 802.11a WiFi clients can connect to the access point. This is the default setting.
 - **11ac:** 802.11ax, 802.11ac, 802.11na, and 802.11a WiFi clients can connect to the access point. However, the speed of 802.11ax clients is limited to the maximum speed that is supported by 802.11ac (about 867 Mbps).
 - **11na:** 802.11ax, 802.11ac, 802.11na, and 802.11a WiFi clients can connect to the access point. However, the speed of 802.11ax and 802.11ac clients is limited to the maximum speed that is supported by 802.11na (about 450 Mbps).
 - **11a:** 802.11ax, 802.11ac, 802.11na, and 802.11a WiFi clients can connect to the access point. However, the speed of 802.11ax, 802.11ac, 802.11na clients is limited to the maximum speed that is supported by 802.11a (up to about 54 Mbps).

6. Click the **Apply** button.

A warning pop-up window displays.

7. Click the **OK** button.

The pop-up window closes and your settings are saved. The radio or radios restart and WiFi clients might need to reconnect.

Change the channel width for a radio

Use the following guidelines when you determine the channel width for a radio:

- A wider channel generally improves the performance (no or minimal interference and better data rates).
- A narrower channel generally results in lower throughput but might provide a more stable connection in a demanding situation, such as an environment with a long distance between the access point and WiFi clients and more than normal interference.
- The 802.11n specification allows a 40 MHz-wide channel in addition to the legacy 20 MHz channel that is available with other WiFi modes.
- The 802.11ac specification and the 802.11ax specification for the 5 GHz band allow an 80 MHz-wide channel in addition to the 20 MHz and 40 MHz channels that are available with other WiFi modes.
- The 802.11ax specification for the 5 GHz radio allows a 160 MHz-wide channel in addition to the 20 MHz, 40 MHz, and 80 MHz channels that are available with other WiFi modes.
- The 40 MHz, 80 MHz, and 160 MHz channels enable higher data rates but leave fewer channels available for use on the 5 GHz radio.

Note: We recommend that you leave the default options (20 MHz for the 2.4 GHz radio and 40 MHz for the 5 GHz radios).

The WiFi mode (see [Change the WiFi mode for a radio](#) on page 88) determines if you can set the channel width, and if so, which channel widths are available.

To change the channel width for a radio:

1. Launch a web browser from a computer that is connected to the same network as the access point or directly to the access point through an Ethernet cable or WiFi connection.

2. Enter the IP address that is assigned to the access point.

A login window displays.

If your browser displays a security warning, you can proceed, or add an exception for the security warning. For more information, see [What to do if you get a browser security warning](#) on page 42.

3. Enter the access point user name and password.

The user name is **admin**. The password is the one that you specified. The user name and password are case-sensitive.

If you previously added the access point to a NETGEAR Insight network location and managed the access point through the Insight Cloud Portal or Insight app, enter the Insight network password for that location. For more information, see [Connect over WiFi using the NETGEAR Insight app](#) on page 24.

The Dashboard page displays.

4. Select **Management > Configuration > Wireless > Basic > Wireless Settings**.

The Wireless Settings page displays.

5. From the **Channel Width** menu for the radio, select one of the following settings.

- **20 MHz**: This is the default setting for the 2.4 GHz radio.
- **40 MHz**: This is the default settings for the 5 GHz radio.
- **80 MHz**: This selection is available only for the 5 GHz radio.
- **160 MHz**: This selection is available only for the 5 GHz radio.
- **Dynamic 20 / 40 MHz**. This selection is available only for the 2.4 GHz radio.
- **Dynamic 20 / 40 / 80 / 160 MHz**. This selection is available only for the 5 GHz radio.

6. Click the **Apply** button.

A warning pop-up window displays.

7. Click the **OK** button.

The pop-up window closes and your settings are saved. The radio or radios restart and WiFi clients might need to reconnect.

Change the guard interval for a radio

From the menu, select the guard interval, which protects radio transmissions from interference. The WiFi mode (see [Change the WiFi mode for a radio](#) on page 88) determines if you can set the guard interval, and if so, which guard intervals are available. For the 11a, 11b, and 11bg WiFi modes, you cannot set the guard interval at all.

Use the following guidelines:

- A shorter guard interval supports more throughput in an environment in which WiFi devices operate at a shorter distance from the access point.
- A longer guard interval works well in an environment with multiple SSIDs and WiFi devices that operate at a longer distance from the access point.
- Some legacy devices can operate with a long -800ns guard interval only.

To change the guard interval for a radio:

1. Launch a web browser from a computer that is connected to the same network as the access point or directly to the access point through an Ethernet cable or WiFi connection.

2. Enter the IP address that is assigned to the access point.

A login window displays.

If your browser displays a security warning, you can proceed, or add an exception for the security warning. For more information, see [What to do if you get a browser security warning](#) on page 42.

3. Enter the access point user name and password.

The user name is **admin**. The password is the one that you specified. The user name and password are case-sensitive.

If you previously added the access point to a NETGEAR Insight network location and managed the access point through the Insight Cloud Portal or Insight app, enter the Insight network password for that location. For more information, see [Connect over WiFi using the NETGEAR Insight app](#) on page 24.

The Dashboard page displays.

4. Select **Management > Configuration > Wireless > Basic > Wireless Settings**.

The Wireless Settings page displays.

5. From the **Guard Interval** menu for the radio, select one of the following settings:

- **Auto**: The guard interval is set automatically by the access point. This option is not available in the 11ax WiFi mode.
- **Long-800 ns**: This option is available in the 11ax, 11ac, 11na, and 11ng modes. In the 11ax WiFi mode, this option is the default setting.
- **Double Long-1600 ns**: This option is available only in the 11ax WiFi mode.
- **Quadruple Long-3200 ns**: This option is available only in the 11ax WiFi mode.

6. Click the **Apply** button.

A warning pop-up window displays.

7. Click the **OK** button.

The pop-up window closes and your settings are saved. The radio or radios restart and WiFi clients might need to reconnect.

Change the output power for a radio

By default, the output power of the access point is set at the maximum. If two or more access points are operating in the same area and on the same channel, interference can occur. In such a situation, you might want to decrease the output power for the access point. Make sure that you comply with the regulatory requirements for total radio frequency (RF) output power in your country.

To change the output power for a radio:

1. Launch a web browser from a computer that is connected to the same network as the access point or directly to the access point through an Ethernet cable or WiFi connection.

2. Enter the IP address that is assigned to the access point.

A login window displays.

If your browser displays a security warning, you can proceed, or add an exception for the security warning. For more information, see [What to do if you get a browser security warning](#) on page 42.

3. Enter the access point user name and password.

The user name is **admin**. The password is the one that you specified. The user name and password are case-sensitive.

If you previously added the access point to a NETGEAR Insight network location and managed the access point through the Insight Cloud Portal or Insight app, enter the Insight network password for that location. For more information, see [Connect over WiFi using the NETGEAR Insight app](#) on page 24.

The Dashboard page displays.

4. Select **Management > Configuration > Wireless > Basic > Wireless Settings**.

The Wireless Settings page displays.

5. From the **Output Power** menu for the radio, select **100%(Max)**, **50%**, **25%**, **12.5%**, or **4%(Min)**.

The default is 100%(Max).

6. Click the **Apply** button.

A warning pop-up window displays.

7. Click the **OK** button.

The pop-up window closes and your settings are saved. The radio or radios restart and WiFi clients might need to reconnect.

Change the channel for a radio

The available WiFi channels and frequencies depend on the country that you select for the access point and the radio. The default is Auto, which enables a radio to automatically select the most suitable channel.

Note: You do not need to change the WiFi channel unless you experience interference (which is indicated by lost connections).

Note: If you use multiple access points, reduce interference by selecting different channels for adjacent access points. We recommend a channel spacing of four channels between adjacent access points (for example, in the 2.4 GHz band, use channels 1 and 5, or 6 and 10).

To change the channel for a radio:

1. Launch a web browser from a computer that is connected to the same network as the access point or directly to the access point through an Ethernet cable or WiFi connection.

2. Enter the IP address that is assigned to the access point.

A login window displays.

If your browser displays a security warning, you can proceed, or add an exception for the security warning. For more information, see [What to do if you get a browser security warning](#) on page 42.

3. Enter the access point user name and password.

The user name is **admin**. The password is the one that you specified. The user name and password are case-sensitive.

If you previously added the access point to a NETGEAR Insight network location and managed the access point through the Insight Cloud Portal or Insight app, enter the Insight network password for that location. For more information, see [Connect over WiFi using the NETGEAR Insight app](#) on page 24.

The Dashboard page displays.

4. Select **Management > Configuration > Wireless > Basic > Wireless Settings**.

The Wireless Settings page displays.

5. From the **Channel** menu for the radio, select a channel.
The default is Auto. When you select a particular channel, the channel selection becomes static.
6. Click the **Apply** button.
A warning pop-up window displays.
7. Click the **OK** button.
The pop-up window closes and your settings are saved. The radio or radios restart and WiFi clients might need to reconnect.

Manage Quality of Service for a WiFi radio

You can specify the Quality of Service (QoS) setting for the 2.4 GHz and 5 GHz radios separately. These settings are enabled by default for both radios. Disabling QoS for a radio might impact the throughput and speed of WiFi traffic on the access point.

To manage the QoS settings for a WiFi radio:

1. Launch a web browser from a computer that is connected to the same network as the access point or directly to the access point through an Ethernet cable or WiFi connection.
2. Enter the IP address that is assigned to the access point.
A login window displays.
If your browser displays a security warning, you can proceed, or add an exception for the security warning. For more information, see [What to do if you get a browser security warning](#) on page 42.
3. Enter the access point user name and password.
The user name is **admin**. The password is the one that you specified. The user name and password are case-sensitive.
If you previously added the access point to a NETGEAR Insight network location and managed the access point through the Insight Cloud Portal or Insight app, enter the Insight network password for that location. For more information, see [Connect over WiFi using the NETGEAR Insight app](#) on page 24.
The Dashboard page displays.
4. Select **Management > Configuration > Wireless > Basic > QoS Settings**.
The QoS Settings page displays.

5. Enable or disable the following features for the radio by selecting the applicable **Enable** or **Disable** radio buttons:
 - **Wi-Fi Multimedia (WMM):** WiFi Multimedia (WMM) is a subset of the 802.11e standard. Time-dependent information such as video or audio is given higher priority than normal traffic. For WMM to function correctly, WiFi clients must also support WMM. By enabling WMM, you allow WMM to control upstream traffic flowing from WiFi devices to the access point and downstream traffic flowing from the access point to WiFi devices. WMM defines the following four queues in decreasing order of priority:
 - **Voice:** The highest priority queue with minimum delay, which makes it very suitable for applications such as VoIP and streaming media.
 - **Video:** The second highest priority queue with low delay. Video applications are routed to this queue.
 - **Best effort:** The medium priority queue with medium delay. Most standard IP applications use this queue.
 - **Background:** The low priority queue with high throughput. Applications such as FTP that are not time-sensitive but require high throughput can use this queue.
 - **WMM Powersave:** Enabling the WMM Powersave feature saves power for battery-powered devices and fine-tunes power consumption.
6. Click the **Apply** button.
A warning pop-up window displays.
7. Click the **OK** button.
The pop-up window closes and your settings are saved. The radio or radios restart and WiFi clients might need to reconnect.

7

Set Up and Manage a Captive Portal

This chapter describes how you can set up and manage a captive portal on the access point.

A captive portal is a web page that users see when they attempt to connect to a WiFi network. A captive portal includes a splash page and usually requires some form of authentication for the user. The access point supports three types of captive portals:

- **Click-through captive portal:** A basic portal for which the splash page is stored on the access point. For each WiFi network, you can set up a unique click-through captive portal.
- **External captive portal:** A portal that is hosted by an external captive portal vendor. You can apply an external captive portal to multiple WiFi networks or you can apply a unique external captive portal to each WiFi network.
- **Facebook Wi-Fi captive portal:** A Facebook business page that serves as a portal. You can configure a single Facebook Wi-Fi captive portal on the access point but you can apply it to multiple WiFi networks.

The chapter includes the following sections:

- [Set up a click-through captive portal for a WiFi network](#)
- [Set up an external captive portal for a WiFi network](#)
- [Register and configure Facebook Wi-Fi for the access point](#)
- [Set up a Facebook Wi-Fi captive portal for a WiFi network](#)
- [Unregister the access point from Facebook Wi-Fi](#)

Note: A captive portal is not compatible with Multi PSK. To enable a captive portal, first disable Multi PSK (see [Set up Multi PSK for a WiFi network](#) on page 76).

Note: In this manual, *WiFi network* means the same as SSID (service set identifier or WiFi network name) or VAP (virtual access point). That is, when we refer to a WiFi network we mean an individual SSID or VAP.

Set up a click-through captive portal for a WiFi network

A click-through captive portal is a basic portal for which the splash page is stored on the access point, that is, it is not an external captive portal. Use a click-through captive portal to welcome or instruct WiFi users and limit their sessions. You can require users to agree to an end user license agreement (EULA) and redirect them to a specific website. A click-through captive portal is specific to the WiFi network (SSID) on which you set it up.

To set up a click-through captive portal for a WiFi network:

1. Launch a web browser from a computer that is connected to the same network as the access point or directly to the access point through an Ethernet cable or WiFi connection.

2. Enter the IP address that is assigned to the access point.

A login window displays.

If your browser displays a security warning, you can proceed, or add an exception for the security warning. For more information, see [What to do if you get a browser security warning](#) on page 42.

3. Enter the access point user name and password.

The user name is **admin**. The password is the one that you specified. The user name and password are case-sensitive.

If you previously added the access point to a NETGEAR Insight network location and managed the access point through the Insight Cloud Portal or Insight app, enter the Insight network password for that location. For more information, see [Connect over WiFi using the NETGEAR Insight app](#) on page 24.

The Dashboard page displays.

4. Select **Management > Configuration > Wireless > Basic**.

The page that displays lets you select an SSID.

5. Click the ► button to the left of the SSID.

The settings for the selected SSID display.

6. Scroll down and click the ► **Advanced** tab.

The page expands.

7. Select the **Captive Portal** check box.

The page adjusts. By default, the **Click Through** radio button is selected.

Insight Managed WiFi 6 AX3000 Access Point Model WAX618

Captive Portal

Click Through ⓘ Facebook Wi-Fi ⓘ External Captive Portal ⓘ

Session Timeout (in min)

Redirect URL

Title

Message

JPEG/JPG Image (Max 500KB)

No file

EULA (Max 1KB)

This usage agreement governs your use of the Internet services provided. The use of this hotspot is voluntarily given and may be rescinded without advanced notice. The user is not entitled to any compensation for damages, real or imagined, incurred while using the hotspot. The user agrees not to:

- 1) Transmit or participate in the transmission of materials in violation of local or national laws and regulations.
- 2) Send large quantities of unsolicited email (spam).
- 3) Restrict or hinder the free usage of this hotspot by other users.
- 4) Attack another user, website or service provider with a denial of service attack or otherwise.

8. Specify the click-through settings as described in the following table.

Setting	Description
Session Timeout (in min)	Enter the number of minutes from 1 to 1440 after which a WiFi session is terminated and a user must log in again. The default is 60 minutes.
Redirect URL	To redirect a user to a specific website after login, select the Redirect URL check box and enter the URL. If the Redirect URL check box is cleared, a user is directed to the default web page.
Title	Enter the title that is displayed on the captive portal login page. If you do not customize the title, the default title displays on the captive portal login page.
Message	Enter a message to the user. This message is displayed on the captive portal login page. If you do not customize the message, the default message displays on the captive portal login page.

(Continued)

Setting	Description
JPEG/JPG Image (Max 500 KB)	To customize the image that is displayed on the captive portal login page, click the Browse button and navigate to and select an image. If you do not customize the image, the default image displays on the captive portal login page.
EULA (Max 1 KB)	The field includes a default end user license agreement (EULA). You can enter or copy custom text into the field. To show the EULA on the captive portal login page, select the EULA check box.

- To preview the captive portal login page, click the **Preview** button.

The following figure shows an example (that is, the figure does not show the default captive portal but a customized one).

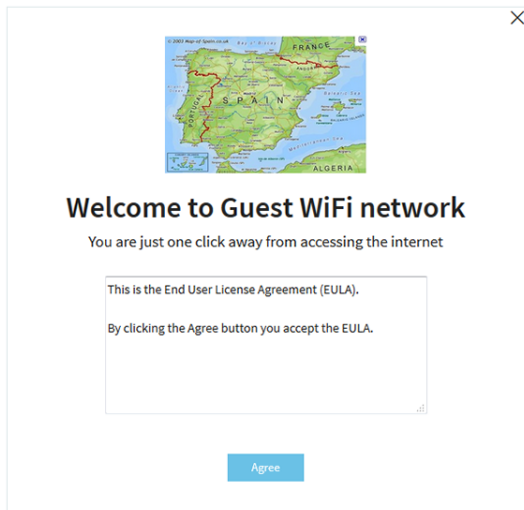

- Click the **Apply** button.

Your settings are saved. WiFi clients attempting to connect to the SSID are presented with the captive portal login page.

Note: An HTTPS session is blocked until after the captive portal authentication occurs.

Set up an external captive portal for a WiFi network

An external captive portal is a portal that is hosted by an external captive portal vendor. That is, this type of portal is not stored on the access point. For an external captive portal, you generally must register your devices with and purchase licenses from the vendor.

You can apply an external captive portal to multiple WiFi networks or you can apply a unique external captive portal to each WiFi network

To set up an external captive portal for a WiFi network:

1. Launch a web browser from a computer that is connected to the same network as the access point or directly to the access point through an Ethernet cable or WiFi connection.

2. Enter the IP address that is assigned to the access point.
A login window displays.

If your browser displays a security warning, you can proceed, or add an exception for the security warning. For more information, see [What to do if you get a browser security warning](#) on page 42.

3. Enter the access point user name and password.

The user name is **admin**. The password is the one that you specified. The user name and password are case-sensitive.

If you previously added the access point to a NETGEAR Insight network location and managed the access point through the Insight Cloud Portal or Insight app, enter the Insight network password for that location. For more information, see [Connect over WiFi using the NETGEAR Insight app](#) on page 24.

The Dashboard page displays.

4. Select **Management > Configuration > Wireless > Basic**.

The page that displays lets you select an SSID.

5. Click the ► button to the left of the SSID.

The settings for the selected SSID display.

6. Scroll down and click the ► **Advanced** tab.

The page expands.

7. Select the **Captive Portal** check box.

The page adjusts. By default, the **Click-Through** radio button is selected.

8. Click the **External Captive Portal** radio button.

Captive Portal

Click Through Facebook Wi-Fi External Captive Portal

Splash Page URL

Captive Portal Authentication Type

Web/HTTP Radius

Web Authentication URL

Key

Secret

FailSafe Enable Disable

Allow HTTPS Enable Disable

Walled Garden

Select-all

Example:

- *.splashpage.com
- *.externalCP.com

9. In the **Splash Page URL** field, enter the URL that is provided by the vendor. This URL redirects a user to the splash page on the website that hosts the captive portal.

10. Select one of the following **Captive Portal Authentication Type** radio buttons:

- **Web/HTTP:** Authentication for access to the splash page occurs on the access point using the HTTPS protocol. Specify the following settings:
 - **Web Authentication URL:** Enter the web authentication URL that is provided by the vendor.
 - **Key:** Enter the key credential that is provided by the vendor. This field is optional and depends on the authentication requirements of the vendor.
 - **Secret:** Enter the secret credential that is provided by the vendor. This field is optional and depends on the authentication requirements of the vendor.
- **Radius:** Authentication for access to the splash page occurs on an external RADIUS authentication server. The vendor might also require an accounting RADIUS

server. Specify the following settings for *each* RADIUS server, as directed by the vendor:

- **IPv4 Address:** Enter the IP address of the server. The IP address is provided by the vendor.
- **Port:** Enter the port number that is used by the server. The IP port number is provided by the vendor. By default, an authentication server uses port number 1812; an accounting server uses port number 1813.
- **Password:** Enter the password (shared secret) for interaction with the server. The password is provided by the vendor.

11. Select one of the following **FailSafe** buttons to specify if users are allowed to reach the splash page and access the Internet if authentication is not possible:

- **Enable:** If authentication is not possible—for example, because captive portal servers do not respond—users are still allowed to access the Internet for a period of 30 minutes.
- **Disable:** This is the default setting. If authentication is not possible, users cannot reach the splash page and cannot access the Internet. Instead, they get a message *Oops. Something went wrong. Please try after some time.*

12. Select one of the following **Allow HTTPS** buttons to specify when secure HTTP (HTTPS) traffic is allowed to pass through:

- **Enable:** Before authentication occurs, HTTPS traffic is allowed to pass through.
- **Disable:** This is the default setting. HTTPS traffic is allowed only *after* authentication occurs.

13. Configure the walled garden settings.

The walled garden specifies the external applications and sites that a user can access from the captive portal. Generally, the vendor provides information about the applications and sites. The vendor splash page, domain name, and authentication servers must also be included in the walled garden. Follow the directions of the vendor.

You can do the following to configure the walled garden:

- **Add a single URL:** In the right field, type the URL, press **Enter**, and click the **Move** button.
- **Add multiple URLs:** In the right field, paste a list of URLs, and click the **Move** button.
- **Remove one or more URLs:** Select the check boxes for URLs, and click the **Remove** button.

- **Remove all URLs:** Select the **Select All** check box, and click the **Remove** button.

14. Click the **Apply** button.

Your settings are saved. WiFi clients attempting to connect to the SSID are presented with the captive portal login page.

Register and configure Facebook Wi-Fi for the access point

Before you can set up Facebook Wi-Fi on the access point so that you can provide customers WiFi access by letting them check in to an existing Facebook business page (see [Set up a Facebook Wi-Fi captive portal for a WiFi network](#) on page 106), you must register the access point with Facebook and configure the Facebook settings. By default, the capability to register is disabled.

To register and configure Facebook Wi-Fi for the access point:

1. Launch a web browser from a computer that is connected to the same network as the access point or directly to the access point through an Ethernet cable or WiFi connection.
2. Enter the IP address that is assigned to the access point.
A login window displays.
If your browser displays a security warning, you can proceed, or add an exception for the security warning. For more information, see [What to do if you get a browser security warning](#) on page 42.
3. Enter the access point user name and password.
The user name is **admin**. The password is the one that you specified. The user name and password are case-sensitive.
If you previously added the access point to a NETGEAR Insight network location and managed the access point through the Insight Cloud Portal or Insight app, enter the Insight network password for that location. For more information, see [Connect over WiFi using the NETGEAR Insight app](#) on page 24.
The Dashboard page displays.
4. Select **Management > Configuration > Wireless > Basic > Facebook Wi-Fi**.
The Facebook Wi-Fi page displays.
5. Select the Register with Facebook Wi-Fi **Yes** radio button.
The capability to register is enabled. By default, this capability is disabled.

6. Click the **Apply** button.
Your settings are saved and the **Add Page** button displays.
7. Click the **Add Page** button.
A pop-up window displays.
8. Click the **OK** button.
The pop-up window closes.
A browser page launches and displays a Facebook page.

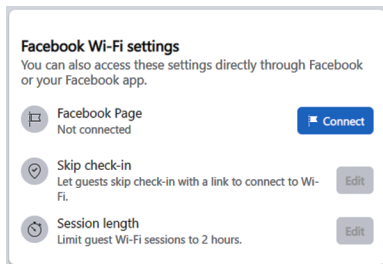

9. Configure the Facebook Wi-Fi settings:
 - a. Click the **Connect** button to log in to the account with which the Facebook business page is associated and select the page.
When you select the page, the page is associated with the access point.
 - b. On the Facebook Wi-Fi settings page, click the **Save** button.
Your settings are saved.
 - c. To let clients skip check-in, click the Skip check in **Edit** button, and configure the settings.
 - d. To limit the session length, click the Session length **Edit** button, and configure the settings.
Clients are automatically logged out when the session length is exceeded.
10. Refresh the page in the local browser UI.
11. To allow clients that are connected to the Facebook captive portal to establish a secure HTTP (HTTPS) session *before* the captive portal authentication occurs, select the Allow HTTPS **Enable** radio button.
By default, the Allow HTTPS **Disable** radio button is selected and clients that are connected to the Facebook captive portal cannot establish an HTTPS session until after the captive portal authentication occurs.
12. Click the **Apply** button.
Your settings are saved.

Set up a Facebook Wi-Fi captive portal for a WiFi network

You can provide customers WiFi access by letting them check in to a Facebook business page. Before you can do so, you must register the access point with Facebook Wi-Fi (see [Register and configure Facebook Wi-Fi for the access point](#) on page 104).

To set up a Facebook Wi-Fi captive portal for a WiFi network:

1. Launch a web browser from a computer that is connected to the same network as the access point or directly to the access point through an Ethernet cable or WiFi connection.

2. Enter the IP address that is assigned to the access point.

A login window displays.

If your browser displays a security warning, you can proceed, or add an exception for the security warning. For more information, see [What to do if you get a browser security warning](#) on page 42.

3. Enter the access point user name and password.

The user name is **admin**. The password is the one that you specified. The user name and password are case-sensitive.

If you previously added the access point to a NETGEAR Insight network location and managed the access point through the Insight Cloud Portal or Insight app, enter the Insight network password for that location. For more information, see [Connect over WiFi using the NETGEAR Insight app](#) on page 24.

The Dashboard page displays.

4. Select **Management > Configuration > Wireless > Basic**.

The page that displays lets you select an SSID.

5. Click the ► button to the left of the SSID.

The settings for the selected SSID display.

6. Scroll down and click the ► **Advanced** tab.

The page expands.

7. Select the **Captive Portal** check box.

The page adjusts. By default, the **Click Through** radio button is selected.

8. Select the **Facebook Wi-Fi** radio button.

The page adjusts again because you do not need to specify any further settings on the page.

Customers receive WiFi access by checking in to a Facebook business page. To use this option, first register the access point with Facebook Wi-Fi and configure the Facebook settings (see [Register and configure Facebook Wi-Fi for the access point](#) on page 104).

9. Click the **Apply** button.

Your settings are saved. WiFi clients attempting to connect to the SSID are presented with the Facebook business page.

Note: When you set up a captive portal with Facebook Wi-Fi, you can configure the option to allow clients that are connected to the Facebook captive portal to establish a secure HTTP (HTTPS) session *before* the captive portal authentication occurs (see [Register and configure Facebook Wi-Fi for the access point](#) on page 104).

Unregister the access point from Facebook Wi-Fi

If the access point is registered with Facebook Wi-Fi but you no longer want to use that option for a captive portal or you want to use another Facebook account, you can unregister the access point from Facebook Wi-Fi and remove the access point's entry.

To unregister the access point from Facebook Wi-Fi and remove the access point's entry:

1. Launch a web browser from a computer that is connected to the same network as the access point or directly to the access point through an Ethernet cable or WiFi connection.
2. Enter the IP address that is assigned to the access point.

A login window displays.

If your browser displays a security warning, you can proceed, or add an exception for the security warning. For more information, see [What to do if you get a browser security warning](#) on page 42.

3. Enter the access point user name and password.

The user name is **admin**. The password is the one that you specified. The user name and password are case-sensitive.

If you previously added the access point to a NETGEAR Insight network location and managed the access point through the Insight Cloud Portal or Insight app, enter the

Insight network password for that location. For more information, see [Connect over WiFi using the NETGEAR Insight app](#) on page 24.

The Dashboard page displays.

4. Select **Management > Configuration > Wireless > Basic > Facebook Wi-Fi**.

The Facebook Wi-Fi page displays.

5. Select the **No** radio button.

The capability to register is disabled. However, the access point's entry on the Facebook business page is not yet removed.

6. Click the **Apply** button.

Your settings are saved.

7. Go to the Facebook business page and log in to your account.

8. Select the check box for the access point's entry.

9. Click the **Delete** button.

The access point's entry is removed.

8

Manage Access and Security

This chapter describes how you can manage access and security features and user accounts.

The chapter includes the following sections:

- [Block specific URLs and keywords for Internet access](#)
- [Manage user accounts](#)
- [Manage local MAC access control lists](#)
- [Manage neighbor AP detection](#)
- [Set up RADIUS servers](#)
- [Enable L2 security](#)

Note: For information about essential WiFi security (network authentication and encryption), see [Set up an open or secure WiFi network](#) on page 58.

Note: In this manual, *WiFi network* means the same as SSID (service set identifier or WiFi network name) or VAP (virtual access point). That is, when we refer to a WiFi network we mean an individual SSID or VAP.

Block specific URLs and keywords for Internet access

You can set up a blacklist by specifying URLs (web addresses) for which Internet access must be blocked. You can also specify keywords that cause the access point to reject URLs that contain those keywords.

To set up a blacklist with URLs and keywords for which Internet access must be blocked:

1. Launch a web browser from a computer that is connected to the same network as the access point or directly to the access point through an Ethernet cable or WiFi connection.

2. Enter the IP address that is assigned to the access point.

A login window displays.

If your browser displays a security warning, you can proceed, or add an exception for the security warning. For more information, see [What to do if you get a browser security warning](#) on page 42.

3. Enter the access point user name and password.

The user name is **admin**. The password is the one that you specified. The user name and password are case-sensitive.

If you previously added the access point to a NETGEAR Insight network location and managed the access point through the Insight Cloud Portal or Insight app, enter the Insight network password for that location. For more information, see [Connect over WiFi using the NETGEAR Insight app](#) on page 24.

The Dashboard page displays.

4. Select **Management > Configuration > Security > URL Filtering**.

The URL Filtering page displays.

5. Select the **Enable** radio button.

The screenshot shows the 'URL Filtering' configuration page. At the top, there are two radio buttons: 'Enable' (selected) and 'Disable'. Below this are two main sections: 'Blocked URLs' and 'Blocked Keywords'. Each section has a text input field, an 'Add' button, and a 'Remove' button. The 'Blocked URLs' section currently has 'www.google.com' in the input field. The 'Blocked Keywords' section has 'Jobs' in the input field. To the right of these sections is a 'Popular URL list' which is a table with checkboxes and the following URLs: www.yahoo.com, www.facebook.com, www.twitter.com, www.news.google.com, www.youtube.com, and www.linkedin.com. A '<< Move' button is positioned between the 'Blocked URLs' and 'Popular URL list' sections. At the bottom of the page, there are 'Cancel' and 'Apply' buttons.

6. Compose the blacklist in the following ways:

- Blocked URLs:** To add a URL to the blacklist, type or copy the URL in the upper field (to the left of the upper **Add** button) and click the upper **Add** button. You can also select one or more URLs from the Popular URL list by selecting the check boxes for the URLs and clicking the **<< Move** button.

To remove a URL from the blacklist, select the check box for the URL and click the upper left **Remove** button.

When you block a URL, the domain and all URLs in the domain are blocked. For example, if you add www.google.com, all web pages in the www.google.com domain are blocked, including, for example, www.google.com/finance.
- Blocked Keywords:** To add a keyword entry to the blacklist, enter the keyword in the lower field (to the left of the lower **Add** button) and click the lower **Add** button.

To remove a keyword entry from the blacklist, select the check box for the entry and click the lower **Remove** button.

All URLs that contain the keyword are blocked. For example, if you add Jobs, all URLs that contains Jobs (or jobs) are blocked.

7. Click the **Apply** button.
Your settings are saved.

Manage user accounts

User accounts provide either read/write or read-only access to the local browser UI of the access point. You cannot delete the admin user account or change its user name, but you can change its password. You can add accounts for other users, and you can change or delete these accounts.

The following sections describe how you can manage user accounts:

- [Add a user account](#)
- [Change the time-out period for a user session](#)
- [Change the settings for a user account](#)
- [Remove a user account](#)

For information about changing the password for the default admin user account, see [Change the admin user account password](#) on page 153.

Add a user account

To add a user account:

1. Launch a web browser from a computer that is connected to the same network as the access point or directly to the access point through an Ethernet cable or WiFi connection.

2. Enter the IP address that is assigned to the access point.

A login window displays.

If your browser displays a security warning, you can proceed, or add an exception for the security warning. For more information, see [What to do if you get a browser security warning](#) on page 42.

3. Enter the access point user name and password.

The user name is **admin**. The password is the one that you specified. The user name and password are case-sensitive.

If you previously added the access point to a NETGEAR Insight network location and managed the access point through the Insight Cloud Portal or Insight app, enter the Insight network password for that location. For more information, see [Connect over WiFi using the NETGEAR Insight app](#) on page 24.

The Dashboard page displays.

4. Select **Management > Configuration > System > Advanced > User Accounts**.

The screenshot shows a configuration form with the following elements:

- User Name:** A text input field containing "admin".
- Password:** A text input field with masked characters (dots).
- Privilege:** A dropdown menu currently set to "Read-Write".
- Session Timeout:** Two sub-fields: "Hours" set to "0" and "Minutes" set to "45".
- Buttons:** "Cancel" and "Apply" buttons at the bottom.

5. Click the add user account icon.
Additional fields and a menu display.
6. Specify the settings for the new user account:
 - **User Name:** Enter a user name.
 - **Password:** Enter a password between 8 and 64 characters in length. The password must contain at least one uppercase letter, one lowercase letter, and one number. The following special characters are allowed:
! @ # \$ % ^ & * ()
 - **Privilege:** From the menu, select **Read-Write** or **Read-Only**.
 - **Session Timeout:** Use the **Hours** and **Minutes** fields to specify the period after which a session automatically expires and the user must log in again. By default, a session expires after 45 minutes.
7. Click the **Apply** button.
Your settings are saved.

Change the time-out period for a user session

When a user logs in to the local browser UI, the session times out automatically after 45 minutes. You can change the time-out period, which applies to all users, including the admin user.

To change the time-out period for a user session:

1. Launch a web browser from a computer that is connected to the same network as the access point or directly to the access point through an Ethernet cable or WiFi connection.
2. Enter the IP address that is assigned to the access point.
A login window displays.

If your browser displays a security warning, you can proceed, or add an exception for the security warning. For more information, see [What to do if you get a browser security warning](#) on page 42.

3. Enter the access point user name and password.

The user name is **admin**. The password is the one that you specified. The user name and password are case-sensitive.

If you previously added the access point to a NETGEAR Insight network location and managed the access point through the Insight Cloud Portal or Insight app, enter the Insight network password for that location. For more information, see [Connect over WiFi using the NETGEAR Insight app](#) on page 24.

The Dashboard page displays.

4. Select **Management > Configuration > System > Advanced > User Accounts**.

The screenshot shows a configuration form for a user account. It includes three input fields: 'User Name' (containing 'admin'), 'Password' (masked with asterisks), and 'Privilege' (a dropdown menu set to 'Read-Write'). Below these is a 'Session Timeout' section with two sub-fields: 'Hours' (set to 0) and 'Minutes' (set to 45). At the bottom of the form are two buttons: 'Cancel' and 'Apply'.

5. Under Session Timeout, use the **Hours** and **Minutes** fields to specify the period after which a session automatically expires and the user must log in again.
By default, a session expires after 45 minutes.
6. Click the **Apply** button.
Your settings are saved. Your session is terminated and you must log in again.

Change the settings for a user account

You cannot change the access privilege for the default admin user account.

To change the user name, password, or access privilege for a user account:

1. Launch a web browser from a computer that is connected to the same network as the access point or directly to the access point through an Ethernet cable or WiFi connection.
2. Enter the IP address that is assigned to the access point.
A login window displays.

If your browser displays a security warning, you can proceed, or add an exception for the security warning. For more information, see [What to do if you get a browser security warning](#) on page 42.

3. Enter the access point user name and password.

The user name is **admin**. The password is the one that you specified. The user name and password are case-sensitive.

If you previously added the access point to a NETGEAR Insight network location and managed the access point through the Insight Cloud Portal or Insight app, enter the Insight network password for that location. For more information, see [Connect over WiFi using the NETGEAR Insight app](#) on page 24.

The Dashboard page displays.

4. Select **Management > Configuration > System > Advanced > User Accounts**.

The existing user accounts display.

5. To the right of the user account, change the existing settings as needed:

- **User Name:** Enter another user name.
- **Password:** Enter another password between 8 and 64 characters in length. The password must contain at least one uppercase letter, one lowercase letter, and one number. The following special characters are allowed:
! @ # \$ % ^ & * ()
- **Privilege:** From the menu, select **Read-Write** or **Read-Only**.

6. Click the **Apply** button.

Your settings are saved.

Remove a user account

You can remove a user account that you no longer need. You cannot remove the default admin user account.

To remove a user account:

1. Launch a web browser from a computer that is connected to the same network as the access point or directly to the access point through an Ethernet cable or WiFi connection.
2. Enter the IP address that is assigned to the access point.
A login window displays.

If your browser displays a security warning, you can proceed, or add an exception for the security warning. For more information, see [What to do if you get a browser security warning](#) on page 42.

3. Enter the access point user name and password.

The user name is **admin**. The password is the one that you specified. The user name and password are case-sensitive.

If you previously added the access point to a NETGEAR Insight network location and managed the access point through the Insight Cloud Portal or Insight app, enter the Insight network password for that location. For more information, see [Connect over WiFi using the NETGEAR Insight app](#) on page 24.

The Dashboard page displays.

4. Select **Management > Configuration > System > Advanced > User Accounts**.

The existing user accounts display.

5. Click the **X** to the right of the user account.

A warning pop-up window displays.

6. Click the **Delete** button.

The pop-up windows closes and the user account is removed.

Manage local MAC access control lists

The access point supports eight local access control lists (ACLs) that are based on MAC addresses. Each local MAC ACL can contain a total number of 512 MAC addresses.

If you set up an ACL with a policy that allows access and you apply that ACL to a WiFi network (that is, to an SSID), the ACL functions as follows:

- A WiFi device for which you place the MAC address in the ACL is allowed access to the WiFi network.
- All other WiFi devices are denied access to the WiFi network.

If you set up an ACL with a policy that denies access and you apply that ACL to a WiFi network (that is, to an SSID), the ACL functions as follows:

- A WiFi device for which you place the MAC address in the ACL is denied access to the WiFi network.
- All other WiFi devices are allowed access to the WiFi network.

An ACL takes effect only after you apply it to a WiFi network. For information about applying an ACL to a WiFi network, see [Select a MAC ACL for a WiFi network](#) on page 205. You can apply a MAC ACL to more than one WiFi network.

The following sections describe how you can manage MAC ACLs:

- [Manually set up a MAC access control List](#)
- [Import an existing MAC access control list](#)

Manually set up a MAC access control List

You can compose up to eight access control lists (ACLs) that are each based on up to 512 MAC addresses. The access point includes MAC ACLs with the following default group names and settings, which you can change:

- **Management:** If enabled, allows access to trusted stations by default.
- **Guest:** If enabled, allows access to trusted stations by default.
- **Guest1:** If enabled, denies access to untrusted stations by default.
- **Custom:** If enabled, denies access to untrusted stations by default.
- **Custom 1:** If enabled, allows access to trusted stations by default.
- **Custom 2:** If enabled, allows access to trusted stations by default.
- **Custom 3:** If enabled, allows access to trusted stations by default.
- **Custom 4:** If enabled, allows access to trusted stations by default.

By default, these MAC ACLs are disabled and do not include any stations. You can manually add devices, import devices (see [Import an existing MAC access control list](#) on page 120), or do both.

You can use a MAC ACL to control which WiFi devices (stations) can access a WiFi network. You can apply one MAC ACL to more than one WiFi network.

To manually set up a MAC ACL:

1. Launch a web browser from a computer that is connected to the same network as the access point or directly to the access point through an Ethernet cable or WiFi connection.
2. Enter the IP address that is assigned to the access point.
A login window displays.

If your browser displays a security warning, you can proceed, or add an exception for the security warning. For more information, see [What to do if you get a browser security warning](#) on page 42.

3. Enter the access point user name and password.

Insight Managed WiFi 6 AX3000 Access Point Model WAX618

The user name is **admin**. The password is the one that you specified. The user name and password are case-sensitive.

If you previously added the access point to a NETGEAR Insight network location and managed the access point through the Insight Cloud Portal or Insight app, enter the Insight network password for that location. For more information, see [Connect over WiFi using the NETGEAR Insight app](#) on page 24.

The Dashboard page displays.

4. Select **Management > Configuration > Security > MAC ACL**.
5. Click the group name for the MAC ACL that you want to set up.

Management

Group Name

Import MAC Address List Replace Merge

No MAC list file chosen

[Download Sample](#)

ACL Policy Allow Deny

Trusted Stations

Select-all	Search..
No Station Found	

Available Stations

Select-all	Search..	
<input type="checkbox"/>	50-6A-03-80-51-01	Connected
<input type="checkbox"/>	50-6A-03-80-51-02	Connected
<input type="checkbox"/>	50-6A-03-80-51-03	Connected

00-00-00-00-00-00

> Guest

> Guest1

> Custom

The previous figure shows some examples. Devices in the Available Stations table are automatically detected by the access point and are common to all MAC ACLs, which allows you to add a device to more than one MAC ACL. A neighboring station displays as Neighbor and a connected station displays as Connected.

6. To change the group name, enter a new name in the **Group Name** field.
The default group names for the eight MAC ACLs are Management, Guest, Guest1, Custom, Custom 1, Custom 2, Custom 3, and Custom 4.
7. Select the ACL Policy **Allow** or **Deny** radio button.

If you select the **Allow** radio button, a WiFi device for which you place the MAC address in the ACL is allowed access to the WiFi network, but all other WiFi devices are denied access to the WiFi network.

If you select the **Deny** radio button, a WiFi device for which you place the MAC address in the ACL is denied access to the WiFi network, but all other WiFi devices are allowed access to the WiFi network.

8. Compose the ACL in the following way:

- For an ACL for which you selected the **Allow** radio button in Step 7, do the following:
 - To manually add a device to the Trusted Stations table, enter the MAC address in the format 00-00-00-00-00-00 in the field below the Trusted Stations table, and click the **Add** button.
The device is added to the Trusted Stations table.
 - To move a device from the Available Stations table to the Trusted Stations table, select the check box for the device and click the **<< Move** button.
You can search the Available Stations table. You can also filter devices in the Available Stations table by clicking the **filter** icon.
 - To remove a device from the Trusted Stations table, select the check box for the device and click the **Remove** button.
You can search the Trusted Stations table.
When you remove a device from the Trusted Stations table, after the access point redetects the device, the device is once again placed in the Available Stations table.

- For an ACL for which you selected the **Deny** radio button in Step 7, do the following:
 - To manually add a device to the Untrusted Stations table, enter the MAC address in the format 00-00-00-00-00-00 in the field below the Untrusted Stations table, and click the **Add** button.
The device is added to the Untrusted Stations table.
 - To move a device from the Available Stations table to the Untrusted Stations table, select the check box for the device and click the **<< Move** button.
You can search the Available Stations table. You can also filter devices in the Available Stations table by clicking the **filter** icon.
 - To remove a device from the Untrusted Stations table, select the check box for the device and click the **Remove** button.
You can search the Untrusted Stations table.
When you remove a device from the Untrusted Stations table, after the access point redetects the device, the device is once again placed in the Available Stations table.

9. Click the **Apply** button.

Your settings are saved.

For more information about applying an ACL to a WiFi network, see [Select a MAC ACL for a WiFi network](#) on page 205.

WiFi devices in the Trusted Stations table can access the WiFi network to which you apply the ACL. WiFi devices in the Untrusted Stations table cannot access the WiFi network to which you apply the ACL.

Import an existing MAC access control list

You can import an existing access control list (ACL) that is based on up to 512 MAC addresses. You can import the list into any MAC ACL, but the MAC addresses on the list are available only for the MAC ACL into which you import the list. That is, if you want to use the same list in another MAC ACL, you must also import the list into that MAC ACL.

The file with MAC addresses must be in the following format:

- Entries in the file must be MAC addresses only in hexadecimal format with each octet separated by a hyphen, for example 00-11-22-33-44-55.
- You must separate entries with a comma.
- The file must be in text format (that is, with a .txt or .cfg extension).

You can use a MAC ACL to control which WiFi devices can access a WiFi network. You can apply a MAC ACL to more than one WiFi network.

To import an existing MAC ACL:

1. Launch a web browser from a computer that is connected to the same network as the access point or directly to the access point through an Ethernet cable or WiFi connection.
2. Enter the IP address that is assigned to the access point.
A login window displays.
If your browser displays a security warning, you can proceed, or add an exception for the security warning. For more information, see [What to do if you get a browser security warning](#) on page 42.
3. Enter the access point user name and password.
The user name is **admin**. The password is the one that you specified. The user name and password are case-sensitive.

If you previously added the access point to a NETGEAR Insight network location and managed the access point through the Insight Cloud Portal or Insight app, enter the Insight network password for that location. For more information, see [Connect over WiFi using the NETGEAR Insight app](#) on page 24.

The Dashboard page displays.

4. Select **Management > Configuration > Security > MAC ACL**.
5. Click the group name for the MAC ACL that you want to set up.

Management

Group Name ? Management

Import MAC Address List ? Replace Merge

Browse File No MAC list file chosen

[Download Sample](#)

ACL Policy Allow Deny

Trusted Stations

Select-all	Search..
No Station Found	

<< Move

Available Stations ↻

Select-all	Search..	Status
<input type="checkbox"/>	50-6A-03-80-51-01	Connected
<input type="checkbox"/>	50-6A-03-80-51-02	Connected
<input type="checkbox"/>	50-6A-03-80-51-03	Connected

00-00-00-00-00-00 Add Remove

Cancel Apply

> Guest

> Guest1

> Custom

The previous figure shows some examples. Devices in the Available Stations table are automatically detected by the access point and are common to all MAC ACLs, which allows you to add a device to more than one MAC ACL. A neighboring station displays as Neighbor and a connected station displays as connected.

6. To change the group name, enter a new name in the **Group Name** field.
The default group names for the eight MAC ACLs are Management, Guest, Guest1, Custom, Custom 1, Custom 2, Custom 3, and Custom 4.
7. Select the ACL Policy **Allow** or **Deny** radio button.
If you select the **Allow** radio button, a WiFi device for which you import the MAC address into the ACL is allowed access to the WiFi network, but all other WiFi devices are denied access to the WiFi network.

If you select the **Deny** radio button, a WiFi device for which you import the MAC address into the ACL is denied access to the WiFi network, but all other WiFi devices are allowed access to the WiFi network.

8. To download a sample of a MAC ACL in the format that is required for importing, click the **Download Sample** link.
9. Import and compose the ACL in the following way:
 - For an ACL for which you selected the **Allow** radio button in Step 7, do the following:
 - a. Replace or merge the MAC addresses in the import list with the MAC addresses in the Trusted Stations table (if any are already in the table) by selecting one of the following radio buttons:
 - **Replace**: MAC addresses in the Trusted Stations table are replaced with the ones in the import list.
 - **Merge**: MAC addresses in the Trusted Stations table are merged with the ones in the import list.
 - b. Click the **Browse** button and navigate to and select the import file. The MAC addresses on the import list are placed in the Trusted Stations table.
 - c. To remove a MAC address from the Trusted Stations table, select the MAC address and click the **Remove** button. You can search the Trusted Stations table. When you remove a device from the Trusted Stations table, after the access point redetects the device, the device is once again placed in the Available Stations table.
 - For an ACL for which you selected the **Deny** radio button in Step 7, do the following:
 - a. Replace or merge the MAC addresses in the import list with the MAC addresses in the Untrusted Stations table (if any are already in the table) by selecting one of the following radio buttons:
 - **Replace**: MAC addresses in the Untrusted Stations table are replaced with the ones in the import list.
 - **Merge**: MAC addresses in the Untrusted Stations table are merged with the ones in the import list.
 - b. Click the **Browse** button and navigate to and select the import file. The MAC addresses on the import list are placed in the Untrusted Stations table.

- c. To remove a MAC address from the Untrusted Stations table, select the MAC address and click the **Remove** button.

You can search the Untrusted Stations table.

When you remove a device from the Untrusted Stations table, after the access point redetects the device, the device is once again placed in the Available Stations table.

10. Click the **Apply** button.

Your settings are saved. For information about manually adding MAC addresses to those in the Trusted Stations table or Untrusted Stations table, see [Manually set up a MAC access control List](#) on page 117.

For more information about applying an ACL to a WiFi network, see [Select a MAC ACL for a WiFi network](#) on page 205.

WiFi devices in the Trusted Stations table can access the WiFi network to which you apply the ACL. WiFi devices in the Untrusted Stations table cannot access the WiFi network to which you apply the ACL.

Manage neighbor AP detection

The access point can detect neighbor access points (APs) in a radio band and you can classify them as known APs.

If you enable neighbor AP detection for a radio band, the access point regularly scans the WiFi network, collects information about all access points on the channels, and maintains a list of access points it detects in the area. Initially all detected access points are displayed in the Unknown AP List. You can add access points that you are familiar with to the Known AP List. You can also import a list of known access points in the Known AP List.

CAUTION: Access points in the Unknown AP List require further investigation. They could be rogue access points, which use the SSID of a legitimate network. These types of access points can present a serious security threat.

The following sections describe how you can manage neighbor AP detection and add neighbor access points to the Known AP List:

- [Enable neighbor access point detection and move access points to the Known AP List](#)
- [Import an existing neighbor access point list in the Known AP List](#)

Note: If you enable Energy Efficiency Mode, the access point cannot detect neighbor APs in the 5 GHz radio band. To use neighbor AP detection in the 5 GHz radio band, first disable Energy Efficiency Mode. For more information, see [Manage the Energy Efficiency Mode](#) on page 175.

Enable neighbor access point detection and move access points to the Known AP List

The access point can detect neighbor access points (APs) and lets you classify them as known APs. After you enable neighbor AP detection, the access point maintains a list of access points it detects in the area. Initially all detected access points are displayed in the Unknown AP List. You can manually move access points from the Unknown AP List to the Known AP List.

By default neighbor access point detection is disabled.

To enable neighbor access point detection and move detected access points to the Known AP List:

1. Launch a web browser from a computer that is connected to the same network as the access point or directly to the access point through an Ethernet cable or WiFi connection.

2. Enter the IP address that is assigned to the access point.
A login window displays.

If your browser displays a security warning, you can proceed, or add an exception for the security warning. For more information, see [What to do if you get a browser security warning](#) on page 42.

3. Enter the access point user name and password.

The user name is **admin**. The password is the one that you specified. The user name and password are case-sensitive.

If you previously added the access point to a NETGEAR Insight network location and managed the access point through the Insight Cloud Portal or Insight app, enter the Insight network password for that location. For more information, see [Connect over WiFi using the NETGEAR Insight app](#) on page 24.

The Dashboard page displays.

4. Select **Management > Configuration > Security > Neighbor AP**.

The page that displays lets you select the radio band (2.4 GHz or 5 GHz).

5. Click the ► button to the left of the radio band.

The Neighbor AP page displays for the selected radio band.

6. Select the **Enable Neighbor AP** check box.

7. Click the **Apply** button.

Your settings are saved. Neighbor AP detection is now enabled.

▼ 2.4 GHz

Enable Neighbor AP

Detection Policy Mild

Known
AP List

Unknown
AP List

Import Known AP List [i](#)

Replace
 Merge

[Download Sample](#)

No AP list file chosen

<input type="checkbox"/>	MAC Address	SSID	Channel	RSSI
Delete				

8. From the **Detection Policy** menu, select the scan method:

- **Mild:** The access point scans for neighbor access points every hour. This is the default setting.
- **Moderate:** The access point scans for neighbor access points every 30 minutes.
- **Aggressive:** The access point scans for neighbor access points every 15 minutes.

Detected neighbor access points display in the Unknown AP List.

9. To view detected neighbor access points and move them from the Unknown AP List to the Known AP List, do the following:
 - a. Click the **Unknown AP List** tab.

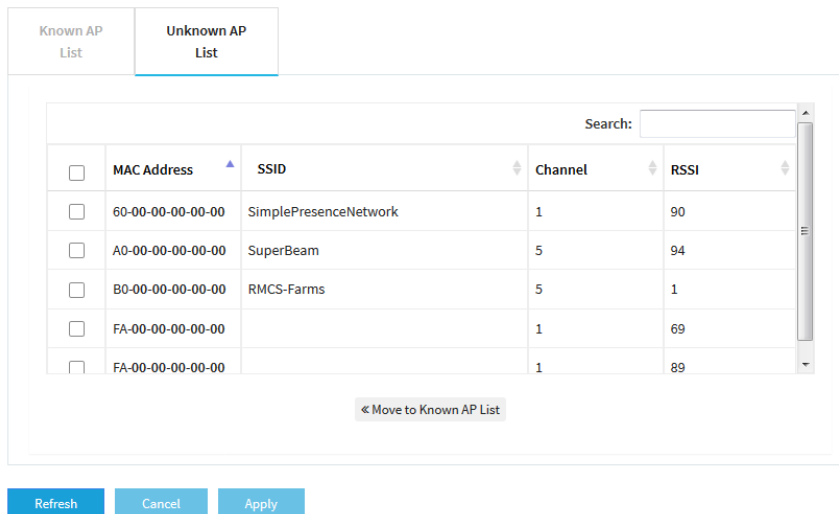

- b. If no access points display, click the **Refresh** button.
 - c. Select the check boxes for the access points that you are familiar with and that you trust.
 - d. Click the **<< Move to Known AP List** button.
 - e. Click the **Known AP List** tab.
The selected access points display in the Known AP List.

Note: You can delete access points from the Known AP List. After being detected, these access points once more display in the Unknown AP List.

10. Click the **Apply** button.
Your settings are saved.

Import an existing neighbor access point list in the Known AP List

You can import a list with MAC addresses of known neighbor access points in the Known AP List.

The file with MAC addresses must be in the following format:

- Entries in the file must be MAC addresses only in hexadecimal format with each octet separated by a hyphen, for example 00-11-22-33-44-55.

- You must separate entries with a comma.
- The file must be in text format (that is, with a `.txt` or `.cfg` extension).

For information about enabling neighbor AP detection, see [Enable neighbor access point detection and move access points to the Known AP List](#) on page 124.

To import a list with MAC addresses of known neighbor access points in the Known AP List:

1. Launch a web browser from a computer that is connected to the same network as the access point or directly to the access point through an Ethernet cable or WiFi connection.

2. Enter the IP address that is assigned to the access point.
A login window displays.

If your browser displays a security warning, you can proceed, or add an exception for the security warning. For more information, see [What to do if you get a browser security warning](#) on page 42.

3. Enter the access point user name and password.

The user name is **admin**. The password is the one that you specified. The user name and password are case-sensitive.

If you previously added the access point to a NETGEAR Insight network location and managed the access point through the Insight Cloud Portal or Insight app, enter the Insight network password for that location. For more information, see [Connect over WiFi using the NETGEAR Insight app](#) on page 24.

The Dashboard page displays.

4. Select **Management > Configuration > Security > Neighbor AP**.

The page that displays lets you select the radio band (2.4 GHz or 5 GHz).

- Click the ► button to the left of the radio band.

The screenshot shows the configuration interface for the 2.4 GHz radio band. At the top, there is a dropdown menu for the radio band, currently set to '2.4 GHz'. Below this, there are two main sections: 'Enable Neighbor AP' and 'Detection Policy'. The 'Enable Neighbor AP' checkbox is checked. The 'Detection Policy' is set to 'Mild'. Below these are two tabs: 'Known AP List' (selected) and 'Unknown AP List'. The 'Known AP List' section contains an 'Import Known AP List' button with an information icon, two radio buttons for 'Replace' and 'Merge' (with 'Merge' selected), a 'Browse File' button, and a 'Download Sample' link. Below the import options is a table with columns for 'MAC Address', 'SSID', 'Channel', and 'RSSI'. A 'Delete' button is located below the table. At the bottom of the page are three buttons: 'Refresh', 'Cancel', and 'Apply'.

- To download a sample of an AP list in the format that is required for importing in the Known AP List, click the **Download Sample** link.
- Import and compose the Known AP List in the following way:
 - Replace or merge the MAC addresses in the import list with the MAC addresses in the Known AP List by selecting one of the following radio buttons:
 - **Replace:** MAC addresses in the Known AP List are replaced with the ones in the import list.
 - **Merge:** MAC addresses in the Known AP List are merged with the ones in the import list.
 - Click the **Browse** button and navigate to and select the import file. The MAC addresses on the import list are placed in the Known AP List.
 - To remove a MAC address from the Known AP List, select the MAC address and click the **Delete** button.
When you remove a device from the Known AP List, after the access point redetects the device, the device is once again placed in the Known AP List.

8. Click the **Apply** button.
Your settings are saved.

Set up RADIUS servers

If you use WPA2 Enterprise security, WPA3 Enterprise security, or a RADIUS MAC ACL, you must set up RADIUS servers for authentication or both authentication and accounting using RADIUS. You must set up a primary IPv4 server and you can set up a secondary IPv4 server. These RADIUS server settings apply either to all WiFi networks that use WPA2 Enterprise security or WPA3 Enterprise security (see [Set up an open or secure WiFi network](#) on page 58) or to all WiFi networks that use a RADIUS MAC ACL.

Note: Either WPA2 Enterprise security or WPA3 Enterprise security and a RADIUS MAC ACL are mutually exclusive. If you want to use a RADIUS MAC ACL for a WiFi network, select a different type of WiFi security (see [Set up an open or secure WiFi network](#) on page 58). If you want to use WPA2 Enterprise security or WPA3 Enterprise security for a WiFi network, use a local MAC ACL (see [Manage local MAC access control lists](#) on page 116).

If you use a RADIUS MAC ACL, you must define the ACL on the RADIUS server, using the format in the following example for client MAC addresses in the RADIUS server: If the client MAC address is 00:0a:95:9d:68:16, specify it as 000a959d6816 in the RADIUS server.

To set up RADIUS servers:

1. Launch a web browser from a computer that is connected to the same network as the access point or directly to the access point through an Ethernet cable or WiFi connection.

2. Enter the IP address that is assigned to the access point.

A login window displays.

If your browser displays a security warning, you can proceed, or add an exception for the security warning. For more information, see [What to do if you get a browser security warning](#) on page 42.

3. Enter the access point user name and password.



The user name is **admin**. The password is the one that you specified. The user name and password are case-sensitive.

If you previously added the access point to a NETGEAR Insight network location and managed the access point through the Insight Cloud Portal or Insight app, enter the

Insight network password for that location. For more information, see [Connect over WiFi using the NETGEAR Insight app](#) on page 24.

The Dashboard page displays.

4. Select **Management > Configuration > Security > RADIUS Settings**.

	IPv4 Address	Port	Password	
Primary Authentication Server	<input type="text"/>	1812	*****	
Secondary Authentication Server	<input type="text"/>	1812	*****	

Enable Accounting

Authentication Settings

Reauthentication Time:

Update Global Key:

1800

5. For each RADIUS server that you want to set up, configure the following settings:
 - **IPv4 Address:** Enter the IPv4 address of the RADIUS server. The access point must be able to reach this IP address.
 - **Port:** Enter the number of the UDP port on the access point that is used to access the RADIUS server. The default port number is 1812.
 - **Password:** Enter the password (shared key) that is used between the access point and the RADIUS server during the authentication or accounting process. By default, the password is sharedsecret.
6. To enable accounting on the authentication servers, click the **Enable Accounting** button so that the button displays blue.
7. Configure the following authentication settings, which apply to all RADIUS server that you set up:
 - **Reauthentication time:** Enter the interval in seconds after which the supplicant (the WiFi client) must be reauthenticated with the RADIUS server. The default interval is 3600 seconds (1 hour). Enter **0** to disable reauthentication.

- **Update Global Key:** Select the check box to allow the global key update, and enter the interval in seconds. The check box is selected by default, and the default interval is 1800 seconds (30 minutes). Clear the check box to prevent the global key update.

8. Click the **Apply** button.
Your settings are saved.

Enable L2 security

L2 security can prevent attacks via VLAN stacking by blocking VLAN-tagged packets on the WiFi interface. If you enable L2 security, the access point allows only certain types of client traffic, such as ARP, IPv4, and IPv6 traffic, on any WiFi network. L2 security is disabled by default.

To enable L2 security:

1. Launch a web browser from a computer that is connected to the same network as the access point or directly to the access point through an Ethernet cable or WiFi connection.

2. Enter the IP address that is assigned to the access point.
A login window displays.

If your browser displays a security warning, you can proceed, or add an exception for the security warning. For more information, see [What to do if you get a browser security warning](#) on page 42.

3. Enter the access point user name and password.

The user name is **admin**. The password is the one that you specified. The user name and password are case-sensitive.

If you previously added the access point to a NETGEAR Insight network location and managed the access point through the Insight Cloud Portal or Insight app, enter the Insight network password for that location. For more information, see [Connect over WiFi using the NETGEAR Insight app](#) on page 24.

The Dashboard page displays.

4. Select **Management > Configuration > Security > L2 Security**.

The L2 Security page displays.

5. Select the **Yes** radio button.

By default the No radio button is selected, and L2 security is disabled.

6. Click the **Apply** button.
Your settings are saved.

9

Manage the Local Area Network and IP Settings

This chapter describes how you can manage the local area network (LAN) and IP settings of the access point.

The chapter includes the following sections:

- [Disable the DHCP client and specify a fixed IP address](#)
- [Enable the DHCP client](#)
- [Set the 802.1Q VLAN and management VLAN](#)
- [Set an existing domain name](#)
- [Enable or disable Spanning Tree Protocol](#)
- [Enable or disable the network integrity check function](#)
- [Enable or disable IGMP snooping](#)
- [Enable or disable Ethernet LLDP](#)
- [Enable or disable UPnP](#)
- [Manage the multicast DNS gateway](#)

Note: In this manual, *WiFi network* means the same as SSID (service set identifier or WiFi network name) or VAP (virtual access point). That is, when we refer to a WiFi network we mean an individual SSID or VAP.

Disable the DHCP client and specify a fixed IP address

By default, the DHCP client of the access point is enabled and the access point receives an IP address from a DHCP server (or a router that functions as a DHCP server) in your network. If your network does not include a DHCP server or you prefer to specify a fixed (static) IP address, disable the DHCP client of the access point.

To disable the DHCP client and specify a fixed IP address:

1. Launch a web browser from a computer that is connected to the same network as the access point or directly to the access point through an Ethernet cable or WiFi connection.

2. Enter the IP address that is assigned to the access point.

A login window displays.

If your browser displays a security warning, you can proceed, or add an exception for the security warning. For more information, see [What to do if you get a browser security warning](#) on page 42.

3. Enter the access point user name and password.

The user name is **admin**. The password is the one that you specified. The user name and password are case-sensitive.

If you previously added the access point to a NETGEAR Insight network location and managed the access point through the Insight Cloud Portal or Insight app, enter the Insight network password for that location. For more information, see [Connect over WiFi using the NETGEAR Insight app](#) on page 24.

The Dashboard page displays.

4. Select **Management > Configuration > IP > LAN**.

The page that displays lets you specify the LAN settings, but the fields are masked because the DHCP client is enabled.

5. Select the **Disable** radio button.

The screenshot shows a configuration window for the DHCP Client. At the top, there are two radio buttons: 'Enable' (unselected) and 'Disable' (selected). Below this, there are three input fields: 'IP Address' with the value '192.168.100.127', 'Subnet Mask' with '255.255.255.0', and 'Gateway' with '192.168.100.1'. Underneath these are 'Primary DNS' (192.168.100.1) and 'Secondary DNS' (0.0.0.0). A section for '802.1Q VLAN' contains 'Untagged VLAN' (checked, value 1) and 'Management VLAN' (value 1). At the bottom, there is a 'Fully Qualified Domain Name' field with a help icon and an 'FQDN' input field. 'Cancel' and 'Apply' buttons are at the bottom left.

The fields are now unmasked.

6. Specify the settings that are described in the following table.

Setting	Description
IP Address	IP address in the range that is used by your LAN (usually 255.255.255.0).
Subnet Mask	The subnet mask must be compatible with your LAN.
Gateway	IP address of the gateway on your LAN.
Primary DNS	IP address of the primary Domain Name System (DNS) server on your LAN.
Secondary DNS	IP address of the secondary DNS server on your LAN, or leave this field blank.

7. Click the **Apply** button.

Your settings are saved. The access point restarts with the new IP settings.

Enable the DHCP client

By default, the DHCP client of the access point is enabled and the access point receives an IP address from a DHCP server (or a router that functions as a DHCP server) in your network.

If you disabled the DHCP client, you can reen able it.

To enable the DHCP client:

1. Launch a web browser from a computer that is connected to the same network as the access point or directly to the access point through an Ethernet cable or WiFi connection.

2. Enter the IP address that is assigned to the access point.

A login window displays.

If your browser displays a security warning, you can proceed, or add an exception for the security warning. For more information, see [What to do if you get a browser security warning](#) on page 42.

3. Enter the access point user name and password.

The user name is **admin**. The password is the one that you specified. The user name and password are case-sensitive.

If you previously added the access point to a NETGEAR Insight network location and managed the access point through the Insight Cloud Portal or Insight app, enter the Insight network password for that location. For more information, see [Connect over WiFi using the NETGEAR Insight app](#) on page 24.

The Dashboard page displays.

4. Select **Management > Configuration > IP > LAN**.

The screenshot shows the DHCP Client configuration interface. At the top, there are radio buttons for 'Enable' and 'Disable', with 'Disable' selected. Below this are three input fields: 'IP Address' (192.168.100.127), 'Subnet Mask' (255.255.255.0), and 'Gateway' (192.168.100.1). Underneath are 'Primary DNS' (192.168.100.1) and 'Secondary DNS' (0.0.0.0). A section for '802.1Q VLAN' contains 'Untagged VLAN' (1) and 'Management VLAN' (1). At the bottom, there is a 'Fully Qualified Domain Name' field with a sub-label 'FQDN'. 'Cancel' and 'Apply' buttons are at the very bottom.

5. Select the **Enable** radio button.

The fields are masked.

6. Click the **Apply** button.

Your settings are saved. The access point restarts with the new IP settings. It might take a while before the access point receives its IP address setting from the DHCP server.

Set the 802.1Q VLAN and management VLAN

The 802.1Q VLAN protocol on the access point logically separates traffic on the same physical (wired) network. This protocol can work with tagged and untagged VLANs, as follows:

- **Untagged VLAN:** The access point sends untagged frames from its Ethernet interface. Incoming untagged frames are assigned to the untagged VLAN. By default, the untagged VLAN is VLAN 1. By default, the access point functions with an untagged VLAN.
- **Tagged VLAN:** The access point tags all frames that it sends from its Ethernet interface. Only the incoming frames that are tagged with known VLAN IDs are accepted.

The management VLAN is used for managing traffic such as Telnet, SNMP, HTTP, and HTTPS traffic sent to and from the access point. Frames that belong to the management VLAN and that are sent over the trunk do not receive an 802.1Q header. If a port is a member of a single VLAN, its traffic can be untagged.

A management VLAN and the following features are mutually exclusive:

- mDNS gateway (see [Manage the multicast DNS gateway](#) on page 145)
- NAT mode (see [Set NAT mode or Bridge mode for addressing and traffic](#) on page 199)

To set the 802.1Q VLAN and management VLAN:

1. Launch a web browser from a computer that is connected to the same network as the access point or directly to the access point through an Ethernet cable or WiFi connection.
2. Enter the IP address that is assigned to the access point.
A login window displays.

If your browser displays a security warning, you can proceed, or add an exception for the security warning. For more information, see [What to do if you get a browser security warning](#) on page 42.

3. Enter the access point user name and password.
The user name is **admin**. The password is the one that you specified. The user name and password are case-sensitive.

If you previously added the access point to a NETGEAR Insight network location and managed the access point through the Insight Cloud Portal or Insight app, enter the Insight network password for that location. For more information, see [Connect over WiFi using the NETGEAR Insight app](#) on page 24.

The Dashboard page displays.

4. Select **Management > Configuration > IP > LAN**.

The screenshot shows the DHCP Client configuration interface. At the top, there are radio buttons for 'Enable' (selected) and 'Disable'. Below this are input fields for IP Address (192.168.100.127), Subnet Mask (255.255.255.0), and Gateway (192.168.100.1). Further down are fields for Primary DNS (192.168.100.1) and Secondary DNS (0.0.0.0). A section titled '802.1Q VLAN' contains an 'Untagged VLAN' checkbox (checked) and a 'Management VLAN' field (set to 1). Below this is a 'Fully Qualified Domain Name' section with an 'FQDN' input field. At the bottom left are 'Cancel' and 'Apply' buttons.

5. To change the 802.1Q VLAN, either clear or select the **Untagged VLAN** check box:

- **Untagged VLAN:** By default, the **Untagged VLAN** check box is selected. The access point sends untagged frames from its Ethernet interface. Incoming untagged frames are assigned to the untagged VLAN. By default, the untagged VLAN is VLAN 1 but you can enter another VLAN ID in the field if that VLAN ID is supported on your network.
- **Tagged VLAN:** Clear the **Untagged VLAN** check box only if the hubs and switches on your LAN support the 802.1Q VLAN protocol. The access point tags all frames that it sends from its Ethernet interface. Only the incoming frames that are tagged with known VLAN IDs are accepted. Similarly, change the ID for the untagged VLAN only if the hubs and switches on your LAN support the 802.1Q VLAN protocol and the new VLAN ID is supported on your network.

6. To change the VLAN ID for the management VLAN, enter another VLAN ID in the **Management VLAN** field.

By default, the management VLAN is VLAN 1. If you change the VLAN ID, be sure that the VLAN ID is supported on your network.

7. Click the **Apply** button.

Your settings are saved. The access point restarts with the new VLAN settings.

Set an existing domain name

You can specify an existing fully qualified domain name (FQDN) for the access point so that you can access the access point by using a domain name instead of an IP address.

The FQDN must be a domain name that is registered with a Domain Name System (DNS) provider.

The following are the requirements for the FQDN:

- The length can be from 1 to 64 characters.
- Alphanumeric characters are allowed (a-z and 1-9)
- A dot (.) and a hyphen (-) are allowed but the name cannot start with either.

An example is *myap01-firstfloor-myorganization.com*.

To set an existing FQDN:

1. Launch a web browser from a computer that is connected to the same network as the access point or directly to the access point through an Ethernet cable or WiFi connection.

2. Enter the IP address that is assigned to the access point.

A login window displays.

If your browser displays a security warning, you can proceed, or add an exception for the security warning. For more information, see [What to do if you get a browser security warning](#) on page 42.

3. Enter the access point user name and password.

The user name is **admin**. The password is the one that you specified. The user name and password are case-sensitive.

If you previously added the access point to a NETGEAR Insight network location and managed the access point through the Insight Cloud Portal or Insight app, enter the Insight network password for that location. For more information, see [Connect over WiFi using the NETGEAR Insight app](#) on page 24.

The Dashboard page displays.

4. Select **Management > Configuration > IP > LAN**.

The screenshot shows the DHCP Client configuration interface. At the top, there are radio buttons for 'Enable' (selected) and 'Disable'. Below this are input fields for IP Address (192.168.100.127), Subnet Mask (255.255.255.0), and Gateway (192.168.100.1). Further down are fields for Primary DNS (192.168.100.1) and Secondary DNS (0.0.0.0). A section for 802.1Q VLAN includes 'Untagged VLAN' (checked, value 1) and 'Management VLAN' (value 1). At the bottom, there is a 'Fully Qualified Domain Name' field with a sub-field for 'FQDN'. 'Cancel' and 'Apply' buttons are located at the bottom left.

5. In the **Fully Qualified Domain Name** field, specify the FQDN.
6. Click the **Apply** button.
Your settings are saved. The access point attempts to resolve the FQDN to an IP address.

Enable or disable Spanning Tree Protocol

For locations where multiple access points are active and redundant network paths might be present, Spanning Tree Protocol (STP) can prevent network loops. If your location might include redundant network paths, we recommend that you enable STP.

To enable or disable Spanning Tree Protocol:

1. Launch a web browser from a computer that is connected to the same network as the access point or directly to the access point through an Ethernet cable or WiFi connection.
2. Enter the IP address that is assigned to the access point.
A login window displays.
If your browser displays a security warning, you can proceed, or add an exception for the security warning. For more information, see [What to do if you get a browser security warning](#) on page 42.
3. Enter the access point user name and password.
The user name is **admin**. The password is the one that you specified. The user name and password are case-sensitive.

If you previously added the access point to a NETGEAR Insight network location and managed the access point through the Insight Cloud Portal or Insight app, enter the Insight network password for that location. For more information, see [Connect over WiFi using the NETGEAR Insight app](#) on page 24.

The Dashboard page displays.

4. Select **Management > Configuration > System > Advanced > General**.

The General page displays.

5. Select a Spanning Tree Protocol radio button:

- **Enable:** STP is enabled.
- **Disable:** STP is disabled. This is the default setting.

6. Click the **Apply** button.

Your settings are saved.

Enable or disable the network integrity check function

The network integrity check function enables the access point to validate whether the upstream link is active before the access point allows WiFi associations. Make sure that the default gateway is configured correctly. By default, the network integrity check function is disabled.

To enable or disable the network integrity check function:

1. Launch a web browser from a computer that is connected to the same network as the access point or directly to the access point through an Ethernet cable or WiFi connection.

2. Enter the IP address that is assigned to the access point.

A login window displays.

If your browser displays a security warning, you can proceed, or add an exception for the security warning. For more information, see [What to do if you get a browser security warning](#) on page 42.

3. Enter the access point user name and password.

The user name is **admin**. The password is the one that you specified. The user name and password are case-sensitive.

If you previously added the access point to a NETGEAR Insight network location and managed the access point through the Insight Cloud Portal or Insight app, enter the

Insight network password for that location. For more information, see [Connect over WiFi using the NETGEAR Insight app](#) on page 24.

The Dashboard page displays.

4. Select **Management > Configuration > System > Advanced > General**.

The General page displays.

5. Select a Network Integrity Check radio button:

- **Enable:** The network integrity check function is enabled.
- **Disable:** The network integrity check function is disabled. This is the default setting.

6. Click the **Apply** button.

Your settings are saved.

Enable or disable IGMP snooping

IGMP snooping allows IP multicast packets to be transmitted only to the members of a corresponding multicast group. Enabling IGMP snooping prevents flooding of multicast traffic to all the ports in a broadcast domain. By default, IGMP snooping is disabled on the access point.

To enable or disable IGMP snooping:

1. Launch a web browser from a computer that is connected to the same network as the access point or directly to the access point through an Ethernet cable or WiFi connection.

2. Enter the IP address that is assigned to the access point.

A login window displays.

If your browser displays a security warning, you can proceed, or add an exception for the security warning. For more information, see [What to do if you get a browser security warning](#) on page 42.

3. Enter the access point user name and password.

The user name is **admin**. The password is the one that you specified. The user name and password are case-sensitive.

If you previously added the access point to a NETGEAR Insight network location and managed the access point through the Insight Cloud Portal or Insight app, enter the Insight network password for that location. For more information, see [Connect over WiFi using the NETGEAR Insight app](#) on page 24.

The Dashboard page displays.

4. Select **Management > Configuration > System > Advanced > General**.

The General page displays.

5. Select an IGMP Snooping radio button:
 - **Enable:** IGMP snooping is enabled.
 - **Disable:** IGMP snooping is disabled. This is the default setting.
6. Click the **Apply** button.

Your settings are saved.

Enable or disable Ethernet LLDP

Link Layer Discovery Protocol (LLDP), as specified in IEEE 802.1AB, can provide link-layer messages to adjacent network devices. For example, LLDP lets network devices such as switches and management devices discover the access point in a network.

LLDP can also detect if the access point receives power through PoE. By default, LLDP is enabled.

To enable or disable the LLDP:

1. Launch a web browser from a computer that is connected to the same network as the access point or directly to the access point through an Ethernet cable or WiFi connection.

2. Enter the IP address that is assigned to the access point.

A login window displays.

If your browser displays a security warning, you can proceed, or add an exception for the security warning. For more information, see [What to do if you get a browser security warning](#) on page 42.

3. Enter the access point user name and password.

The user name is **admin**. The password is the one that you specified. The user name and password are case-sensitive.

If you previously added the access point to a NETGEAR Insight network location and managed the access point through the Insight Cloud Portal or Insight app, enter the Insight network password for that location. For more information, see [Connect over WiFi using the NETGEAR Insight app](#) on page 24.

The Dashboard page displays.

4. Select **Management > Configuration > System > Advanced > Ethernet LLDP**.

The Ethernet LLDP page displays.

5. Select a radio button:

- **Enable:** LLDP is enabled. This is the default setting.
- **Disable:** LLDP is disabled.

CAUTION: If the access point receives power from a PoE switch and you disable LLDP, power to the access point might be turned off after you click the **Apply** button. In that case, restart the access point.

6. Click the **Apply** button.

Your settings are saved.

Enable or disable UPnP

Universal Plug and Play (UPnP) lets the access point be discovered by other devices in a network that support UPnP. UPnP is enabled by default.

To enable or disable UPnP:

1. Launch a web browser from a computer that is connected to the same network as the access point or directly to the access point through an Ethernet cable or WiFi connection.
2. Enter the IP address that is assigned to the access point.

A login window displays.

If your browser displays a security warning, you can proceed, or add an exception for the security warning. For more information, see [What to do if you get a browser security warning](#) on page 42.

3. Enter the access point user name and password.

The user name is **admin**. The password is the one that you specified. The user name and password are case-sensitive.

If you previously added the access point to a NETGEAR Insight network location and managed the access point through the Insight Cloud Portal or Insight app, enter the Insight network password for that location. For more information, see [Connect over WiFi using the NETGEAR Insight app](#) on page 24.

The Dashboard page displays.

4. Select **Management > Configuration > System > Advanced > UPnP**.

The UPnP page displays.

5. Select a radio button:
 - **Enable:** UPnP is enabled. This is the default setting.
 - **Disable:** UPnP is disabled.
6. Click the **Apply** button.

Your settings are saved.

Manage the multicast DNS gateway

The access point can function as a multicast DNS (mDNS) gateway to allow devices and services to be shared across different VLANs and WiFi networks. mDNS works even if inter-VLAN routing is disabled in the network that the access point is connected to.

Shared devices include printers, scanners, storage devices, and other hardware devices. Services include multiple predefined telephone, music, and video streaming services, file sharing services, and other services and applications.

For example, if a group of WiFi clients are on VLAN 20 and a printer is on VLAN 1, an mDNS gateway policy can make the printer available to the WiFi clients. Or, if a meeting participant wants to use a phone connected to a WiFi network on VLAN 20 to cast a presentation to a large-screen device connected to a WiFi network on VLAN 30, another mDNS gateway policy can make this possible.

A service can run either on a wired or WiFi device, but for a WiFi client to be able to access the service, the WiFi client must be connected to a WiFi network on an access point that has the mDNS gateway feature enabled.

In a network with multiple access points that support the mDNS gateway feature, you can set one access point as the mDNS reflector access point, which readvertises shared devices and services throughout the network.

An mDNS gateway and the following features are mutually exclusive:

- WPA2 Enterprise security and WPA3 Enterprise security that use a dynamic VLAN (see [Set up an open or secure WiFi network](#) on page 58)
- Multi PSK (see [Set up Multi PSK for a WiFi network](#) on page 76)
- Management VLAN (see [Set the 802.1Q VLAN and management VLAN](#) on page 137)
- NAT mode (see [Set NAT mode or Bridge mode for addressing and traffic](#) on page 199)
- Client isolation (see [Enable or disable client isolation for a WiFi network](#) on page 200)

Enable the multicast DNS gateway and add a policy

After you enable the multicast DNS (mDNS) gateway and add a policy, the access point can automatically discover devices and services that can be shared. The policy forms a bridge between the following two VLANs:

- **Service VLAN:** The VLAN that includes shared devices or services as members. For example, the type of shared device can be *printer*, in which case the service VLAN is the VLAN of which the printer is a member. Or, the type of shared service can be *Googlecast*, in which case the service VLAN is the VLAN of which the Googlecast device is a member.
- **VLANs on allowed WiFi networks:** The VLAN that includes as members the WiFi devices that must be able to use the shared devices or service on the service VLAN.

You can add up to eight policies. A policy enables access to a shared device or service. A WiFi client can access a shared device or service if the access point to which the client is connected has a policy configured for the shared device or service.

To enable the multicast DNS gateway and add a policy:

1. Launch a web browser from a computer that is connected to the same network as the access point or directly to the access point through an Ethernet cable or WiFi connection.

2. Enter the IP address that is assigned to the access point.
A login window displays.

If your browser displays a security warning, you can proceed, or add an exception for the security warning. For more information, see [What to do if you get a browser security warning](#) on page 42.

3. Enter the access point user name and password.

The user name is **admin**. The password is the one that you specified. The user name and password are case-sensitive.

If you previously added the access point to a NETGEAR Insight network location and managed the access point through the Insight Cloud Portal or Insight app, enter the Insight network password for that location. For more information, see [Connect over WiFi using the NETGEAR Insight app](#) on page 24.

The Dashboard page displays.

4. Select **Management > Configuration > mDNS Gateway**.

The mDNS Gateway page displays.

5. Select the mDNS Gateway **Enable** radio button.

By default, the mDNS gateway is disabled and the Disable radio button is selected.

6. If your network includes multiple access points that support the mDNS gateway feature and this access point must function as the mDNS reflector access point in your network, select the **Yes** radio button.
By default, the No radio button is selected.
7. Click the Add Policy **+** button.
A row is added to the table with mDNS gateway policies. (You can add multiple rows for multiple policies.)
8. Define the mDNS gateway policy by specifying the following:
 - **Policy Name:** A name that lets you identify the policy. You can use up to 32 alphanumeric and special characters, except for the double quote (") and backslash (\) characters.
 - **Shared Services:** From the **Shared Services** menu, select the type of device (for example, printer) or service (for example, Googlecast) that must be shared.
 - **Service VLAN:** In the **Service VLAN** field, enter the VLAN ID that includes as members the type of shared device or service that you select from the **Shared Services** menu.
 - **Service IP:** Enter the IP address of the shared device or service that you select from the **Shared Services** menu.
 - **Allowed Wireless Network:** From the **Allowed Wireless Network** menu, select the WiFi networks with their associated VLANs, which include as members the WiFi devices that must be able to use the type of shared devices or service that you select from the **Shared Services** menu.
9. To add another mDNS policy, click the Add Policy **+** button, and repeat the previous step.
10. Click the **Apply** button.
Your settings are saved.

Change or remove a multicast DNS policy

You can change or remove a multicast DNS (mDNS) policy.

To change or remove an mDNS policy:

1. Launch a web browser from a computer that is connected to the same network as the access point or directly to the access point through an Ethernet cable or WiFi connection.
2. Enter the IP address that is assigned to the access point.
A login window displays.

If your browser displays a security warning, you can proceed, or add an exception for the security warning. For more information, see [What to do if you get a browser security warning](#) on page 42.

3. Enter the access point user name and password.

The user name is **admin**. The password is the one that you specified. The user name and password are case-sensitive.

If you previously added the access point to a NETGEAR Insight network location and managed the access point through the Insight Cloud Portal or Insight app, enter the Insight network password for that location. For more information, see [Connect over WiFi using the NETGEAR Insight app](#) on page 24.

The Dashboard page displays.

4. Select **Management > Configuration > mDNS Gateway**.

The mDNS Gateway page displays.

5. To change a policy:

- a. Click the **pencil and notebook** icon to the right of the policy.

- b. Change the settings.

For more information about the settings, see [Enable the multicast DNS gateway and add a policy](#) on page 146.

- c. Click the **Apply** button.

Your settings are saved.

6. To remove a policy:

- a. Click the **trash can** icon to the right of the policy.

- b. Confirm the deletion.

10

Manage and Maintain the Access Point

This chapter describes how you can manage and maintain the access point.

The chapter includes the following sections:

- [Change the management mode to NETGEAR Insight or Web-browser](#)
- [Change the country or region of operation](#)
- [Change the admin user account password](#)
- [Change the system name](#)
- [Specify a custom NTP server](#)
- [Set the time zone](#)
- [Manage the syslog settings](#)
- [Manage the firmware of the access point](#)
- [Manage the configuration file of the access point](#)
- [Reboot the access point from the local browser UI](#)
- [Schedule the access point to reboot](#)
- [Return the access point to its factory default settings](#)
- [Enable SNMP and manage the SNMP settings](#)
- [Manage the LEDs](#)
- [Manage the Energy Efficiency Mode](#)

Note: In this manual, *WiFi network* means the same as SSID (service set identifier or WiFi network name) or VAP (virtual access point). That is, when we refer to a WiFi network we mean an individual SSID or VAP.

Change the management mode to NETGEAR Insight or Web-browser

The access point can function in either of the following management modes:

- **NETGEAR Insight mode:** For NETGEAR Insight Premium and Insight Pro subscribers, you can manage the access point remotely through the Insight Cloud Portal or from a mobile device on which the NETGEAR Insight app is installed. The NETGEAR Insight mode is the default setting. In this mode, you *can* connect to the access point over the local browser UI, but only a basic and limited local browser UI is available. For information about the NETGEAR Insight Cloud Portal and Insight app, visit insight.netgear.com and see the NETGEAR knowledge base at netgear.com/support/product/insight.aspx.

CAUTION: When you change the management mode from Web-browser mode to NETGEAR Insight mode, the configuration of the access point is reset (cleared) with the exception of the IP address, access point name, and password for the local browser UI. The access point restarts and broadcasts SSID Netgearxxxxxx, in which xxxxxx represents the last six hexadecimal digits of the access point's MAC address. The MAC address is listed on the product label. The default WiFi passphrase is **sharedsecret**.

- **Web-browser mode:** You can manage the access point locally from a WiFi or wired device through the local browser UI. In this mode, the access point functions as a standalone device and is not connected to the Insight cloud-based management platform.

Note: If you first add the access point to a NETGEAR Insight network location and manage the access point through the Insight Cloud Portal or Insight app and then you change the management mode to Web-browser mode, you must continue to use the Insight network password to access the local browser UI until you manually change the admin password on the access point.

To change the management mode to NETGEAR Insight mode or Web-browser mode:

1. Launch a web browser from a computer that is connected to the same network as the access point or directly to the access point through an Ethernet cable or WiFi connection.
2. Enter the IP address that is assigned to the access point.
A login window displays.

If your browser displays a security warning, you can proceed, or add an exception for the security warning. For more information, see [What to do if you get a browser security warning](#) on page 42.

3. Enter the access point user name and password.

The user name is **admin**. The password is the one that you specified. The user name and password are case-sensitive.

If you previously added the access point to a NETGEAR Insight network location and managed the access point through the Insight Cloud Portal or Insight app, enter the Insight network password for that location. For more information, see [Connect over WiFi using the NETGEAR Insight app](#) on page 24.

The Dashboard page displays.

4. Select **Management > Configuration > System > Basic > Management Mode**.

The Management Mode page displays.

5. Select one of the following radio buttons:

- **NETGEAR Insight:** The access point functions in NETGEAR Insight management mode.
- **Web-browser:** The access point functions in Web-browser management mode.

CAUTION: When you change the management mode from Web-browser mode to NETGEAR Insight mode, the configuration of the access point is reset (cleared) with the exception of the IP address, access point name, and password for the local browser UI. The access point restarts and broadcasts SSID Netgearxxxxxx, in which xxxxxx represents the last six hexadecimal digits of the access point's MAC address. The MAC address is listed on the product label. The default WiFi passphrase is **sharedsecret**.

6. Click the **Apply** button.

A warning pop-up window displays.

7. Click the **OK** button.

The pop-up window closes and your settings are saved. The access point restarts in the new management mode.

Change the country or region of operation

You can change the country or region in which the access point operates. Note the following:

- Make sure that the country is set to the location where the device is operating. You are responsible for complying with the local, regional, and national regulations that are set for channels, power levels, and frequency ranges.
- It might not be legal to operate the access point in a country or region other than those listed in the menu. If your country or region is not listed in the menu, you must check with your local government agency or check the NETGEAR website for information about which channels you can use.
- In some countries, the access point is sold with a preconfigured country or region setting and you cannot change it.

To change the country or region of operation:

1. Launch a web browser from a computer that is connected to the same network as the access point or directly to the access point through an Ethernet cable or WiFi connection.

2. Enter the IP address that is assigned to the access point.

A login window displays.

If your browser displays a security warning, you can proceed, or add an exception for the security warning. For more information, see [What to do if you get a browser security warning](#) on page 42.

3. Enter the access point user name and password.

The user name is **admin**. The password is the one that you specified. The user name and password are case-sensitive.

If you previously added the access point to a NETGEAR Insight network location and managed the access point through the Insight Cloud Portal or Insight app, enter the Insight network password for that location. For more information, see [Connect over WiFi using the NETGEAR Insight app](#) on page 24.

The Dashboard page displays.

4. Select **Management > Configuration > System > Basic**.

The General page displays the basic system settings.

5. Select a country or region from the **Country / Region** menu.

6. Click the **Apply** button.

A warning pop-up window displays.

7. Click the **OK** button.

The pop-up window closes and your settings are saved. The access point restarts with the default WiFi and radio settings that are specific to the selected country or region.

Change the admin user account password

This admin user account password is the password that you use to log in to the local browser UI of the access point with the user name admin. (It is not the passphrase that you use for WiFi access.)

The password must be 8 to 63 characters in length and must contain at least one uppercase letter, one lowercase letter, and one number. The following special characters are allowed:

! @ # \$ % ^ & * ()

To change the password for the user name admin:

1. Launch a web browser from a computer that is connected to the same network as the access point or directly to the access point through an Ethernet cable or WiFi connection.

2. Enter the IP address that is assigned to the access point.
A login window displays.

If your browser displays a security warning, you can proceed, or add an exception for the security warning. For more information, see [What to do if you get a browser security warning](#) on page 42.

3. Enter the access point user name and password.

The user name is **admin**. The password is the one that you specified. The user name and password are case-sensitive.

If you previously added the access point to a NETGEAR Insight network location and managed the access point through the Insight Cloud Portal or Insight app, enter the Insight network password for that location. For more information, see [Connect over WiFi using the NETGEAR Insight app](#) on page 24.

The Dashboard page displays.

4. Select **Management > Configuration > System > Advanced > User Accounts**.

The page that displays lets you change the user accounts.

5. Next to admin, in the **Password** field, enter the new password.

6. In the **Confirm Password** field, enter the same new password.

Note: You cannot change the user name. The name must remain admin.

7. Click the **Apply** button.

Your settings are saved. The next time that you log in to the access point, you must use the new password. If you forget the new password, you must reset the access point to factory default settings. Doing so restores the password to the default password.

Change the system name

The system name (also referred to as access point name, or AP name) is a unique NetBIOS name for the access point. The default system name is located on the access point label. By default, the system name is Netgearxxxxxx, in which xxxxxx represents the last six hexadecimal digits of the access point's MAC address.

To change the system name:

1. Launch a web browser from a computer that is connected to the same network as the access point or directly to the access point through an Ethernet cable or WiFi connection.
2. Enter the IP address that is assigned to the access point.
A login window displays.
If your browser displays a security warning, you can proceed, or add an exception for the security warning. For more information, see [What to do if you get a browser security warning](#) on page 42.
3. Enter the access point user name and password.
The user name is **admin**. The password is the one that you specified. The user name and password are case-sensitive.
If you previously added the access point to a NETGEAR Insight network location and managed the access point through the Insight Cloud Portal or Insight app, enter the Insight network password for that location. For more information, see [Connect over WiFi using the NETGEAR Insight app](#) on page 24.
The Dashboard page displays.
4. Select **Management > Configuration > System > Basic**.
The General page displays the basic system settings.
5. Enter a new name in the **System Name** field.

Use the following guidelines:

- The name must contain alphanumeric characters, can contain hyphens, and cannot be longer than 15 characters.
- The name cannot start or end with a hyphen.
- The name must contain at least one alphabetical character.

6. Click the **Apply** button.
Your settings are saved.

Specify a custom NTP server

By default, the access point receives its time from a default NETGEAR Network Time Protocol (NTP) server, but you can also specify a custom NTP server.

To specify a custom NTP server:

1. Launch a web browser from a computer that is connected to the same network as the access point or directly to the access point through an Ethernet cable or WiFi connection.

2. Enter the IP address that is assigned to the access point.
A login window displays.

If your browser displays a security warning, you can proceed, or add an exception for the security warning. For more information, see [What to do if you get a browser security warning](#) on page 42.

3. Enter the access point user name and password.

The user name is **admin**. The password is the one that you specified. The user name and password are case-sensitive.

If you previously added the access point to a NETGEAR Insight network location and managed the access point through the Insight Cloud Portal or Insight app, enter the Insight network password for that location. For more information, see [Connect over WiFi using the NETGEAR Insight app](#) on page 24.

The Dashboard page displays.

4. Select **Management > Configuration > System > Basic > Time**.

The screenshot shows a configuration window for the Time settings. It includes a dropdown menu for Time Zone (USA-Pacific), a text field for Current Time (24-hour) (Wed Jun 3 16:01:10 PDT 2020), a radio button for NTP Client (Enable), a checkbox for Use Custom NTP Server, and radio buttons for Hostname (selected) and IP Address. The NTP Server field contains time-b.netgear.com. At the bottom, there are Cancel and Apply buttons.

By default, the **Enable** radio button is selected and the access point receives its time from a default NETGEAR NTP server.

5. Select the **Use Custom NTP Server** check box.
6. Take one of the following actions:
 - Enter the host name of the NTP server.
By default, the **Hostname** radio button is selected.
 - Select the **IP address** radio button and enter the IP address of the NTP server.
7. Click the **Apply** button.

Your settings are saved. When the access point connects over the Internet to the new NTP server, the date and time that display on the page are adjusted according to your settings.

For information about setting the time zone, see [Set the time zone](#) on page 156.

Set the time zone

When the access point synchronizes its clock with a Network Time Protocol (NTP) server, the page shows the date and time. If the page does not show the correct date and time, you might need to set the time zone and adjust the daylight saving time setting.

To set the time zone and adjust the daylight saving time setting:

1. Launch a web browser from a computer that is connected to the same network as the access point or directly to the access point through an Ethernet cable or WiFi connection.
2. Enter the IP address that is assigned to the access point.
A login window displays.

If your browser displays a security warning, you can proceed, or add an exception for the security warning. For more information, see [What to do if you get a browser security warning](#) on page 42.

3. Enter the access point user name and password.

The user name is **admin**. The password is the one that you specified. The user name and password are case-sensitive.

If you previously added the access point to a NETGEAR Insight network location and managed the access point through the Insight Cloud Portal or Insight app, enter the Insight network password for that location. For more information, see [Connect over WiFi using the NETGEAR Insight app](#) on page 24.

The Dashboard page displays.

4. Select **Management > Configuration > System > Basic > Time**.

The page that displays lets you change the time settings.

5. From the **Time Zone** menu, select the time zone for the area in which the access point operates.

6. Click the **Apply** button.

Your settings are saved. When the access point connects over the Internet to an NTP server, the date and time that display on the page are adjusted according to your settings.

For information about other time settings, see [Specify a custom NTP server](#) on page 155.

Manage the syslog settings

If a syslog server is present on your network, you can configure the access point to send its system logs to the syslog server.

To manage the syslog settings and enable the syslog function:

1. Launch a web browser from a computer that is connected to the same network as the access point or directly to the access point through an Ethernet cable or WiFi connection.

2. Enter the IP address that is assigned to the access point.

A login window displays.

If your browser displays a security warning, you can proceed, or add an exception for the security warning. For more information, see [What to do if you get a browser security warning](#) on page 42.

3. Enter the access point user name and password.

The user name is **admin**. The password is the one that you specified. The user name and password are case-sensitive.

If you previously added the access point to a NETGEAR Insight network location and managed the access point through the Insight Cloud Portal or Insight app, enter the Insight network password for that location. For more information, see [Connect over WiFi using the NETGEAR Insight app](#) on page 24.

The Dashboard page displays.

4. Select **Management > Configuration > System > Advanced > Syslog**.



5. Specify the IP address and port number for the syslog server:
 - **Syslog Server IP Address:** Enter the IP address of the syslog server on your network.
 - **Port Number:** Enter the port number at which the syslog can be reached. By default, the port number is 514.
6. To enable the syslog server function, select the **Enable Syslog** check box.
7. Click the **Apply** button.
Your settings are saved.

Manage the firmware of the access point

The access point firmware is stored in flash memory.

You can check to see if new firmware is available and update the access point to the new firmware. You can also visit the NETGEAR support website, download the firmware manually to a local computer, and update the access point to the new firmware. If someone (usually the network administrator) places new firmware on a secure FTP (SFTP) server in the network, you can load the firmware from the server and update the firmware of the access point.

Depending on how you are connected to the access point, we recommend the following firmware update methods:

- **WiFi connection:** If you are connected over WiFi to the access point, let the access point check the Internet to see if new firmware is available. See [Let the access point check for new firmware and update the firmware](#) on page 159.
With this method, if new firmware is available, it is downloaded directly to the access point.

- **LAN connection:** If you are connected over the LAN to the access point, manually update the firmware from a computer or SFTP server. See [Manually download firmware and update the access point](#) on page 160 or [Use an SFTP server to update the access point](#) on page 163.
With this mode, if new firmware is available, you must either download it to your computer and then upload it to the access point or upload it from an SFTP server to the access point.

The following sections describe the firmware management methods:

- [Let the access point check for new firmware and update the firmware](#)
- [Manually download firmware and update the access point](#)
- [Revert to the backup firmware](#)
- [Use an SFTP server to update the access point](#)

Let the access point check for new firmware and update the firmware

For you to let the access point check for new firmware, the access point must be connected to the Internet.

To let the access point check for new firmware and update the access point:

1. Launch a web browser from a computer that is connected to the same network as the access point or directly to the access point through an Ethernet cable or WiFi connection.

2. Enter the IP address that is assigned to the access point.

A login window displays.

If your browser displays a security warning, you can proceed, or add an exception for the security warning. For more information, see [What to do if you get a browser security warning](#) on page 42.

3. Enter the access point user name and password.

The user name is **admin**. The password is the one that you specified. The user name and password are case-sensitive.

If you previously added the access point to a NETGEAR Insight network location and managed the access point through the Insight Cloud Portal or Insight app, enter the Insight network password for that location. For more information, see [Connect over WiFi using the NETGEAR Insight app](#) on page 24.

The Dashboard page displays.

4. Click the **Check for Upgrade** button.

The access point detects new firmware if any is available and displays the latest version available.

5. To read the release notes if any are available, click the **Release Notes** link. A web page displays the release notes.
6. To download and install the new firmware, click the **Upgrade Now** button, and follow the prompts and dialog boxes. The access point locates the firmware, downloads it, and begins the update.

WARNING: To avoid the risk of corrupting the firmware, do not interrupt the update. For example, do not close the browser, click a link, or load a new page. Do not turn off the access point. Wait until the access point finishes restarting and the Power/Cloud LED remains solid green or solid blue.

The firmware update process takes several minutes. When the update is complete, your access point restarts.

7. Verify that the access point runs the new firmware version by logging back in to the access point. The firmware version is displayed on the Dashboard page.
8. Read the new firmware release notes to determine whether you must reconfigure the access point after updating.

Manually download firmware and update the access point

Downloading firmware to a local computer and updating the access point are two separate tasks that are combined in the following procedure. After you update the access point to new firmware, the old firmware is saved as backup firmware so that you can revert to it (see [Revert to the backup firmware](#) on page 162).

CAUTION: When you install an older firmware version (or the backup firmware version), that is, you downgrade rather than update the firmware, the configuration of the access point is reset (cleared) with the exception of the IP address, access point name, and password for the local browser UI. The access point restarts and broadcasts SSID Netgearxxxxxx, in which xxxxxx represents the last six hexadecimal digits of the access point's MAC address. The MAC address is listed on the product label. The default WiFi passphrase is **sharedsecret**.

To download firmware manually and update the access point:

1. Visit netgear.com/support/download/, locate the support page for your product, and download the new firmware.
2. Read the new firmware release notes to determine whether you must reconfigure the access point after upgrading.
3. Launch a web browser from a computer that is connected to the same network as the access point or directly to the access point through an Ethernet cable or WiFi connection.
4. Enter the IP address that is assigned to the access point.
A login window displays.
If your browser displays a security warning, you can proceed, or add an exception for the security warning. For more information, see [What to do if you get a browser security warning](#) on page 42.
5. Enter the access point user name and password.
The user name is **admin**. The password is the one that you specified. The user name and password are case-sensitive.
If you previously added the access point to a NETGEAR Insight network location and managed the access point through the Insight Cloud Portal or Insight app, enter the Insight network password for that location. For more information, see [Connect over WiFi using the NETGEAR Insight app](#) on page 24.
The Dashboard page displays.
6. Select **Management > Maintenance > Upgrade > Firmware Upgrade**.
The Firmware Upgrade page displays.
7. Make sure that **Local** is selected from the **Upgrade Options** menu.
Local is the default selection.
8. Locate and select the firmware file on your computer by doing the following:
 - a. Click the **Browse** button.
 - b. Navigate to the firmware file.
The file name ends in `.tar`.
 - c. Select the firmware file.
9. Click the **Upgrade** button.

WARNING: To avoid the risk of corrupting the firmware, do not interrupt the update. For example, do not close the browser, click a link, or load a new page. Do not turn off the access point. Wait until the access point finishes restarting and the Power/Cloud LED remains solid green or solid blue.

The firmware update process takes several minutes. When the update is complete, the access point restarts.

10. Verify that the access point runs the new firmware version by logging back in to the access point.

The firmware version is displayed on the Dashboard page.

Revert to the backup firmware

After you upgrade the access point to new firmware, the old firmware is saved as backup firmware so that you can revert to it.

CAUTION: When you revert to the backup firmware and the backup firmware is an earlier version than the firmware version that is running on the access point, the configuration of the access point is reset (cleared) with the exception of the IP address, access point name, and password for the local browser UI. The access point restarts and broadcasts SSID Netgearxxxxxx, in which xxxxxx represents the last six hexadecimal digits of the access point's MAC address. The MAC address is listed on the product label. The default WiFi passphrase is **sharedsecret**.

To revert to the backup firmware on the access point:

1. Launch a web browser from a computer that is connected to the same network as the access point or directly to the access point through an Ethernet cable or WiFi connection.

2. Enter the IP address that is assigned to the access point.

A login window displays.

If your browser displays a security warning, you can proceed, or add an exception for the security warning. For more information, see [What to do if you get a browser security warning](#) on page 42.

3. Enter the access point user name and password.

The user name is **admin**. The password is the one that you specified. The user name and password are case-sensitive.

If you previously added the access point to a NETGEAR Insight network location and managed the access point through the Insight Cloud Portal or Insight app, enter the Insight network password for that location. For more information, see [Connect over WiFi using the NETGEAR Insight app](#) on page 24.

The Dashboard page displays.

4. Select **Management > Maintenance > Upgrade > Firmware Upgrade**.

The Firmware Upgrade page displays. The page shows both the current firmware version and the backup firmware version.

5. Click the **Boot up Backup Firmware** button.

A warning pop-up window displays.

CAUTION: When you revert to the backup firmware, the configuration of the access point is reset (cleared) with the exception of the IP address, access point name, and password for the local browser UI. The access point restarts and broadcasts SSID Netgearxxxxxx, in which xxxxxx represents the last six hexadecimal digits of the access point's MAC address. The MAC address is listed on the product label. The default WiFi passphrase is **sharedsecret**.

6. Click the **Swap** button.

The pop-up window closes, the firmware reversion process initiates, and the access point restarts.

WARNING: To avoid the risk of corrupting the firmware, do not interrupt the reversion. For example, do not close the browser, click a link, or load a new page. Do not turn off the access point. Wait until the access point finishes restarting and the Power/Cloud LED remains solid green or solid blue.

7. Verify that the access point runs the backup firmware version by logging back in to the access point.

The firmware version is displayed on the Dashboard page.

Use an SFTP server to update the access point

If someone (usually the network administrator) places new firmware on a secure FTP (SFTP) server in the network, you can load the firmware from the SFTP server and update the firmware of the access point.

To update the firmware of the access point from an SFTP server:

1. Launch a web browser from a computer that is connected to the same network as the access point or directly to the access point through an Ethernet cable or WiFi connection.
2. Enter the IP address that is assigned to the access point.
A login window displays.

If your browser displays a security warning, you can proceed, or add an exception for the security warning. For more information, see [What to do if you get a browser security warning](#) on page 42.

3. Enter the access point user name and password.

The user name is **admin**. The password is the one that you specified. The user name and password are case-sensitive.

If you previously added the access point to a NETGEAR Insight network location and managed the access point through the Insight Cloud Portal or Insight app, enter the Insight network password for that location. For more information, see [Connect over WiFi using the NETGEAR Insight app](#) on page 24.

The Dashboard page displays.

4. Select **Management > Maintenance > Upgrade > Firmware Upgrade**.

The Firmware Upgrade page displays.

5. From the **Upgrade Options** menu, select **SFTP**.

6. Specify the following server settings:

- **Firmware File:** The name of the access point firmware file on the SFTP server.
- **SFTP Server IP:** The IP address of the SFTP server on your network.
- **User Name:** The user name that is required to access the SFTP server.
- **Password:** The password that is required to access the SFTP server.

7. Click the **Upgrade** button.

WARNING: To avoid the risk of corrupting the firmware, do not interrupt the update. For example, do not close the browser, click a link, or load a new page. Do not turn off the access point. Wait until the access point finishes restarting and the Power/Cloud LED remains solid green or solid blue.

The firmware update process takes several minutes. When the update is complete, the access point restarts.

8. Verify that the access point runs the new firmware version by logging back in to the access point.

The firmware version is displayed on the Dashboard page.

Manage the configuration file of the access point

The configuration settings of the access point are stored within the access point in a configuration file. You can back up (save) this file to your computer or restore it.

Back up the access point configuration

You can save a copy of the current configuration settings. If necessary, you can restore the configuration settings later.

Note: The backup file is saved in a binary format so that it is protected and cannot be opened by a regular application.

To back up the access point's configuration settings:

1. Launch a web browser from a computer that is connected to the same network as the access point or directly to the access point through an Ethernet cable or WiFi connection.

2. Enter the IP address that is assigned to the access point.
A login window displays.

If your browser displays a security warning, you can proceed, or add an exception for the security warning. For more information, see [What to do if you get a browser security warning](#) on page 42.

3. Enter the access point user name and password.

The user name is **admin**. The password is the one that you specified. The user name and password are case-sensitive.

If you previously added the access point to a NETGEAR Insight network location and managed the access point through the Insight Cloud Portal or Insight app, enter the Insight network password for that location. For more information, see [Connect over WiFi using the NETGEAR Insight app](#) on page 24.

The Dashboard page displays.

4. Select **Management > Maintenance > Upgrade > Backup and Restore > Backup Settings**.

The Backup Settings page displays.

5. Click the **Backup** button.

A pop-up window displays.

6. Enter a password to protect the backup file, and click the **Continue** button.

You can either use your existing password (the one that you use to log in to the access point) or enter a unique password.

The password must be 8 to 63 characters in length and must contain at least one uppercase letter, one lowercase letter, and one number. Special characters are not allowed.

Note: We recommend that you save the password because you must enter it again if you restore the configuration from the backup file.

7. Choose a location to store the file on your computer.

The name of the backup file can be

WAX6XX-NETGEARYYYYYY-dd-mm-yy_hh-mm-ss-config.tar or
WAX6XX-WAX6XX-YYYYYY-dd-mm-yy_hh-mm-ss-config.tar.

6XX represents the model number, YYYYYY represents the last six hexadecimal digits of the access point's MAC address (or the system name), dd is the date, mm is the month, yy is the year, hh is the hour (in 24-hour format), mm is the minutes, and ss is the seconds.

Examples of the name of a backup file are

WAX6XX-NETGEAR1A2B3C-06-18-21_16-44-12-config.tar and
WAX6XX-WAX6XX-1A2B3C-06-18-21_16-44-12-config.tar.

8. Follow the directions of your browser to save the file.

Restore the access point configuration

If you backed up the configuration file, you can restore the configuration from this file.

To restore configuration settings that you backed up:

1. Launch a web browser from a computer that is connected to the same network as the access point or directly to the access point through an Ethernet cable or WiFi connection.

2. Enter the IP address that is assigned to the access point.

A login window displays.

If your browser displays a security warning, you can proceed, or add an exception for the security warning. For more information, see [What to do if you get a browser security warning](#) on page 42.

3. Enter the access point user name and password.

The user name is **admin**. The password is the one that you specified. The user name and password are case-sensitive.

If you previously added the access point to a NETGEAR Insight network location and managed the access point through the Insight Cloud Portal or Insight app, enter the Insight network password for that location. For more information, see [Connect over WiFi using the NETGEAR Insight app](#) on page 24.

The Dashboard page displays.

4. Select **Management > Maintenance > Upgrade > Backup and Restore > Restore Settings**.

The Restore Settings page displays.

5. Click the **Browse** button and navigate to and select the saved configuration file.

The name of the backup file can be

WAX6XX-NETGEARYYYYYY-dd-mm-yy_hh-mm-ss-config.tar or

WAX6XX-WAX6XX-YYYYYY-dd-mm-yy_hh-mm-ss-config.tar.

6XX represents the model number, YYYYYY represents the last six hexadecimal digits of the access point's MAC address (or the system name), dd is the date, mm is the month, yy is the year, hh is the hour (in 24-hour format), mm is the minutes, and ss is the seconds.

Examples of the name of a backup file are

WAX6XX-NETGEAR1A2B3C-06-18-21_16-44-12-config.tar and

WAX6XX-WAX6XX-1A2B3C-06-18-21_16-44-12-config.tar.

6. Click the **Restore** button.
A pop-up window displays.
7. Enter the password that you specified when you saved the backup file, and click the **Continue** button.
8. Click the **Restore** button.

The pop-up window closes and the configuration is uploaded to the access point. When the restoration is complete, the access point reboots. This process takes about two minutes.

WARNING: To avoid the risk of corrupting the firmware, do not interrupt the restoration. For example, do not close the browser, click a link, or load a new page. Do not turn off the access point. Wait until the access point finishes restarting and the Power/Cloud LED turns solid green or solid blue.

Reboot the access point from the local browser UI

If you cannot physically access the access point to reboot it (that is, disconnect the power and reconnect the power), you can use the local browser UI to reboot the access point.

To reboot the access point:

1. Launch a web browser from a computer that is connected to the same network as the access point or directly to the access point through an Ethernet cable or WiFi connection.

2. Enter the IP address that is assigned to the access point.

A login window displays.

If your browser displays a security warning, you can proceed, or add an exception for the security warning. For more information, see [What to do if you get a browser security warning](#) on page 42.

3. Enter the access point user name and password.

The user name is **admin**. The password is the one that you specified. The user name and password are case-sensitive.

If you previously added the access point to a NETGEAR Insight network location and managed the access point through the Insight Cloud Portal or Insight app, enter the Insight network password for that location. For more information, see [Connect over WiFi using the NETGEAR Insight app](#) on page 24.

The Dashboard page displays.

4. Select **Management > Maintenance > Reset > Reboot AP**.

The Reboot AP page displays.

5. Click the **Reboot AP** button.

A warning pop-up window displays.

6. Click the **Reboot** button.

The pop-up window closes and the access point reboots, which takes about one minute.

Schedule the access point to reboot

You can schedule the access point to reboot at a time that is more convenient for the network, for example, when you do not expect any (or only a few) WiFi clients to be connected to the access point. The schedule that you set up is a recurring schedule.

To schedule the access point to reboot:

1. Launch a web browser from a computer that is connected to the same network as the access point or directly to the access point through an Ethernet cable or WiFi connection.
2. Enter the IP address that is assigned to the access point.
A login window displays.
If your browser displays a security warning, you can proceed, or add an exception for the security warning. For more information, see [What to do if you get a browser security warning](#) on page 42.
3. Enter the access point user name and password.
The user name is **admin**. The password is the one that you specified. The user name and password are case-sensitive.
If you previously added the access point to a NETGEAR Insight network location and managed the access point through the Insight Cloud Portal or Insight app, enter the Insight network password for that location. For more information, see [Connect over WiFi using the NETGEAR Insight app](#) on page 24.
The Dashboard page displays.
4. Select **Management > Maintenance > Reset > Reboot AP**.
The Reboot AP page displays.
5. Click the **Enable Scheduled Reboot** button so that the button displays blue.
The scheduling controls display.
6. Select the check box for the day on which you want the access point to reboot.
You can select multiple days.
7. Using the **Start Time** menus, specify the hour and minutes for the time at which the access point must reboot.
Specify the hour in 24-hour format.
8. Click the **Apply** button.
Your settings are saved.

Return the access point to its factory default settings

Under some circumstances (for example, if you lost track of the changes that you made to the access point settings or you move the access point to a different network), you might want to erase the configuration and reset the access point to factory default settings.

If you do not know the current IP address of the access point, first try to use an IP scanner application to detect the IP address before you reset the access point to factory default settings.

Note: You can also use the NETGEAR Insight app to discover the IP address that is assigned to the access point. For more information, see [Connect over WiFi using the NETGEAR Insight app](#) on page 24.

To reset the access point to factory default settings, you can use either the **Reset** button on the access point or the reset function in the local browser UI. However, if you cannot find the IP address or you lost the password to access the access point, you must use the **Reset** button.

After you reset the access point to factory default settings, the password for the admin user name is **password**, the access point's DHCP client is enabled, the setup SSID is shown in the format NETGEARxxxxxx-SETUP, and the default password for WiFi access is **sharedsecret**. If the access point does not receive an IP address from a DHCP server, the LAN IP address is set to 192.168.0.100.

For an extensive list of factory default settings, see [Factory default settings](#) on page 249.

Use the Reset button to reset the access point

You can use the **Reset** button to return the access point to its factory default settings. However, if you added the access point to a NETGEAR Insight network location, you must first use the Insight Cloud Portal or Insight app to remove the access point from the Insight network location before the factory default settings function of the **Reset** button is available.

CAUTION: This process erases all settings that you configured in the access point.

To reset the access point to factory default settings:

1. On the bottom panel of the access point, locate the recessed **Reset** button.

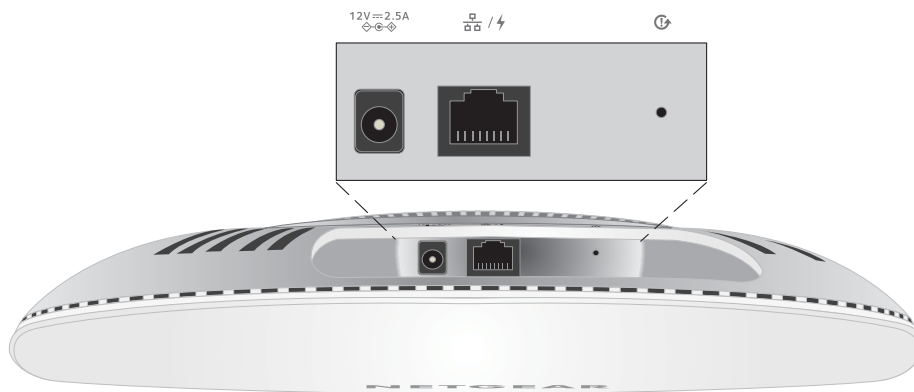

2. Using a straightened paper clip, press and hold the **Reset** button for at least 10 seconds.

Note: If you hold the **Reset** button for less than 10 seconds and then release it, the access point reboots rather than returns to its factory default settings.

3. Release the **Reset** button.

The configuration is reset to factory default settings. When the reset is complete, the access point reboots. This process takes about two minutes.

WARNING: To avoid the risk of corrupting the firmware, do not interrupt the reset. Do not turn off the access point. Wait until the access point finishes restarting and the Power/Cloud LED turns solid green or solid blue.

Use the local browser UI to reset the access point

You can use the access point's local browser UI to return the access point to its factory default settings.

CAUTION: This process erases all settings that you configured in the access point.

To reset the access point to factory default settings through the local browser UI:

1. Launch a web browser from a computer that is connected to the same network as the access point or directly to the access point through an Ethernet cable or WiFi connection.
2. Enter the IP address that is assigned to the access point.
A login window displays.

If your browser displays a security warning, you can proceed, or add an exception for the security warning. For more information, see [What to do if you get a browser security warning](#) on page 42.

3. Enter the access point user name and password.

The user name is **admin**. The password is the one that you specified. The user name and password are case-sensitive.

If you previously added the access point to a NETGEAR Insight network location and managed the access point through the Insight Cloud Portal or Insight app, enter the Insight network password for that location. For more information, see [Connect over WiFi using the NETGEAR Insight app](#) on page 24.

The Dashboard page displays.

4. Select **Management > Maintenance > Reset > Restore Defaults**.

The Restore Defaults page displays.

5. Click the **Restore Defaults** button.

A warning pop-up window displays.

6. Click the **Restore** button.

The pop-up window closes and the configuration is reset to factory default settings. When the reset is complete, the access point reboots. This process takes about two minutes.

WARNING: To avoid the risk of corrupting the firmware, do not interrupt the reset. For example, do not close the browser, click a link, or load a new page. Do not turn off the access point. Wait until the access point finishes restarting and the Power/Cloud LED turns solid green or solid blue.

Enable SNMP and manage the SNMP settings

You can access the access point over a Simple Network Management Protocol (SNMP) connection, which allows SNMP network management software such as HP OpenView to manage the access point by using the SNMPv1 or SNMPv2 protocol. By default, SNMP is disabled.

To enable SNMP and manage the SNMP settings:

1. Launch a web browser from a computer that is connected to the same network as the access point or directly to the access point through an Ethernet cable or WiFi connection.

2. Enter the IP address that is assigned to the access point.

A login window displays.

If your browser displays a security warning, you can proceed, or add an exception for the security warning. For more information, see [What to do if you get a browser security warning](#) on page 42.

3. Enter the access point user name and password.

The user name is **admin**. The password is the one that you specified. The user name and password are case-sensitive.

If you previously added the access point to a NETGEAR Insight network location and managed the access point through the Insight Cloud Portal or Insight app, enter the Insight network password for that location. For more information, see [Connect over WiFi using the NETGEAR Insight app](#) on page 24.

The Dashboard page displays.

4. Select **Management > Maintenance > Remote Management**.

The Remote Management page displays.

5. Select the SNMP **Enable** radio button.

By default, SNMP is disabled.

The screenshot shows the SNMP configuration interface. At the top, there are two radio buttons: 'Enable' (which is selected) and 'Disable'. Below this, there are three input fields for community names: 'Read-Only Community Name' with the value 'public', 'Read-Write Community Name' with the value 'private', and 'Trap Community Name' with the value 'trap'. There are also two more input fields: 'IP Address (to receive traps)' which is empty, and 'Trap Port' with the value '162'. At the bottom left, there are two buttons: 'Cancel' and 'Apply'.

6. Specify the following settings:

- **Read-Only Community Name:** The community string that allows the SNMP manager to read the access point’s MIB objects. The default is public.

- **Read-Write Community Name:** The community string that allows the SNMP manager to read and write the access point's MIB objects. The default is private.
- **Trap Community Name:** The community name that is associated with the IP address that must receive traps. The default is trap.
- **IP address (to receive traps):** The IP address of the SNMP manager that must receive traps.
- **Trap Port:** The port number at which the SNMP manager must receive traps. The default is 162.

7. Click the **Apply** button.
Your settings are saved.

Manage the LEDs

By default, all LEDs are enabled and function as described in [Top panel with LEDs](#) on page 11. You can manage whether the LEDs light at all. This function is useful if you want the access point to function in a dark environment.

To enable or disable the LEDs:

1. Launch a web browser from a computer that is connected to the same network as the access point or directly to the access point through an Ethernet cable or WiFi connection.

2. Enter the IP address that is assigned to the access point.

A login window displays.

If your browser displays a security warning, you can proceed, or add an exception for the security warning. For more information, see [What to do if you get a browser security warning](#) on page 42.

3. Enter the access point user name and password.

The user name is **admin**. The password is the one that you specified. The user name and password are case-sensitive.

If you previously added the access point to a NETGEAR Insight network location and managed the access point through the Insight Cloud Portal or Insight app, enter the Insight network password for that location. For more information, see [Connect over WiFi using the NETGEAR Insight app](#) on page 24.

The Dashboard page displays.

4. Select **Management > Configuration > System > Advanced > LED Control**.

The LED Control page displays.

5. Select or clear one of the following radio buttons:
 - **Enable All LEDs:** All LEDs are enabled. This is the default setting.
 - **Disable All LEDs:** All LEDs are disabled.
 - **Enable Power/Cloud LED:** All LEDs are disabled except for the Power/Cloud LED.
6. Click the **Apply** button.
Your settings are saved.

Manage the Energy Efficiency Mode

If no WiFi clients are connected to the access point, the access point can automatically enter Energy Efficiency Mode (EEM) to reduce power consumption and save energy. When one or more WiFi clients connect, the access point automatically leaves the EEM to resume normal operation.

If EEM is enabled and no WiFi clients are connected to the access point, antenna stream operation is limited to 1x1. (Under normal circumstances, the access point can support multiple antenna streams.) If a WiFi client initiates a connection to the access point, the antenna streams resume normal operation.

Note the following restrictions:

- **Wireless distribution system:** EEM is mutually exclusive with a wireless distribution system (WDS, see [Set up a WiFi Bridge](#) on page 213).
- **Neighbor AP detection:** EEM does not let the 5 GHz radio detect neighbor APs (see [Manage neighbor AP detection](#) on page 123).
- **DFS channels:** When WiFi clients connect to the access point and the access point resumes normal operation, 5 GHz radio transmissions can be temporarily suspended if the access point operates in a DFS channel (about 1 minute suspension for a DFS channel; about 10 minutes suspension for a weather DFS channel).

Note: If use you EEM, we recommend that you enable band steering in your WiFi networks. Band steering lets 5-GHz-capable WiFi clients that are connected to the 2.4 GHz band to be steered to the 5 GHz band for improved performance. For more information, see [Enable or disable band steering with 802.11k RRM and 802.11v WiFi network management](#) on page 81.

To enable or disable the Energy Efficiency Mode:

1. Launch a web browser from a computer that is connected to the same network as the access point or directly to the access point through an Ethernet cable or WiFi connection.

2. Enter the IP address that is assigned to the access point.

A login window displays.

If your browser displays a security warning, you can proceed, or add an exception for the security warning. For more information, see [What to do if you get a browser security warning](#) on page 42.

3. Enter the access point user name and password.

The user name is **admin**. The password is the one that you specified. The user name and password are case-sensitive.

If you previously added the access point to a NETGEAR Insight network location and managed the access point through the Insight Cloud Portal or Insight app, enter the Insight network password for that location. For more information, see [Connect over WiFi using the NETGEAR Insight app](#) on page 24.

The Dashboard page displays.

4. Select **Management > Configuration > System > Advanced > Energy Efficiency Mode**.

The Energy Efficiency Mode page displays.

5. Select a radio button:

- **Enable:** Energy Efficiency Mode is enabled.
- **Disable:** Energy Efficiency Mode is disabled. This is the default setting.

6. Click the **Apply** button.

Your settings are saved.

11

Monitor the Access Point and the Network

This chapter describes how you can monitor the access point and the network.

The chapter includes the following sections:

- [Display the access point Internet, IP, and system settings](#)
- [Display the WiFi radio settings](#)
- [Display unknown and known neighbor access points](#)
- [Display client distribution, connected clients, and client trends](#)
- [View WiFi and Ethernet traffic, traffic and ARP statistics, and channel utilization](#)
- [View or download tracked URLs](#)
- [View, save, download, or clear the logs](#)
- [View a WiFi bridge connection](#)
- [View alarms and notifications](#)

Note: In this manual, *WiFi network* means the same as SSID (service set identifier or WiFi network name) or VAP (virtual access point). That is, when we refer to a WiFi network we mean an individual SSID or VAP.

Display the access point Internet, IP, and system settings

To display the access point, Internet, IP, and system settings:

1. Launch a web browser from a computer that is connected to the same network as the access point or directly to the access point through an Ethernet cable or WiFi connection.
2. Enter the IP address that is assigned to the access point.
A login window displays.
If your browser displays a security warning, you can proceed, or add an exception for the security warning. For more information, see [What to do if you get a browser security warning](#) on page 42.
3. Enter the access point user name and password.
The user name is **admin**. The password is the one that you specified. The user name and password are case-sensitive.
If you previously added the access point to a NETGEAR Insight network location and managed the access point through the Insight Cloud Portal or Insight app, enter the Insight network password for that location. For more information, see [Connect over WiFi using the NETGEAR Insight app](#) on page 24.
The Dashboard page displays.
4. Locate the Connection Status Information pane, System Information pane, and IP Settings Information pane, which are shown, respectively, on the left, upper center, and lower center of the following Dashboard figure.
If the page width on your device is narrow, these panes might be located elsewhere on the Dashboard.

For information about the radio settings, see [Display the WiFi radio settings](#) on page 181.

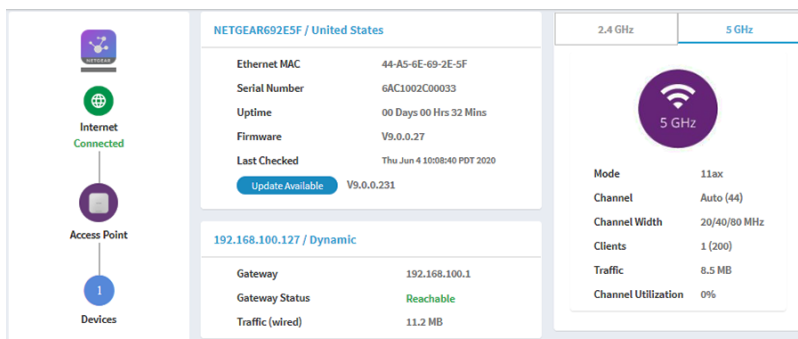

- Connection Status Information pane:** This pane is in the top, left corner of the Dashboard (if the page width on your device is sufficient; otherwise, it might be elsewhere) and displays the following:
 - Status of the connection to the NETGEAR Insight cloud-based management platform, if any.
 - Status of the Internet connection.
 - Functioning mode of the access point, which is always Access Point.
 - Number of clients connected to the access point.
- System Information pane:** This pane is in the center at the top of the Dashboard (if the page width on your device is sufficient; otherwise, it might be elsewhere) and displays the following:
 - System name of the access point and country or region of operation.
 - Ethernet MAC address.
 - The serial number.
 - Device uptime.
 - Firmware version.
 - The date and time that the access point itself or someone manually last checked if new firmware was available.

This pane also contains a button that you can click to check for firmware updates for the access point. If an update is available, the **Update Available** button displays. (For more information about firmware updates, see [Let the access point check for new firmware and update the firmware](#) on page 159).

- **IP Settings Information pane:** This pane is in the center of the Dashboard page (if the page width on your device is sufficient; otherwise, it might be elsewhere) and displays the following:
 - IP address of the access point and its DHCP status.
 - Gateway IP address.
 - Gateway status.
 - Wired traffic volume.

5. To display more detailed information, select **Management > Monitoring > System**.

System Information

System Name	WAX618-10CADF
System Mode	AP
LAN MAC Address	C8-9E-43-10-CA-DF
Wireless MAC Address for 2.4 GHz	C8-9E-43-10-CA-C0
Wireless MAC Address for 5 GHz	C8-9E-43-10-CA-E0
Power Source	Power Adaptor
Ethernet LLDP	Enabled
LLDP Neighbour	NETGEAR7149F
Country / Region	Germany
Current Firmware Version	V10.1.0.19
Backup Firmware Version	V10.11.0.116
Bootloader Version	U-Boot 2016.01-V10.1.0.15
Serial Number	6V31215CF0009
Current Time	Mon Feb 7 15:46:00 PST 2022
Uptime	04 Days 04 Hrs 50 Mins

AP Interface Status

LAN

2.4GHz

5GHz

IPv4 Settings

IPv4 Address	192.168.100.182
Subnet Mask	255.255.255.0
Default Gateway	192.168.100.1
DHCP Client	Enabled

Wireless Settings

Parameters	2.4 GHz	5 GHz
Antenna	2x2	2x2
Wireless Mode	11ax	11ax
Channel / Frequency	Auto (6)/2.437 GHz	Auto (36)/5.18 GHz

The page shows four sections:

- **System Information section:** The following settings are displayed:
 - **System Name:** The access point NetBIOS name.
 - **System Mode:** The access point system mode (AP).
 - **LAN MAC Address:** The MAC address of the LAN Ethernet port of the access point.
 - **Wireless MAC Address for 2.4 GHz:** The MAC address of 2.4 GHz WiFi interface (radio) of the access point.
 - **Wireless MAC Address for 5 GHz:** The MAC address of 5 GHz WiFi interface (radio) of the access point.
 - **Power Source:** The type of power source (PoE 802.3at or Power Adapter).

- **Ethernet LLDP:** The status of Ethernet LLDP feature (Enabled or Disabled).
- **Country / Region:** The country or region in which the access point operates or for which the access point is licensed.
- **Current Firmware Version:** The version of the firmware that is running on the access point.
- **Backup Firmware Version:** The version of the backup firmware on the access point.
- **Bootloader Version:** The primary bootloader (U-Boot) version that is installed on the access point.
- **Serial Number:** The serial number of the access point.
- **Current Time:** The current system time of the access point.
- **Uptime:** The time since the access point was last restarted.

- **AP Interface Status:** A green icon indicates that the interface is in use. A gray icon indicates that the interface is not in use.
- **IPv4 Settings section:** The following settings are displayed:
 - **IPv4 Address:** The IPv4 address of the access point.
 - **Subnet Mask:** The subnet mask of the access point.
 - **Default Gateway:** The default gateway for the access point.
 - **DHCP Client:** The status of DHCP client (Enabled or Disabled).

- **Wireless Settings section:** The following settings are displayed, with separate columns for the 2.4 GHz and 5 GHz radios:
 - **Antenna:** The type of antenna (by default, 2x2).
 - **Wireless Mode:** The operating WiFi mode of the radio.
 - **Channel / Frequency:** The channel and frequency that are used by the radio.

Display the WiFi radio settings

To display the WiFi radio settings of the access point:

1. Launch a web browser from a computer that is connected to the same network as the access point or directly to the access point through an Ethernet cable or WiFi connection.
 2. Enter the IP address that is assigned to the access point.
-

A login window displays.

If your browser displays a security warning, you can proceed, or add an exception for the security warning. For more information, see [What to do if you get a browser security warning](#) on page 42.

3. Enter the access point user name and password.

The user name is **admin**. The password is the one that you specified. The user name and password are case-sensitive.

If you previously added the access point to a NETGEAR Insight network location and managed the access point through the Insight Cloud Portal or Insight app, enter the Insight network password for that location. For more information, see [Connect over WiFi using the NETGEAR Insight app](#) on page 24.

The Dashboard page displays.

4. Locate the Radio Information pane at the top, right corner of the Dashboard page (if the page width on your device is sufficient; otherwise, it might be elsewhere).

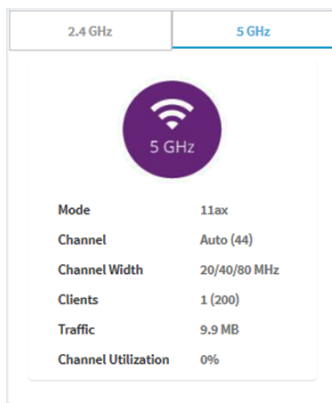

The following settings are displayed:

- Radio status (If the 2.4 GHz or 5 GHz icon is displayed as gray, the radio is turned off.)
- Mode
- Channel
- Channel width
- Number of connected clients and maximum number of supported clients
- WiFi traffic volume
- Channel utilization

5. To view information about the other radio, click either the **2.4 GHz** or **5 GHz** tab. The pane adjusts.

6. To view more detailed information, select **Management > Monitoring > System**.

System Information

System Name	WAX618-10CADF
System Mode	AP
LAN MAC Address	C8-9E-43-10-CA-DF
Wireless MAC Address for 2.4 GHz	C8-9E-43-10-CA-C0
Wireless MAC Address for 5 GHz	C8-9E-43-10-CA-E0
Power Source	Power Adaptor
Ethernet LLDP	Enabled
LLDP Neighbour	NETGEARA7149F
Country / Region	Germany
Current Firmware Version	V10.1.0.19
Backup Firmware Version	V10.11.0.116
Bootloader Version	U-Boot 2016.01-v10.1.0.15
Serial Number	6V31215CF0009
Current Time	Mon Feb 7 15:46:00 PST 2022
Uptime	04 Days 04 Hrs 50 Mins

AP Interface Status

LAN

2.4GHz

5GHz

IPv4 Settings

IPv4 Address	192.168.100.182
Subnet Mask	255.255.255.0
Default Gateway	192.168.100.1
DHCP Client	Enabled

Wireless Settings

Parameters	2.4 GHz	5 GHz
Antenna	2x2	2x2
Wireless Mode	11ax	11ax
Channel / Frequency	Auto (6)/2.437 GHz	Auto (36)/5.18 GHz

The page shows four sections:

- **System Information section:** The following settings are displayed:
 - **System Name:** The access point NetBIOS name.
 - **System Mode:** The access point system mode (AP).
 - **LAN MAC Address:** The MAC address of the LAN Ethernet port of the access point.
 - **Wireless MAC Address for 2.4 GHz:** The MAC address of 2.4 GHz WiFi interface (radio) of the access point.
 - **Wireless MAC Address for 5 GHz:** The MAC address of 5 GHz WiFi interface (radio) of the access point.
 - **Power Source:** The type of power source (PoE 802.3at or Power Adapter).
 - **Ethernet LLDP:** The status of Ethernet LLDP feature (Enabled or Disabled).
 - **Country / Region:** The country or region in which the access point operates or for which the access point is licensed.
 - **Current Firmware Version:** The version of the firmware that is running on the access point.
 - **Backup Firmware Version:** The version of the backup firmware on the access point.
 - **Bootloader Version:** The primary bootloader (U-Boot) version that is installed on the access point.

- **Serial Number:** The serial number of the access point.
- **Current Time:** The current system time of the access point.
- **Uptime:** The time since the access point was last restarted.
- **AP Interface Status:** A green icon indicates that the interface is in use. A gray icon indicates that the interface is not in use.
- **IPv4 Settings section:** The following settings are displayed:
 - **IPv4 Address:** The IPv4 address of the access point.
 - **Subnet Mask:** The subnet mask of the access point.
 - **Default Gateway:** The default gateway for the access point.
 - **DHCP Client:** The status of DHCP client (Enabled or Disabled).
- **Wireless Settings section:** The following settings are displayed, with separate columns for the 2.4 GHz and 5 GHz radios:
 - **Antenna:** The type of antenna (by default, 2x2).
 - **Wireless Mode:** The operating WiFi mode of the radio.
 - **Channel / Frequency:** The channel and frequency that are used by the radio.

Display unknown and known neighbor access points

If you enabled neighbor access point (AP) detection (see [Manage neighbor AP detection](#) on page 123), you can display the unknown access points in the Unknown AP list and the known access points in the Known AP list.

To display the detected neighbor access points:

1. Launch a web browser from a computer that is connected to the same network as the access point or directly to the access point through an Ethernet cable or WiFi connection.
2. Enter the IP address that is assigned to the access point.
A login window displays.

If your browser displays a security warning, you can proceed, or add an exception for the security warning. For more information, see [What to do if you get a browser security warning](#) on page 42.

- Enter the access point user name and password.

The user name is **admin**. The password is the one that you specified. The user name and password are case-sensitive.

If you previously added the access point to a NETGEAR Insight network location and managed the access point through the Insight Cloud Portal or Insight app, enter the Insight network password for that location. For more information, see [Connect over WiFi using the NETGEAR Insight app](#) on page 24.

The Dashboard page displays.

- Select **Management > Monitoring > Neighbor AP**.

Unknown AP Known AP

2.4 GHz : 3 5 GHz : 2

Show 10 Entries Search:

MAC Address	SSID	Radio	Channel	RSSI	Timestamp
08-00-00-00-00-00	Netgear3A21CF	5 GHz	161	94	Fri Aug 4 17:30:05 PDT
60-00-00-00-00-00	SimplePresenceNetwork 5GHz	5 GHz	44	53	Fri Aug 4 17:30:05 PDT
B0-00-00-00-00-00	RMCS-Farms	2.4 GHz	5	2	Fri Aug 4 17:09:53 PDT
FA-00-00-00-00-00		2.4 GHz	1	79	Fri Aug 4 17:34:57 PDT
FA-00-00-00-00-00		2.4 GHz	1	87	Fri Aug 4 17:34:57 PDT

Previous 1 Next

Refresh

At the top of the page, for each radio band, the page displays the total number of unknown access points.

For information about moving unknown access points to the Known AP list, see [Enable neighbor access point detection and move access points to the Known AP List](#) on page 124.

- To display the most recent unknown access points, click the **Refresh** button.
- To view the Known AP list, click the **Known AP** tab.

Unknown AP Known AP

2.4 GHz : 2 5 GHz : 0

Show 10 Entries Search:

MAC Address	SSID	Radio	Channel	RSSI	Timestamp
08-00-00-00-00-00	Netgear3A21CF	2.4 GHz	5	94	Fri Aug 4 17:34:57 PDT
60-33-00-00-00-00	SimplePresenceNetwork	2.4 GHz	1	90	Fri Aug 4 17:34:57 PDT

Previous 1 Next

Refresh

At the top of the page, for each radio band, the page displays the total number of known access points.

7. To display the most recent known access points, click the **Refresh** button.

Display client distribution, connected clients, and client trends

To display the clients that are connected to the access point over WiFi:

1. Launch a web browser from a computer that is connected to the same network as the access point or directly to the access point through an Ethernet cable or WiFi connection.

2. Enter the IP address that is assigned to the access point.

A login window displays.

If your browser displays a security warning, you can proceed, or add an exception for the security warning. For more information, see [What to do if you get a browser security warning](#) on page 42.

3. Enter the access point user name and password.

The user name is **admin**. The password is the one that you specified. The user name and password are case-sensitive.

If you previously added the access point to a NETGEAR Insight network location and managed the access point through the Insight Cloud Portal or Insight app, enter the Insight network password for that location. For more information, see [Connect over WiFi using the NETGEAR Insight app](#) on page 24.

The Dashboard page displays.

4. Locate the Client Distribution pane (shown on the left side in the following figure) and the Recent Clients pane (shown on the right side).

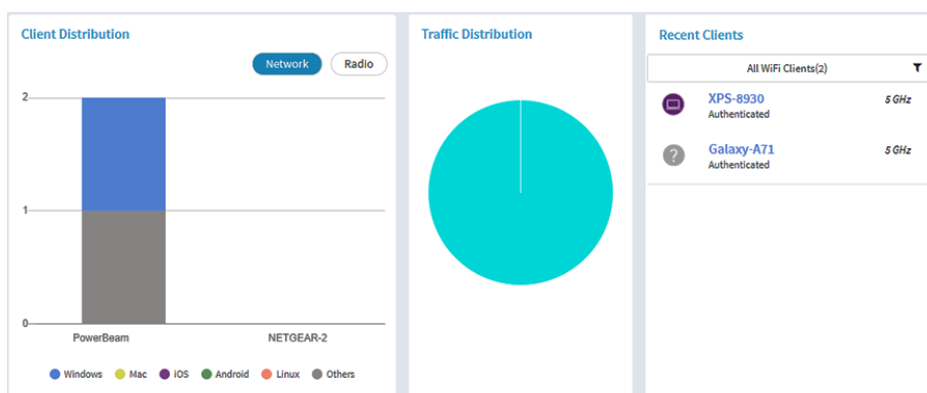

The Client Distribution pane shows the types of clients (Windows, Mac, iOS, Android, Linux, and other operating systems) and how these clients are distributed over the networks. (By default, the **Network** button is selected.)

The Recent Clients pane shows the top 5 recently connected clients list.

- To display how the clients are distributed over the radios, click the **Radio** button in the Client Distribution pane.

The page adjusts and shows the types of clients for each radio.

- To display recent clients for all networks or a single network, in the Connected Clients pane, click the icon in the menu under Recent Clients, and select **All WiFi Clients** or the clients for a specific WiFi network (SSID).

For your selection, the pane displays the total number of connected clients and the device names of the connected clients.

- To display information about a connected client, click its device name.

The page displays the MAC address, device name, IP address, and SSID for the client. You can also view more information, including very detailed information (see [Step 11](#) and [Step 12](#)).

- To display trends about clients, scroll down to the Hours Trend pane.

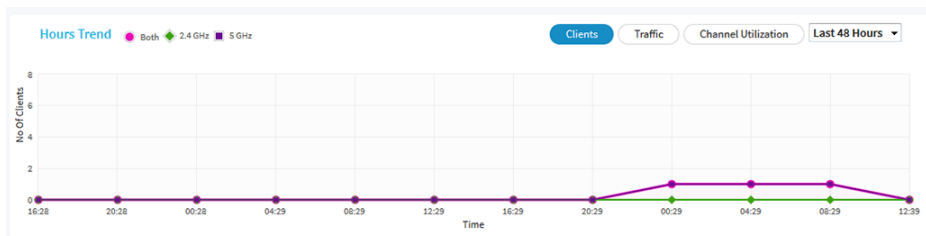

The Hours Trend pane shows a graph with the number of clients, the traffic in MBps, or the channel utilization over a period that you can select. (The previous figure shows the trend for the last 48 hours.) By default, the client information is selected (that is, the **Client** button is selected) and the graph shows the total number of clients for both radios and the number of clients for each radio (2.4 GHz and 5 GHz).

You can also click the **Traffic** button or the **Channel Utilization** button. For more information, see [View WiFi and Ethernet traffic, traffic and ARP statistics, and channel utilization](#) on page 189.

- To display more information, point to a node on one of the lines on the graph.
- To change the period over which information is filtered and displayed, select the number of recent hours from the menu to the right of the buttons.

11. To display more information about currently connected clients, select **Management > Monitoring > Connected Clients**.

Wireless Clients

2.4 GHz Clients : 0 (128)

#	SSID	MAC Address	IP Address	Host Name	OS	Mode	VLAN ID	User Name
No Available Clients								

5 GHz Clients : 2 (128)

Show 10 Entries Search:

#	SSID	MAC Address	IP Address	Host Name	OS	Mode	VLAN ID	User Name
1	AzimuthBeam	0A-38-EA-BE-BE-BE	192.168.100.175	A71	Generic Android	11AC	1	Not Applicable
2	AzimuthBeam	40-23-43-BE-BE-BE	192.168.100.162	XPS-8930	Windows OS	11AC	1	Not Applicable

Previous 1 Next

Refresh

For each radio, the page displays the number of connected clients and the maximum number of supported clients.

For each radio and each WiFi client, the page displays the SSID, MAC address, IP address, host name, operating system (OS), WiFi mode, VLAN ID, and user name or key identifier (for a Multi PSK configuration).

12. To display very detailed information about a WiFi client, click the information (I) icon to the left of the client.

The Detailed Client Information page displays and shows the following information:

- **MAC Address:** The MAC address of the client.
- **IP Address:** The IP address associated with the client.
- **Host Name:** The host name of the client.
- **OS:** The operating system that runs on the client.
- **BSSID:** The BSSID that the client connects to.
- **SSID:** The SSID of the radio that the client connects to.
- **Channel:** The channel that the client connects to.
- **Channel Width:** The width of the channel that the client connects to.
- **Tx Rate:** The rate of traffic transmission of the client.
- **Rx Rate:** The rate of traffic reception of the client.
- **RSSI:** The RSSI threshold value of the client.
- **Tx Bytes:** The number of bytes that the client transmitted.
- **Rx Bytes:** The number of bytes that the client received.
- **State:** The QoS state of the connection.
- **Type:** The type of WiFi security that is used for the connection.

- **Device Type:** The type of device that the client is.
- **Mode:** The WiFi mode of the connection.
- **Status:** The security status of the connection.
- **Idle Time:** The time that the client remained idle.
- **Assoc Time Stamp:** The time that is associated with the information on the Detailed Client Information page.
- **PMF Support:** If PMF is enabled on the access point, indicates if the client supports PMF.

13. If you opened the Detailed Client Information page, click the **Close** button.
The Detailed Client Information page closes.

14. To display the most recent information, click the **Refresh** button.

View WiFi and Ethernet traffic, traffic and ARP statistics, and channel utilization

To view WiFi and Ethernet (wired LAN) traffic, traffic and ARP statistics, and channel utilization:

1. Launch a web browser from a computer that is connected to the same network as the access point or directly to the access point through an Ethernet cable or WiFi connection.

2. Enter the IP address that is assigned to the access point.
A login window displays.

If your browser displays a security warning, you can proceed, or add an exception for the security warning. For more information, see [What to do if you get a browser security warning](#) on page 42.

3. Enter the access point user name and password.

The user name is **admin**. The password is the one that you specified. The user name and password are case-sensitive.

If you previously added the access point to a NETGEAR Insight network location and managed the access point through the Insight Cloud Portal or Insight app, enter the Insight network password for that location. For more information, see [Connect over WiFi using the NETGEAR Insight app](#) on page 24.

The Dashboard page displays.

4. Scroll down to the Hours Trend pane at the bottom of the Dashboard page. By default, the **Clients** button is selected.

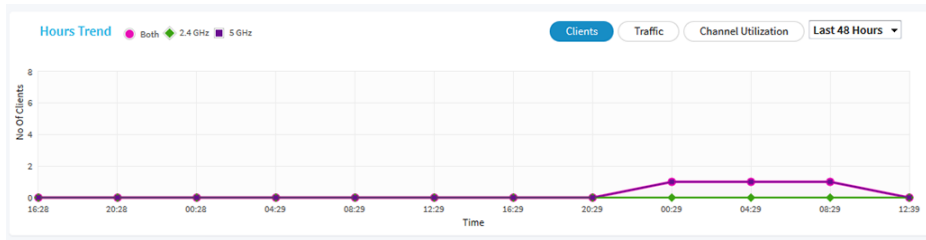

5. To view traffic information, do the following:
 - a. Click the **Traffic** button.
The graph shows the information for Ethernet (wired LAN) traffic, total WiFi traffic, WiFi traffic for the 2.4 GHz radio, and WiFi traffic for the 5 GHz radio.
 - b. To view more information, point to a node on one of the lines on the graph.
6. To view channel utilization, do the following:
 - a. Click the **Channel Utilization** button.
The graph shows the channel utilization for the 2.4 GHz radio.
 - b. To view the channel utilization for the 5 GHz radio, click the **5 GHz** button.
 - c. To view more information, point to a bar.
7. To change the period over which information is filtered and displayed, select the number of recent hours from the menu to the right of the buttons.

- To view traffic statistics, select **Management > Monitoring > Statistics**.

Wireless

Parameters	2.4 GHz		5 GHz	
	Received	Transmitted	Received	Transmitted
Unicast Packets	0	0	62477	96469
Broadcast Packets	0	0	12	694
Multicast Packets	0	0	102	7773
Total Packets	0	0	62591	104936
Total Bytes	0	0	9327887	133718139
Number of Clients	0		1	

ARP Statistics

ARP Packets Received	Proxied ARP's	ARP Packets Dropped
1378	13	1378

Ethernet

Parameter	Received	Transmitted
Total Packets	112677	70349
Total Bytes	132191664	12617424

[Refresh](#)

The page displays the network traffic statistics for both the WiFi and Ethernet interfaces of the access point since the access point started or rebooted. The page also displays the number of clients that are associated with each radio.

If the ARP proxy is enabled (see [Manage the ARP proxy](#) on page 229), the page also displays the ARP statistics, including the number of proxied and dropped packets.

- To display the most recent information, click the **Refresh** button.

View or download tracked URLs

If you enabled URL tracking for a WiFi network (see [Enable or disable URL tracking for a WiFi network](#) on page 202), you can view the tracked URLs by URL, WiFi client, and SSID. You can also download a URL tracking report as a `.csv` file.

To view or download tracked URLs:

- Launch a web browser from a computer that is connected to the same network as the access point or directly to the access point through an Ethernet cable or WiFi connection.
- Enter the IP address that is assigned to the access point.

A login window displays.

If your browser displays a security warning, you can proceed, or add an exception for the security warning. For more information, see [What to do if you get a browser security warning](#) on page 42.

3. Enter the access point user name and password.

The user name is **admin**. The password is the one that you specified. The user name and password are case-sensitive.

If you previously added the access point to a NETGEAR Insight network location and managed the access point through the Insight Cloud Portal or Insight app, enter the Insight network password for that location. For more information, see [Connect over WiFi using the NETGEAR Insight app](#) on page 24.

The Dashboard page displays.

4. Select **Management > Monitoring > URL Tracking**.

List by URL ▼

URL	Clients ▲	SSIDs	Hit-Count
api.twitter.com	C1-BD-D1-B0-F0-F1...	TitaniumBeam...	2
userlocation.googleapis.co	C1-BD-D1-B0-F0-F1...	TitaniumBeam...	1
graph.facebook.com	C1-BD-D1-B0-F0-F1...	TitaniumBeam...	2
edge-mqtt.facebook.com	C1-BD-D1-B0-F0-F1...	TitaniumBeam...	1
m.barclaycardus.com	C1-BD-D1-B0-F0-F1...	TitaniumBeam...	1
decide.mixpanel.com	C1-BD-D1-B0-F0-F1...	TitaniumBeam...	2
api.mixpanel.com	C1-BD-D1-B0-F0-F1...	TitaniumBeam...	2
app.alivecor.com	C1-BD-D1-B0-F0-F1...	TitaniumBeam...	2
youtubei.googleapis.com	C1-BD-D1-B0-F0-F1...	TitaniumBeam...	4
googleads.g.doubleclick.ne	C1-BD-D1-B0-F0-F1...	TitaniumBeam...	2

Previous 1 2 3 Next [View All](#)

Clear
Download

By default, the table shows the URLs that were accessed, each with the MAC address of the WiFi client that accessed the URL, the associated SSID, and the number of times that the WiFi client accessed the URL.

5. To view additional information, click the **...** link to the right of a MAC address or SSID.

6. To view URL tracking information by WiFi client, do the following:
 - a. From the **List by** menu, select **Client**.
The table shows the MAC addresses of the WiFi clients, each with the client host name, and the first URL of the list of URLs that the client accessed.
 - b. To view all URLs that a WiFi client accessed, click the **...** link to the right of the first URL.
A pop-up window displays all URLs that the WiFi client accessed.
 - c. Click the **Close** button.
The pop-up window closes.
7. To view URL tracking information by SSID, do the following:
 - a. From the **List by** menu, select **SSID**.
The table shows the SSIDs and the first URL of the list of URLs that were accessed on the SSID.
 - b. To view all URLs that were accessed on the SSID, click the **...** link to the right of the first URL.
A pop-up window displays all URLs that the were accessed on the SSID.
 - c. Click the **Close** button.
The pop-up window closes.
8. To download a URL tracking report as a .csv file, click the **Download** button, and follow the directions of your browser.
9. To clear all URL tracking information, do the following:
 - a. Click the **Clear** button.
A warning pop-up window displays.
 - b. Click the **OK** button.
The pop-up window closes and the information is cleared.

View, save, download, or clear the logs

You can view and manage the activity logs of the access point. You can also download a detailed log file.

Note: If the access point functions in the NETGEAR Insight management mode, you can also view and manage the cloud activity logs, which show the connection of the access point to the Insight cloud-based management platform. If the access point functions in the NETGEAR Insight management mode, this is option is available from the Dashboard page by selecting **Management > Monitoring > Cloud Logs**.

To view, save, download, or clear the logs:

1. Launch a web browser from a computer that is connected to the same network as the access point or directly to the access point through an Ethernet cable or WiFi connection.

2. Enter the IP address that is assigned to the access point.

A login window displays.

If your browser displays a security warning, you can proceed, or add an exception for the security warning. For more information, see [What to do if you get a browser security warning](#) on page 42.

3. Enter the access point user name and password.

The user name is **admin**. The password is the one that you specified. The user name and password are case-sensitive.

If you previously added the access point to a NETGEAR Insight network location and managed the access point through the Insight Cloud Portal or Insight app, enter the Insight network password for that location. For more information, see [Connect over WiFi using the NETGEAR Insight app](#) on page 24.

The Dashboard page displays.

4. Select **Management > Monitoring > Logs**.

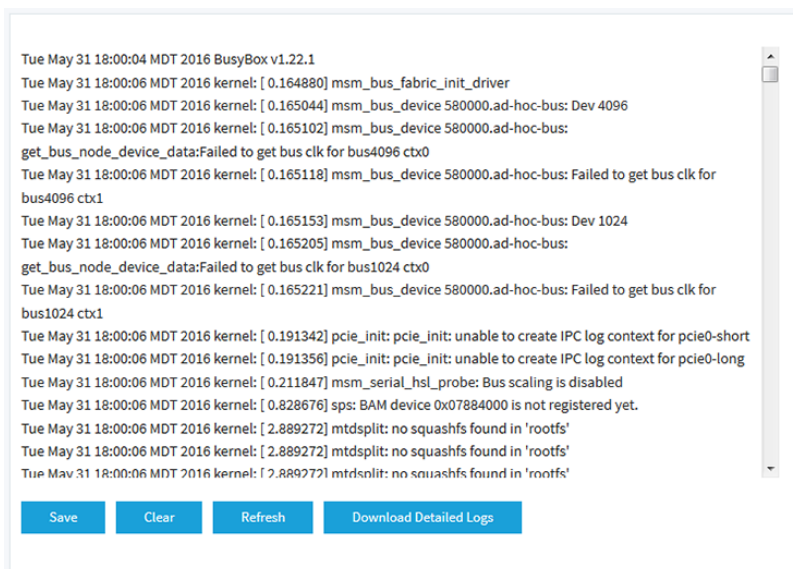

5. To save the logs, do the following:

- a. Click the **Save** button.
- b. Follow the directions of your browser to save the file to your computer.

6. To download the detailed log entries, do the following:
 - a. Click the **Download Detailed Logs** button.
Depending on the size of the file, downloading the detailed log entries might take several minutes.
 - b. Follow the directions of your browser to save the file to your computer.
7. To refresh the log entries onscreen, click the **Refresh** button.

WARNING: After you clear the log entries, you can no longer save or download them.

8. To clear the log entries, click the **Clear** button.

View a WiFi bridge connection

You can configure a wireless distribution system (WDS) that consists of point-to-point WiFi bridge connections between two access points (see [Set up a WiFi Bridge](#) on page 213). This is different from a NETGEAR Insight Instant Mesh WiFi network.

You can view whether a WiFi bridge is established and view the function (base station or repeater), MAC addresses, and IP addresses of the access points that form the WiFi bridge.

To view a WiFi bridge connection:

1. Launch a web browser from a computer that is connected to the same network as the access point or directly to the access point through an Ethernet cable or WiFi connection.

2. Enter the IP address that is assigned to the access point.

A login window displays.

If your browser displays a security warning, you can proceed, or add an exception for the security warning. For more information, see [What to do if you get a browser security warning](#) on page 42.

3. Enter the access point user name and password.

The user name is **admin**. The password is the one that you specified. The user name and password are case-sensitive.

If you previously added the access point to a NETGEAR Insight network location and managed the access point through the Insight Cloud Portal or Insight app, enter the Insight network password for that location. For more information, see [Connect over WiFi using the NETGEAR Insight app](#) on page 24.

The Dashboard page displays.

4. Select **Management > Monitoring > Wireless Bridge**.

The page that displays lets you select a WDS profile (WDS 1, WDS 2, WDS 3, or WDS 4).

5. Click the ► button to the left of a WDS profile.

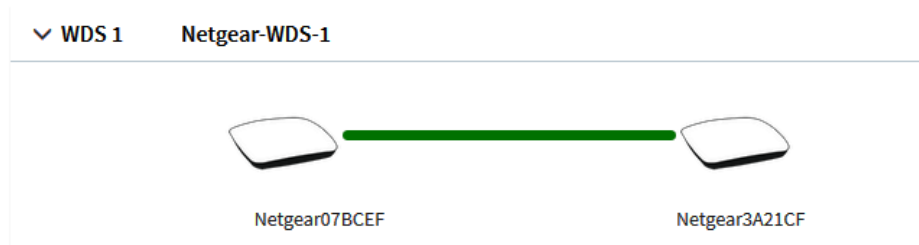

6. To view the function, MAC address, and IP address of an access point, point your cursor to the access point.

View alarms and notifications

You can view the alarms and notifications from any access point page. The following procedure describes how you can view them from the Dashboard page.

To view the alarms and notifications:

1. Launch a web browser from a computer that is connected to the same network as the access point or directly to the access point through an Ethernet cable or WiFi connection.

2. Enter the IP address that is assigned to the access point.

A login window displays.

If your browser displays a security warning, you can proceed, or add an exception for the security warning. For more information, see [What to do if you get a browser security warning](#) on page 42.

3. Enter the access point user name and password.

The user name is **admin**. The password is the one that you specified. The user name and password are case-sensitive.

If you previously added the access point to a NETGEAR Insight network location and managed the access point through the Insight Cloud Portal or Insight app, enter the Insight network password for that location. For more information, see [Connect over WiFi using the NETGEAR Insight app](#) on page 24.

The Dashboard page displays.

4. Locate the alarm bell icon at the top-right of the page.
The icon shows a number, indicating the total number of new alarms and notifications since the last time that you viewed alarms and notifications.
5. Click the alarm bell icon.

Reboot Reason: Country Changed	
2:48 pm Jun 3th, Wednesday 2020	
Radio 5GHz On	
2:48 pm Jun 3th, Wednesday 2020	
Radio 2.4GHz On	
2:48 pm Jun 3th, Wednesday 2020	
System UP	
2:48 pm Jun 3th, Wednesday 2020	

The pop-up window shows the alarms (indicated by a red bell) and notifications (indicated by a blue bell) with a description and time.

6. To view more alarms and notification, scroll down in the pop-up window.

12

Manage the Advanced WiFi Features for a WiFi network

This chapter describes how you can manage the advanced WiFi features for a WiFi network.

For information about the basic WiFi features for a WiFi network, see [Manage the Basic WiFi Features for a WiFi network](#) on page 57.

The chapter includes the following sections:

- [Set NAT mode or Bridge mode for addressing and traffic](#)
- [Enable or disable client isolation for a WiFi network](#)
- [Enable or disable URL tracking for a WiFi network](#)
- [Change the format of the DHCP offer messages in a WiFi network](#)
- [Select a MAC ACL for a WiFi network](#)
- [Set bandwidth rate limits for a WiFi network](#)
- [Configure advanced rate selection for a WiFi network](#)

Note: If you want to change the settings of a WiFi network on the access point, use a wired connection to avoid being disconnected when the new WiFi settings take effect.

Note: In this manual, *WiFi network* means the same as SSID (service set identifier or WiFi network name) or VAP (virtual access point). That is, when we refer to a WiFi network we mean an individual SSID or VAP.

Set NAT mode or Bridge mode for addressing and traffic

By default, the addressing and traffic mode of the access point is Bridge mode, which means that WiFi clients receive IP addresses from a DHCP server (or a router that functions as a DHCP server) in your network. This is usually the same DHCP server that assigns an IP address to the access point itself.

You can also set NAT mode, which enables the access point's DHCP server for WiFi clients. The access point's DHCP server assigns an IP address in a different range from the IP address of the access point itself.

NAT mode and the following features are mutually exclusive:

- Multi PSK (see [Set up Multi PSK for a WiFi network](#) on page 76)
- Management VLAN (see [Set the 802.1Q VLAN and management VLAN](#) on page 137)
- mDNS gateway (see [Manage the multicast DNS gateway](#) on page 145)

To set NAT mode or Bridge mode for addressing and traffic:

1. Launch a web browser from a computer that is connected to the same network as the access point or directly to the access point through an Ethernet cable or WiFi connection.

2. Enter the IP address that is assigned to the access point.

A login window displays.

If your browser displays a security warning, you can proceed, or add an exception for the security warning. For more information, see [What to do if you get a browser security warning](#) on page 42.

3. Enter the access point user name and password.

The user name is **admin**. The password is the one that you specified. The user name and password are case-sensitive.

If you previously added the access point to a NETGEAR Insight network location and managed the access point through the Insight Cloud Portal or Insight app, enter the Insight network password for that location. For more information, see [Connect over WiFi using the NETGEAR Insight app](#) on page 24.

The Dashboard page displays.

4. Select **Management > Configuration > Wireless > Basic**.

The page that displays lets you select an SSID.

5. Click the ► button to the left of the SSID.

The settings for the selected SSID display.

6. Scroll down and click the **> Advanced** tab.

The page expands.

7. From the **Addressing and Traffic** menu, select the addressing and traffic mode:

- **Bridge:** The WiFi clients receive their IP addresses from the DHCP server in the same network as the access point. This is the default mode.
- **NAT:** WiFi clients receive their IP addresses from a private DHCP address pool on the access point. If you select this mode, by default, the WLAN network address is 172.31.0.0. This means that WiFi clients are assigned an IP address in the range from 172.31.0.2 to 172.31.3.254. The IP address of the default DNS server for the WLAN is 8.8.8.8. To change the default range for the DHCP address pool, the default DNS server, or both, do the following:
 - a. In the **Network Address** field, enter a network address that is different from the network address for the access point. For example, if the access point's IP address is in the range from 192.168.0.1 to 192.168.0.254 (a common IP address range), enter a network address that is different from 192.168.0.0.
 - b. In the **DNS** field, enter the IP address for the DNS server that you want to use. This IP address must be different from the WLAN network address that you set in the previous step.

8. Click the **Apply** button.

Your settings are saved.

Enable or disable client isolation for a WiFi network

By default, client isolation is disabled for a WiFi network (SSID or VAP), allowing communication between WiFi clients that are associated with the same or different WiFi networks on the access point. For additional security, you can enable client isolation so that clients that are associated with the same or different WiFi networks *cannot* communicate with each other, except for communication over the Internet, which remains possible.

Client isolation is not compatible with Multi PSK. To enable client isolation, first disable Multi PSK (see [Set up Multi PSK for a WiFi network](#) on page 76).

To enable or disable client isolation for a WiFi network:

1. Launch a web browser from a computer that is connected to the same network as the access point or directly to the access point through an Ethernet cable or WiFi connection.

2. Enter the IP address that is assigned to the access point.

A login window displays.

If your browser displays a security warning, you can proceed, or add an exception for the security warning. For more information, see [What to do if you get a browser security warning](#) on page 42.

3. Enter the access point user name and password.

The user name is **admin**. The password is the one that you specified. The user name and password are case-sensitive.

If you previously added the access point to a NETGEAR Insight network location and managed the access point through the Insight Cloud Portal or Insight app, enter the Insight network password for that location. For more information, see [Connect over WiFi using the NETGEAR Insight app](#) on page 24.

The Dashboard page displays.

4. Select **Management > Configuration > Wireless > Basic**.

The page that displays lets you select an SSID.

5. Click the ► button to the left of the SSID.

The settings for the selected SSID display.

6. Scroll down and click the ► **Advanced** tab.

The page expands.

7. Under Wireless Client Isolation, select one of the following radio buttons:

- **Disable:** Client isolation is disabled for the WiFi network. This is the default setting.
- **Enable:** Client isolation is enabled for the WiFi network. The following check boxes display:

If you select the **Enable** radio button, two check boxes display (see the following steps).

8. If the **Allow Access to AP UI** check box displays: To prevent an admin user from accessing the local browser UI over the WiFi network, clear the **Allow Access to AP UI** check box.

By default, this check box is selected, allowing an admin user to access the local browser UI over the WiFi network.

Note: If the management VLAN and WiFi network VLAN are identical (which they are by default), an admin user can always access the local browser UI over a wired network connection, even if you disable access over the WiFi network.

9. If the **Allow access to devices listed below** check box displays: To add network devices that are exempt from isolation so that clients are allowed to reach them, do the following:
 - a. Select the **Allow access to devices listed below** check box.
By default, the check box is cleared.
The Allowlist displays.
 - b. In the field to the right, enter up to five static IP addresses and domain names of devices that clients are allowed to reach over the WiFi network.
For example, you could enter the static IP address or domain name of a network printer that you want to make available to WiFi clients. A domain name on the Allowlist must resolve to a static IP address.
 - c. Click the **Move** button.
The addresses and domain names are added to the Allowlist.
 - d. To remove one, several, or all addresses and domain names, select individual check boxes or the **Select All** check box, and click the **Remove** button.
10. Click the **Apply** button.
Your settings are saved.

Enable or disable URL tracking for a WiFi network

You can enable the access point to track all URLs that are requested by WiFi clients that are connected to a WiFi network (SSID or VAP). This feature is disabled by default, but you can enable it.

For information about how to view the tracked URLs per SSID or per WiFi client, see [View or download tracked URLs](#) on page 191.

To enable or disable URL tracking for a WiFi network:

1. Launch a web browser from a computer that is connected to the same network as the access point or directly to the access point through an Ethernet cable or WiFi connection.

2. Enter the IP address that is assigned to the access point.

A login window displays.

If your browser displays a security warning, you can proceed, or add an exception for the security warning. For more information, see [What to do if you get a browser security warning](#) on page 42.

3. Enter the access point user name and password.

The user name is **admin**. The password is the one that you specified. The user name and password are case-sensitive.

If you previously added the access point to a NETGEAR Insight network location and managed the access point through the Insight Cloud Portal or Insight app, enter the Insight network password for that location. For more information, see [Connect over WiFi using the NETGEAR Insight app](#) on page 24.

The Dashboard page displays.

4. Select **Management > Configuration > Wireless > Basic**.

The page that displays lets you select an SSID.

5. Click the ► button to the left of the SSID.

The settings for the selected SSID display.

6. Scroll down and click the ► **Advanced** tab.

The page expands.

7. Under URL Tracking, select one of the following radio buttons:

- **Enable:** URL Tracking is enabled for the WiFi network.
- **Disable:** URL Tracking is disabled for the WiFi network.

8. Click the **Apply** button.

Your settings are saved.

Change the format of the DHCP offer messages in a WiFi network

When a device tries to associate with the WiFi network and negotiates an IP address, the access point converts the broadcast DHCP offer message that it receives from the DHCP server to a unicast message, and forwards it to the device. This is the default configuration. For the DHCP message exchange, unicast packets are more reliable and minimize the traffic in the network.

If your situation requires that DHCP offer messages must be distributed as broadcast packets in a specific WiFi network, you can change the message format for that WiFi network so that the access point does *not* convert the broadcast DHCP offer messages to unicast messages.

To change the format of the DHCP offer messages in a WiFi network:

1. Launch a web browser from a computer that is connected to the same network as the access point or directly to the access point through an Ethernet cable or WiFi connection.

2. Enter the IP address that is assigned to the access point.

A login window displays.

If your browser displays a security warning, you can proceed, or add an exception for the security warning. For more information, see [What to do if you get a browser security warning](#) on page 42.

3. Enter the access point user name and password.

The user name is **admin**. The password is the one that you specified. The user name and password are case-sensitive.

If you previously added the access point to a NETGEAR Insight network location and managed the access point through the Insight Cloud Portal or Insight app, enter the Insight network password for that location. For more information, see [Connect over WiFi using the NETGEAR Insight app](#) on page 24.

The Dashboard page displays.

4. Select **Management > Configuration > Wireless > Basic**.

The page that displays lets you select an SSID.

5. Click the > button to the left of the SSID.

The settings for the selected SSID display.

6. Scroll down and click the > **Advanced** tab.

The page expands.

7. Under DHCP Offer Broadcast to Unicast, select one of the following radio buttons:
 - **Enable.** The access point forwards DHCP offer messages as unicast packets in the WiFi network. This is the default selection.
 - **Disable.** The access point forwards DHCP offer messages as broadcast packets in the WiFi network.
8. Click the **Apply** button.
Your settings are saved

Select a MAC ACL for a WiFi network

After you set up one or more local MAC access control lists (ACLs, also referred to as access lists; see [Manage local MAC access control lists](#) on page 116), you can select an ACL for use with an SSID.

Depending on the policy that you defined for an ACL, WiFi devices for which the MAC address is on the MAC ACL are either allowed access to the access point through this SSID or denied access to the SSID. If denied access to the SSID, these devices might be able to connect to the access point through another SSID if you did not set up MAC ACL security for that SSID.

You can also set up a RADIUS server (see [Set up RADIUS servers](#) on page 129) and select the RADIUS MAC ACL. You must define the ACL on the RADIUS server, using the following format for client MAC addresses in the RADIUS server: If the client MAC address is 00:0a:95:9d:68:16, specify it as 000a959d6816 in the RADIUS server.

Note: A RADIUS MAC ACL cannot function if the WiFi security is WPA2 Enterprise or WPA3 Enterprise. If you want to use a RADIUS MAC ACL, select a different type of WiFi security for the WiFi network (see [Change the authentication and encryption for a WiFi network](#) on page 71).

Before you select a MAC ACL for a WiFi network, review the policy of the ACL:

- **ACL policy that allows access:** A WiFi device on the ACL is allowed access to the SSID while all other WiFi devices are denied access to the SSID.
- **ACL policy that denies access:** A WiFi device on the ACL is denied access to the SSID while all other WiFi devices are allowed access to the SSID.

To select a MAC ACL for a WiFi network:

1. Launch a web browser from a computer that is connected to the same network as the access point or directly to the access point through an Ethernet cable or WiFi connection.
2. Enter the IP address that is assigned to the access point.
A login window displays.
If your browser displays a security warning, you can proceed, or add an exception for the security warning. For more information, see [What to do if you get a browser security warning](#) on page 42.
3. Enter the access point user name and password.
The user name is **admin**. The password is the one that you specified. The user name and password are case-sensitive.
If you previously added the access point to a NETGEAR Insight network location and managed the access point through the Insight Cloud Portal or Insight app, enter the Insight network password for that location. For more information, see [Connect over WiFi using the NETGEAR Insight app](#) on page 24.
The Dashboard page displays.
4. Select **Management > Configuration > Wireless > Basic**.
The page that displays lets you select an SSID.
5. Click the ► button to the left of the SSID.
The settings for the selected SSID display.
6. Scroll down and click the ► **Advanced** tab.
The page expands.
7. Select the **MAC ACL** check box.
8. Do one of the following:
 - Select the **Local MAC ACL** radio button, and from the **Select Group** menu, select the MAC ACL that you defined earlier.
To change the MAC ACL policy, MAC addresses in the ACL, or both, click the link next to the group. For more information, see [Manage local MAC access control lists](#) on page 116.
 - Select the **Radius MAC ACL** radio button.
This option functions only if you set up a RADIUS server (see [Set up RADIUS servers](#) on page 129).
9. Click the **Apply** button.

Your settings are saved.

Set bandwidth rate limits for a WiFi network

You can set rate limits for the upload and download bandwidths for devices that are connected to a WiFi network. The minimum bandwidth rate is 64 Kbps, the maximum bandwidth rate is 1024 Mbps. You can set one rate for the upload bandwidth and another rate for the download bandwidth.

Note: You can set bandwidth rate limits for a maximum of two WiFi networks on the access point.

To set bandwidth rate limits for devices that are connected to a WiFi network:

1. Launch a web browser from a computer that is connected to the same network as the access point or directly to the access point through an Ethernet cable or WiFi connection.

2. Enter the IP address that is assigned to the access point.

A login window displays.

If your browser displays a security warning, you can proceed, or add an exception for the security warning. For more information, see [What to do if you get a browser security warning](#) on page 42.

3. Enter the access point user name and password.

The user name is **admin**. The password is the one that you specified. The user name and password are case-sensitive.

If you previously added the access point to a NETGEAR Insight network location and managed the access point through the Insight Cloud Portal or Insight app, enter the Insight network password for that location. For more information, see [Connect over WiFi using the NETGEAR Insight app](#) on page 24.

The Dashboard page displays.

4. Select **Management > Configuration > Wireless > Basic**.

The page that displays lets you select an SSID.

5. Click the ► button to the left of the SSID.

The settings for the selected SSID display.

6. Scroll down and click the ► **Advanced** tab.

The page expands.

7. Select the **Rate Limit** check box.
8. Specify the values:
 - **Upload:** For the upload bandwidth limitation, enter a value from 64 to 1024 and select **Kbps** or **Mbps** from the menu.
 - **Download:** For the download bandwidth limitation, enter a value from 64 to 1024 and select **Kbps** or **Mbps** from the menu.
9. Click the **Apply** button.
Your settings are saved.

Configure advanced rate selection for a WiFi network

Advanced rate selection lets you improve the capacity of an *individual* WiFi network (as opposed to a radio, which affects *all* WiFi network on the radio) so that you can reach the optimal balance between the following components in the WiFi network:

- Types of traffic (multicast, management, control, and data traffic)
- Number and proximity of clients (the client density)
- Types of clients (the WiFi modes that clients can support, including legacy WiFi modes)
- Throughput speed for clients
- Area that the WiFi network must cover

To successfully configure advanced rate selection, we recommend that you determine what the clients in your network can require (the types of traffic, the supported WiFi modes, and the expected throughput speed), how many clients potentially can connect simultaneously to the WiFi network, and where the clients can be located.

Note: By default, advanced rate selection is disabled. If you enable advanced rate selection, the access point applies rate control settings to WiFi connections in a regular WiFi network but not to connections in a wireless distribution system (WDS) or Insight Instant Mesh WiFi network.

Advanced rate selection lets you configure the following settings for the 2.4 GHz and 5 GHz radio bands in a WiFi network:

- **Fixed multicast rate:** The multicast traffic transmission rate that you select is automatically applied. The rates that you can select are the basic multicast rates that the radio band supports.
- **Rate control:** The rate that you select is automatically applied to beacon and other management frames and to control and data frames. If you enable rate control, you can set the density level, which consists of four components that are described below. That is, the density level includes much more than the client density (the number and proximity of clients in the WiFi network).
The available settings for the density level in the WiFi network depend on the WiFi mode in which the radio operates. (For more information about WiFi modes, see [Change the WiFi mode for a radio](#) on page 88.)
You can set a density level of 0 (actually spanning 0-4, the default setting), 1 (spanning 1-4), 2 (spanning 2-4), 3 (spanning 3-4), or 4. The setting is then applied to the following *interdependent* components, which you cannot set individually precisely because they are interdependent:
 - **Density:** The density (the number and proximity) of clients in the WiFi network. (The density is one of the four components of the density *level*.) A setting of 0 means a very low client density. A setting of 4 means a very high client density.
 - **Compatibility:** The compatibility with WiFi modes for legacy clients in the WiFi network. A setting of 0 means compatibility with 802.11b/g/n/ax clients. A setting of 4 means compatibility with 802.11g/n/ax clients but not with 802.11b legacy clients.
 - **Overall performance:** The throughput speed for the clients in the WiFi network. A setting of 0 means a reduced performance. A setting of 4 means an optimal performance. As an example, you can deliberately select a reduced performance if you require a very wide coverage area.
 - **Coverage:** The area that the WiFi network must cover. A setting of 0 means a very wide coverage area. A setting of 4 means a very narrow coverage area. As an example, you can deliberately select a very narrow area if you require an optimal performance.

Another way to describe the density level is that a selected level is mapped to a corresponding client density level, WiFi mode, minimum legacy rate, beacon rate, and minimum Modulation Coding Scheme (MCS) rate.

To configure advanced rate selection for a WiFi network:

1. Launch a web browser from a computer that is connected to the same network as the access point or directly to the access point through an Ethernet cable or WiFi connection.

2. Enter the IP address that is assigned to the access point.

A login window displays.

If your browser displays a security warning, you can proceed, or add an exception for the security warning. For more information, see [What to do if you get a browser security warning](#) on page 42.

3. Enter the access point user name and password.

The user name is **admin**. The password is the one that you specified. The user name and password are case-sensitive.

If you previously added the access point to a NETGEAR Insight network location and managed the access point through the Insight Cloud Portal or Insight app, enter the Insight network password for that location. For more information, see [Connect over WiFi using the NETGEAR Insight app](#) on page 24.

The Dashboard page displays.

4. Select **Management > Configuration > Wireless > Basic**.

The page that displays lets you select and add an SSID.

5. Click the ► button to the left of the SSID.

The settings for the selected SSID display.

6. Scroll down and click the **Advanced Rate Selection** tab.

Advanced Rate Selection

2.4 GHz

Fixed Multicast Rate
Auto

Rate Control

Density Level

Environment: Density - Very Low, Compatibility - 802.11b/g/n/ax, Overall Performance - Reduced, Coverage - Very Wide

5 GHz

Fixed Multicast Rate
Auto

Rate Control

Density Level

Environment: Density - Very Low, Compatibility - 802.11a/n/ac/ax, Overall Performance - Reduced, Coverage - Very Wide

Note: For the selected SSID, you can specify the radio settings for the 2.4 GHz and 5 GHz radio bands individually. The descriptions in the following steps apply to both radios.

7. To apply basic fixed multicast rates, from the **Fixed Multicast Rate** menu, select one of the following rates, depending on the radio band:
 - **2.4 GHz:** **1**, **2**, **5.5**, or **11** Mbps or **Auto**. (By default, Auto is 11 Mbps.)
 - **5 GHz:** **6**, **12**, or **24** Mbps or **Auto**. (By default, Auto is 24 Mbps.)
8. To enable automatic minimum rate control for beacon and other management frames and for control and data frames, select the **Rate Control** check box.
If you select the **Rate Control** check box, the **Density Level** slider becomes available.
9. To set the density level for your environment, move the **Density Level** slider to **0**, **1**, **2**, **3**, or **4**.
As you move the slider, the selected density level is mapped to a corresponding WiFi mode, beacon rate, minimum legacy rate, and minimum MCS rate. The available settings depend on the WiFi mode that you select for the radio (see [Change the WiFi mode for a radio](#) on page 88). By default, the WiFi mode for each radio is 11ax.

The density level for the WiFi network is based on the following interdependent components, for which a setting is assigned by the position of the slider but *which you cannot set individually*:

- **Density of the WiFi clients:** In the default 11ax WiFi mode for the radios, the setting can be very low, low, medium, high, or very high, depending on the position of the slider.
- **Compatibility with WiFi modes for legacy clients:** In the default 11ax WiFi mode for the radios, the setting can be as follows:
 - **2.4 GHz:** 802.11b/g/n/ax, which supports 802.11b clients, or 802.11g/n/ax, which does not.
 - **5 GHz:** 802.11a/n/ac/ax, which supports all types of clients in the 5 GHz radio band in any position of the slider.
- **Overall performance for the WiFi clients:** In the default 11ax WiFi mode for the radios, the setting can be reduced, moderate, good, very good, or optimal, depending on the position of the slider.
- **WiFi coverage:** In the default 11ax WiFi mode for the radios, the setting can be very narrow, narrow, average, wide, or very wide, depending on the position of the slider.

Note: The help text in the local browser UI provides a table with detailed information about how the WiFi mode of a radio affects these components and how these components depend on each other.

10. Click the **Apply** button.
Your settings are saved.

13

Set up a WiFi Bridge

This chapter describes how you can configure a wireless distribution system (WDS) that consists of point-to-point WiFi bridge connections between two access points. Each WiFi bridge connection requires a WDS profile for which the settings must match on the access points that make up the bridge.

A WDS is *not* the same as a NETGEAR Insight Instant Mesh WiFi network, which requires a root (see [Install the Access Point in an Insight Instant Mesh WiFi Network](#) on page 44).

The chapter includes the following sections:

- [WiFi base station, WiFi repeater, and WiFi bridge requirements](#)
- [Set up a WiFi bridge between access points](#)

Note: If you enable Energy Efficiency Mode, you cannot use a WDS. To use a WDS, first disable Energy Efficiency Mode. For more information, see [Manage the Energy Efficiency Mode](#) on page 175.

Note: In this manual, *WiFi network* means the same as SSID (service set identifier or WiFi network name) or VAP (virtual access point). That is, when we refer to a WiFi network we mean an individual SSID or VAP.

WiFi base station, WiFi repeater, and WiFi bridge requirements

If the access point is connected to the Internet over a wired connection, the access point can function as the WiFi base station for up to four other access points that function as WiFi repeaters. The access point itself can also function as a WiFi repeater if it is connected to another access point that functions as a WiFi base station.

A WiFi base station connects to the Internet, wired and WiFi clients can connect to the base station, and the base station sends its WiFi signal to one or more access points that function as WiFi repeaters. Wired and WiFi clients can also connect to a WiFi repeater, but the repeater connects to the Internet through the WiFi base station.

The following figure shows two access points in a WiFi repeating setup with a WiFi base station on the left side and a single WiFi repeater on the right side.

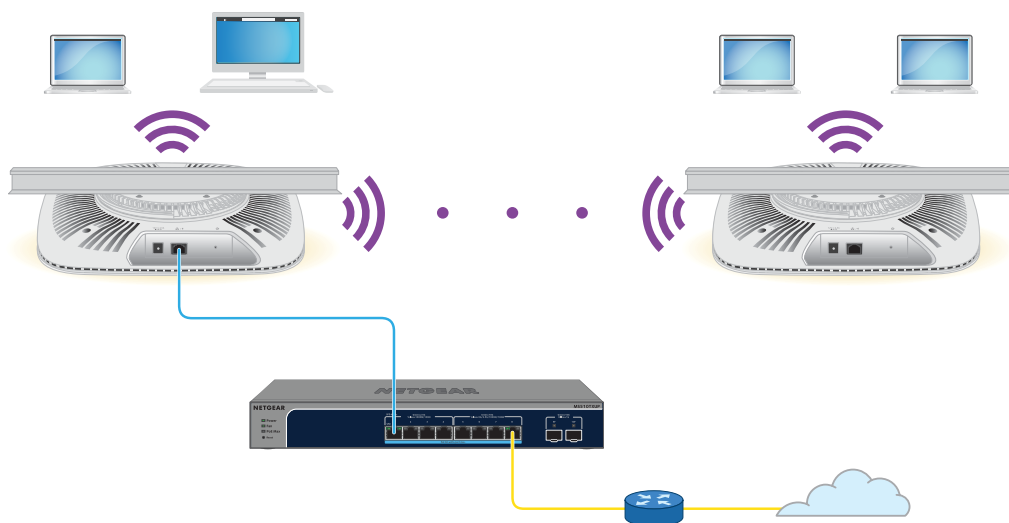

Figure 9. WiFi bridge configuration between two access points in the 5 GHz radio band

To use a WiFi bridge, you cannot use the auto channel feature for the access point and the SSID broadcast must be enabled.

For a WiFi bridge, you must set up one access point as a WiFi base station and another access point as a WiFi repeater:

Before you can set up a WiFi network with WDS, your configuration must meet the following conditions:

- Both access points must use the same WiFi channel and WiFi security settings.
- Both access points must be on the same LAN IP subnet. That is, all of the access point LAN IP addresses are in the same network.

- All LAN devices (wired and WiFi computers) are configured to operate in the same LAN network address range as the access points.

Note: If you are using the access point as the base station with a non-NETGEAR access point as a repeater, you might need to change more configuration settings. In particular, you might need to disable the DHCP server function on the non-NETGEAR access point that is the repeater.

Set up a WiFi bridge between access points

The following procedure describes how you can configure the WiFi bridge settings on one access point and then do the same on another access point, allowing the WiFi bridge to be established.

To set up a WiFi bridge between two access points:

1. Launch a web browser from a computer that is connected to the same network as the access point or directly to the access point through an Ethernet cable or WiFi connection.

2. Enter the IP address that is assigned to the access point.

A login window displays.

If your browser displays a security warning, you can proceed, or add an exception for the security warning. For more information, see [What to do if you get a browser security warning](#) on page 42.

3. Enter the access point user name and password.

The user name is **admin**. The password is the one that you specified. The user name and password are case-sensitive.

If you previously added the access point to a NETGEAR Insight network location and managed the access point through the Insight Cloud Portal or Insight app, enter the Insight network password for that location. For more information, see [Connect over WiFi using the NETGEAR Insight app](#) on page 24.

The Dashboard page displays.

4. Select **Management > Configuration > Wireless Bridge**.

The page that displays lets you select a WDS profile (WDS 1, WDS 2, WDS 3, or WDS 4).

5. Click the ► button to the left of a WDS profile.

The WDS profile page displays.

6. Select the Band **2.4 GHz** or **5 GHz** radio button.

Your selection determines the radio band on which the WDS is established. For countries that do not support dual-band operation, you cannot select the radio.

7. Select the VAP **Enable** radio button.
By default, a WDS profile is disabled.

The screenshot shows a configuration form for a WDS profile. It includes sections for Band (2.4 GHz selected), VAP (Enable selected), Wireless Network Name (SSID) (Netgear-WDS-1), Local MAC Address (44-A5-6E-69-2E-49), Remote MAC Address (00-00-00-00-00-00), and Authentication (Open). There are Cancel and Apply buttons at the bottom.

8. Configure the WDS profile settings as described in the following table.

Setting	Description
Wireless Network Name (SSID)	The WiFi network name of the network on which the WDS is established. The default name is Netgear-WDS-x, in which x is the number of the WDS (1, 2, 3, or 4). Note: The WiFi network name must be identical on the WiFi base station and the WiFi repeater.
Local MAC Address	The MAC address of the local WDS radio interface, that is, the MAC address of the local radio on which the WDS is established. You cannot change this MAC address on this page. The MAC address is displayed for your information. Enter this MAC address on the remote access point of the WDS connection.
Remote MAC Address	The MAC address of the remote WDS radio interface, that is, the MAC address of the remote radio on which the WDS is established.
Network Authentication, Data Encryption, and Passphrase	By default, the selection from the menu is Open, in which case authentication and data encryption are not applicable. To secure the WDS connection, select WPA2 Personal and specify the following settings: <ul style="list-style-type: none"> • Encryption: The data encryption is AES and you cannot change this setting. • Passphrase: The passphrase for the WDS connection. For you to enable the WDS connection, the passphrase on the remote access point must match the passphrase that you define in this field.

9. Click the **Apply** button.
Your settings are saved.

10. Configure the WiFi bridge settings on the access point at the other end of the WiFi bridge and restart that access point.

Note: If the device at the other end of the WiFi bridge is a NETGEAR access point, you might not need to restart it.

The WiFi bridge is established.

11. Verify connectivity across the LANs of both access points.

If the configuration is set up correctly, a computer on any WiFi or wired LAN segment of the access point that functions as the WiFi repeater can connect to the Internet or share files and printers with any other computer or server connected to the access point that functions as the WiFi base station.

Note: After the WiFi bridge is established, you cannot change the WiFi channel for the radio on which the WiFi bridge is established.

14

Manage the Advanced Radio Features

This chapter describes how you can manage the advanced radio features of the access point. For information about the basic radio features, see [Manage the Basic Radio Features](#) on page 83.

CAUTION: If you change a radio feature on the 2.4 GHz radio, the change affects all WiFi networks that broadcast on the 2.4 GHz radio. Similarly, if you change a radio feature on the 5 GHz radio, the change affects all WiFi networks that broadcast on the 5 GHz radio. If the change is not specific to one radio, the change affects *all* WiFi networks on the access point.

The chapter includes the following sections:

- [Manage the advanced WiFi settings for the radios](#)
- [Manage the maximum number of clients for a radio](#)
- [Manage the broadcast and multicast settings for a radio](#)
- [Manage load balancing for the radios](#)
- [Manage sticky clients](#)
- [Manage the ARP proxy](#)

Note: If you want to change the radio settings, use a wired connection to avoid being disconnected when the new radio settings take effect.

Note: In this manual, *WiFi network* means the same as SSID (service set identifier or WiFi network name) or VAP (virtual access point). That is, when we refer to a WiFi network we mean an individual SSID or VAP.

Manage the advanced WiFi settings for the radios

The advanced WiFi settings for the radios apply to all WiFi networks (VAPs or SSIDs). Although these settings work fine for most network environments and it is unlikely that you need to change them, you *can* change the radio settings, and you can do so for the 2.4 GHz and 5 GHz radios individually.

CAUTION: We recommend that you change these advanced WiFi settings only if you fully understand the consequences. Incorrect configuration might cause connectivity problems for devices trying to connect to the access point.

A radio must be turned on for you to change the settings. For more information about turning a radio on, see [Turn a radio on or off](#) on page 87.

To manage the advanced WiFi settings for the radios:

1. Launch a web browser from a computer that is connected to the same network as the access point or directly to the access point through an Ethernet cable or WiFi connection.

2. Enter the IP address that is assigned to the access point.
A login window displays.

If your browser displays a security warning, you can proceed, or add an exception for the security warning. For more information, see [What to do if you get a browser security warning](#) on page 42.

3. Enter the access point user name and password.

The user name is **admin**. The password is the one that you specified. The user name and password are case-sensitive.

If you previously added the access point to a NETGEAR Insight network location and managed the access point through the Insight Cloud Portal or Insight app, enter the Insight network password for that location. For more information, see [Connect over WiFi using the NETGEAR Insight app](#) on page 24.

The Dashboard page displays.

4. Select **Management > Configuration > Wireless > Advanced**.

The screenshot shows the configuration interface for the 2.4 GHz and 5 GHz radios. The 2.4 GHz section includes settings for Max. Wireless Clients (128), 802.11n 256 QAM (checked), MU-MIMO (Enable), RTS Threshold (2346), DTIM Interval (2), Beacon Interval (100), and Broadcast/Multicast Rate Limiting (checked). The 5 GHz section includes settings for Max. Wireless Clients (128), MU-MIMO (Enable), Broadcast/Multicast Rate Limiting (checked), RTS Threshold (2346), 802.11h (Disable), and DTIM Interval (2). Buttons for 'Cancel' and 'Apply' are at the bottom.

5. Configure the settings as described in the following table.
 The descriptions in the table apply to both radios. You can specify the radio settings for the 2.4 GHz and 5 GHz radios individually, but the check box for the 802.11n 256 QAM feature applies to the 2.4 GHz radio only (the feature is always enabled for the 5 GHz radio). The 802.11h feature applies to the 5 GHz radio only.

Insight Managed WiFi 6 AX3000 Access Point Model WAX618

Setting	Description
Max. Wireless Clients	<p>Enter the maximum number of WiFi clients that can simultaneously associate with the radio.</p> <p>The range is from 1 to 128 WiFi clients, and the default is 128.</p>
RTS Threshold (256-2346)	<p>Enter the Request to Send (RTS) threshold. The range is from 256 to 2346. The default is 2346.</p> <p>If the packet size is equal to or less than the RTS threshold, the radio uses the Carrier Sense Multiple Access with Collision Detection (CSMA/CD) mechanism and the data frame is transmitted immediately after the silence period. If the packet size is larger than the RTS threshold, the system uses the CSMA with Collision Avoidance (CSMA/CA) mechanism. In this situation, the transmitting device sends the RTS packet to the receiving device and waits for the receiving device to return a Clear to Send (CTS) packet before sending the actual packet data.</p>
Beacon Interval (100-300)	<p>Enter an interval between 100 ms and 300 ms for each beacon transmission, which allows the radio to synchronize the WiFi network. The default is 100 ms.</p> <p>Note: If you set up more than four WiFi networks, the beacon interval is automatically changed to 300.</p>
802.11n 256 QAM	<p>When the WiFi mode is 802.11n, you can select the 802.11n 256 QAM check box to enable the 2.4 GHz radio to function over 256-quadrature amplitude modulation (QAM), which can increase the 2.4 GHz radio throughput for 802.11n clients that are capable of supporting 256 QAM. By default, 256 QAM is disabled for the 2.4 GHz radio, that is, the check box is cleared.</p> <p>By default, 256-QAM is enabled for the 5 GHz radio and you cannot disable it (the page does not provide a check box for the 5 GHz radio).</p>
DTIM Interval (1-255)	<p>Move the slider to specify the delivery traffic indication message (DTIM) interval or the data beacon rate, which indicates the beacon delivery traffic indication message period in multiples of beacon intervals. This value must be between 1 and 255. The default is 2.</p>
Broadcast/Multicast Rate Limiting	<p>Multicast and broadcast rate limiting is enabled by default to improve the overall network performance by limiting the number of packets that are transmitted across the network. By default, the setting is 50 (the maximum possible value), which specifies a maximum rate limit of 50 packets per second. To change the setting, move the slider. To disable multicast and broadcast rate limiting, clear the small check box.</p>

(Continued)

Setting	Description
MU-MIMO	<p>By default, the MU-MIMO Enable radio button is selected and multiuser MIMO (MU-MIMO) is enabled. To disable MU-MIMO, select the MU-MIMO Disable radio button.</p> <p>MU-MIMO enables multiple users to receive data from the access point simultaneously using the same channel. With MU-MIMO, the access point can transmit to multiple clients simultaneously using the same channel. MU-MIMO is used in the downstream direction and requires both the access point and the WiFi clients to be capable of 802.11ac Wave 2 or 802.11ax.</p>
802.11h	<p>Select the 802.11h Enable radio button to enable 802.11h-capable WiFi clients to automatically switch to a new channel without disconnecting from the access point and without losing any data when the access point changes to another channel. By default, the 802.11h Disable radio button is selected and 802.11h is disabled.</p> <p>You can enable or disable 802.11h for the 5 GHz radio but not for the 2.4 GHz radio.</p>

6. Click the **Apply** button.
A warning pop-up window displays.
7. Click the **OK** button.
The pop-up window closes and your settings are saved. The radio or radios restart and WiFi clients might need to reconnect.

Manage the maximum number of clients for a radio

The number of clients that are allowed to associate with a radio affects the reliability and throughput of the WiFi connection. A smaller number can increase the reliability and throughput and a large number can decrease the reliability and throughput.

By default, one radio allows up to 128 client associations. You can specify a lower number of clients. If the number of associated clients exceeds the maximum number that you specify, the radio rejects new client associations until the number drops below that maximum number.

To manage the maximum number of clients for a radio:

1. Launch a web browser from a computer that is connected to the same network as the access point or directly to the access point through an Ethernet cable or WiFi connection.
2. Enter the IP address that is assigned to the access point.
A login window displays.
If your browser displays a security warning, you can proceed, or add an exception for the security warning. For more information, see [What to do if you get a browser security warning](#) on page 42.
3. Enter the access point user name and password.
The user name is **admin**. The password is the one that you specified. The user name and password are case-sensitive.
If you previously added the access point to a NETGEAR Insight network location and managed the access point through the Insight Cloud Portal or Insight app, enter the Insight network password for that location. For more information, see [Connect over WiFi using the NETGEAR Insight app](#) on page 24.
The Dashboard page displays.
4. Select **Management > Configuration > Wireless > Advanced**.
The Wireless Settings page displays.
5. In the **Max.Wireless Clients** field for the radio, enter the maximum number of WiFi clients that can simultaneously associate with the radio.
The range is from 1 to 128 WiFi clients, and the default is 128.
6. Click the **Apply** button.
A warning pop-up window displays.
7. Click the **OK** button.
The pop-up window closes and your settings are saved. The radio or radios restart and WiFi clients might need to reconnect.

Manage the broadcast and multicast settings for a radio

Because multicast and broadcast traffic can adversely affect the throughput and latency of a WiFi network, you can change the multicast and broadcast rate limiting settings for a radio.

By default, multicast and broadcast rate limiting is enabled to improve the overall network performance by limiting the number of packets that are transmitted across the network. By default, the setting is 50 (the maximum possible value), which specifies a maximum rate limit of 50 packets per second. You can lower this number.

To manage the broadcast and multicast settings for a radio:

1. Launch a web browser from a computer that is connected to the same network as the access point or directly to the access point through an Ethernet cable or WiFi connection.
2. Enter the IP address that is assigned to the access point.
A login window displays.
If your browser displays a security warning, you can proceed, or add an exception for the security warning. For more information, see [What to do if you get a browser security warning](#) on page 42.
3. Enter the access point user name and password.
The user name is **admin**. The password is the one that you specified. The user name and password are case-sensitive.
If you previously added the access point to a NETGEAR Insight network location and managed the access point through the Insight Cloud Portal or Insight app, enter the Insight network password for that location. For more information, see [Connect over WiFi using the NETGEAR Insight app](#) on page 24.
The Dashboard page displays.
4. Select **Management > Configuration > Wireless > Advanced > Wireless Settings**.
The Wireless Settings page displays.
5. To change the multicast and broadcast rate limiting settings, under Broadcast/Multicast Rate Limiting for the radio, take one of the following actions:
 - To change the rate limiting setting, move the slider. By default, the setting is 50 (the maximum possible value), which specifies a maximum rate limit of 50 packets per second.
 - To disable or enable multicast and broadcast rate limiting, clear or select the small check box.
6. Click the **Apply** button.
A warning pop-up window displays.
7. Click the **OK** button.
The pop-up window closes and your settings are saved. The radio or radios restart and WiFi clients might need to reconnect.

Manage load balancing for the radios

You can configure the radio utilization thresholds to enable each radio to maintain the speed and performance of the WiFi network as clients associate with and disassociate from the WiFi network.

If you enable load balancing, client associations depend on the maximum number of clients per radio, the channel load per radio, and each client's Received Signal Strength Indicator (RSSI). New client associations are allowed if a radio's utilization remains within the defined load balancing settings. If a radio's utilization exceeds the defined load balancing settings, new client associations are temporarily halted until the radio's utilization falls within the defined load balancing settings.

Note: The Dashboard page can show information about the client and traffic distribution per radio as well as the client, traffic, and channel utilization for each radio (see [Display client distribution, connected clients, and client trends](#) on page 186 and [View WiFi and Ethernet traffic, traffic and ARP statistics, and channel utilization](#) on page 189).

By default, all of the following types of load balancing are enabled with their default settings:

- **Load balancing based on the maximum number of clients:** The access point allows client associations up to the specified maximum number of clients. After the maximum number is exceeded, new clients are rejected. Even though this is a global setting, it is implemented per radio.
- **Load balancing based on the channel load:** The access point allows client associations up to the defined maximum channel utilization. After the maximum channel utilization is exceeded, new clients are rejected. Even though this is a global setting, it is implemented per radio.

Note: If a client is rejected but persistently tries to associate with the access point, the access point grants access to that client.

- **Load balancing based on the RSSI of the client:** Clients with an RSSI that is equal to or higher than the defined minimum are allowed to associate with the access point. Clients with an RSSI below the defined minimum are rejected. Even though this is a global setting, it is implemented per radio.

Note: If a client is rejected but persistently tries to associate with the access point, the access point grants access to that client.

You can change the default settings for each type of load balancing, or completely disable one or more types of load balancing.

To manage load balancing for the radios:

1. Launch a web browser from a computer that is connected to the same network as the access point or directly to the access point through an Ethernet cable or WiFi connection.

2. Enter the IP address that is assigned to the access point.

A login window displays.

If your browser displays a security warning, you can proceed, or add an exception for the security warning. For more information, see [What to do if you get a browser security warning](#) on page 42.

3. Enter the access point user name and password.

The user name is **admin**. The password is the one that you specified. The user name and password are case-sensitive.

If you previously added the access point to a NETGEAR Insight network location and managed the access point through the Insight Cloud Portal or Insight app, enter the Insight network password for that location. For more information, see [Connect over WiFi using the NETGEAR Insight app](#) on page 24.

The Dashboard page displays.

4. Select **Management > Configuration > Wireless > Advanced > Load Balancing**.

5. To globally enable load balancing for the radios, select the Load Balancing Mode **Enable** radio button.

The page adjusts and displays a slider for each type of load balancing and each radio.

By default, load balancing is disabled. When you enable load balancing, all three types of load balancing are enabled. You can individually disable one or more types of load balancing.

6. To individually enable or disable one or more types of load balancing, do the following:
 - To disable a particular type of load balancing, clear the small blue check box to the left of the *Based On* text.
 - To enable a particular type of load balancing, select the small blue check box to the left of the *Based On* text.
7. To change the load balancing settings, do the following:
 - **Based On Maximum Number Of Clients:** For each radio, move the associated slider to specify the maximum number of clients allowed, before the radio stops accepting new client associations.
For each radio, the minimum number of clients is 5 and the maximum number is 128, and the default number is 128.
 - **Based On Channel Load:** For each radio, move the associated slider to specify the maximum percentage of channel load that is allowed on the radio, before it stops accepting new client associations.
For each radio, the minimum percentage of channel load is 50, the maximum percentage is 90, and the default percentage is 70.
 - **Based on Channel Receive Signal Strength:** For each radio, move the associated slider to specify the minimum required RSSI value for an individual client, below which the radio does not accept the client association.
For each radio, the minimum RSSI value is 1, the maximum value is 50, and the default value is 23.
8. Click the **Apply** button.
Your settings are saved.

Manage sticky clients

During roaming, sticky clients do not change to an access point with a better signal but remain associated with (that is, *stick to*) their initial access point, even though the quality of the connection to that access point is degraded. Such a situation causes delay for other clients that are associated with that access point.

Note: For a home WiFi network with a single access point, a sticky client is useful because no other access point is available to associate with during roaming. For a business or enterprise network with multiple access points, a sticky client can cause a drain on WiFi resources.

You can force sticky clients to disassociate from the radios of the access point.

If load balancing based on the RSSI of the client is enabled (see [Manage load balancing for the radios](#) on page 225), after a client is forced to disassociate, the client can join again in the following situations:

- The client can associate again if its RSSI is equal to or higher than the minimum required RSSI.
- If the client persistently tries to associate with the access point, the access point grants access to that client, even if its RSSI is below minimum required RSSI.

To manage sticky clients:

1. Launch a web browser from a computer that is connected to the same network as the access point or directly to the access point through an Ethernet cable or WiFi connection.

2. Enter the IP address that is assigned to the access point.

A login window displays.

If your browser displays a security warning, you can proceed, or add an exception for the security warning. For more information, see [What to do if you get a browser security warning](#) on page 42.

3. Enter the access point user name and password.

The user name is **admin**. The password is the one that you specified. The user name and password are case-sensitive.

If you previously added the access point to a NETGEAR Insight network location and managed the access point through the Insight Cloud Portal or Insight app, enter the Insight network password for that location. For more information, see [Connect over WiFi using the NETGEAR Insight app](#) on page 24.

The Dashboard page displays.

4. Select **Management > Configuration > Wireless > Advanced > Load Balancing**.

The Load Balancing page displays.

5. Either select or clear the **Force Sticky Clients To Disassociate** check box.

Selecting the check box forces sticky clients to disassociate from a radio. Clearing the check box allows sticky clients to remain associated with a radio.

6. Click the **Apply** button.

Your settings are saved.

Manage the ARP proxy

By default, the ARP proxy is enabled on the access point, allowing it to inspect all ARP broadcast packets for its clients. In this way, the access point responds to ARP requests for its clients, preventing unnecessary broadcast traffic on the radios.

For information about the ARP statistics, including the number of proxied and dropped packets, see [View WiFi and Ethernet traffic, traffic and ARP statistics, and channel utilization](#) on page 189.

To manage the ARP proxy:

1. Launch a web browser from a computer that is connected to the same network as the access point or directly to the access point through an Ethernet cable or WiFi connection.
2. Enter the IP address that is assigned to the access point.
A login window displays.
If your browser displays a security warning, you can proceed, or add an exception for the security warning. For more information, see [What to do if you get a browser security warning](#) on page 42.
3. Enter the access point user name and password.
The user name is **admin**. The password is the one that you specified. The user name and password are case-sensitive.
If you previously added the access point to a NETGEAR Insight network location and managed the access point through the Insight Cloud Portal or Insight app, enter the Insight network password for that location. For more information, see [Connect over WiFi using the NETGEAR Insight app](#) on page 24.
The Dashboard page displays.
4. Select **Management > Configuration > Wireless > Advanced > ARP Proxy**.
The ARP Proxy page displays.
5. Select one of the following radio buttons
 - **Enable**: The ARP proxy is enabled. This is the default setting.
 - **Disable**: The ARP proxy is disabled. Broadcast traffic on the radios might increase.
6. Click the **Apply** button.
Your settings are saved.

15

Diagnostics and Troubleshooting

This chapter describes how you can capture WiFi packets and troubleshoot the access point and network.

The chapter includes the following sections:

- [Perform a ping test](#)
- [Capture WiFi and Ethernet packets](#)
- [Quick tips for WiFi troubleshooting](#)
- [Troubleshoot with the LEDs](#)
- [The node and root cannot connect](#)
- [Troubleshoot WiFi connectivity for a WiFi client device](#)
- [Troubleshoot Internet browsing](#)
- [You cannot log in to the access point over a LAN connection](#)
- [Changes are not saved](#)
- [You enter the wrong password and can no longer log in to the access point](#)
- [Troubleshoot your network using the ping utility](#)

Note: In this manual, *WiFi network* means the same as SSID (service set identifier or WiFi network name) or VAP (virtual access point). That is, when we refer to a WiFi network we mean an individual SSID or VAP.

Perform a ping test

You can ping the IP address of a device or network location from the access point and view the results of the ping test.

To perform a ping test:

1. Launch a web browser from a computer that is connected to the same network as the access point or directly to the access point through an Ethernet cable or WiFi connection.

2. Enter the IP address that is assigned to the access point.
A login window displays.

If your browser displays a security warning, you can proceed, or add an exception for the security warning. For more information, see [What to do if you get a browser security warning](#) on page 42.

3. Enter the access point user name and password.

The user name is **admin**. The password is the one that you specified. The user name and password are case-sensitive.

If you previously added the access point to a NETGEAR Insight network location and managed the access point through the Insight Cloud Portal or Insight app, enter the Insight network password for that location. For more information, see [Connect over WiFi using the NETGEAR Insight app](#) on page 24.

The Dashboard page displays.

4. Select **Management > Diagnostics > Ping Test**.

Ping Count	<input type="text" value="16"/>	Packet Size(in Bytes)	<input type="text" value="64"/>
Ping Interval(in sec)	<input type="text" value="1"/>	Ping Timeout(in sec)	<input type="text" value="60"/>
Remote Host 	<input type="text" value="8.8.8.8"/>		

Ping Result

5. Specify the settings that are described in the following table.

Setting	Description
Ping Count	The number of pings that the access point must send. The default number is 16.
Packet Size (in Bytes)	The size of each ping packet. The default size is 64 bytes.
Ping Interval (in sec)	The interval between pings. The default interval is 1 second.
Ping Timeout (in sec)	The period after which a ping times out. The default period is 60 seconds.
Remote Host	The IP address that the access point must ping.

- To start the ping test, click the **Start** button.
The results of the ping test display in the Ping Result field.
- To stop the ping test before the ping count is reached or if the ping times out, click the **Stop** button.

Capture WiFi and Ethernet packets

You can capture WiFi and Ethernet packets that are received and transmitted by the access point and save the file with captured packets to your computer. During the packet capture process, normal functioning of the access point is not affected.

The packet capture capability can be useful for analyzing a WiFi deployment, monitoring a WiFi network, debugging protocols, determining WiFi network bottlenecks, and, in general, troubleshooting any irregularities in a WiFi network.

You can select to capture all packets or selected packets only.

Note: To view the captured packets, you need an application that can open .pcap files.

To capture packets:

- Launch a web browser from a computer that is connected to the same network as the access point or directly to the access point through an Ethernet cable or WiFi connection.
- Enter the IP address that is assigned to the access point.

A login window displays.

If your browser displays a security warning, you can proceed, or add an exception for the security warning. For more information, see [What to do if you get a browser security warning](#) on page 42.

3. Enter the access point user name and password.

The user name is **admin**. The password is the one that you specified. The user name and password are case-sensitive.

If you previously added the access point to a NETGEAR Insight network location and managed the access point through the Insight Cloud Portal or Insight app, enter the Insight network password for that location. For more information, see [Connect over WiFi using the NETGEAR Insight app](#) on page 24.

The Dashboard page displays.

4. Select **Management > Diagnostics > Packet Capture**.

5. Specify the settings that are described in the following table.

Setting	Description
Capture Interface	<p>From the Capture Interface menu, select one of the following interfaces on which packets must be captured:</p> <ul style="list-style-type: none"> • br-lan. All packets are captured, that is, packets on the Ethernet interface, 2.4 GHz radio, and 5 GHz radio. This is the default setting. • Eth0. Only packets on the Ethernet interface are captured. • radio1. Only packets on the 2.4 GHz radio are captured. • radio2. Only packets on the 5 GHz radio are captured.
Max. Capture File Size (64-4096 KB)	Enter the maximum size that the file with captured packets is limited to. The range is from 64 to 4096 KB. The default is 1024 KB.

(Continued)

Setting	Description
Promiscuous Capture	To enable the access point to capture packets in promiscuous mode, select the Enable check box. By default, promiscuous mode is disabled. In promiscuous mode the radio or radios receive all traffic on the channel, including traffic that is not destined for the access point. While the radio or radios are operating in promiscuous mode, they continue to serve associated clients. Packets that are not destined for the access point are not forwarded. When the capture process stops, the radio or radios revert to nonpromiscuous mode.
Client Filter	To capture packets for a specific client only, select the Client Filter check box and enter the client's MAC address in the Client Filter MAC Address field.
Client Filter MAC Address	If you select the Client Filter check box, enter the client's MAC address to capture the packets only for the specific client on the selected interface. You must enter the MAC address in hexadecimal format with each octet separated by a hyphen, for example 00-11-22-33-44-55.
Capture Duration (10-3600 secs)	Enter the maximum duration of the capture process (that is, if you do not click the Stop button). The range is from 10 to 3600 seconds. By default, the maximum duration is 300 seconds.

6. To start the packet capture process, click the **Start** button.
If any captured packets are already stored on the access point, you are prompted to allow the packet capture process to overwrite the old information.
7. To stop the packet capture process, click the **Stop** button.
If you do not stop the process manually, the process is automatically stopped when the capture duration period is exceeded.
8. To download the file with captured packets, do the following:
 - a. Click the **Download** button.
 - b. Follow the directions of your browser to save the file to your computer.
9. To display the latest information on the page, click the **Refresh** button.

Quick tips for WiFi troubleshooting

If one or more WiFi networks do not function normally, consider to repower the access point:

1. Unplug the Ethernet cable from the access point to the network switch.
2. If you use a power adapter, disconnect it from the access point.
3. Plug in the Ethernet cable from the access point to the network switch. Wait two minutes.
4. If you use a power adapter, connect it to the access point. Wait two minutes.

If a WiFi client device cannot connect to the access point, check the following:

- Make sure that a WLAN LED on the access point is not off.
If a WLAN LED is off and you did not disable the LEDs (see [Manage the LEDs](#) on page 174), the associated WiFi radio is probably off too. For more information about the WiFi radios, see [Turn a radio on or off](#) on page 87.
- Make sure that the WiFi settings in the WiFi client device and access point match exactly.
The WiFi network name (SSID) and WiFi security settings of the access point and WiFi client device must match exactly.
For information about accessing the access point for initial configuration over a WiFi connection, see [Connect to the access point for initial configuration](#) on page 21.
- Make sure that the WiFi client device supports the authentication and encryption that you are using for the WiFi network. For more information, see [Change the authentication and encryption for a WiFi network](#) on page 71.

Note: If the access point's WiFi authentication and encryption is set to WPA3 Personal and the WiFi client device does support WPA3, make sure that the WiFi adapter device driver is updated to the latest version on the WiFi client device.

- Make sure that the WiFi client device is not too far from the access point or too close. To see if the signal strength improves, move the WiFi client device near the access point but at least 6 feet (1.8 meters) away.
- Make sure that the WiFi signal is not blocked by objects between the access point and the WiFi client device.
- Make sure that the access point's SSID broadcast is not disabled.
If the access point's SSID broadcast is disabled, the WiFi network name is hidden and does not display in the WiFi client device's scanning list. To connect to a hidden network, the user must enter the network name and the WiFi password. For more

information about the SSID broadcast, see [Hide or broadcast the SSID for a WiFi network](#) on page 69.

- Make sure that the WiFi client device does not use a static IP address but is configured to receive an IP address automatically with DHCP. (For most devices, DHCP is the default setting.)

Troubleshoot with the LEDs

For general information about the LEDs and LED icons, see [Top panel with LEDs](#) on page 11.

When you connect the access point to a power source and you did not disable the LEDs (see [Manage the LEDs](#) on page 174), the LEDs light as described here:

1. The Power/Cloud LED lights solid amber initially and then blinks amber slowly. After about two minutes, the Power/Cloud LED turns either solid green or solid blue, indicating that the startup procedure is complete and the access point is ready:
 - **Solid green:** The access point functions either as a standalone access point, or as an Insight discovered access point that is *not* connected to the Insight cloud-based management platform.
 - **Solid blue:** The access point functions in Insight mode and is connected to the Insight cloud-based management platform.
2. When the startup procedure is complete, verify the following:
 - The LAN LED lights solid green or solid amber, depending on the speed of the Ethernet link.
If the access point processes Ethernet traffic, the LAN LED blinks green or blue.
 - The 2.4G WLAN LED and 5G WLAN LED light solid green.
If clients are connected to a radio, the associated WLAN LED lights solid blue. If a radio processes traffic, the associated WLAN LED blinks blue.

You can use the LEDs for troubleshooting. For more information, see the following sections:

- [Power/Cloud LED remains off](#)
- [Power/Cloud LED remains solid amber](#)
- [Power/Cloud LED is blinking amber slowly, continuously](#)
- [The access point functions as a PoE PD and the Power/Cloud LED remains solid amber](#)
- [Power/Cloud LED does not light blue in the NETGEAR Insight management mode](#)
- [Power/Cloud LED does not stop blinking amber, green, and blue](#)

- 2.4G or 5G WLAN LED is off

Power/Cloud LED remains off

If you use a PoE+ connection and the Power/Cloud LED and other LEDs are off when the Ethernet cable is connected to a PoE+ switch, do the following:

- Make sure that the LEDs are not disabled (see Manage the LEDs on page 174).
- Make sure that the Ethernet cable between the access point and the PoE+ switch is correctly connected at both ends.
- Make sure that the other end of the Ethernet cable is plugged into a PoE+ port on a PoE+ switch that is receiving power.
- Make sure that the PoE power budget of the PoE+ switch is not oversubscribed so that the PoE+ switch is capable of delivering PoE+ (802.3at) power to the access point.

If you use an optional power adapter and the Power/Cloud LED and other LEDs remain off when the access point is turned on, do the following:

- Make sure that the LEDs are not disabled (see Manage the LEDs on page 174).
- Make sure that the power adapter is correctly connected to the access point, and that the power adapter is correctly connected to a functioning power outlet. If it is plugged into a power strip, make sure that the power strip is turned on. If it is plugged directly into the wall, verify that the outlet is not switched off.
- Make sure that you are using the NETGEAR power adapter for this product. That is, do not use the NETGEAR power adapter for another NETGEAR product or a third-party power adapter.

If the error persists, a hardware problem might exist. For recovery instructions or help with a hardware problem, contact technical support at netgear.com/support.

Power/Cloud LED remains solid amber

When you connect the access point to a power source, the Power/Cloud LED lights solid amber initially, then blinks amber slowly, and finally turns solid green or solid blue, indicating that the startup procedure is complete and the access point is ready.

If the Power/Cloud LED remains solid amber after five minutes, either a boot error occurred or the access point is malfunctioning.

Do the following:

1. Disconnect the access point from its power source, reconnect it, and wait several minutes to see if the startup procedure completes successfully.
2. If the startup procedure still does not complete successfully and the Power/Cloud LED remains solid amber after five minutes, use the **Reset** button to return the access point to its factory default settings.

For more information, see [Use the Reset button to reset the access point](#) on page 170.

If the error persists, a hardware problem might exist. For recovery instructions or help with a hardware problem, contact technical support at netgear.com/support.

Power/Cloud LED is blinking amber slowly, continuously

When you connect the access point to a power source, the Power/Cloud LED lights solid amber temporarily and then turns solid green or solid blue, indicating that the startup procedure is complete and the access point is ready. During regular operation, the only time that the Power/Cloud LED blinks amber temporarily is when firmware is being upgraded. Also, in that situation, the Power/Cloud LED blinks amber quickly, not slowly.

If the Power/Cloud LED blinks amber slowly and continuously, the access point did not receive an IP address from a DHCP server.

Check to make sure that the DHCP client of the access point is enabled (see [Enable the DHCP client](#) on page 135), that your network includes a DHCP server (or a router that functions as a DHCP server), and that the DHCP server can reach the access point (both must be on the same network).

In the unlikely situation that your network does not include a DHCP server, you might need to configure a fixed (static) IP address on the access point (see [Disable the DHCP client and specify a fixed IP address](#) on page 134).

The access point functions as a PoE PD and the Power/Cloud LED remains solid amber

When you connect the access point to a power source, the Power/Cloud LED lights solid amber initially, then blinks amber slowly, and finally turns solid green or solid blue, indicating that the startup procedure is complete and the access point is ready.

If the access point functions as a PoE PD and the Power/Cloud LED remains solid amber after five minutes, the access point might not be receiving power at the required 802.3at (PoE+) level. For example, this situation might occur if the access point is connected to a switch that provides only 802.3af (PoE) rather than 802.3at (PoE+).

Do the following:

1. Disconnect and reconnect the Ethernet cable at the LAN/PoE+ port on the access point and at the 802.3at (PoE+) port on the PoE+ switch.
The access point restarts.
2. If the Power/Cloud LED remains solid amber after five minutes, check to see why the PoE+ switch cannot provide sufficient PoE power to the access point.
Most likely, the PoE power budget of the PoE+ switch is oversubscribed and you might need to disconnect another PoE device from the PoE+ switch to make sufficient PoE power available for the access point.

If the error persists, see [Power/Cloud LED remains solid amber](#) on page 237.

Power/Cloud LED does not light blue in the NETGEAR Insight management mode

If the access point functions in the Web-browser management mode, the Power/Cloud LED lights green. This is normal LED behavior.

However, if the access point functions in the NETGEAR Insight management mode and the Power/Cloud LED does not light blue but remains green, the access point is not connected to the Insight cloud-based management platform.

If the access point functions in the NETGEAR Insight management mode and the Power/Cloud LED does not light blue, try the following troubleshooting steps until the problem is resolved:

1. Verify that the management mode of the access point is NETGEAR Insight.
For more information, see [Change the management mode to NETGEAR Insight or Web-browser](#) on page 150.
2. Make sure that the Ethernet cable connection between the access point and your network is good.
3. Make sure that the access point is connected to the Internet and that the Internet connection is good.
4. Make sure that the access point is running the latest firmware version.
For more information, see [Manage the firmware of the access point](#) on page 158.
5. Disconnect and reconnect the Ethernet cable at the LAN/PoE+ port and wait five minutes to see if the Power/Cloud LED lights solid blue.
If you use a power adapter with the access point, disconnect and reconnect the power adapter and wait five minutes to see if the Power/Cloud LED lights solid blue.

6. If the problem is still not resolved, use the **Reset** button to return the access point to its factory default settings, and reconfigure the access point.

For more information, see [Use the Reset button to reset the access point](#) on page 170.

If the error persists, a hardware problem might exist. For recovery instructions or help with a hardware problem, contact technical support at netgear.com/support.

Power/Cloud LED does not stop blinking amber, green, and blue

During the initial installation and configuration process in an Insight Instant Mesh WiFi network, the Power/Cloud LED blinks amber, green, and blue while the access point is being configured as a node. For more information, see [Connect the access point as a node to a root using the Insight app](#) on page 53.

If the Power/Cloud LED does not stop blinking amber, green, and blue, the node cannot connect.

Check the following items or try the following troubleshooting steps:

- Make sure that at least one root is available for the node to connect to.
- Make sure that all roots run the latest firmware version.
- Make sure that the output power of each radio on each root is at its maximum level. By default, the output power for a radio is at its maximum level. For more information, see [Change the output power for a radio](#) on page 93.
- Make sure that the node is not too far away from a root. For more information, see [The node and root cannot connect](#) on page 241.
- Restart the node.
- Remove the node from your Insight network location and from your Insight account. Then, add the node to your Insight account again and to your Insight network location.

2.4G or 5G WLAN LED is off

If the 2.4G WLAN LED or 5G WLAN LED is off, do the following:

- Check to see if a radio is disabled (see [Turn a radio on or off](#) on page 87). By default, the radios are enabled and the WLAN LEDs light as follows:
 - **Solid green:** The radio is operating without any clients.
 - **Solid blue:** The radio is operating with clients.
 - **Blinking blue:** The radio is operating with clients and is processing traffic.

- If you are using a PoE connection, make sure that the PoE+ switch is providing sufficient power to the access point. The access point requires power at the 802.3at (PoE+) level. Power at a level lower than PoE+ affects the radios. For more information, see [The access point functions as a PoE PD and the Power/Cloud LED remains solid amber](#) on page 238.

If the error persists, a hardware problem might exist. For recovery instructions or help with a hardware problem, contact technical support at netgear.com/support.

The node and root cannot connect

When you add the access point as a node to an Insight network location that includes one or more roots (see [Connect the access point as a node to a root using the Insight app](#) on page 53), we recommend that you place the node in the same room as a root during the initial sync. After a successful sync, move the node to the location where you intend to use it.

For a reliable WiFi connection, place the node less than 25 feet (7.5 m), in a line of sight with minimal obstacles from the closest root.

To sync the node and the root after you already added the node to an Insight network location:

1. Place the node in the same room as the root.
Use this node location only during the sync process.
2. Connect the node to a power source.
If you do not use a PoE connection to a PoE switch, connect a power adapter to the DC power connector.
The Power/Cloud LED on the node lights solid amber.
3. Wait for the node to go through the initial connection and configuration process and for the Power/Cloud LED to stop blinking amber, green, and blue and to light solid blue.

Note: The initial connection and configuration process might take up to 10 minutes. The node might restart during the configuration process.

The Power/Cloud LED lights as follows during the initial connection and configuration process:

- **Blinking green:** The node is attempting to detect a root.
- **Solid green:** The node is making its first connection with the root that provides the strongest WiFi signal.

- **Blinking amber slowly:** The node is contacting the network router or DHCP server to receive an IP address.
If the Power/Cloud LED does not stop blinking amber, see [Power/Cloud LED is blinking amber slowly, continuously](#) on page 238.
- **Blinking amber, green, and blue:** The node is being configured as a managed device in the Insight Instant Mesh WiFi network.
If the Power/Cloud LED does not stop blinking amber, green, and blue, see [Power/Cloud LED does not stop blinking amber, green, and blue](#) on page 240.

When the configuration is complete, the Power/Cloud LED lights as follows:

- **Solid blue:** The configuration is complete and the node is ready for operation. The node functions in the Insight Instant Mesh WiFi network and is connected to the Insight cloud.

4. Disconnect the node and move it to the location where you intend to use it.
5. At the new location, repeat [Step 2](#) and [Step 3](#).
6. Wait for the node to resync with the root.

When the node's Power/Cloud LED lights solid blue, the node and root synced successfully.

If the node and root did not sync, move the node closer to the root and try again. The node must be within the root's WiFi coverage area to establish a good or fair WiFi connection.

Troubleshoot WiFi connectivity for a WiFi client device

If a WiFi client device cannot connect to the access point or the WiFi connectivity is not normal, try to isolate the problem:

- Make sure that the WiFi settings in the WiFi client device and access point match exactly.
The WiFi network name (SSID) and WiFi security settings of the access point and WiFi device must match exactly. Make sure that the WiFi client device uses the correct passphrase for the WiFi network.
For information about accessing the access point for initial configuration over a WiFi connection, see [Connect to the access point for initial configuration](#) on page 21.
- Does the WiFi client device support the authentication and encryption that you configured for the WiFi network?

For more information, see [Change the authentication and encryption for a WiFi network](#) on page 71.

Note: If the access point's WiFi authentication and encryption is set to WPA3 Personal and the WiFi client device does support WPA3, make sure that the WiFi adapter device driver is updated to the latest version on the WiFi client device.

- Does the WiFi client device find the WiFi network?
If not, check the WLAN LEDs. If a WLAN LED is off, the associated WiFi radio is probably off, too. For more information about the WiFi radios, see [Turn a radio on or off](#) on page 87.
- If you disabled the access point's SSID broadcast for the WiFi network, the WiFi network is hidden and does not display in the WiFi device's network scanning list. (By default, SSID broadcast is enabled.) For more information about the SSID broadcast, see [Hide or broadcast the SSID for a WiFi network](#) on page 69.

Note: If you want to change the settings of a WiFi network on the access point, use a wired LAN connection to avoid being disconnected when the new WiFi settings take effect.

If the WiFi client device finds the WiFi network but the signal strength is weak, check these conditions:

- Is the WiFi client device too far from the access point, or too close?
Place the WiFi client device near the access point, but at least 6 feet (1.8 meters) away, and see whether the signal strength improves.
- Are objects between the WiFi client device and the access point blocking the WiFi signal?

Troubleshoot Internet browsing

If a WiFi device is connected to the access point but unable to load any web pages from the Internet, it might be for one of the following reasons:

- The WiFi device might not recognize any DNS server addresses.
If you manually entered a DNS address when you set up the access point (that is, the access point uses static IP address settings), restart the WiFi device and verify the DNS address.
- The WiFi device might not use the correct TCP/IP settings.
If the WiFi device obtains its information by DHCP, reboot the WiFi device and verify the address of the switch or Internet modem to which the access point is connected.

For information about TCP/IP problems, see [Troubleshoot your network using the ping utility](#) on page 246.

You cannot log in to the access point over a LAN connection

If you are unable to log in to the access point from a computer on your LAN and use the access point's local browser UI, check the following:

- Make sure that you are using the correct login information. The user name is **admin** and the password is the one that you specified. The user name and password are case-sensitive.
If you previously added the access point to a NETGEAR Insight network location and managed the access point through the Insight Cloud Portal or Insight app, enter the Insight network password for that location. For more information, see [Connect over WiFi using the NETGEAR Insight app](#) on page 24.
- Make sure that the IP address of your computer is in the same subnet as the access point.
If you disabled the access point's DHCP client and configured a fixed (static) IP address when you connected the access point to your network (see [Disable the DHCP client and specify a fixed IP address](#) on page 134), change the IP address and subnet mask on your computer to so that the IP addresses of your computer and the access point are in the same IP subnet.
- Try quitting the browser and launching it again.
- If you are using an older type of browser, make sure that Java, JavaScript, or ActiveX is enabled in your browser. For example, if you are using Internet Explorer, click the **Refresh** button to be sure that the Java applet is loaded.
- If your access point's IP address was changed (for example, the DHCP server in your network issued an IP address to the access point) and you do not know the current IP address, use an IP scanner application to detect the IP address.

Note: You can also use the NETGEAR Insight app to discover the IP address that is assigned to the access point. For more information, see [Connect over WiFi using the NETGEAR Insight app](#) on page 24.

If you still cannot find the IP address, reset the access point's configuration to factory defaults. This sets the access point's IP address to 192.168.0.100 and enables the DHCP client. For more information, see [Use the Reset button to reset the access point](#) on page 170.

Changes are not saved

If you are logged in to the access point's local browser UI and the access point does not save the changes that you make on a page, do the following:

- When entering configuration settings, always click the **Apply** button before moving to another page or tab or your changes are lost.
- Click the **Refresh** or **Reload** button in the web browser. It is possible that the changes occurred but that the old settings remain in the web browser's cache.

You enter the wrong password and can no longer log in to the access point

If you enter the wrong admin password three or more times, access to the access point's local browser UI is blocked for a period. For example, if you enter the wrong password three times, access to the access point might be blocked for five minutes.

The blockage period depends on the number of failed login attempts. During the blockage period, any attempts to log in to the access point are ignored, even if you enter the correct password. You must wait until the blockage is lifted, and then you get *a single opportunity* to enter the correct password. If you enter the wrong password again, the blockage period is extended as described in the following table.

Table 2. Login blockage periods

Number of failed attempts	Blockage period in minutes
3	5
4	10
5	20
6	40
And so on	And so on

In addition, the following rules apply to the number of failed login attempts:

- If the number of failed login attempts is smaller than the number of allowed retry attempts, the counter for failed login attempts is reset after 30 minutes. For example,

if you enter the wrong password twice but enter the correct password at the third login attempt, the two failed login attempts are erased from memory after 30 minutes.

- If the number of failed login attempts is larger than the number of allowed retry attempts, the counter for failed login attempts is reset after 24 hours. For example, if you enter the wrong password five times but enter the correct password at the sixth login attempt, the five failed login attempts are erased from memory after 24 hours.
- The last access attempt determines whether the counter for failed login attempts is increased.
- If you restart the access point, the counter for failed login attempts is reset.

Troubleshoot your network using the ping utility

Most network devices and routers contain a ping utility that sends an echo request packet to the designated device. The device then responds with an echo reply. You can easily troubleshoot a network using the ping utility in your computer or workstation.

Test the LAN path to your access point

You can ping the access point from your computer to verify that the LAN path to your access point is set up correctly.

To ping the access point from a Windows-based computer:

1. From the Windows taskbar, click the **Start** button and find and select **Run**.
2. In the field provided, enter **ping** followed by the IP address of the access point, as in this example:

ping 192.168.0.100

3. Click the **OK** button.

A message such as the following one displays:

```
Pinging <IP address> with 32 bytes of data
```

If the path is working, you see this message:

```
Reply from < IP address >: bytes=32 time=NN ms TTL=xxx
```

If the path is not working, you see this message:

```
Request timed out
```

If the path is not functioning correctly, one of the following problems might be occurring:

- Wrong physical connections
Check that the appropriate LEDs are on for your network devices. If your access point and computer are connected to a separate Ethernet switch, make sure that the link LEDs are lit for the switch ports that are connected to your computer and access point.
- Wrong network configuration
Verify that the IP addresses for your computer and the access point are correct and that the addresses are in the same subnet.

Test the path from your computer to a remote device

After you verify that the LAN path works correctly, test the path from your computer to a remote device.

To test the path from your computer to a remote device:

1. From the Windows taskbar, click the **Start** button and find and select **Run**.
2. In the field provided, enter **ping -n 10 IP address**.
IP address is the IP address of a remote device such as a remote DNS server.

If the path is functioning correctly, replies as described in [Test the LAN path to your access point](#) on page 246 display. If you do not receive replies, do the following:

- Check to see that your computer lists the IP address of the router to which the access point is connected as the default router. If the IP configuration of your computer is assigned by DHCP, this information is not visible in your computer's Network Control Panel.
- Check to see that the network address of your computer (the portion of the IP address specified by the netmask) is different from the network address of the remote device.

A

Factory Default Settings and Technical Specifications

This appendix includes the following sections:

- [Factory default settings](#)
- [Technical specifications](#)

Factory default settings

You can reset the access point to the factory default settings, which are shown in the following table.

For more information about resetting the access point to its factory settings, see [Return the access point to its factory default settings](#) on page 170.

Table 3. Factory default settings

Feature	Default Setting
Management and login settings	
Management mode	NETGEAR Insight (Cloud/Remote) Note: To access the local browser UI, you must select Web-browser (Local) as the management mode.
User login URL	192.168.0.100, if not connected to a network. Note: If connected to a network, the access point receives an IP address from a DHCP server or router in the network.
User name	admin , nonconfigurable
AP login password	password , case-sensitive, configurable Note: The first time that you log in to the local browser UI, you must change the AP login password. If you previously added the access point to a NETGEAR Insight network location and managed the access point through the Insight Cloud Portal or Insight app, enter the Insight network password for that location. For more information, see Connect over WiFi using the NETGEAR Insight app on page 24.
WiFi network settings for initial setup and WiFi login	
Initial SSID name	The SSID for initial setup is NETGEARxxxxxx-SETUP, where xxxxxx is the last six hexadecimal digits of the access point's MAC address. Note: The first time that you log in to the local browser UI, you must change the SSID. If you previously added the access point to a NETGEAR Insight network location and managed the access point through the Insight Cloud Portal or Insight app, this requirement might not apply.
Initial WiFi security	WPA2 Personal (which is WPA2-PSK) WiFi password (network key): sharedsecret Note: The first time that you log in to the local browser UI, you must change the WiFi password. If you previously added the access point to a NETGEAR Insight network location and managed the access point through the Insight Cloud Portal or Insight app, this requirement might not apply.
RF channels	Automatically selected (Auto) for all radios. Note: The available and supported channels depend on the country and region that you select for the access point.
General system settings	
Operating mode	AP mode

Insight Managed WiFi 6 AX3000 Access Point Model WAX618

Table 3. Factory default settings (Continued)

Feature	Default Setting
DHCP client	Enabled so that the access point receives an IP address from a DHCP server or router in the network.
NTP client	Enabled
Spanning Tree Protocol	Disabled
Network integrity check	Disabled
IGMP snooping	Disabled
802.1Q VLAN	Untagged VLAN with VLAN ID 1
Management VLAN	VLAN ID 1
Syslog	Disabled
Ethernet LLDP	Enabled
UPnP	Enabled
Multicast DNS gateway	Disabled
LEDs	All enabled
Energy Efficiency Mode	Disabled
WLAN settings for an individual WiFi network (SSID or VAP)	
Broadcast SSID	Enabled
VLAN ID (for WiFi clients)	1
Network authentication	WPA2 Personal (which is WPA2-PSK) The nonconfigurable data encryption for WPA2 Personal is AES
802.11w (PMF)	Disabled
Multi PSK	Disabled
Broadcast schedule	Always on
Radio bands	All enabled
Band steering	Disabled Automatic band steering includes automatic 802.11k RRM and automatic 802.11v WiFi network management.
WiFi client isolation	Disabled
URL tracking	Disabled
DHCP offer broadcast to unicast	Enabled

Table 3. Factory default settings (Continued)

Feature	Default Setting
Captive portal	None
MAC ACL	None assigned
Rate limit	None
Advanced rate selection	Fixed multicast rate: Auto Rate control: Disabled
Basic radio settings that apply to all WiFi networks (SSIDs or VAPs)	
Radio broadcast	2.4 GHz radio: Enabled 5 GHz radio: Enabled
WiFi mode	2.4 GHz radio: 11ax mode, which also supports 11b, 11bg, and 11na 5 GHz radio: 11ax mode, which also support 11a, 11na, and 11ac
Channel width	2.4 GHz radio: 20 MHz 5 GHz radio: 40 MHz
Guard interval	2.4 GHz radio: Long-800 ns 5 GHz radio: Long-800 ns
Output power	2.4 GHz radio: Maximum (100%) 5 GHz radio: Maximum (100%)
Channel	2.4 GHz radio: Auto 5 GHz radio: Auto
Wi-Fi Multimedia (WMM)	2.4 GHz radio: Enabled 5 GHz radio: Enabled
WMM Powersave	2.4 GHz radio: Enabled 5 GHz radio: Enabled
Advanced radio settings that apply to all WiFi networks (SSIDs or VAPs)	
Number of WiFi clients	2.4 GHz radio: 128 default (also the maximum number) 5 GHz radio: 128 default (also the maximum number)
RTS threshold	2.4 GHz radio: Enabled at 2346 5 GHz radio: Enabled at 2346
Beacon interval	2.4 GHz radio: 100 millisecc. 5 GHz radio: 100 millisecc.
802.11n 256 QAM	2.4 GHz radio: Disabled (QAM applies in the 11ng WiFi mode only) 5 GHz radio: Nonconfigurable
MU-MIMO	2.4 GHz radio: Enabled 5 GHz radio: Enabled
DTIM interval	2.4 GHz radio: 2 5 GHz radio: 2

Table 3. Factory default settings (Continued)

Feature	Default Setting
Broadcast and multicast rate limiting	2.4 GHz radio: Enabled with a limit of 50 pps 5 GHz radio: Enabled with a limit of 50 pps
802.11h	2.4 GHz radio: Not applicable 5 GHz radio: Disabled
Load balancing between radios	Disabled
Force sticky clients to disassociate	Disabled
ARP proxy	Disabled
Wireless bridge	None configured
General security	
URL filtering	Disabled
RADIUS servers	None configured
Neighbor AP detection	2.4 GHz radio: Disabled 5 GHz radio: Disabled
MAC ACLs	Eight default ACLs but none configured with MAC addresses
L2 security	Disabled
Remote management	
SNMP	Disabled

Technical specifications

The following table shows the technical specifications.

Table 4. Technical specifications

Feature	Description
WiFi modes	2.4 GHz radio: 802.11ax, 802.11ng, 801.11bg, and 802.11b 5 GHz radio: 802.11ax, 802.11ac, 802.11na, and 802.11a The access point supports 2.4 GHz and 5 GHz band concurrent operation.
Maximum theoretical throughput	About 3000 Mbps simultaneous throughput (600 Mbps in the 2.4 GHz band and 2400 Mbps in the 5 GHz band). Note: Throughput can vary. Network conditions and environmental factors, including volume of network traffic, building materials and construction, and network overhead, affect the data throughput rate.
Maximum number of supported clients	2.4 GHz radio: 128 5 GHz radio: 128 Even though each radio can support 128 clients, the access point can support a maximum of 164 clients with both radios enabled.
802.11 security	WPA3 Personal, WPA3 Enterprise, WPA3/WPA2 Personal, WPA2 Personal, WPA2 Enterprise, WPA2/WPA Personal, Open Enhanced, and Open
WiFi standards	WiFi Multimedia Prioritization (WMM) Wireless distribution system (WDS)
WiFi streams	4 (2+2) streams: 2.4 GHz radio: 2 streams 5 GHz radio: 2 streams
Operating frequency ranges	2.4 GHz band: <ul style="list-style-type: none"> US: 2.412-2.462 GHz Europe: 2.412-2.472 GHz 5 GHz band: <ul style="list-style-type: none"> US: 5.18-5.885 Europe: 5.18-5.32 GHz and DFS 5.50-5.70 GHz
Power over Ethernet	If you do not use a power adapter, the LAN/PoE+ port requires 802.3at (PoE+) power but might also function with 802.3af (PoE) power. We recommend that you use 802.3at (PoE+) power. For more information, see The access point functions as a PoE PD and the Power/Cloud LED remains solid amber on page 238 . Note: PoE might be considered a network environment 0 per IEC TR 62101, and thus the interconnected ITE circuits might be considered safety extra low voltage (SELV).
PoE consumption	21.2W

Insight Managed WiFi 6 AX3000 Access Point Model WAX618

Table 4. Technical specifications (Continued)

Feature	Description
Power adapter	12 VDC, 2.5A The plug is localized to the country of sale. Note: For model WAX618PA, a power adapter is included. For model WAX618, a power adapter is not included but can be ordered as an option.
Hardware interfaces	One RJ-45 LAN/PoE+ Ethernet port that supports 2.5 Gbps, 1 Gbps, 100 Mbps, and 10 Mbps. The port also supports Auto Uplink (Auto MDI-X). Note: Without a power adapter, the LAN/PoE+ port requires 802.3at (PoE+) power but might also function with 802.3af (PoE) power. We recommend that you use 802.3at (PoE+) power. For more information, see The access point functions as a PoE PD and the Power/Cloud LED remains solid amber on page 238.
Dimensions (W x D x H)	9.5 x 9.5 x 1.58 in (241.5 x 241.5 x 40.2 mm)
Weight	1.6 lb (726.5 g)
Operating temperature	32° to 104°F (0° to 40°C)
Operating humidity	10 to 90% maximum relative humidity, noncondensing
Storage temperature	-4° to 158°F (-20° to 70°C)
Storage humidity	5 to 95% maximum relative humidity, noncondensing
EMI certification	FCC Part 15 Report (EMI) SubPart B CE EMC Report, EN 55032/24/35 Report EN 301 489-1/-17 EMC Report
Regulatory compliance US	FCC Grant, FCC Authorization FCC Spectrum Report, Part 15, SubPart C (15.247) FCC Spectrum Report, Part 15, SubPart E (15.407) FCC Standard Absorption Rate Report (SAR or MPE), FCC Part 2 SpJ
Regulatory compliance Europe	EN 300 328, Radio Spectrum Report EN 301 893 Radio Spectrum Report EN 301 893 DFS Report EN RF Exposure (SAR or MPE), EN 50385 (for AP router), EN 50566 (Body SAR)
Safety and energy compliance	IEC 60950-1 CB Certificate and Test Report, CB IEC60950 / EN60950 CE LVD Report, EN60950 Report EC 278/2009, External Power Supply

B

Mount the Access Point to a Wall or Ceiling

You can mount the access point to a wall or to a ceiling with a 15/16 in. (24 mm) T-bar, or you can install the access point freestanding on a flat surface.

We recommend that you use a flat Ethernet cable so that the cable fits in the narrow space between the access point and the surface on which it is mounted or placed.

Before you mount the access point, first set up and test the access point to verify WiFi network connectivity.

This appendix includes the following sections:

- [Mounting parts](#)
- [Mount the access point on a wall](#)
- [Mount the access point to a T-bar](#)
- [Unmount the access point](#)

Mounting parts

The package includes the following mounting parts:

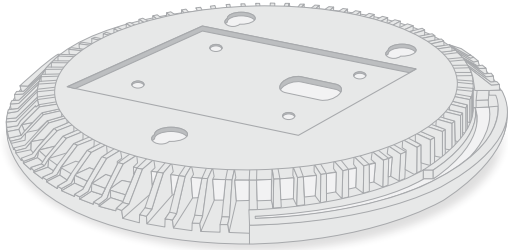

Figure 10. Mounting plate

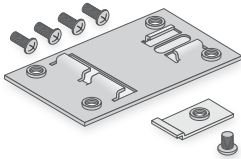

Figure 11. Metal bracket with T-bar lock, lock screw, and 4 short screws

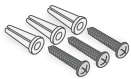

Figure 12. 3 tall screws and anchors for wall mounting

Mount the access point on a wall

CAUTION: Make sure that the wall is not damaged. For example, water damage can destroy a drywall.

To mount the access point on a wall:

1. Place the mounting plate on the wall.
2. Mark the wall where the mounting holes are.
3. Using a 3/16 in. (4.7mm) drill bit, drill holes in the wall.
4. Tap each anchor into the wall with a soft mallet until the anchors are flush with the wall.
5. Use the screws to attach the mounting plate to the wall.

Note: Do not insert the screws into the wall without anchors.

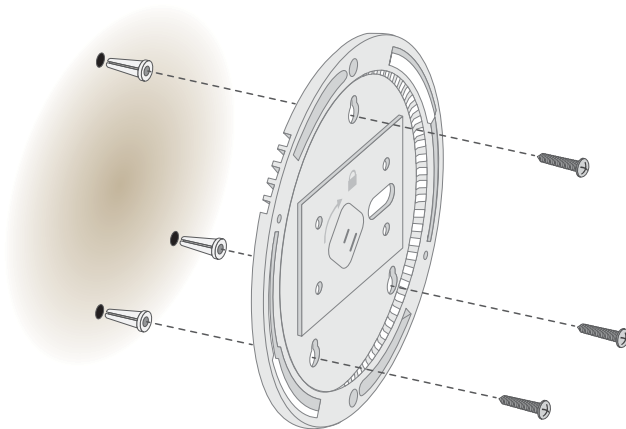

6. Connect an Ethernet cable (if you use a PoE+ switch) or both a power adapter and an Ethernet cable to the access point before you attach the access point to the mounting plate.

The access point sits flat on the wall when it is mounted.

7. Attach the access point to the mounting plate.

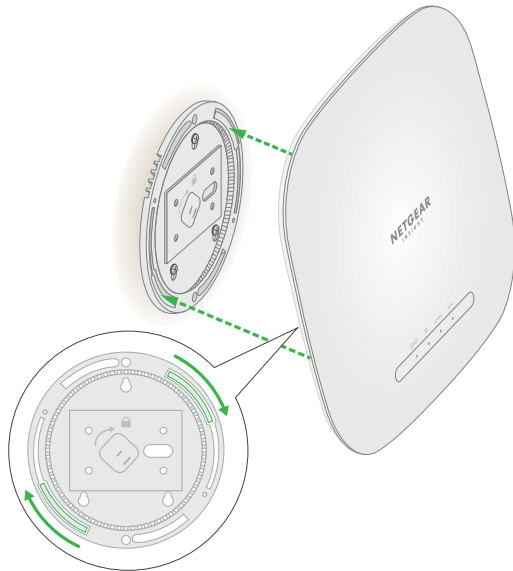

8. Twist the access point clockwise to lock it onto the mounting plate.



Mount the access point to a T-bar

To mount the access point to a T-bar:

1. If the T-bar lock is not yet attached to the metal bracket, slide the T-bar lock partially into the metal bracket.
2. Attach the metal bracket to the T-bar.
3. Push the T-bar lock over the T-bar.

4. Use the lock screw to lock the metal bracket into place.

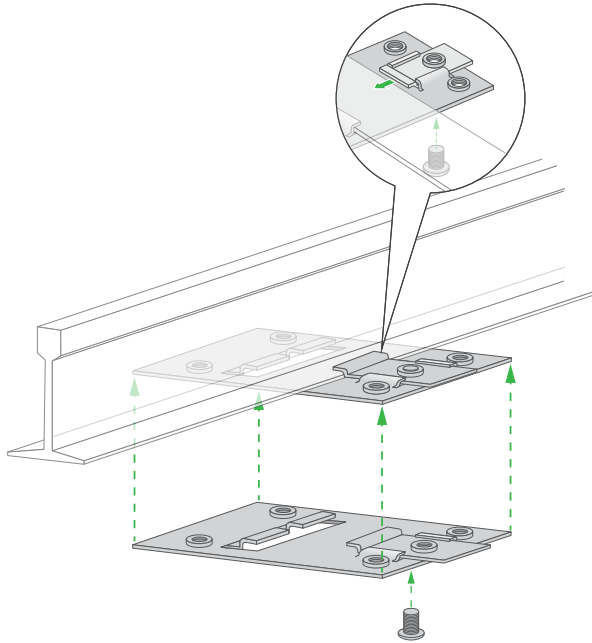

5. Use the four short screws to attach the mounting plate to the T-bar.

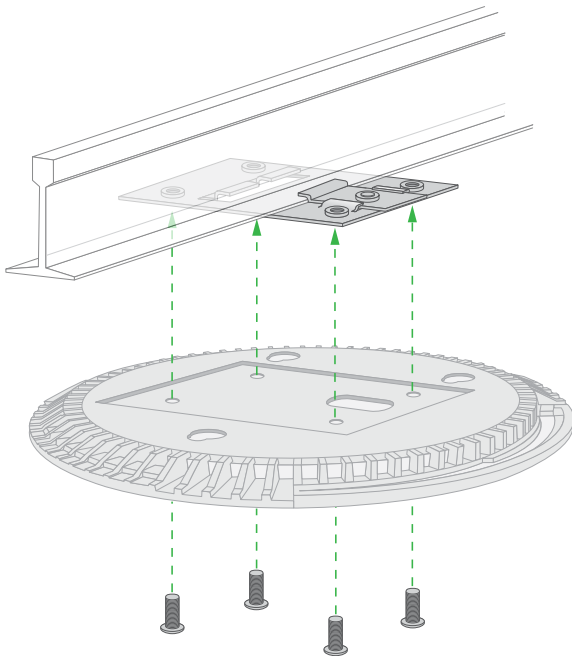

6. Connect an Ethernet cable (if you use a PoE+ switch) or both a power adapter and an Ethernet cable to the access point before you attach the access point to the mounting plate.

The access point sits flat on the ceiling surface when it is mounted.

7. Hold the access point upside down and attach it to the mounting plate.

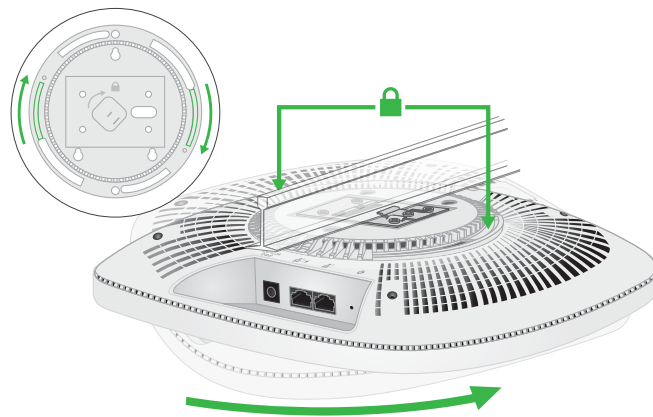
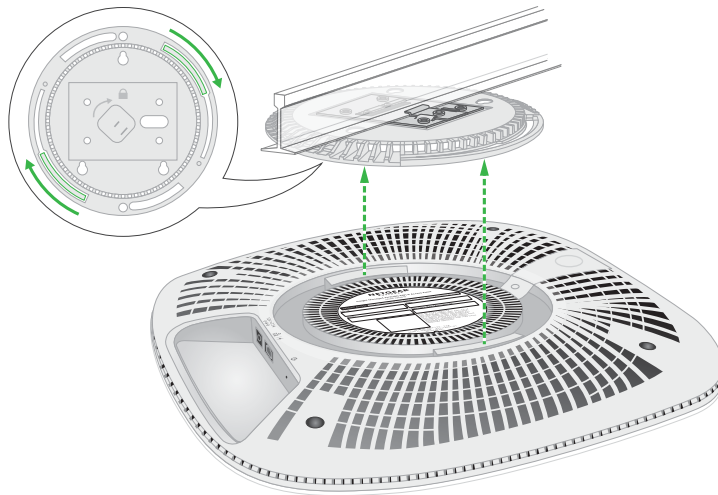

8. Turn the access point clockwise until it locks in the mounting plate.

Insight Managed WiFi 6 AX3000 Access Point Model WAX618

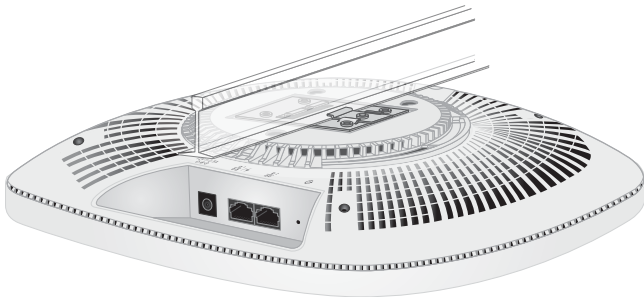
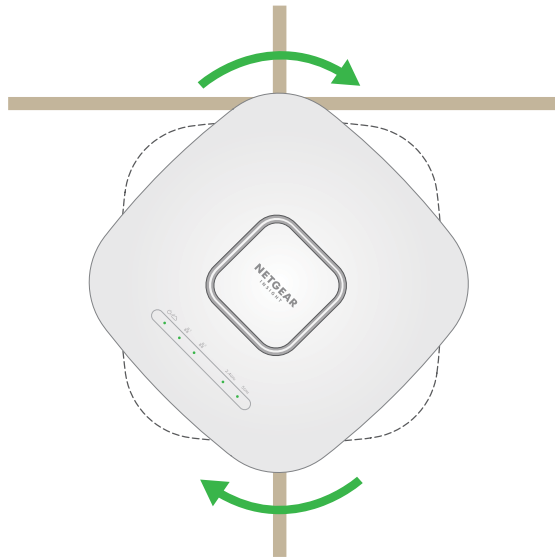

Unmount the access point

CAUTION: Make sure you hold the access point so that it does not drop when you release it from the mounting plate.

To unmount the access point:

1. Find the locking latch by placing your thumb on the center of the LEDs and your finger on the other side of the access point, directly opposite the thumb.
2. Press and hold the latch down to release the lock and keep the lock open.

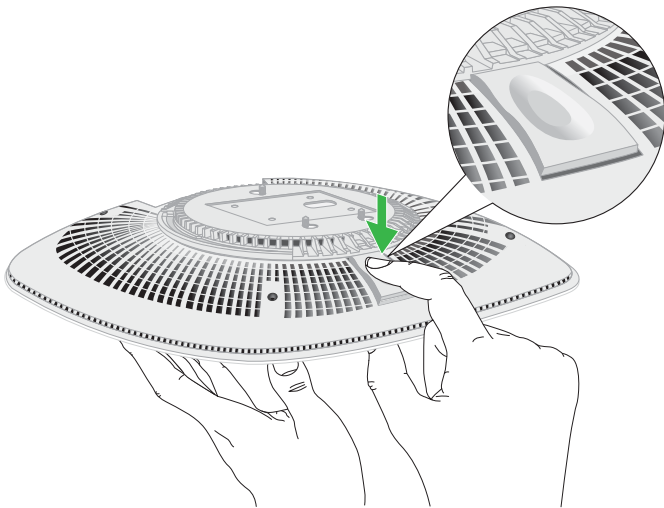

3. Turn the access point counterclockwise until the access point releases from the mounting plate.



4. Remove the access point from the mounting plate.
The mounting plate remains attached to the ceiling or the wall.

