

# Quick Start Guide

## Industrial Connectivity Solutions

**Model Series: N206-XXX-IND, P569-XXX-IND, U325-XXX-IND, N200P-XXX-IND, N455-XXX-IND, N820-XXX-IND**  
See page 2 for a complete model listing.

Tripp Lite's industrial connectivity solutions comply with the IP44 standard for protection against water intrusion on all sides, as well the IP68 standard for protection against invasive dust, dirt and sand, and submersion in up to 1.5 m of water for up to 60 minutes.

**Note:** Certain product combinations are needed to achieve IP44 and/or IP68 standards. See section 4. **Product Combinations for IP44 and IP68 Protection** for more information. IP68 Protection rating is based on manufacturer's guarantee.

Este guía esta disponible en español en la página de Tripp Lite:  
[tripplite.com/support](http://tripplite.com/support)

Ce guide est disponible en français sur le site Web de Tripp Lite :  
[tripplite.com/support](http://tripplite.com/support)

Русскоязычная версия настоящего краткого руководства представлена на веб-сайте компании Tripp Lite по адресу: [tripplite.com](http://tripplite.com)

### WARRANTY REGISTRATION

Register your product today and be automatically entered to win an ISOBAR surge protector in our monthly drawing!

[tripplite.com/warranty](http://tripplite.com/warranty)



1111 W. 35th Street, Chicago, IL 60609 USA • [tripplite.com/support](http://tripplite.com/support)

Copyright © 2020 Tripp Lite. All rights reserved.

## Table of Contents

<b>Industrial Connectivity Solutions Complete Product Listing</b>	<b>3</b>
<b>1. N206-SB01-IND Surface Box Dimensions</b>	<b>4</b>
<b>2. Industrial Bulkhead Coupler Installation (N206-BC01-IND, U325-000-IND, P569-000-FF-IND, N455-BC01-IND)</b>	<b>5</b>
<b>3. Industrial Keystone Jack Installation (N206-KJ01-IND)</b>	<b>7</b>
<b>4. Product Combinations for IP44 and IP68 Protection</b>	<b>10</b>
<b>Warranty and Product Registration</b>	<b>11</b>

## Industrial Connectivity Solutions

### Complete Product Listing

#### Industrial Faceplates

N206-FP01-IND (1 Cutout)  
N206-FP02-IND (2 Cutouts)  
N206-FP04-IND (4 Cutouts)

#### Industrial Surface Mount Box

N206-SB01-IND

#### Bulkhead Couplers and Keystone Jacks

N206-BC01-IND  
(Cat5e/6 Bulkhead Coupler)  
N206-KJ01-IND (Keystone Jack)  
U325-000-IND (USB 3.0 Coupler)  
P569-000-FF-IND (4K HDMI Coupler)  
N455-BC01-IND  
(Multimode Fiber LC/LC Coupler)

#### Industrial Patch Cables & 4PPoE (90W) Cables

N206-PC03-IND  
(3 ft. Cat5e/6 Patch Cable)  
N206-PC10-IND  
(10 ft. Cat5e/6 Patch Cable)  
N206-PC16-IND  
(16 ft. Cat5e/6 Patch Cable)  
N206-PC23-IND  
(23 ft. Cat5e/6 Patch Cable)  
N206-PC33-IND  
(33 ft. Cat5e/6 Patch Cable)  
N206-PC50-IND  
(50 ft. Cat5e/6 Patch Cable)  
N200P-003BL-IND  
(3 ft. Cat6 4PPoE Cables)  
N200P-010BL-IND  
(10 ft. Cat6 4PPoE Cables)  
N200P-016BL-IND  
(16 ft. Cat6 4PPoE Cables)  
N200P-023BL-IND  
(23 ft. Cat6 4PPoE Cables)  
N200P-033BL-IND  
(33 ft. Cat6 4PPoE Cables)

#### Industrial Patch Cables & 4PPoE (90W) Cables (continued)

N200P-050BL-IND  
(50 ft. Cat6 4PPoE Cables)

#### Industrial USB 3.0 Cables

U325-003-IND (3 ft. USB 3.0 Cable)  
U325-006-IND (6 ft. USB 3.0 Cable)  
U325-010-IND (10 ft. USB 3.0 Cable)  
U325-013-IND (13 ft. USB 3.0 Cable)

#### Industrial 4K HDMI Cables

P569-003-IND (3 ft. 4K HDMI Cable,  
1 water-resistant connector)  
P569-006-IND (6 ft. 4K HDMI Cable,  
1 water-resistant connector)  
P569-010-IND (10 ft. 4K HDMI Cable,  
1 water-resistant connector)  
P569-012-IND (12 ft. 4K HDMI Cable,  
1 water-resistant connector)  
P569-003-IND2 (3 ft. 4K HDMI Cable,  
2 water-resistant connectors)  
P569-006-IND2 (6 ft. 4K HDMI Cable,  
2 water-resistant connectors)  
P569-010-IND2 (10 ft. 4K HDMI  
Cable, 2 water-resistant connectors)  
P569-012-IND2 (12 ft. 4K HDMI  
Cable, 2 water-resistant connectors)

#### Industrial Duplex Multimode Fiber Patch Cables

N820-01M-IND  
(1 m LC/LC Fiber Patch Cables)  
N820-02M-IND  
(2 m LC/LC Fiber Patch Cables)  
N820-05M-IND  
(5 m LC/LC Fiber Patch Cables)  
N820-10M-IND  
(10 m LC/LC Fiber Patch Cables)

#### Waterproof Cable Assembly Kit

N206-WK01-IND

# 1. N206-SB01-IND Surface Mount Box Dimensions

Dimensions: [mm] INCHES

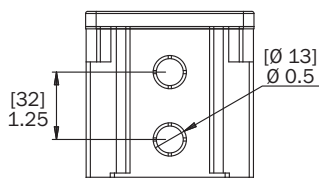
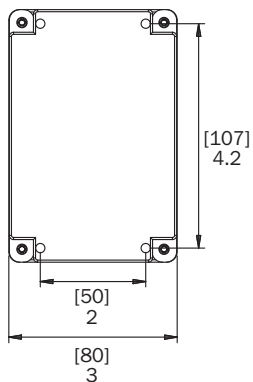
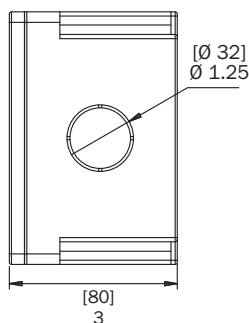
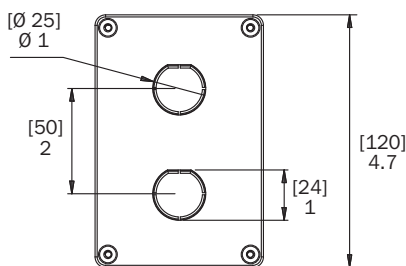
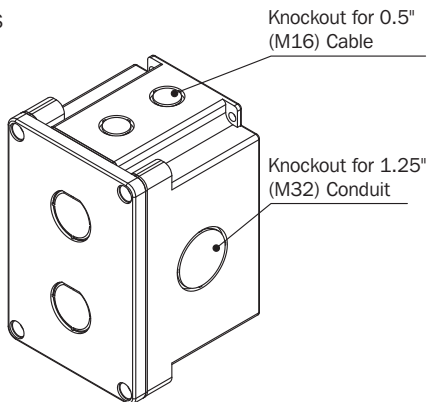

## 2. Industrial Bulkhead Coupler Installation

(N206-BC01-IND, U325-000-IND, P569-000-FF-IND and N455-BC01-IND)

**Note:** USB, HDMI and fiber solutions are also available. Screwdriver not included. Additional tools may be required to remove knockouts.

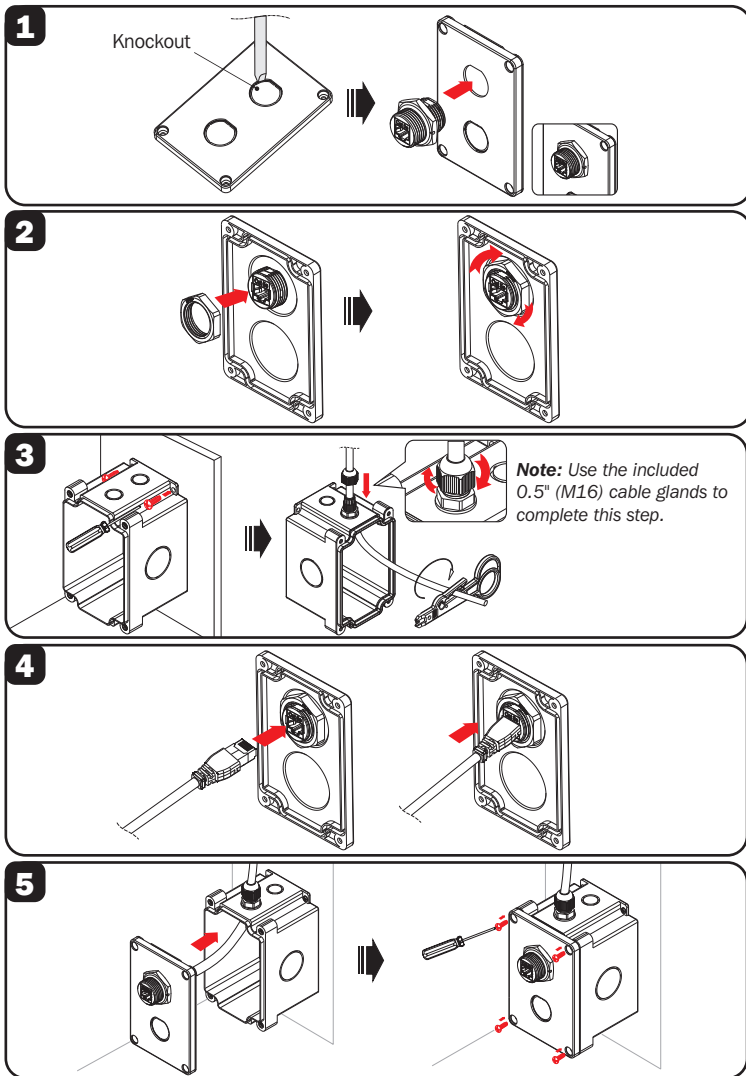

## 2. Industrial Bulkhead Coupler Installation

(N206-BC01-IND, U325-000-IND, P569-000-FF-IND and N455-BC01-IND)

6

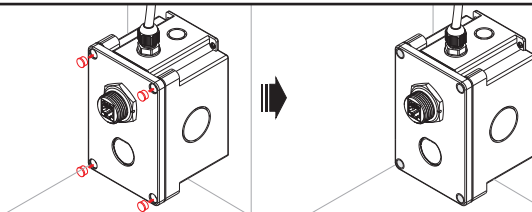

7

For the front mating connection, you can use the N206-PCXX-IND, U325-XXX-IND, P569-XXX-IND, N820-XXX-IND or N200P-XXBL-IND Series industrial cables.

You can also choose to assemble your own cable connection using the N206-WK01-IND waterproof assembly kit.

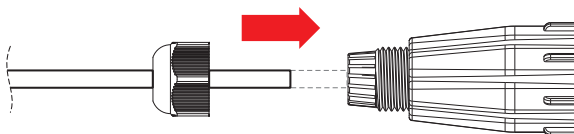

N206-WK01-IND

8

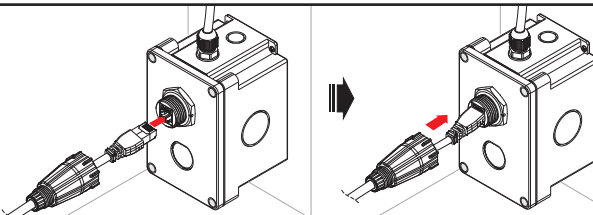

9

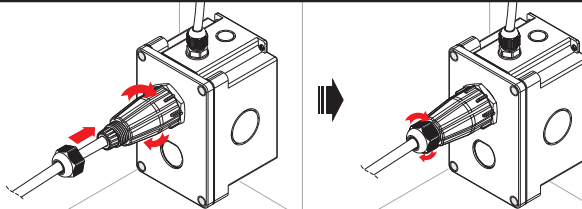

### 3. Industrial Keystone Jack Installation (N206-KJ01-IND)

**Note:** Additional tools may be required to remove knockouts.

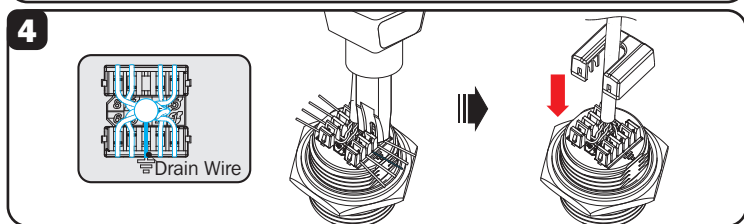
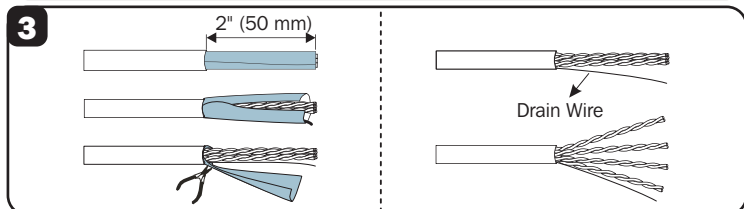
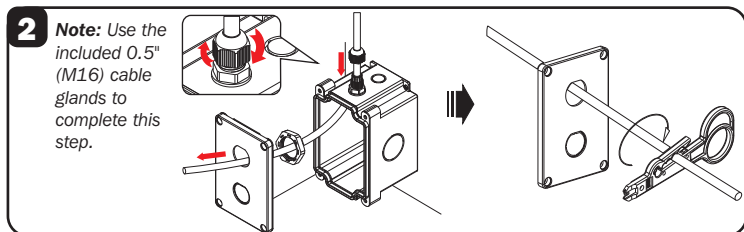
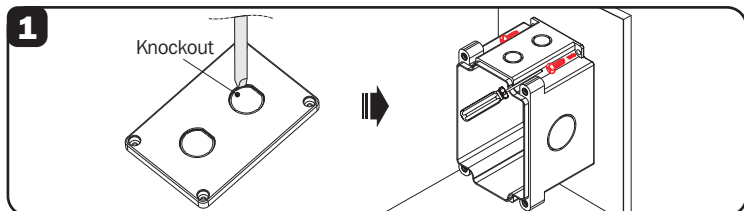

### 3. Industrial Keystone Jack Installation (N206-KJ01-IND)

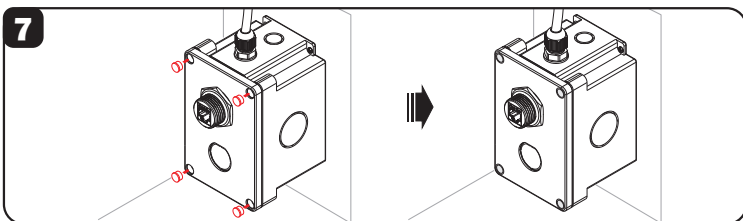
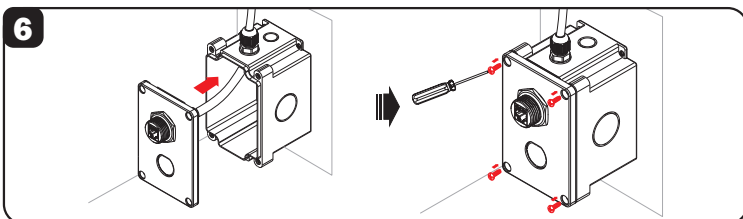
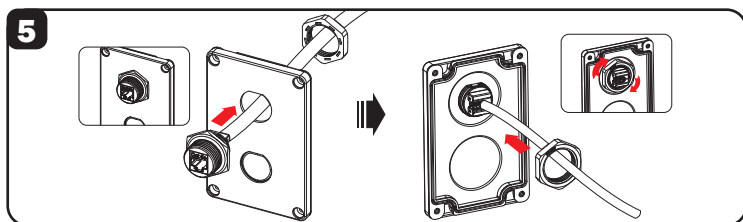

**8** For the front mating connection, you can use N206-PCXX-IND Series industrial cables. You can also choose to assemble your own cable connection using the N206-WK01-IND waterproof assembly kit.

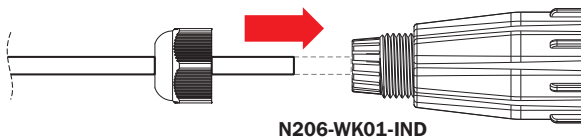



### 3. Industrial Keystone Jack Installation (N206-KJ01-IND)

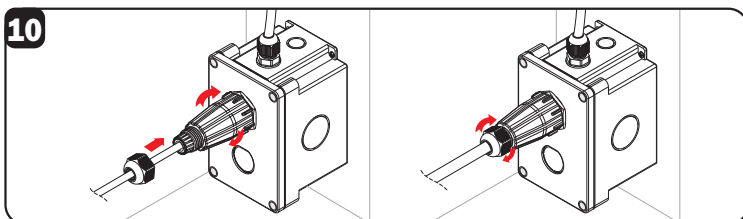
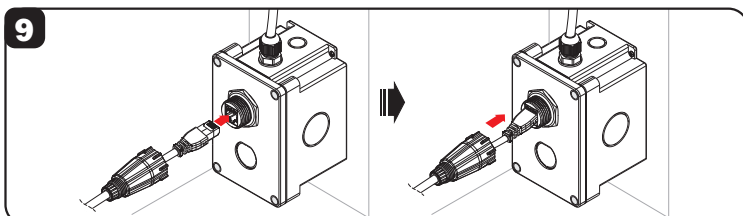

## 4. Product Combinations for IP44 and IP68 Protection

**Note:** For IP68 environments (submersion in up to 1.5 m of water for 60 minutes), the N206-SB01-IND should be used (not the N206-FPXX-IND). IP68 rating of up to 1.5 m of water for up to 60 minutes is based on manufacturer's guarantee.

<b>Faceplate</b>	<b>Bulkhead Couplers/ Keystone Jacks</b>	<b>Industrial Patch Cables/ Industrial USB 3.0 Cables</b>	<b>Waterproof Cable Assembly Kit</b>
N206-FPXX-IND	N206-BC01-IND (Bulkhead Coupler)	N206-PCXX-IND (Cat5e/6 Cable)	N206-WK01-IND
N206-FPXX-IND	N206-KJ01-IND (Keystone Jack)	N206-PCXX-IND (Cat5e/6 Cable)	N206-WK01-IND
N206-FPXX-IND	N206-BC01-IND (Bulkhead Coupler)	N200P-XXX-IND (Cat6 4PPoE Cables)	N206-WK01-IND
N206-FPXX-IND	U325-000-IND (USB 3.0 Coupler)	U325-XXX-IND (USB 3.0 Cable)	
N206-FPXX-IND	P569-000-FF-IND (4K HDMI Coupler)	P569-XXX-IND/ P569-XXX-IND2 (4K HDMI Cable)	
N206-FPXX-IND	N455-BC01-IND (LC/LC Fiber Coupler)	N820-XXM-IND (LC/LC Fiber Cable)	
<b>Surface Mount Box</b>	<b>Bulkhead Couplers/ Keystone Jacks</b>	<b>Industrial Patch Cables/ Industrial USB 3.0 Cables</b>	<b>Waterproof Cable Assembly Kit</b>
N206-SB01-IND	N206-BC01-IND (Bulkhead Coupler)	N206-PCXX-IND (Cat5e/6 Cable)	N206-WK01-IND
N206-SB01-IND	N206-KJ01-IND (Keystone Jack)	N206-PCXX-IND (Cat5e/6 Cable)	N206-WK01-IND
N206-SB01-IND	N206-BC01-IND (Bulkhead Coupler)	N200P-XXX-IND (Cat6 4PPoE Cables)	N206-WK01-IND
N206-SB01-IND	U325-000-IND (USB 3.0 Coupler)	U325-XXX-IND (USB 3.0 Cable)	
N206-SB01-IND	P569-000-FF-IND (4K HDMI Coupler)	P569-XXX-IND/ P569-XXX-IND2 (4K HDMI Cable)	
N206-SB01-IND	N455-BC01-IND (LC/LC Fiber Coupler)	N820-XXM-IND (LC/LC Fiber Cable)	

## Warranty and Product Registration

### Limited Lifetime Warranty

Seller warrants this product, if used in accordance with all applicable instructions, to be free from original defects in material and workmanship for its lifetime. If the product should prove defective in material or workmanship within that period, Seller will repair or replace the product, at its sole discretion. Service under this Warranty can only be obtained by Buyer delivering or shipping the product (with all shipping or delivery charges prepaid) to: Tripp Lite, 1111 W. 35th Street, Chicago, IL 60609. Seller will pay return shipping charges. Visit [tripplite.com/support](http://tripplite.com/support) before sending any equipment back for repair.

THIS WARRANTY DOES NOT APPLY TO NORMAL WEAR OR TO DAMAGE RESULTING FROM ACCIDENT, MISUSE, ABUSE OR NEGLIGENCE. SELLER MAKES NO EXPRESS WARRANTIES OTHER THAN THE WARRANTY EXPRESSLY SET FORTH HEREIN. EXCEPT TO THE EXTENT PROHIBITED BY APPLICABLE LAW, ALL IMPLIED WARRANTIES, INCLUDING ALL WARRANTIES OF MERCHANTABILITY OR FITNESS, ARE LIMITED IN DURATION TO THE WARRANTY PERIOD SET FORTH ABOVE; THIS WARRANTY EXPRESSLY EXCLUDES ALL INCIDENTAL AND CONSEQUENTIAL DAMAGES.

(Some states do not allow limitations on how long an implied warranty lasts, and some states do not allow the exclusion or limitation of incidental or consequential damages, so the above limitations or exclusions may not apply to you. This Warranty gives you specific legal rights, and you may have other rights which vary from jurisdiction to jurisdiction).

WARNING: The individual user should take care to determine prior to use whether this device is suitable, adequate or safe for the use intended. Since individual applications are subject to great variation, the manufacturer makes no representation or warranty as to the suitability or fitness of these devices for any specific application.

### PRODUCT REGISTRATION

Visit [tripplite.com/warranty](http://tripplite.com/warranty) today to register your new Tripp Lite product. You'll be automatically entered into a drawing for a chance to win a FREE Tripp Lite product!\*

\* No purchase necessary. Void where prohibited. Some restrictions apply. See website for details.

### WEEE Compliance Information for Tripp Lite Customers and Recyclers (European Union)



Under the Waste Electrical and Electronic Equipment (WEEE) Directive and implementing regulations, when customers buy new electrical and electronic equipment from Tripp Lite they are entitled to:

- Send old equipment for recycling on a one-for-one, like-for-like basis (this varies depending on the country)
- Send the new equipment back for recycling when this ultimately becomes waste

Use of this equipment in life support applications where failure of this equipment can reasonably be expected to cause the failure of the life support equipment or to significantly affect its safety or effectiveness is not recommended.

The Tripp Lite has a policy of continuous improvement. Specifications are subject to change without notice. Photos and illustrations may differ slightly from actual products.



Manufacturing  
Excellence.

1111 W. 35th Street, Chicago, IL 60609 USA • [tripplite.com/support](http://tripplite.com/support)