

TP-MVD8MV2

8MP HD TwilightVision™ IR VF Turret Network Camera



KEY FEATURES

- ✓ To be used with SMART Series NVR with Turing Vision Cloud
- ✓ 2.8~12mm Motorized Lens
- ✓ Max. 8MP (3840*2160)@20fps
- ✓ **TwilightVision™** technology superior low-light performance
- ✓ Built-in Mic
- ✓ Smart IR, up to 40m (131 ft)
- ✓ Supports 256 G Micro SD card
- ✓ IP67, IK10, WDR



SPECIFICATIONS

CAMERA	
Sensor	1/2.8", 8.0 megapixel, progressive scan, CMOS
Lens	2.8 ~ 12mm, AF automatic focusing and motorized zoom lens
Angle of view (H)	107.4° ~ 29.2°
Angle of View (V)	54.2° ~ 16.3°
Angle of View (O)	111.0° ~ 33.1°
Adjustment angle	Pan: 0° ~ 360° Tilt: 0° ~ 75° Rotate: 0° ~ 360°
Shutter	Auto/Manual, 1 ~ 1/1000000s
Minimum Illumination	Color: 0.003Lux (F1.6, AGC ON) 0Lux with IR
Day/Night	IR-cut filter with auto switch (ICR)
Digital Noise Reduction	2D/3D DNR
S/N	>56dB
IR Range	Up to 40m (131ft) IR range
Wavelength	850nm
IR On/Off Control	Auto/Manual
Defog	Digital Defog
WDR	120dB

VIDEO & AUDIO	
Video Compression	Ultra 265,H.265, H.264, MJPEG
H.264 code profile	Baseline profile, Main Profile
Frame Rate	Main Stream: 8MP (3840*2160), Max 20fps;5MP (3072*1728), Max 30fps; 4MP (2560*1440), Max30fps; 1080P (1920*1080), Max 30fps; Sub Stream: 1080P (1920*1080), Max 30fps;720P (1280*720), Max 30fps; D1 (720*576), Max 30fps; 640*360,Max 30fps; 2CIF(704*288), Max 30fps; CIF(352*288), Max 30fps; Third Stream: D1 (720*576), Max 30fps; 640*360,Max 30fps; 2CIF(704*288), Max 30fps; CIF(352*288), Max 30fps;
Video Bit Rate	128 Kbps~16 Mbps
OSD	Up to 8 OSDs
Privacy Mask	Up to 4 areas
ROI	Up to 8 areas
Motion Detection	Up to 4 areas

IMAGE	
White Balance	Auto/Outdoor/Fine Tune/Sodium Lamp/Locked/Auto2
Digital noise reduction	2D/3D DNR
Smart IR	Support
Flip	Normal/Vertical/Horizontal/180°/90°Clockwise/90°Anti-clockwise
Dewarping	Supported
HLC	Supported
BLC	Supported

AUDIO	
Audio Compression	G.711
Two-way audio	Supported
Suppression	Supported
Sampling Rate	8KHZ

STORAGE	
Edge Storage	Micro SD, up to 256GB
Network Storage	ANR

INTELLIGENCE	
Smart intrusion Prevention	Cross line, intrusion, enter area detection
Compatible NVR	Turing SMART NVR: TR-MR(P) models

EVENTS	
Basic Detection	Motion detection, tampering alarm, audio detection
General Function	Watermark, IP address filtering, tampering alarm, alarm input, alarm output, access policy, ARP protection, RTSP authentication, user authentication
Protocols	IPv4, IGMP, ICMP, ARP, TCP, UDP, DHCP, PPPoE, RTP, RTSP, RTCP, DNS, DDNS, NTP, FTP, UPnP, HTTP, HTTPS, SMTP, 802.1x, SNMP, QoS
Compatible Integration	ONVIF (Profile S, Profile G, Profile T), API
Web Browser	Plug-in required live view: IE9+, Chrome 41 and below, Firefox 52 and below

INTERFACES	
Built-in Mic	Supported
Network	1 RJ45 10M/100M Base-TX Ethernet

CERTIFICATIONS	
Certifications	CE: EN 60950-1 UL: UL60950-1 FCC: FCC Part 15

GENERAL	
Power	DC 12V±25%, PoE (IEEE 802.3af) Power consumption: Max 9.0W
Dimensions (Ø x H)	Ø129 x 110mm (Ø5.1" x 4.3")
Net Weight	0.69kg (1.52lb)
Material	Metal
Working Environment	-30°C ~ 60°C (-22°F ~ 140°F), Humidity: ≤95% RH (non-condensing)
Storage Environment	-30°C ~ 60°C (-22°F ~ 140°F), Humidity: ≤95% RH (non-condensing)
Surge Protection	6KV
Ingress Protection	IP67
Vandal Resistant	IK10
Reset Button	Supported



DIMENSIONS

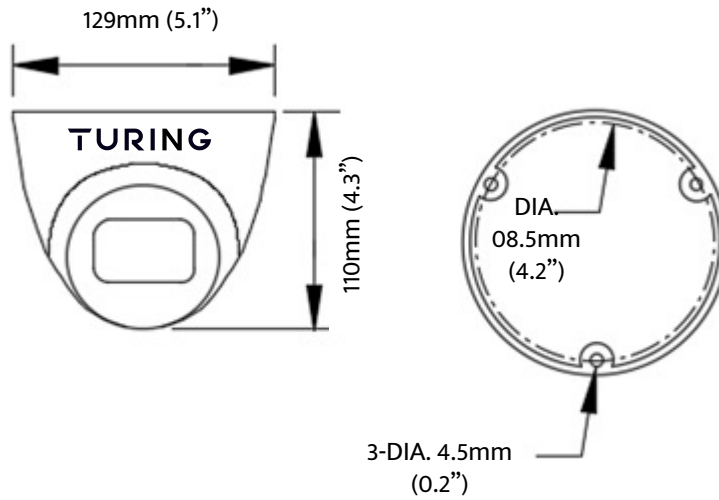

MOUNTING

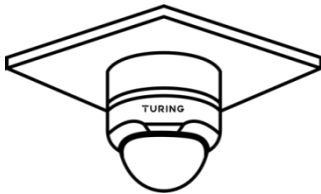

Junction Box: TP-VDJB

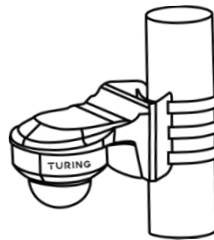

Pole Mount: TP-UDPM
Wall Mount: TP-VDWM
WM w/ Junc. Box: TP-VDWJ

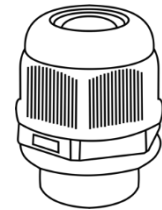

Optional Cable Gland:
TP-UWPJ



Wall Mount: TP-VDWM
w/ Junction Box: TP-VDWJ

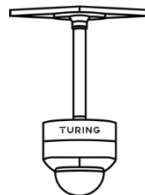

Pendant Mount: TP-AIPMB
Junction Box: TP-VDJB
Optional Extensions: TP-IPME2 (9") &
TP-IPME5 (22")



BETTER SAFETY, BETTER SECURITY WITH NEXT LEVEL AI

Turing AI's People Analytics provides better safety and security through utilizing Face Search*, Person Attribute Search*, Person History*, and Person of Interest* Alerts & Notifications.

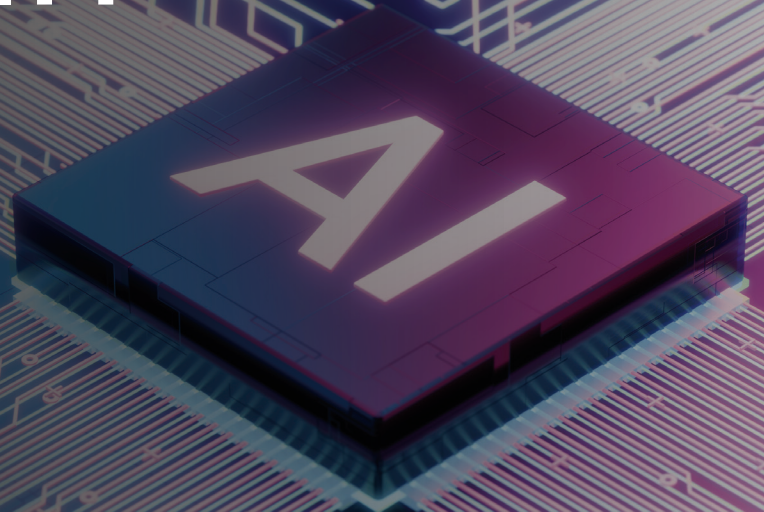

Three Levels of AI

LEVEL ONE: OBJECT DETECTION

Person

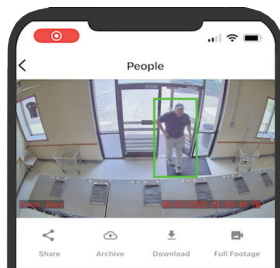

LEVEL TWO: IDENTITY DETECTION

Tim S.

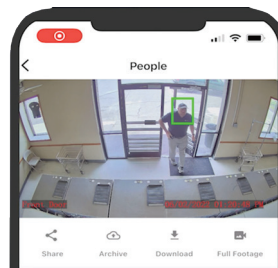

LEVEL THREE: ATTRIBUTE DETECTION

Hat /
Black Shirt /
Grey Pants

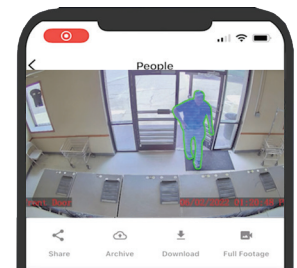

TURING

Turing AI is committed to ensure its platform comply with applicable regulations. Activation depends on state regulations and the compliance with Biometric Information Protection Act (BIPA). Please refer to our [privacy policy](#), and [compliance availability](#).

*Activation depends on state regulations and the compliance with Biometric Information Protection Act (BIPA). Please refer to our [privacy policy](#).

Visit our website to learn more at turing.ai

Simplify Your Security Workflow with Award-Winning AI

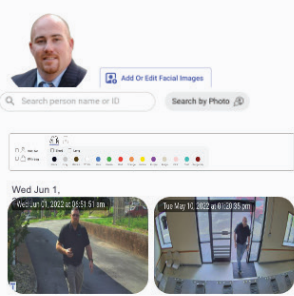

Identity Search uses Name, ID and Face

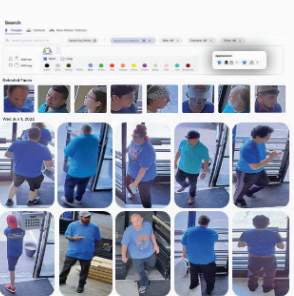

Find People that Match Selected Attributes

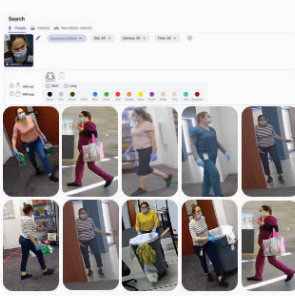

View all people that have been captured to speed up investigations

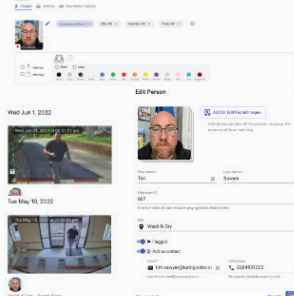

Intelligent alert based on person and vehicle of interest

Privacy

Turing AI's People Analytics solution is built with optimal safety and security. Any historical data your system collects is encrypted and securely stored within your organization.

Turing AI provides customers complete control over their Turing Vision Platform. Face Search* and People Attribute Search* takes administrative approval to be activated. Face Search* is not available and may not be used in the States of Illinois, Texas, or Washington. By enabling Face Search*, I agree not to use Face Search* in Illinois, Texas or Washington. If I do use Face Search* in Illinois, Texas or Washington, I agree to indemnify and hold harmless Turing for any claims or liability arising from or related to my use of Face Search* in Illinois, Texas, or Washington. I further acknowledge that the data generated by Face Search* may be subject to certain Data Protection Laws and Biometric Privacy Laws and agree that I will comply with all applicable Data Protection Laws and Biometric Privacy Laws relating to the deployment and use of Face Search*.

Data Protection Laws include, without limitation, (i) the California Consumer Privacy Act of 2018 (CCPA), as amended and replaced by the California Privacy Rights Act of 2020, (ii) the Virginia Consumer Data Protection Act (VCDPA), (iii) the Colorado Privacy Act (CPA), (iv) the Connecticut Data Privacy Act (CTDPA), (v) the Utah Consumer Privacy Act (UCPA), (vi) the Canada Personal Information and Electronic Documents Act (PIPEDA), (vii) the Alberta Personal Information Protection Act (Alberta PIPA), (viii) the British Columbia Personal Information Protection Act (BC PIPA), (ix) the Quebec Act Respecting the Protection of Personal Information in the Private Sector, (x) the Quebec Information Technology Act and (xi) such other comprehensive data protection laws that may be enacted and during my use of the services and would apply to my use of the services. Biometric Privacy Laws include, without limitation, (i) the Illinois Biometric Information Privacy Act (BIPA), (ii) Washington statute RCW 19.375, (iii) the Texas Capture or Use of Biometric Identifiers (CUBI), (iv) New York City Admin. Code § 22-1201 and (v) such other biometric privacy laws that may be enacted during my use of the services and would apply to my use of the services.

Compliance and Availability

Turing AI is committed to ensure its platform comply with applicable regulations. The following features are not available in the jurisdiction listed in the table below.

Jurisdiction	Face Search	Person of Interest Notifications
Illinois	X	X
Texas	X	X
Washington	X	X
Baltimore	X	X
Portland	X	X

TURING

Turing AI is committed to ensure its platform comply with applicable regulations. Activation depends on state regulations and the compliance with Biometric Information Protection Act (BIPA). Please refer to our [privacy policy](#), and [compliance availability](#).

*Activation depends on state regulations and the compliance with Biometric Information Protection Act (BIPA). Please refer to our [privacy policy](#).

Visit our website to learn more at turing.ai

TRANSFORM YOUR SAFETY, SECURITY, AND OPERATIONS

A SMART FLEXIBLE CLOUD-BASED VIDEO SECURITY PLATFORM

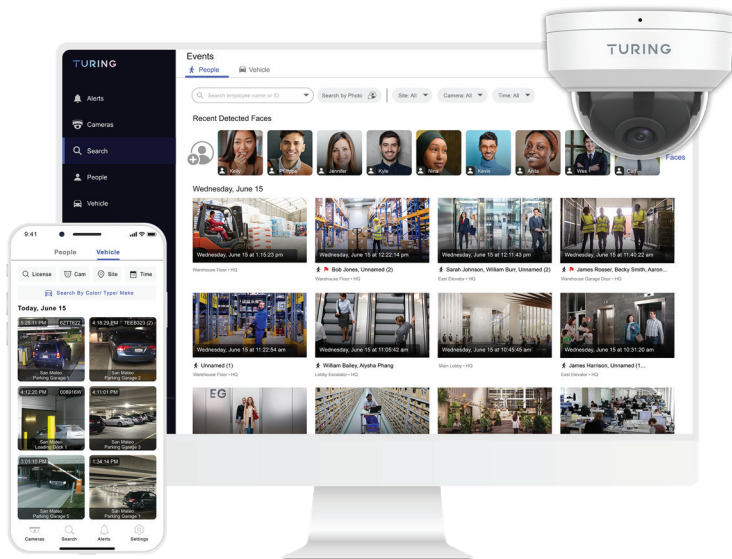

Turing Vision is the industry-leading safety and security video platform. Turing Vision's AI-enabled, cloud-based platform allows you to search, be alerted, and analyze detection patterns across multiple locations. Turing Vision allows you to improve operational efficiencies, increase safety, and get the most out of your camera infrastructure investments.



Find, Capture, and Send Security Clips in Seconds

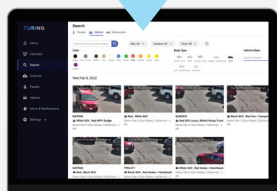

CLICK TO VIEW VIDEO

Easily Access Multiple Sites from Anywhere and on Any Device

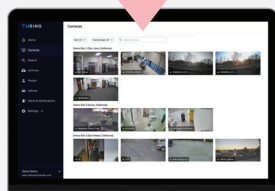

CLICK TO VIEW VIDEO

Flexible Integration with New and Existing IP Cameras

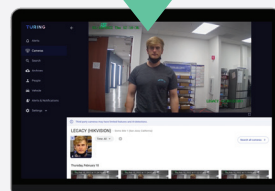

CLICK TO VIEW VIDEO

Manage and Upgrade Your Systems and Firmware Remotely

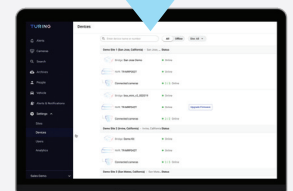

CLICK TO VIEW VIDEO

TURING

Visit our website to learn more at turing.ai

TURING VISION CORE AI LICENSE

CORE FEATURES	SMART SERIES
FAST AND EASY SECURITY WORKFLOW	
Live view and replay camera recording from anywhere*	✓
Smart Alert: Setup alerts based on one or more face recognition, flagged or specific license plates, or specific vehicle attributes like colors, make, body type.	✓
Basic Alert: Alerts when vehicles or people are detected to text message, email and/or mobile push notifications.*	✓
Cloud Archive: archive important detection event video clips or snapshot indefinitely in the cloud.	✓
Share alert, event and archive with law enforcement, legal investigation, insurance and virtually anyone instantly.	✓
CLOUD-BASED DEVICE MANAGEMENT	
Bridge and NVR Management, OTA Firmware Upgrade / Remote Restart from anywhere*	✓
OTA Camera Firmware Upgrade, setup detection region and edit camera settings from anywhere	✓
System Dashboard: Camera and Device status	✓
ADVANCED AI	
Face Search: Search person events by uploading a photo with a face, or by a recently detected face. Flag or name detected faces for future alerts. Preload faces for flagging and alerts. ¹	✓
Person Attribute Search ^{**} : Search person events by the color of the attire, long/short sleeves, gender, items like hat or bag.	✓
Vehicle Attribute Search: Search by vehicle color, make and body type	✓
Vehicle License Plate Search: Search by license plate number. Flag detected license plates for future alerts. Set up Vehicle License Plate Database for customizing Smart alert (alert and do not alert list).	✓
Non-Motor Vehicle: Search events with non-motor wheeled objects	✓
WARRANTY	
Turing AI warranty covers hardware with active CORE AI licenses. ^{***}	✓

Multi-Year License Subscription

DURATION	CORE AI	WARRANTY ^{***}	DURATION	CORE AI	WARRANTY ^{***}
1 YEAR CORE	✓	✓	5 YEAR CORE	✓	✓
3 YEAR CORE	✓	✓	10 YEAR CORE	✓	✓



*Included in the Basic Subscription

**Upcoming features

***Warranty included and covers hardware with active CORE AI licenses

¹Activation depends on state regulations and the compliance with Biometric Information Protection Act (BIPA).

Please refer to our privacy policy.