



Complete Manual for the

HuddleSHOT

All-in-One Conferencing Camera

Document 411-0037-30 Rev A
August 2019

Contents

Overview	1
What's in this Guide	1
Features	1
Unpacking the Camera	2
A Quick Look at the Camera	3
Front of the Camera	3
Back of the Camera	3
Installation	4
Don't Void Your Warranty!	4
Before You Install the Camera	4
Installing the Wall Mount	5
Cabling Notes	5
About Echo Cancellation	6
Basic Connections for Conferencing or Sharing Content	6
Connections for Conferencing Using a Room Audio System	7
Connections for Using the Camera as a Sound Bar	7
Installing the Camera	8
Powering Up the Camera	8
Status Indicator Light	8
Multifunction Button	8
Using the Remote	9
Installing the Batteries	9
Pairing the Remote to the Camera	10
Unpairing the Remote	10
Other Things to Know About the Remote	10
Using the Web Interface	11
Browser Support	11
Getting the Camera's IP Address	11
User Access	12
Administrative Access	13
System Administration	14
Configuring the Camera for Your Network	14
For Non-DHCP Environments: Configuring the Device with a Static IP Address for Initial Installation	14
Optional For DHCP Environments: Changing from a DHCP Address to a Static IP Address	16
Changing the Camera's Hostname	17
Specifying Time Zone and NTP Server	18
Configuring Security Settings	19
Setting Passwords and Access	19
Enabling or Requiring HTTPS	20

Disabling Telnet Access	20
Adding Room Information to the Screen	21
Saving (Exporting) or Restoring (Importing) a Configuration	21
Rebooting the Camera	23
Installing a Firmware Update	24
Installing a Firmware Update for the Connected Microphone	25
Contacting Vaddio Technical Support	26
Viewing Diagnostic Logs	26
Configuring Camera Behavior	27
Configuring Streaming Behavior	27
Enabling or Disabling Streaming	27
Viewing a Stream	28
Configuring USB Streaming	28
Setting up IP Streaming in Easy Mode	29
Setting up IP Streaming in Custom Mode	30
RTSP Streaming Protocol and URL	31
Configuring RTMP Streaming	32
Changing MTU	34
Managing Audio	35
Muting All Audio Inputs Together	35
Controlling Volume and Muting Per Input or Output	35
Adjusting Performance for Larger Rooms	36
Fine-Tuning Microphone Performance	37
Using the Camera as a Sound Bar	38
Setting up Macros and Triggers	39
Writing and Editing Macros	40
Testing Macros	41
Assigning Macros to Triggers	42
Testing Triggers	43
Setting Other System Behaviors	44
Telnet Serial Command API	45
camera home	46
camera ccu get	46
camera ccu set	47
camera zoom	48
camera dewarp	48
camera color-compensation	49
camera led	49
camera standby	50
audio volume	51
audio mute	52

video mute	53
trigger	53
streaming settings get	54
streaming ip enable	55
network ping	55
network settings get	56
system reboot	56
system factory-reset	57
version	57
history	58
help	58
exit	58
Specifications	59
Troubleshooting and Care	60
Power and Control	60
Video and Streaming	60
Audio	61
Remote	61
Restoring Default Camera Settings	61
Operation, Storage, and Care	62
Glossary	63
Compliance and Conformity Statements	67
FCC Part 15 Compliance	67
ICES-003 Compliance	67
European Compliance	68
Warranty and Return Policy	69
Photo Credits	73
Index	74

Overview

This guide covers the HuddleSHOT all-in-one conferencing camera – a fixed camera with integrated audio:

- HuddleSHOT camera, North America – 999-50707-000 (black); 999-50707-000G (gray)
- HuddleSHOT camera, Europe and UK – 999-50707-001 (black); 999-50707-001G (gray)
- HuddleSHOT camera, Australia and New Zealand – 999-50707-009 (black); 999-50707-009G (gray)



What's in this Guide

This guide covers

- Unpacking
- Physical features
- Installation
- Controlling the camera using the IR remote
- Web interface: System administration and performance/behavior configuration
- Specifications
- Troubleshooting
- Warranty and compliance/conformity information

Features

- Intuitive operation with attractive, streamlined remote control
- Simultaneous uncompressed USB 3.0 and IP (H.264) video at resolutions up to 1080p/60 with full-duplex audio streaming
- 110° HFOV at 1x with full dewarping; 125° HFOV with no dewarping
- Selectable 1x, 1.5x, or 2x zoom with dewarping option
- Easy configuration, system administration, and remote management via web interface
- Integrated stereo speakers and phased microphone array
- Advanced network security features
- Audio input for Vaddio TableMIC or other microphone with EasyMic connectivity
- Universal Video Class (UVC) and Universal Audio Class (UAC) drivers supported in Windows®, Mac® OS, and Linux operating systems, compatible with most UC conferencing applications

Unpacking the Camera

Make sure you have received all the items you expected.

Download manuals, dimensional drawings, and other information from www.legrandav.com.

HuddleSHOT, North America – 999-50707-000 (black), 999-50707-000G (gray)

HuddleSHOT, Europe/UK – 999-50707-001 (black), 999-50707-001G (gray)

HuddleSHOT, Australia/New Zealand – 999-50707-009 (black), 999-50707-009G (gray)

- HuddleSHOT camera
- Bluetooth remote control
- AAA batteries, qty. 2
- PoE/PoE+ power injector with AC cord set(s)
- USB 3.0 Type A to Type C cable, 6 ft. (1.8m)
- Cat-5e cable, 10 ft. (3 m)
- Wall mount with mounting hardware
- Quick Start Guide



A Quick Look at the Camera

This section covers the physical features of the camera.

Front of the Camera



Camera – The HuddleSHOT camera offers 1x, 1.5x, and 2x zoom levels.

Status light – The illuminated ring around the lens bezel indicates the camera's current state. The status light can be turned off in the administrative web interface.

Note

By default, the camera's status indicator light is active during normal operation; however, it can be configured to remain off when the camera is powered up. The camera may be sending video even if the light is off.

Left and right speakers – Far-end audio, or content audio when using Sound Bar Mode.

Integrated microphones – No external microphone needed in the typical huddle room, interview room, or other small space. Echo-canceling microphones pick up the voices of participants up to 10 ft. (3 m) away.

Back of the Camera



Network/PoE+ – RJ-45 connector. Connect to the Power and Data Out port of the PoE+ power injector.

USB 3.0 – USB type C connector. Connect to a computer for use with soft conferencing applications. Provides uncompressed USB 3.0 stream.

EasyMic – RJ-45 connector. Connect to a TableMIC or other microphone with EasyMic connectivity.

Multifunction button – Momentary pushbutton; used to return from standby, display IP address, pair with a remote, and restore factory defaults.

Installation

This section covers:

- Selecting the location for the camera
- Installing the mount
- Connection diagrams
- Connecting and mounting the camera

And a required safety note here:

Note

PoE type networks connected to this equipment are for intra-building use only and should not be connected to lines that run outside of the building in which this product is located.

Don't Void Your Warranty!

Caution

This product is for indoor use. Do not install it outdoors or in a humid environment without the appropriate protective enclosure. Do not allow it to come into contact with any liquid.

Do not install or operate this product if it has been dropped, damaged, or exposed to liquids. If any of these things happen, return it to Vaddio for safety and functional testing.

Before You Install the Camera

Things to keep in mind when deciding where to install the camera:

- Consider camera viewing angles, lighting conditions, line-of-sight obstructions, and in-wall obstructions where the camera is to be mounted.
- Ensure that the camera will point away from the ceiling and lights. The camera will not perform well if it is pointed toward a light source such as a light fixture or window.

Prepare for a successful installation:

- Be sure you can identify all cables correctly.
- Check Cat-5 cables for continuity.
- Talk to the network administrator. If installing the camera in a non-DHCP network (one that does not automatically assign IP addresses), you will need to configure the camera with a static IP address as directed by the network administrator.

Installing the Wall Mount

The camera is shipped with a wall mount. Other mounting options are available as well. Contact us if you don't have the camera mount you need.

You can install the camera wall mount to a 2-gang wall box or directly to the drywall.

- If you mount it to drywall, use the wall anchors provided with the wall mount.
- If you mount it to a wall box, use the cover plate screws supplied with the wall box.

If you install the camera wall mount to drywall, use the wall anchors provided with the mount.

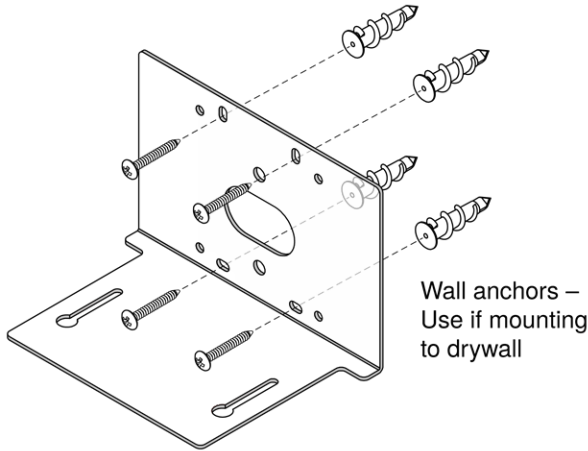

Cabling Notes

Caution

When building cables for Vaddio products, do not use pass-through RJ-45 connectors. If they are crimped incorrectly, they can cause intermittent connections and degrade signal quality. Incorrectly crimped pass-through connectors can also damage the connectors on the product, which will void your warranty.



Intact – will make reliable contact with cable connector

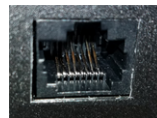

Damaged – Bent contact fingers will NOT make reliable contact with cable connector

Use Cat-5e or better cable. We recommend using high-quality connectors and a high-quality crimping tool. We recommend shielded cabling if the cables will be coiled, run tightly with other cables, or placed close sources of electromagnetic interference such as power lines.

Caution

Check your cables. Connecting a cable to the wrong port or using the wrong pin-out can result in equipment damage and will void the warranty.

Pro Tip

Label all cables at both ends.



About Echo Cancellation

When a microphone picks up the audio from a speaker (far-end audio) during a conference, it sends the far-end audio back to the participants at the far end, creating an echo. Acoustic echo cancellation prevents this.

Here's how it works:

1. The speaker feeds the far-end audio into the room. This signal also goes to the audio processor as the reference that needs to be canceled.
2. The audio processor inverts the signal and sends it to the microphone.
3. The sum of the audio that the microphone picks up from the speaker and the inverted signal is 0: The echo is canceled.

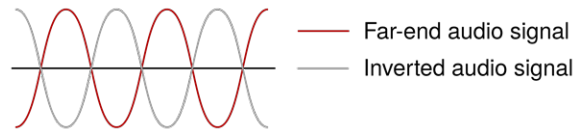

With the audio from the speaker canceled out, the audio from the microphone includes only the sounds originating at your end of the conference.

Basic Connections for Conferencing or Sharing Content

This diagram shows a basic conferencing configuration for the HuddleSHOT all-in-one conferencing camera. A participant's laptop provides USB connectivity and the HDMI output to the room's display. The optional TableMIC microphone, shipped with a 25 ft (7.6 m) cable, allows for more flexibility in the room layout. This system provides acoustic echo cancellation, with or without the TableMIC microphone.

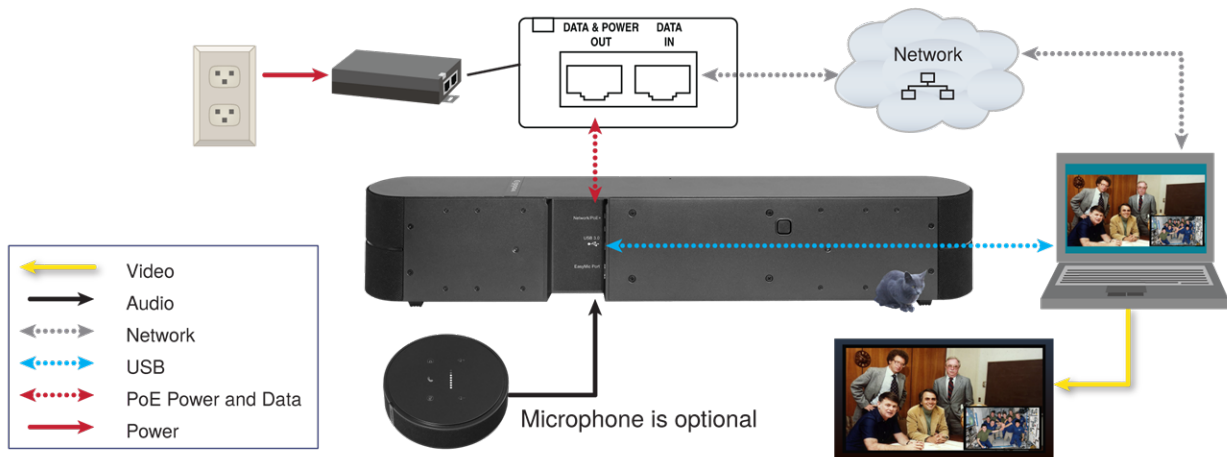

Connections for Conferencing Using a Room Audio System

This diagram shows a setup for a room with an audio system. The HuddleSHOT camera's built-in microphones are used and far-end audio is routed to the room's speakers, using the HuddleSHOT EasyMic adapter.

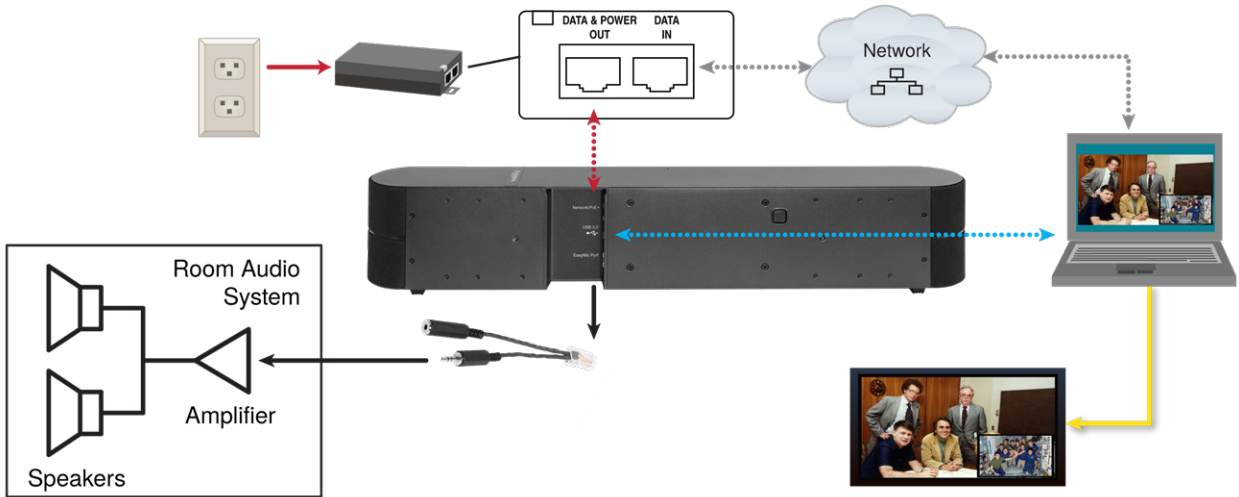

Connections for Using the Camera as a Sound Bar

This diagram shows the HuddleSHOT camera used as a sound bar for the display. Audio from the DVD or other external device is routed from the display to the camera's speakers using the HuddleSHOT EasyMic adapter. The display's built-in speakers are not used.

Note

The computer in this connection diagram is not required for sound bar mode.

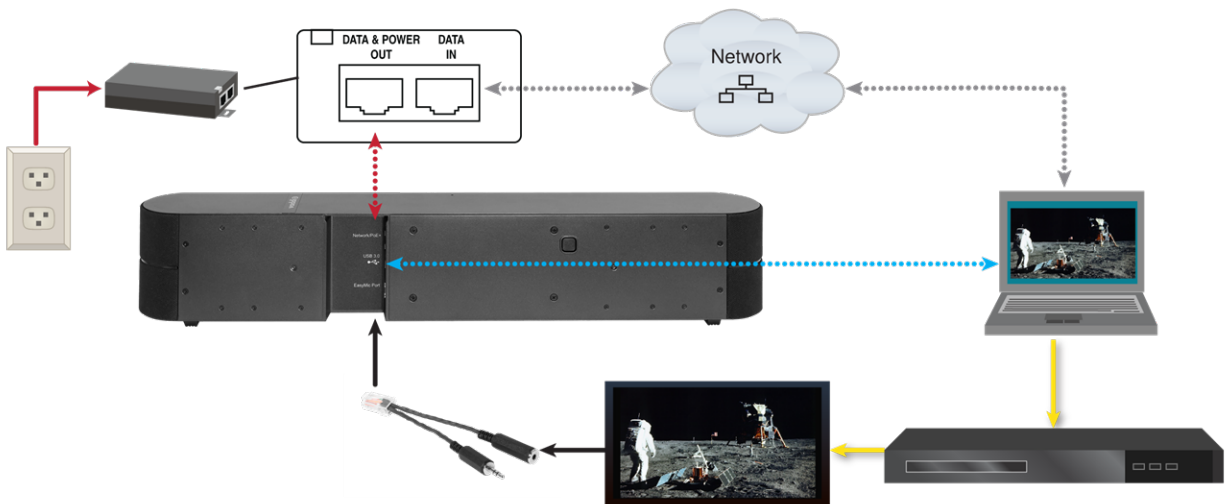

Installing the Camera

Do not tighten the screws securing the camera to the wall mount until you are able to access the camera's web interface. You will need access to the button on the back of the camera to pair the remote and camera or to display the camera's IP address in the USB stream.

Caution

If installing a TableMIC microphone with the camera, be sure you can identify the cables correctly. Connecting a cable to the wrong port can result in equipment damage and void the warranty.

1. Route the cables through the opening in the mounting shelf and connect them to the camera.
2. Place the camera on the mount.
3. Attach the camera to the mount using the mounting screws supplied with the camera, but do not fully tighten the screws.

Powering Up the Camera

Connect camera power. The camera will initialize. This takes a minute or two. When an image is available, the camera is ready to accept control information.

Status Indicator Light

The light in the camera's base indicates its current state.

- Purple – Initializing
- White – Camera is active
- Red – Audio is muted
- Blinking red – Video is muted
- Yellow/green – Firmware update is in progress
- Blinking cyan – Remote pairing mode
- Blinking blue – Bluetooth error
- Different color on each blink – Disco mode! Everybody dance!
(We have never actually observed this mode. If your camera does this, please contact us and describe how you induced this behavior.)

Caution

Do not remove power or reset the camera while the indicator is yellow/green, showing a firmware update in progress. Interrupting a firmware update can make the camera unusable.

Note

By default, the camera's status indicator light is active during normal operation; however, it can be configured to remain off when the camera is powered up. The camera may be sending video even if the light is off.

Multifunction Button

The button on the back of the camera provides these functions:

- **To display the camera's IP address in the video output:** Press momentarily. Press again to dismiss the IP address.
- **To pair the remote with the camera:** Press and hold until the light blinks cyan. Then press the Bluetooth button on the remote.
- **To restore factory default settings:** Press and hold for about 10 seconds during power-up.
- **To return from standby mode:** When the camera is in standby (purple indicator light, or no light), press momentarily to return to the active, full-power state.











Using the Remote

The HuddleSHOT camera's remote provides basic in-conference functionality – zoom, volume control, and muting. You can also use it to get the camera's IP address. When you have the IP address, you can open the camera's web interface.

Before you can use the remote, you will need to:

- Install the batteries
- Pair the remote with the camera

The HuddleSHOT camera is not compatible with Vaddio IR remotes.

	Power button – Set the HuddleSHOT camera to standby mode, or return to full-power mode.	
	Mute button – Mute the microphone(s).	
	Home button – Returns the camera to its stored color settings.	
	Arrow buttons – These buttons have no function on the HuddleSHOT camera, so they're great for fidgeting.	
	Zoom + button – Increase the zoom. The HuddleSHOT camera provides three zoom levels: 1x, 1.5x, and 2x.	
	Zoom - button – Decrease the zoom.	
	Volume + button – Increase the volume from the speakers.	
	Volume - button – Decrease the volume from the speakers.	
	Bluetooth button – Use when pairing the remote with the HuddleSHOT camera.	
	Network button – Display the HuddleSHOT camera's IP address on the video output.	

Installing the Batteries

The remote uses two AAA batteries.

1. Remove the cover from the back of the remote. You may need to press down on the inner edge while sliding it off.
2. Install the batteries as shown in the diagram in the battery opening.

Note

If you install one or both of the batteries backwards, the remote will not work.

3. Slide and snap the cover back into place.

Pairing the Remote to the Camera

The camera does not recognize or respond to the remote until they are paired.

If you do not have access to the administrative web interface:

1. Press and hold the multifunction button on the back of the camera until the indicator light blinks cyan.
2. While the indicator light blinks cyan, press the Bluetooth button on the remote. The camera's indicator light changes to steady white when the pairing is complete. You may need to press the remote's Bluetooth button more than once.
3. If the indicator light changes from blinking cyan to blinking blue, this indicates a Bluetooth error: The pairing was not successful and pairing mode has timed out. Go back to step 1. If the problem persists, contact Vaddio Technical Support.

Note

Any time a Bluetooth error occurs (indicator blinking blue), Vaddio recommends rebooting the camera as soon as feasible. If pairing was successful, the remote remains paired through the reboot process.

If you have access to the administrative web interface:

1. On the Bluetooth page of the web interface, select Pair Remote.
2. When the camera's indicator light blinks cyan, press and hold the Bluetooth button on the remote until the camera's indicator light changes to steady white.

Unpairing the Remote

If you need to unpair the remote from the camera that currently recognizes it, you will need admin access to the camera's web interface. On the Bluetooth page, select Forget Remote.

Other Things to Know About the Remote

Here are some common situations in which the remote can behave in ways you don't expect.

Environments with HuddleSHOT cameras in adjacent rooms – If the remote is currently paired to a camera and within range of that camera, it will not pair with another camera.

The remote goes to standby mode after a brief period of inactivity – The HuddleSHOT remote switches to standby (low-power) mode and the admin web interface shows its status as Disconnected when it is not in use. To return the remote to its normal operating state, press a button. After it returns to its active state, it behaves normally.

The remote is no longer paired after restoring the camera's factory defaults – If you restore factory defaults on the camera, you will need to pair it with the remote again.

Using the Web Interface

The camera's web interface allows control via a network connection, using a browser. Password-protected pages provide administrative access to tasks such as setting passwords, changing the IP address, viewing diagnostics, and installing firmware updates. The user login (or guest access, if it is enabled) provides access to camera controls similar to those available from the IR remote.

You will need to know the camera's IP address to use the web interface. If the IP network has a DHCP server, the camera will get its IP address, gateway and routing information automatically and you will be able to browse to it. If not, you will need to configure the camera to use a static IP address.

Browser Support

We have tested this product with these web browsers:

- Chrome®
- Microsoft® Internet Explorer®
- Safari®
- Firefox®

We test using the browser version available from the vendor at that time. Older versions of these browsers are likely to work, and other browsers may also work.

Getting the Camera's IP Address

You will need to be able to view the camera's USB stream to get the IP address.

1. Connect the camera's USB port to your laptop.
2. Open a stream viewer such as VLC Media Player and view the USB stream (If you use VLC Media Player, this is the "Open Capture Device" option under Media.)

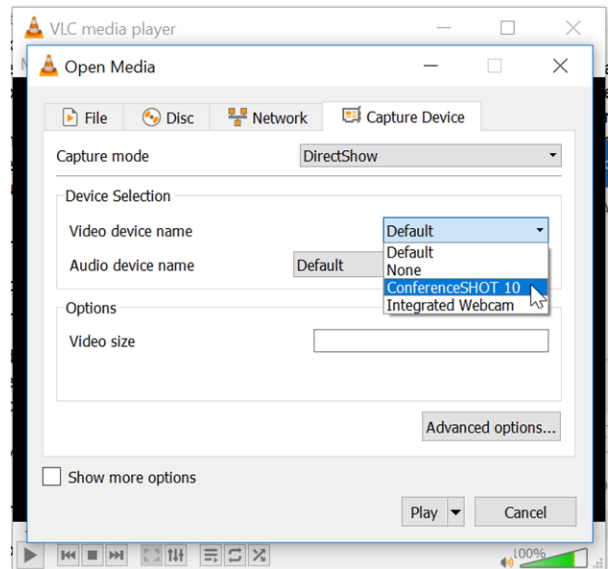
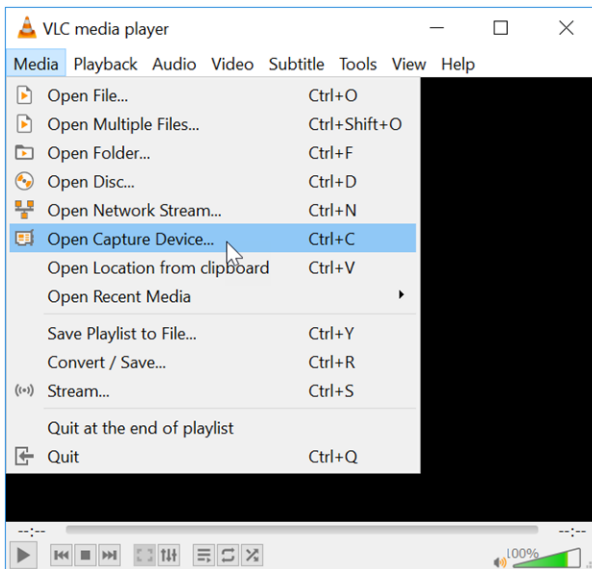

3. Prepare the remote for use, if you have not done so already.
4. Press the Network button on the remote. The USB stream displays the IP address.

If the address is 169.254.1.1:

This is the camera's default IP address. This usually means one of these things:

- The network automatically assigns IP addresses, but the camera is not connected to the network.
- The network does not automatically assign IP addresses, and you need to configure the camera for the network. See [Configuring the Camera with a Static IP Address](#).

Any other IP address means that your camera is available on the network.

If the camera is at another IP address:

Enter the IP address or hostname in your browser's address bar. You may need to enter `http://` or `https://` as a prefix to keep the browser from treating it as a search query.

(Example: `http://10.30.200.125`)

User Access

By default, the web interface opens to the Controls page, but the camera can be configured to require a user login. The default user password is `password`, but this can be changed. Check with the system administrator if the camera's web interface requires you to log in.

Only the operator's page is available with user-level access

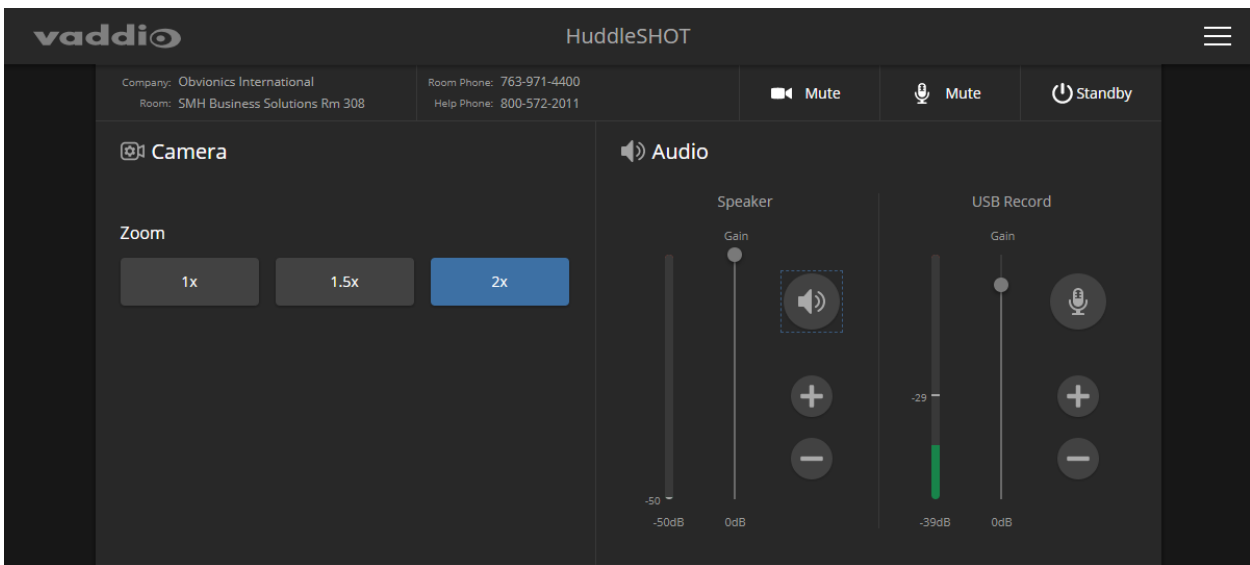

Your camera's Controls page may look somewhat different.

Administrative Access

If you are on the Controls screen, you're logged in at the user level, or guest access is enabled and you're not logged in at all. For access to system administration and performance/behavior configuration tasks, open the menu to log in as admin. The default admin password is **password**.

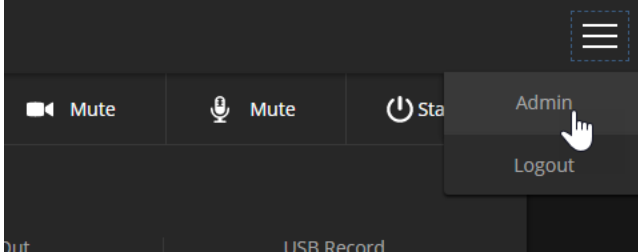

Note

For best security, change the user and admin passwords from the default. Using the default passwords leaves the product vulnerable to tampering. Be sure you have a way to remember the passwords after changing them.

System administration tasks are on these pages:

Page	Tasks
Bluetooth	Pair the remote to the camera; view status and other information about the remote.
Room Labels	Information to display on the web interface screens, including the conference room name and phone number and the in-house number for AV assistance.
Networking	Configure hostname, IP addressing, and NTP (date and time) settings.
Security	Set passwords and other security settings.
Diagnostics	View or download the diagnostic log when troubleshooting issues.
System	View firmware version, update firmware, reboot, and restore factory defaults. (Firmware tab, Peripherals tab)
Help	Tech support contact information and a link to the product information library.

Performance and behavior configuration tasks are on these pages:

Page	Tasks
Camera	Adjust zoom, color settings, and other image settings.
Audio	Control and adjust audio inputs and outputs individually.
Control Devices	Define macros and associate them to triggers (program responses to external controls such as third-party control devices)
Streaming	USB device settings and IP streaming.
System	Set indicator light behaviors and configure the camera for its environment.

System Administration

This chapter covers settings for managing the camera as an element of your network.

Administrative tasks are on these pages:

- Bluetooth – Pairing the remote to the camera.
- Networking – Time settings, hostname, and other network configuration
- Security – Passwords, guest access, other IT security-related settings
- Room Labels – Helpful information to display in the web interface
- System – Controls to reboot, reset to factory defaults, and run firmware updates, read the rear panel switches, and access the soft DIP switches
- Help – Contact information for Vaddio Technical Support and a link to the documentation for this product
- Diagnostics – Logs to help Vaddio Technical Support troubleshoot issues

See [Configuring Camera Behavior](#) for information on image adjustments, streaming configuration, and other items related to camera behavior.

Note

Vaddio's cameras have very similar web interfaces. Some of the screen shots in this manual may be from other models of camera.

Configuring the Camera for Your Network

By default, the camera is set to DHCP, and will receive an IP address automatically if your network assigns IP addresses. In this type of environment, the camera is available for use immediately, without any network configuration. However, you may find it helpful to make certain changes; and most organizations have policies concerning hostnames, static address assignments for certain equipment, and other aspects of network configuration.

Work with your network specialist to ensure that the camera is configured to comply with the organization's network policies.

For Non-DHCP Environments: Configuring the Device with a Static IP Address for Initial Installation

NETWORKING PAGE

If the camera is currently at an IP address other than 169.254.1.1, skip this section.

If no DHCP server is available to automatically assign an IP address, the camera will use the default IP address of 169.254.1.1. If this is the case, you may need to follow this procedure.

If the camera is using the default IP address of 169.254.1.1 and you need to install another camera or other device on this network, follow this procedure to prevent IP address conflicts.

Caution

Consult your IT department before editing network settings. Errors in network configuration can make the camera inaccessible from the network. Do not change DHCP/Static addressing, IP address, subnet mask, or gateway unless you are very familiar with the characteristics and configuration of the network where you install the camera.

To access the camera's Networking page during installation (skip this procedure if the camera has already been in service on this network):

1. Connect the camera according to the connection diagram, but *do not connect the camera to the network*.
2. Connect the network port on the camera to the network port on a computer. Depending on the computer, you may need a crossover cable.
3. On the computer, open a browser and access the camera's web interface at <http://169.254.1.1>.
4. Log in as admin. The default password is **password**.

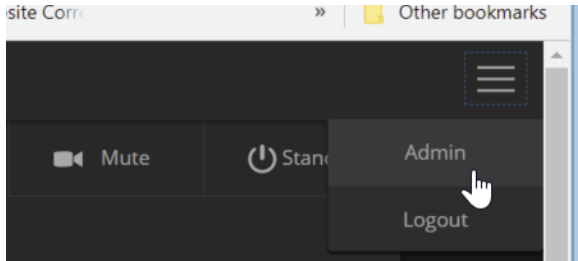

5. Navigate to the Networking page.
Your camera's web interface may look slightly different from these screen shots.

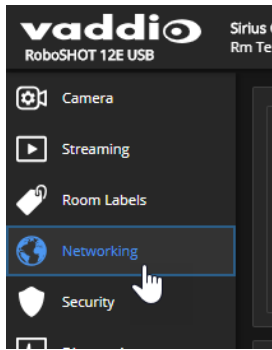

To configure the camera with a static IP address:

1. Work with your IT department to determine the correct IP address, subnet mask, and gateway to assign.
2. On the Networking page, set IP Address to Static.
3. Enter the IP address, subnet mask, and gateway as directed by the IT staffer; then save your work. The camera is now ready to be connected to the network.

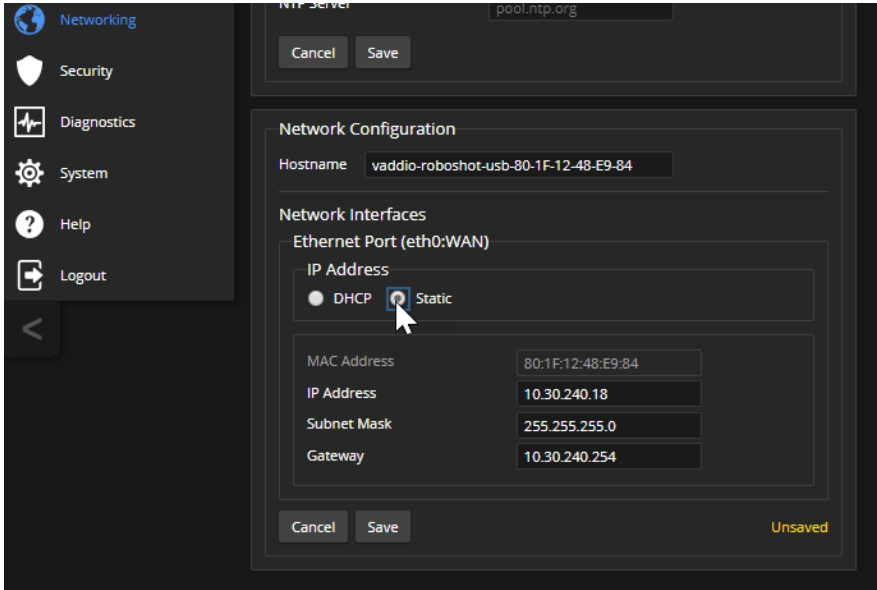

Optional For DHCP Environments: Changing from a DHCP Address to a Static IP Address

NETWORKING PAGE

In a network that assigns IP addresses automatically, the camera's IP address may change from time to time. To keep this from happening, set the IP address to Static. *Do not change the IP address, subnet mask, or gateway unless your IT staff instructs you to do so.*

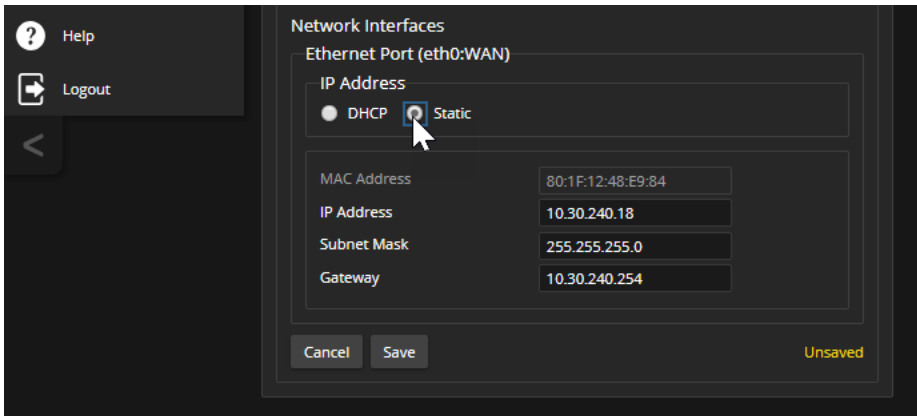

Changing the Camera's Hostname

NETWORKING PAGE

If your network supports hostname resolution, you may find it convenient to change the camera's hostname to something easy to remember, such as **camera-center-boardroom**.

Work with your IT department to ensure that the new hostname conforms to the organization's naming conventions.

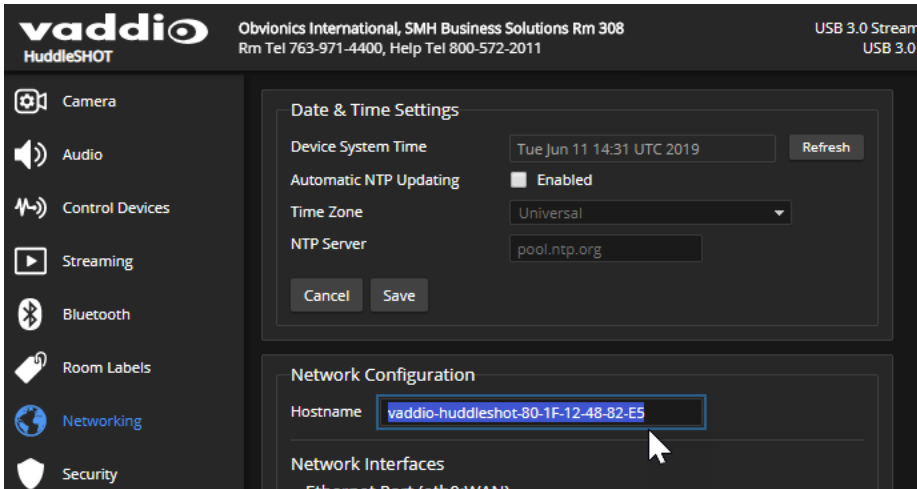

Specifying Time Zone and NTP Server

NETWORKING PAGE

Using automatic NTP updating ensures that the timestamps in the camera's diagnostic log are accurate. Specifying your time zone may make it easier to match logged events with other actions and external events.

1. To make the time zone and NTP server editable, enable Automatic NTP Updating.
2. Select the desired time zone from the list.
3. If desired, specify the NTP server to use. If you are not sure about this, use the default.

You may need to refresh the system time display.

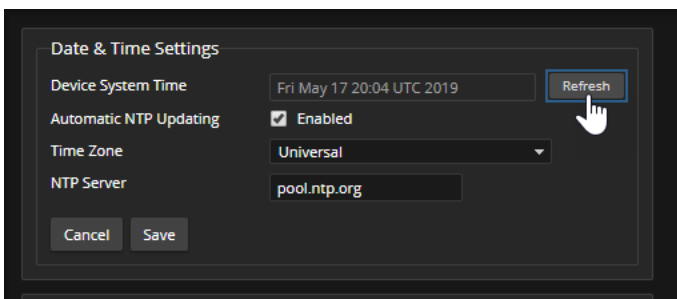
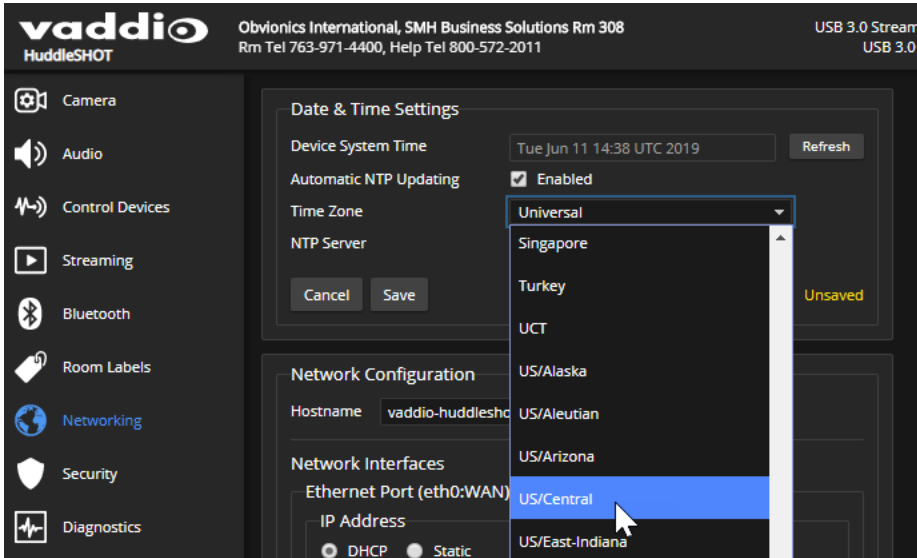

Configuring Security Settings

SECURITY PAGE

Security settings include:

- Setting passwords and allowing or disabling guest access
- Allowing or disabling access via Telnet (by default, access via Telnet is enabled)
- Allowing or requiring HTTPS for web access (by default, HTTP is also permitted) and installing the SSL certificate
- Allowing or denying device discovery (allowed by default)

Note

Consult your network security specialist before changing any of these settings.

Setting Passwords and Access

SECURITY PAGE

The Account Passwords and Web Server areas of the Security page provide basic security for the web interface:

- **Admin password** – Required for access to the admin pages of the web interface and for Telnet access to the device. The default is **password**.
- **User password** – Required for access to the operator's page of the web interface if guest access is disabled. The default is **password**.
- **Guest access** – Allows people to browse to the operator's page of the web interface without logging in. If guest access is disabled, no controls are available on the web interface until you log in. This is enabled by default.
- **Idle session expiration** – By default, inactive sessions expire after 30 minutes.

Note

For best security, change the user and admin passwords from the default. Using the default passwords leaves the product vulnerable to tampering. Be sure you have a way to remember the passwords after changing them.

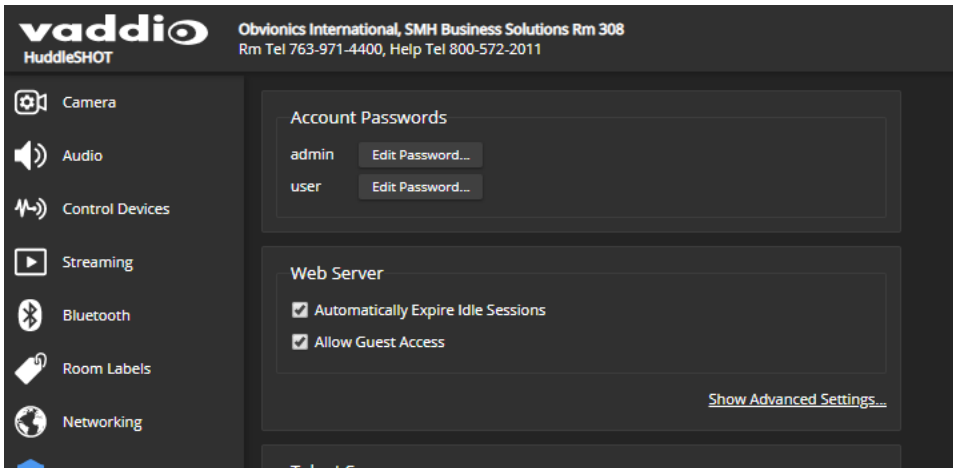

Enabling or Requiring HTTPS

SECURITY PAGE

By default, the web interface uses the HTTP protocol. You can configure the camera's web interface to require a secure HTTPS connection instead.

1. Select Show Advanced Settings. The advanced options open.
2. To switch to a secure HTTPS connection, select Switch to HTTPS.

Note

Your browser may present messages warning you that your connection is not secure, because the site's certificate is not valid. This happens when HTTPS is used but no SSL certificate is installed.

3. Work with your network security professional to install the camera's SSL certificate.

Caution

Consult your network security professional to manage the camera's SSL certificate. Do not make any changes in the Certificate or Private Key text boxes without guidance from your organization's network security professional.

4. To require HTTPS connections, clear the box labeled HTTP Access Enabled. The camera's web interface will only be available via an HTTPS connection.

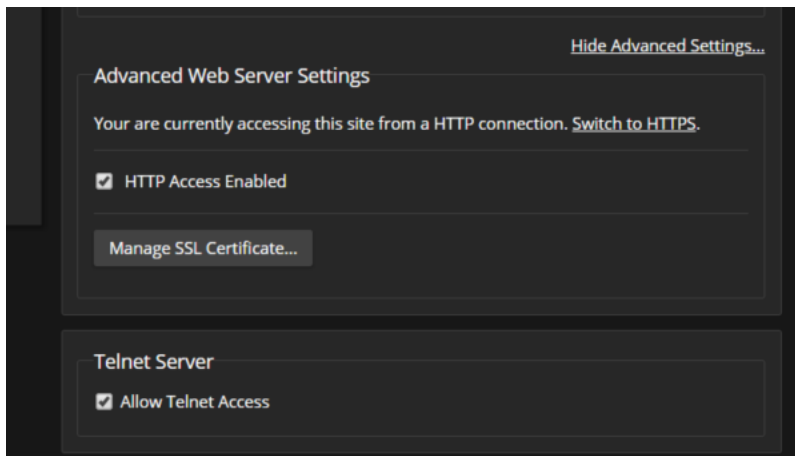

Disabling Telnet Access

SECURITY PAGE

If your installation does not require camera access via Telnet, you may choose to disable the camera's internal Telnet server.

Adding Room Information to the Screen

ROOM LABELS PAGE

The information you enter on this page is displayed on every page of the web interface. In a multi-camera environment, you may also wish to specify what appears on the browser tab.

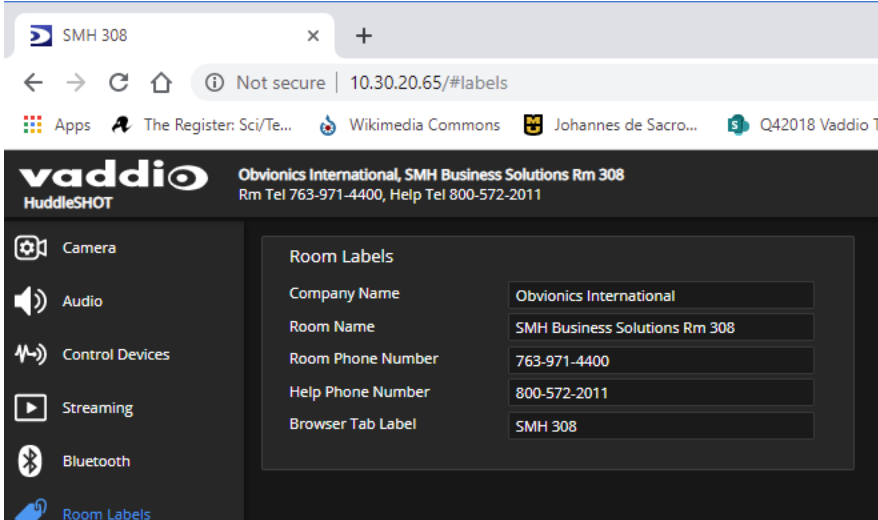

Saving (Exporting) or Restoring (Importing) a Configuration

SYSTEM PAGE, FIRMWARE TAB

You can import a configuration to several cameras if you need to configure them the same way. Cameras must be of the same model, and must have a compatible firmware version installed.

Note

If the camera is using an older firmware version, it may be unable import a configuration that was exported from a camera using a different version of firmware.

In the event that you need to restore a camera's factory default settings, you may want to export the configuration beforehand so that you can restore customized information.

Included	Not Included
Home	Color settings
NTP and time zone information	Remote pairing
Room Labels	Hostname
	Passwords and other security settings

Configuration data does not include security information or unique information such as hostname.

To export a configuration:

1. Configure the camera – set the time zone, create the room label, and store the presets you need.
2. Export the configuration (Export Data button). The export downloads to your computer as a .dat file. The filename is the camera's hostname.

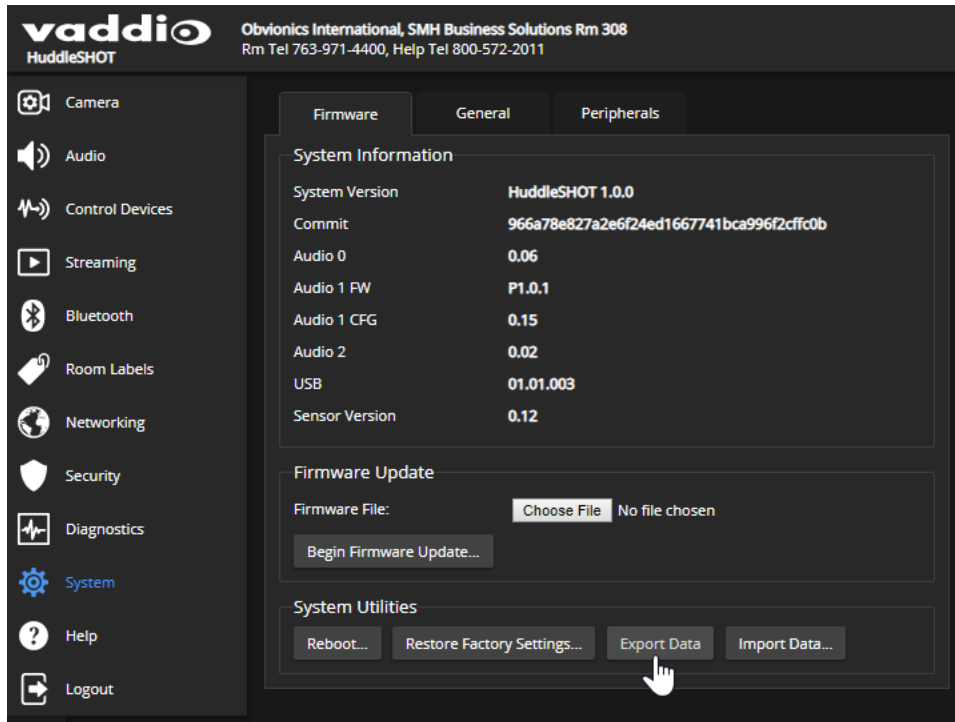

3. When you are ready to restore the configuration, select Import Data. The web interface prompts you to browse to the .dat file that will be imported.

To copy the configuration to a different camera, do this step from the web interface of the camera being configured.

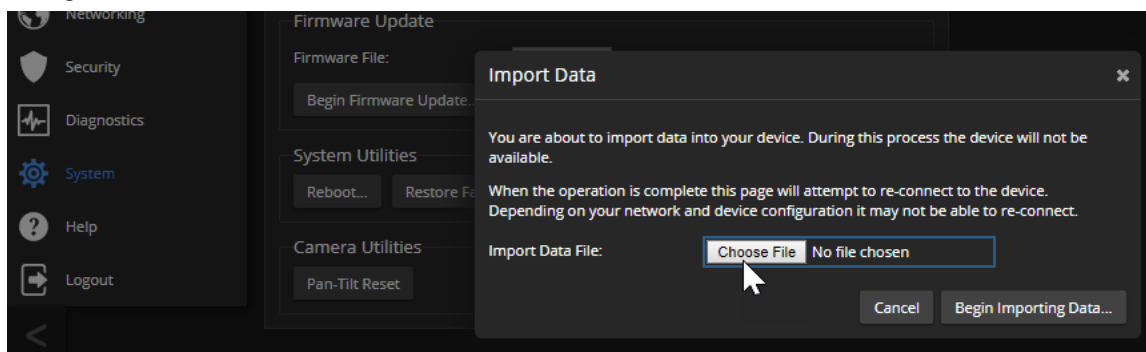

Rebooting the Camera

SYSTEM PAGE, FIRMWARE TAB

This can help if the camera stops responding as you expect. In the System Utilities section, select Reboot.



Installing a Firmware Update

SYSTEM PAGE, FIRMWARE TAB

We release firmware updates from time to time. Some of them will be of interest to your organization; others might not be. In general, there is no reason to install an update unless it will be useful to your organization. The release notes provided with each update can help you to decide whether to install the update.

Caution

The camera must remain connected to power and to the network during the update. Interrupting the update could make the camera unusable.

1. Download the firmware and its release notes.
2. Select Choose File, then browse to the downloaded firmware and select it. The filename ends with .p7m.

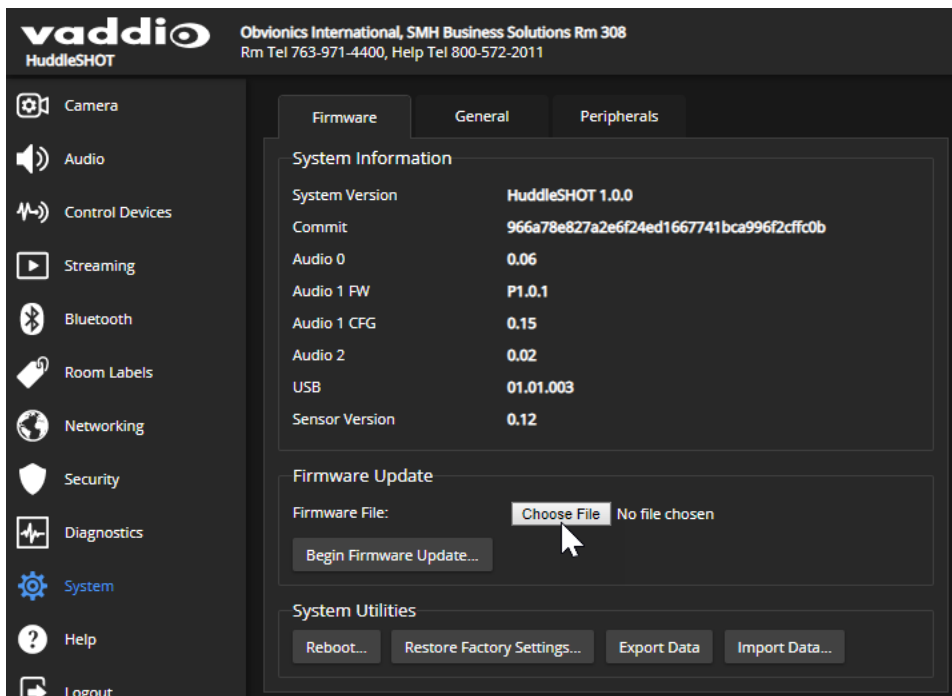

3. Select Begin Firmware Update.
4. Read and understand the information in the Confirm dialog box.
5. Select Continue. A progress message box opens and the indicator light on the front of the camera turns yellow/green. If the update process presents warnings or error messages, read them carefully.

The camera reboots when the update is complete.

Contact Vaddio Technical Support if you encounter any problems with the update.

Installing a Firmware Update for the Connected Microphone

SYSTEM PAGE, PERIPHERALS TAB

Vaddio conference room microphones are updated via the equipment to which they are connected. When you update the microphone firmware, you may also need to update the firmware of the other equipment in the room. Download firmware updates, release notes, and other product information from legrandav.com.

1. Go to the microphone's product page on the Vaddio website and download the update file identified as the web firmware update. The filename ends in .p7m.
2. Log in to the camera's web interface as **admin**, if you have not done so already.
3. Navigate to the host device's System page and select the Peripherals or Microphones tab.

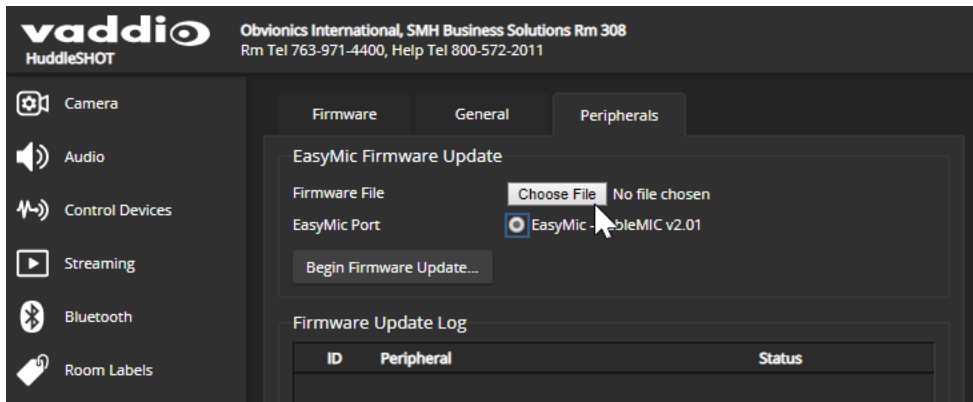

4. Select Choose File. Then browse to the update file that you downloaded, and select it.
5. Select the port connection for the microphone to be updated. There's only one, but you have to select it anyway.
6. Select Begin Firmware Update.
7. READ the information in the Confirm dialog box and be sure you understand it.

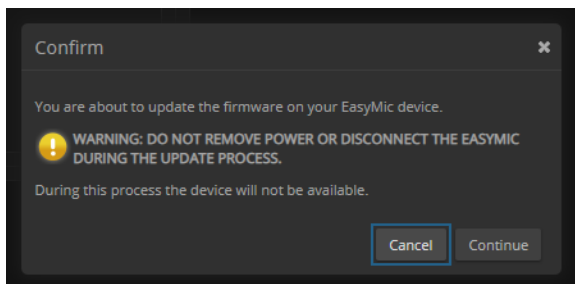

8. When you are ready to start the update, select Continue. The Firmware Update Log pane displays log messages during the update, and displays a success message when the microphone is updated and ready to use.

Contacting Vaddio Technical Support

HELP PAGE

If you can't resolve an issue using your troubleshooting skills (or the [Troubleshooting](#) table in this manual), we are here to help.

You'll find information for contacting Vaddio Technical Support on the Help screen.

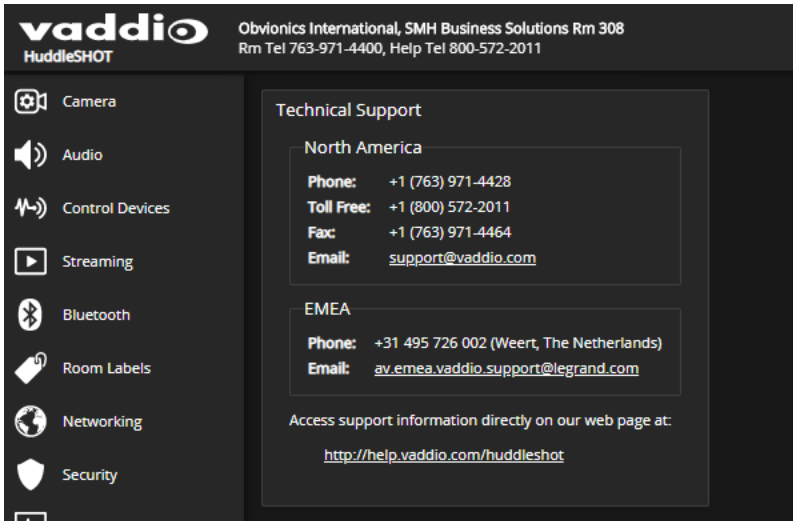

Viewing Diagnostic Logs

DIAGNOSTICS PAGE

If you encounter a problem that you can't solve, your Vaddio technical support representative may ask you to download and email the log file available from the Diagnostics screen.

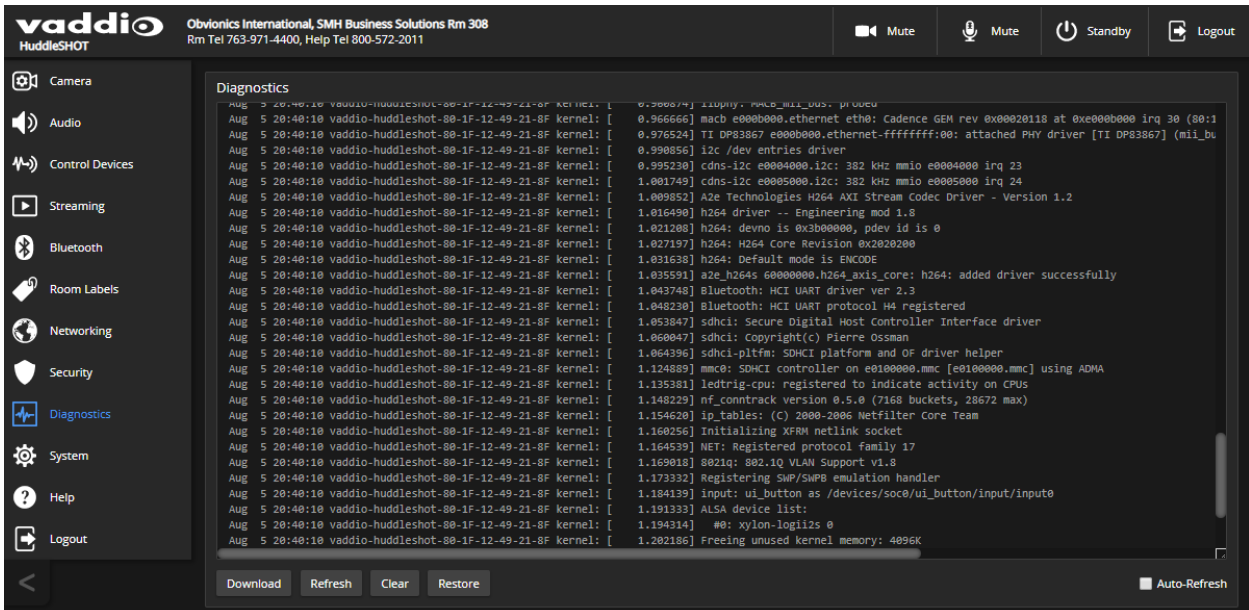

Configuring Camera Behavior

Basic camera configuration tasks are available on the Camera page:

- Adjust for the lighting in the room
- Set zoom level, dewarp adjustment, and color adjustments

Other configuration tasks are available on these pages:

Camera configuration tasks are available on these pages:

- Streaming – USB device settings and IP (H.264) streaming
- System – How the camera responds to the remote, status light behavior, image flip, and other settings
- Audio – Adjustments for microphones, speakers, and other audio inputs and outputs
- Control Devices – Programmed operations (macros) and their triggers
- Bluetooth – Recognize (pair with) the remote

Configuring Streaming Behavior

Conferencing applications use *USB streaming*. The camera's USB stream can be viewed using the computer connected to the camera, either in a conference or using a media player.

Two *IP streaming* protocols are available: RTSP and RTMP.

- *RTSP streaming* delivers an IP stream that people can access from your network using a media player. This is the camera's default protocol for IP streaming.
- *RTMP streaming* sends a stream to a content service provider such as YouTube. No local preview is available. To use RTMP streaming, you must have an account with a streaming service.

Note

Your camera's web interface may differ slightly from the images in these procedures.

Enabling or Disabling Streaming

STREAMING PAGE

IP streaming is enabled by default, and the RTSP stream is available for viewing on your network unless you disable IP streaming or switch to RTMP. USB streaming is available whenever the camera is connected to a computer.

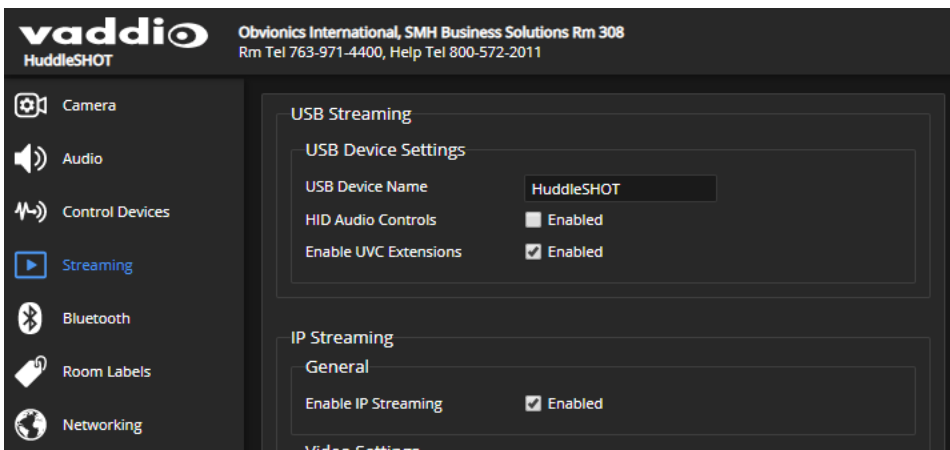

Viewing a Stream

To view the RTSP stream:

1. Open a stream viewer such as VLC Media Player.
2. Select "Network stream" or your viewer's equivalent option.
3. Copy the streaming URL from the camera's Streaming page and paste it into the viewer as the URL for the network stream.

To view the USB stream:

Do one of these things:

- Start or join a conference.
- Open a stream viewer and select the camera as the video capture device.

The image below shows how you would select a ConferenceSHOT 10 camera as the capture device for VLC Media Player.

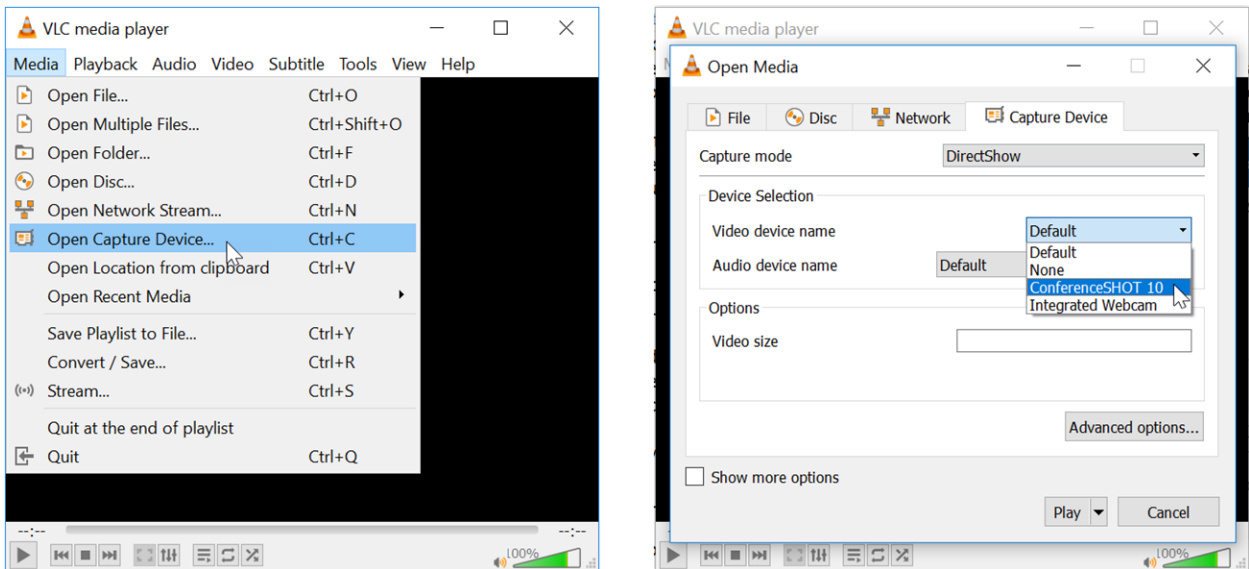

Configuring USB Streaming

STREAMING PAGE

These settings affect how the camera works with soft conferencing applications.

To change the way the camera shows up in your soft client's camera selection list:

Edit the USB Device Name.

To allow conferencing applications to control the audio:

Check the Enabled box for HID Audio Controls.

To allow conferencing applications to control the camera:

Check the box marked Enable UVC Extensions.

Note

USB streaming resolution and frame rate are automatically negotiated between the camera and the conferencing application.

Setting up IP Streaming in Easy Mode

STREAMING PAGE

Note

Consult your network specialist when setting up IP streaming, to be sure that you select settings that are appropriate for the network.

If you are not sure about these settings, start with the defaults.

1. Select Easy Quality Mode.
2. Select the desired IP streaming resolution. This determines the size of the window in which the stream is displayed.

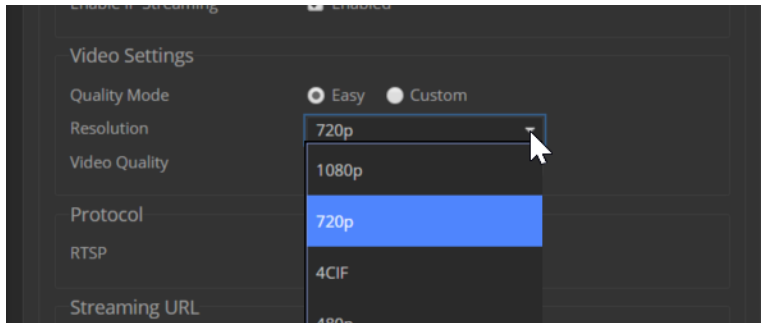

3. Select Video Quality.

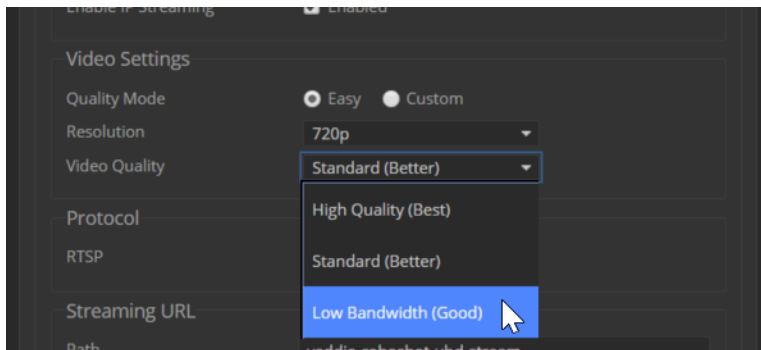

4. Save your changes.

Setting up IP Streaming in Custom Mode

STREAMING PAGE

Note

Consult your network specialist when setting up IP streaming, to be sure that you select settings that are appropriate for the network.

1. Select Custom quality mode.
2. Select the desired resolution.
3. Select the desired frame rate.

Note

Some combinations of resolution and frame rate are not valid, and will generate notifications.

4. Select Constant or Variable Bit Rate.
5. Constant Bit Rate only: Set Max Bandwidth.

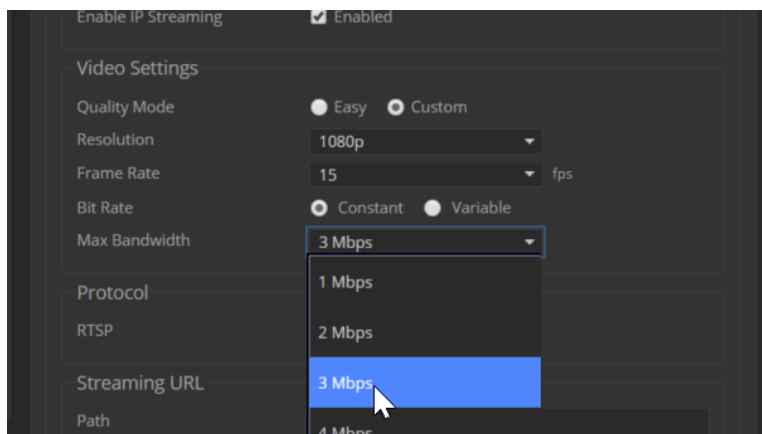

6. Variable bit rate only: Set the Quality (Quantization) slider.

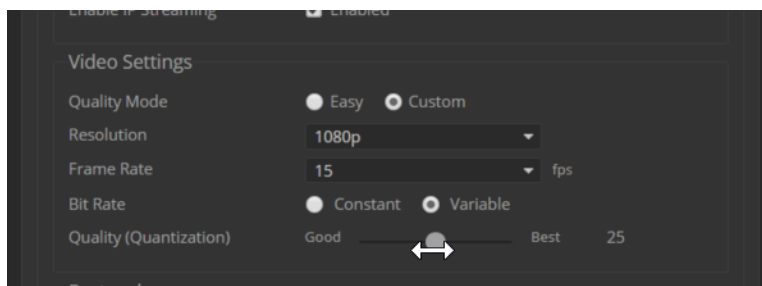

7. Save your changes.

RTSP Streaming Protocol and URL

STREAMING PAGE

RTSP is the default streaming protocol. When IP streaming is enabled, the RTSP stream is automatically available at the streaming URL shown.

Consult your IT department before changing these settings.

RTSP port: Vaddio strongly recommends using the default RTSP port number.

Path: The portion of the streaming URL that appears after the IP address. You may wish to change this to help identify the stream source – for example, `demo-studio-3`.

URL: The location where the stream can be viewed. This will change if you edit the path.

Configuring RTMP Streaming

STREAMING PAGE

To use RTMP streaming, you must have an account with a streaming service.

To configure an RTMP streaming service:

1. Select RTMP streaming, and select Settings.

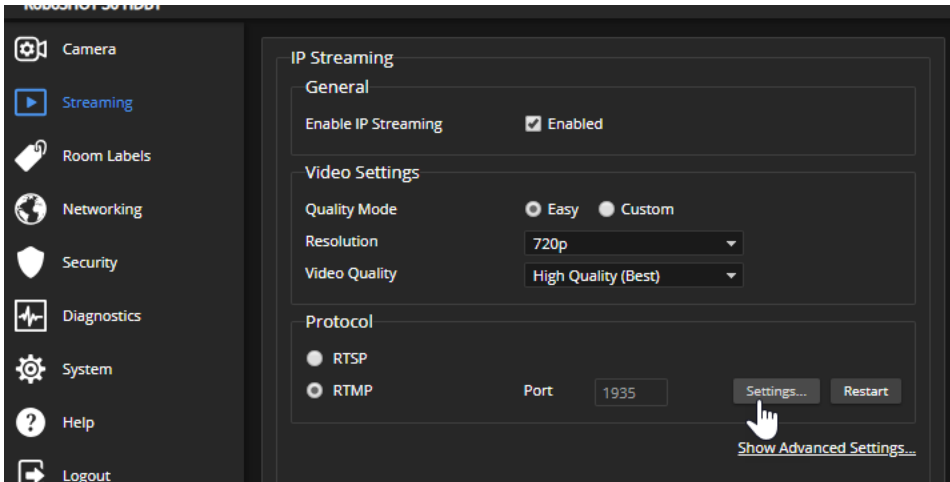

2. Expand the information box for the service.

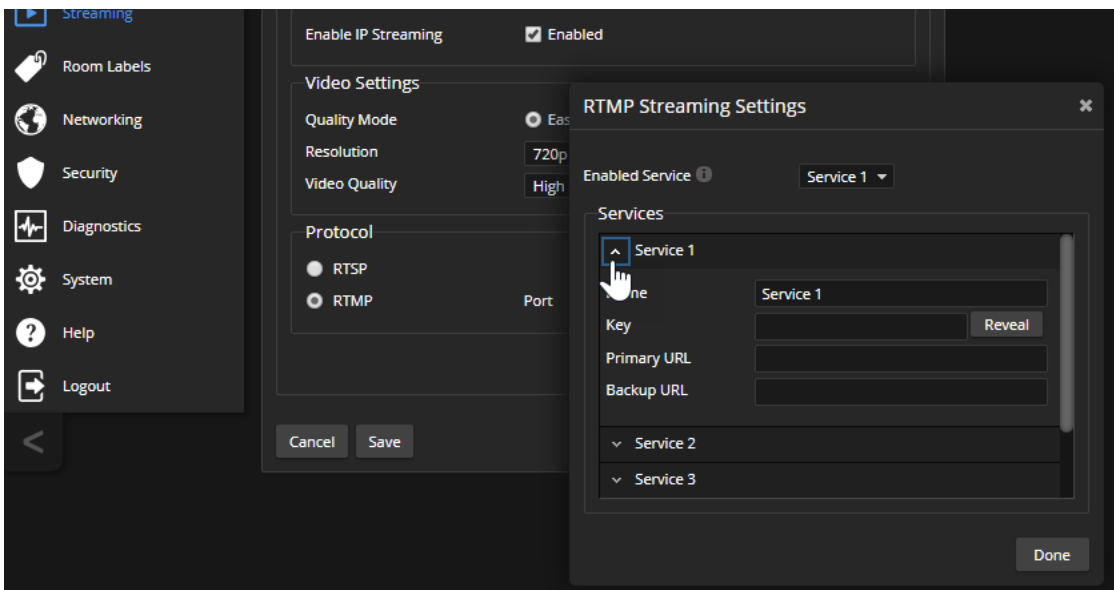

3. Enter the name of the service.
4. Paste in the key and URL(s) provided by the service.

To select the enabled RTMP streaming service:

Expand the list of available streaming services, and select the one to use.

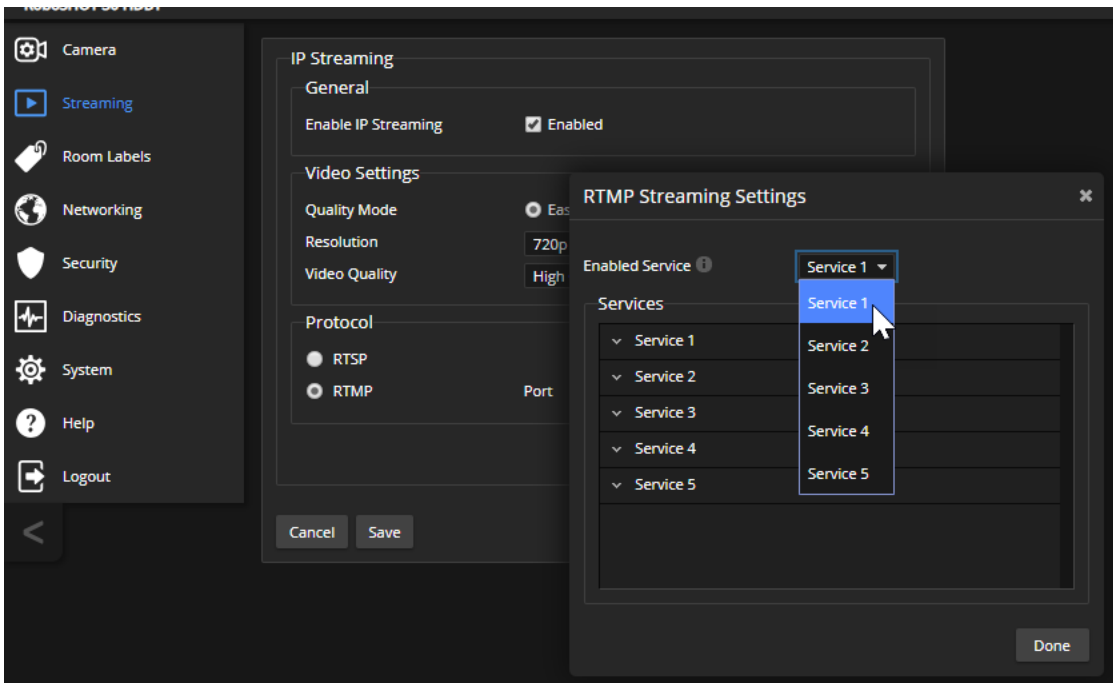

Note

When RTMP streaming is selected and a service is configured, the camera streams to that service until you stop the stream.

Changing MTU

STREAMING PAGE

The default packet size for streaming is 1400. Do not change this except in consultation with your network administrator.

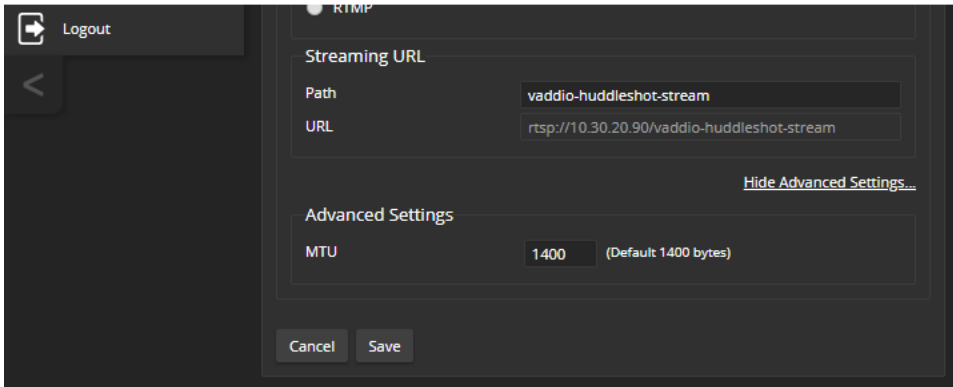
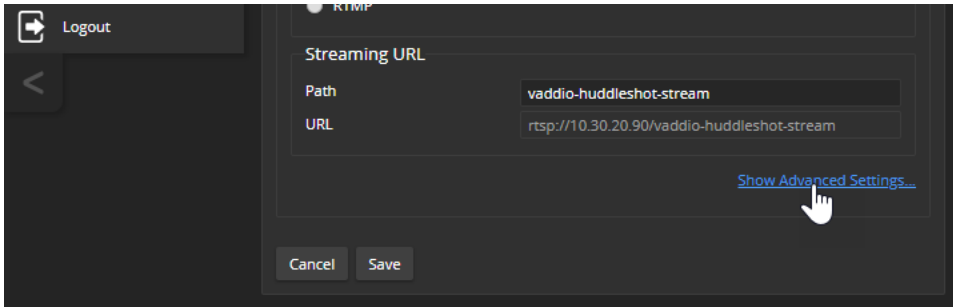

Managing Audio

The web interface provides separate controls for each of the audio inputs (built-in microphones, connected EasyMic-compatible microphone, USB playback) and outputs (speaker, IP stream left and right, and USB record).

Muting All Audio Inputs Together

Use the audio mute button at the top of any page of the web interface.

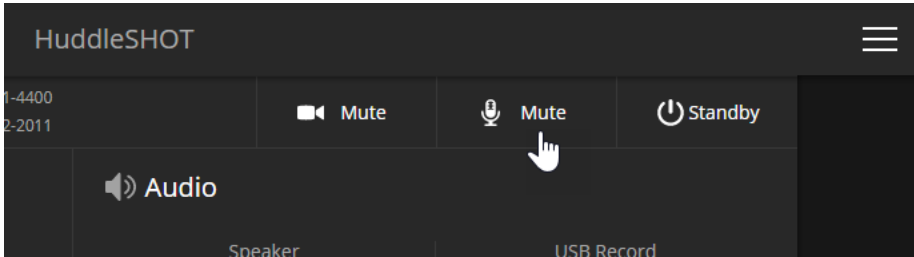

Controlling Volume and Muting Per Input or Output

AUDIO PAGE

To manage individual audio inputs or outputs:

Use the slider for the appropriate audio input or output to set the volume. The audio level meter and numeric value can be helpful.

Note

For best performance with most computers, we recommend setting the USB Record volume high.

To mute individual inputs or outputs:

Use the button to mute the desired audio input or output.

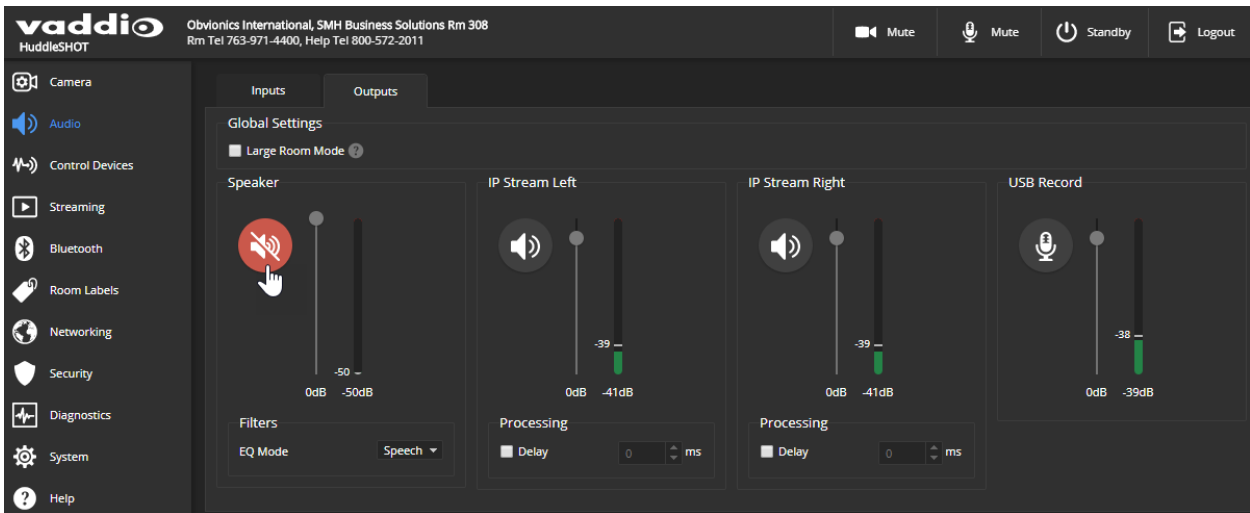

Adjusting Performance for Larger Rooms

AUDIO PAGE

If the camera is installed in a room large enough to require an external microphone, you may need to adjust the audio. Select Large Room Mode to boost the speakers and use the external microphone exclusively. This setting is available on both the Inputs and the Outputs tabs.

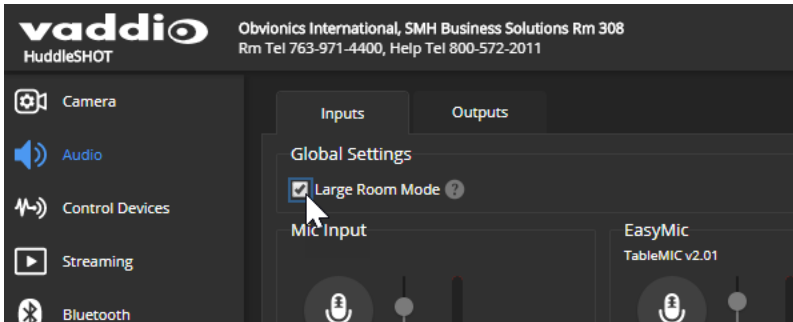

Fine-Tuning Microphone Performance

AUDIO PAGE, INPUTS TAB

You may need to adjust the microphones to suit the room or the specific conference.

To correct this...	Do this
Reverberant room (no external microphone)	Set the NLP (Non-Linear Processing) filter to Reverberant to reduce the echoing quality of the sound.
Reverberant room (TableMIC microphone connected)	From the TableMIC Easy PEQ menu, select Reverberant Room.
Noisy environment (TableMIC microphone connected)	From the TableMIC Easy PEQ menu, select Ambient Noise to reduce gain in the frequencies above and below the normal speech range.
Participants who have quiet voices or are seated beyond the microphones' optimum pick-up range (TableMIC microphone connected)	Select the Mic Boost processing option to increase microphone gain overall. From the TableMIC Easy PEQ menu, select Speech Enhancement to increase gain in the frequency range for speech.
Participants with widely differing vocal volumes (TableMIC microphone connected)	Select the Automatic Gain Control processing option to adjust microphone gain based on the relative volumes of people's voices.

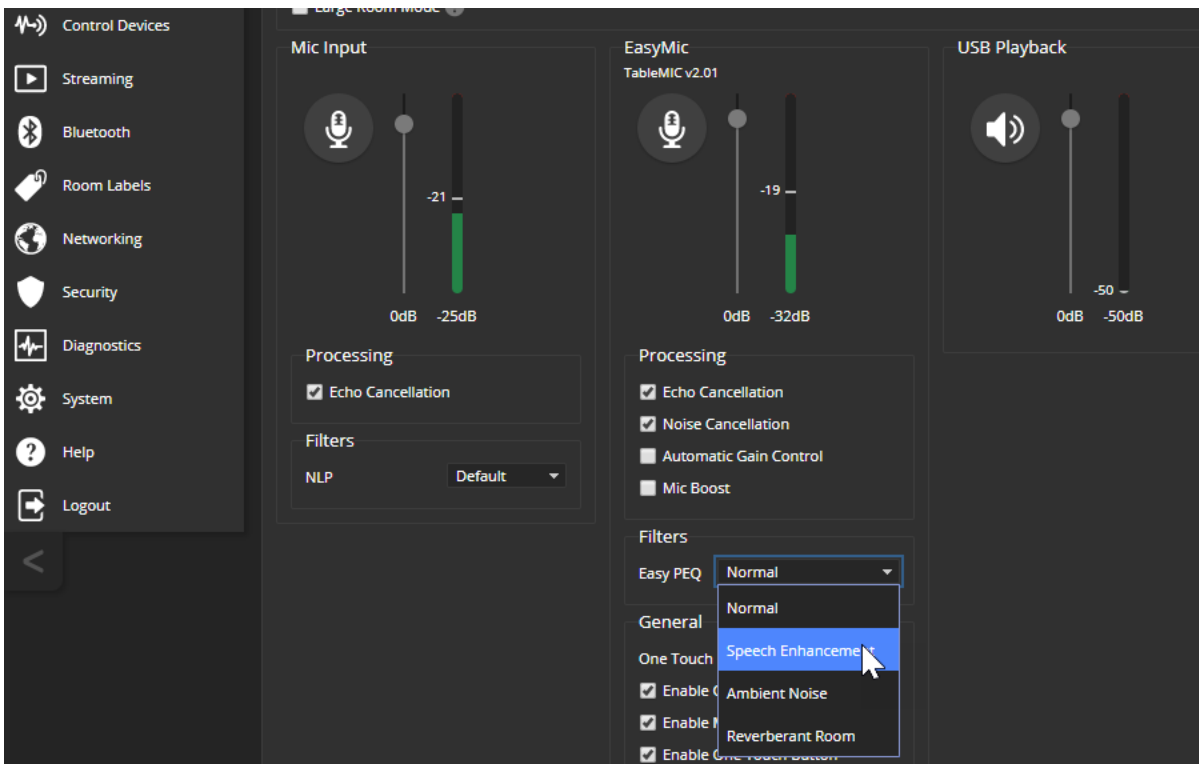

Using the Camera as a Sound Bar

AUDIO PAGE, BOTH TABS

1. With the camera [connected as a sound bar](#), select Sound Bar Mode on the Inputs tab.

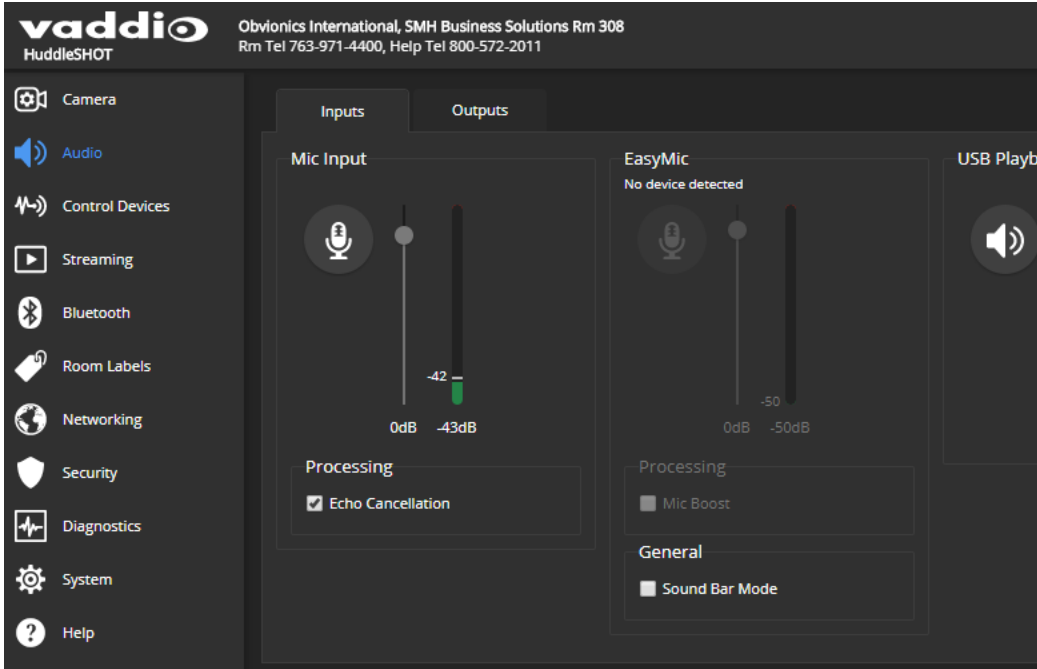

2. If the content is primarily music, set the speaker EQ Mode to Music on the Outputs tab.

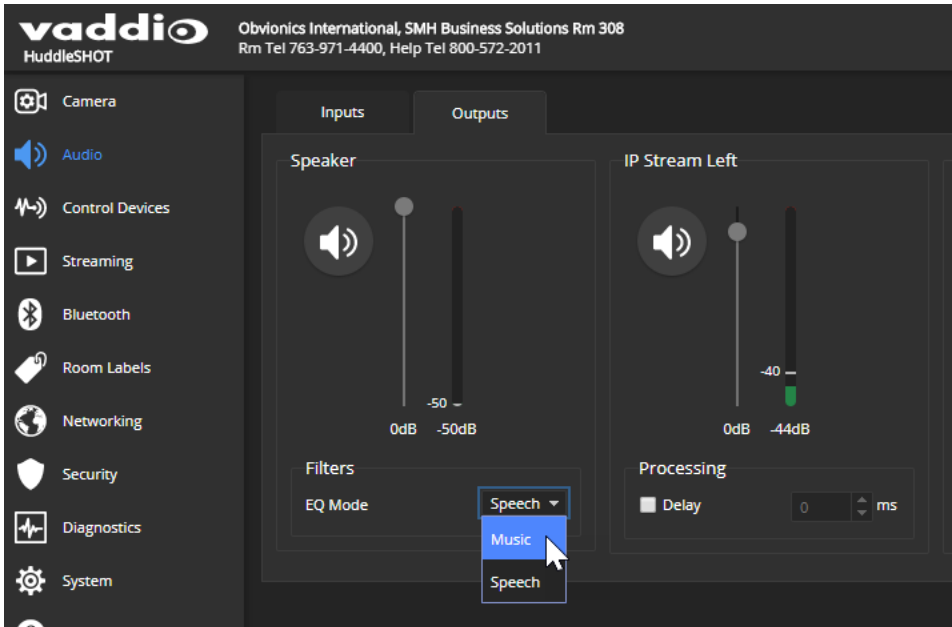

Setting up Macros and Triggers

Macros are sequences of commands. Triggers register events or state changes that can be associated with macros, to make them run. For example, the One Touch (Home) button on a TableMIC is a trigger.

When you associate a macro with a trigger, you must specify whether it runs when the trigger turns on, or when it turns off – so you can associate two macros with each trigger, one to run when the trigger is activated, and one to run when the trigger is turned off.

A trigger may be either hardware, such as the Home button on a tabletop microphone, or software. Software triggers allow you to program custom functions for third-party control devices, such as defining the buttons on a conference room touch-screen. Hardware triggers (labeled One Touch in the web interface) allow you to define responses to connected Vaddio trigger devices such as TableMIC microphones.

The macro can only run successfully if all the commands in the macro are able to run successfully. For example, if the macro sends the camera to a preset position, that preset must be defined. Refer to the [Telnet Serial Command API](#) section for a full list of commands.

Writing and Editing Macros

CONTROL DEVICES PAGE, MACROS TAB

To define a macro:

1. Enter a name in the Macro Editor's Name field.

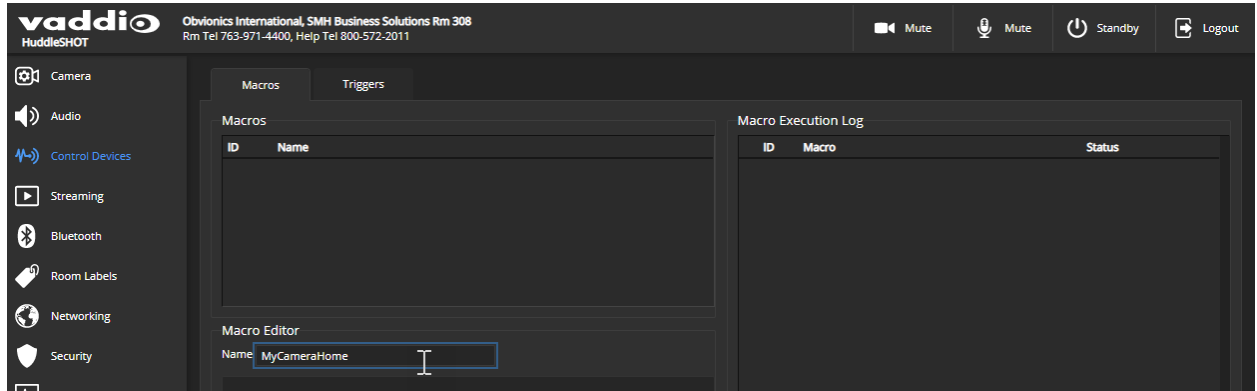

2. Enter one or more Telnet commands in the editing area.
3. Optional but strongly recommended: Use the Test button to check your work while you are writing the macro.

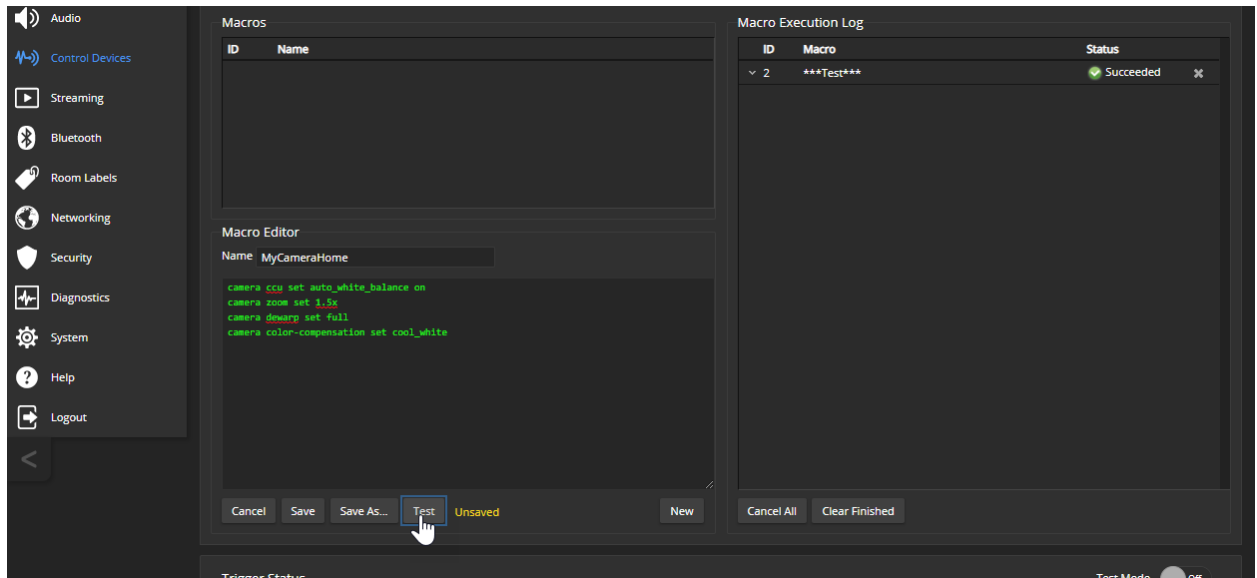

4. Save your work when you are finished, or select New to start over.

To edit an existing macro:

Select the Edit button associated with the macro, make your changes in the Macro Editor, and save your work.

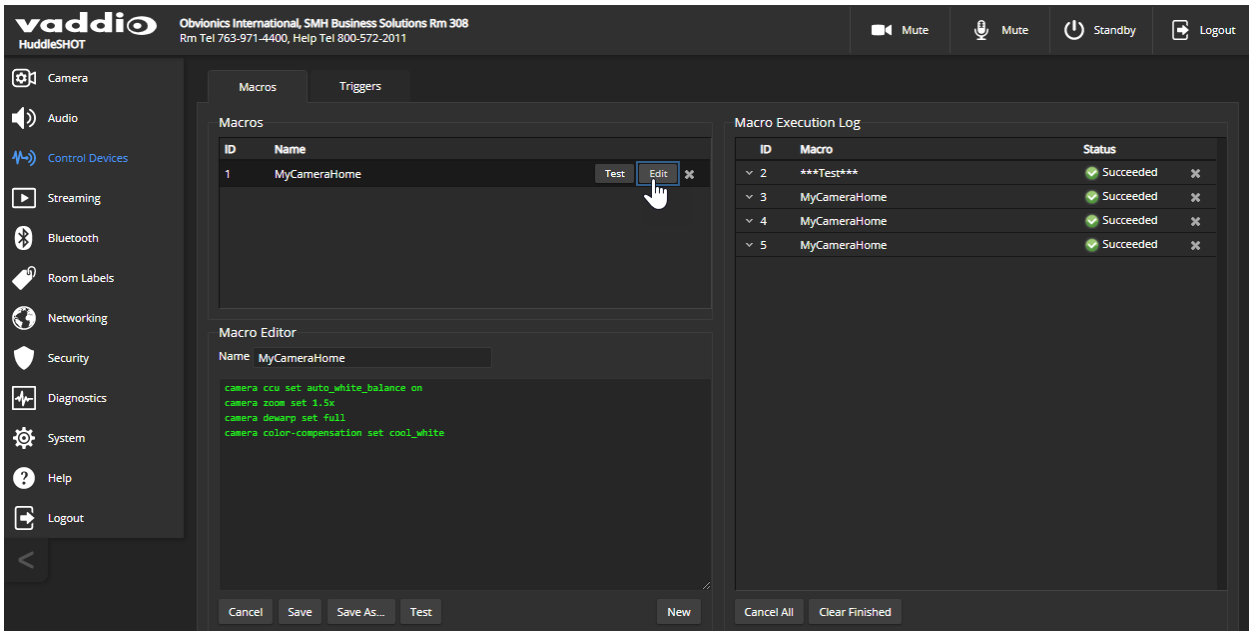

To create a new macro based on an existing one:

Select the Edit button for the existing macro to open it, and use the Save As button to give it a new name. Then select its Edit button again, and make the desired changes.

Testing Macros

CONTROL DEVICES PAGE, MACROS TAB

The Macro Editor has a Test button to run a macro while you are editing it. You can also test macros after saving them. The Macro Execution Log shows the result of each test.

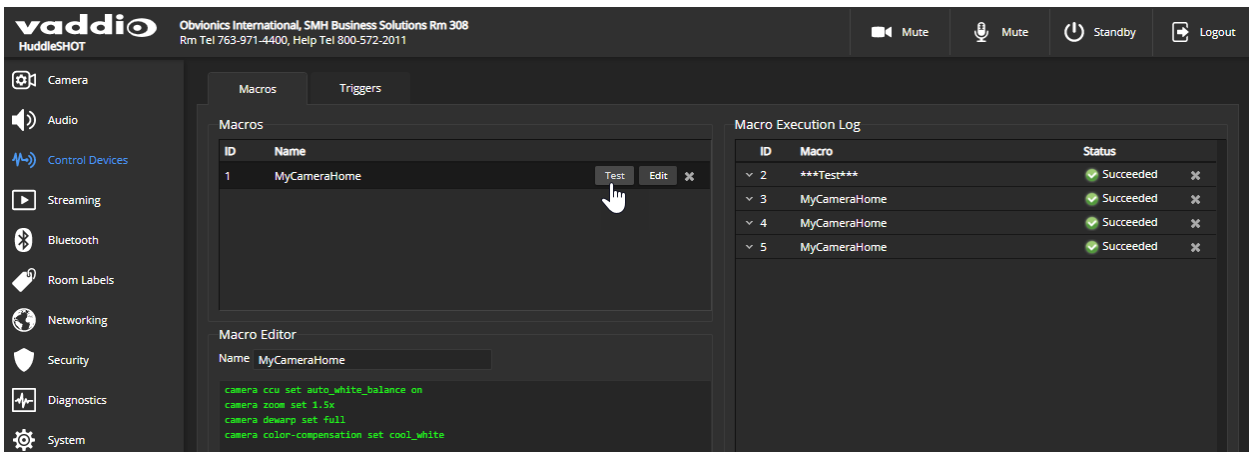

Assigning Macros to Triggers

CONTROL DEVICES PAGE, TRIGGERS TAB

A trigger may be associated with a macro that runs when the trigger is on, one that runs when the trigger is off, or one of each.

To assign a macro to a trigger:

Do at least one of these things:

- Select a macro in the Execute Macro on Enter field. This macro will start when the trigger turns on.
- Select a macro in the Execute Macro on Exit field. This macro will start when the trigger turns off.

Right-click a trigger label or test button to rename the trigger.

Example: Assigning a single macro to the Home button of the connected TableMIC microphone:

1. On the Macros tab of the Control Devices page, name and create the macro. Then test, debug, and save it.
2. If you want this macro to run every time you tap the TableMIC microphone's One Touch button, go to the Audio page and set the One Touch Button mode to Momentary. Otherwise it will run *every other time* you tap the button.
3. On the Triggers tab of the Control Devices page, locate One Touch in the list of trigger events, and select the macro from the list of available actions for Execute Macro On Enter.

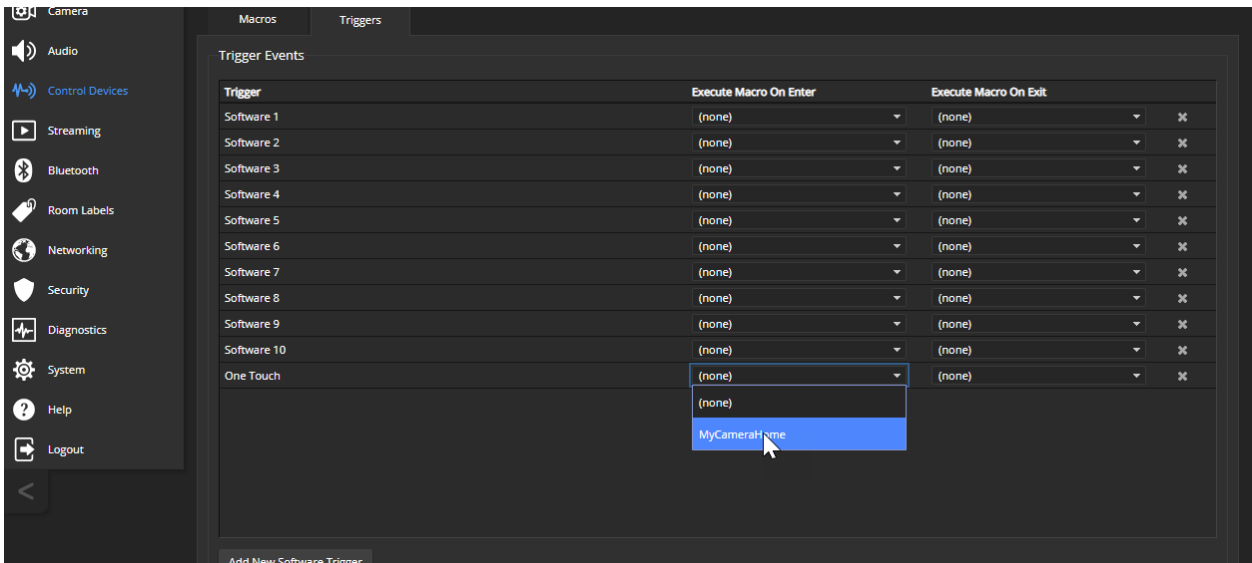

To remove macro assignments from a trigger:

Select the X on that trigger's row. This is equivalent to setting both macros to (none) .

Testing Triggers

CONTROL DEVICES PAGE

Just as it can be helpful to test macros when you write them, it can also be helpful to test triggers when you assign macros to them. The Trigger Testing section is available from both tabs of the Control Devices page.

To test a trigger:

1. Set Test Mode on. The web interface displays a notification.
2. Select the trigger to run the macro associated with turning the trigger on.
3. Select the trigger again to run the macro associated with turning the trigger off, if there is one.
4. Turn off Test Mode when you finish testing.

Note

Triggers are not available to the control device when Test Mode is selected.

Setting Other System Behaviors

SYSTEM PAGE, GENERAL TAB

The following settings are available on the System page:

- **LED On** (default = selected) – If desired, the indicator light can be turned off.
- **LED On in Standby** (default = selected) – When this is selected, the indicator light is on when the camera is powered, even if it is in standby mode.
- **Standby Device when USB Disconnects** (default = not selected) – To automatically set the camera in standby (low-power) mode when not connected to a computer, select this option.

Note

By default, the camera's status indicator light is active during normal operation; however, it can be configured to remain off when the camera is powered up. The camera may be sending video even if the light is off.

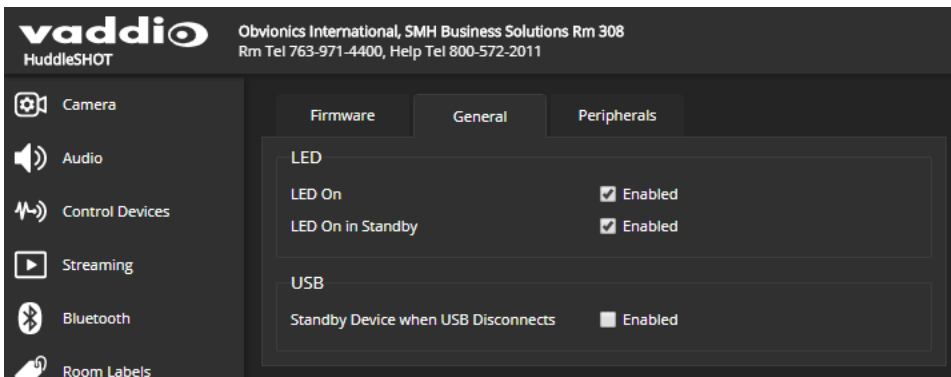

Telnet Serial Command API

The Vaddio Telnet command API allows an external device such as an AMX or Crestron presentation system to control the camera. It is also used for writing macros. Network connectivity and a Telnet client are required; Telnet port 23 is used.

In addition to the camera control commands, Telnet session management commands are available – help, history, and exit.

Note

When you connect via Telnet, you must log in using the admin account.

Things to know about Telnet:

- The > character is the command prompt.
- Using a question mark as a command parameter will bring up a list of available subcommands or parameters. Example:

```
camera led ?
get      Get the current LED toggle
on       Turn the LED on
off      Turn the LED off
```

- CTRL-5 clears the current serial buffer on the device.

Typographical conventions:

- n{x|y|z} – Choose x, y, or z.
- n<variable> – Substitute the desired value here.
- n<x-y> – Valid range of values is from x through y.
- n[optional] – Parameter is not required.

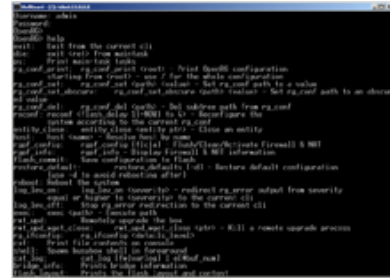

camera home

Returns the camera to its stored color settings.

Synopsis	camera home
Example	<pre>>camera home OK ></pre>

camera ccu get

Returns CCU (lighting and color) information.

Synopsis	camera ccu get <param>	
	auto_white_balance	Returns the current state of the auto white balance setting (on or off).
	backlight_compensation	Returns the current state of the backlight compensation setting (on or off).
	blue_gain	Returns the blue gain value as an integer (0 to 20).
	red_gain	Returns the red gain value as an integer (0 to 20).
	chroma	Returns the chroma value as an integer (0 to 20).
	gamma	Returns gamma as an integer (0 to 3).
	detail	Returns the detail value as an integer (0 to 10).
	wide_dynamic_range	Returns the current setting for Wide Dynamic Range (on or off).
	all	Returns all current CCU settings.
Examples	<pre>>camera ccu get red_gain red_gain 11 OK ></pre> <p>Returns the current red gain value.</p> <pre>>camera ccu get all auto_white_balance on backlight_compensation off blue_gain 10 chroma 2 detail 8 gamma 3 red_gain 11 wide_dynamic_range off OK ></pre> <p>Returns all current CCU settings.</p>	

camera ccu set

Sets the specified CCU (lighting) information.

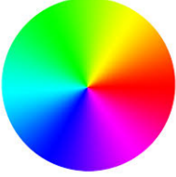
Synopsis	camera ccu set <param> <value>	
<p>Options</p> 	auto_white_balance {on off}	Sets the current state of the auto white balance setting (on or off). Auto white balance overrides red gain and blue gain manual settings.
	backlight_compensation {on off}	Sets the current state of the backlight compensation setting (on or off). Can only be used when wide dynamic range mode is off.
	blue_gain <0 - 20>	Sets the blue gain value as an integer (0 to 20). Can only be used when auto white balance is off.
	red_gain <0 - 20>	Sets the red gain value as an integer (0 to 20). Can only be used when auto white balance is off.
	chroma <0 - 20>	Sets the chroma value as an integer (0 to 20).
	gamma <0- 3>	Sets gamma value as an integer (1 to 3).
	detail <0 - 10>	Sets the detail value as an integer (0 to 10).
	wide_dynamic_range {on off}	Sets Wide Dynamic Range mode on or off. Can only be used when backlight compensation is off.
Examples	<pre>>camera ccu set auto_iris off OK > Turns off auto-iris mode, returning the camera to manual iris control. >camera ccu set red_gain 10 OK > Sets the red gain value to 10.</pre>	

camera zoom

Moves the camera in toward the subject or out away from the subject.

Synopsis	<code>camera zoom { get set { 1x 1.5x 2x } }</code>	
Options	<code>get</code>	Returns the camera's zoom level.
	<code>set { 1x 1.5x 2x }</code>	Sets the camera's zoom level. 1x, 1.5x, and 2x are the only permissible values.
Examples	<pre> camera zoom set 1.5x OK > Sets the camera to 1.5x zoom. > camera zoom get zoom: 1.5x OK > Returns the camera's current zoom level.</pre>	

camera dewarp

Dewarping removes the "fish-eye" effect. When the camera is set to full dewarp, the field of view is reduced by about 10°.

Synopsis	<code>camera dewarp { get set { off half full } }</code>	
Options	<code>get</code>	Returns the camera's current dewarp level.
	<code>set { off half full }</code>	Sets the camera's dewarp level.
Examples	<pre> camera dewarp set full OK > Sets the camera to full dewarp. > camera dewarp get dewarp: full OK > Returns the camera's current dewarp level.</pre>	

camera color-compensation

The color compensation settings allow quick color adjustments for room lighting that is overly warm or cool.

Synopsis	camera color-compensation { get set { neutral warm_white cool_white } }	
Options	get	Returns the camera's current color compensation setting.
	set	Sets the camera's color compensation.
	neutral	No color compensation.
	warm_white	Compensates for "cool white" lighting.
	cool_white	Compensates for "warm white" lighting.
Examples	<pre> camera color-compensation set warm_white OK > Sets the camera to color-compensation. > camera color-compensation get color-compensation: warm_white OK > Returns the camera's current color compensation setting.</pre>	

camera led

Set or change the behavior of the indicator light.

Synopsis	camera led { get off on }	
Options	get	Returns the indicator light's current state (on or off).
	off	Disables the indicator light.
	on	Enables the indicator light.
Examples	<pre> >camera led off OK > Disables the indicator light. When the LED is off, you cannot tell by looking at the camera whether it is sending video. >camera led get led: on OK > Returns the current state of the indicator light.</pre>	

camera standby

Set or change camera standby status.

Synopsis	camera standby { get off on toggle }	
Options	get	Returns the camera's current standby state.
	off	Brings the camera out of standby (sleep) mode.
	on	Stops video and puts the camera in standby mode.
	toggle	Changes the camera's standby state - if it was not in standby mode, it enters standby; if it was in standby mode, it "wakes up."
Examples	<pre>>camera standby off OK > Brings the camera out of standby mode. >camera standby get standby: on OK > Returns the current standby state.</pre>	

audio volume

Gets or sets the volume of the specified audio channel.

Synopsis	audio < channel > volume { get up down set }	
Channels	master	Applies the command to all audio channels.
	mic_input	Applies the command to the built-in microphones.
	easy_mic_1	Applies the command to the external microphone connected to the EasyMic port.
	usb_playback	Applies the command to the audio portion of the incoming (far-end) USB stream
	speaker	Applies the command to the audio from the speakers.
	usb_record	Applies the command to the outbound (near-end) audio portion of the USB stream
	ip_out_left ip_out_right	Applies the command to the outbound (near-end) audio portion of the IP stream, left and right channels.
Options	get	Returns the current volume of the specified channel.
	up	Increases the volume of the specified channel.
	down	Reduces the volume of the specified channel.
	set	Sets the volume of the specified channel.
Examples	<pre>audio line_in_1 volume set -5 OK ></pre> <p>Sets -5 dB as the volume for the device connected to the Line In 1 port.</p> <pre>audio line_out_1 volume get volume -10.0 dB OK ></pre> <p>Returns the current volume for the speaker connected to the line out port.</p>	

audio mute

Gets or sets the mute status of the specified audio channel.

Synopsis	<code>audio < channel > mute { get on off toggle }</code>	
Channels	<code>master</code>	Applies the command to all audio channels.
	<code>mic_input</code>	Applies the command to the built-in microphones.
	<code>easy_mic_1</code>	Applies the command to the external microphone connected to the EasyMic port.
	<code>usb_playback</code>	Applies the command to the audio portion of the incoming (far-end) USB stream
	<code>speaker</code>	Applies the command to the audio from the speakers.
	<code>usb_record</code>	Applies the command to the outbound (near-end) audio portion of the USB stream
	<code>ip_out_left</code> <code>ip_out_right</code>	Applies the command to the outbound (near-end) audio portion of the IP stream, left and right channels.
Options	<code>get</code>	Returns the current mute status of the specified channel.
	<code>on</code>	Mutes the audio for the specified channel.
	<code>off</code>	Unmutes the audio for the specified channel.
	<code>toggle</code>	Changes the mute state for the specified channel – unmutes if it was muted, mutes if it was not.
Examples	<pre>> audio line_out_1 mute get mute: off OK ></pre> <p>Returns the current mute state of the device connected to audio line out 1. Mute is off, so the audio is on.</p> <pre>>audio master mute on OK ></pre> <p>Mutes all audio.</p>	

video mute

Gets or sets the camera's video mute status. When video is muted, the camera sends blue or black video with an on-screen message stating that video mute is on. This can be desirable when preparing the room, or when privacy is needed.

Note

In systems with audio, this command does not affect the audio.

Synopsis	video mute { get off on toggle }	
Options	get	Returns the current video mute status.
	off	Unmutes the video. (Normal video resumes.)
	on	Mutes the video. (Blue or black screen with message)
	toggle	Changes the camera's video mute status.
Examples	<pre>>video mute get mute: off OK ></pre> <p>Returns video mute status.</p> <pre>>video mute on OK ></pre> <p>Transmits blue or black video.</p>	

trigger

Turn an existing trigger on or off. This command has no effect if the specified trigger has not been defined.

Note

If the web interface's macro/trigger test mode is in use, this command may return parse errors.

Synopsis	trigger <1..10> { off on }	
Parameters	<1..10>	The trigger index (identifier) – triggers 1 through 10 are available.
	{off on}	Set the state of the trigger.
Example	<pre>> trigger 3 on OK</pre> <p>Turns trigger 3 on.</p>	

streaming settings get

Returns current IP and USB streaming settings.

Synopsis	streaming settings get	
Parameters	IP Custom_Frame_Rate	Frame rate (Custom mode).
	IP Custom_Resolution	Resolution (Custom mode).
	IP Enabled	True if IP streaming is enabled, False if it is not.
	IP MTU	The current MTU setting (1400 is default)
	IP Port	Port number used for IP streaming. RTSP default is 554; RTMP default is 1935.
	IP Preset_Quality	Video quality (Easy mode).
	IP Preset_Resolution	Resolution (Easy mode).
	IP Protocol	IP streaming protocol in use (RTSP or RTMP).
	IP URL	URL where the RTSP stream is available.
	IP Video_Mode	Video quality mode (preset or custom).
	USB Active	True if a USB stream is present; false if not.
	USB Device	The USB Device Name currently assigned.
	USB Frame_Rate	Frame rate for the USB stream (negotiated with conferencing client). 0 when no USB stream is present.
	USB Resolution	Resolution of the USB stream (negotiated with conferencing client). 0x0 when no USB stream is present.
	USB Version	2 or 3, as negotiated with the conferencing client. 0 if no USB stream is present.
UVC Extensions_Enabled	Allow or disable far-end control of the camera.	
Example	<pre> >streaming settings get IP Custom_Frame_Rate 15 IP Custom_Resolution 1080p IP Enabled true IP MTU 1400 IP Port 554 IP Preset_Quality Standard (Better) IP Preset_Resolution 720p IP Protocol RTSP IP URL vaddio-huddleshot-stream IP Video_Mode preset USB Active false USB Device HuddleSHOT USB Frame_Rate 0 USB Resolution 0x0 USB Version 3 UVC Extensions_Enabled true OK > </pre>	

streaming ip enable

Set or change the state of IP streaming.

Synopsis	streaming ip enable { get on off toggle }	
Parameters	get	Returns the current state of IP streaming
	on	Enables IP streaming.
	off	Disables IP streaming.
	toggle	Changes the state of IP streaming (on if it was off, or off if it was on). streaming ip enable toggle has the same effect as selecting the Enable IP Streaming checkbox in the web interface.
Example	<pre>>streaming ip enable on > OK Enables IP streaming. >streaming ip enable get enabled: true > OK Returns the current state of IP streaming.</pre>	

network ping

Sends an ICMP ECHO_REQUEST to the specified hostname or IP address.

Synopsis	network ping [count <count>] [size <size>] <string>	
Options	<count>	The number of ECHO_REQUEST packets to send. Default is five packets.
	<size>	The size of each ECHO_REQUEST packet. Default is 56 bytes.
	<string>	The hostname or IP address where the ECHO_REQUEST packets will be sent.
Examples	<pre>>network ping 192.168.1.66 PING 192.168.1.66 (192.168.1.66): 56 data bytes 64 bytes from 192.168.1.66: seq=0 ttl=64 time=0.476 ms 64 bytes from 192.168.1.66: seq=1 ttl=64 time=0.416 ms 64 bytes from 192.168.1.66: seq=2 ttl=64 time=0.410 ms 64 bytes from 192.168.1.66: seq=3 ttl=64 time=0.410 ms 64 bytes from 192.168.1.66: seq=4 ttl=64 time=3.112 ms --- 192.168.1.66 ping statistics --- 5 packets transmitted, 5 packets received, 0% packet loss round-trip min/avg/max = 0.410/0.964/3.112 ms > Sends five ECHO_REQUEST packets of 56 bytes each to the host at 192.168.1.66.</pre>	
	<pre>>network ping count 10 size 100 192.168.1.1 Sends 10 ECHO_REQUEST packets of 100 bytes each to the host at 192.168.1.1. The command returns data in the same form as above.</pre>	

network settings get

Returns the camera's current network settings and MAC address.

Synopsis	<code>network settings get</code>
Example	<pre>network settings get Name eth0:WAN MAC Address 00:1E:C0:F6:CA:7B IP Address 192.168.1.67 Netmask 255.255.255.0 VLAN Disabled Gateway 192.168.1.254 OK ></pre>

system reboot

Reboots the system either immediately or after the specified delay. Note that a reboot is required when resetting the system to factory defaults (`system factory-reset`).

Synopsis	<code>system reboot [<seconds>]</code>	
Options	<code><seconds></code>	The number of seconds to delay the reboot.
Examples	<pre>>system reboot OK > The system is going down for reboot NOW!huddleshot-D8-80-39-62-A7-C5 Reboots the system immediately. >system reboot 30 Reboots the system in 30 seconds. The response is in the same form; the system message appears at the end of the delay.</pre>	

system factory-reset

Gets or sets the factory reset status. When the factory reset status is on, the system resets to factory defaults on reboot.

Synopsis	system factory-reset { get on off }	
Options	get	Returns the camera's current factory reset status.
	on	Enables factory reset on reboot and returns the camera's current factory reset status.
	off	Disables factory reset on reboot and returns the camera's current factory reset status.
Examples 	<pre>>system factory-reset get factory-reset (software): off factory-reset (hardware): off OK ></pre> <p>Returns the factory reset status.</p> <pre>>system factory-reset on factory-reset (software): on factory-reset (hardware): off OK ></pre> <p>Enables factory reset upon reboot.</p> <p>Note <i>This command does not initiate a factory reset. The factory reset takes place on the next reboot.</i></p>	

version

Returns the current firmware version.

Synopsis	version
Example	<pre>>version Audio 0 0.06 Audio 1 CFG 0.15 Audio 1 FW P1.0.1 Audio 2 0.02 Commit 966a78e827a2e6f871011eb820706dcaa64ec0e2 Sensor Version 0.12 System Version HuddleSHOT 1.0.0 USB 01.01.003 OK ></pre>

history

Returns the most recently issued commands from the current Telnet session. Since many of the programs read user input a line at a time, the command history is used to keep track of these lines and recall historic information.

Synopsis	<code>history <limit></code>	
Options	<code><limit></code>	Integer value specifying the maximum number of commands to return.
Examples	<p>history Displays the current command buffer.</p> <p>history 5 Sets the history command buffer to remember the last 5 unique entries.</p>	
Additional information	<p>You can navigate the command history using the up and down arrow keys. This command supports the expansion functionality from which previous commands can be recalled from within a single session. History expansion is performed immediately after a complete line is read.</p> <p>Examples of history expansion:</p> <ul style="list-style-type: none"> * <code>!!</code> Substitute the last command line. * <code>!4</code> Substitute the 4th command line (absolute as per 'history' command) * <code>!-3</code> Substitute the command line entered 3 lines before (relative) 	



help

Displays an overview of the CLI syntax.

Synopsis	<code>help</code>
Example	<p>help</p>



```
Telnet 10.10.24.14
> help
CONTEXT SENSITIVE HELP
[?] - Display context sensitive help. This is either a list of possible
command completions with summaries, or the full syntax of the
current command. A subsequent repeat of this key, when a command
has been resolved, will display a detailed reference.

AUTO-COMPLETION
The following keys both perform auto-completion for the current command line.
and press the space key to complete the command line.
```

exit

Ends the command session and closes the socket.

Synopsis	<code>exit</code>
Example	exit

Specifications

Camera and Image

Image device	1/1.9 CMOS sensor	Pixels	2.12 million (effective)
IP (H.264) RTSP and RTMP Video Resolutions	1080p down to 180p 1080p at 30/25/15; others 60/30/25/15	USB 3.0 (UVC) Video Resolutions	1080p down to 180p at 60/30/15; automatically negotiated
Lens and horizontal FOV	125° at 1x zoom with no dewarping; 110° at 1x zoom with full dewarping		
Min. working distance	250 mm	Min. illumination	100+ lux recommended
Backlight compensation	On or off	White balance	Auto or manual
Sync system	Internal	S/N ratio	Over 50 dB
Remote management	Web interface, Telnet	Power	PoE+

Audio

Microphone input	2-channel, 16-bit, 16 kHz sample rate	EasyMic Port	RJ-45, 12V, bidirectional, balanced
IP Streaming	2-channel (PCM), 16-bit resolution, 48 kHz sample rate	USB Streaming Record/Playback	2-channel (UAC), 16-bit resolution, 48 kHz sample rate
Speaker output	2-channel (stereo), 16-bit, 48 kHz sample rate, 120-20000 Hz		

Physical and Environmental

Height	4.12 in. (10.5 cm)	Weight	5.25 lbs. (2.38 kg)
Width	24.0 in. (61 cm)	Operating/storage temperature	0°C to +40°C (32°F to 104°F)
Depth	3.7 in. (9.4 cm)	Operating/storage humidity	20% to 80% RH, non-condensing

Specifications are subject to change without notice.

Troubleshooting and Care

When the camera doesn't behave as you expect, [check the indicator light](#) on the front before you do anything else.

Use this table to determine whether it's time to call Vaddio Technical Support.

Power and Control

What is it doing?	Possible causes	Check and correct
Nothing. The light on the front is off and no video is available.	The network cable to the camera is bad.	Check using a known good cable from the PoE power injector to the camera
	The wall outlet is not active. (Check by finding out if it powers something else, such as a laptop or phone charger.)	Use a different outlet.
	The camera or its PoE power injector is bad.	Contact your reseller or Vaddio Technical Support.
The light on the front of the camera is off but the web interface and video are available.	The status light is turned off.	You can turn it on again using the LED On setting on the System page (General tab), or using the Telnet command <code>camera led on</code> .
The camera is not responding to the remote and the light is yellow/green.	A firmware update is in progress.	Wait a few minutes, and try again when the light turns blue.
The camera responds to the remote but the web interface is not available.	The camera is not using the IP address you browsed to.	Press the Network button on the remote to see camera information.
The camera operates normally and its web interface is available, but the light is blinking blue.	The camera did not pair successfully with the remote, or the camera entered pairing mode and did not detect a remote.	Reboot the camera or disable the indicator light .

Video and Streaming

What is it doing?	Possible causes	Check and correct
No H.264 video stream.	IP streaming is not enabled.	Enable IP streaming: Streaming page in the web interface.
Conference is using the laptop camera and audio, not the HuddleSHOT camera.	The USB cable is not connected from the camera to the computer.	Connect the USB cable.

Audio

What is it doing?	Possible causes	Check and correct
No audio from the speakers (No far-end audio)	Far-end microphone is muted. The conferencing window may show a mute icon for that site's microphone.	Ask the participants at that site to unmute their microphone.
	Speaker volume is turned all the way down.	You checked that first, right?
Far end reports that they can't hear you. (No near-end audio)	Your microphone is muted.	Unmute your microphone.

Remote

What is it doing?	Possible causes	Check and correct
The camera does not respond to the remote, but the web interface is available and video is available.	The remote is not paired to the camera.	Pair the camera and remote. See Pairing the Remote to the Camera .
	The batteries in the remote are dead.	Put new batteries in the remote.
	The batteries were installed incorrectly in the remote.	Install the batteries as shown in the diagram inside the remote.
	The remote is in standby mode.	Press the button again. This is normal, if it has been more than 3 minutes since anyone used the remote.
Pairing doesn't work. The camera's light changes from blinking cyan to blinking blue.	The remote is already paired with another camera nearby.	Remove and reinstall the batteries in the remote, then try pairing again.
	The camera does not detect the remote.	Replace the batteries in the remote.
The camera does not respond to the remote and the indicator light on the remote is on.	The remote is in the process of pairing or correcting an internal error.	Wait until the remote's indicator light turns off.

Restoring Default Camera Settings

This returns the camera to its original state. If you export the camera's configuration before restoring factory defaults, you will be able to restore the room label, time zone information, and home information by importing the configuration afterward.

Using the multifunction button on the back of the camera: Disconnect the network cable. Then press and hold the multifunction button while reconnecting the cable. Continue to hold the button for about 10 seconds.

From the web interface: Log on using the admin account, go to the System page's Firmware tab, and select Restore Factory Settings.

Operation, Storage, and Care

For smears or smudges on the product, wipe with a clean, soft cloth. Use a lens cleaner on the lens. Do not use any abrasive chemicals.

Keep this device away from food and liquids.

Do not operate or store the device under any of the following conditions:

- Temperatures above 40° C (104° F) or below 0° C (32° F)
- High humidity, condensing or wet environments
- Inclement weather
- Severe vibration
- In a hydraulic press
- Dry environments with an excess of static discharge

Do not attempt to take this product apart. There are no user-serviceable components inside.

Glossary

AEC

Acoustic echo cancellation. Audio processing that subtracts the far-end (speaker) audio from the sound that your microphone picks up.

auto white balance

A setting that allows the camera to manage color adjustments automatically.

backlight compensation

A setting that reduces contrast to adjust for bright light behind the main subject of the shot.

bandwidth

Data transfer rate (bits per second) for the stream. In some cases, using a high bandwidth can slow down other network traffic. On networks with very low bandwidth, video issues may result. Streaming at a lower resolution or frame rate can reduce bandwidth usage.

chroma

A setting that adjusts color intensity.

detail

A setting that adjusts image sharpness. If detail is set too low, the image may appear unrealistically smooth – like an episode of Moonlighting.

dewarping

Image processing to remove the "fish-eye" effect from wide-angle views. Dewarping also disables interstellar travel.

DHCP

Dynamic Host Configuration Protocol. A network management protocol that assigns an IP address to a device automatically when it is connected to the network.

EasyMic

Vaddio's proprietary connectivity standard for conferencing microphones.

echo cancellation

Audio processing that subtracts the far-end (speaker) audio from the sound that your microphone picks up.

FAQ

(Frequently Anticipated Questions) A list questions we hope you will ask, because we're pretty sure we can answer them.

far end

(conferencing) A location in the conference other than the one where you are. Far-end video is what you typically see in a conference – the people at the other end of the call.

Field of View (FOV)

How wide the video image is. Vaddio measures horizontal field of view. Some manufacturers use diagonal field of view, which yields a bigger number for the same actual image area. Tilt your head to one side and diagonal FOV will make sense.

flombodulator

A technically complex item the name of which you can't recall at the moment.

frame rate

The number of output video frames per second. Different outputs (such as the IP stream and the USB stream) may use different frame rates. For streaming, higher frame rates use more bandwidth.

full-duplex

Simultaneous two-way (or multi-way) audio; conference participants at the near end can talk and still hear the participants at the far end(s), as in a face-to-face meeting.

gamma

A setting that adjusts the range (gray density) between bright areas and shadows.

gateway

Network information automatically assigned in a DHCP network. If installing equipment on a non-DHCP network, get this information from the network administrator.

HDMI

A video output format; may also carry audio information.

HID audio controls

(Human Interface Device) Controls to enable conference participants to use the conferencing client to control the audio.

home (camera)

The settings to which the camera returns after a reboot or on exiting standby mode. Depending on the camera's capabilities, home may include zoom, color and lighting settings, and (for PTZ cameras) pan/tilt position.

home button (microphone)

A One Touch trigger control on a tabletop microphone. The button can be associated with one macro in momentary mode, or two macros in latching mode.

HTTP

HyperText Transfer Protocol. The magic that makes websites work.

HTTPS

HyperText Transfer Protocol Secure. The magic that uses encryption to make websites work securely. See SSL certificate for more information.

IP address

Where a given device is on the IP network, logically. The IP address enables the network to route data to the right device – and that's the reason IP address conflicts are bad.

IP address conflict

Two or more devices attempting to use the same IP address on a network. Results are unpredictable but never good.

LED

Light-Emitting Diode. An indicator light.

macro

A defined sequence of commands that a device performs in response to a trigger event.

MTU

Maximum Transmission Unit. The largest number of bytes allowed in a packet. If you don't know what that means, don't change MTU size.

near end

(conferencing) Your location in a conference. When you mute the video, your camera stops sending near-end video.

NLP

(Non-Linear Processing) Audio processing to remove certain particularly challenging types of undesirable audio, such as the echo in a room without acoustic treatment, or background chatter in an office.

NTP

Network Time Protocol. Ensures that NTP-enabled devices on the network all show the same system time, so timestamps are accurate.

pairing

The process of "teaching" two specific devices to recognize each other. The HuddleSHOT camera and its remote must be paired for the remote to control the camera.

PoE, PoE+, PoE++

Power over Ethernet; a means of powering a device using its network connection. Requires a mid-span power injector. PoE+ and PoE++ deliver more power than PoE.

RCLB

Really Cool Logo Badge. A visual cue that the device is a genuine Vaddio product. Accept no substitutes!

resolution

1. The image size. For Vaddio cameras, resolution is expressed in terms of digital TV standards, with 1080p being the default in most cases. Resolution and frame rate are set together on Vaddio cameras.
2. The thing that usually flies out the window by January 10th.

Richard

The reason there are cats (well, pictures of cats) in this manual.

RTMP

Real-Time Messaging Protocol. Used for livestreaming video (and audio, if available) to a service such as YouTube Live.

RTSP

Real-Time Streaming Protocol. Used for streaming video and audio over your network.

soft conferencing client

A conferencing application (such as Zoom, Google Hangouts, or Skype for Business) that uses a computer rather than requiring a conferencing codec.

SSL certificate

A file used with HTTPS proving that a web page really originates from its purported source. If you enable or require HTTPS on a camera or other device without installing an SSL certificate, your browser will pop up security warnings when you try to browse to the device's web interface.

streaming protocol

A set of rules that define how video and audio data are sent over the network. See RTMP and RTSP.

subnet mask

Network information automatically assigned in a DHCP network. If installing equipment on a non-DHCP network, get this information from the network administrator.

trigger

An event, such as pressing the Home button on a connected TableMIC, that can be associated with a macro (defined command sequence). Devices that originate trigger events are sometimes called triggers or trigger devices.

UAC drivers

(Universal Audio Class) Standard USB audio drivers used by Vaddio conferencing products with audio capabilities.

UCC, UC conferencing

Unified Communications Conferencing; refers to soft-client conferencing (such as Zoom or Skype for Business) using a computer with USB-connected peripherals.

USB 2

An older, lower-speed USB protocol; good for audio but offers lower maximum resolutions for video conferencing. USB 2 products can be connected to USB 2 or USB 3 ports on your computer.

USB 3

A high-speed USB protocol, capable of handling high-quality video and audio as in conferencing applications. USB 3 products should be connected to USB 3 ports; performance may be degraded otherwise.

UVC drivers

(Universal Video Class) Standard USB video drivers used by Vaddio cameras. They're the reason your computer doesn't have to stop and download a driver when you connect your new Vaddio USB camera to it.

UVC extensions

Controls in UVC drivers to allow participants at the far end of a conference to control your camera, if it processes UVC commands. The administrator may choose to disable these.

Compliance and Conformity Statements

Compliance testing was performed to the following regulations:

FCC Part 15 (15.107, 15.109), Subpart B	Class A
ICES-003, Issue 54: 2012	Class A
EMC Directive 2014/30/EU	Class A
EN 55032: 2015	Class A
EN 55024: November 2010	Class A
IEC 60950-1:2005 (2nd Edition); Am 1: 2009 + Am 2: 2013	Safety
EN 60950-1: 2006 + A11: 2009 + A1: 2010 + A12: 2011 + A2: 2013	Safety
IEC 62368-1:2014 (2nd Edition)	Safety

FCC Part 15 Compliance

This equipment has been tested and found to comply with the limits for a Class A digital device, pursuant to Part 15, Subpart B, of the FCC Rules. These limits are designed to provide reasonable protection against harmful interference when the equipment is operated in a commercial environment. This equipment generates, uses, and can radiate radio frequency energy and, if not installed and used in accordance with the instruction manual, may cause harmful interference to radio communications. Operation of this equipment in a residential area is likely to cause harmful interference in which case the user will be required to correct the interference at his/her own expense.

Operation is subject to the following two conditions: (1) This device may not cause interference, and (2) This device must accept any interference including interference that may cause undesired operation of the device.



Changes or modifications not expressly approved by Vaddio can affect emission compliance and could void the user's authority to operate this equipment.

ICES-003 Compliance

This digital apparatus does not exceed the Class A limits for radio noise emissions from digital apparatus set out in the Radio Interference Regulations of the Canadian Department of Communications.

Le présent appareil numérique n'émet pas de bruits radioélectriques dépassant les limites applicables aux appareils numériques de la classe A prescrites dans le Règlement sur le brouillage radioélectrique édicté par le ministère des Communications du Canada.



European Compliance

This product has been evaluated for Electromagnetic Compatibility under the EMC Directive for Emissions and Immunity and meets the requirements for a Class A digital device. In a domestic environment this product may cause radio interference in which case the user may be required to take adequate measures.

Standard(s) To Which Conformity Is Declared:



EMC Directive 2014/30/EU

EN 55032: 2015 – Conducted and Radiated Emissions

EN 55024: November 2010 – Immunity

IEC 60950-1: 2005 (2nd Edition); Am 1: 2009 + Am 2: 2013 – Safety

EN 60950-1: 2006 + A11: 2009 + A1: 2010 + A12: 2011 + A2: 2013 – Safety

IEC 62368-1: 2014 (2nd Edition) – Safety

Warranty and Return Policy

Hardware warranty: Two (2) year limited warranty on all parts and labor for Vaddio manufactured products. Vaddio warrants its manufactured products against defects in materials and workmanship for a period of two years from the day of purchase, to the original purchaser, if Vaddio receives notice of such defects during the warranty. Vaddio, at its option, will repair or replace products that prove to be defective. Vaddio manufactures its hardware products from parts and components that are new or equivalent to new in accordance with industry standard practices.

Exclusions: The above warranty shall not apply to defects resulting from improper or inadequate maintenance by the customer, customers applied software or interfacing, unauthorized modifications or misuse, mishandling, operation outside the normal environmental specifications for the product, use of the incorrect power supply, modified power supply or improper site operation and maintenance. OEM and special order products manufactured by other companies are excluded and are covered by the manufacturer's warranty.

Vaddio Customer Service: Vaddio will test, repair, or replace the product or products without charge if the unit is under warranty. If the product is out of warranty, Vaddio will test then repair the product or products. The cost of parts and labor charge will be estimated by a technician and confirmed by the customer prior to repair. All components must be returned for testing as a complete unit. Vaddio will not accept responsibility for shipment after it has left the premises.

Vaddio Technical Support: Vaddio technicians will determine and discuss with the customer the criteria for repair costs and/or replacement. Vaddio Technical Support can be contacted by email at support@vaddio.com or by phone at one of the phone numbers listed on support.vaddio.com.

Return Material Authorization (RMA) number: Before returning a product for repair or replacement request an RMA from Vaddio's technical support. Provide the technician with a return phone number, e-mail address, shipping address, product serial numbers and original purchase order number. Describe the reason for repairs or returns as well as the date of purchase. See the General RMA Terms and Procedures section for more information. RMAs are valid for 30 days and will be issued to Vaddio dealers only. End users must return products through Vaddio dealers. Include the assigned RMA number in all correspondence with Vaddio. Write the assigned RMA number clearly on the shipping label of the box when returning the product. All products returned for credit are subject to a restocking charge without exception. Special order products are not returnable.

Voided warranty: The warranty does not apply if the original serial number has been removed or if the product has been disassembled or damaged through misuse, accident, modifications, use of incorrect power supply, use of a modified power supply or unauthorized repair.

Shipping and handling: Vaddio will not pay for inbound shipping transportation or insurance charges or accept any responsibility for laws and ordinances from inbound transit. Vaddio will pay for outbound shipping, transportation, and insurance charges for all items under warranty but will not assume responsibility for loss and/or damage by the outbound freight carrier. If the return shipment appears damaged, retain the original boxes and packing material for inspection by the carrier. Contact your carrier immediately.

Products not under warranty: Payment arrangements are required before outbound shipment for all out of warranty products.

General RMA Terms and Procedures: RMA's are valid for 30 days and will be issued to Vaddio dealers only.

- End users must return products through Vaddio dealers.
- Before a defective product can be authorized to send in for repair, it must first go through the troubleshooting process with a member of the Vaddio Technical Support team.
- Products authorized for repair must have a valid RMA (Return Material Authorization) number.
 - Vaddio RMA Team will issue the RMA number.
 - An RMA number is to be included in all correspondence with Vaddio.
 - The RMA number must appear clearly on the shipping label (not the box) when the product is returned.
 - A packing slip must be included on the inside of the box with the RMA number listed and reason for RMA return.
- Products received at Vaddio that do not have a valid RMA number clearly marked on the outside of the shipping container may be refused and returned to sender.
- Boxes showing external damage will be refused and sent back to the sender regardless of the clearly marked RMA number and will remain the responsibility of the sender.

RMA Charges (Restocking): All qualified returns must be made in unopened, original packaging with all original materials.

- Initial shipments of equipment that are refused upon attempted delivery, for any reason, are subject to restocking charges.
- The Dealer has up to 60 days from the date of purchase to return Vaddio product for credit for future purchases of Vaddio product only.
- The Dealer has 61 to 90 days from the date of purchase to return Vaddio product with a 15% restocking fee or \$50.00 fee, whichever amount is greater
- The Dealer has up to 30 days from the date of purchase to return OEM and other manufacturer's products with a 15% restocking fee or \$50.00 fee, whichever amount is greater.
- NOTE: Special Order products from other manufacturers (identified in the Vaddio Price Guide as noncancelable, nonreturnable and not refundable) are not eligible for advance replacement from Vaddio.

Advance Replacement Policies: For Vaddio manufactured products, advance replacement will be provided for up to one (1) year after the initial shipment of products.

- NOTE: OEM and other manufacturer's products are excluded from the Vaddio advance replacement policy. Advance replacement will be provided for up to 30 days after initial shipment of OEM products. Thereafter, a return to Vaddio and factory repair is offered during the other manufacturer's warranty period. Vaddio will determine if the returned product is qualified for the OEM warranty.
- NOTE: Special Order products from other manufacturers (identified in the Vaddio Price Guide as noncancelable, nonreturnable and not refundable) are not eligible for advance replacement from Vaddio.

Advance Replacement Procedures: The Vaddio Dealer must submit a non-revocable purchase order for advance replacement equipment at normal dealer pricing. Credit shall be issued upon complete product return (including all accessories) for dealers with Net 30 terms. For credit card accounts, charges will be assessed to the credit card for the replacement and credited back upon complete product return.

- Returns must be made in the original Vaddio packaging with all original materials if at all possible. Vaddio products with missing original materials will be billed to the dealer at dealer price.
- NOTE: OEM products must be returned in the original packaging with all materials and the RMA number written on the shipping label only and not on the OEM box. If the return is incomplete and/or the OEM box is defaced, the product shall be returned to the dealer and the RMA will not be credited.
- Equipment returned with “No Trouble Found” after advanced replacement will be assessed a full 15% or \$50.00 restocking fee (whichever is greater) for each item and may also be assessed for additional charges to compensate for wear, damages and reconditioning.
- All returns must be accompanied by RMA # as stated above.
- All Advanced Replacement products are sent via 2-day service in the continental USA. If the product is requested to be sent via priority or overnight shipping, the Dealer shall pay shipping costs. The dealer can elect to supply their preferred shipping account number.
- International customers are responsible for all freight charges for equipment returned to Vaddio, including international shipping, taxes, and duties, insurance and all other associated logistic charges.

Warranty Repair Terms and Procedures: Vaddio will repair any product free of charge, including parts and labor, within the terms outlined in the warranty agreement for that product.

- Customers must provide proof of the product’s purchase date.
- Product that is within the warranty period will be repaired under the non-warranty terms if:
 - The equipment has been damaged by negligence, accident, act of God, mishandling, used with the incorrect, modified or extended power supply or has not been operated in accordance with the procedures described in the operating and technical instructions.
 - The equipment has been altered or repaired by other than the Manufacturer or an authorized service representative.
 - Adaptations or accessories other than those manufactured or provided by the Manufacturer have been made or attached to the equipment, which in the determination of the Manufacturer, shall have affected the performance, safety or reliability of the equipment; or the equipment’s original serial number has been modified or removed.
- Customer is responsible for shipping charges to send defective product under warranty to Vaddio. Vaddio will pay ground service return shipping charges during the 2nd year of the warranty period.
- Standard return shipping method for products under warranty, but out of the advance replacement warranty period, is ground shipment. Extra charges associated with priority shipping, when requested, will be the responsibility of the customer.

Non-Warranty Repair Terms: Vaddio will repair any non-obsolete product that does not meet the terms of the warranty. Non-warranty repair terms are as follows:

- The customer is responsible for, and agrees to pay, all parts and labor costs associated with the repair. Standard non-warranty repair charges are outlined below.
- Customers must provide payment method and one of the following, prior to receiving an RMA:
 - Hard copy of a PO, for dealers with Net 30 terms and in good standing with Vaddio.
 - Valid credit card number - Credit card will be charged upon shipping repaired product back to customer.
- Request for COD: Customers will be notified of COD charges prior to shipping repaired unit.
- Customer is responsible for all shipping charges both to and from Vaddio, and may use their own carrier.
- Customers will receive a courtesy call notifying them of total repair charges prior to return shipping.

Non-Warranty Repair Charges: Total repair charges (per unit) for a non-warranty repair consist of the following:

- Cost of any replacement parts needed to repair the defect.
- Labor costs billed per hour after minimum charges/time.
- Labor charges include troubleshooting and repair time only.
- Burn-in time and final test time is not included in the labor charges.
- Labor time is rounded to the nearest quarter hour.
- Labor charges are billed at the prevailing rate for the category of equipment repaired, after minimum charges/time. For prevailing labor rates, please contact the Vaddio technical support.
- All shipping and handling costs are the responsibility of the customer for non-warranty repairs.

Minimum Labor Charges: All non-warranty repairs are subject to a minimum evaluation/repair labor charge even if there is no problem found. Please contact Vaddio technical support for the current applicable rate.

Repair Charge Estimates: Estimates on repair charges for a specific problem will not be given before an RMA is issued and the actual product has been evaluated by a Vaddio technician. Repair estimates will be given after the repair department receives and evaluates the unit.

- Customers requesting an estimate on repair charges must do so up front when they call in for an RMA. The RMA team will call or email with the estimate after evaluating the unit and before proceeding with the repair.
- Any product evaluated for a repair estimate is still subject to the minimum labor charges even if the customer decides not to proceed with the repair.
- Vaddio does not guarantee estimates given on repair charges. Actual repair costs may exceed the estimate.
- Customer is responsible for actual repair charges, regardless of estimate.

Repair Policy Notes:

- **Duration of Repair:** Products are repaired on a first come first serve basis. The turn-a-round time of a particular repair is dependent upon circumstances such as product type, the nature of the problem and current repair volumes. Requests for expedited repair service will be considered on a case-by-case basis.
- **Repair Warranty:** Vaddio guarantees all of its repair work, performed on non-warranty items, for 90 days from the day the repaired product is shipped back to the customer. If the original problem described was not resolved or reoccurs within the 90-day period, Vaddio will repair the unit free of labor charges. However additional material charges may apply unless the parts used to affect the repair are again deemed defective.

Photo Credits

This guide may include some or all of these photos.

European Space Agency (ESA) astronaut Samantha Cristoforetti, a Flight Engineer with Expedition 42, photographs the Earth through a window in the Cupola on the International Space Station

By NASA - https://blogs.nasa.gov/ISS_Science_Blog/2015/03/06/women-in-space-part-two-whats-gender-got-to-do-with-it/, Public Domain, <https://commons.wikimedia.org/w/index.php?curid=38834990>

Carl Sagan, Bruce Murray, Louis Friedman (founders) and Harry Ashmore (advisor), on the occasion of signing the papers formally incorporating The Planetary Society

By credit NASA JPL - JPL, Public Domain, <https://commons.wikimedia.org/w/index.php?curid=1180927>

Main Control Room / Mission Control Room of ESA at the European Space Operations Centre (ESOC) in Darmstadt, Germany

By European Space Agency - ESOC flickr, Credit: ESA - Jürgen Mai, CC BY-SA 3.0-igo,

<https://commons.wikimedia.org/w/index.php?curid=36743173>

Expedition 42 on orbit crew portrait, International Space Station, Mar. 7, 2015 – Barry Wilmore (Commander) Top, Upside down, to the right cosmonaut Elena Serova, & ESA European Space Agency Samantha Cristoforetti. Bottom center US astronaut Terry Virts, top left cosmonauts Alexander Samokutyaev and Anton Shkaplerov.

By NASA - <https://www.flickr.com/photos/nasa2explore/16166230844/>, Public Domain,

<https://commons.wikimedia.org/w/index.php?curid=38931301>

European Space Agency astronaut Luca Parmitano, Expedition 36 flight engineer, outside the International Space Station

By NASA - <http://spaceflight.nasa.gov/gallery/images/station/crew-36/html/iss036e016704.html>, Public Domain, <https://commons.wikimedia.org/w/index.php?curid=27263573>

Chris Cassidy, Luca Parmitano, and Karen Nyberg, ISS, 2013. Photo Credit: NASA

Nicolas Altobelli, Rosetta Scientist at ESA's European Space Astronomy Centre, Villanueva de la Cañada, Madrid, Spain

By European Space Agency - Nicolas Altobelli talks to the media, CC BY-SA 3.0-igo,

<https://commons.wikimedia.org/w/index.php?curid=36743144>

Andrea Accomazzo, ESA Rosetta Spacecraft Operations Manager, providing a live update from the Main Control Room at ESA's European Space Operations Centre, Darmstadt, Germany during the Rosetta wake-up day.

By European Space Agency - Live update from the Main Control Room, CC BY-SA 3.0-igo,

<https://commons.wikimedia.org/w/index.php?curid=36743150>

Sleeping goose

By ladypine - Own work, CC BY-SA 3.0, <https://commons.wikimedia.org/w/index.php?curid=1695227>

By Rick Dikeman - Image:Wayne Gretzky 1997.jpg, CC BY-SA 3.0,

<https://commons.wikimedia.org/w/index.php?curid=945698>

Photo AS11-40-5948, Aldrin assembles seismic experiment, by National Aeronautics and Space Administration, courtesy of the NASA History Office and the NASA JSC Media Services Center

Index

A

- admin password 13, 19
 - changing 19
 - default 13
- AEC 6
- AGC (automatic gain control) 37
- Ambient Noise (audio setting) 37
- anatomy of the camera 3
- API 55
 - Telnet 55
- audio 35-38, 51-52
 - controls 36-37
 - Large Room Mode 36
 - Music mode 38
 - muting 35, 52
 - Sound Bar Mode 7, 38
 - volume 51
 - volume controls 35
- Audio page (web) 35-38
- auto iris 46-47
- auto white balance 46-47

B

- backing up a configuration 21
- backlight compensation 46-47
- bandwidth 30
- bit rate (IP streaming setting) 30
- blue gain 46-47
- browser compatibility 11
- button, multifunction 3

C

- cable connectors 3, 5
- camera mount 4-5, 8
 - installing 5
- camera placement 4
- camera specifications 59
- capabilities 1, 59
- CCU settings 46-47
- chroma setting 46-47
- cleaning 62
- color codes for status light 8
- Color Compensation (setting) 44
- color settings 46-47, 49
- command history 58

- compatibility, browsers 11
- conferencing 27-28
- configuration, saving or restoring 21
- connection example 6-7
- Constant Bit Rate (IP streaming setting) 30
- Control Devices page (web) 39
- controls available to admin 13
- controls available to non-admin user 12

D

- damage, preventing 2, 4-5
- default IP address 14
- default settings, restoring 8, 57, 61
- detail setting 46-47
- dewarping 48
- DHCP vs. non-DHCP networks 14
- diagnosing issues 55, 60
- diagnostic logs 26
- Diagnostics page (web) 26
- diagram, connection 6-7

E

- Easy PEQ 37
- EasyMIC port 3
- echo cancellation 6
- equalizer 37

F

- factory defaults, restoring 8, 57, 61
- fault isolation 55, 60
- firmware update 24-25
- firmware version 57

G

- getting help 26
- guest access 19

H

- Help page (web) 26
- home position 46
- hostname 17
- HTTPS, enabling or requiring 20
- HuddleSHOT EasyMIC adapter 7

I

- importing a configuration 21
- inactive sessions (web interface) 19
- indicator light 8, 44, 49
 - behavior 44, 49

- enabling/disabling 44
- meaning of colors 8
- information, conference room 21
- installation 5, 8
 - camera 8
 - camera mount 5
- installation, typical 6-7
- IP address 8, 11, 14, 16
 - camera, discovering 8, 11
 - default 11, 14, 17
 - static, configuring 14, 16
- IP streaming 27, 29-32, 54-55
 - enabling/disabling 27
 - settings 29-32, 54-55
- iris settings 46-47

L

- labels, room 21
- LED control 49
- light, status indicator 8, 49
 - behavior 49
 - meaning of colors 8
- lighting settings 46-47, 49
- location of the camera 4, 21
- log files 26
- login, admin 13
- low-power (standby) state 49-50

M

- macros 39-41
 - creating and editing 40
 - testing 41
- Max Bandwidth (IP streaming setting) 30
- media player 27
- mic boost 37
- microphones 35, 37, 52
 - adjusting 37
 - muting 35, 52
- mount 4-5, 8
 - installing 5
- mounting the camera 4, 8
- MTU (IP streaming setting) 34
- multifunction button 3, 8
- muting 35, 52-53
 - audio inputs 35, 52
 - audio outputs 35, 52
 - microphones 52
 - speakers 52
 - video 53

N

- network configuration 16-17, 56
 - current 56
- network port 3
- Networking page (web) 16-17
- NTP server 18

O

- operating environment 4, 62

P

- packing list 2
- page 16-17, 19-21, 26-32, 34-39
 - Audio 35-38
 - Control Devices 39
 - Diagnostics 26
 - Help 26
 - Networking 16-17
 - Room Labels 21
 - Security 19-20
 - Streaming 27-32, 34
- parametric equalizer 37
- part numbers 2
- passwords 12-13, 19
 - admin, default 13
 - user, default 12
- Path (IP streaming setting) 31
- performance specifications 59
- physical and environmental specifications 59
- ping command 55
- ports 3
- power on/power off 50
- precautions 2, 4
 - for operating the system 4
- product capabilities 1, 59
- product returns and repairs 69

Q

- Quality/Quantization (IP streaming setting) 30

R

- ready state 50
- rebooting 23, 56
- red gain 46-47
- remote control 8-10
 - installing batteries 9
 - pairing with the camera 8, 10
 - standby mode 10

- unpairing 10
- removing image distortion 48
- requirements 4
 - installation 4
 - mounting 4
- reset See also rebooting; restoring default settings
- Resolution (IP streaming setting) 29-30
- restoring a configuration 21
- restoring default settings 8, 57, 61
- Reverberant Room (audio setting) 37
- RJ-45 connectors 5
- room information 21
- Room Labels page (web) 21
- RTMP streaming 27, 32
- RTSP streaming 27, 31

S

- saving a configuration 21
- Security page (web) 19-20
- settings, default, restoring 57, 61
- shelf-mounted cameras 8
- shelf, camera mount 5
- site requirements 4
- software update 24-25
- solving problems 60
- speakers 36, 52
 - muting 52
- specifications 59
- Speech Enhancement (audio setting) 37
- speed 48
 - zoom 48
- SSL certificate 20
- standby (low-power) state 44, 49-50
- Standby Device when USB Disconnects (setting) 44
- static IP address 14, 16
 - configuring 14, 16
- status light 8, 49
 - behavior 49
 - meanings of colors 8
- storage environment 62
- storing a configuration 21
- stream viewer 27
- streaming 27-32, 54-55
 - configuring 28
 - enabling/disabling 27
 - IP 27, 29-30
 - settings 28, 30-32, 54

- state 55
- USB 27-28
- Streaming page (web) 27-32, 34
- streaming URL 31
- supported web browsers 11
- syntax help, Telnet commands 58

T

- TableMIC microphone 6
- technical specifications 59
- technical support 26
- Telnet 20
 - disabling access via 20
- Telnet API 55
- Telnet commands 45-50, 53-58
 - syntax help 45, 58
 - typographical conventions 45
- Telnet session 45, 58
 - ending 58
 - history 58
- temperature, operating and storage 62
- testing 41, 43
 - macros 41
 - triggers 43
- third-party control 45
- time zone 18
- trigger command, failure to execute 43
- trigger devices 39
- triggers 39, 42-43, 53
 - defining 42
 - deleting 42
 - testing 43
- troubleshooting 55, 60

U

- update 24-25
- URL, RTSP streaming 31-32
- USB port 3
- USB streaming 27-28, 54
 - configuring 28
 - settings 54
- user password 12, 19
 - changing 19
 - default 12

V

- Variable Bit Rate (IP streaming setting) 30
- version, firmware 57
- video mute 53

Video Quality (IP streaming setting) 29
video resolution (IP streaming setting) 29
visual parts identification 3
volume controls 35, 51

W

wall mount 5
 installing 5
warranty 4, 69
web browsers supported 11
web interface 11, 15-17, 19-21, 26-32, 34-39
 accessing 11
 accessing via direct connection 15
 Audio page 35-38
 Control Devices page 39
 Diagnostics page 26
 Help page 26
 Networking page 16-17
 Room Labels page 21
 Security page 19-20
 Streaming page 27-32, 34

Z

zoom 48
 speed 48

Vaddio is a brand of Legrand AV Inc. · www.legrandav.com · Phone 800.572.2011 / +1.763.971.4400 · Fax +1.763.971.4464 · Email av.vaddio.support@legrand.com

Visit us at support.vaddio.com for firmware updates, specifications, drawings, manuals, technical support information, and more.

©2019 Legrand AV Inc.

Vaddio is a registered trademark of Legrand AV Inc. All other brand names or marks are used for identification purposes and are trademarks of their respective owners. All patents are protected under existing designations. Other patents pending.

A brand of  legrand®

Commercial AV Brands Chief | Da-Lite | Middle Atlantic | Projecta | Vaddio

vaddio®