



Complete Manual for the

# PrimeSHOT 20 HDMI

PTZ Camera

Document 411-0022-30 Rev B  
July 2018

# Contents

Overview .....	1
What's in this Guide .....	1
Features .....	1
Unpacking the Camera .....	2
A Quick Look at the Camera .....	3
Front of the Camera .....	3
Back of the Camera .....	4
Video Resolution Setting .....	4
Installation .....	5
Before You Install the Camera .....	5
Don't Void Your Warranty! .....	5
Cabling Notes .....	5
Installing the Thin Profile Wall Mount .....	6
About Ceiling-Mounted Cameras .....	6
Basic Connection Diagram .....	6
RS-232 Serial Communication .....	7
Installing the Camera .....	8
Powering Up the Camera .....	9
Status Light .....	9
Using the Remote Control .....	10
Quick Reference .....	10
Details .....	11
Storing a Preset Using the Remote .....	11
Clearing a Preset Using the Remote .....	11
Web Interface .....	12
Browser Support .....	12
User Access .....	13
Administrative Access .....	13
Web Interface Quick Reference .....	14
Compact Menu View .....	14
System Administration .....	15
Configuring Network Settings .....	15
Setting Time Zone and NTP Server .....	16
Managing Access and Passwords .....	17
Adding Room Information to the Screen .....	18
Rebooting the Camera .....	19
Saving or Restoring a Configuration .....	19
Starting a Firmware Update .....	20
Contacting Vaddio Technical Support .....	21
Viewing Diagnostic Logs .....	21

Configuring Camera Behavior .....	22
Storing Preset Positions Including Custom Home .....	22
Adjusting the Color Settings .....	23
Adjusting the Focus .....	24
Setting the Speeds of Camera Movements .....	24
Setting Pan Direction .....	24
Enabling or Disabling Streaming .....	25
Configuring IP Streaming .....	26
Advanced IP Streaming Settings .....	28
Setting Other Camera Behaviors .....	29
Operating the Camera .....	30
Moving the Camera .....	30
Zooming In or Out .....	30
Moving the Camera to a Preset Position .....	30
Stopping or Resuming Video .....	31
Managing the Camera Ready State .....	31
Telnet Serial Command API .....	32
camera home .....	33
camera pan .....	33
camera tilt .....	34
camera zoom .....	35
camera focus .....	35
camera preset .....	36
camera ccu get .....	37
camera ccu set .....	38
camera ccu scene .....	39
camera led .....	39
camera recalibrate .....	39
camera standby .....	40
video mute .....	40
streaming settings get .....	41
network settings get .....	41
network ping .....	42
system reboot .....	42
system factory-reset .....	43
version .....	43
help .....	44
history .....	44
exit .....	44
RS-232 Control .....	45
Camera Movement, Zoom, and Focus Commands .....	45

Movement, Zoom, and Focus Inquiry Commands .....	47
Color and Light Management Commands .....	48
Shutter Speed Values (CAM_Shutter) .....	50
Iris Values (CAM_Iris) .....	51
Iris Gain and Gain Limit Values (CAM_Gain) .....	51
Color and Light Management Inquiry Commands .....	52
Other Commands .....	52
Other Inquiry Commands .....	53
Specifications .....	54
Troubleshooting and Care .....	55
Status Light .....	56
Restoring Default Camera Settings .....	57
Operation, Storage, and Care .....	57
Compliance Statements and Declarations of Conformity .....	58
FCC Part 15 Compliance .....	58
ICES-003 Compliance .....	58
European Compliance .....	59
Warranty Information .....	60
Photo Credits .....	61
Index .....	62

## Overview

This guide covers the PrimeSHOT™ 20 HDMI PTZ camera:

- PrimeSHOT 20 HDMI (black), North America – 999-30420-000
- PrimeSHOT 20 HDMI (white), North America – 999-30420-000W
- PrimeSHOT 20 HDMI (black), Europe and UK – 999-30420-001
- PrimeSHOT 20 HDMI (white), Europe and UK – 999-30420-001W
- PrimeSHOT 20 HDMI (black), Australia and New Zealand – 999-30420-009
- PrimeSHOT 20 HDMI (white), Australia and New Zealand – 999-30420-009W
- PrimeSHOT 20 HDMI (black) with HDMI Extenders, North America – 999-30420-300
- PrimeSHOT 20 HDMI (white) with HDMI Extenders, North America – 999-30420-300W
- PrimeSHOT 20 HDMI (black) with HDMI Extenders, Europe and UK – 999-30420-301
- PrimeSHOT 20 HDMI (white) with HDMI Extenders, Europe and UK – 999-30420-301W
- PrimeSHOT 20 HDMI (black) with HDMI Extenders, Australia and New Zealand – 999-30420-309
- PrimeSHOT 20 HDMI (white) with HDMI Extenders, Australia and New Zealand – 999-30420-309W



## What's in this Guide

This guide covers

- Unpacking and installation
- The system's physical features
- Configuration and system administration
- Controlling the camera using the IR remote or web interface
- Controlling the camera using Telnet or RS-232 commands
- Specifications
- Troubleshooting and maintenance
- Warranty and compliance/conformity information

For your convenience, the information you need to install this product is also available in the smaller, stand-alone **Installation Guide for the PrimeSHOT 20 HDMI PTZ Camera**.

Download manuals, dimensional drawings, and other information from [www.vaddio.com/support](http://www.vaddio.com/support).

## Features

- PTZ camera for medium to large venues such as houses of worship and lecture theaters
- 2.12 Megapixel effective, native 1080p/60 full HD image sensor
- 20x optical zoom, 55° horizontal field of view (wide end)
- Simultaneous HDMI 1.3, S-Video, and IP streaming outputs
- Precise pan and tilt movements at up to 90° per second
- Presenter-friendly IR remote control
- Integration-ready Telnet or serial RS-232 control
- Full administrative control via web interface; manage the camera remotely while monitoring the stream separately

## Unpacking the Camera

Make sure you received all the items you expected.



### Caution

Always support the camera's body when lifting or moving it. Lifting the camera by its head or mounting arm will damage it.

- 999-30420-000 – PrimeSHOT 20 HDMI (black), North America
- 999-30420-000W – PrimeSHOT 20 HDMI (white), North America
- 999-30420-001 – PrimeSHOT 20 HDMI (black), Europe and UK
- 999-30420-001W – PrimeSHOT 20 HDMI (white), Europe and UK
- 999-30420-009 – PrimeSHOT 20 HDMI (black), Australia and New Zealand
- 999-30420-009W – PrimeSHOT 20 HDMI (white), Australia and New Zealand

- PrimeSHOT 20 HDMI camera
- Thin Profile Wall Mount with mounting hardware
- Vaddio IR Remote Commander
- 12 VDC, 3.0 Amp power supply with AC cord set(s)
- Quick-Start Guide



- 999-30420-300 – PrimeSHOT 20 HDMI (black) with HDMI Extender, North America

- 999-30420-300W – PrimeSHOT 20 HDMI (white) with HDMI Extender, North America

- 999-30420-301 – PrimeSHOT 20 HDMI (black) with HDMI Extender, Europe and UK

- 999-30420-301W – PrimeSHOT 20 HDMI (white) with HDMI Extender, Europe and UK

- 999-30420-309 – PrimeSHOT 20 HDMI (black) with HDMI Extender, Australia and New Zealand

- 999-30420-309W – PrimeSHOT 20 HDMI (white) with HDMI Extender, Australia and New Zealand

- PrimeSHOT 20 HDMI camera
- Thin Profile Wall Mount with mounting hardware
- Vaddio IR Remote Commander
- 12 VDC, 3.0 Amp power supply with AC cord set(s)
- Quick-Start Guide
- C2G HDMI Extender Transmitter unit
- C2G HDMI Extender Receiver unit
- 5VDC 1.0A Extender power supply with regional plugs, quantity 2
- 1 ft (0.3 m) HDMI cable
- C2G HDMI Extenders User Booklet



## A Quick Look at the Camera

This section covers the physical features of the camera.

### Front of the Camera



**Camera and Zoom Lens:** The PrimeSHOT 20 HDMI camera features a 20x optical zoom lens.

**IR sensor:** Receives signals from the IR remote. Make sure there's nothing directly in front of the camera base, and point the remote at the camera.

**Status light:** The multi-colored LED indicates the camera's current state. This light can be turned off.

- Blue – Camera is active
- Red – Tally
- Purple – Standby mode or booting
- Yellow – Firmware update is in progress
- Blinking red – Video mute is on (UC color scheme only)
- Blinking yellow – Motor out of calibration
- Blinking purple – Error

**Note**

*By default, the camera's status light is active during normal operation; however, it can be configured to remain off when the camera is powered up. The camera may be sending video even if the indicator light is off.*

## Back of the Camera



From left to right:

- **Power connector** – Connect the 12 VDC, 3 A power supply shipped with the camera.
- **Rotary switch** – Select the video output resolution.
- **Ethernet connector** – Connect to the network.
- **RS-232 connector** – Optional. Connect to a camera controller to manage the camera.
- **S-Video connector** – S-Video output; can be set to NTSC or PAL.
- **HDMI connector** – HDMI 1.3 video output.

## Video Resolution Setting

Use the rotary switch on the back of the camera to set the desired HDMI output resolution.

Rear Rotary Switch

0	720p/59.94	B	1080p/50
1	1080i/59.94		
2	1080p/59.94	A	
3	720p/60	B	
4	1080i/60	C	
5	1080p/60	D	
6	720p/50	E	
7	1080i/50	F	

The S-Video output can be set to PAL or NTSC in the administrative interface (see [Setting Other Camera Behaviors](#)). Default is NTSC.



## Installation

This section covers:

- Selecting the location for the camera
- Installing the mount
- Connecting the camera
- Mounting the camera

### Before You Install the Camera

- Choose a mounting location that will optimize camera performance. Consider camera viewing angles, lighting conditions, line-of-sight obstructions, and in-wall obstructions where the camera is to be mounted.
- Ensure that the camera body can move freely and will normally point away from the ceiling and lights. The camera will not perform well if it is pointed toward a light source such as a light fixture or window.
- Follow the installation instructions included with the camera mount.

### Don't Void Your Warranty!

#### **Caution**

*This product is for indoor use. Do not install it outdoors or in a humid environment without the appropriate protective enclosure. Do not allow it to come into contact with any liquid.*

*Use only the power supply included with this product. Using a different one will void the warranty, and could create unsafe operating conditions or damage the product.*

*Do not install or operate this product if it has been dropped, damaged, or exposed to liquids. If any of these things happen, return it to Vaddio for safety and functional testing.*

### Cabling Notes

#### **Note**

*Use standard RJ-45 connectors and a good crimping tool. Do not use pass-through RJ-45 connectors. Poorly crimped connectors can damage the connectors on the product, cause intermittent connections, and degrade signal quality. Test cable pin-outs and continuity before connecting them.*



**Intact** – will make reliable contact with cable connector



**Damaged** – Bent contact fingers will NOT make reliable contact with cable connector

#### **Pro Tip**

*Label all cables at both ends.*

## Installing the Thin Profile Wall Mount

The PrimeSHOT 20 HDMI camera is shipped with a Thin Profile Wall Mount. Other mounting options are available as well. Contact us if you don't have the camera mount you need.

You can install the camera wall mount to a 2-gang wall box or directly to the drywall.

- If you mount it to drywall, use the wall anchors provided with the wall mount.
- If you mount it to a wall box, use the cover plate screws supplied with the wall box.

If you install the camera wall mount to drywall, use the wall anchors provided with the mount.

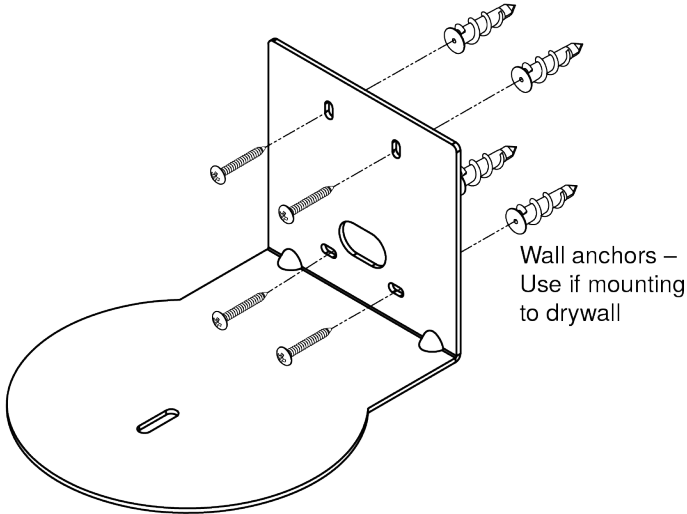

## About Ceiling-Mounted Cameras

If you use an inverted mount, set the camera's Image Flip soft DIP switch ON. See [Setting Other Camera Behaviors](#).

## Basic Connection Diagram

The Quick-Start Guide for the PrimeSHOT 20 HDMI PTZ Camera provides additional information.



## RS-232 Serial Communication

The RS-232 serial port (RJ-45, color-coded blue) on the camera's back panel enables third-party control.

Parameter	Value
Communication Speed	9600 bps (default)
Number of start bits	1
Number of stop bits	1
Number of data bits	8
Parity	None
Flow control	None

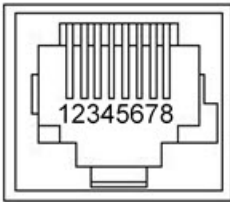

Connector pin-out:

- Pin 1: Not used
- Pin 2: Not used
- Pin 3: Not used
- Pin 4: Not used
- Pin 5: Not used
- Pin 6: GND
- Pin 7: RXD (from TXD of control source)
- Pin 8: TXD (to RXD of control source)

**Caution:**

*Check Cat-5 cables for continuity before using them. Using the wrong pin-out may damage the camera system and void the warranty. Pro tip: Label your cables.*

## Installing the Camera

### Caution

Before you start, be sure you can identify all cables correctly. Connecting a cable to the wrong port can result in equipment damage.

### Caution:

Check Cat-5 cables for continuity before using them. Using the wrong pin-out may damage the camera system and void the warranty. Pro tip: Label your cables.

1. Verify that you have set the switch on the back of the camera to the desired video resolution.
2. Route the cables through the opening in the mounting shelf and connect them to the camera.

### Caution:

Use the power supply shipped with the camera. Using a different power supply will damage the camera and void the warranty, and may create an unsafe operating condition.

3. Place the camera on the mount.

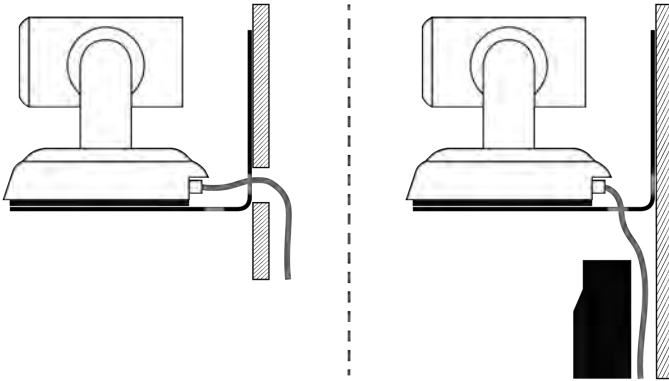

4. Attach the camera to the mount using the mounting screw supplied with the camera.

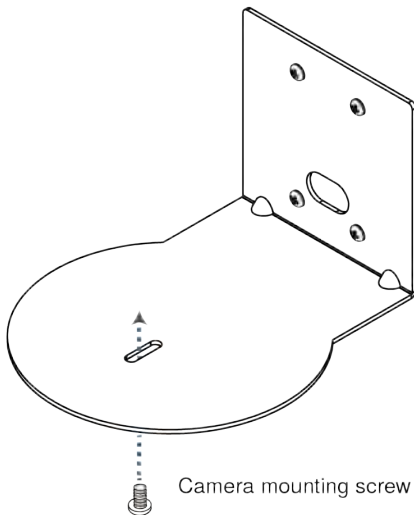

Image for illustration only; not to scale. Camera and mount details may differ.

### Note

If the camera is jostled or bumped, it may require a pan-tilt reset.

## Powering Up the Camera

Connect camera power.

The camera will initialize and move. This will take a few seconds. When an image is available, the camera is ready to accept control information.

## Status Light

The light in the camera's base indicates its current state.

- Blue – Camera is active
- Purple – Standby mode or booting
- Yellow – Firmware update is in progress
- Blinking red – Video mute is on (UC color scheme only)
- Blinking yellow – Motor out of calibration
- Blinking purple – Error

### **Caution**

*Do not remove power or reset the camera while the indicator is yellow, showing a firmware update in progress. Interrupting a firmware update can make the camera unusable.*

### **Note**

*By default, the camera's status light is active during normal operation; however, it can be configured to remain off when the camera is powered up. The camera may be sending video even if the indicator light is off.*

## Using the Remote Control

The remote provides basic camera control.

### Quick Reference

What do you need to do?	Button(s)
Power on or standby	<b>Power</b> (green button at top right)
Select the camera to control (if this remote controls more than one)	<b>Camera Select</b> buttons 1 through 3 (second row on the remote)
Discover the camera's IP address	<b>Data Screen</b> button (top left) – press and hold for 3 seconds
Move the camera	Arrow buttons and <b>Home</b> button (dark red)
Move the camera to a preset position	<b>Position Preset</b> buttons 1 through 6 (bottom two rows)
Focus the camera	<b>Auto Focus</b> button (near arrow buttons) <b>Manual Focus</b> buttons <b>Near</b> and <b>Far</b> (below Zoom Speed buttons)
Change zoom speed	<b>Zoom speed</b> buttons – Slow <b>T</b> and <b>W</b> or Fast <b>T</b> and <b>W</b> for telephoto (zoom in) and wide-angle (zoom out) modes (center)
Adjust for excess light behind the camera's subject	<b>Back Light</b> button (top center)
Correct a motor calibration fault condition (blinking yellow light)	<b>Pan-Tilt Reset</b> button (center right, beside arrow buttons)

## Details

The remote provides the following functions:

**Data Screen** – Press and hold for 3 seconds to display the camera’s IP address and MAC address on the near-end display. Press momentarily to dismiss the information.

**Power indicator** – Shows power on, IR transmission, and battery level.

**Power** – Switch the selected camera on or off.

**Back Light** – Use or turn off back light compensation.

**Camera Select** – In multi-camera installations, selects the camera to be controlled. See [Setting Other Camera Behaviors](#) for information on configuring the camera as camera 1, 2, or 3.

**Pan/Tilt (arrow button) controls and Home button** – Control the camera’s position.

**Std. Pan and Rev. Pan** – Control how the camera responds to the arrow buttons. Helpful for ceiling-mounted cameras and installations where the camera will point at the person using the remote.

**Pan/Tilt Reset** – Recalibrate the pan and tilt motors. If the camera gets jostled, you may need to push this button to ensure that the camera moves accurately to its home and preset positions.

**Auto Focus** – Switch the camera to Auto-Focus mode.

**Zoom Speed** – Select Slow or Fast movements for telephoto and wide-angle shots.

- **T** (slow and fast) – Telephoto
- **W** (slow and fast) – Wide-angle

**Manual Focus** – Switch the camera to Manual Focus mode.

**Near (-) adjustment** – Moves the focus nearer when in manual focus mode.

**Far (+) adjustment** – Moves the focus farther when in manual focus mode.

**Position Presets 1 through 6** – Move the camera to a predefined position.

**Preset** – Save the camera’s current position as one of the numbered presets.

**Reset** – Clear the saved position presets.

The web interface offers greater control over camera movements to presets, and provides additional presets.

## Storing a Preset Using the Remote

Set up the shot using the pan, tilt, and zoom controls. Then hold down the **Preset** button and press one of the numbered preset buttons.

## Clearing a Preset Using the Remote

Press and hold the **Reset** button while pressing the preset number you want to clear.



## Web Interface

The camera's web interface allows control via a network connection, using a browser. Password-protected pages provide administrative access to tasks such as setting passwords, changing the IP address, viewing diagnostics, and installing firmware updates. The user login (or guest access, if it is enabled) provides access to camera controls similar to those available from the IR remote.

You will need to know the camera's IP address to use the web interface. If the LAN has a DHCP server, the camera will get its IP address, gateway and routing information automatically and you will be able to browse to it. If not, you will need to configure the camera to use a static IP address.

### **To display the camera's IP address:**

1. Point the remote at the camera and press the Data Screen button. The camera overlays its IP address and MAC address on the video output.
2. Press the button again to dismiss the information display.

If the address is 169.254.1.1, the camera is using its default IP address and you will need to configure it for your network. You can configure the camera's static IP address either through the network or from a computer connected directly to its Ethernet port. You may need a crossover cable.

### **Note**

*Work with your IT department to determine the correct IP address, subnet mask, and gateway information.*

### **To access the web interface:**

Enter the IP address or hostname in your browser's address bar. If you use the hostname, you may need to enter `http://` or `https://` as a prefix to keep the browser from treating it as a search query.

## Browser Support

We have tested this product with these web browsers:

- Chrome®
- Microsoft® Internet Explorer®
- Safari®
- Firefox®

We test using the browser version available from the vendor at that time. Older versions of these browsers are likely to work, and other browsers may also work.



## User Access

By default, the web interface opens to the Controls page without requiring a login; but if the administrator has changed the guest access setting, you will need to log in. The default user password is **password**. Only the camera control page is available with user-level access.

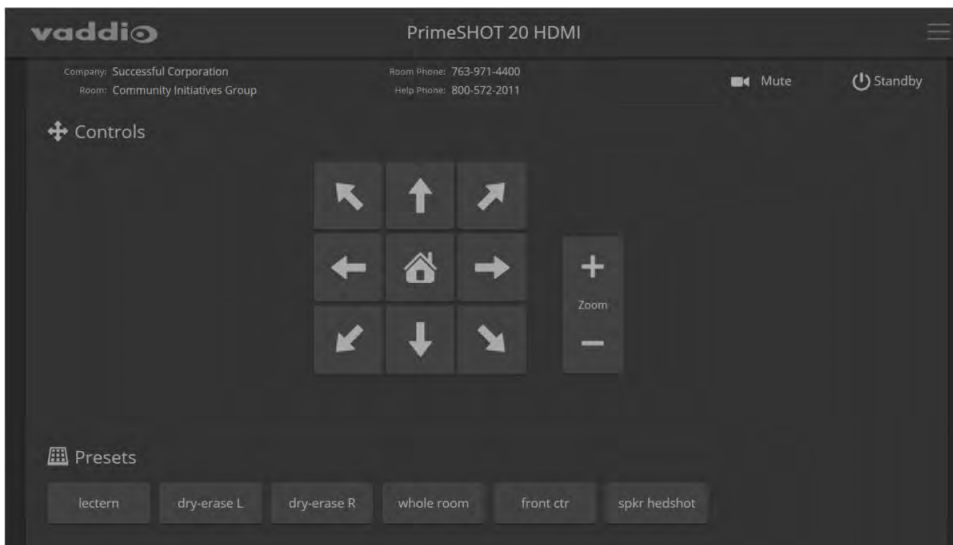

## Administrative Access

If you are on the Controls screen, you're logged in at the user level, or guest access is enabled and you're not logged in at all. Open the menu to log in as admin.

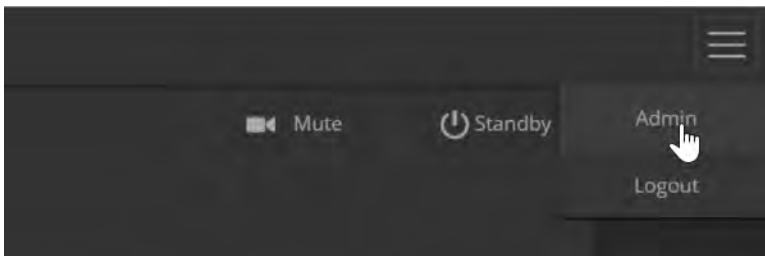

The default admin password is **password**.

Logging in as Admin gives you access to configuration and system administration tasks:

- Camera – Additional control over camera behavior related to camera zoom and color management.
- Streaming – Set up IP (H.264) streaming to meet your organization's requirements.
- Room Labels – Information to display on the web interface screens, including the conference room name and phone number and the in-house number for AV assistance.
- Networking – Ethernet configuration.
- Security – Set passwords and manage guest access.
- Diagnostics – View or download logs when troubleshooting issues.
- System – View firmware version and hardware switch settings, access soft DIP switches, reboot, restore factory defaults, and run firmware updates.
- Help – Tech support contact information and a link to the product information library on the Vaddio website.
- Logout – Leave the web interface in a password-protected state. If guest access is on, this returns the web interface to the Controls page at guest access level.

## Web Interface Quick Reference

Where to find the controls you need right now.

What do you need?	Go to this page
Camera operation <ul style="list-style-type: none"> <li>■ Stop sending video (video mute)</li> <li>■ Enter or exit standby mode</li> </ul>	(any page)
Access management <ul style="list-style-type: none"> <li>■ Guest access</li> <li>■ Account passwords</li> <li>■ Automatic logout for idle sessions</li> </ul>	Security
IP streaming settings	Streaming
Other IP settings <ul style="list-style-type: none"> <li>■ Hostname</li> <li>■ DHCP or static addressing</li> <li>■ Static: IP address, subnet mask, gateway</li> </ul>	Networking
Date and time, time zone, and NTP server	Networking
Information about the camera <ul style="list-style-type: none"> <li>■ Room location and phone number</li> <li>■ Help desk phone number</li> </ul>	Room Labels
Vaddio Technical Support contact information	Help
Diagnostic logs	Diagnostics

## Compact Menu View

By default, the navigation buttons in the administrative interface display an icon and a text label.

The web interface provides a compact view of the menu buttons along with the standard view. The button at the bottom of the menu toggles between the two views.

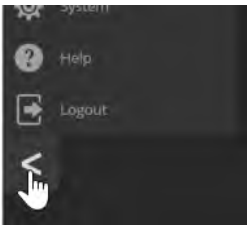

## System Administration

Administrative tasks are on these pages:

- Networking – Network configuration, date/time, and time zone settings
- Security – Passwords, guest access, other IT security-related settings
- Room Labels – Helpful information to display in the web interface
- System – Controls to reboot, reset to factory defaults, and run firmware updates
- Help – Contact information for Vaddio Technical Support and links to more information
- Diagnostics – Logs to help Vaddio Technical Support troubleshoot issues

## Configuring Network Settings

### NETWORKING PAGE

#### Caution

*Consult your IT department before editing network settings. Errors in network configuration can make the camera and its IP stream inaccessible from the network. Do not change DHCP/Static addressing, IP address, subnet mask, or gateway unless you are very familiar with the characteristics and configuration of the network where you install the camera.*

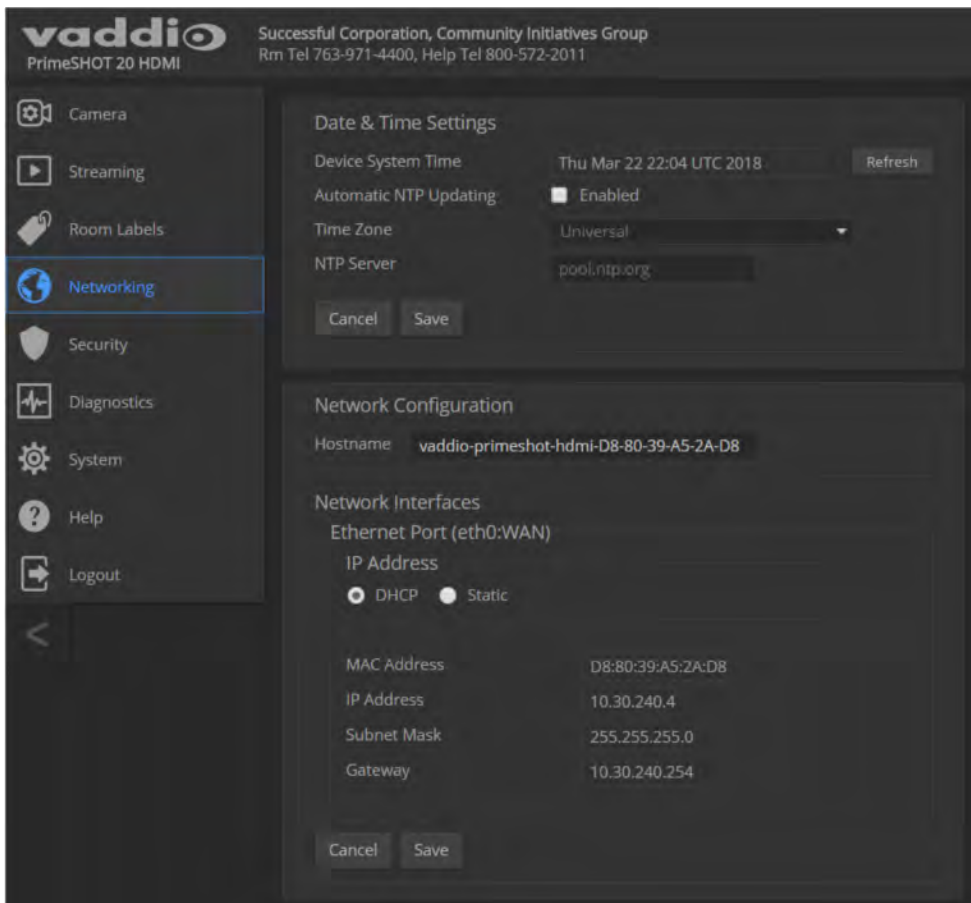

Editable network settings include:

- The camera's hostname
- Choice of static IP addressing or DHCP addressing
- IP address, subnet mask, and gateway, if static IP addressing is used

If your network supports hostname resolution, you may find it convenient to change the camera's hostname.

DHCP is the default setting, but the camera will use the default address of 169.254.1.1 if no DHCP server is available. You will only be able to enter the IP address, subnet mask, and gateway if you set IP Address to Static.

## Setting Time Zone and NTP Server

### NETWORKING PAGE

Using automatic NTP updating ensures that the timestamps in the camera's diagnostic log are accurate. Specifying your time zone may make it easier to match logged events with other actions and external events.

1. To make the time zone and NTP server editable, enable Automatic NTP Updating.
2. Select the desired time zone from the list.
3. If desired, specify the NTP server to use. If you are not sure about this, use the default.

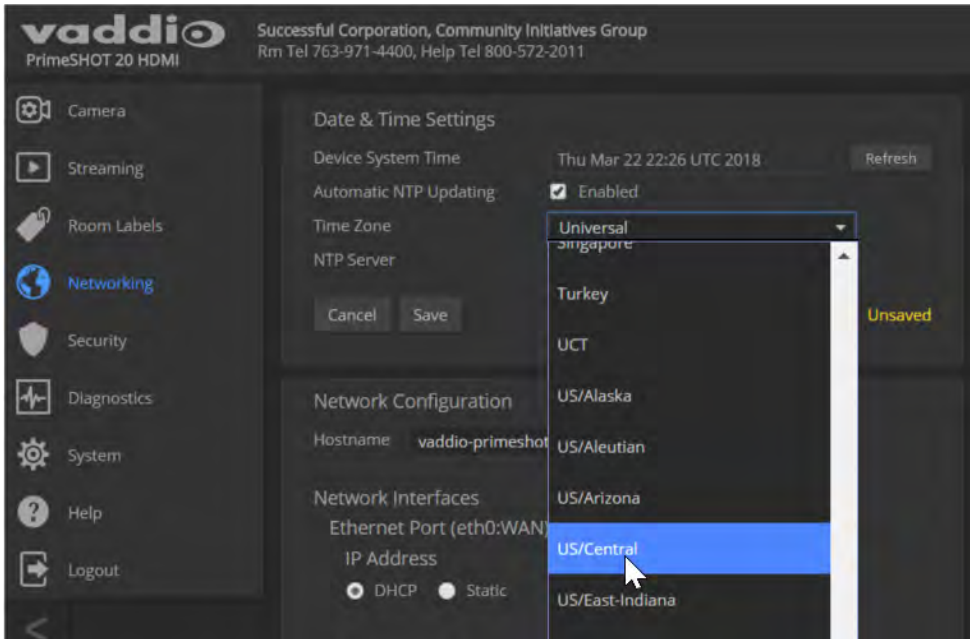

## Managing Access and Passwords

### SECURITY PAGE

Things you can do on this page:

- Allow people to access the Controls screen without logging on (Allow Guest Access) – this is enabled by default
- Set whether inactive sessions log off automatically or not (Automatically Expire Idle Sessions) – by default, inactive sessions expire after 30 minutes
- Change the password for the admin account (default is **password**)
- Change the password for the user account (default is **password**)
- Disable Telnet access

The Security page also provides advanced settings for web access, to configure the camera to comply with your organization's network security policies.

#### Note

**For best security, Vaddio strongly recommends changing the user and admin passwords. Using the default passwords leaves the product vulnerable to tampering. Be sure you have a way to remember the passwords after changing them.**

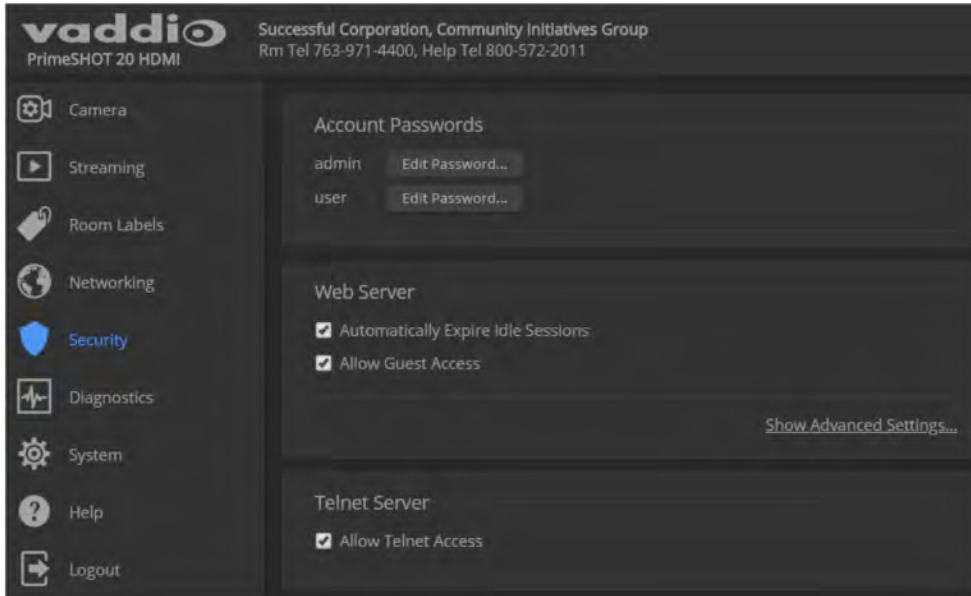

Advanced settings include:

- Use HTTPS connection/Use HTTP connection
- HTTP Access Enabled (selected by default)
- Manage SSL Certificate

**Note**

Consult your IT department before disabling Telnet access or making any changes to the Advanced settings.

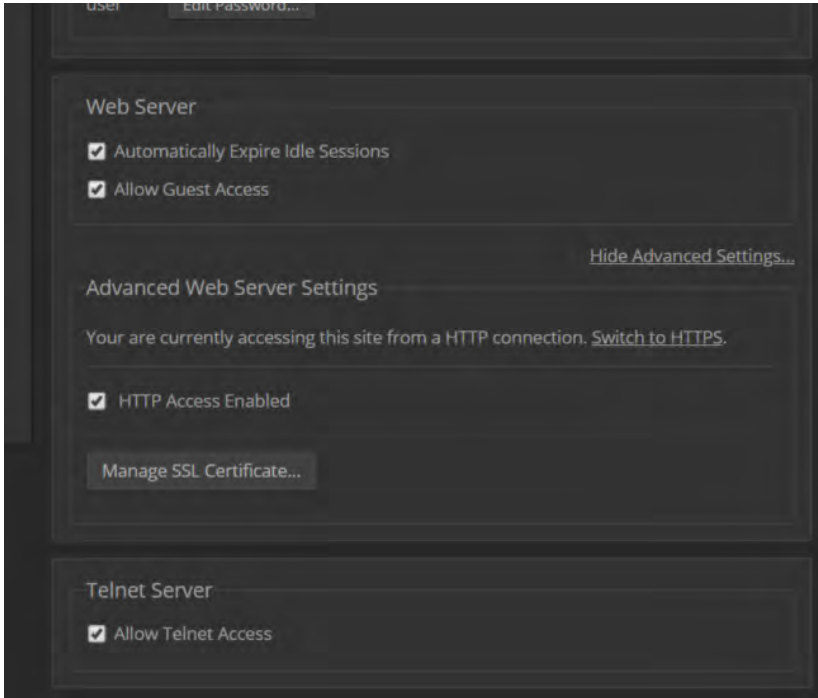

## Adding Room Information to the Screen

### ROOM LABELS PAGE

Enter your organization's name, the conference room name and phone number, and the number for people to call for in-house A/V support. This information is displayed on every page of the web interface.

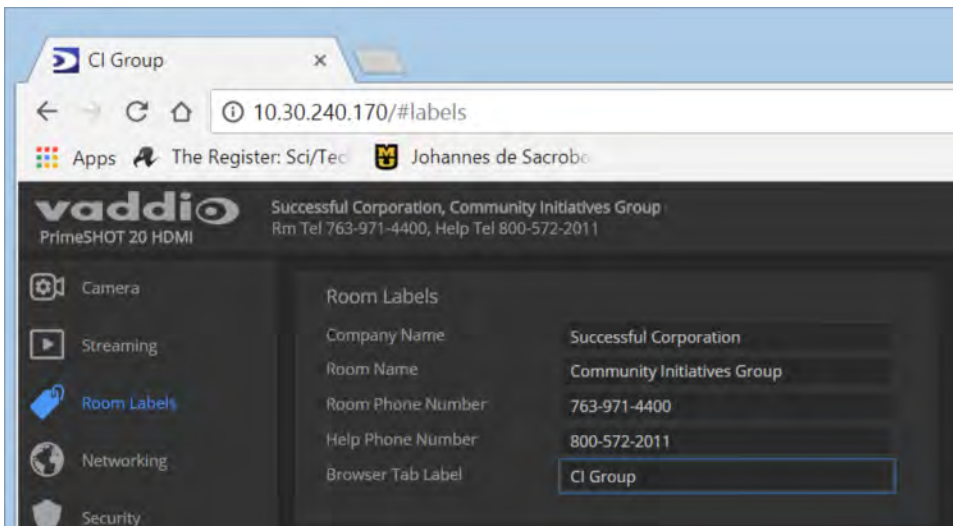

## Rebooting the Camera

SYSTEM PAGE, FIRMWARE TAB

This can help if the camera stops responding as you expect. In the System Utilities section, select Reboot.

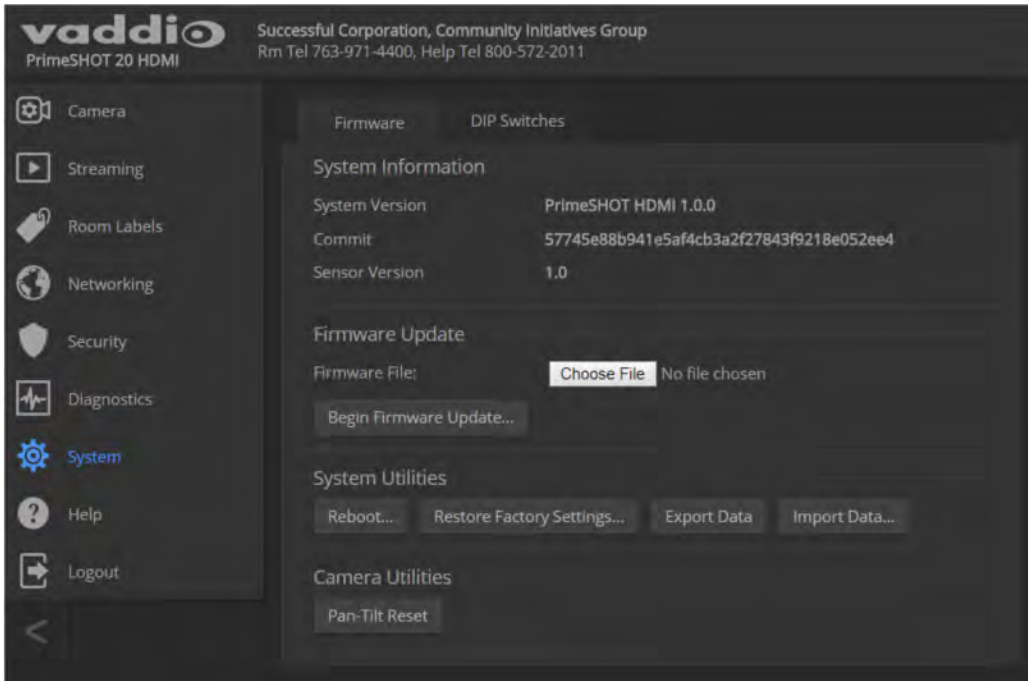

## Saving or Restoring a Configuration

SYSTEM PAGE, FIRMWARE TAB

If you need to configure several cameras the same way, you can configure the first one, export its configuration, and then import the configuration to the other cameras. The export downloads to your computer as a `.dat` file. The filename is the camera's hostname.

### Note

*If the camera is using an older software version, it may be unable import a configuration that was exported from a camera using a different version of software.*

## Starting a Firmware Update

SYSTEM PAGE, FIRMWARE TAB

1. Be sure you have downloaded the appropriate update file to your computer.
2. Select Choose File. In the box that opens, select the update file.

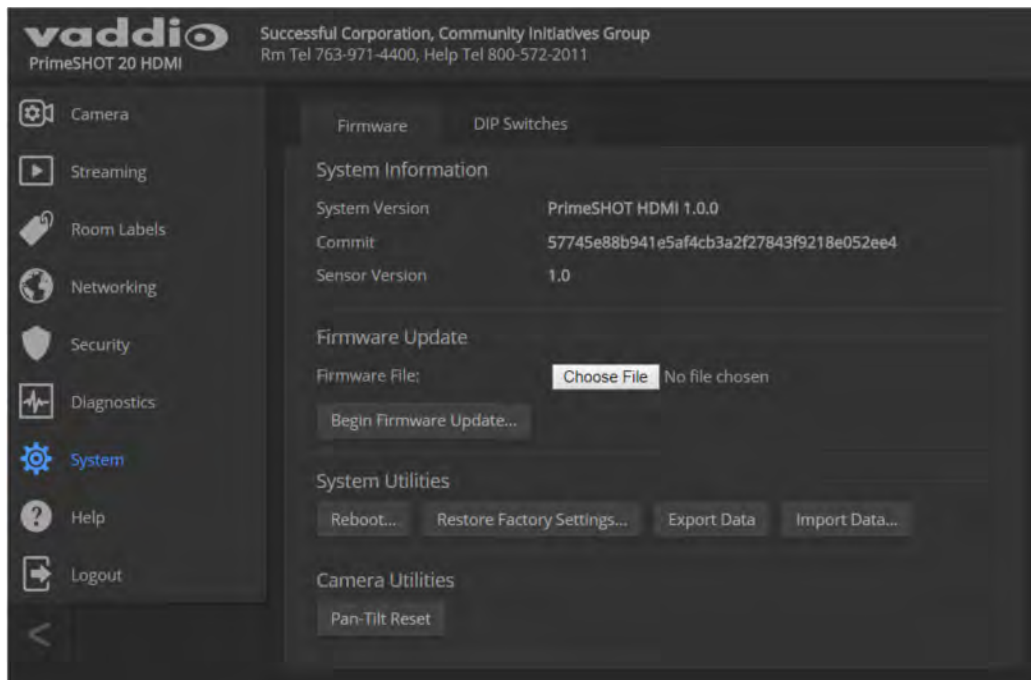

3. Select Begin Firmware Update.
4. READ the information in the Confirm dialog box and be sure you understand it. It may seem boring, but it could save you some time and aggravation.
5. When you are ready to start the update, select Continue. A progress message box opens and the indicator light on the front of the camera turns yellow to show the firmware update is in progress. If the update process presents warnings or error messages, read them carefully.  
The camera reboots when the update is complete.
6. Contact Vaddio Technical Support if you encounter any problems with the update.

### **Caution**

*Do not remove power or reset the camera while the indicator is yellow, showing a firmware update in progress. Interrupting a firmware update can make the camera unusable.*



## Contacting Vaddio Technical Support

### HELP PAGE

If you can't resolve an issue using your troubleshooting skills (or the [Troubleshooting](#) table in this manual), we are here to help.

You'll find information for contacting Vaddio Technical Support on the Help screen.



## Viewing Diagnostic Logs

### DIAGNOSTICS PAGE

If you encounter a problem that you can't solve, your Vaddio technical support representative may ask you to download and email the log file available from the Diagnostics screen.

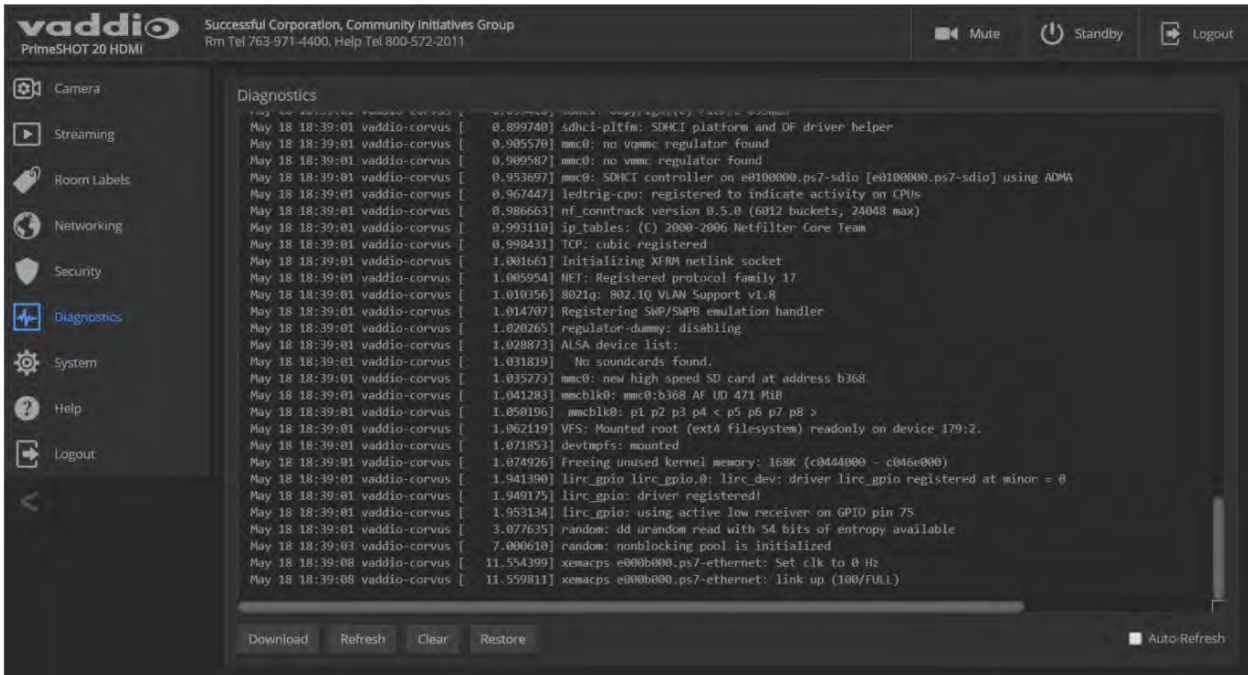

## Configuring Camera Behavior

Basic camera configuration tasks are available on the Camera page:

- Set a custom Home position and other presets
- Adjust for the lighting in the room
- Set pan, tilt, and zoom speeds

Other camera configuration tasks are available on these pages:

- Streaming – IP streaming settings
- System (DIP Switches tab) – How the camera responds to the remote, status light behavior, image flip, and other settings

## Storing Preset Positions Including Custom Home

1. Set up the camera shot, then use the Store button to open the Store Preset box.
2. Select one of the preset buttons – either a numbered preset or the Home button.
3. To save the current CCU settings along with the camera position, check Store with Current Color Settings.
4. Store the preset.

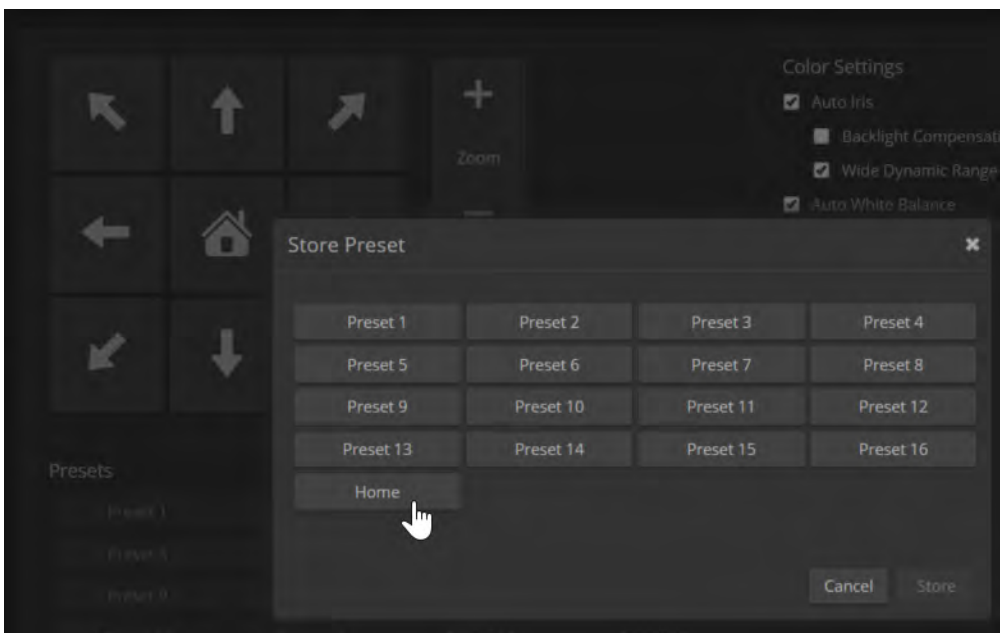

## Adjusting the Color Settings

Fine-tune the color and lighting as needed using the Color Settings controls.

- **Auto Iris** allows the camera to compensate automatically for the light level. Clear this box to adjust iris and gain manually.
- **Backlight Compensation** (available with Auto Iris) reduces contrast to adjust for bright light behind the main subject of the shot. This setting can't be used with Wide Dynamic Range.
- **Wide Dynamic Range** (available with Auto Iris) increases the contrast between the brightest and darkest areas. This setting can't be used with Backlight Compensation.
- **Auto White Balance** adjusts color automatically. Clear this box to adjust red gain and blue gain manually.
- **Red Gain** and **Blue Gain** (available when Auto White Balance is not selected) provide manual color adjustment.
- **Detail** adjusts the image sharpness. If the video looks grainy or “noisy,” try a lower Detail setting.
- **Chroma** adjusts the color intensity.
- **Gamma** adjusts the range between bright areas and shadows.

If you make a change that you don't like, start over by selecting and then deselecting Auto White Balance.

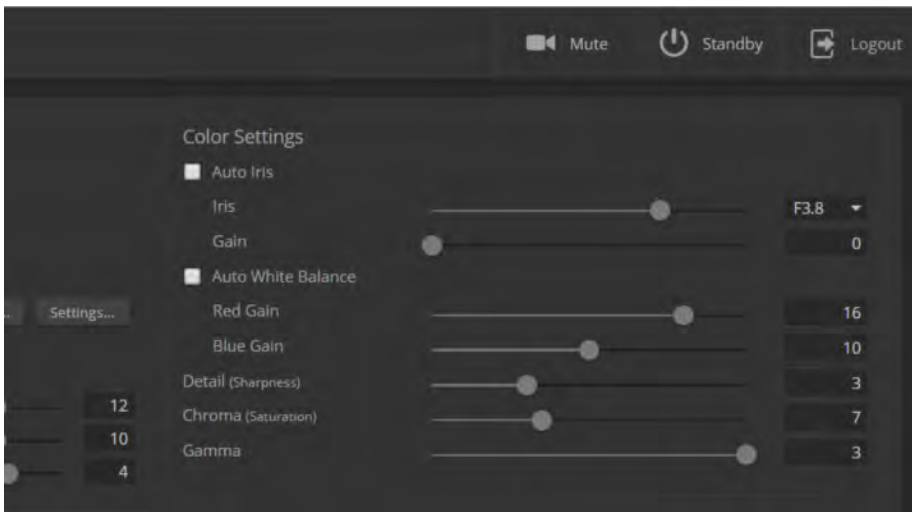

## Adjusting the Focus

Open the Focus control to select Auto-focus, or to set manual focus with the + (near) and – (far) buttons.

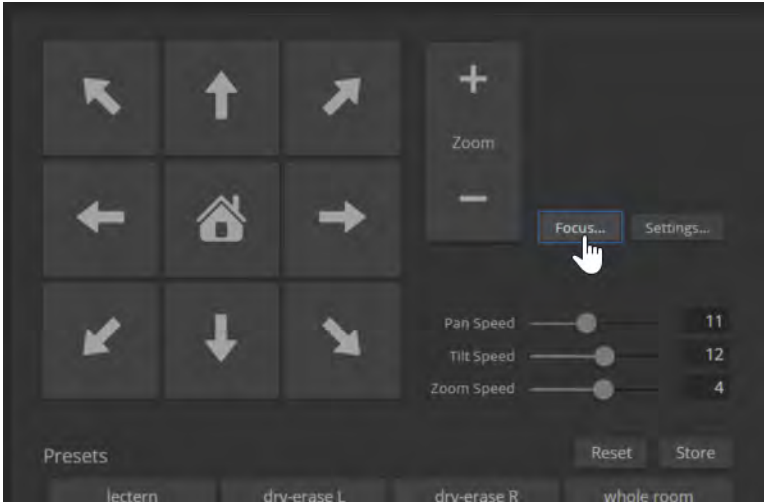

## Setting the Speeds of Camera Movements

### To set speeds for movements to presets:

In the Global Preset Speeds section, set the speeds for movements to presets.

### To set speeds for movements using the arrow buttons:

Use the speed sliders to adjust the speed of movements that you control with the buttons for pan, tilt, and zoom. For tight shots, slower is usually better.

## Setting Pan Direction

By default, the arrow buttons move the camera in the direction that viewers at the far end would see. If you face the camera and use the left arrow button, the camera pans to your right.

To switch the camera pan direction to the near end point of view, use the Settings button to open the pan and tilt direction box. Then set Pan Direction to Inverted.

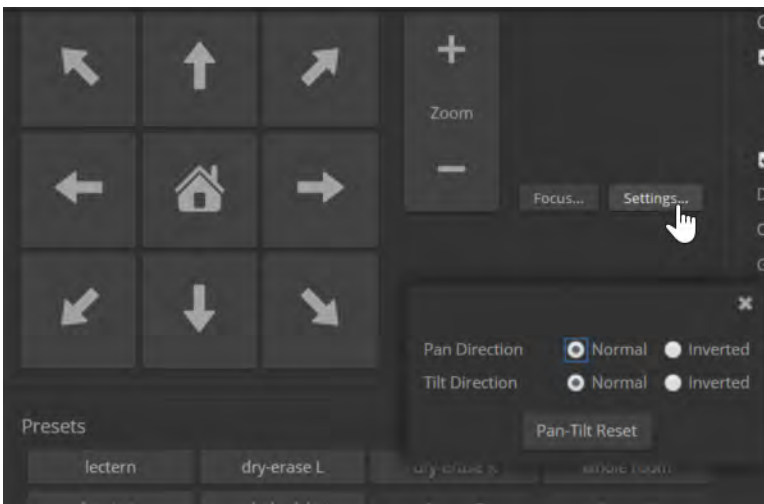

### Note

To change tilt direction, please use the soft DIP switch on the System page.

## Enabling or Disabling Streaming

### STREAMING PAGE

IP streaming is enabled by default. Clear the Enable IP Streaming checkbox to change this.

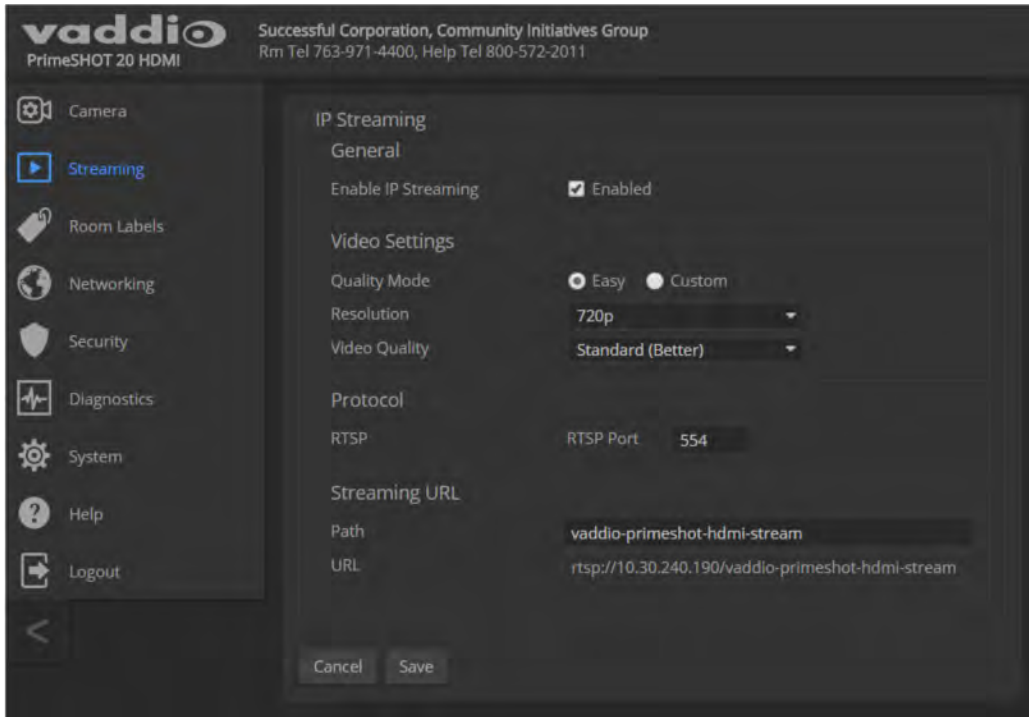

## Configuring IP Streaming

### STREAMING PAGE

**Note**

*The web interface presents all the possible streaming resolutions values, but the IP stream cannot be higher than the value set with the video resolution switch on the back of the camera. (See [Video Resolution](#) for information on setting the switch.) If the selected value is out of range, the camera will automatically adjust the streaming resolution.*

If you are not sure about these settings, start with the defaults.

1. Select the video Quality Mode: Easy or Custom. Easy takes care of most settings automatically; Custom provides additional control.
2. Select the desired IP streaming resolution.

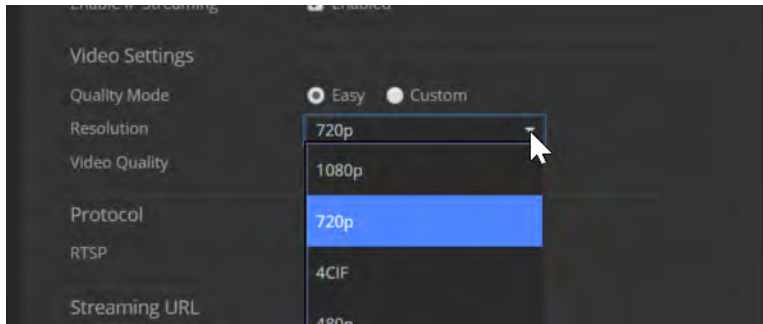

3. Easy quality mode only: Select Video Quality.

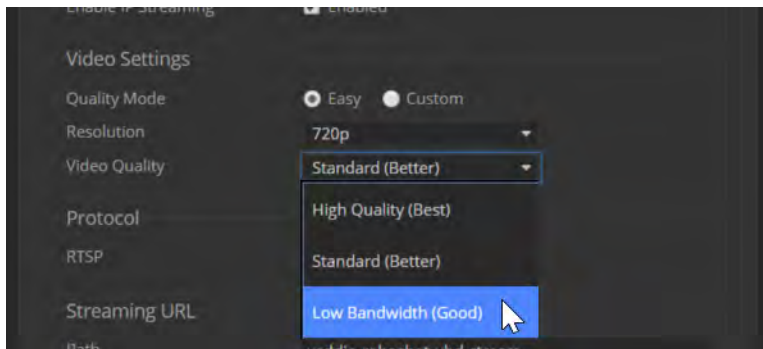

4. Custom quality mode only: Select the desired IP streaming frame rate.

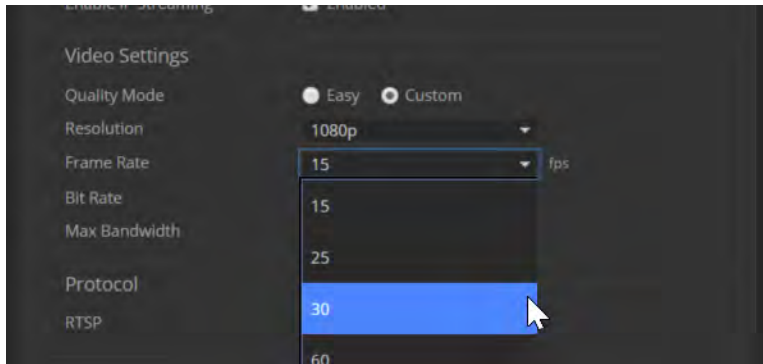

5. Custom quality mode only: Select Constant or Variable Bit Rate.

6. Custom quality mode, Constant Bit Rate only: Set Max Bandwidth.

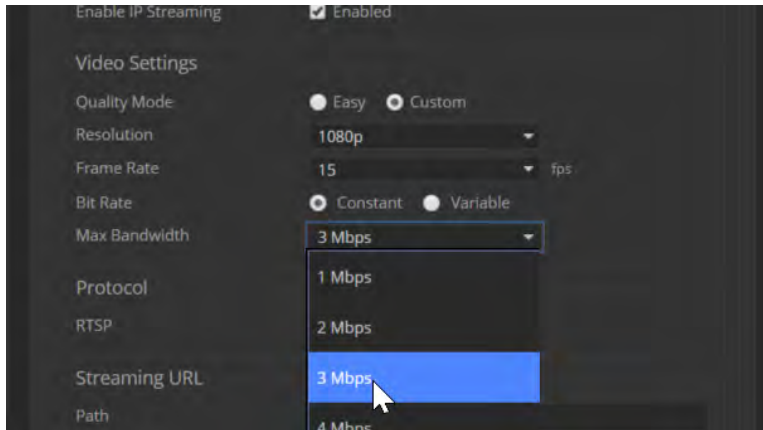

7. Custom quality mode, Variable bit rate only: Set the Quality (Quantization) slider.

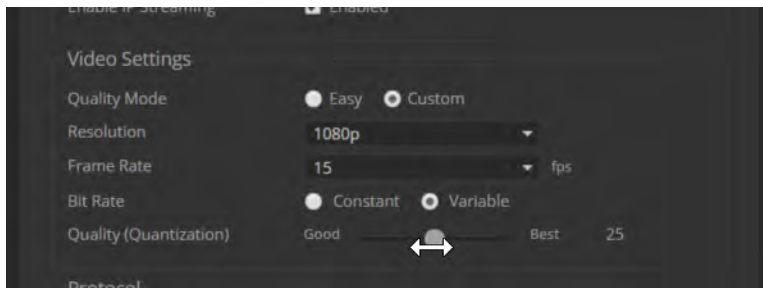

## Advanced IP Streaming Settings

Consult your IT department before changing these.

**RTSP port:** Vaddio strongly recommends using the default RTSP port number unless you need to change it. Consult your IT department.

**Streaming URL:** Edit the path to change the portion of the streaming URL that appears after the IP address, if necessary.



## Setting Other Camera Behaviors

### SYSTEM PAGE, DIP SWITCHES TAB

The DIP Switches tab of the System page provides access to these features via soft switches:

**Camera ID (IR Settings)** – The IR Remote Commander can control up to three cameras in the same room with different IR frequencies. Use **IR Settings** switches 1 and 2 to select the frequency to identify the camera as camera 1, 2, or 3; then use the Camera Select buttons at the top of the remote to select the camera you want to control.

**Image Flip** – If mounting the camera upside-down, set IMAGE FLIP ON.

**Baud Rate (9600 bps or 38400 bps)** – RS-232 serial communication rate.

**HDMI color** – YCbCr (default) or sRGB.

**LED color scheme** – Status light color codes for Pro AV (broadcast) or UC (unified conferencing); set to Pro AV by default, to follow the standard for broadcast cameras. At this time, the two color schemes are functionally identical on this camera.

**LED on/off** – In most cases, Vaddio recommends leaving the status light on, to let people in the room know whether the camera is currently sending video.

**S-Video NTSC/PAL** – US (NTSC) or European (PAL) format.

**Enable/Disable LED in Standby Mode** – If the LED is enabled in standby (low-power) mode, it illuminates purple when the camera is in standby mode. If the LED is disabled, it turns off when the camera is in standby mode.

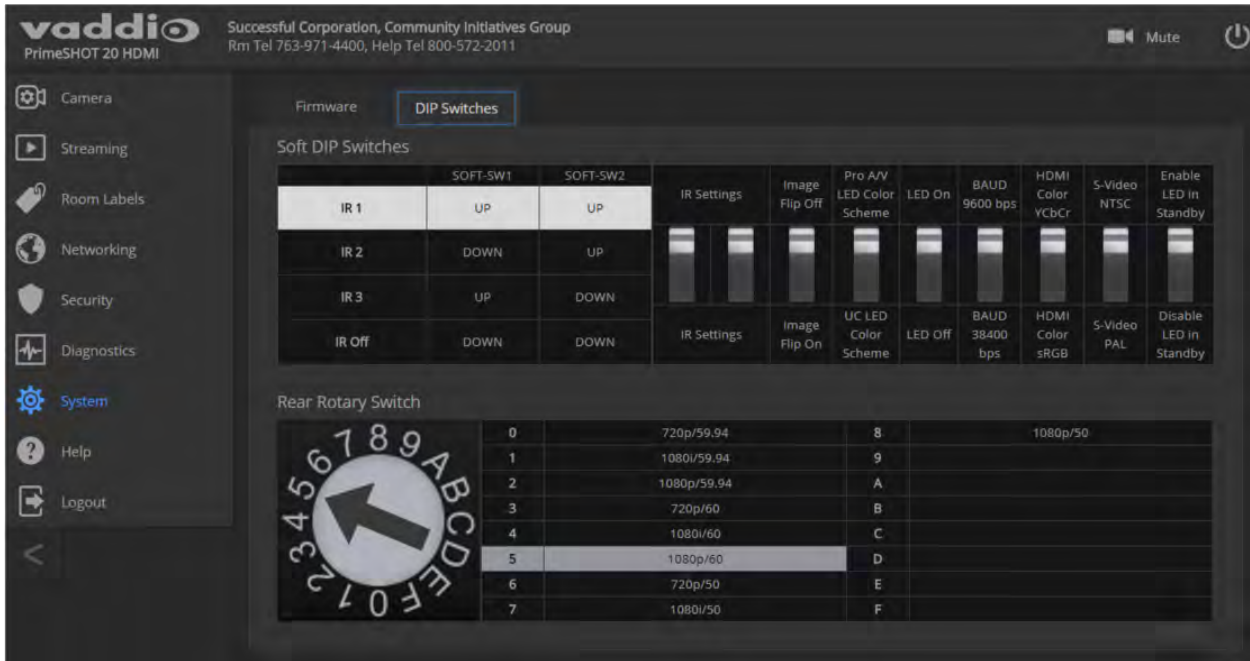

### Note

By default, the camera's status light is active during normal operation; however, it can be configured to remain off when the camera is powered up. The camera may be sending video even if the indicator light is off.

## Operating the Camera

### CONTROLS PAGE (USER OR GUEST ACCESS)

The Controls page provides most of the same controls as the IR Remote Commander:

- [Pan, tilt, zoom, or return to home position](#)
- [Stop or resume transmitting live camera video](#) (video mute)
- [Put the camera in standby](#) or bring it back to the ready state
- [Move to camera presets](#), if any have been stored



### Moving the Camera

Use the arrow buttons for camera pan and tilt. The center button moves the camera to the home position.

### Zooming In or Out

Use the Zoom + button to zoom in and the Zoom – button to zoom out.

### Moving the Camera to a Preset Position

Use the Preset buttons (if available) to move the camera to any of its programmed positions. Presets are only available if they have been set in the administrative interface.

## Stopping or Resuming Video

Use the Mute button to temporarily stop video from the camera without placing it in standby. Remember that the mute button does not mute the room's microphones. In video mute mode, the camera transmits blue or black video, with a message that the video is muted.

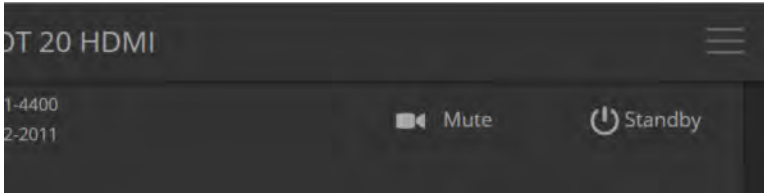

## Managing the Camera Ready State

Use the Standby button to switch between low-power (standby) and ready states.

## Telnet Serial Command API

The Vaddio Telnet command API allows an external device such as an AMX or Crestron presentation system to control the camera.

**Note**

*When you connect via Telnet, you must log in using the admin account.*

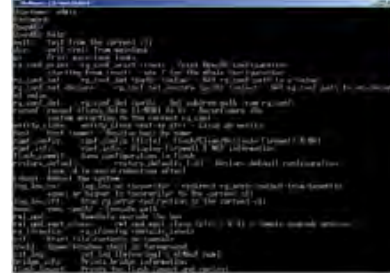

The command format follows a get/set structure. Here are some examples:

Command	<code>camera pan right</code>
Response	OK >
Command	<code>camera focus mode auto</code>
Response	OK >
Command	<code>camera ccu get iris</code>
Response	iris 6 OK >

Use a question mark as a command parameter to bring up a list of commands, subcommands, or command parameters. For example:

**> camera focus ?**

```
near    Focus the camera near
far     Focus the camera far
stop    Stop the camera focus
mode    Camera focus mode
```

Things you might need to know about control via Telnet session:

- Command lines are terminated with a carriage return.
- All ASCII characters (including carriage returns) are echoed to the terminal program and appended with the VT100 string ESC[J (hex 1B 5B 4A), which most terminal programs automatically strip.
- CTRL-5 Clears the current serial buffer on the device.

Typographical conventions:

- n { x | y | z } – Choose x, y, or z.
- n <variable> – Substitute the desired value here.
- n < x - y > – Valid range of values is from x through y.
- n [optional] – Parameter is not required.

## camera home

Synopsis	camera home
Example	>camera home OK >

## camera pan

Moves the camera horizontally

Synopsis	camera pan { left [<speed>]   right [<speed>]   stop   get   set <position> [<speed>] }	
Options	left	Moves the camera left.
	right	Moves the camera right.
	speed <1 - 24>	Optional: Specifies the pan speed as an integer (1 to 24). Default speed is 12.
	stop	Stops the camera's horizontal movement.
	set <position>	Sets the camera's absolute pan position in degrees, as a floating point value between approximately -160.00 and 160.00. This is the minimum range. Individual cameras may have slightly more travel before they reach their physical limits.
	get	Returns the camera's absolute pan position in degrees, as a floating point value between approximately -160.00 (left) and 160.00 (right).
Examples	<pre>&gt;camera pan left OK &gt;</pre> <p>Pans the camera left at the default speed.</p> <pre>&gt;camera pan right 20 OK &gt;</pre> <p>Pans the camera right using a speed of 20.</p> <pre>&gt;camera pan stop OK &gt;</pre> <p>Stops the camera's horizontal motion.</p>	

## camera tilt

Moves the camera vertically.

Synopsis	<code>camera tilt{ up [&lt;speed&gt;]   down [&lt;speed&gt;]   stop   get   set &lt;position&gt; [&lt;speed&gt;] }</code>	
Options	<code>up</code>	Moves the camera up.
	<code>down</code>	Moves the camera down.
	<code>speed &lt;1 - 20&gt;</code>	Optional: Specifies the tilt speed as an integer (1 to 20). Default speed is 10.
	<code>stop</code>	Stops the camera's vertical movement.
	<code>set &lt;position&gt;</code>	Sets the camera's absolute tilt position in degrees, as a floating point value between approximately -30.00 and 90.00. This is the minimum range; individual cameras may have an additional degree or two of travel before they reach their physical limits.
	<code>get</code>	Returns the camera's absolute tilt position in degrees, as a floating point value between approximately -30.00 (down) and 90.00 (up).
Examples	<pre>&gt;camera tilt up OK &gt; Tilts the camera up at the default speed.  &gt;camera tilt down 20 OK &gt; Tilts the camera down at a speed of 20.  &gt;camera tilt 15.25 12 OK &gt; Tilts the camera to position 15.25 at a speed of 12.</pre>	

## camera zoom

Moves the camera in toward the subject or out away from the subject.

Synopsis	camera zoom { in [<speed>]   out [<speed>]   stop   get   set <position> }	
Options	in	Zooms the camera in.
	out	Zooms the camera out.
	stop	Stops the camera's zoom movement.
	set <zoom>	Sets the camera's zoom level as a floating point value between 1 and 20.
	get <zoom>	Returns the camera's zoom setting as a floating point value between 1 and 20.
Examples	<pre>&gt;camera zoom in OK &gt;  &gt;camera zoom stop OK &gt;  Stops the camera's zoom motion.</pre>	

## camera focus

Changes the camera focus.

Synopsis	camera focus { near [<speed>]   far [<speed>]   stop   mode {get   auto   manual} }	
Options	near	Brings the focus nearer to the camera. Can only be used when camera is in manual mode.
	far	Moves the focus farther from the camera. Can only be used when camera is in manual mode.
	speed <1 - 8>	Optional: integer (1 to 8) specifies the focus speed.
	mode [get   auto   manual]	Returns the current focus mode, or specifies automatic or manual focus.
	stop	Stops the camera's focus movement.
Examples	 <pre>camera focus near OK &gt;  Brings the focus near at the default speed.  camera focus far 7 OK &gt;  Moves the focus farther from the camera at a speed of 7.  camera focus mode get auto_focus:  on OK &gt;  Returns the current focus mode.</pre>	

## camera preset

Moves the camera to the specified preset, or stores the current camera position and optionally CCU information.

Synopsis	<code>camera preset { recall   store} [1 - 16] [save-ccu]</code>	
Options	<code>recall [1 - 16]</code>	Moves the camera to the specified preset.
	<code>store [1 - 16]</code>	Stores the current camera position as the specified preset.
	<code>save-ccu</code>	Optional: Saves the current CCU (color and lighting) settings as part of the preset. If not specified, the last color settings are used when recalled.
Examples	<pre>&gt;camera preset recall 3 OK &gt; Moves the camera to preset 3.  &gt;camera preset store 1 OK &gt; Saves the camera's current position as preset 1.</pre>	



## camera ccu get

Returns CCU (lighting and color) information.

Synopsis	<code>camera ccu get &lt;param&gt;</code>	
	<code>auto_white_balance</code>	Returns the current state of the auto white balance setting (on or off).
	<code>red_gain</code>	Returns the red gain value as an integer (0 to 20).
	<code>blue_gain</code>	Returns the blue gain value as an integer (0 to 20).
	<code>backlight_compensation</code>	Returns the current state of the backlight compensation setting (on or off).
	<code>iris</code>	Returns the iris value as an integer (0 to 11).
	<code>auto_iris</code>	Returns the current auto-iris state (on or off).
	<code>gain</code>	Returns the gain value as an integer (1 to 10).
	<code>detail</code>	Returns the detail value as an integer (0 to 10).
	<code>chroma</code>	Returns the chroma value as an integer (0 to 20).
	<code>wide_dynamic_range</code>	Returns the current setting for Wide Dynamic Range (on or off).
	<code>all</code>	Returns all current CCU settings.
Examples	<pre>&gt;camera ccu get iris iris 6 OK &gt;</pre> <p>Returns the current iris value.</p> <pre>&gt;camera ccu get red_gain red_gain 201 OK &gt;</pre> <p>Returns the current red gain value.</p> <pre>&gt;camera ccu get all auto_iris on auto_white_balance on backlight_compensation off blue_gain 10 chroma 7 detail 3 gain 2 iris 9 red_gain 10 wide_dynamic_range on OK &gt;</pre> <p>Returns all current CCU settings.</p>	

## camera ccu set

Sets the specified CCU (lighting) information.

Synopsis	camera ccu set <param> <value>	
<p>Options</p> 	auto_white_balance {on   off}	Sets the current state of the auto white balance setting (on or off). Auto white balance overrides red gain and blue gain manual settings.
	red_gain <0 - 20>	Sets the red gain value as an integer (0 to 20). Can only be used when auto white balance is off.
	blue_gain <0 - 20>	Sets the blue gain value as an integer (0 to 20). Can only be used when auto white balance is off.
	backlight_compensation {on   off}	Sets the current state of the backlight compensation setting (on or off). Can only be used when wide dynamic range mode is off.
	iris <0 - 11>	Sets the iris value as an integer (0 to 11). Can only be used when auto-iris is off.
	auto_iris {on   off}	Sets the auto-iris state (on or off). Auto-iris disables manual iris and gain when it is on.
	gain <1 - 10>	Sets gain value as an integer (1 to 10). Can only be used when auto-iris is off.
	detail <0 - 10>	Sets the detail value as an integer (0 to 10).
	chroma <0 - 20>	Sets the chroma value as an integer (0 to 20).
	wide_dynamic_range {on   off}	Sets Wide Dynamic Range mode on or off. Can only be used when backlight compensation is off.
Examples	<pre>&gt;camera ccu set auto_iris off OK &gt; Turns off auto-iris mode, returning the camera to manual iris control.  &gt;camera ccu set red_gain 10 OK &gt; Sets the red gain value to 10.</pre>	

### camera ccu scene

Stores the current CCU scene or recalls the specified ccu scene.

Synopsis	camera ccu scene {recall {factory <1 - 6>   custom <1 - 3>}   store custom <1 - 3>}	
Options	recall factory <1 - 6> recall custom <1 - 3>	Recalls the camera to the specified scene (factory 1 - 6 or custom 1 - 3).
	store custom <1 - 3>	Saves the current scene as the specified custom scene.
Examples	<pre>&gt;camera ccu scene recall factory 2 OK &gt;  Sets the camera to use factory CCU scene 2.  &gt;camera ccu scene store custom 1 OK &gt;  Saves the current CCU scene as custom CCU scene 1.</pre>	

### camera led

Set or change the behavior of the indicator light.

Synopsis	camera led { get   off   on }	
Options	get	Returns the indicator light's current state (on or off).
	off	Disables the indicator light.
	on	Enables the indicator light.
Examples	<pre>&gt;camera led off OK &gt;  Disables the indicator light. You cannot tell by looking at the camera whether it is sending video.  &gt;camera led get led:  on OK &gt;  Returns the current state of the indicator light.</pre>	

### camera recalibrate

Recalibrates the pan and tilt motors. This is typically done in response to a motor fault indication or error message.

Synopsis	camera recalibrate
Example	<pre>&gt;camera recalibrate OK &gt;</pre>

## camera standby

Set or change camera standby status.

Synopsis	camera standby { get   off   on   toggle }	
Options	get	Returns the camera's current standby state.
	off	Brings the camera out of standby (sleep) mode.
	on	Stops video and puts the camera in standby mode.
	toggle	Changes the camera's standby state - if it was not in standby mode, it enters standby; if it was in standby mode, it "wakes up."
Examples	<pre>&gt;camera standby off OK &gt; Brings the camera out of standby mode.  &gt;camera standby get standby:      on OK &gt; Returns the current standby state.</pre>	

## video mute

Gets or sets the camera's video mute status. When video is muted, the camera sends blue or black video with an on-screen message stating that video mute is on. This can be desirable when preparing the room, or when privacy is needed.

**Note**

*In systems with audio, this command does not affect the audio.*

Synopsis	video mute { get   off   on   toggle }	
Options	get	Returns the current video mute status.
	off	Unmutes the video. (Normal video resumes.)
	on	Mutes the video. (Blue or black screen with message)
	toggle	Changes the camera's video mute status.
Examples	<pre>&gt;video mute get mute: off OK &gt; Returns video mute status.  &gt;video mute on OK &gt; Transmits blue or black video.</pre>	

## streaming settings get

Retrieves IP streaming settings. These are configured in the web interface.

Synopsis	<code>streaming settings get</code>	
Parameters	IP Custom_Frame_Rate	Frame rate selected in Custom quality mode.
	IP Custom_Resolution	Resolution selected in Custom quality mode.
	IP Enabled	True if IP streaming is enabled, False if it is not.
	IP Port	The RTSP port number used for IP streaming. Default is 554.
	IP Preset_Quality	Video quality selected in Easy video quality mode.
	IP Preset_Resolution	Resolution selected in Easy video quality mode.
	IP Protocol	The IP streaming protocol in use.
	IP URL	The URL where the stream is available.
	IP Video_Mode	Video quality mode selected (preset or custom)
Example	<pre>&gt;streaming settings get IP Custom_Frame_Rate  15 IP Custom_Resolution  1080p IP Enabled             true IP Port                554 IP Preset_Quality     Standard (Better) IP Preset_Resolution  720p IP Protocol            RTSP IP URL                 vaddio-primeshot-hdmi-stream IP Video_Mode         preset OK &gt;</pre> <p>Returns the current streaming settings.</p>	

## network settings get

Returns the camera's current network settings and MAC address.

Synopsis	<code>network settings get</code>	
Example	<pre>network settings get Name          eth0:WAN MAC Address   00:1E:C0:F6:CA:7B IP Address    192.168.1.67 Netmask       255.255.255.0 VLAN          Disabled Gateway       192.168.1.254 OK &gt;</pre>	

## network ping

Sends an ICMP ECHO\_REQUEST to the specified IP address.

Synopsis	network ping [count <count>] [size <size>] <destination-ip>	
Options	<count>	The number of ECHO_REQUEST packets to send. Default is five packets.
	<size>	The size of each ECHO_REQUEST packet. Default is 56 bytes.
	<destination-ip>	The IP address where the ECHO_REQUEST packets will be sent.
Examples	<pre>&gt;network ping 192.168.1.66 PING 192.168.1.66 (192.168.1.66): 56 data bytes 64 bytes from 192.168.1.66: seq=0 ttl=64 time=0.476 ms 64 bytes from 192.168.1.66: seq=1 ttl=64 time=0.416 ms 64 bytes from 192.168.1.66: seq=2 ttl=64 time=0.410 ms 64 bytes from 192.168.1.66: seq=3 ttl=64 time=0.410 ms 64 bytes from 192.168.1.66: seq=4 ttl=64 time=3.112 ms --- 192.168.1.66 ping statistics --- 5 packets transmitted, 5 packets received, 0% packet loss round-trip min/avg/max = 0.410/0.964/3.112 ms &gt;</pre> <p>Sends five ECHO_REQUEST packets of 56 bytes each to the host at 192.168.1.66.</p>	
	<pre>&gt;network ping count 10 size 100 192.168.1.1</pre> <p>Sends 10 ECHO_REQUEST packets of 100 bytes each to the host at 192.168.1.1. The command returns data in the same form as above.</p>	

## system reboot

Reboots the system either immediately or after the specified delay. Note that a reboot is required when resetting the system to factory defaults (system factory-reset).

Synopsis	system reboot [<seconds>]	
Options	<seconds>	The number of seconds to delay the reboot.

## system factory-reset

Gets or sets the factory reset status. When the factory reset status is on, the system resets to factory defaults on reboot.

Synopsis	system factory-reset { get   on   off }	
Options	get	Returns the camera's current factory reset status.
	on	Enables factory reset on reboot and returns the camera's current factory reset status.
	off	Disables factory reset on reboot and returns the camera's current factory reset status.
Examples 	<pre>&gt;system factory-reset get factory-reset (software):    off factory-reset (hardware):   off OK &gt;</pre> <p>Returns the factory reset status.</p> <p>This evaluates the most recent <code>system factory-reset on</code> or <code>off</code> command, if one has been received, then reads the rear panel rotary switch and returns the status <code>on</code> if it is in the D position.</p> <pre>&gt;system factory-reset on factory-reset (software):    on factory-reset (hardware):   off OK &gt;</pre> <p>Enables factory reset upon reboot.</p> <p><b>Note</b> <i>This command does not initiate a factory reset. The factory reset takes place on the next reboot.</i></p>	

## version

Returns the current firmware version.

Synopsis	version	
Example	<pre>&gt;version Commit          b0c31c48ff4f1d128ceb6cf7ebd0c2861cf440ed Sensor Version  1.1 System Version  PrimeSHOT HDMI 1.0.0 OK &gt;</pre>	

## help

Displays an overview of the CLI syntax.

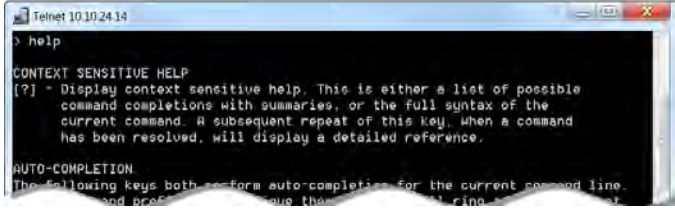
Synopsis	help
Example	<p><b>help</b></p> 

## history

Returns the most recently issued commands from the current Telnet session. Since many of the programs read user input a line at a time, the command history is used to keep track of these lines and recall historic information.

Synopsis	history <limit>	
Options	<limit>	Integer value specifying the maximum number of commands to return.
Examples	<p><b>history</b> Displays the current command buffer.</p> <p><b>history 5</b> Sets the history command buffer to remember the last 5 unique entries.</p>	
Additional information	<p>You can navigate the command history using the up and down arrow keys. This command supports the expansion functionality from which previous commands can be recalled from within a single session. History expansion is performed immediately after a complete line is read.</p> <p>Examples of history expansion:</p> <ul style="list-style-type: none"> <li>* !! Substitute the last command line.</li> <li>* !4 Substitute the 4th command line (absolute as per 'history' command)</li> <li>* !-3 Substitute the command line entered 3 lines before (relative)</li> </ul>	

## exit

Ends the command session and closes the socket.

Synopsis	exit
Example	<b>exit</b>



## RS-232 Control

The Vaddio Control Protocol is similar to the Sony® VISCA command set in order to be compatible with several popular control devices. Not all VISCA commands are supported and there are Vaddio-specific commands in the following command and inquiry lists.

For RS-232 communication settings and connector pin-out, see [RS-232 Serial Communication](#).

### Camera Movement, Zoom, and Focus Commands

Command Set	Command	Command Packet	Comments
CAM_Zoom	Stop	8x 01 04 07 00 FF	Variable speed: p = 0 (low) to 7 (high) Direct: pqrs = zoom position (0h-7AC0h)
	Tele (std)	8x 01 04 07 02 FF	
	Wide (std)	8x 01 04 07 03 FF	
	Tele (variable)	8x 01 04 07 2p FF	
	Wide (variable)	8x 01 04 07 3p FF	
	Direct	8x 01 04 47 0p 0q 0r 0s FF	
	Corresponds to <code>camera zoom</code> in Telnet API		
CAM_Focus	Stop	8x 01 04 08 00 FF	Variable speed: p = 0 (low) to 7 (high) Direct and Near Limit: pqrs = focus position (1000h – F000h)
	Far (std)	8x 01 04 08 02 FF	
	Near (std)	8x 01 04 08 03 FF	
	Far (variable)	8x 01 04 08 2p FF	
	Near (variable)	8x 01 04 08 3p FF	
	Direct	8x 01 04 48 0p 0q 0r 0s FF	
	Auto Focus	8x 01 04 38 02 FF	
	Manual Focus	8x 01 04 38 03 FF	
	Auto/Manual	8x 01 04 08 10 FF	
	One Push Trigger	8x 01 04 18 01 FF	
	Near Limit	8x 01 04 28 0p 0q 0r 0s FF	
	Corresponds to <code>camera focus</code> in Telnet API		

Command Set	Command	Command Packet	Comments
Pan-TiltDrive	Up	8x 01 06 01 vv ww 03 01 FF	vv= Pan speed (01h-18h) ww=Tilt speed (01h-14h)
	Down	8x 01 06 01 vv ww 03 02 FF	
	Left	8x 01 06 01 vv ww 01 03 FF	
	Right	8x 01 06 01 vv ww 02 03 FF	
	UpLeft	8x 01 06 01 vv ww 01 01 FF	
	UpRight	8x 01 06 01 vv ww 02 01 FF	
	DownLeft	8x 01 06 01 vv ww 01 02 FF	
	DownRight	8x 01 06 01 vv ww 02 02 FF	
	Stop	8x 01 06 01 vv ww 03 03 FF	
	Absolute Position	8x 01 06 02 vv ww 0Y 0Y 0Y 0Y 0Z 0Z 0Z 0Z FF	0Y0Y0Y0Y = Pan position (90E2h-6BD8h) 0Z0Z0Z0Z = Tilt position (EB99h-3D59h)
Home	8x 01 06 04 FF	Returns the camera to its default position	
Pan-TiltDrive	Reset	81 01 06 05 FF	Resets/recalibrates the pan and tilt motors
	Corresponds to <code>camera recalibrate</code> in Telnet API		
Pan-Tilt-ZoomDrive	Up	8x 01 06 0A vv ww rr 03 01 03 FF	vv= Pan speed (01h-18h) ww=Tilt speed (01h-14h) rr=Zoom speed (00h - 07h)
	Down	8x 01 06 0A vv ww rr 03 02 03 FF	
	Left	8x 01 06 0A vv ww rr 01 03 03 FF	
	Right	8x 01 06 0A vv ww rr 02 03 03 FF	
	In	8x 01 06 0A vv ww rr 03 03 01 FF	
	Out	8x 01 06 0A vv ww rr 03 03 02 FF	
	Stop	8x 01 06 0A vv ww rr 03 03 03 FF	
	Home	8x 01 06 0C FF	Returns the camera to the default position and zoom
Pan-Tilt-ZoomDrive	Absolute Position	8x 01 06 0B vv ww 0Y 0Y 0Y 0Y 0Z 0Z 0Z 0Z 0R 0R 0R 0R FF	0Y0Y0Y0Y = Pan position (90E2h-6BD8h) 0Z0Z0Z0Z = Tilt position (EB99h-3D59h) 0R0R0R0R = Zoom position (0h-4000h)

Command Set	Command	Command Packet	Comments
CAM_Memory	Reset	8x 01 04 3F 00 0p FF	p= preset number(0h-0Fh)
	Set	8x 01 04 3F 01 0p FF	
	Set with 'scene'	8x 01 04 3F 21 0p FF	
	Recall	8x 01 04 3F 02 0p FF	
	Corresponds to <code>camera preset</code> in Telnet API.		

## Movement, Zoom, and Focus Inquiry Commands

Inquiry Command	Command	Response Packet	Comments
CAM_ZoomPosInq	8x 09 04 47 FF	y0 50 0p 0q 0r 0s FF	pqrs: Zoom position
CAM_FocusPosInq	8x 09 04 48 FF	y0 50 0p 0q 0r 0s FF	pqrs: Focus position
CAM_FocusModeInq	8x 09 04 38 FF	y0 50 02 FF	Auto focus
		y0 50 03 FF	Manual focus
	Corresponds to <code>camera focus mode get</code> in Telnet API.		
Pan-TiltPosInq	8x 09 06 12 FF	y0 50 0w 0w 0w 0z 0z 0z 0z FF	www= Pan position zzzz=Tilt Position
CAM_MemoryInq	8x 09 04 3F FF	y0 50 pp FF	pp: Preset number recalled last (00h - 0Fh)
CAM_MemoryStatusInq	8x 09 04 3F 0p FF	y0 50 0p 0q 0r 0s FF	p: Preset number (00h - 0Fh) q: mode (00-std, 10-std /w ccu) rs: speed (0x1-0x18) 1 - 24
CAM_MemSaveInq	8x 09 04 23 0X FF	y0 50 0p 0q 0r 0s FF	X: 00h to 0Fh (preset number) pqrs: 0000h to FFFFh (Data)
CAM_PTZ_PresetSpeedInq	8x 09 7E 01 0B FF	y0 50 p q r FF	p:pan speed (01h-18h) q:tilt speed (01h-14h) r:zoom speed (0h-07h)

## Color and Light Management Commands

Command Set	Command	Command Packet	Comments
CAM_WB	Auto	8x 01 04 35 00 FF	Normal auto
	Manual	8x 01 04 35 05 FF	Manual control mode
	Corresponds to <code>camera ccu set auto_white_balance</code> in Telnet API.		
CAM_RGain	Reset	8x 01 04 03 00 FF	Manual control of red gain pq = red gain (00h – 14h)
	Up	8x 01 04 03 02 FF	
	Down	8x 01 04 03 03 FF	
	Direct	8x 01 04 43 00 00 0p 0q FF	
	Corresponds to <code>camera ccu set red_gain</code> in Telnet API.		
CAM_BGain	Reset	8x 01 04 04 00 FF	Manual control of blue gain pq = blue gain (00h – 14h)
	Up	8x 01 04 04 02 FF	
	Down	8x 01 04 04 03 FF	
	Direct	8x 01 04 44 00 00 0p 0q FF	
	Corresponds to <code>camera ccu set blue_gain</code> in Telnet API.		
CAM_AE	Auto	8x 01 04 39 00 FF	Auto exposure mode
	Manual	8x 01 04 39 03 FF	Manual control mode
	Corresponds to <code>camera ccu set auto_iris</code> in Telnet API.		
CAM_Shutter	Reset	8x 01 04 0A 00 FF	Shutter setting
	Up	8x 01 04 0A 02 FF	pq = shutter position (00h – 15h)
	Down	8x 01 04 0A 03 FF	See <a href="#">Shutter Speed Values – CAM_Shutter Command</a>
	Direct	8x 01 04 4A 00 00 0p 0q FF	
CAM_Iris	Reset	8x 01 04 0B 00 FF	Iris setting
	Up	8x 01 04 0B 02 FF	pq = iris position (0h, 05h-11h)
	Down	8x 01 04 0B 03 FF	See <a href="#">Iris Values – CAM_Iris Command</a>
	Direct	8x 01 04 4B 00 00 0p 0q FF	
	Corresponds to <code>camera ccu set iris</code> in Telnet API.		
CAM_Gain	Reset	8x 01 04 0C 00 FF	Iris gain setting
	Up	8x 01 04 0C 02 FF	pq = gain position (01h – 0Fh)
	Down	8x 01 04 0C 03 FF	p = gain limit (04h-0Fh)
	Direct	8x 01 04 4C 00 00 0p 0q FF	See <a href="#">Iris Gain and Gain Limit Values – CAM_Gain Command</a>
	+Gain Limit	8x 01 04 2C 0p FF	
	Corresponds to <code>camera ccu set gain</code> in Telnet API.		
CAM_BackLight	On	8x 01 04 33 02 FF	Backlight compensation On/Off
	Off	8x 01 04 33 03 FF	
	Corresponds to <code>camera ccu set backlight_compensation</code> in Telnet API.		

Command Set	Command	Command Packet	Comments
CAM_WD	On	8x 01 04 3D 02 FF	Wide Dynamic Range On
	Off	8x 01 04 3D 03 FF	Wide Dynamic Range Off
	Corresponds to <code>camera ccu set wide_dynamic_range</code> in Telnet API.		
CAM_Aperture	Reset	8x 01 04 02 00 FF	Aperture setting pq = aperture position (0h-0fh)
	Up	8x 01 04 02 01 FF	
	Down	8x 01 04 02 02 FF	
	Direct	8x 01 04 42 00 00 0p 0q FF	
	Corresponds to <code>camera ccu set detail</code> in Telnet API.		
CAM_Chroma	Direct	8x 01 7E 55 00 00 0p 0q FF	pq: 00h – 14h
	Corresponds to <code>camera ccu set chroma</code> in Telnet API.		
CAM_Gamma	--	8x 01 04 5B 0p FF	p = gamma setting (0: std, 1: straight)
	Corresponds to <code>camera ccu set gamma</code> in Telnet API.		

## Shutter Speed Values (CAM\_Shutter)

Value	60/59.94/30/29.97 fps	50/25 fps
0x15	1/10000	1/10000
0x14	1/6000	1/6000
0x13	1/4000	1/3500
0x12	1/3000	1/2500
0x11	1/2000	1/1750
0x10	1/1500	1/1250
0x0F	1/1000	1/1000
0x0E	1/725	1/600
0x0D	1/500	1/425
0x0C	1/350	1/300
0x0B	1/250	1/215
0x0A	1/180	1/150
0x09	1/125	1/120
0x08	1/100	1/100
0x07	1/90	1/75
0x06	1/60	1/50
0x05	1/30	1/25
0x04	1/15	1/12
0x03	1/8	1/6
0x02	1/4	1/3
0x01	1/2	1/2
0x00	1/1	1/1

## Iris Values (CAM\_Iris)

Value	Iris
0x11	F1.6
0x10	F2
0x0F	F2.4
0x0E	F2.8
0x0D	F3.4
0x0C	F4
0x0B	F4.8
0x0A	F5.6
0x09	F6.8
0x08	F8
0x07	F9.6
0x06	F11
0x05	F14
0x00	CLOSED

## Iris Gain and Gain Limit Values (CAM\_Gain)

Iris Gain			Iris Gain Limit		
Value	Steps	Gain in dB	Value	Steps	Gain in dB
0x0F	28	77.8	0x0F	28	77.8
0x0E	26	44.4	0x0E	26	44.4
0x0D	24	41.0	0x0D	24	41.0
0x0C	22	37.5	0x0C	22	37.5
0x0B	20	34.1	0x0B	20	34.1
0x0A	18	30.7	0x0A	18	30.7
0x09	16	27.3	0x09	16	27.3
0x08	14	23.9	0x08	14	23.9
0x07	12	20.5	0x07	12	20.5
0x06	10	17.1	0x06	10	17.1
0x05	8	13.7	0x05	8	13.7
0x04	6	10.2	0x04	6	10.2
0x03	4	6.8			
0x02	2	3.4			
0x01	0	0			

## Color and Light Management Inquiry Commands

Inquiry Command	Command	Response Packet	Comments
CAM_WBModelInq	8x 09 04 35 FF	y0 50 00 FF	Auto
		y0 50 05 FF	Manual
CAM_RGainInq	8x 09 04 43 FF	y0 50 00 00 0p 0q FF	pq: Red gain
CAM_BGainInq	8x 09 04 44 FF	y0 50 00 00 0p 0q FF	pq: Blue gain
CAM_AEModelInq	8x 09 04 39 FF	y0 50 00 FF	Auto
		y0 50 03 FF	Manual
CAM_ShutterPosInq	8x 09 04 4A FF	y0 50 00 00 0p 0q FF	pq: Shutter position
CAM_IrisPosInq	8x 09 04 4B FF	y0 50 00 00 0p 0q FF	pq: Iris position
CAM_GainPosInq	8x 09 04 4C FF	y0 50 00 00 0p 0q FF	pq: Gain position
CAM_WDModelInq	8x 09 04 3D FF	y0 50 02 FF	On
		y0 50 03 FF	Off
CAM_BackLightModelInq	8x 09 04 33 FF	y0 50 02 FF	On
		y0 50 03 FF	Off
CAM_ApertureInq	8x 09 04 42 FF	y0 50 00 00 0p 0q FF	pq: Aperture gain
CAM_ChromaInq	8x 09 7E 55 FF	y0 50 05 00 00 00 0p FF	p: 0 – Eh
CAM_GammaInq	8x 09 04 5B FF	y0 50 0p FF	Gamma p: 00h , 01h

## Other Commands

Command Set	Command	Command Packet	Comments
CommandCancel		8x 2p FF	p= socket (1 or 2)
CAM_Power	On	8x 01 04 00 02 FF	Power on
	Off	8x 01 04 00 03 FF	Power off
	Corresponds to <code>camera standby</code> in Telnet API.		
CAM_Tally	On	8x 01 7E 01 0A 00 02 FF	
	Off	8x 01 7E 01 0A 00 03 FF	
CAM_NR	--	8x 01 04 53 0p FF	p = noise reduction level (0: off, 1 – 5)
CAM_Mute	On	8x 01 04 75 02 FF	Video mute on/off
	Off	8x 01 04 75 03 FF	
	Toggle	8x 01 04 75 10 FF	
	Corresponds to <code>video mute</code> in Telnet API.		



## Other Inquiry Commands

Inquiry Command	Command	Response Packet	Comments
CAM_PowerInq	8x 09 04 00 FF	y0 50 02 FF	On
		y0 50 03 FF	Off (standby)
	Corresponds to <code>camera standby get</code> in Telnet API		
CAM_TallyInq	8x 09 7E 01 0A FF	y0 50 02 FF	On
		y0 50 03 FF	Off
CAM_NRInq	8x 09 04 53 FF	y0 50 0p FF	Noise reduction p: 00h to 05h
CAM_MuteModelInq	8x 09 04 75 FF	y0 50 02 FF	On
		y0 50 03 FF	Off
	Corresponds to <code>video mute get</code> in Telnet API		
IPAddressInq	8x 09 08 4E 00 00 FF	90 50 49 50 00 00 00 0p 0p 0p 0q 0q 0q 0r 0r 0r 0s 0s 0s FF	pppqqrrrsss = IP address Example: 90 50 49 50 00 00 00 00 01 00 00 03 00 02 04 00 01 09 00 FF = 10.30.240.190
Vaddio_ModelInq	8x 09 08 0e FF	90 50 04 68 00 00 00 FF	PrimeSHOT 20 HDMI

## Specifications

### Camera and Image

<b>Image device</b>	1/3-type CMOS sensor	<b>Pixels</b>	2.12 million (effective)
<b>Video Resolutions</b>	<b>HDMI 1.3:</b> 1080p/60/59.94/50 1080i/60/59.94/50 720p/60/59.94/50	<b>S-Video:</b> 480i (NTSC) 576i (PAL)	<b>H.264 IP Streaming:</b> 1080p/30/25/15 720p/60/30/25/15 4CIF/60/30/25/15 640x480/60/30/25/15 360p/60/30/25/15 CIF/60/30/25/15
<b>Pan angle and speed</b>	± 160°, up to 90°/sec	<b>Tilt angle and speed</b>	+90° -30°, up to 90°/sec
<b>Horizontal FOV</b>	20x optical zoom, 55° horizontal field of view (wide end) to 2.9° at 20x zoom (tele end)		
<b>Lens characteristics</b>	f=4.7mm to 94mm, F1.6 to F3.5		
<b>Min. working distance</b>	50 cm (wide), 1.5 m (tele)	<b>Min. illumination</b>	100+ lux recommended
<b>Aperture/detail</b>	10 steps	<b>Gain</b>	Auto or manual
<b>Backlight compensation</b>	On or off	<b>White balance</b>	Auto or manual
<b>Focusing system</b>	Auto or manual	<b>Noise reduction</b>	Auto
<b>Sync system</b>	Internal	<b>S/N ratio</b>	Over 50 dB (AGC off)
<b>Remote management</b>	Web interface, Telnet	<b>Power</b>	12 VDC, 3 A

### Physical and Environmental

<b>Height</b>	6.3 in. (163 mm)	<b>Operating temperature</b>	0°C to +40°C (32°F to 104°F)
<b>Width</b>	7.0 in. (178* mm)	<b>Operating humidity (relative)</b>	20% to 80% non-condensing
<b>Depth</b>	5.5 in. (145 mm)	<b>Storage temperature</b>	-5°C to +60°C (-23°F to 140°F)
<b>Weight</b>	3.0 lbs.(1.36 kg)	<b>Storage humidity (relative)</b>	20% to 80% non-condensing

Specifications are subject to change without notice.

## Troubleshooting and Care

When the camera doesn't behave as you expect, check the indicator light on the front before you do anything else.

Use this table to determine whether it's time to call Vaddio Technical Support.

What is it doing?	Possible causes	Check and correct
Nothing. The light on the front is off and no video is available.	At least one of the cables is bad.	Check using known good cables.
	The wall outlet is not active. (Check by finding out if it powers something else, such as a laptop or phone charger.)	Use a different outlet.
	The camera or its power supply is bad.	Contact your reseller or Vaddio Technical Support.
The light on the front of the camera is off but the web interface and video are available.	The status light is turned off.	You can turn it on again using the LED soft DIP switch on the System page, or using the Telnet command <b>camera led on</b> .
The camera is not responding to the remote and the light is yellow.	A firmware update is in progress.	Wait a few minutes, and try again when the light turns blue.
The camera does not respond to the remote, but the web interface is available.	The remote is not using the same IR channel as the camera.	Push the Camera Select 1 button on the remote.
	The batteries in the remote are dead.	Put new batteries in the remote.
The camera responds to the remote but the web interface is not available.	The camera is not using the IP address you browsed to.	Press the Data Screen button on the remote to see camera information.
The camera's web UI is available but the camera does not respond to commands via RS-232 connection.	The RS-232 cable is not connected, or is bad.	Connect a known good cable.
	The camera's RS-232 settings don't match the settings on the controlling device.	Check the settings at both ends to be sure they match. The camera's baud rate can be viewed but not changed on the System page in the web UI.
The camera loses all its settings when power is cycled.	The rotary switch is in the D position. (Verify on the DIP Switches tab of the System page.)	Set the rotary switch to a valid video resolution. See <a href="#">Video Resolution Settings</a> for more information.
No H.264 video stream.	IP streaming is not enabled.	Enable IP streaming: Streaming page in the web interface.
Status light blinks yellow	Pan or tilt motor is out of calibration	Reset the pan and tilt motors. See <a href="#">Correct a Motor Calibration Error</a> .

## Correct a Motor Calibration Error

If the web interface presents an error message about the motors, or if the camera's status light is blinking yellow, you will need to reset the pan and tilt motors.

1. On the Camera Controls page, select Settings to open the pan and tilt settings box;  
OR  
On the System page, go to the Firmware tab if you are on a different tab.
2. Select Pan-Tilt Reset. The motors recalibrate. This takes a few seconds.

## Status Light

The light in the camera's base indicates its current state.

- Blue – Camera is active
- Purple – Standby mode or booting
- Yellow – Firmware update is in progress
- Blinking red – Video mute is on (UC color scheme only)
- Blinking yellow – Motor out of calibration
- Blinking purple – Error

### **Caution**

*Do not remove power or reset the camera while the indicator is yellow, showing a firmware update in progress. Interrupting a firmware update can make the camera unusable.*

### **Note**

*By default, the camera's status light is active during normal operation; however, it can be configured to remain off when the camera is powered up. The camera may be sending video even if the indicator light is off.*

## Restoring Default Camera Settings

Factory reset clears most settings and returns soft DIP switches (on the DIP Switches tab of the System page) to their default positions.

**Using the rotary switch on the back of the camera:** Disconnect power, set the switch to the D position, and reconnect power. Wait for the camera to finish booting. Then disconnect power again, return the switch to the desired resolution setting, and reconnect power.

**From the web interface:** Log on using the admin account, go to the System page's Firmware tab, and select Restore Factory Settings.

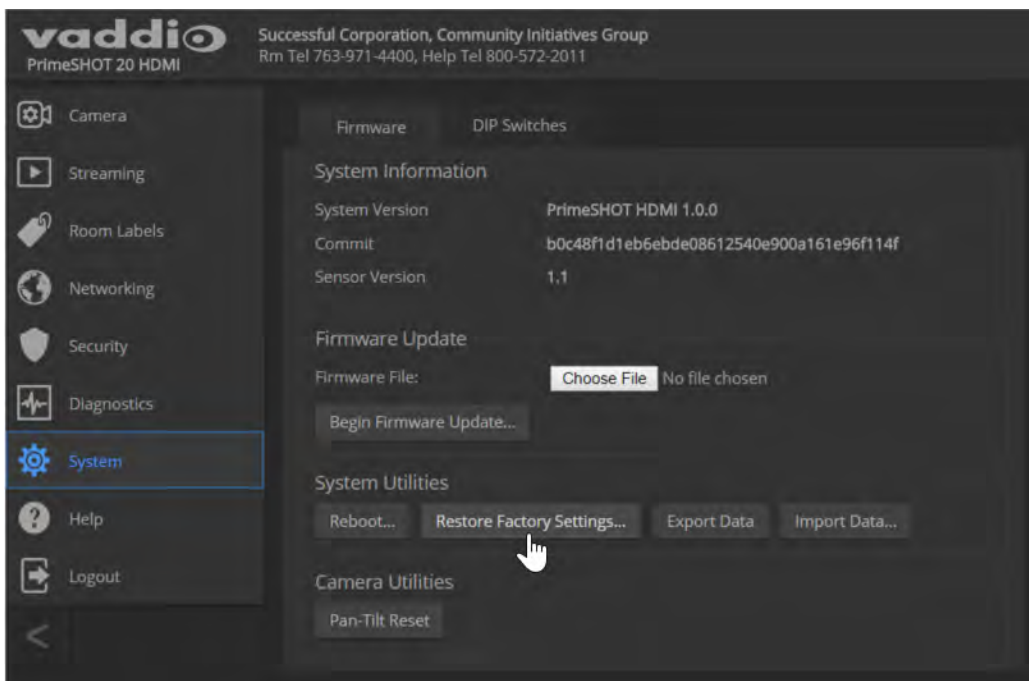

## Operation, Storage, and Care

For smears or smudges on the product, wipe with a clean, soft cloth. Use a lens cleaner on the lens. Do not use any abrasive chemicals.

Keep this device away from food and liquids.

Do not operate or store the device under any of the following conditions:

- Temperatures above 40°C (104°F) or below 0°C (32°F)
- High humidity, condensing or wet environments
- Inclement weather
- Severe vibration
- Between converging tectonic plates
- Dry environments with an excess of static discharge

Do not attempt to take this product apart. There are no user-serviceable components inside.

## Compliance Statements and Declarations of Conformity

Compliance testing was performed to the following regulations:

FCC Part 15 (15.107, 15.109), Subpart B	Class A
ICES-003, Issue 54: 2012	Class A
EMC Directive 2004/108/EC	Class A
EN 55032: 2015	Class A
EN 55024: November 2010	Class A
KN22 2008 (CISPR 22: 2006)	Class A
KN24 2008 (CISPR 24: 1997 + A1: 2000 + A2: 2002)	Class A
IEC 60950-1:2005 (2nd Edition); Am 1: 2009 + Am 2: 2013	Safety
EN 60950-1: 2006 + A11: 2009 + A1: 2010 + A12: 2011 + A2: 2013	Safety

### FCC Part 15 Compliance

This equipment has been tested and found to comply with the limits for a Class A digital device, pursuant to Part 15, Subpart B, of the FCC Rules. These limits are designed to provide reasonable protection against harmful interference when the equipment is operated in a commercial environment. This equipment generates, uses, and can radiate radio frequency energy and, if not installed and used in accordance with the instruction manual, may cause harmful interference to radio communications. Operation of this equipment in a residential area is likely to cause harmful interference in which case the user will be required to correct the interference at his/her own expense.

Operation is subject to the following two conditions: (1) This device may not cause interference, and (2) This device must accept any interference including interference that may cause undesired operation of the device.



Changes or modifications not expressly approved by Vaddio can affect emission compliance and could void the user's authority to operate this equipment.

### ICES-003 Compliance

This digital apparatus does not exceed the Class A limits for radio noise emissions from digital apparatus set out in the Radio Interference Regulations of the Canadian Department of Communications.

Le présent appareil numérique n'émet pas de bruits radioélectriques dépassant les limites applicables aux appareils numériques de la classe A prescrites dans le Règlement sur le brouillage radioélectrique édicté par le ministère des Communications du Canada.



## European Compliance

This product has been evaluated for Electromagnetic Compatibility under the EMC Directive for Emissions and Immunity and meets the requirements for a Class A digital device. In a domestic environment this product may cause radio interference in which case the user may be required to take adequate measures.

Standard(s) To Which Conformity Is Declared:



### **EMC Directive 2004/108/EC**

**EN 55022: December 2010**

**EN 55024: November 2010**

EN 61000-4-2: 1995 + Amendments A1: 1998 + A2: 2001

EN 61000-4-3: 2006 + A1: 2008

EN 61000-4-4: 2004 + Corrigendum 2006

EN 61000-4-5: 2006

EN 61000-4-6: 2009

EN 61000-4-8: 2010

EN 61000-4-11: 2004

### **KN22 2008 (CISPR 22: 2006)**

**KN24 2008 (CISPR 24: 1997 + A1: 2000 + A2: 2002)**

EN 61000-4-2

EN 61000-4-3

EN 61000-4-4

EN 61000-4-5

EN 61000-4-6

EN 61000-4-8

EN 61000-4-11

**IEC 60950-1: 2005 (2nd Edition); Am 1: 2009 + Am 2: 2013**

**EN 60950-1: 2006 + A11: 2009 + A1: 2010 + A12: 2011 + A2: 2013**

Conducted and Radiated Emissions

Immunity

Electrostatic Discharge

Radiated Immunity

Electrical Fast Transients

Surge Immunity

Conducted Immunity

Power Frequency Magnetic Field

Voltage Dips, Interrupts and Fluctuations

Conducted and Radiated Emissions

IT Immunity Characteristics

Electrostatic Discharge

Radiated Immunity

Electrical Fast Transients

Surge Immunity

Conducted Immunity

Power Frequency Magnetic Field

Voltage Dips, Interrupts and Fluctuations

Safety

Safety

## Warranty Information

See Vaddio Warranty, Service and Return Policies posted on [support.vaddio.com](http://support.vaddio.com) for complete details.

**Hardware\* warranty:** Two (2) year limited warranty on all parts and labor for Vaddio manufactured products. Vaddio warrants its manufactured products against defects in materials and workmanship for a period of two years from the day of purchase, to the original purchaser, if Vaddio receives notice of such defects during the warranty. Vaddio, at its option, will repair or replace products that prove to be defective. Vaddio manufactures its hardware products from parts and components that are new or equivalent to new in accordance with industry standard practices.

**Exclusions:** The above warranty shall not apply to defects resulting from improper or inadequate maintenance by the customer, customers applied software or interfacing, unauthorized modifications or misuse, mishandling, operation outside the normal environmental specifications for the product, use of the incorrect power supply, modified power supply or improper site operation and maintenance. OEM and special order products manufactured by other companies are excluded and are covered by the manufacturer's warranty.

**Vaddio Customer Service:** Vaddio will test, repair, or replace the product or products without charge if the unit is under warranty. If the product is out of warranty, Vaddio will test then repair the product or products. The cost of parts and labor charge will be estimated by a technician and confirmed by the customer prior to repair. All components must be returned for testing as a complete unit. Vaddio will not accept responsibility for shipment after it has left the premises.

**Vaddio Technical Support:** Vaddio technicians will determine and discuss with the customer the criteria for repair costs and/or replacement. Vaddio Technical Support can be contacted by email at [support@vaddio.com](mailto:support@vaddio.com) or by phone at one of the phone numbers listed on [support.vaddio.com](http://support.vaddio.com).

**Return Material Authorization (RMA) number:** Before returning a product for repair or replacement request an RMA from Vaddio's technical support. Provide the technician with a return phone number, e-mail address, shipping address, product serial numbers and original purchase order number. Describe the reason for repairs or returns as well as the date of purchase. See the General RMA Terms and Procedures section for more information. RMAs are valid for 30 days and will be issued to Vaddio dealers only. End users must return products through Vaddio dealers. Include the assigned RMA number in all correspondence with Vaddio. Write the assigned RMA number clearly on the shipping label of the box when returning the product. All products returned for credit are subject to a restocking charge without exception. Special order product are not returnable.

**Voided warranty:** The warranty does not apply if the original serial number has been removed or if the product has been disassembled or damaged through misuse, accident, modifications, use of incorrect power supply, use of a modified power supply or unauthorized repair.

**Shipping and handling:** Vaddio will not pay for inbound shipping transportation or insurance charges or accept any responsibility for laws and ordinances from inbound transit. Vaddio will pay for outbound shipping, transportation, and insurance charges for all items under warranty but will not assume responsibility for loss and/or damage by the outbound freight carrier. If the return shipment appears damaged, retain the original boxes and packing material for inspection by the carrier. Contact your carrier immediately.

**Products not under warranty:** Payment arrangements are required before outbound shipment for all out of warranty products.



## Photo Credits

This guide may include some or all of these photos.

European Space Agency (ESA) astronaut Samantha Cristoforetti, a Flight Engineer with Expedition 42, photographs the Earth through a window in the Cupola on the International Space Station

By NASA - [https://blogs.nasa.gov/ISS\\_Science\\_Blog/2015/03/06/women-in-space-part-two-whats-gender-got-to-do-with-it/](https://blogs.nasa.gov/ISS_Science_Blog/2015/03/06/women-in-space-part-two-whats-gender-got-to-do-with-it/), Public Domain, <https://commons.wikimedia.org/w/index.php?curid=38834990>

Carl Sagan, Bruce Murray, Louis Friedman (founders) and Harry Ashmore (advisor), on the occasion of signing the papers formally incorporating The Planetary Society

By credit NASA JPL - JPL, Public Domain, <https://commons.wikimedia.org/w/index.php?curid=1180927>

Main Control Room / Mission Control Room of ESA at the European Space Operations Centre (ESOC) in Darmstadt, Germany

By European Space Agency - ESOC flickr, Credit: ESA - Jürgen Mai, CC BY-SA 3.0-igo,

<https://commons.wikimedia.org/w/index.php?curid=36743173>

Expedition 42 on orbit crew portrait, International Space Station, Mar. 7, 2015 – Barry Wilmore (Commander) Top, Upside down, to the right cosmonaut Elena Serova, & ESA European Space Agency Samantha Cristoforetti. Bottom center US astronaut Terry Virts, top left cosmonauts Alexander Samokutyaev and Anton Shkaplerov.

By NASA - <https://www.flickr.com/photos/nasa2explore/16166230844/>, Public Domain,

<https://commons.wikimedia.org/w/index.php?curid=38931301>

European Space Agency astronaut Luca Parmitano, Expedition 36 flight engineer, outside the International Space Station

By NASA - <http://spaceflight.nasa.gov/gallery/images/station/crew-36/html/iss036e016704.html>, Public Domain, <https://commons.wikimedia.org/w/index.php?curid=27263573>

Chris Cassidy, Luca Parmitano, and Karen Nyberg, ISS, 2013. Photo Credit: NASA

Nicolas Altobelli, Rosetta Scientist at ESA's European Space Astronomy Centre, Villanueva de la Cañada, Madrid, Spain

By European Space Agency - Nicolas Altobelli talks to the media, CC BY-SA 3.0-igo,

<https://commons.wikimedia.org/w/index.php?curid=36743144>

Andrea Accomazzo, ESA Rosetta Spacecraft Operations Manager, providing a live update from the Main Control Room at ESA's European Space Operations Centre, Darmstadt, Germany during the Rosetta wake-up day.

By European Space Agency - Live update from the Main Control Room, CC BY-SA 3.0-igo,

<https://commons.wikimedia.org/w/index.php?curid=36743150>

Sleeping goose

By ladypine - Own work, CC BY-SA 3.0, <https://commons.wikimedia.org/w/index.php?curid=1695227>

# Index

## A

- admin password 13, 17
  - changing 17
  - default 13
- anatomy of the camera 3
- auto focus 24, 35
- auto iris 23, 37-38
- auto white balance 23, 37-38

## B

- backing up a configuration 19
- backlight compensation 23, 37-38
- bandwidth 26
- bit rate (IP streaming setting) 26
- blue gain 23, 37-38
- browser compatibility 12

## C

- cable connectors 5
- calibration fault, correcting 39, 56
- camera mount 5-6, 8
  - installing 6
- camera placement 5
- camera select 10-11
- camera specifications 54
- camera standby position 31
- capabilities 1, 54
- CCU scenes 39
  - custom 39
  - recalling 39
- CCU settings 36-38
- ceiling-mounted cameras 6
- cheat sheet 10-11, 14
  - web interface 14
- chroma setting 23, 37-38
- cleaning 57
- color codes for status light 9, 56
- color settings 23, 37-39
  - storing and recalling 39
- command history 44
- command set, RS-232 (VISCA) 45, 47-48, 50-53
- compatibility, browsers 12
- configuration, saving or restoring 19
- connection example 6

- connector identification 4
- connector pin-out, RS-232 7
- Constant Bit Rate 26
- controls available to admin 13
- controls available to non-admin user 13
- Controls page (web) 30
- custom home position 22

## D

- damage, preventing 2, 5, 7
- default IP address 12
- default settings, restoring 43, 57
- detail setting 23, 37-38
- DHCP 15
- diagnosing issues 42, 55
- diagnostic logs 21
- Diagnostics page (web) 21
- DIP switches 29
  - soft 29
- directional controls 10-11, 30

## F

- factory defaults, restoring 43, 57
- fault isolation 42, 55
- firmware update 20
- firmware version 43
- focus 10-11, 24, 35
- Frame Rate (IP streaming setting) 26

## G

- gain 23
  - blue 23
  - red 23
- gamma setting 23
- getting help 21
- guest access 17

## H

- Help page (web) 21
- home position 22, 30, 33
  - custom 22
- hostname 15

## I

- importing a configuration 19
- inactive sessions (web interface) 17
- indicator light 9, 29, 39, 56
  - behavior 29, 39
  - color scheme 29

- enabling/disabling 29
- meaning of colors 9, 56
- information, conference room 18
- installation 6, 8
  - camera 8
  - camera mount 6
- installation, typical 6
- inverted installation 6
- IP address 10-12, 15
  - default 12, 15
  - discovering 12
- IP streaming 25-26, 41
  - enabling/disabling 25
  - settings 26, 41
- IR remote 10-11
- iris settings 37-38

## L

- labels, room 18
- LED control 39
- light, status indicator 9, 29, 39, 56
  - behavior 29, 39
  - color scheme 29
  - enabling/disabling 29
  - meaning of colors 9, 56
- lighting settings 37-38
- location of the camera 5
- locations of connectors 4
- log files 21
- login, admin 13
- low-power (standby) state 31, 40
- low-power state 39

## M

- manual focus 10-11, 24, 35
- Max Bandwidth (IP streaming setting) 26
- motor calibration 39, 56
- mount 5-6, 8
- mounting the camera 5, 8
- muting 31, 40
  - video 31, 40

## N

- navigation buttons, hiding/showing 14
- network configuration 12, 15, 41
  - current 41
  - default 15
- Networking page (web) 15
- NTP server 16

## O

- operating environment 5, 57

## P

- packing lists 2
- page 15, 17-18, 21, 30
  - Controls 30
  - Diagnostics 21
  - Help 21
  - Networking 15
  - Room Labels 18
  - Security 17
- pan 10-11, 24, 30, 33
  - direction 24
  - speed 24, 33
- pan/tilt recalibration 39, 56
- pan/tilt/zoom 24
- part numbers 2
- passwords 13, 17
  - admin, default 13
  - user, default 13
- performance specifications 54
- physical and environmental specifications 54
- pin-out, RS-232 connector 7
- ping command 42
- power on/power off 10-11, 31, 40
- precautions 5
  - for operating the system 5
- presets 10-11, 22, 30, 36
  - clearing 11
  - moving to 30, 36
  - setting 11, 22, 36
- pro A/V status light color scheme 29
- product capabilities 1, 54
- product returns and repairs 60

## Q

- quick reference 10-11, 14
  - remote control 10
  - Vaddio IR Remote Commander 11
  - web interface 14

## R

- ready state 31, 40
- rebooting 19, 42
- recalibration, pan and tilt 39, 56
- red gain 23, 37-38
- regulatory information 58

remote control 10-11  
 requirements 5  
   installation 5  
   mounting 5  
 reset 39, 56. See also rebooting; restoring  
   default settings  
   pan and tilt motors 39, 56  
 resolution 4, 26  
   IP streaming 26  
   switch setting 4  
 restoring a configuration 19  
 restoring default settings 43, 57  
 RJ-45 connectors 5  
 room information 18  
 Room Labels page (web) 18  
 rotary switch settings 4  
 RS-232 commands 45, 47-48, 50-53  
   setting values 50-51  
 RS-232 connector pin-out 7  
 RS-232 serial connection 7

## S

saving a configuration 19  
 Security page (web) 17  
 setting up and storing shots 22  
 settings, default, restoring 43, 57  
 shelf-mounted cameras 8  
 shelf, camera mount 6  
 site requirements 5  
 soft DIP switches 29  
 software update 20  
 solving problems 55  
 specifications 54  
 speed 10-11, 24, 33-35  
   focus 35  
   pan 24, 33  
   tilt 24, 34  
   zoom 10-11, 24, 35  
 standby (low-power) state 31, 40  
 static IP address 15  
 status light 9, 29, 39, 56  
   behavior 29, 39  
   color scheme 29  
   enabling/disabling 29  
   meanings of colors 9, 56  
 storage environment 57  
 storing a configuration 19  
 streaming 25-26, 41  
   configuring 26

  enabling/disabling 25  
   settings 41  
 supported web browsers 12  
 switch settings 6, 29  
   in web interface 29  
 switch, video resolution 4  
 syntax help, Telnet commands 44

## T

technical specifications 54  
 technical support 21  
 telnet commands  
   typographical conventions 32  
 Telnet commands 32-44  
   syntax help 32, 44  
 Telnet session 32, 44  
   ending 44  
   history 44  
 temperature, operating and storage 57  
 third-party control 7, 32  
 tilt 10-11, 24, 30, 34  
   speed 24  
 time zone 16  
 troubleshooting 42, 55

## U

UC conferencing status light color scheme 29  
 update 20  
 user password 13, 17  
   changing 17  
   default 13

## V

Vaddio IR Remote Commander 10-11  
 Variable Bit Rate 26  
 version, firmware 43  
 video mute 31, 40  
 Video Quality (IP streaming setting) 26  
 video resolution setting 4  
 virtual DIP switches 29  
 VISCA commands 45, 47-48, 50-53  
 visual packing list 2  
 visual parts identification 3

## W

wall mount 6  
   installing 6  
 warranty 5, 60  
 web browsers supported 12

web interface 14-15, 17-18, 21, 30

Controls page 30

Diagnostics page 21

Help page 21

navigation button labels 14

Networking page 15

Room Labels page 18

Security page 17

## **Z**

zoom 10-11, 24, 30, 35

speed 10-11, 24, 35

Vaddio is a brand of Milestone AV Technologies · [www.milestone.com](http://www.milestone.com)

Phone 800.572.2011 / +1.763.971.4400 · Fax +1.763.971.4464 · Email [info@vaddio.com](mailto:info@vaddio.com)

Visit us at [support.vaddio.com](http://support.vaddio.com) for firmware updates, specifications, drawings, manuals, technical support information, and more.

Vaddio and PrimeSHOT are trademarks or registered trademarks of Milestone AV Technologies. The terms HDMI and HDMI High-Definition Multimedia Interface, and the HDMI logo, are trademarks or registered trademarks of HDMI Licensing LLC in the United States and other countries. All other brand names or marks are used for identification purposes and are trademarks of their respective owners.

In British Columbia, Milestone AV Technologies ULC carries on business as MAVT Milestone AV Technologies ULC.

©2018 Milestone AV Technologies

The logo for Vaddio, featuring the word "vaddio" in a bold, blue, lowercase sans-serif font. The final letter "o" is stylized as a circle with a smaller solid blue circle inside it, and a registered trademark symbol (®) is positioned to the upper right of the circle.