

Marshall Electronics

Model No. **V-MD173**
Rack Mountable High Definition LCD Monitor

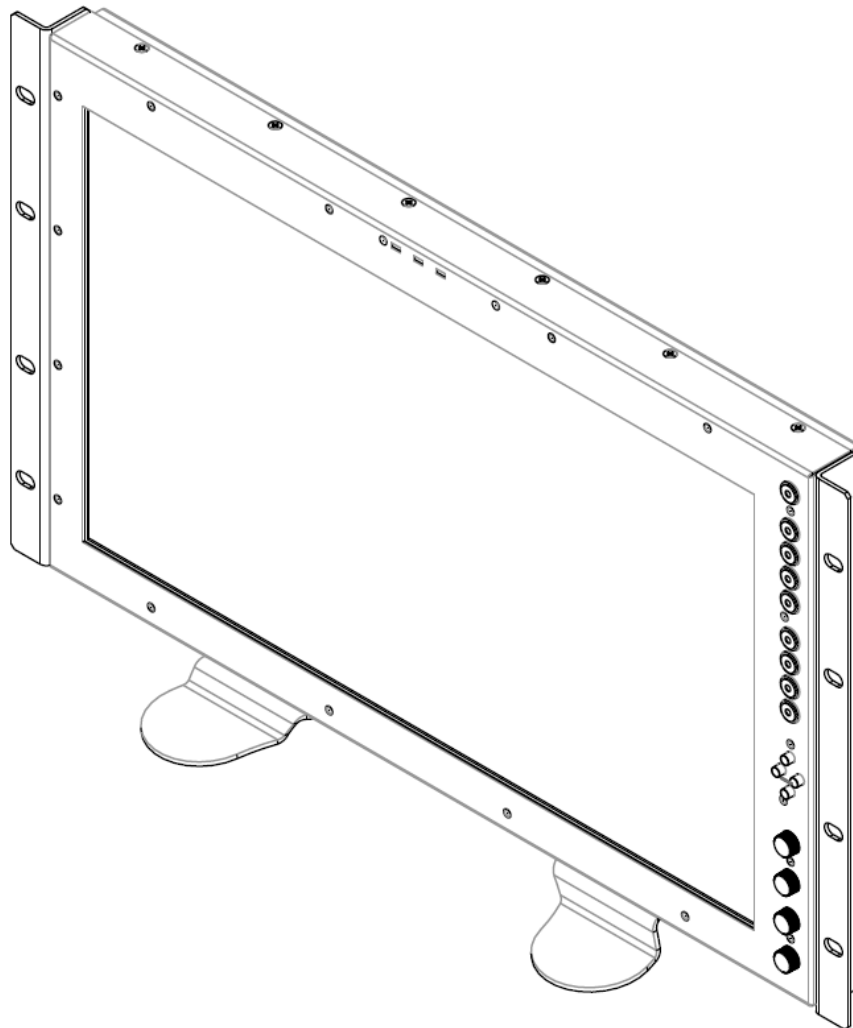

Operating Instructions

Edition 1 Revision 7W

Table of Contents

Installation and Initial Setup	3
Top and Front Panel Features	4
Rear Panel Features.....	5
Compatible Input Formats.....	6
Input Module Installation.....	7
MAIN MENU AND NAVIGATION.....	8
VIDEO CONFIGURATION SUBMENU.....	8
MARKER CONFIGURATION SUBMENU	9
FILTER CONFIGURATION SUBMENU.....	14
SYSTEM CONFIGURATION SUBMENU	16
FUNCTION PRESETS SUBMENU	17
IMD & TALLY CONFIGURATION	18
SYSTEM INFORMATION SUBMENU	19
Specifications.....	20
Dimensions.....	21
Maintenance.....	24
Warranty	24

Installation and Initial Setup

■ Unpacking

Carefully unpack the V-MD173 monitor and verify that the following items are included:

- V-MD173 Monitor
- V-PS12-5A-XLR Power Supply
- Operating Instructions

Inspect the unit for any physical damage that may have occurred during shipping. Should there be any damage, immediately contact Marshall Electronics at (800) 800-6608. If you are not located within the continental United States, call +1 (310) 333-0606.

■ Installation

The V-MD173 can be mounted in any standard EIA 19" equipment rack. The attached rack ears can be angled to provide the user control over the viewing angle. Adequate ventilation is required when installed to prevent possible damage to the monitor's internal components. Please see the [Dimensions](#) section for more information.

A VESA standard 75mm hole pattern also allows custom mounting installations. Alternately, the V-MD173 can be used in a desktop configuration with optional stand. Please contact Marshall Electronics for more information.

Warning: Please use only the square type VESA mount (which fits inside the VESA Screw Length WARNING silkscreen) with the 75mm hole pattern in order to avoid obstructing Module Slot 2.

Please contact Marshall Electronics or visit www.LCDRACKS.com for further information.

■ Connections, Power-On and Initial Setup

Plug the power supply into an AC power source (100-240 V @ 50/60 Hz). Attach the Power connector to the back of the monitor. Connect the required cables for video signal input and output. (Power must be applied to the V-MD173 for the active loop-through output to be activated.) The monitor defaults to 'ON' when power is supplied. Video will automatically be detected and displayed on the screen.

Top and Front Panel Features

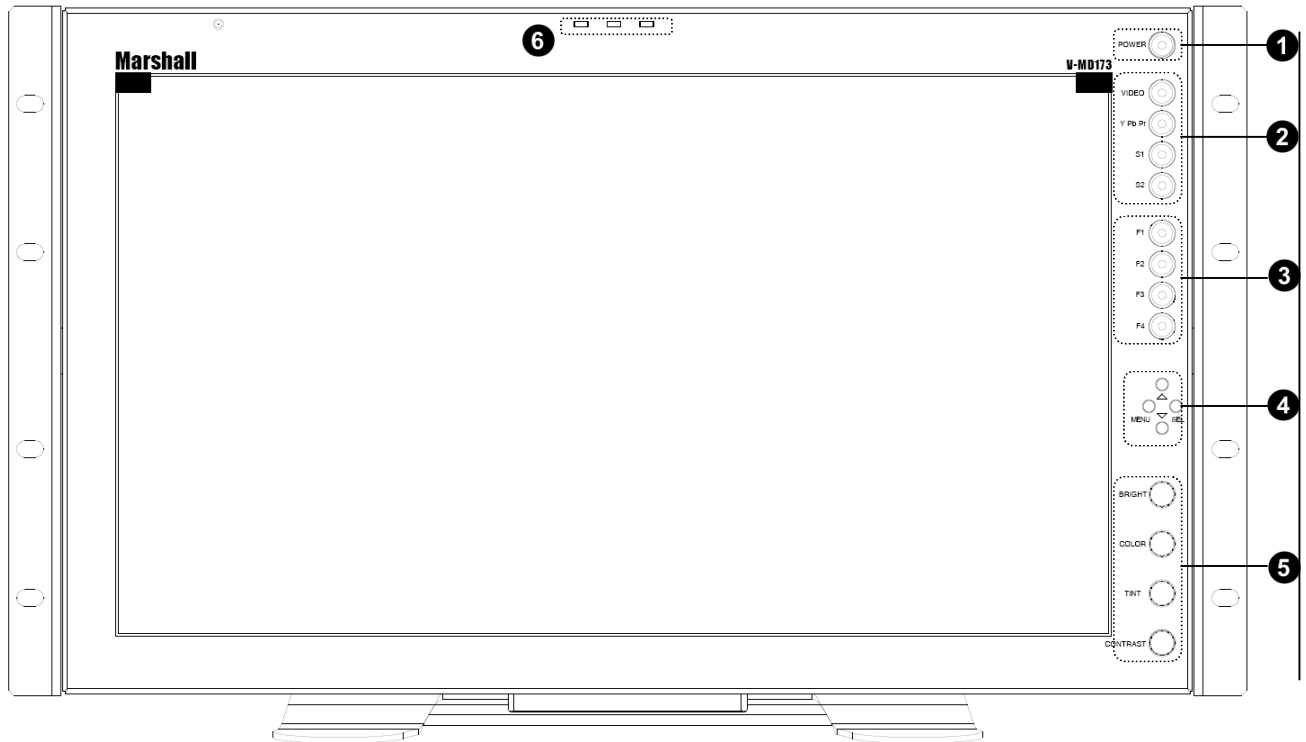

❶ Power Button

Use the power button to toggle between ON and STANDBY modes. In both the STANDBY and the ON state, the LED on the button will illuminate bright green. This indicates that MAIN power is applied to the unit.

❷ Input Select Buttons

Use the VIDEO, YPbPr, S1 and S2 buttons to select the corresponding analog or digital input. Video standards (NTSC/PAL, etc.) are automatically detected. S1 and S2 buttons select inputs connected to *Optional Input Modules* (located in Slot-1 or Slot-2).

❸ User-Definable Function Buttons

Four user-definable function buttons can be used for direct access to various settings. Functions are assigned using the on-screen menu.

❹ Menu Navigation Buttons

Use the Menu, ▲, ▼, and Select buttons to display and navigate the on-screen menu ([See Main Menu and Navigation](#)).

❺ Image Adjustment Knobs

Use the image adjustment knobs to adjust color brightness, color-saturation, tint, and contrast of the image. The status of each image adjustment parameter is shown on the bottom left of the screen, with values ranging from 0 to 100. Default value is 50.

❻ LED Tally

Three LED tally lights (yellow, red, green) are available above the screen.

Rear Panel Features

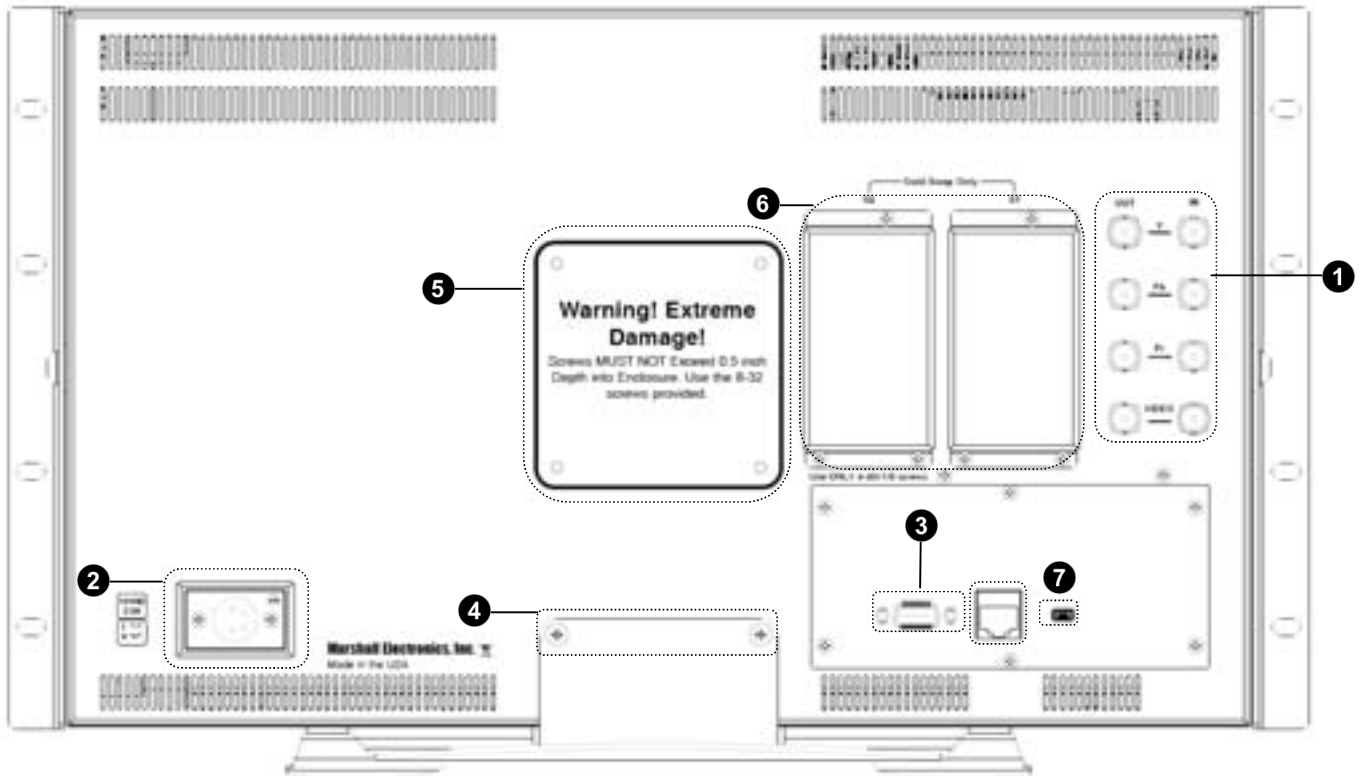

1 YPbPr and CVBS Video Input and Output

The V-MD173 has CVBS and YPbPr inputs and one active through output for each input. See [Compatible Input Formats](#) for details on accepted formats.

2 Power Input

Connect 12VDC to the 4-pin XLR power input connector. Power should only be supplied from the included power supply.

IMPORTANT: If using a power source other than the included power supply, damage may result. Please use the pin out diagram in the [Specifications](#) section.

3 Tally Input Connector

The LED tally can be activated via the [HD-15 connector](#) by connecting the corresponding pin to ground. A variety of external devices can be used to perform the contact closure. No additional power should be supplied to the HD-15 port.

4 Desktop Mounting Holes

These holes are used when attaching the monitor to the optional desktop stand.

5 VESA 75mm Hole Pattern

VESA-standard 75 mm hole-patterns is provided to accommodate a variety of custom mounting options. See [Dimensions](#) for further details.

Warning: Please use only the square type VESA mount (which fits inside the VESA Screw Length WARNING silkscreen) with the 75mm hole pattern in order to avoid obstructing Module Slot 2.

6 Optional Module Slot 1 / Slot 2

The V-MD monitor comes with Module Slots for Marshall Electronics' line of future proof Input Modules. Please contact Marshall Electronics for a list of compatible Input Modules. See the [Input Module Installation](#) instructions for details on Module installation.

7 PROG Port

The PROG port is a Service / Upgrade port only. Please contact Marshall Electronics for more information.

Compatible Input Formats

The following video standards are supported by the V-MD173:

Video Input

NTSC, PAL

YPbPr Input

480i, 576i/50

480p, 576p/50

720p/25, 29.97, 30, 50, 59.94, 60

1080p/23.98, 23.98sF, 24, 24sF

1080i/50, 59.94, 60

Optional Input Modules (Type A modules)

MD-3GSDI and MD-TC – 3G/HD/SDI Input Module with Loop-Through

525i, 625i/50

720p/25, 29.97, 30, 50, 59.94, 60

1080p/23.98, 23.98sF, 24, 24sF, 25, 29, 30

1080i/50, 59.94, 60

3G – Level A and Level B

YCbCr, YCbCr+A, RGB, RGB+A

1080p/ 60, 59.94, 50

1080p/ 30, 29.97, 25, 24, 23.98, 30sF, 29.97sF, 25sF, 24sF, 23.98sF

1080i/ 60, 59.94, 50

MD-HDSDIx2 – Two-channel HD-SDI Input Module with switched output

525i, 625i/50

720p/25, 29.97, 30, 50, 59.94, 60

1080p/23.98, 23.98sF, 24, 24sF, 25, 29, 30

1080i/50, 59.94, 60

MD-HDMIx2 – Two-channel HDMI Input Module

480p/59.94, 576p/50

720p/25, 29.97, 30, 50, 59.94, 60

1080p/23.98, 23.98sF, 24, 24sF, 25, 29, 30

1080i/50, 59.94, 60

MD-DVII – DVI-I Input Module

640 x 480/ 60, 75, 85

800 x 600/ 60, 75, 85

1024 x 768/ 60, 75, 85

1280 x 1024/ 60, 75

1600 x 1200/ 60 (CVT Timing)

1920 x 1200/ 60 (CVT Timing)

Input Module Installation

1. Remove Power From Unit

- Modules are cold-swappable only. Damage will occur if modules are inserted or removed while unit is powered.

2. Remove Blank Module Cover

- Using Philips screwdriver, remove the 4-40x1/8" screws. There are a total of three screws, save them for later use.
- Remove blank cover

3. Insert Optional Module

- Decide which slot you intend to install module (Slot 1 or Slot 2)
- Carefully align the module with the chosen slot. The raised rails will fit inside the module
- Align the Module so that the three (3) mounting holes all line up with the threaded holes of the slot.
- The connectors on both the module and the main-board slot should now be in alignment.
- Carefully PRESS the module into the slot. Module will seat flush with the rear of the unit.
- Replace the three (3) screws removed in Step 2.

NOTE Use ONLY 4-40x1/8" screws provided. Any screw longer than 1/8" will damage the main unit.

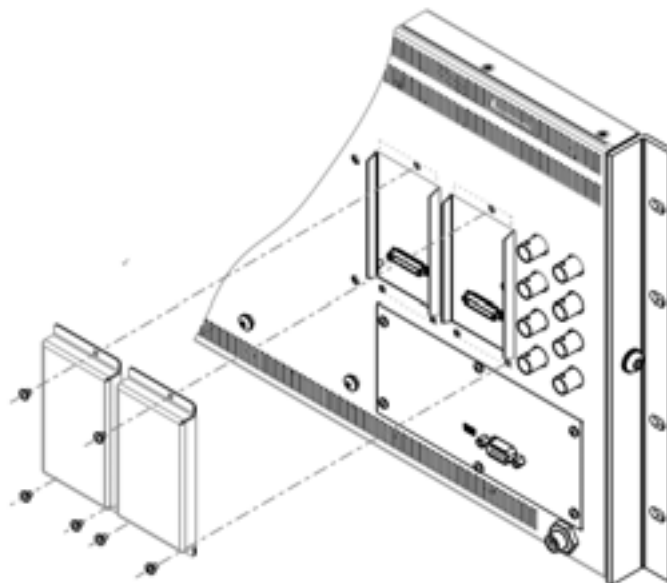

MAIN MENU AND NAVIGATION

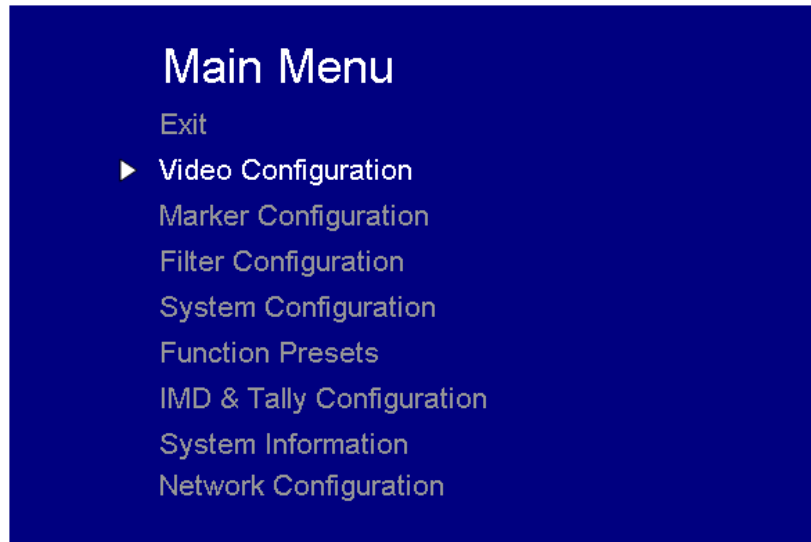

Access the main menu by pushing and holding the **MENU** button on the front panel of the monitor.

- Step through menu items using the ▲ and ▼ buttons.
- Choose a submenu or select a menu item by pressing **SELECT**.
- Return to the previous menu by pressing **MENU**.
- Exit the main menu by pressing **MENU**. The menu will automatically time out after 15 seconds.

VIDEO CONFIGURATION SUBMENU

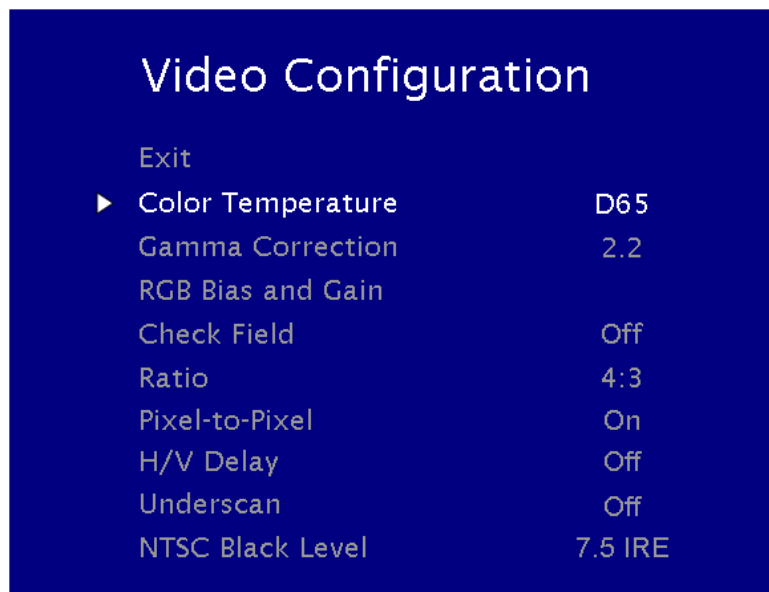

■ Color Temperature

Use this setting to choose one of three color temperature presets:

- D55 (5500K)
- D65 (6500K)
- 9300K
- USER (Adjustable Color Bias and Gain)
- Linear (No processing is applied to the panel)

Use this setting to enable monochrome mode. Only the luminance of the image will be displayed as a grayscale picture.

■ Gamma

Use this setting to choose one of four selectable Gamma tables:

- 1.6
- 1.8
- 2.0
- 2.2
- 2.4

Note: Gamma is disabled when **Color Temperature** is set to **Linear**

■ RGB Bias and Gain

Select this submenu to fine-tune the monitor's color balance (R, G, B). This should only be done by someone experienced with video engineering, as this will alter the overall color shading of the screen. The purpose is to allow color matching to other types of monitors and/or displays. Note: The Color Temperature preset will automatically switch to USER when Color Bias settings are adjusted. It is normal for color bias adjustments to be very subtle.

When selecting the RGB Bias and Gain submenu, gain adjustment indicators will appear at the top of the screen, and bias adjustment indicators will appear at the bottom of the screen:



RGB Bias and Gain

Use the ▲ and ▼ buttons to select each individual bias or gain control. Press SELECT to begin adjusting the control. Use the ▲ and ▼ buttons to increase or decrease the value.

Alternately, the image adjustment buttons (Brightness, Color, Tint, Contrast) can be used to easily adjust the bias and gain settings as shown below. The buttons affect whichever row of controls (gain or bias) is currently selected.

■ Check Field

Use the check field modes for monitor calibration or to analyze individual color components of an image. In Monochrome mode, all color is disabled and only a grayscale image is shown. In Blue, Green, and Red check field modes, only the selected color will be shown.

Use the following procedure when calibrating the monitor to SMPTE color bars with the following procedure:

1. Allow the monitor to warm up for at least 5-10 minutes.
2. Display SMPTE split-field color bars on the monitor using an external source.
3. Enable **Monochrome mode**.
4. Locate the pluge pattern (super black, black, and gray bars) at the lower-right corner of the screen. Adjust the **Brightness** button until there is no visible difference between the super black and black bars, but the gray bar is still visible.
5. Adjust the **Contrast** button until an even grayscale appears along the top bars.
6. Disable **Monochrome mode**.
7. Enable **Blue Check Field mode** and adjust the **Color** button so that the outermost bars (white and blue) appear to match in brightness.
8. Composite NTSC only: Adjust the **Tint** button until the third bar from the left (cyan) and the third bar from the right (magenta) appear to match in brightness.
9. Disable **Blue Check Field mode**.

■ Ratio Settings

Use to switch between Full Screen, 4:3 and 16:9 aspect ratios.

- In Full Screen mode, images are scaled to fill the entire screen.
- In 4:3 mode, images are scaled to fill the center 4:3 portion of the screen. With a 16:9 source, images will be centered with a black letter-box added on the left and right sides.
- In 16:9 mode, images are scaled to a 16:9 portion of the screen , with a black letter-box added top and bottom.

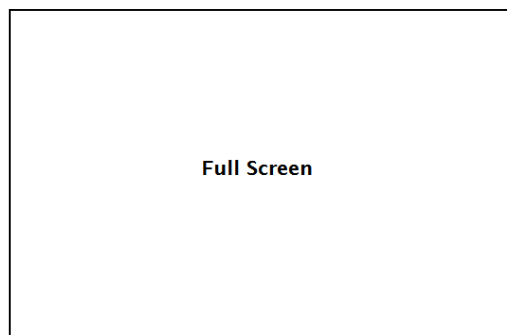

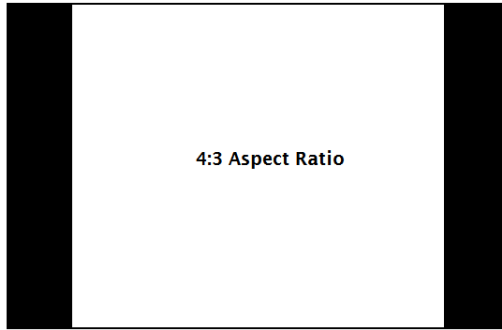

Note: The aspect ratio setting is ignored when Pixel-to-Pixel mode is enabled.

■ Pixel-to-Pixel

Use this setting to enable Pixel-to-Pixel mode.

This Pixel-to-Pixel mode bypasses the monitor's internal scaling function and displays incoming images in their native resolution and aspect ratio, with a one-to-one mapping:

- For incoming formats smaller than the native resolution of the LCD panel, the image will be displayed in the center of the screen using only the necessary LCD pixels. For example, NTSC images will occupy exactly 720 x 480 pixels. The surrounding pixels will be black.

Note: Pixel-to-Pixel mode disables aspect ratio control and H/V Delay.

MARKER CONFIGURATION SUBMENU

Use the Video Configuration submenu to select various video settings such as monochrome mode or blue-only mode.

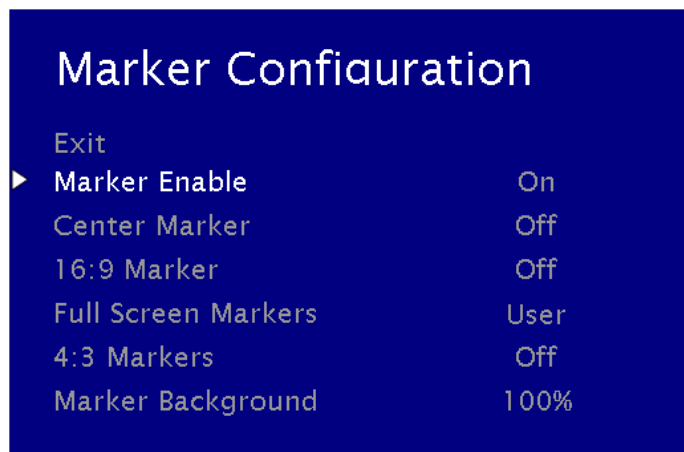

Marker Configuration Submenu

■ Marker Enable

Use this setting to enable or disable all on-screen markers. This setting affects the center marker, full screen markers, 16:9 markers and 4:3 markers.

■ Center Marker

Use this setting to display a center marker on the screen.

■ 16:9 Markers

Use these settings to superimpose one of 12 markers on the screen when in 16:9 mode.

- 4:3
- 13:9
- 14:9
- 1.85:1
- 2.35:1
- 95% Safe
- 93% Safe
- 90% Safe
- 88% Safe
- 85% Safe
- 80% Safe

16:9 Marker Examples:



OFF (No Marker)

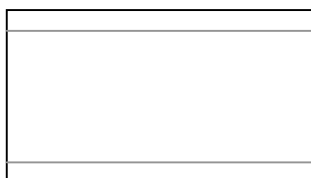

2.35:1 Aspect Ratio



4:3 Aspect Ratio Marker

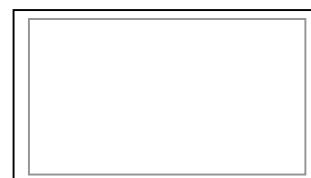

90% Safe Area

■ Full Screen Markers

Use these settings to superimpose one of 6 markers on the screen when in Full Screen mode.

- 95% Safe
- 93% Safe
- 90% Safe
- 88% Safe
- 85% Safe
- 80% Safe

■ 4:3 Markers

Use this setting to superimpose one of 5 markers on the screen when in 4:3 mode.

- 95% Safe Area
- 93% Safe Area
- 90% Safe Area
- 88% Safe Area

- 85% Safe Area
- 80% Safe Area

4:3 Marker Examples:

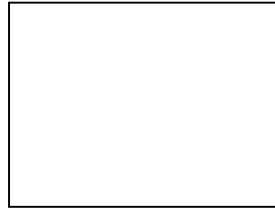

OFF (No Marker)



90% Safe Area

■ Marker Background

Use this setting to choose how selected markers are displayed on the screen. :

- 0% The marker is superimposed on the complete image.
- 25% Image area beyond the marker is shown at 25% intensity.
- 50% Image area beyond the marker is shown at 50% intensity.
- 75% Image area beyond the marker is shown at 75% intensity.
- 100% Image area beyond the marker is shown at 100% intensity (black).

Example (80% Marker in 4:3 Mode):



0% Background



100% Background

FILTER CONFIGURATION SUBMENU

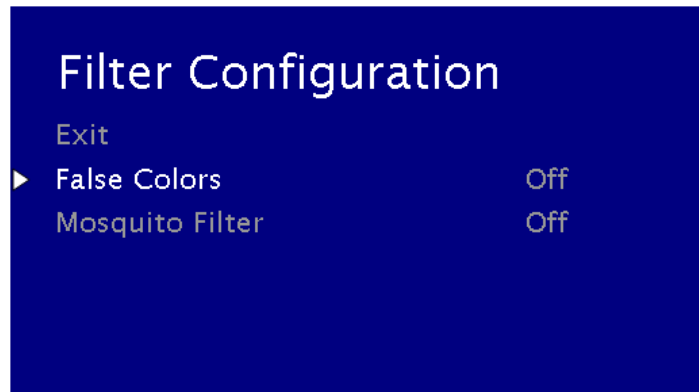

■ False Colors

This monitor has a false color filter to aid in the setting of camera exposure. As the camera Iris is adjusted, elements of the image will change color based on the luminance or brightness values. This enables proper exposure to be achieved without the use of costly, complicated external equipment. To best utilize this feature, you must understand the color chart below and have a basic understanding of camera exposure. Normally, when shooting subjects like people, it is common practice to set exposure of faces to the equivalent of approximately 56 IRE. The false color filter will show this area as the color PINK on the monitor. Therefore, as you increase exposure (open the IRIS), your subject will change color as indicated on the chart: PINK, then GREY, then a few shades of YELLOW. Over exposed subjects (above 101 IRE) on the monitor will be shown as RED. In addition, underexposed subjects will show as DEEP-BLUE to DARK-BLUE, with clipped-blacks indicated with a FUCHSIA-like color. Lastly, the color GREEN is used to indicate elements of the image that are approximately 45 IRE. This represents a 'neutral' or 'mid-level' exposure commonly used for objects (not people).

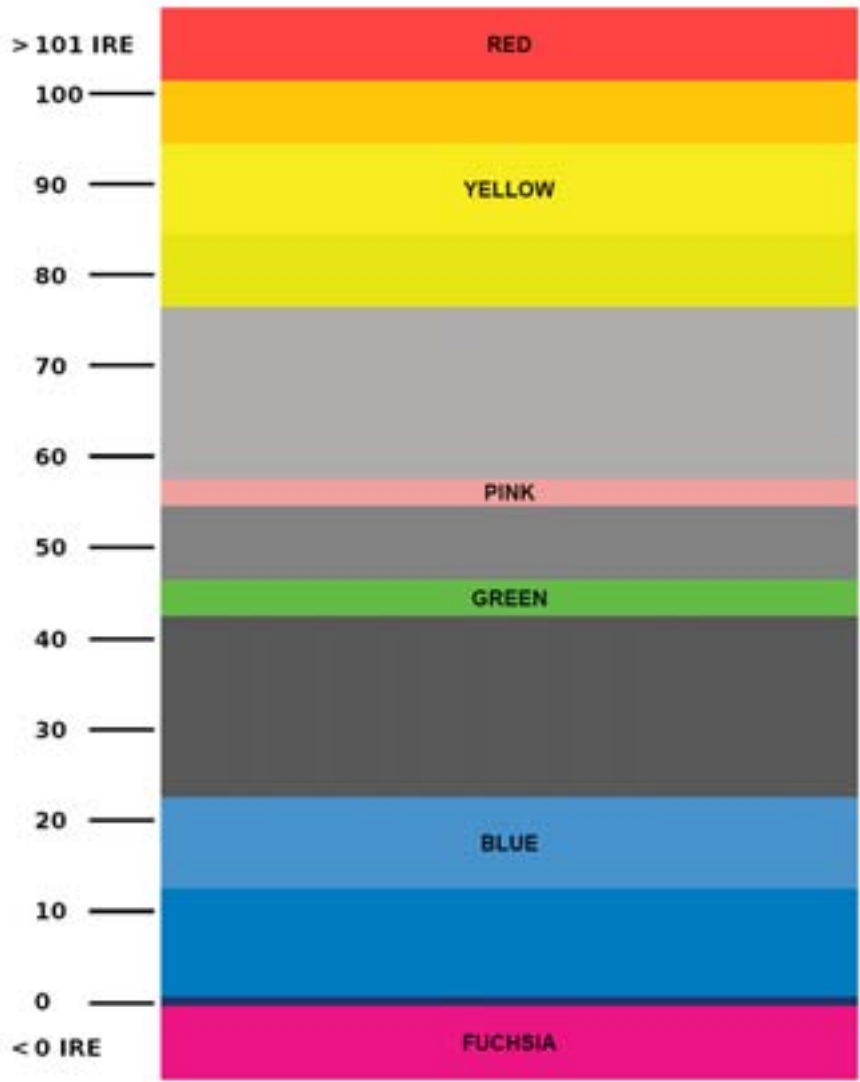

False Color Key

■ Mosquito Filter

Use this setting to filter out “Mosquito Noise” – an artifact that appears as specs around edges of objects. This artifact is the result of video that has been compressed at some point. Video sources from DVD-Players, PDA’s, Digital Cable Boxes, Camcorders, etc. often have this artifact.

SYSTEM CONFIGURATION SUBMENU

Use the Color Configuration submenu to adjust the color temperature of the display.

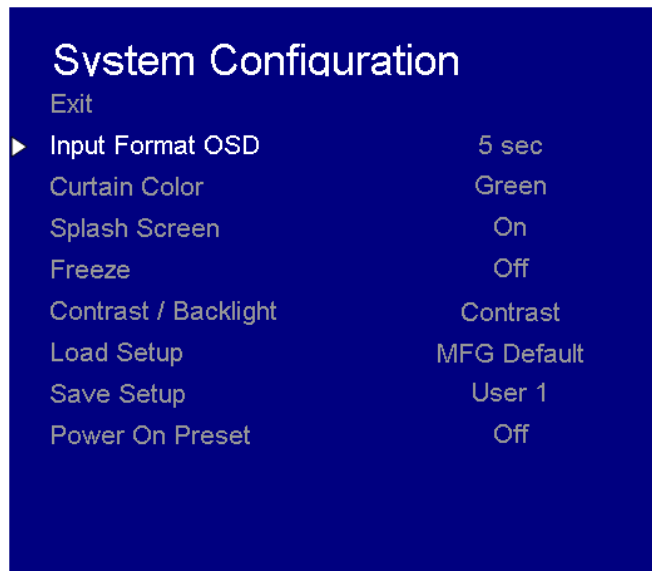

Color Configuration Submenu

■ Input Format OSD

Use this option to enable on-screen display of input/format status in the upper-left corner of the screen.

■ Curtain Color

Use this option to change the curtain color on the monitor. This curtain color is what you see when there is no signal input to the monitor.

■ Splash Screen

Use this option to enable or disable the Marshall Electronics Inc. splash screen seen when the monitor is first powered on.

■ Freeze

Use the Freeze function to “freeze” the current image on the screen. Select this menu item again (Unfreeze) to return to the real-time video input.

■ Contrast / Backlight

Use this feature to choose between controlling the Contrast of the image or the intensity of the panel's Backlight with the CONTRAST button on your monitor. **Note:** While the Contrast control moves up and down at intervals of 1, the Backlight control will move up and down at intervals of 2, from 0-100.

■ **Load Setup**

Select this menu item to reset all adjustments and menu settings to the factory default configuration or to one of the user configured presets.

■ **Save Setup**

Select this menu item to save a current setup into one of 6 available user presets.

■ **Power On Preset**

Select this menu item to reset all adjustments and menu settings to the factory default configuration whenever the unit is powered down.

FUNCTION PRESETS SUBMENU

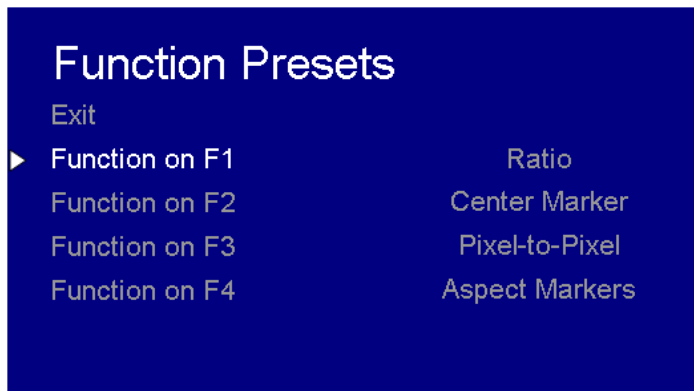

■ **Function Presets**

Allows user to assign menu items to the front panel function buttons: **F1, F2, F3 and F4**. The following options are available for each button:

- Ratio
- Check Field
- Mosquito Filter
- False Colors
- Freeze Input
- Aspect Markers
- Center Marker
- Marker Enable
- Underscan
- H/V Delay
- Pixel-to-Pixel

IMD & TALLY CONFIGURATION

IMD & Tally Configuration	
Exit	
▶ Text Enable	Off
Text String	M a r s h a l l M o n i t o r
Text Color	Green
Text Background	50%
Text Alignment	Center
Tally Source	HD-15 (Contact Closure)
LED Tally	On
On-Screen Tally	Off
Text Tally	Off

■ Text Enable

Use the Text Enable function to turn the MD Text feature ON. This will cause the Text String to appear on the lower portion of the screen.

■ Text String

Use this field to enter your own 16 character string on the screen.

■ Text Color

Use this field to change the color of the text in the Text String field.

■ Text Background

Use this field to change the opacity of the background behind the text in the Text String field. A value of 0% will cause the background to appear black. A value of 100% will make the background invisible.

■ Text Alignment

Use this field to change the alignment of the text string mentioned above.

■ Tally Source

Use this setting to change the source of the LED tally lights. Choosing the HD-15 (Contact Closure) option will render the LAN Tally interface disabled. Choosing the LAN 100 option will also render the HD-15 (Contact Closure) connector inoperable.

■ LED Tally

Use the LED Tally option to turn the physical LED tally lights ON or OFF.

■ On-Screen Tally

Use the On-Screen Tally option to turn the On-Screen tally ON or OFF.

■ Text Tally

Use the Text Tally option to lock the Text String color to the same color as the current Tally color. When there is no specific tally color enabled, the text string will default to the Text Color selection made in the IMD & Tally Configuration menu option.

SYSTEM INFORMATION SUBMENU

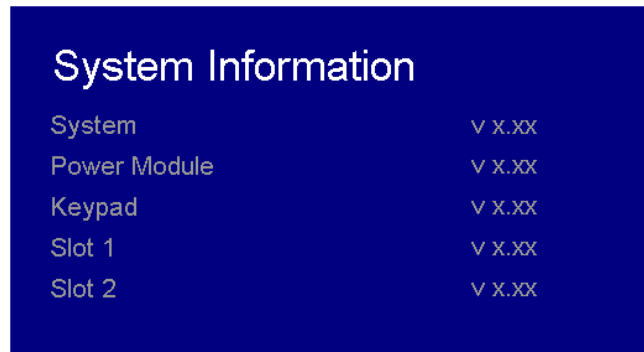

■ System

This shows the System firmware version of your monitor.

■ Power Module

This shows the Power Module firmware version of your monitor.

■ Keypad

This shows the Keypad firmware version of your monitor.

■ Slot (1 or 2)

This shows your module type and the firmware version of your module. If no module is present, the word EMPTY will appear in parentheses.

Specifications

■ PANEL

Screen Size	17.3" Diagonal
Display Area (h x v)	381.888 x 214.812 mm
Pixels	1920 x RGB x 1080
Viewing Angle	(h x v) 160° x 160°
Brightness	400 cd/m2
Contrast Ratio	600:1

■ VIDEO INPUT/OUTPUT

Video Input / Output (Composite)
Supports SMPTE 170M, NTSC/PAL

YP_BP_R Input / Output (Component)
Supports SMPTE 260M, 274M, 296M

■ CONNECTORS

Video Input

Video (Composite)	1 x BNC Female (75 Ω)
YP _B P _R (Component)	3 x BNC Female (75 Ω)

Video Output (Active Loop-Through)

Video (Composite)	1 x BNC Female (75 Ω)
YP _B P _R (Component)	3 x BNC Female (75 Ω)

S1, S2 (Module Slots)

For Marshall I/O Modules Only
Cold-Swap – remove power from unit before
Inserting or removing Modules.

Power Input

4-Pin XLR Connector

Tally Hardware Interface

HD-15 Female

HD-15 Female

CN-1 – Programming Port*

Factory / Upgrade Use Only

■ TALLY Hardware Interface (HD-15)

Activation requires contact closure of pin to ground on the HD-15 connector:



■ ELECTRICAL

Power Consumption	N/A
Voltage Requirement	12 VDC



Pin number	Signal
1	GND
2, 3	—
4	+12 V

■ MECHANICAL

Weight (with rack ears): 8.75 lbs

Operating Temperature	32°F to 104°F (0°C to 40°C)
Storage Temperature	-4°F to 120°F (-20°C to 50°C)

See [Dimensions](#) section for exact specifications.

Warning: Please use only the square type VESA mount (which fits inside the VESA Screw Length WARNING silkscreen) with the 75mm hole pattern in order to avoid obstructing Module Slot 2.

Dimensions

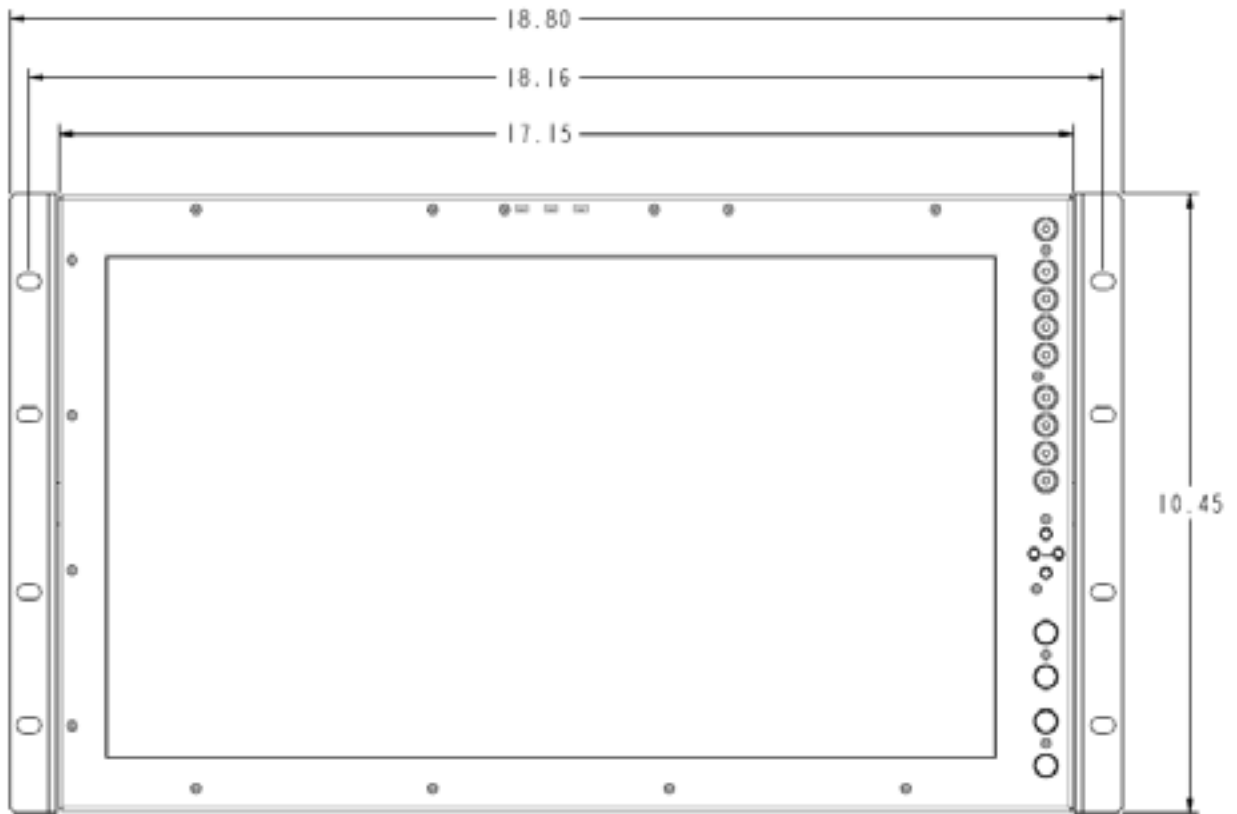
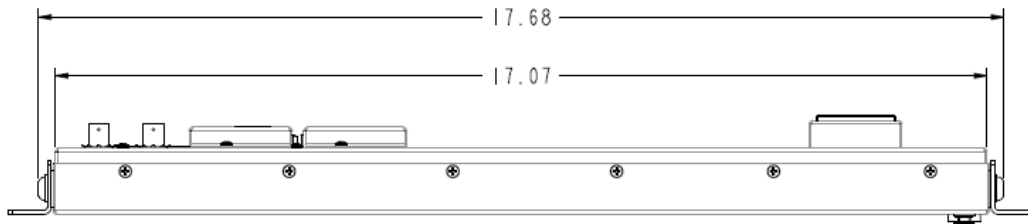

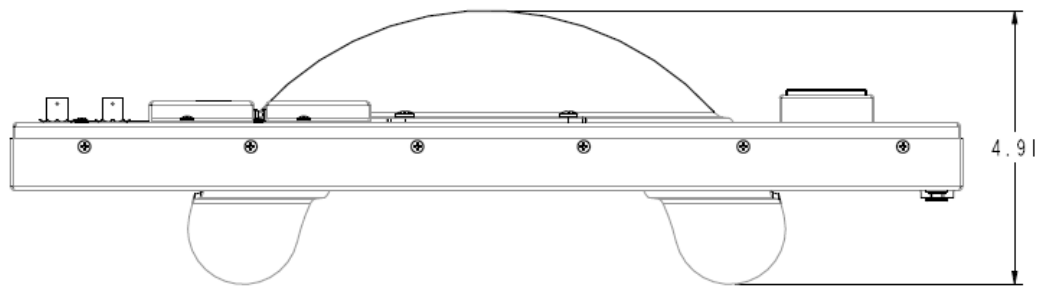
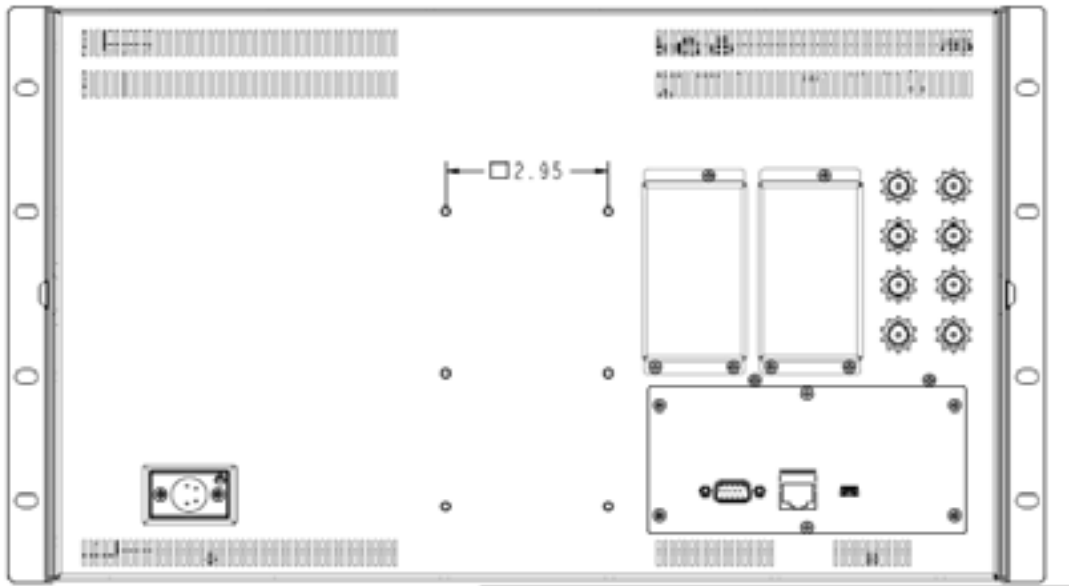

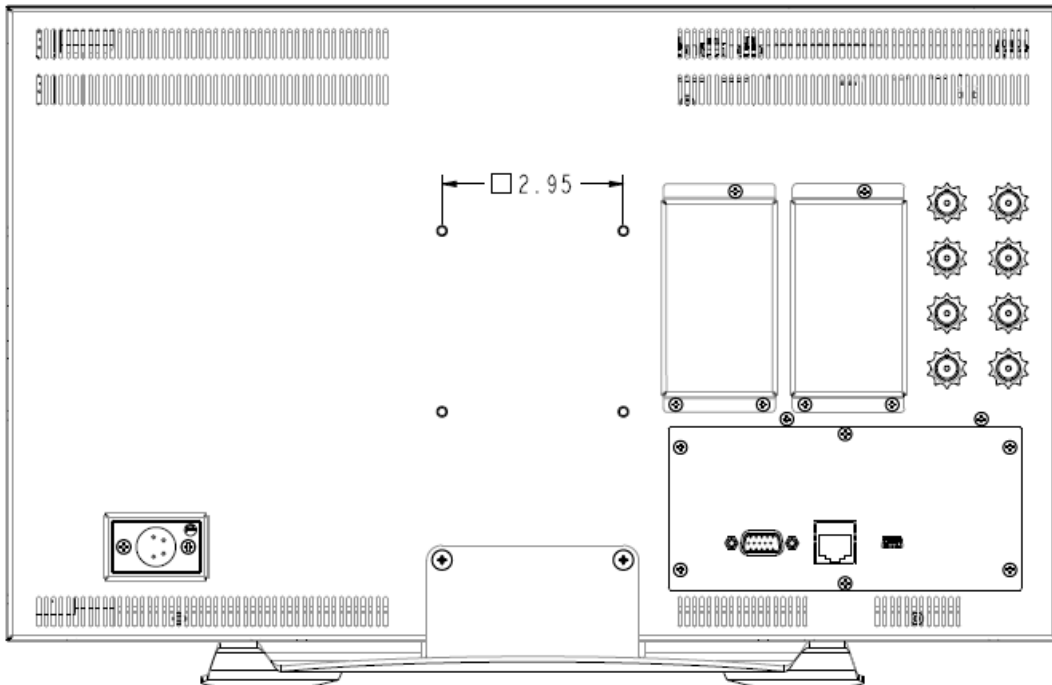
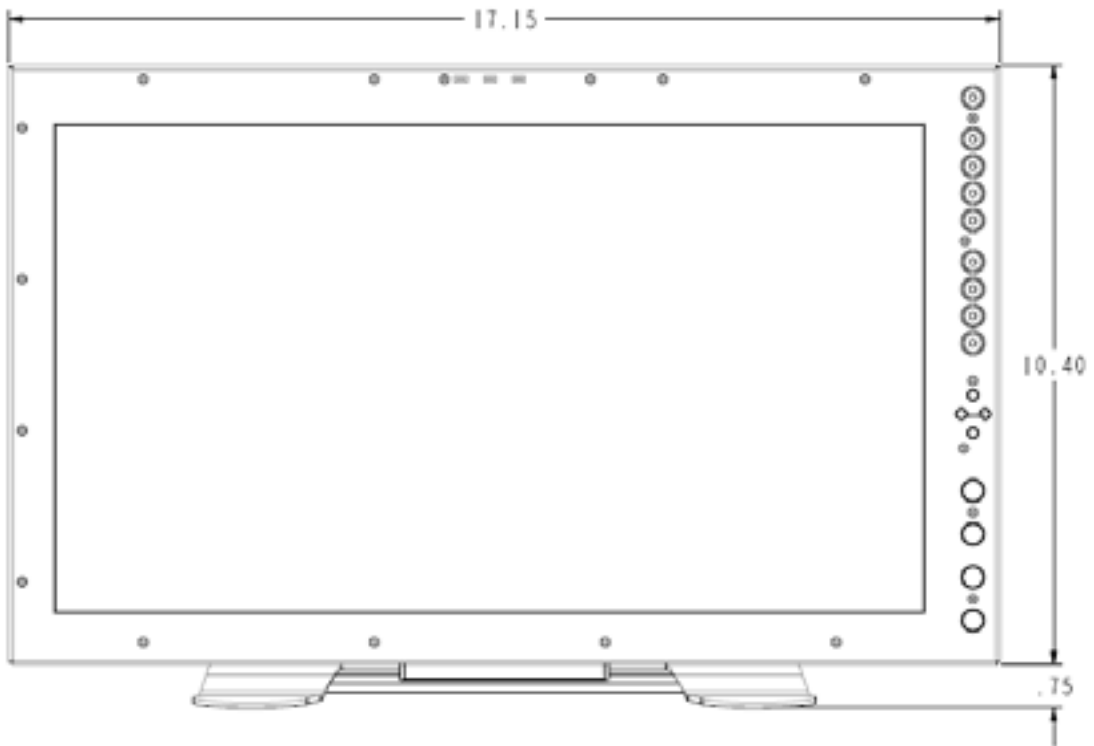

Maintenance

■ Screen Cleaning

Periodically clean the screen surface using ammonia-free cleaning wipes (Marshall Part No. V-HWP-K). A clean micro-fiber cloth can also be used using only non-abrasive and ammonia-free cleaning agents. Do not use paper towels. Paper towel fibers are coarse and may scratch the surface of the polycarbonate faceplate or leave streaks on the surface. Antistatic and fingerprint resistant cleaning agents are recommended. Do not apply excessive pressure to the screen to avoid damaging the LCD.

■ Faceplate Dusting

Dust the unit with a soft, damp cloth or chamois. Dry or abrasive cloths may cause electrostatic charge on the surface, attracting dust particles. Neutralize static electricity effects by using the recommended cleaning and polishing practice.

Warranty

For Warranty information please refer to Marshall website page:

<https://marshall-usa.com/company/warranty.php>