



OWNER'S MANUAL

# LG ProBeam

DLP Projector

---

Please read the safety information carefully before using this product.

BU70QGA (BU70QGA-GL)

# CONTENTS

## PREPARATION

## TRANSPORTING

- 10 Checking before transportation

## INSTALLATION

- 11 Check before Installation  
11 Installation Direction  
11 Ceiling-Type Installation  
12 Projection Distance per Screen Size  
16 Adjusting the Focus and Position of Projection Display  
18 Using Multi-Projection Function  
25 Kensington Security System

## USING REMOTE CONTROL

- 26 Inserting Batteries in the Remote Control  
27 Viewing the Remote Control Features

## MAKING CONNECTIONS

- 31 Connecting to a PC  
31 External Device Connection  
33 Connecting Multiple Projectors

## SAFETY PRECAUTIONS

## CHECKING BEFORE REPORTING MALFUNCTION

- 46 Projector Safety Check  
47 Troubleshooting

## CHECKING INFORMATION

- 49 Specifications  
50 HDMI/HDBaseT Supported mode  
52 Licenses  
52 Open Source Software Notice Information  
53 Other specifications  
54 Symbols

This manual is produced for public use and may contain images or contents different from the product you purchased.

This manual is subject to change depending on the company's circumstances.

# PREPARATION

The pictures may differ slightly from the actual product.

## Accessories

Accessories included with the projector are shown below.

Accessories are subject to change without prior notice.

New accessories may be added or old ones removed.

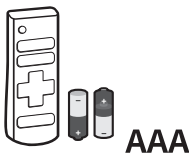

Remote Control  
Two AAA Batteries



Owner's Manual

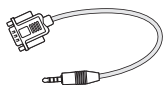

D-Sub To Phone Jack Cable



Power cord

- When connecting an HDMI or USB cable, or connecting a USB flash drive to the HDMI or USB port, use a product that has a width of 18 mm or less and a height of 10 mm or less. If the USB cable or USB flash drive does not fit the USB ports of the projector, use an extension cable that supports USB 2.0.

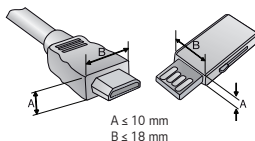

- When connecting two USB devices at the same time, each one should have bezels less than 8.5 mm thick.
- Use a certified cable with the HDMI logo attached.
- If you do not use a certified HDMI cable, the screen may not display or a connection error may occur. (Recommended HDMI cable types)
  - Ultra High Speed HDMI®/™ Cable (3 m or less)

**Optional Extras**

To purchase optional accessories, visit an electronics store or online shopping site or contact the retail store where you purchased the product. Optional accessories are subject to change without prior notice.

## Parts and Components

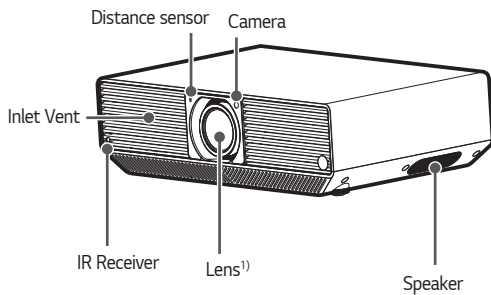

- 1) Do not touch the lens when using the projector. The lens may be damaged. (Keep lens away from sharp objects.)

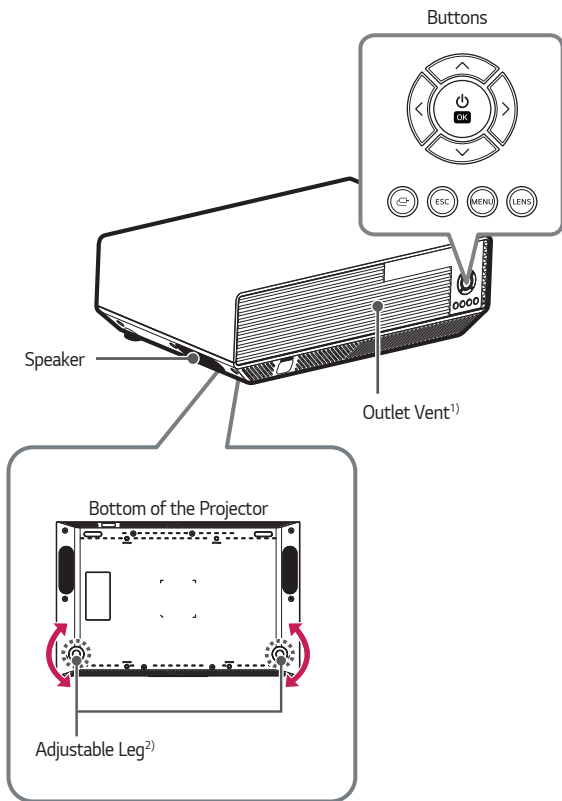

1) Due to the high temperature of vent area, do not get close to the vent area.

2) Turn the adjustable leg left or right to adjust the angle.

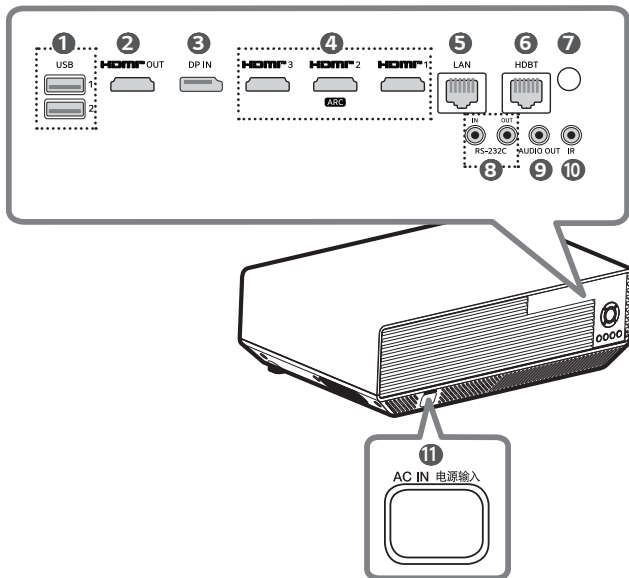

- 1** USB Port
- 2** HDMI OUT Port
- 3** DP IN Port
- 4** HDMI IN Port
- 5** LAN Port
- 6** HDBT (HDBaseT) Port
- 7** IR Receiver
- 8** RS-232C IN / RS-232C OUT Port
- 9** AUDIO OUT Port
- 10** IR (IR IN) Port
- 11** AC IN电源输入 (AC IN Port)

## Using the Button

You can operate the projector by pressing the button or moving the button left, right, up, or down.



- Power On Button: With the projector off, press the Power button once and then release it.
- Power Off Button (Press and Hold): With the projector on, press the Power button for 3 seconds or longer and then release it.



- Up, Down, Left, Right, OK button: You can select and adjust the functions after selecting the menu. (You can move up, down, left, or right to set a function or move the cursor.)



- Input Button: Changes the external input.



- ESC Button: Stops the current function.



- Menu Button: Shows the Settings menu.



- LENS Button: You can set the [Focus]/[Zoom]/[V-Shift]/[H-Shift] functions.
- LENS Button (Press and Hold): Press the **LENS** button for 3 seconds or longer to display the [Auto Screen Adjustment] menu.



## Projector Status Indicators

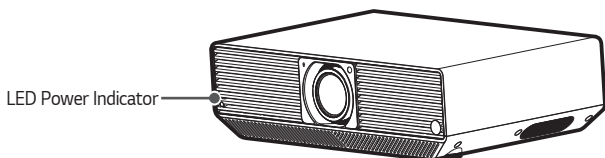

LED Power Indicator	
<b>Red</b>	Power standby state
<b>Off</b>	The projector is operating with the power on.

# TRANSPORTING

## Checking before transportation

We will not be held responsible for the product damage caused by not following the guide.

- 1 Press the **LENS** button on the remote control and the product.
- 2 Repeatedly press the Up/Down buttons on the remote control and the product until the desired Lens movement control screen is displayed.
- 3 You can change the [H-Shift]/[V-Shift] functions. Press the left/right button on the remote control and the product to move the position of the lens to the center/bottom. Transport the projector after moving the position of the lens to the center/bottom.

### CAUTION

- If you transport the projector without moving the position of the lens, the projector may be damaged.

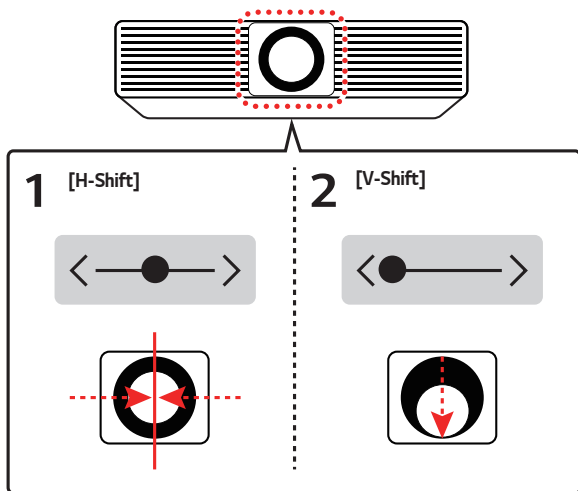

# INSTALLATION

## Check before Installation

We will not be held responsible for the product damage caused by not following the guide.

### CAUTION

- Do not overlap the projectors with each other.

### NOTE

- It is recommended to set the Focus, Zoom, and Lens Shift at least 20 minutes after the projection starts, as the image may not be stable immediately after the projector is turned on.

## Installation Direction

- You can install the projector regardless of the angle. There are no vertical or horizontal limits related to the installation of the projector.
- To install the projector in an inclined position, you may need some exclusive installation mounter.
- Prepare a mounter by consulting an expert.

## Ceiling-Type Installation

### WARNING

**When installing the product on the ceiling, observe the following precautions to prevent the projector from falling:**

- It is recommended to install the product through a professional installation services provider. (If installing on the ceiling, modify the projector's PJT Mode settings)
- Do not use adhesive, lubricant, oil, etc. when using the mounting equipment.
- Do not tighten the screws with an excessive force since the projector may fall due to breakage of the screw connection part.
- Standard screw: M4 x 8 mm, M6 x 10 mm, 1/4-20 UNC x 5 mm (Applicable screw types may vary depending on the model.)
- Recommended torque: 5-8 kgf.cm
- A failure to follow the precautions may result in injury or death and product damage due to the fall of the product.

## Projection Distance per Screen Size

- 1 Place the projector on a sturdy, level surface, together with the PC or audio/video source.
- 2 Place the projector an appropriate distance away from the screen. The distance between the projector and the screen determines the actual size of the image.
- 3 Position the projector so that the lens is at a right angle to the screen. If the projector is not at a right angle, the projected image will look distorted. To correct the distortion, use the Edge Adjustment function.
- 4 Connect the power cord of the projector and the connected device to the wall outlet.

**Ratio of upward projection: 110 %**

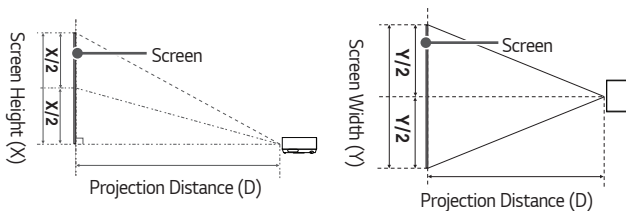

### NOTE

- If the projected image looks distorted or bent, check to see if the screen is installed properly.

16:9 Aspect Ratio (1.6 x Zoom)				
Screen Size		Screen Width (Y)	Screen Height (X)	Projection Distance (D)
inches	mm	mm	mm	mm
40	1016.2	885.7	498.2	1325
60	1525.2	1329.3	747.7	2015
80	2034.2	1773.0	997.3	2705
100	2543.1	2216.5	1246.8	3395
120	3052.3	2660.3	1496.4	4085
140	3557.3	3100.4	1744.0	4775
160	4061.4	3539.8	1991.1	5465
180	4572.2	3985.0	2241.5	6150
200	5079.4	4427.1	2490.2	6845
220	5590.0	4872.4	2740.5	7530
240	6096.9	5313.9	2989.1	8225
260	6601.8	5754.0	3236.6	8910
280	7114.7	6201.0	3488.1	9600
300	7618.7	6640.3	3735.2	10290

The projection distance may vary depending on the installation conditions.

16:9 Aspect Ratio (1.0 x Zoom)				
Screen Size		Screen Width (Y)	Screen Height (X)	Projection Distance (D)
inches	mm	mm	mm	mm
40	1016.2	885.7	498.2	2160
60	1525.2	1329.3	747.7	3260
80	2034.2	1773.0	997.3	4365
100	2543.1	2216.5	1246.8	5470
120	3052.3	2660.3	1496.4	6570
140	3557.3	3100.4	1744.0	7675
160	4061.4	3539.8	1991.1	8780
180	4572.2	3985.0	2241.5	9875
200	5079.4	4427.1	2490.2	10980
220	5590.0	4872.4	2740.5	12075
240	6096.9	5313.9	2989.1	13200
260	6601.8	5754.0	3236.6	14290
280	7114.7	6201.0	3488.1	15400
300	7618.7	6640.3	3735.2	16500

The projection distance may vary depending on the installation conditions.

## Adjusting the Size of Projection Display

- 1** Press the **LENS** button on the remote control and the product.
- 2** Repeatedly press the Up/Down buttons on the remote control and the product until the [Zoom] adjustment screen is displayed.
- 3** Press the Left/Right buttons of the remote control and the product to adjust the size of the projection display.

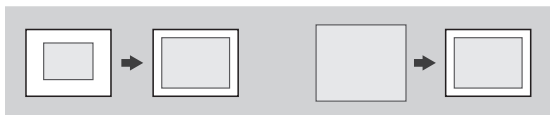

## Adjusting the Focus and Position of Projection Display

Be careful not to shake the product.

Automatically adjusts the Focus, Zoom, Lens, and Keystone of the projection display of the projector.

- **⚙️ (Settings)** → [EZ Setting] → [Installation Wizard] → [Auto Screen Adjustment]
- Press the **LENS** button on the remote control and the product for 5 seconds or longer to execute the [Auto Screen Adjustment].

After the image appears on the screen, check if the focus is correct and if it suits the screen. If the focus and position of the projection display are not automatically adjusted, you can adjust them in detail.

### Adjusting the Focus Details of the Projection Display

- You can change the [Focus] function by pressing the **LENS** button on the remote control and the product.
  - To set the focus of the image, slowly adjust it to the sides while looking at the central upper end of the screen. The point with the right balance between the left and the right is the most suitable focus position.



#### ✓ NOTE

- After using the product at room temperature, turning on the power may blur the focus if the inside temperature is low, but it will recover over time.
- This defocusing is a temporary phenomenon that occurs in low-temperature environments, and this will not affect the product's performance or lifespan.



## Adjusting the Position of Projection Display in detail

Use it when adjusting the position of the projection display without moving the projector up/down/left/right by using the [V-Shift]/[H-Shift].

- 1 Press the **LENS** button on the remote control and the product.
- 2 Repeatedly press the Up/Down buttons on the remote control and the product until the desired Lens movement control screen is displayed.
- 3 You can change the [V-Shift]/[H-Shift] functions. (Control the position of the projection display by pressing the Left/Right buttons on the remote control and the product.)
  - If the projection display is not shown correctly on the screen even after the position of the screen display is adjusted by using the [V-Shift]/[H-Shift] functions, use the [Edge Adjustment] function.

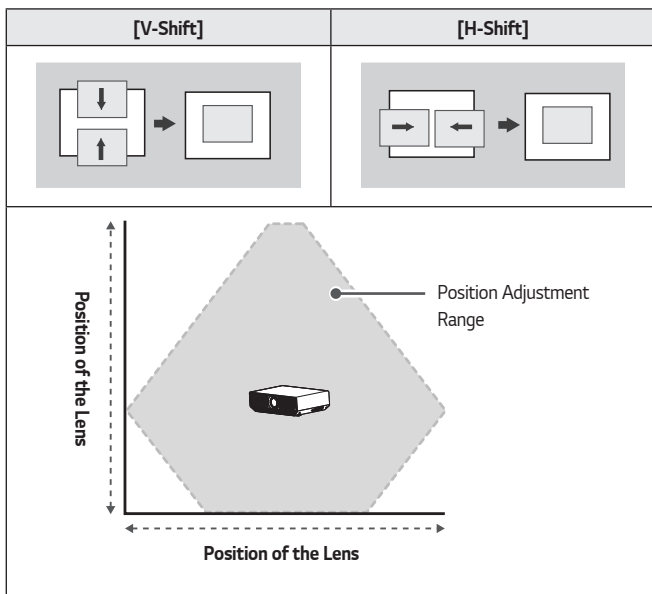

## Using Multi-Projection Function

You can set up to 9 projectors to project a big, broad image.

To make a smooth screen, you can adjust the differences in brightness and colors between projected images.

-  **(Settings)** → [EZ Setting] → [Installation Wizard] → [Edge Blending] → [Video Wall]/[Blending Settings]

## [Edge Blending] – Setting Video Wall

If you make a big single image with multiple projectors, designate a projection position for each projector.

### Video Wall - Setting Tile Mode

- 1 Turn on all projectors.
- 2 Set the [Tile Mode] of [Video Wall] to On.
- 3 Adjust the placement of each projected image.
  - Set the number of projectors by using [Row] and [Column] in [Tile Mode Setting] at [Video Wall].
  - Set the position of the projection image in the row sequence and column sequence.
    - Row Sequence: Place the screen from the upper side to the lower side in the order of 1, 2, and 3.



- Column Sequence: Place the screen from the left side to the right side in the order of 1, 2, and 3.

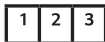

- 4 Repeat the steps on each projector.
- 5 Set the ID of all projectors and the remote control.
- 6 When the ID setting and placement are completed, adjust the position distances and colors of the projected image.

※ There can be up to 9 values of Tile's Row x Column.

## **[Edge Blending] - Setting Blending**

Use the Edge Blending function to naturally overlap several images on the brightness slope of the overlapped area.

### **When performing Edge Blending**

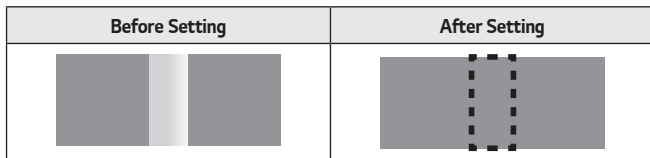

### **Sequence of Adjusting Edge Blending**

- Whole image
  - [Video Wall]: [Tile Mode] On → [Blending Settings]: [Blending Range Settings] → [Blending Mode] On → [Blending Quality Settings]

#### **✓ NOTE**

- When edge blending a divided image
  - [Blending Settings]: [Tile Mode] Off → [Blending Range Settings] → [Blending Mode] On → [Blending Quality Settings]
- If you set the [Tile Mode] of [Video Wall] to Off, the [Clip Range] and [Zoom] of [Blending Range Settings] will be inactivated.

- 1 Set the [Tile Mode] of [Video Wall] to On.
- 2 Set the blending range. ([Blending Range Settings])

1. Set the [Aspect Ratio].

- Select 16:9, the original ratio, before setting the overlap area.
- Position the projector to fit the area you wish to overlap.

2. Set the [Overlapping Range].

Menu	Function
[Menu Position]	Select the position of the Settings menu. (Upper right end, lower right end, upper left end, lower left end)
[Pattern Guide]	Set it to On, and display the Pattern Guide in the Blending Settings range.
[Line Guide]	Set it to On, and display the Line Guide in the Blending Settings range.
[Line Color]	Select the Line Guide color. (Red, Green, Blue)
[Up/Down] or [Left/Right]	Set [Up/Down] or [Left/Right] according to the combining direction, and adjust the edge blending range by adjusting [Up/Down] or [Left/Right].

- Set the Menu Position to not overlap with the shade range.
- Set the Pattern Guide to On.
- Set the Line Guide to On after setting the Line Guide color.
- Set Up/Down or Left/Right to On. (Change Up/Down and Left/Right in accordance with the engaging direction.)
- Adjust the overlapped area minutely.

## 3. Set the [Clip Range].

- Adjust the currently displayed image by adjusting [H]/[V].
- Vertical Expand/Reduce: Vertically expand or reduce the clip-adjusted image.
- Horizontal Expand/Reduce: Horizontally expand or reduce the clip-adjusted image.

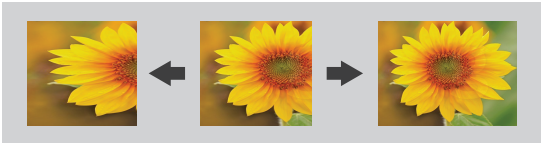
[Clip Range] - [H] Adjustment		
Reduce	Default Value	Expand
		
※ However, when changing the resolution, you need to readjust [Clip Range].		

4. Set the [Zoom] range.

- Adjust the currently displayed image by adjusting [H]/[V].
- Vertical Expand/Reduce: Vertically expand or reduce the image.
- Horizontal Expand/Reduce: Horizontally expand or reduce the image.

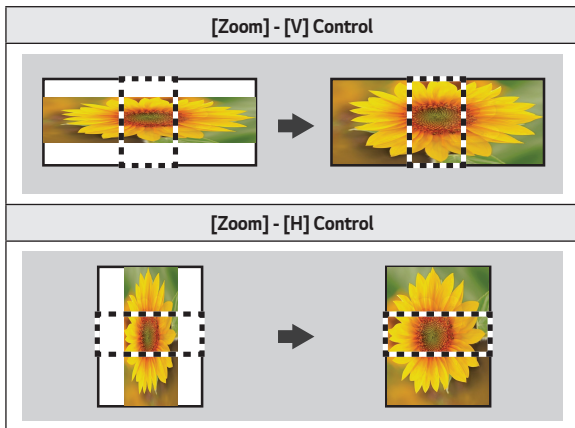

**3** Set the [Blending Mode] of [Blending Settings] to On.

#### 4 Set the blending quality. ([Blending Quality Settings])

- Adjust the [Brightness Level].
  - Adjust the brightness of the projector by adjusting [Brightness Level].
- Adjust the [White Balance].

Menu	Function
[Menu Position]	Select the position of the Settings menu. (Upper right end, lower right end, upper left end, lower left end)
[Picture Mode]	Select the image mode among Shopping Mall/QSR, General, Transportation, Education, Government/Enterprise, and Color Adjustment.
[White Pattern]	Set it to On and display the white pattern. (80IRE, 100IRE)
[Color Temperature]	Adjust the color temperature.
R-Gain, G-Gain, B-Gain	Adjust the colors of red, green, and blue, respectively.

- Set the menu position at the desired position.
- Set the image mode according to the situation.
- Set the white pattern.
- Adjust the color temperature.
- Adjust the R, G, and B gain.

- Adjust the [Color Uniformity].

1	2	3	4	5
6	7	8	9	10
11	12	13	14	15

- Select the desired place among the 15 areas.
- Set the menu position at the desired position.
- Adjust [Red], [Green], and [Blue] to fit [Color Uniformity].

- Adjust the [Black Level].

- Adjust the projector black level of the non-overlapping/overlapping/ border area with the black level adjustment.



## Kensington Security System

- This projector has a Kensington Security Standard connector as an anti-theft mechanism. Connect a Kensington Security System cable as shown below.
- For more information on installation and use of the Kensington Security System, refer to the user's guide provided with the Kensington Security System.
- The Kensington Security System is an optional accessory.
- What is Kensington?

Kensington is a company that provides safety systems for laptops and other electronic devices. Website: <http://www.kensington.com>

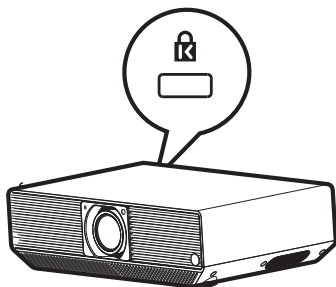

# USING REMOTE CONTROL

## Inserting Batteries in the Remote Control

Use 1.5 V, AAA-type alkaline batteries. Replace the two batteries with new ones and insert them according to the direction indicator inside the remote control.

- 1** Remove the battery cover on the back of the remote control.
- 2** Insert the batteries to match the +, - polarity symbols.
- 3** Close the battery cover.

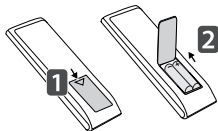

### CAUTION

- Do not mix new batteries with old ones.

## Viewing the Remote Control Features

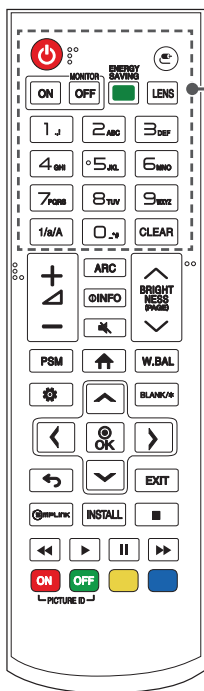

### (Power)

Turns the Projector on or off.



### (Input)

Selects the input mode.

### MONITOR ON

Turns the Projector on.

### MONITOR OFF

Turns the Projector off.

### ENERGY SAVING

Reduces power consumption by adjusting peak screen brightness.

### LENS

You can adjust Focus, Zoom, and Lens Shift.

– Press the **LENS** button for 3 seconds or longer to display the [Auto Screen Adjustment] menu.

### Number and Alphabet buttons

Enters numerical or alphabetical characters depending upon the setting.

### 1/a/A

Toggles between numerical and alphabetical. (This function is not supported.)

### CLEAR

Deletes the entered numerical or alphabetical character.

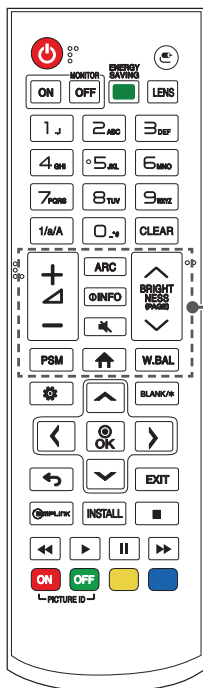

### + ▽ (Volume Button)

Adjusts the volume level.

### ARC (Aspect Ratio)

Selects the screen size.

### ⓘ INFO

Shows information on the current screen.

### 🔇 (Mute)

Mutes all sounds.

### ⤴ BRIGHTNESS ⤵ (Brightness Up/Down)

Adjusts the brightness of the display.

### ⤴ (PAGE) ⤵ (Page Up/Down)

Moves to the previous or next screen.

### PSM (Picture Mode)

Selects the Picture Mode.

### 🏠 (Home menu)

Activates the Launcher.

### W.BAL (White Balance)

Enters the White Balance menu.

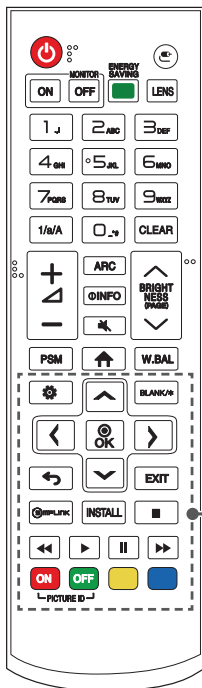

### ⚙️ (Settings)

Accesses the main menus or saves your input and exit menus.

⬆️ ⬇️ ⬅️ ➡️ ⬆️ (Up, Down, Left, Right, OK)

After selecting the menu, select and adjust functions.

### BLANK/\*

Blanks the screen.

### ⬅️ (Back)

Returns to the previous screen.

### EXIT

Exits the menu.

### Ⓜ️ SIMPLINK

Allows you to control various multimedia devices to enjoy multimedia simply by using the remote control through the SIMPLINK menu.

### INSTALL (Installation Wizard)

Accesses the [Installation Wizard].

⏏️ ⏮️ ⏪️ ⏩️ ⏭️ (Control Buttons)

Controls media playback.

### PICTURE ID ON/OFF

When the Picture ID number matches the Set ID number, you can control whichever projector you want in multi-display format.

- **ON**: Individually control the projectors with an image ID assigned to each of them.
- **OFF**: Control the projectors at once.

---

 **NOTE**

- When using the remote control, the optimal operation range is 6 meters or less (left/right) and within a 30 degree arc of the remote control IR receiver.
  - If a cable is connected to the back port, the optimal operating range is 3 meters or less (left/right) and within a 30 degree arc of the remote control IR receiver.
  - For seamless operation, do not block the IR receiver.
  - Some features of the remote control may not be supported in certain models.
  - The product's internal and external batteries should not be exposed to excessive heat such as direct sunlight, fire, or the like.
  - When you carry the remote control in the portable bag, make sure that the buttons on the remote control are not pressed by the projector, cables, documents, or any other accessories in the bag. Otherwise, it may significantly reduce the battery life.
-

# MAKING CONNECTIONS

You can connect various external devices to your projector. Change the input mode and select the external device you want to connect.

For more information about external device connections, see the user manual provided with each device.

## Connecting to a PC

Some of the cables are not provided. This projector supports the Plug and Play\* feature.

\* Plug and Play: a feature that enables a PC to recognize devices attached by the user without device configuration or user intervention when powering up.

## External Device Connection

Connect a HD receiver, DVD, or VCR player to the projector and select an appropriate input mode.

Some of the cables are not provided. For the best picture and sound quality, connecting external devices to your projector using HDMI cables is recommended.

 **NOTE**

- For the best image quality, using the projector with HDMI connection is recommended.
- To comply with the standard specifications of the product, use a shielded interface cable with a ferrite core, such as a DVI-D cable.
- If you turn the projector on when the set is cold, the screen may flicker. This is normal.
- Sometimes red, green, or blue spots may appear on the screen. This is normal.
- Use a High Speed HDMI<sup>®</sup>/TM cable. (3 m or less)
  - 4K 60 Hz/50 Hz: 3 m or less
  - 4K 30 Hz: 10 m or less
  - 1080p: 15 m or less
- Use a certified cable with the HDMI logo attached. If you do not use a certified HDMI cable, the screen may not display or a connection error may occur.
- Recommended HDMI Cable Types
  - High Speed HDMI<sup>®</sup>/TM Cable
  - High Speed HDMI<sup>®</sup>/TM Cable with Ethernet
- If you cannot hear any sound in HDMI mode please check your PC settings. Some PCs require you to manually change the default audio output to HDMI.
- If you want to use HDMI-PC mode, you must set your PC/DTV to PC mode.
- You may experience compatibility issues if you use HDMI-PC mode.
- Make sure the power cable is disconnected.
- If you connect a gaming device to the projector, use the cable provided with the gaming device.



## Connecting Multiple Projectors

- Images may differ according to the model.

To use multiple products, connect an external device to a product and then connect one side of the supported signal input cable to the **OUT** (output) connector of the product, and connect the other side to the **IN** (input) connector of another product to be connected.

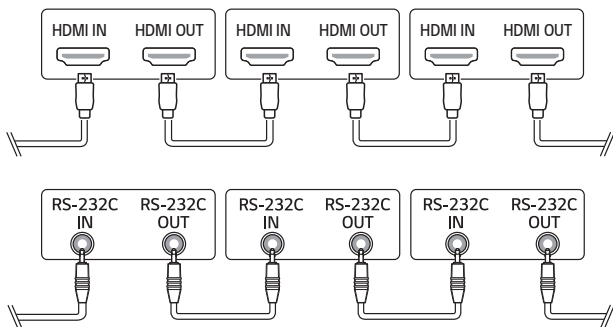

### NOTE

- If the signal cable between the product and your PC is too long, make sure to use the Booster or optical cable.
- Daisy chaining the video output may be limited depending on the performance of the input device that supports HDCP.

# SAFETY PRECAUTIONS

Please take note of the safety instructions to prevent any potential accident or misuse of the projector.

Child injuries can be prevented by following these simple safety precautions.

The precautions should be followed in the same manner when you store or move your existing projector.

- Safety precautions are given in two forms, i.e., **WARNING** and **CAUTION** as detailed below.

 **WARNING:** Failure to follow the instructions may cause serious injury and even death.

 **CAUTION:** Failure to follow the instructions may cause personal injury or product damage.

- Read the owner's manual carefully and keep it on hand.



The lightning flash with arrowhead symbol, within an equilateral triangle, is intended to alert the user to the presence of uninsulated dangerous voltage within the product's enclosure that may be of sufficient magnitude to constitute a risk of electric shock to persons.



The exclamation point within an equilateral triangle is intended to alert the user to the presence of important operating and maintenance (servicing) instructions in the literature accompanying the device.

## **WARNING/CAUTION**

- TO REDUCE THE RISK OF FIRE AND ELECTRIC SHOCK, DO NOT EXPOSE THIS PRODUCT TO RAIN OR MOISTURE.

**Read these instructions. Keep these instructions.**

**Heed all warnings. Follow all instructions.**

## **Indoor Installation**

### **WARNING**

**Do not install products including projectors and remote controls in the following places:**

- Any place exposed to direct sunlight;
  - Any humid place such as bathroom;
  - Any place near hot objects such as flammables and stoves;
  - Any place where oil, oil mist, and steam can reach such as a worktop or places near a humidifier;
  - Any place where water can splash like a vase or the aquarium;
  - Any place that is dusty or exposed to wind and rain;
  - Any place that is under the air conditioner or is directly exposed to the wind from the air conditioner;
  - Any place near flammable materials such as flammable sprays, etc.; or
  - Any cupboard, bookcase shelf or cabinet without a fixture installed and any place where a pet can access.
- It may cause an electric shock, fire, malfunction, deformation or falling.

**Be careful not to drop the projector when connecting an external device.**

- It may cause injury or damage to the product.

**Keep the following precautions in mind to prevent the temperature rise inside the projector:**

- Install the air vents at least 30 cm away from the wall.
- Do not install the product in a place where it cannot be ventilated, such as on a bookcase or in a closet.
- Do not install the product on carpet or cushion.
- Make sure that the air vents are not blocked with tablecloths, curtains, etc.
- It may cause a fire.

**For places where oil or oil mist can reach, do not install the product on a wall or ceiling.**

- The product may be damaged and fall.

**Do not allow a child to hang or climb on the installed projector.**

- The projector may fall and cause injury or death.

 CAUTION

**When moving the projector, be sure to turn off the power switch and disconnect the power plug, antenna cable and the connection cord between the devices.**

- A failure to do so may cause damage to the projector or the cord, resulting in a fire or electric shock.

**Do not install the projector on a shaky shelf, a slanted place, a place subject to vibrations, a place where the projector is not fully supported or on a fabric such as tablecloths.**

- It may cause injury as the projector falls or tips over, or it may cause a malfunction of the projector.

**To prevent damage to the power cord or plug, do not install the projector where the cord can be walked on.**

- It may cause a fire or electric shock.

**When installing the projector, do not install it too close to the wall.**

- The cable connection may be deteriorated or the projector and its cables may be damaged.

**When installing the projector on a cabinet or a shelf, make sure that the front end of the bottom of the projector does not come out.**

- The projector may fall due to the unbalance of the centre of gravity and cause injury to people or a malfunction.

## When in Use



**When thunder or lightning strikes, unplug the power cord and do not touch the antenna wire.**

- It may cause an electric shock.

**If there is a gas leak from the gas lines, do not touch the outlet and be sure to vent by opening the window.**

- Sparks may be caused and lead to a fire or burns.

**When using the product with an external device connected such as a games console, make sure the connection cable is long enough.**

- The product may fall over and cause injury or product damage.

**Do not scratch or give an impact on the projector with metallic materials or objects.**

- It may cause injury to people or damage to the product.

**Do not insert metallic objects including coins, hairpins or a piece of iron or flammable objects such as paper or matches into the projector.**

- It may cause a fire or electric shock.

**When replacing the batteries used for the remote control, be careful not to let children eat them and keep the batteries out of reach of children.**

- If a child swallows the battery, consult a doctor immediately.

**Keep the plastic wrapping of the product out of the reach of children.**

- If a child misuses it, it may suffocate the child.

**Do not touch near the vents during the operation or immediately after the power is turned off as they generate intense heat.**

- The heat does not indicate a defect or a problem of the projector when it is operating so use it with confidence.

**Do not look into the front of the lens when the projector is operating. Strong light is projected from the product which can cause injury to your eyes.**

**Never try to disassemble or modify the projector yourself. Always seek a qualified service technician or consult your dealer or local Service Centre for inspection, adjustment or repairs.**

- It may cause a fire or electric shock.



**Do not use any product that uses high voltage electricity near the projector. (e.g. An electric fly swatter)**

- It may cause a malfunction.

**Do not place any liquid containers such as a vase, pot, cup, cosmetics or medicine, decorations such as candles or any heavy objects on top of the projector.**

- Doing so may cause a fire, electric shock and injury due to failing.

**The surface of the AC adapter is hot, so be careful not to put the surface against your skin or let the children touch the surface during use. (Except for the models that do not use an adapter)**

**Do not hold or move the projector upside down by grabbing only the power cord, signal cable, or projection mirror.**

- Doing so may damage the product or cause an electric shock or fire.

**Even if the projector is turned off with the remote control or the button, the power is not completely cut off if the power cord is plugged in.**

**If you use headphones or earphones, do not use them at high volume or for a long period of time. (It applies only to the models that support headphones (earphones).)**

- Doing so may damage your hearing.

**Do not start the projector when the volume is high.**

- A loud volume can cause hearing loss.

**Do not use or store the projector outdoors for an extended period of time.**

**Do not touch the projector's lens or give an impact on it.**

- It may cause damage to the product.

**Do not block the light from the projector lens with a person, book or other objects.**

- If the light from the projector shines on an object for a long time, it can cause fire due to the heat of such light. Also, the reflected light can heat the lens and cause damage to the projector.



**Do not mix old and new batteries together.**

- It may cause battery rupture or fire due to liquid leakage or may cause electrical shock.

**When replacing the batteries, make sure that they are properly installed according to the polarities (+, -).**

- Battery rupture or leakage may lead to fire, explosion, injury or contamination (damage) of the surrounding area.

**Do not expose the batteries to direct sunlight, fireplace, electric heater, high temperature above 60 °C, excessively humid places or excessive heat.**

- It can cause an explosion or fire.

**Do not throw or disassemble the battery.**

- It can cause a fire and explosion due to battery damage.

**Do not carelessly throw away old batteries.**

- It can cause an explosion or fire. The disposal method may vary by country and region. Dispose of it in an appropriate manner.

**Risk of fire or explosion if the battery is replaced by an incorrect type.**

**Supervise children and to never allow them to stare into the projector beam at any distance from the projector.**

**Use caution when using the remote control for staring the projector while in front of the projection lens.**

**The user to avoid the use of optical aids such as binoculars or telescopes inside the beam.**

**If the ambient temperature rises above 30 °C, the fan may run faster to protect the internal parts of the projector.**

**If the ambient temperature exceeds 35 °C, the light output may be reduced to protect the projector.**

**Do not dispose of this product with general household waste.**

**Disposal of this product must be carried out in accordance to the regulations of your local authority.**

## Power



**Make sure the power plug is securely plugged in to prevent it from shaking.**

- If the connection is unstable, it may cause a fire.

**Do not plug too many devices into one multi-power outlet.**

- This may result in fire due to the power outlet overheating.

**Do not insert a metal object such as chopsticks into the other end of the power plug while it is plugged into a wall outlet. Also, do not touch the power plug immediately after unplugging it from the outlet.**

- It can cause an electric shock.

**Connect the power plug to a grounded outlet or multi-power outlet. (Except for any device without ground connection)**

- A failure to do so may cause an electric shock due to a malfunction or electrical short.

**Never touch the power plug with wet hands.**

- It may cause an electric shock.

**Disconnect the power plug from the outlet when you are not using the projector for a long time or absent.**

- Dust collects and may cause an electric shock and fire caused by a short circuit due to heat, ignition and insulation/degradation.

**The Power Plug is the disconnecting device. In case of an emergency, the Power Plug must remain readily accessible.**

**If any of the following occurs, it could be a malfunction of the product, so you must immediately turn the projector off, unplug the power cord from the outlet, and contact the service centre:**

- When the product is damaged;
  - When the product fails;
  - When there is a foreign substance inside the product; or
  - When the product smokes or smells.
- It may cause a fire or electric shock.

 **CAUTION**

**Do not unplug or plug the power plug from/in the outlet while the power switch is on. (Do not use the power plug as a switch.)**

- It may cause a fire or malfunction.

**When removing the AC adapter or power cord, be sure to hold the plug part.**

- A failure to do so may cause a fire or damage to the product.

**Do not damage the AC adapter, power cord or power plug, place heavy objects on them or give an impact on them.**

- It may cause a fire, electric shock or damage to the product.

**Attach the power cord and AC adapter connected to the projector in a way that they are fully seated.**

- Poor contact can cause a malfunction of the product and fire.

**If there is dust on the pin part of the power plug or the outlet, clean it thoroughly.**

- It may cause a fire.

**Keep the power cord away from heat sources.**

- The coating of the cord may melt and cause a fire or electric shock.

**Use only the authorised power cord or AC adapter supplied by LG Electronics. Do not use any other products.**

- It may cause a malfunction of the product, fire or electric shock.

## Cleaning

### WARNING

**Do not spray water directly onto the projector when cleaning it.**

- It may cause a fire or electric shock.

### CAUTION

#### **How to clean the projector**

- Disconnect the plug from the outlet before cleaning.
- Do not wipe the optical system (the lens and mirror) immediately after the power is turned off.
- Do not spray the water with a sprayer on the product or wipe the product with a damp cloth.
- Wipe the product gently with a soft cloth.
- Do not use any detergents, automotive or industrial polishes, abrasives, waxes, benzenes or alcohols.
- It may cause a fire, electric shock or damage to the projector (deformation, corrosion, and breakage).

#### **How to clean the lens**

- Clean the lens if any dust or smudge appears on the surface of the lens.
- Clean the surface of the lens with an air sprayer or a soft, dry cloth.
- To remove dust or stains on the lens, use a compressed air duster, cotton swab, or soft cloth to gently wipe the lens.
- Never clean the lens when the projector is operating or immediately after the projector is turned off.
- Do not use any detergents, automotive or industrial polishes, abrasives, waxes, benzenes, alcohols, water, etc. on the lens, as they will damage the projector.

**Consult your dealer or the service centre for cleaning the interior of the product once a year.**

- If you do not clean the interior of the projector for a long time while dust collects, it may cause a fire or malfunction.

## Laser

### WARNING

- You risk being exposed to laser radiation if you manipulate or alter the product in a way not specified in the user manual.
- Be sure not to let infants or people with diseases directly watch the light source.

### CAUTION

- This product is a class 1 laser device that meets IEC 60825-1.

#### **Built-in laser standard (class 4 laser module)**

- Blue
  - Wavelength: 449 nm - 461 nm
  - Light output: approx. 156 W

### **Product Laser Class Label**

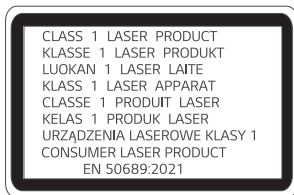

The laser class label of product is attached to the bottom of the product.

# CHECKING BEFORE REPORTING MALFUNCTION

Please check the list below when you experience the following symptoms during use of the product. It may not be a failure.

## Projector Safety Check

### Symptoms

- The projector does not display anything on the screen or output sound when it is turned on.
- The product emits smoke or a burning smell.
- Water or foreign substances are present inside the product.
- Part of the projected image is cut out.
- A strange noise (crackling or sparking sound) regularly occurs from inside the projector.
- The projector still displays the screen or outputs sound when it is turned off.
- There are other errors or failures.

### Causes and Solutions

- For safety, turn off the power switch and remove the plug from the socket.
- Contact the place of purchase or authorised service centre for product inspection.
- Do not attempt to repair the product yourself.

## Troubleshooting

Symptoms	Causes and Solutions
<b>I cannot turn on the Projector.</b>	<ul style="list-style-type: none"> <li>• Please make sure your projector power plug is correctly connected to the outlet.</li> <li>• There may be a problem with the outlet, so try plugging the power cord of another product into the outlet where the projector was plugged in.</li> </ul>
<b>Cannot control the Projector with the remote control.</b>	<ul style="list-style-type: none"> <li>• The remote control may not work properly where a lamp with electronic stabiliser or a three-wavelength lamp is installed.               <ul style="list-style-type: none"> <li>— In this case, replace the lamp with electronic stabiliser or the three-wavelength lamp with international standard products to ensure the remote control works properly.</li> </ul> </li> <li>• Check if there is any obstacle between the product and the remote control.</li> <li>• When replacing the batteries, make sure that they are properly installed according to the polarities (+, -).</li> <li>• Replace both used batteries with new ones.</li> </ul>
<b>The power turns off suddenly.</b>	<ul style="list-style-type: none"> <li>• Check if the Off time is set.</li> <li>• See if the external devices are operating together.</li> <li>• Check if the No Signal Power Off (15 min.) is set. This product is equipped with the No Signal Power Off function which allows the power to be automatically turned off when there is no input signal for 15 minutes.</li> <li>• Check if the No IR Signal Power Off (4 hours) is set.</li> <li>• Check if the DPM (Standby Mode) is set.</li> </ul>

Symptoms	Causes and Solutions
<p><b>I see dots on the screen.</b></p>	<ul style="list-style-type: none"> <li>• There is a coloured dot (bright dots, dark dots, stationary dots, and/or flickering dots) on the screen.               <ul style="list-style-type: none"> <li>– This projector was produced with high precision technology. However, a tiny dark or bright dot may appear on the screen. This is a common occurrence due to the production process, and it does not indicate a functional failure.</li> </ul> </li> <li>※ Bright spot: brightly lit dots, Dark spot: invisible or blurred point of text or objects, Blinking: flashing dots, Bright dot: glowing dots that are brighter than regular images</li> </ul>
<p><b>I hear a noise.</b></p>	<ul style="list-style-type: none"> <li>• <b>Electrical noise:</b> this is a small sound generated from the operation of the high-speed switching circuit that supplies current to the projector, and the noise may vary depending on the product. This noise is normal and does not affect the projector's functions. LG Electronics manages the manufacturing of projectors according to strict standards. A fixed level of noise does not indicate a problem. Please understand that this does not allow you to get an exchange or refund.</li> <li>• <b>Fan sound:</b> to maintain the temperature inside the projector at an appropriate level, the fan sound may increase or decrease depending on the ambient temperature.</li> </ul>



# CHECKING INFORMATION

## Specifications

MODEL	BU70QGA (BU70QGA-GL)	
<b>Resolution (Pixel)</b>	3840 (Horizontal) × 2160 (Vertical) <sup>1)</sup>	
<b>Aspect ratio</b>	16:9 (Horizontal:Vertical)	
<b>Projection distance</b> – <b>Screen size</b>	1325 mm to 10290 mm – 1016.2 mm to 7618.7 mm (40 inches to 300 inches)	
<b>Ratio of upward projection</b>	110 %	
<b>Ratio of downward projection</b>	-60 %	
<b>Power consumption</b>	470 W	
<b>Power</b>	AC 100 - 240 V~, 50/60 Hz, 4.9 A	
<b>Audio Output</b>	5 W + 5 W	
<b>Height</b>	159 mm (without foot), 162.6 mm (with foot)	
<b>Width</b>	570 mm	
<b>Depth</b>	360 mm	
<b>Weight</b>	17.8 kg	
<b>USB Device</b>	5 V, 0.5 A (Max.)	
<b>Environment Condition</b>	<b>Temperature</b>	
	<b>Operation</b>	0 °C to 40 °C
	<b>Storage</b>	-20 °C to 60 °C
	<b>Relative Humidity</b>	
	<b>Operation</b>	0 % to 80 %
	<b>Storage</b>	0 % to 85 %

- Contents in this manual may be changed without prior notice due to upgrade of product functions.

1) 4K UHD resolution with 8.3 million discrete pixels projected by XPR (Extended Pixel Resolution) video processing.

**HDMI/HDBaseT Supported mode****DTV**

<b>Resolution</b>	<b>Horizontal Frequency (kHz)</b>	<b>Vertical Frequency (Hz)</b>
640 x 480	31.46	59.94
640 x 480	31.5	60
720 x 480	31.47	59.94
720 x 480	31.5	60
720 x 576	31.25	50
1280 x 720	44.96	59.94
1280 x 720	45	60
1280 x 720	37.5	50
1920 x 1080i	28.12	50
1920 x 1080i	33.72	59.94
1920 x 1080i	33.75	60
1920 x 1080p	56.25	50
1920 x 1080p	67.43	59.94
1920 x 1080p	67.5	60
3840 x 2160p	61.43	29.97
3840 x 2160p	67.5	30
3840 x 2160p	112.5	50
3840 x 2160p	134.86	59.94
3840 x 2160p	135	60

**PC**

<b>Resolution</b>	<b>Horizontal Frequency (kHz)</b>	<b>Vertical Frequency (Hz)</b>
640 x 350	31.46	70.09
720 x 400	31.46	70.08
640 x 480	31.46	59.94
800 x 600	37.87	60.31
1024 x 768	48.36	60
1280 x 1024	63.98	60.02
1920 x 1080	67.5	60
3840 x 2160	53.95	23.98
3840 x 2160	54	24
3840 x 2160	56.25	25
3840 x 2160	61.43	29.97
3840 x 2160	67.5	30
3840 x 2160	112.5	50
3840 x 2160	134.86	59.94
3840 x 2160	135	60

- If an invalid signal is input into the projector, it will not be displayed properly on the screen or a message such as [No Signal] or [Invalid Format] will be displayed.
- The projector supports the DDC1/2B type as the Plug and Play function (Auto-recognition of PC monitor).
- 3840 x 2160 is recommended as the best picture quality in the PC mode.

## Licenses

Supported licenses may differ by model. For more information about licenses, visit [www.lg.com](http://www.lg.com).



The terms HDMI, HDMI High-Definition Multimedia Interface, HDMI trade dress and the HDMI Logos are trademarks or registered trademarks of HDMI Licensing Administrator, Inc.



HDBaseT™ and the HDBaseT Alliance logo are trademarks of the HDBaseT Alliance.

Manufactured under license from Dolby Laboratories. Dolby, Dolby Vision, Dolby Vision IQ, Dolby Audio, Dolby Atmos, and the double-D symbol are trademarks of Dolby Laboratories Licensing Corporation.



## Open Source Software Notice Information

To obtain the source code that is contained in this product, under GPL, LGPL, MPL, and other open source licenses that have the obligation to disclose source code, and to access all referred license terms, copyright notices and other relevant documents, please visit <https://opensource.lge.com>.

LG Electronics will also provide open source code to you on CD-ROM for a charge covering the cost of performing such distribution (such as the cost of media, shipping, and handling) upon email request to [opensource@lge.com](mailto:opensource@lge.com).

This offer is valid to anyone in receipt of this information for a period of three years after our last shipment of this product.

## Other specifications



As with any bright light source, do not stare into the beam, RG2 IEC 62471-5:2015.

### Risk Group 2

**CAUTION** Possibly hazardous optical radiation emitted from this product. Do not stare at operating lamp. May be harmful to the eye.







This label is attached to the bottom of the product and language may differ.

### [For coin battery application]

 <b>WARNING</b>	
<ul style="list-style-type: none"> <li>• <b>INGESTION HAZARD:</b> This product contains a button cell or coin battery.</li> <li>• <b>DEATH</b> or serious injury can occur if ingested.</li> <li>• A swallowed button cell or coin battery can cause <b>Internal Chemical Burns</b> in as little as <b>2 hours</b>.</li> <li>• <b>KEEP</b> new and used batteries <b>OUT OF REACH of CHILDREN</b></li> <li>• <b>Seek immediate medical attention</b> if a battery is suspected to be swallowed or inserted inside any part of the body.</li> </ul>	

- a) "Remove and immediately recycle or dispose of used batteries according to local regulations and keep away from children.  
Do NOT dispose of batteries in household trash or incinerate."
- b) "Even used batteries may cause severe injury or death."
- c) "Call a local poison control center for treatment information."
- d) The compatible battery type is only CR2032
- e) The nominal battery voltage is 3 V
- f) "Non-rechargeable batteries are not to be recharged."
- g) "Do not force discharge, recharge, disassemble, heat above (manufacturer's specified temperature rating) or incinerate.  
Doing so may result in injury due to venting, leakage or explosion resulting in chemical burns."

## Symbols

	Refers to alternating current (AC).
	Refers to direct current (DC).
	Refers to class II equipment.
	Refers to stand-by.
	Refers to "ON" (power).
	Refers to dangerous voltage.





# ABOUT LG PROJECTOR

---

The images in this user manual are for illustration purposes only and may look different from the real product.

The contents of this user manual may be changed or added without prior notice to improve the quality of the product.

Your projector's OSD (On Screen Display) may differ slightly from that shown in this manual.

[ ]: the buttons and the text to be displayed on the projector screen.

webOS 6.0



# CONTENTS

<b>SETTINGS .....</b>	<b>4</b>		
- Home.....	4	- Display .....	27
Global Buttons		[Picture Mode]	
Dashboard		[Aspect Ratio]	
[Content Manager]		[Rotation]	
- Ez Setting .....	5	[Advanced Setting]	
[Installation Wizard]		- Sound .....	33
[On/Off Scheduler]		[Sound Mode]	
[SI Server Setting]		[Sound Out]	
[Server Setting]		[Audio Out]	
[Fail Over]		[AV Sync Adjustment]	
[Status Mailing]		[Digital Sound Output]	
[Play via URL]		- Admin.....	37
[Setting Data Cloning]		[Lock Mode]	
[Sync Mode]		[Change Password]	
[LG ConnectedCare]		[Enterprise Settings]	
[Multi Screen]		[Factory Reset]	
[Office Meeting Mode]		<b>CONTENT MANAGER .....</b>	<b>40</b>
- General.....	15	- Web Login.....	40
[Language]		- Content Manager .....	40
[System Information]		[Player]	
[Set ID]		[Scheduler]	
[Time & Date]		[Editor]	
[Power]		- Group Manager 2.0 .....	48
[Network]		- Screen Share .....	51
[User Agreement]		How to Use [Screen Share]	
[Audio Guidance]		- LG Presenter.....	52
[Advanced Setting]		How to use LG Presenter	

**MANAGEMENT TOOLS..... 53**

- Control Manager.....53
- Picture ID.....54

**IR CODE ..... 55****CONTROLLING MULTIPLE PRODUCTS..... 57**

- Connecting cables.....57
- Communication Parameter .....58
- Command Reference List.....59
- Transmission/Reception Protocol .....63

**TROUBLESHOOTING..... 81**



- Troubleshooting Power/Remote Issues .....81
- Troubleshooting Screen Issues .....82
- Troubleshooting Sound Issues .....83
- Troubleshooting PC Connection Issues .....84
- Troubleshooting Movie Playback Issues .....85
- Troubleshooting Network Connection Issues 86

- Software-related content may be changed without prior notice due to upgrades of the product functions.
- Some features described in the User Manual may not be supported in certain models and countries.
- SNMP 2.0 is supported.

# SETTINGS

## Home

### Global Buttons

-  [Input]: Navigate to the external input selection screen
-  [Setting]: Navigate to the Settings screen

### Dashboard

- This feature displays key information about your Projector in the center of the home screen. In the Dashboard, you can manually change settings by selecting the corresponding items.

---

#### NOTE

- If the dashboard is locked, the focus does not move.
- 

### [Content Manager]

- [Player]: Play a variety of content including images, videos, and SuperSign content.
- [Scheduler]: Manage schedules for content that will be played at different times.
- [Editor]: You can create your own content using templates and media files.
- [Group Manager 2.0]: Distribute content schedules and setting data to the connected device.

# Ez Setting

## [Installation Wizard]

**SETTINGS / ⚙️** → [Ez Setting] → [Installation Wizard]

- [PJT Mode]: This function turns the projected image upside down or flips horizontal.
- [Edge Adjustment]: [Edge Adjustment] adjusts the horizontal and vertical sides of the projected image if the projector is at an angle and not perpendicular to the screen. This feature ensures the shape of the projected image is not distorted. Use this feature only when the projector cannot be set up at the optimal angle. [Edge Adjustment] may result in a loss of image quality.
  - Some models may not be supported.
  - The configurable items differ depending upon model.
  - [H/V Keystone]: You can adjust the screen in a horizontal/vertical direction.
  - [Smooth Adjustment]: Screen adjustment will be adjusted as a curve. You can select this only in the 9, 15, and 25-point screen adjustments.
  - You can adjust the screen by selecting one out of [4 points]/[9 points]/[15 points]/[25 points].
    - > [4 points]: Screen fit is adjustable using 4 points.
    - > [9 points]: Screen fit is adjustable using 9 points.
    - > [15 points]: Screen fit is adjustable using 15 points.
    - > [25 points]: Screen fit is adjustable using 25 points.
- [Edge Blending]: This setting is for displaying one integrated screen using multiple projectors.
  - Some models may not be supported.
  - [Video Wall]
    - > [Tile Mode]: Turns the [Tile Mode] On/Off.
    - > [Tile Mode Setting]: Sets the Tile mode. (Row/Column/Tile ID)
  - [Blending Settings]
    - > [Blending Mode]: Turns the [Blending Mode] On/Off.
    - > [Blending Range Settings]: Sets the blending range. (Screen Size, Overlapping Range, Clip Range, Zoom)
    - > [Blending Quality Settings]: Sets the blending quality. (Brightness Level, White Balance, Color Uniformity, Black Level)
- [Auto Screen Adjustment]: This function automatically adjusts the focus, zoom, lens, and keystone.
  - Some models may not be supported.
  - If the screen is not installed, it works only within 5 meters of the wall.
  - If the installation angle between the screen and the product exceeds 10 degrees, it may not work properly.
  - If there is an obstacle between the screen and the product, it may not work properly.
  - If the screen is a unique and not normal shape, it may not work properly. (If the screen's border is not black, the screen may not be identified correctly.)
  - When working the [Auto Screen Adjustment] function, if the surrounding environment (brightness, obstacle, etc.) changes, it may not work properly.
  - In an environment so dark that the screen cannot be identified, it may not work properly.
  - [Auto Screen Adjustment] function is a function that automatically helps installation, so each function (zoom, focus, lens shift, screen adjustment) may need to be minutely adjusted after the operation is completed.
  - Please refer to a separate page for the screen size and the standard distance between the screen and the product.

- [High Altitude]: If the projector is used at an altitude higher than 1200 meters, turn this on.
  - Otherwise, the projector may overheat or its protection function may be activated. If this happens, turn the projector off and then on again after waiting for several minutes.
  - Some models may not be supported.
- [Remote Setting]: The power button on the LG TV remote control can be used separately or together with the projector.
  - [Projector + TV]: The power on the projector and TV can be used together. You can turn the projector on and off with the LG TV remote control.
  - [Projector Only]: The power on the projector and TV can be used separately. You cannot turn the projector on and off with the LG TV remote control.
  - Some projector models may not support this feature.
  - Other company's products are not compatible.
- [Blank Mode]: This function temporarily hides the screen.
- [Panel Aspect Ratio]: Select 16:6, 16:9, 16:10, 21:9, 4:3 for the panel screen.
  - Some models may not be supported.

## [On/Off Scheduler]

**SETTINGS / ⚙️** → [Ez Setting] → [On/Off Scheduler]

Set a schedule to use your Projector by time and day of the week.

- [On/Off Time Setting]: Set on/off times for each day of the week.
- [Holiday Setting]: Set holidays by date and by day of the week.

## [SI Server Setting]

**SETTINGS / ⚙️** → [Ez Setting] → [SI Server Setting] → [SI Server Setting]

Set up to connect your Projector to an external SI server. Set up a server environment for SI app installation.

**SETTINGS / ⚙️** → [Ez Setting] → [SI Server Setting] → [Developer Mode & Beanviser]

This feature provides great convenience to the app developers.

Set up to install and activate the Developer mode and Beanviser app.



### NOTE

- To use these features, an account (ID/PASSWORD) for webOS Signage developer website (<http://webosSignage.developer.lge.com/>) is required.
- 

## [Server Setting]

**SETTINGS / ⚙️** → [Ez Setting] → [Server Setting]

Set up to connect your Projector to a SuperSign server.

- CMS Server
- Control Server
- LG Pro:Cloud Server (It may not be supported depending on the model.)

## [Fail Over]

**SETTINGS / ⚙️** → [Ez Setting] → [Fail Over]

Set the priority of the input devices when a fault occurs. Automatically play the content stored in the device or run the set app.

- [On/Off]: Turns [Fail Over] on or off.
- [Input Priority]: Set the priority of input sources for fail over.
- [Play Backup Content]: When there is no input signal, this feature automatically plays the content stored in the device or runs the set app. When set to [On], [Auto Capture Images], [Media Storage], [SuperSign Content], and [SI App/Play via URL] items are activated.
  - [Auto Capture Images]: When the automatic input switches due to taking screenshots of an image or video that is playing at regular intervals, this feature will play back the file.
    - > Capture time Interval: The time interval can be set to 30 min, 1 hour, 2 hours and 3 hours.
  - [Media Storage]: When the automatic input switches due to the image and video file being uploaded, the feature will play back the file.
    - > [Backup media select]: Using the settings button, you can upload a single file in the internal / external memory.
    - > [Preview]: You can preview the uploaded file.
  - [SuperSign Content]: When the automatic input switches, this feature will play the file(s) distributed in SuperSign CMS.
  - [SI App/Play via URL] Run SI App or Play via URL when automatic input switch occurs.
    - > [SI App]: SI App behavior depends on the settings from [SI Server Setting] menu in [Ez Setting].
    - > [Play via URL]: Play via URL behavior depends on the settings from [Play via URL] menu in [Ez Setting].
    - > If both [Play via URL] and [SI Server Setting] can be run, it runs [Play via URL] when automatic input switch occurs.
- [Reset]: Reset to initial settings.

## [Status Mailing]

**SETTINGS / ⚙️** → [Ez Setting] → [Status Mailing]

This feature configures the system so that the status of the device is assessed and then notified to the administrator by e-mail.

- [On/Off]: Turns [Status Mailing] on or off.
- [Mailing Option], [Scheduling]: Sets the email sending interval.
- [User E-mail Address]: Set the user email address of the sender.
- [Sending Server (SMTP)]: Set the address of the SMTP server.
- [ID]: Enter the account ID of the sender.
- [Password]: Enter the password for the sender's account.
- [Receiver E-mail Address]: Set the email address of the recipient.
- [Send message]: Immediately assess the status of the device and deliver the information to the specified email address.
- [Reset]: Reset to initial settings.

### ✓ NOTE

- If the status regarding any of the following items changes or becomes abnormal, a status message can be sent.
  - 1. LAN Status, WiFi Status: An email is sent when the network's connection status is changed. The maximum number of network status changes that can be saved is limited to 50. The saved value is reset once the power turns off.
  - 2. No Signal Check: Checks whether there is a signal. If there are no signals for more than 10 seconds, an email is sent.
  - 3. Schedule Play Status: An email is sent if content cannot be played between the scheduled start time and end time in either Content Management Schedule status or SuperSign Content status. However, this does not apply when terminated using the remote control.
  - 4. Fail Over Status: An email is sent if input switching occurred due to an error. (Excludes input switching initiated by the user (RC, RS232C, SuperSign))
- Only SMTP ports 25, 465, and 587 are supported.
- The occurrence of internal input switches, excluding external input switches (RC, RS232C, SuperSign), are considered as Fail Over Status.
- One email containing the "Failover status: Failover" message is sent when switching to Fail Over Status, and the following status emails sent regularly or upon status changes contain the message "Failover status: None".



## [Play via URL]

**SETTINGS / ⚙️** → [Ez Setting] → [Play via URL]

Play content you want to play automatically through the built-in web browser.

- [URL Loader]: Turns [Play via URL] on or off.
- [Set URL]: Enter the URL address to display automatically.
- [Preview]: Preview your desired website by accessing the specified URL.
- [Save]: Save the specified URL.
- [Reboot to Apply]: Restarts the Projector set after saving the specified URL.
- [Reset]: Reset to initial settings.



### NOTE

- This feature does not apply when [Screen Rotation] is enabled, and using this feature disables [Preview].
- If [Time & Date] is not set to [Set Automatically], website navigation may be difficult.  
- **SETTINGS / ⚙️** → Check [General] → [Time & Date] → [Set Automatically]

## [Setting Data Cloning]

**SETTINGS / ⚙️** → [Ez Setting] → [Settings Data Cloning]

This feature is used to copy and import the settings of the device to other devices.

- [Export Setting Data]: Export the settings of the device to another device.
- [Import Setting Data]: Import the settings of another device into the device.

## [Sync Mode]

**SETTINGS / ⚙️** → [Ez Setting] → [Sync Mode]

Sync up time and content among multiple Projector.

- [RS-232C Sync]: Sync up multiple Projector connected by RS-232C.
- [Network contents sync]: Sync up multiple Projector connected to the same network.

## [LG ConnectedCare]

**SETTINGS** /  → [Ez Setting] → [LG ConnectedCare]

You can install the [LG ConnectedCare] (fault diagnosis) solution for fault diagnosis and prediction service.

- [Install]: Installs the [LG ConnectedCare] solution.
  - 1) [ENTER ACCOUNT NUMBER]: Enters the 6-digit account number to install the [LG ConnectedCare] solution.
    - Account Number: The number assigned when the [LG ConnectedCare] solution is registered. When the account number is entered, the account name corresponding to the number is obtained.
  - 2) [CONFIRM ACCOUNT NUMBER]: Displays the account number and the account name corresponding to the account number and validates the account number.
    - If the account number is registered, the account name corresponding to the account number is displayed, and you can continue to install the [LG ConnectedCare] solution.
    - If the account number is not registered, "Unknown" is displayed as the account name, and you cannot continue to install the solution.
- [Enable]/[Disable]: Sets whether to Enable/Disable the [LG ConnectedCare] solution.
- [Account]: Displays user's currently connected account number and name.
- [Version]: Displays the version of the [LG ConnectedCare] solution.
- [Check for Update]: Checks for available updates in the server.
- [Update]: Updates the [LG ConnectedCare] solution to the latest version.
- [Server Status]: Displays the status of connection between the set and server.
  - [Connected]: Displayed when the set and server are connected.
  - [Not Connected]: Displayed when the set and server are disconnected.
  - [Waiting for Approval]: Displayed when the server is waiting for approval.
  - [Rejected]: Displayed when the server rejected the connection.
- [Reset]: Deletes the installed [LG ConnectedCare] solution.

## [Multi Screen]

SETTINGS / ⚙️ → [Ez Setting] → [Multi Screen]

This feature allows you to view multiple external inputs and videos on a single screen.

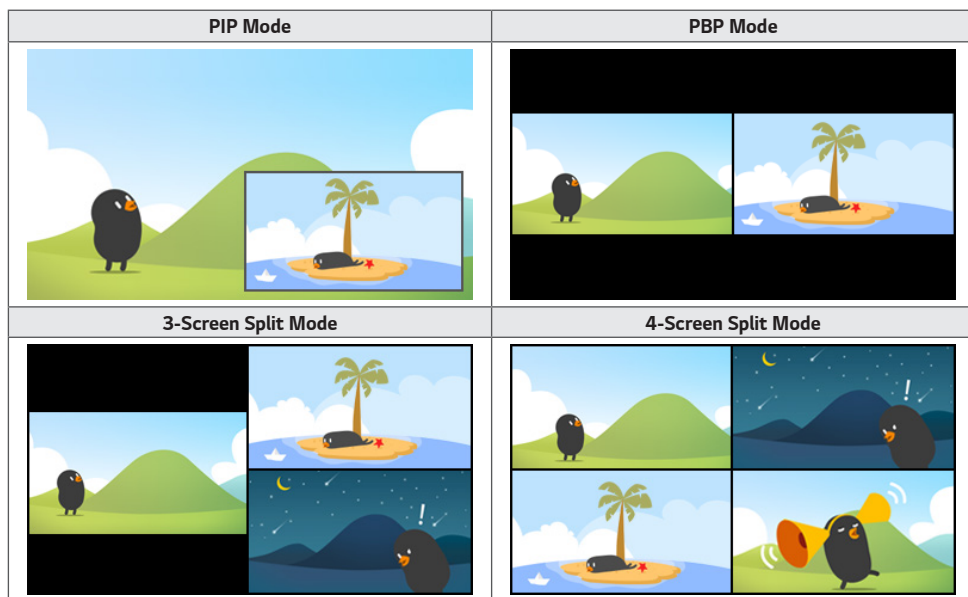

### ✓ NOTE

- In multi-screen mode, the HDMI daisy chain feature is not supported.
- The number of split screens you can have may vary depending on the model.

## Selecting Screen Layout

When you enter multi-screen mode without having set any screen layout, the screen layout selection menu appears. When the screen layout selection menu is not displayed on the screen, go to the screen layout menu bar by pressing the up arrow key on your remote control and select your desired screen layout. If you want to close the screen layout menu, press the back key.

## Closing Screen Layout Menu

From the screen layout menu, press the up arrow key on the remote control to go to the screen layout menu bar and select it or press the back key to close the screen layout menu.

## Changing Screen Input

Press the  button on the top right of each split screen to select the desired input.

### ✓ NOTE

- Inputs which have already been selected for other split screens cannot be selected again. To select them, press the reset button to reset the inputs for all screens first.
- The PIP mode works only when Screen Rotation is set to Off or 180.
- Interlaced formats are not supported. E.g. 1080i
- When setting PIP, PBP, 3-division, and 4-division, the maximum supported resolution is as follows.

PIP	PBP	3-Division	4-Division
3840 x 2160 <sup>1)</sup>	3840 x 2160 <sup>1)</sup>	3840 x 2160 <sup>1)</sup>	1920 x 1080

1) Some models only support up to 30 frames.

- There may be additional restrictions on media depending on the codec combination.

## Playing Videos on Split Screens

Press the  button on the upper right of each split screen, select Video File, and then select a storage device to view the list of videos in the selected device. Next, select your desired video from the list to play it.

### ✓ NOTE

- Videos created with HEVC, MPEG1,2,4, H.264, VP8 or VP9 codecs can be played on split screens. When using PIP mode, the following combinations cannot be used.

Main	Sub
HEVC	HEVC
H.264	HEVC
MPEG2	HEVC
VP9	VP9
H.264 4K	MPEG2
H.264 4K	VP9

- The limitations of 3 and 4-screen split are as below.

<b>When Using 4K</b>	It supports only up to 2 videos. A combination of max. 4K @ 60 fps + 2K @ 60 fps is available. However, H.264 4K supports max. 30 fps.	
	<b>When Using Only 2K</b>	
	60fps	You can combine up to 1 MPEG2, 2 H.264, and 4 other codecs.
	30fps	You can combine up to 2 MPEG2 and 4 other codecs.

- Recommended Framerate: 24, 25, 30, 60 (including 23.9, 24.9, 29.9, 59.9)  
We do not guarantee performance when you play contents with other framerates.

## [Office Meeting Mode]

**SETTINGS / ⚙️** → [Ez Setting] → [Office Meeting Mode]

You can set up Quick Functions to use the product in a conference room.

- [Office Meeting Mode]: Turning on this feature enables you to set functions related to the conference room meeting mode.
- [Meeting Guide Screen]
  - [Meeting Guide Screen]: Turning on this feature will allow you to use the conference information screen. This feature is for displaying a background image when there is no external input. Turning it on will turn on the [No Signal Image] feature.
  - [Meeting Room Name]: When the conference information screen is on, you can change the conference room name displayed on the screen or select whether or not to display the conference room name.
  - [Time]: When the conference information screen is on, you can select whether or not to display the current time on the screen.
- [Advanced Settings]
  - [Picture Mode]: Set the same picture mode for all external input supported by this product.
  - Input Auto Switching: When an external input is inserted, it is automatically converted to the relevant external input. Removing the external input or closing the app switches the input back to the previous status. Features supported by input auto switching are external input, SuperSign content, the SI app, and Play via URL. Turning this feature on switches the [Ez Setting] → [Fail Over] feature off.
    - > [SI App]: The SI app operates according to the settings in the [SI Server Setting] menu in [Ez Setting].
    - > [Play via URL]: Play via URL operates according to the settings in the [Play via URL] menu in [Ez Setting].
  - Auto Power Off: Switch the power off automatically. When this feature is turned on, the [No Signal Power Off (15 Min)] and [No IR Power Off (4hour)] features will be turned on.
  - Edit Input Name: Change the name of each external input.
  - [Presentation Timer]: Use the presentation timer. Turning on this feature will display the [Presentation Timer] on the screen for selecting an external input.
    - > **INPUT / ** → [Presentation Timer]
    - > The time of operation can be set up to 120 minutes in intervals of ten minutes. When the time has been set, press [Start] to begin the timer.
    - > Press the yellow button on the remote control to pause the timer. When the timer is paused, the time is displayed in blue.
    - > Press the yellow button on the remote control to restart the timer.
    - > The time is displayed in red when the remaining time is less than three minutes. The time will blink when the remaining time is less than one minute.
    - > Press the blue button on the remote control to end the timer.
    - > The UI will disappear automatically ten minutes after the timer has ended.
    - > The product may turn off while the timer is still in operation due to the auto-off and power saving settings.

### **NOTE**

- If the No Signal image has been downloaded, turning on [Meeting Guide Screen] will display the downloaded image first when there is no signal.
- If using the [Meeting Room Name] and [Time] items in the [Meeting Guide Screen], and if using the downloaded image as the No Signal image, it is recommended to use a brightly-colored image in accordance with the optimal resolution of the Projector model.

# General

## [Language]

**SETTINGS** / ⚙️ → [General] → [Language]

You can select the menu language to be displayed on the screen.

- [Menu Language]: Sets the language of your Projector.
- [Keyboard Language]: Sets the language of the keyboard displayed on the screen.

## [System Information]

**SETTINGS** / ⚙️ → [General] → [System Information]

This feature displays information such as the device name, software version, and storage space.

## [Set ID]

**SETTINGS** / ⚙️ → [General] → [Set ID]

- [Set ID] (1-1000): Assigns a unique Set ID number to each product when several products are connected via RS-232C. Assign numbers ranging from 1 to 1000 and exit the option. You can control each product separately by using the Set ID you assigned to each product.
- [Auto Set ID]: Automatically assigns a unique Set ID number to each product when several products are connected for display.
- [Reset Set ID]: Reset the Set ID of the product to 1.

## [Time & Date]

**SETTINGS** / ⚙️ → [General] → [Time & Date]

This feature enables you to view and change the time and date on the device.

- [Set Automatically]: Set [Time] and [Date].
- [Daylight Saving Time]: Set the start and end times for Daylight Saving Time. The DST start/end times function only when you set them more than one day apart from each other.
- [Time Zone]: Allows you to change the time zone based on continent, country/region, city or user settings.
- [NTP Server Setting]: Allows you to set other NTP servers other than the basic NTP server.

## [Power]

SETTINGS / ⚙️ → [General] → [Power]

Power-related feature settings

### **[No Signal Power Off (15 Min)]**

Set whether to use the 15 Min Auto Off feature.

- You can set this option to [On] or [Off].
- If you set this feature to [On], the product turns off after it's remained in No Signal status for 15 minutes.
- If you set this feature to [Off], the 15 Min Force Off feature is disabled.
- It is recommended that you set this feature to [Off] if you intend to use the product for long periods of time as the feature turns the power of the product off.

### **[No IR Power Off (4hour)]**

Set whether to use 4 Hours Off feature.

- You can set this option to [On] or [Off].
- If you set this feature to [On] the product turns off if there is no input from the remote control for 4 hours.
- If you set this feature to [Off], the 4 Hours Off feature is disabled.
- It is recommended that you set this feature to [Off] if you intend to use the product for long periods of time as the feature turns the power of the product off.

### **[DPM (Standby Mode)]**

Set the Display Power Management (DPM) mode.

- If this feature is not set to [Off], the Projector will enter DPM mode when there is no input signal.
- If you set this feature to [Off], [DPM (Standby Mode)] is disabled.

### **[DPM (Standby Mode) Wake Up Control]**

Turns on the set according to the digital signal processing of the connected HDMI port.

- Some models may not be supported.
- When set to [Clock], the set only checks for digital clock signals and turns on once it finds the clock signal.
- When set to [Clock+DATA], the set turns on if the digital clock and data signals are both input.

**[PM Mode]**

- [Power Off(Default)]: Set the normal DC off mode.
- [Sustain Aspect Ratio]: The PC retains the Extended Display Identification Data (EDID) even when the power is off.
- [Screen Off]: Switches to [Screen Off] status when entering DPM, Auto Power Off (15 min, 4 hours), or Abnormal Shut Down mode.
- [Screen Off Always]: Switches to [Screen Off] status when entering DPM, Auto Power Off (15 min, 4 hours), Off Time Scheduling, or Abnormal Shut Down mode, or when there is input from the remote control's Power button or the Projector's Off button.
- [Network Ready]: Projector is turned off, but you can control power internally through the network.

**NOTE**

- In order for the screen to switch from [Screen Off] to On status, there must be input from the remote control's **Power** or **Input**, or **MONITOR ON** button.

**[Power On Delay(0-250)]**

- This feature prevents overload by implementing a power-on delay when multiple Projector sets turn on.
- You can set the delay interval in the range of 0 to 250 seconds.

**[Power On Status]**

- Select the operating status of the Projector when the main power has turned on.
- You can choose from among [PWR(Power On)], [STD(Standby)], and [LST(Last Status)].
- [PWR(Power On)] keep the Projector powered on when the main power has turned on.
- [STD(Standby)] switch the Projector to Standby status when the main power has turned on.
- [LST(Last Status)] switches the Projector back to its previous status.

**[Wake On LAN (Networked Standby Mode)]**

- Set whether to use [Wake On LAN (Networked Standby Mode)].
- You can set the feature to On or Off for each wired/wireless network.
- [Wired]: When set to [On], the [Wake On LAN (Networked Standby Mode)] feature is enabled, letting you turn the product on remotely through a wired network.
- [Wireless]: When set to [On], the [Wake On LAN (Networked Standby Mode)] feature is enabled, letting you turn the product on remotely through a wireless network.



**[Power On/Off History]**

Display the device's power on/off history.

**[Quick Start+]**

This setting puts your Projector in standby mode when it's turned off so it will help using Projector's functions quicker when you turn the Projector back on.

- Some models may not be supported.
- Turning this option on may increase energy consumption.

**[Network]**

SETTINGS / ⚙️ → [General] → [Network]

**[Wired Connection (Ethernet)]**

- **Wired Connection:** Connects the Projector to a local area network (LAN) via the LAN port and configures wired network settings. Only wired network connections are supported. After setting up a physical connection, the display will automatically connect without any adjustments on most networks. A small number of networks may require the display settings to be adjusted. For detailed information, contact your Internet provider or consult your router manual.
- **802.1X EAP:** Authentication based on IEEE 802.1X is available for wired connection. Select the desired EAP type and Phase 2 Authentication, enter the ID/Password registered with the authentication server, and press the CONNECT button to attempt the connection.

**[Wi-Fi Connection]**

If you have set your Projector up for a wireless network, you can view and connect to available wireless Internet networks.

- **[Add a Hidden Wireless Network]:** You can add a wireless network by manually typing in its name.
- **[Connect via WPS PBC]:** Press the button on the wireless router that supports PBC to easily connect to the router.
- **[Connect via WPS PIN]:** Enter the PIN number in the web page of the PIN-supporting wireless router to connect to the router in a simple manner.
- **[Advanced Wi-Fi Settings]:** When there is no available wireless network displayed on the screen, you can connect to the wireless network by entering the network information directly.

### **[Certificate Download]**

- Download the certificates used for 802.1X EAP stored in USB.
- Only pem file extension can be downloaded.

---

#### **NOTE**

- On models that support Wi-Fi dongles, the Wireless Network Connection menu is enabled only when a Wi-Fi dongle is connected.
  - When connected to a network that supports IPv6, you can select IPv4 / IPv6 in the wired / wireless network connection. But, IPv6 connection only supports automatic connection.
- 

### **[SoftAP]**

If you set up a SoftAP, you can connect many devices via a Wi-Fi connection without a wireless router and use wireless Internet.

- The SoftAP and Screen Share features cannot be used at the same time.
- On models that support Wi-Fi dongles, the SoftAP menu is enabled only when a Wi-Fi dongle is connected to the product.
- Wi-Fi Channel: You can directly select a Wi-Fi channel.
- SoftAp Access Information
  - SSID: A unique identifier necessary to make a wireless Internet connection
  - Security Key: The security key you enter to connect to the desired wireless network
  - Number of connected devices: Shows the number of devices currently connected to your Projector device via a Wi-Fi connection. Up to 10 devices are supported.

---

**[Ping Test]**

Check your network status with the ping test.

**[Port Control]**

Unused ports can be blocked for network security.

**[Connection Domain]**

Change domain for checking network connection.

---

**✓ NOTE**

- A reboot is recommended for the settings to be applied properly.
-

### Tips for Network Settings

- Use a standard LAN cable (Cat5 or higher with an RJ45 connector) with this display.
- Many network connection problems during set up can often be fixed by re-setting the router or modem. After connecting the display to the home network, quickly power off and/or disconnect the power cable of the home network router or cable modem, Then power on and/or connect the power cable again.
- Depending on the Internet service provider (ISP), the number of devices that can receive INTERNET service may be limited by the applicable terms of service. For details, contact your ISP.
- LG is not responsible for any malfunction of the display or Internet connection failures due to communication errors/malfunctions associated with your Internet connection or other connected equipment.
- LG is not responsible for problems within your INTERNET connection.
- You may experience undesired results if the network connection speed does not meet the requirements of the content being accessed.
- Some INTERNET connection operations may not be possible due to certain restrictions set by the Internet service provider (ISP) supplying your Internet connection.
- Any fees charged by an ISP including, without limitation, connection charges are your responsibility.

### NOTE

- If you want to access the Internet directly on your display, the INTERNET connection should always be on.
- If you cannot access the Internet, check the network conditions from a PC on your network.
- When you use Network Setting, check the LAN cable or check if DHCP in the router is turned on.
- If you do not complete the network settings, the network may not function correctly.

### CAUTION

- Do not connect a modular phone cable to the LAN port.
- Since there are various connection methods, please follow the specifications of your telecommunication carrier or Internet service provider.
- Network setting menu will not be available until the display connected to physical network.

### Tips for When Configuring Wireless Network Settings

- The wireless network may be affected by interference from a device that uses 2.4 GHz frequency, such as a wireless telephone, Bluetooth device or microwave. Interference may also be caused by a device that uses 5 GHz frequency such as Wi-Fi devices.
- The wireless network service may run slowly depending on the surrounding wireless environment.
- Some devices may have a network traffic jam if any local home networks are turned on.
- To connect to a wireless router, a router that supports wireless connection is necessary; the wireless connection function of the corresponding router must also be activated. Ask the router manufacturer whether the router supports wireless connection.
- To connect to a wireless router, verify the SSID and security settings of the wireless router. Please refer to the user guide of the corresponding router regarding SSID and security settings of the wireless router.
- The Projector may not work properly if network devices (wired/wireless router or hub, etc.) are incorrectly set up. Be sure to install the devices correctly by referring to their user guides before configuring the network connection.
- The connection method may vary according to the manufacturer of the wireless router.

### [User Agreement]

**SETTINGS** /  → [General] → [User Agreement]

Check the terms and conditions or change whether to agree or not.

### [Audio Guidance]

**SETTINGS** /  → [General] → [Audio Guidance]

If [Audio Guidance] is set to [On], audio guides will be provided in various situations, such as when you adjust the volume or change settings and input signals.

- [Speed]: Adjust the speed of spoken guide.
- [Volume]: Adjust the volume of spoken guide.
- [Pitch]: Adjust the tone of spoken guide.
- This feature is available on certain languages only.
- Some models may not be supported.
- The configurable items differ depending upon model.
- For visually impaired users.

## [Advanced Setting]

SETTINGS /  → [General] → [Advanced Setting]

### [Beacon]

- This option enables BLE Beacon, one of Bluetooth 4.0's features.
- Beacon Mode (On/Off Toggle): enables the Beacon feature.
- The LG Beacon/iBeacon/Eddystone Type Beacon features are supported.
- iBeacon
  - Beacon UUID (hex): Set the UUID.
    1. Field1: 4byte hex value (8 digits)
    2. Field2: 2byte hex value (4 digits)
    3. Field3: 2byte hex value (4 digits)
    4. Field4: 2byte hex value (4 digits)
    5. Field5: 6byte hex value (12 digits)
  - Major (0-65535): Sets the Major value.
  - Minor (0-65535): Sets the Minor value.
- Eddystone
  - Frame: Set UUID or URL.
- 1. Setting the URL method
  - Beacon UUID (hex): Set the UUID.
    - 1 - Field1: 10byte hex value (20 digits)
    - 2 - Field2: 6byte hex value (12 digits)
- 2. Setting the URL method
  - URL Prefix: Sets the prefix of the URL.
  - URL Suffix: Set the suffix of the URL.
  - URL: Enter the part of the URL that excludes the prefix and suffix.
  - URL string length is limited to 15 characters.
- [Check] button: The button used to complete and apply the Beacon settings.

### NOTE

- Some models do not support background screening services in iOS.
- A reboot is recommended for the settings to be applied properly.
- The UUID value is hexadecimal and the exact number of digits must be entered.
- The distance to Beacon may vary depending on the device.
- The distance to Beacon may vary depending on the application used in the device.
- The Beacon function is affected by radio waves because it employs the Bluetooth Low Energy (BLE) technology. It may not function properly if the frequency range is not around 2.4GHz.
- When you set iBeacon, LG Beacon will be set to be the same as the value of iBeacon field. But the LG Beacon setting item won't be provided separately.

**[Control Interface]**

Devices connected to the display can be controlled via the interface.

- [PC Power Control]: Enable you to control the power of PC as you turn the display on and off.
  - [Disable]: Disable [PC Power Control].
  - [Sync(On)]: Set the PC power to be turned on when the display is turned on.
  - [Sync(On/Off)]: Set the PC power to be turned on when the display is turned on and set the PC power to be turned off when the display is turned off.
- [Control Interface Selection]: Select the serial communication path between the display and the connected devices.
  - Some models may not be supported.
  - [Display]: Serial communication is available via a display RS-232C IN terminal.
  - [HDBaseT]: Serial communication is available with the display via HDBaseT equipment.

**✓ NOTE**

- Depending on the model, it can be displayed as [PC Control].
- Some models may not be supported.
- Depending on the supported interface, the sub-menu of [Control Interface Selection] may be different.
- The PC products that support the power control are MP500/MP700, and you have to purchase them separately if necessary.
- If you change [Control Interface Selection], the [RS232C SYNC] feature of [Sync Mode] may be restricted.
  - Depending on model

**[Background Image]**

This feature enables you to set the default background image.

- [Booting Logo Image]: Change the logo image that appears when the device boots up. If you set this option to Off, no logo image appears when the device boots up. Download or initialize an image file on the storage device.
- [No Signal Image]: Change the image that appears when there is no signal. If you set this option to Off, no image appears when there is no signal. Download or initialize an image file on the storage device.

**✓ NOTE**

- To download an image, an image file must exist in a folder named "LG\_MONITOR" or "lg\_monitor" in the external memory (USB).
- Supported image file formats: "BMP", "JPG"

**[Input Manager]**

You can set the PC or DTV label for each external input.

**[SIMPLINK Setup]**

- When the [SIMPLINK Setup] is set to [On], you can use the SIMPLINK provided by LG Projector.
- [Device ID]: Set the ID of the device connected via CEC wiring. You can choose a value between [All] and [E].
- [StandBy]: Sets the scenarios for sending and receiving the OpStandBy (0x0c) command. Detailed scenarios are as follows:

	Transmission	Reception
All	O	O
Send Only	O	X
Receive Only	X	O

**[Crestron]**

(Depending on model)

**[Crestron Connected] V1**

- This function enables synchronization with applications provided by Crestron.
- [Server]: This menu sets the server's IP address for the network connection with the server (equipment provided by Crestron).
- [Port] (1024~65535): This menu sets the port for the network connection with the server. The default port number is 41794.
- [IP ID] (3-254): This menu sets a unique ID for synchronizing with the application.

**[Crestron Connected] V2**

- The connection status of the server type shall be indicated by pictures and phrases. (Disconnected, Connecting, Connected)
- [Type]: You can select the server type you want to connect to (Off, Control System, Virtual Control, Fusion)
- [CONNECT]: If you press the button once, a set tries to connect to the server and the button phrase is changed into [DISCONNECT]. In this case, the upper items are immutable. To disconnect and change upper items, pressing the button again is needed.
- Information for connecting with the server
  - [Type]: Control System
    - [Server]: Enter the IP information of the server
    - [Port]: Enter the Port information for the server
    - [IP ID]: A unique ID that distinguishes crestron equipment from server
  - [Type]: Virtual Control
    - [Room ID]: A unique ID that distinguishes room from server. If the [IP ID] is the same, but the [Room ID] is different, the server recognises it as a different Crestron equipment.
    - [Server], [Port], [IP ID] are the same as Control System's.



- [Type]: Fusion
- [Method]: Connection direction can be selected. ([Device to Fusion], [Fusion to Device])
- [Device to Fusion]: How to connect from set to server
- [URL]: Server URL
- [Port]: Server Port
- [Fusion to Device]: How to connect from server to set
- [Auto Discovery]: The ability to locate other Crestron equipment in the network
- [SSL]: Communication security with server can be established. The following items are meaningful only at [SSL] on
  - [User], [Password]: When the [Authentication] function is turned on on the server, [User] and [Password] must be entered to connect with the server.
  - [Verify Certificate]: A feature that checks whether a certificate installed on a server is valid. If it is not valid, it does not connect to the server
  - [Certificate Download]: The certificate must be stored in the set to perform the [Verify Certificate] function. Only certificates with extensions .pem, .crt in the USB root directory are recognised and can be added or deleted through the menu. All certificates stored at the time of [Factory Reset] are deleted.

### **[LG promota]**

This feature allows connection of promota app on mobile device.

For more information on how to use it, please visit the promota website (<https://www.promota.net/>).

Autorun promota App function automatically runs promota after booting.

# Display

## [Picture Mode]

SETTINGS / ⚙️ → [Display] → [Picture Mode]

### [Mode]

This feature enables you to choose the optimal picture mode for your installation environment.

- [Mall/QSR], [Transportation], [Education], [Screen Game], [Gov./Corp.]: Display the picture optimally for your installation environment.
- [General]: Display the picture at normal contrast, brightness, and sharpness.
- [Expert], [Calibration]: Allow an expert, or anyone who loves picture quality, to manually tune to the best picture quality.
- [Hospital]: An image setting mode optimised for medical images.



### NOTE

- The type of [Picture Mode] you can select may vary depending on the model or input signal.
- [Expert] is an option that allows a picture quality expert to fine-tune the picture quality using a specific image. Thus, it may not be effective for a normal picture.
- When changing [Picture Mode], the aperture of the lens may move and make a sound, which is a normal operation.
  - Depending on model

### [HDR]

This feature enables you to choose the optimal picture mode for your installation environment.

- [Mall/QSR]: sharpens the image by increasing the contrast, brightness and sharpness.
- [General]: In a normal viewing environment, it opens a screen that can properly show the expressiveness and brightness of HDR.
- [Gov./Corp.]: The screen appears brighter and clearer than of the General screen.
- [Education]: Suitable picture for education.
- [Screen Game]: Suitable picture for screen game.

**[Customize]**

- [Contrast]: Adjust the difference between the light and dark areas of the picture. The closer the value is to 100, the greater the difference is.
- [Brightness]: Adjust the overall brightness of the screen. The closer the value is to 100, the brighter the screen is.
- [Sharpness]: Adjust the sharpness of the edges of objects. The closer the value is to 50, the clearer and the sharper the edge becomes.
- [Color]: Soften or deepen the tints on the screen. The closer the value is to 100, the deeper the colors become.
- [Tint]: Adjust the balance between red and green levels displayed on the screen. The closer to Red 50, the redder the color will be. The closer to Green 50, the greener the color will be.
- [Color Temperature]: The higher you set the color temperature, the cooler the colors on the screen will feel. The lower you set the color temperature, the warmer the colors on the screen will feel.
- [Advanced Controls] / [Expert Controls]: Customize the advanced options.
  - [Dynamic Contrast]: Optimize the difference between the light and dark parts of the screen according to the brightness of the image.
  - [Super Resolution]: Sharpen the areas of the screen that are blurry or barely distinguishable.
  - [Color Gamut]: Select the range of colors available.
  - [Dynamic Color]: Adjust the tint and saturation of the image for a more vivid and lively display.
  - [Gamma]: Adjust gamma settings to compensate for the brightness of the input signal.
  - [White Balance]: Adjust the overall color fidelity of the screen to your liking. In Expert mode, you can fine-tune the picture using the Method/Pattern options.
  - [Color Management System]: Experts use the color management system when they adjust the colors by using the test pattern. The color management system allows you to make an adjustment by selecting from among 6 different color spaces (Red/Yellow/Blue/Cyan/Magenta/Green) without affecting other colors. In a normal picture, you may not notice the color changes you have made.
  - [Dynamic Tone Mapping]: Suitable contrast settings based on image brightness of the HDR content.

- [Picture Option]: Customize the picture options.
  - [Noise Reduction]: Remove randomly popping dots to make the picture look clearer.
  - [MPEG Noise Reduction]: Reduce the noise generated in the process of creating a digital video signal.
  - [Smooth Gradation]: Reduces step-shaped irregularities in the image edges, resulting in a smooth display.
  - [Black Level]: Adjust the brightness and contrast of the screen by adjusting the black level of the screen.  
(Recommended settings based on input signals: RGB 0 - 255: High, RGB 16 - 235: Low, YCbCr: Low)
  - [Real Cinema]: Optimise the video image for a cinematic look.
  - [TruMotion]: Reduce image shaking and image sticking that can occur with /moving images. (If you set the [External Input Rotation], this feature is unavailable.)
- [Apply to all inputs]: Copies the current value of the detailed setting menu to the entire input, and applies only to the selected picture mode.
- [Reset]: Reset the picture settings. Because the picture settings are reset according to the Projector's picture mode, please select the picture mode before resetting the picture settings.

## **[Aspect Ratio]**

**SETTINGS / ⚙️** → [Display] → [Aspect Ratio]

This feature enables you to change the picture size to view the picture at its optimal resolution.

- [Full]: Stretch the picture to fill the screen.
- [Original]: Display the picture at its original resolution.

## **[Rotation]**

**SETTINGS / ⚙️** → [Display] → [Rotation]

### **[Screen Rotation]**

- This feature rotates the screen clockwise.
- You can set this feature to Off/90/180/270.
- When set to off, this feature is deactivated.
- It is recommended that you use content designed to be used in Portrait mode.
- When the screen rotation is enabled, the PIP mode of the multi-screen is unavailable.

### **[External Input Rotation]**

- This feature rotates the screen clockwise.
- You can set this feature to Off/90/180/270.
- Setting External Input Rotation to On (90 or 270) resizes the video to be [Full Wide] for the ARC.
- If [External Input Rotation] is enabled during WiDi operation, the position of the mouse cursor may not be displayed accurately.
- Please note that the degradation of picture quality that occurs when you have enabled [External Input Rotation] during the use of external input has nothing to do with the product itself.

## [Advanced Setting]

SETTINGS / ⚙️ → [Display] → [Advanced Setting]

### [UHD Deep Color]

If you connect an HDMI or DP device to one of the Deep Color adjustable ports, you can select between UHD Deep Color On (6G) or Off (3G) in the UHD Deep Color settings menu.

If a compatibility issue occurs with a graphics card when the Deep Color option is set to On at 3840 x 2160 @ 60 Hz, set the Deep Color option back to Off.

- HDMI, and DP specifications may vary depending on the input port. Check the specifications of each device before connecting.
- HDMI input port 1, 2 is best suited for high definition videos that are 4K@60 Hz (4:4:4, 4:2:2). However, video or audio may not be supported depending on the specifications of the external device. If this is the case, please connect the device to a different HDMI port.
- This feature may not be available on some models.

### [Average Picture Level Auto Control]

Can use image quality control based on APL (Average Picture Level) of the Projector input image.

When using the Projector as a Video Wall, it is recommended to set this function off to prevent an image quality difference between the Projectors. (Depending on model)



#### NOTE

- Return to default settings by clicking [Admin] > [Factory Reset].

**[Energy Saving]**

- [Brightness Control]: Adjust the brightness of the screen to save energy.
  - Minimum/Medium/Maximum: Use energy saving according to the energy saving level set for the Projector.

**✓ NOTE**

- Return to default settings by clicking [Admin] > [Factory Reset].

**[HDMI IT Content]**

Set the HDMI IT Contents function.

- [Off]: Disable the HDMI IT Contents function.
- [On]: Enable the HDMI IT Contents function.

This feature automatically changes the Projector's picture mode based on HDMI Contents information when an HDMI signal is entered.

Even if the Projector's picture mode has been changed by the HDMI IT Contents feature, you can change the picture mode again manually.

As this has a higher priority than the picture mode set by the user, the existing picture mode may be changed when the HDMI signal changes.

# Sound

## [Sound Mode]

SETTINGS /  → [Sound] → [Sound Mode]

### [Sound Mode]

The best sound quality will be selected automatically depending on the video type currently being watched.

- [Standard]: This sound mode works well for content of all types.
- [Cinema]: Optimise sound for watching movies.
- [Clear Voice III]: Enhance voices so they can be heard more clearly.
- [Sports]: Optimise sound for watching sports.
- [Music]: Optimise sound for listening to music.
- [Game]: Optimise sound for playing video games.

### [Balance]

- [Balance]: Adjust the output volume for the left speaker and the right speaker.

### [Equalizer]

- [Equalizer]: Manually adjust sound by using the equalizer.

### [Reset]

- [Reset]: Resets sound settings.



**[Sound Out]****SETTINGS / ⚙️ → [Sound] → [Sound Out]**

- [Main Speaker]: You can output audio either through your Projector's internal speaker or through an external speaker connected to it.
  - [Use Speaker Sound]: Enables you to turn the speaker on and off. If you are using an external audio device, turning off this feature allows you to play sound through the external audio device only.
- [HDMI ARC]: Enables the sound of the Projector to be output through an external audio device connected to the HDMI (ARC) terminal. This option is activated when SIMPLINK has been set to On.
- [LG Sound Sync / Bluetooth]: Enables you to connect Bluetooth audio devices or Bluetooth headsets wirelessly to Projector so that you can enjoy richer audio conveniently.

**✔ NOTE**

- Some recently connected devices may automatically attempt to reconnect to the Projector when it is turned on.
- It is recommended that you set LG audio devices that support LG Sound Sync to LG TV mode or LG Sound Sync mode before connecting.
- Press Device Selection to view the devices that are or that can be connected and connect other devices.
- You can use the Projector remote control to adjust the volume of the connected device.
- If the audio device fails to connect, check that it is switched on and available for connection.
- Depending on the type of the Bluetooth device, the device may not connect correctly or an abnormal behavior may occur such as unsynchronized video and audio.
- Sound may stutter or sound quality may be reduced if:
  - The Bluetooth device is too far from the Projector.
  - There is an obstructing object between the Bluetooth device and the Projector.
  - The Bluetooth device is used together with radio equipment such as a microwave oven or wireless LAN.

## [Audio Out]

**SETTINGS / ⚙️** → [Sound] → [Audio Out]

- [Off]: Disables the use of [Audio Out]. (No audio outputted.)
- [Variable]: You can specify an output range for the external audio device connected to the Projector and adjust the volume within the range. You can change the volume of an external audio device within the range of 0 to 100 (the same as the Projector speaker volume). However, there may be a difference in the actual volume level outputted.
- [Fixed]: Sets a fixed audio output level for the external audio device.
  - If there is no external input, no external audio is outputted.
  - The variable audio output level 100 is the same as the fixed audio output level.

## [AV Sync Adjustment]

**SETTINGS / ⚙️** → [Sound] → [AV Sync Adjustment]

This feature adjusts audio timing to synchronize video and audio.

- [AV Sync Adjustment]: You can set AV Sync Adjustment feature to [On/Off].
- [Main Speaker] (0-60): Adjust the sync of sound from the main speakers. The larger the number is, the slower the voice output is than the default value.
- [Bypass]: Output the broadcast signals or the sound from external devices without any audio delay. Audio may be outputted earlier than video due to the processing time for video that is inputted into the Projector.
- [HDMI ARC] (0-60): Adjust the sync of sound from the HDMI ARC. The larger the number is, the slower the voice output is than the default value.

## [Digital Sound Output]

**SETTINGS / ⚙️** → [Sound] → [Digital Sound Output]

Enables you to configure the settings for Export Digital Sound.

- **SETTINGS / ⚙️** → [Sound] → This can be set if [Sound Out] is optical digital/HDMI ARC.
- Sound effect output may not work if using Pass Through.
- The codec which is being output to the device may differ from the codec of the input signal.

	Audio Input	Digital Sound Output
<b>Auto/Pass Through</b>	Dolby Digital Plus	Dolby Digital
	Dolby Digital	Dolby Digital
	AAC (Media)	Dolby Digital
	AAC	Dolby Digital
	HE-AAC	Dolby Digital
	MPEG	PCM
<b>PCM</b>	All	PCM

# Admin

## [Lock Mode]

SETTINGS / ⚙️ → [Admin] → [Lock Mode]

## [Home Dashboard Lock]

When you set the Home Dashboard Lock, you can limit the change in the settings of the Home Dashboard.

## [USB Lock]

This feature enables you to configure the USB lock feature so that settings or content cannot be changed.

## [OSD Lock]

This feature enables you to configure the OSD lock feature so that settings or content cannot be changed.

- Press and hold the Settings key for at least 10 seconds and enter password to access the settings menu in OSD Lock.

## [IR Operation Lock]

- If you set this feature to [Off (Normal)], you can use your remote control.
- If you set this feature to [On (Power Key Only)], you can only use the power key.
- If you set this feature to [On (Block All)], you cannot use your remote control. (However, Power On feature is available.)
- Press and hold the Settings key for at least 10 seconds and enter password to access the settings menu in IR Operation Lock.

## [Local Key Operation Lock]

This feature enables you to configure the Local Key Operation Lock feature so that settings or content cannot be changed.

- If you set this feature to [Off (Normal)], you can use the local keys on the Projector.
- If you set this feature to [On (Power Key Only)], you can only use the power key. (When you use a joystick, press and hold a local key to turn on/off the Projector.)
- If you set this feature to [On (Block All)], you cannot use the local keys. (However, Power On feature is available.)

**[Wi-Fi Lock]**

This feature enables you to turn the Wi-Fi feature on or off.

**[Screen Share Lock]**

- [On]: This feature enables you to turn the Screen Share feature off.
  - [Off]: This feature enables you to turn the Screen Share feature on.
  - [Off (PIN)]: This feature enables you to use the Screen Share feature using PIN number.
- If the Screen Share Lock value is changed, the function is not applied without a reboot.

**[Change Password]**

This feature enables you to set the password you use to enter the Installation menu. (The default password: 000000)

- 1 Enter your current password.
- 2 Enter a new 6-digit password.
- 3 Enter the same password again in the Confirm Password field for confirmation.

**[Enterprise Settings]**

- Enter your company account code to apply the corresponding enterprise settings.
- When your code has been entered, the Projector set gets reset, thereby applying the corresponding enterprise settings.
- This feature does not get activated if a code has already been entered.

## [Factory Reset]

Initializes all settings in [Setting] and files from the internal storage.

The exceptions are RGB gain value of [Calibration] mode, [Installation Wizard] ([Video Wall] > [Tile Mode], [Tile Mode Setting]) and [Server Setting] items of [Ez Setting], and [Set ID] items of [General]. (Depending on model)

---

### ✓ NOTE

- It keeps the existing settings because the Off / On button in the User menu only affects the active / inactive status of the submenu.
  - [Focus], [Zoom], [H-Shift], and [V-Shift] items that can be adjusted by the **LENS** button on the remote control and the product are exception items to the [Factory Reset], and their existing settings will be maintained.
    - Some models may not be supported.
-

# CONTENT MANAGER

## Web Login

- Different features are supported depending on the product. This Projector product comes with a feature that enables you to access it on your PC or mobile device.
- Content Manager, Group Manager 2.0, Control Manager, Log Out, Change Password menus are provided.
- URL: *https://set*, IP:3777
- The default password: (Serial Number) + LGGe12\*  
E.g. If the serial number is ABCD123456789, enter ABCD123456789LGGe12\* as the password.
- The serial number can be found on the tag attached to the product or on the **SETTINGS / ⚙️** → [General] → [System Information] menu.



### CAUTION

- Supported resolutions (this program is optimised for the following resolutions):
  - PC: 1920 x 1080 / 1280 x 1024
  - Mobile: 360 x 640 (1440 x 2560, 1080 x 1920), DPR
- Supported browsers (this program is optimised for the following browsers):
  - Chrome 56 or later (recommended)

## Content Manager

### [Player]

HOME / ↑ →  (Player)

The Content Manager app's player feature enables you to play/manage contents of video, image, template, SuperSign and playlist in an integrated way.

### [Continuous Play]

- 1 Select your desired type of content from the tab on the left and then select your desired content.
- 2 Click [Play] in the upper right-hand corner of the screen and enjoy the content you have selected.

### [Export]

- 1 Select your desired type of content from the tab on the left and click [Export] in the upper right-hand corner of the screen.
- 2 Select the content you wish to export.
- 3 Click [Copy]/[Move] in the upper right-hand corner of the screen and select the device to which you wish to export the content. (If a content file stored on the target device has been selected, the processing of the content file is skipped.)
- 4 You can see that the content has been moved/copied to the device.

### **[Delete]**

- 1 Select your desired type of content from the tab on the left and click [Delete] in the upper right-hand corner of the screen.
- 2 Select the content you wish to delete.
- 3 Click [Delete] in the upper right-hand corner of the screen.
- 4 You can see that the content has been deleted.

### **[Filter/Sort]**

- 1 Click [Filter/Sort] in the upper right-hand corner of the screen.
- 2 1) Choose your desired sort criterion to sort content files either by file name or in the order they have been played (the most recently played file shown at the top of the list).  
2) It is possible to only view the content stored on your desired device by filtering content files by device.  
3) It is possible to only view the content of your desired type by filtering content files by content type.

### **[Create Playlist]**

When creating a playlist, you cannot include characters that cannot be used in file names on Windows — such as \, /, ;, \*, ?, " , <, >, and | — in the names of the files in the playlist. In addition, if the playlist contains content files whose names include such characters, you cannot move or copy the playlist.

- 1 Select the [Playlist] tap from the tab on the left and click [Create Playlist] in the upper right-hand of the screen.
- 2 Select the content you wish to add to the playlist and click [NEXT] in the upper right-hand of the screen.
- 3 Set a play time for each piece of content (applicable only for photo and template content), as well as other items such as Conversion Effect, Ratio, and Auto Playback, and then click [DONE] button in the upper right-hand corner of the screen.
- 4 You can see a new [Playlist] has been created.

### **[Distribution]**

- 1 Click [Distribute] in the upper right-hand corner of the screen.
- 2 Go to the Group Manager app to distribute the created playlists.



#### **NOTE**

- The Distribute button shows only when playlist is selected as media type.



**[Scheduler]**

HOME /  →  (Scheduler)

The Content Manager app's scheduler feature enables certain content to be played at a scheduled time through a playlist or external input.

**[Creating a Schedule]**

- 1 Click [New Schedule] in the upper right-hand corner of the screen.
- 2 Choose between [Playlist] and [Input Source].
- 3 1) If you have selected [Playlist], select the playlist you wish to schedule the playback of.  
2) If you have selected [Input Source], select the external input source you wish to schedule the playback of.
- 4 Enter schedule information and create a new schedule. (When creating a schedule, you cannot include characters that cannot be used in file names on Windows — such as \, /, ;, \*, ?, " , <, >, and | — in the name of the schedule file. In addition, if the playlist linked to the schedule contains content files whose names include such characters, you cannot move or copy the playlist.)
- 5 Watch the playlist or external input you selected play back at its scheduled time.

**[Importing a Schedule]**

- 1 Click [Import] in the upper right-hand corner of the screen.
- 2 Select the external storage device from which you wish to import a schedule.
- 3 Select the schedule you wish to import to your Projector. (You can only choose a single schedule.)
- 4 Click [Select] in the upper right-hand corner of the screen.
- 5 Check that the schedule has been imported to the Projector's internal storage memory.

**[Exporting a Schedule]**

- 1 Click [Export] in the upper right-hand corner of the screen.
- 2 Select the external storage device to which you wish to export a schedule.
- 3 Select the schedule you wish to export from your Projector. (You can choose multiple schedules.)
- 4 Click [Select] in the upper right-hand corner of the screen.
- 5 Check that the schedule has been exported to the external storage device you selected.

**[Delete Schedule]**

- 1 Click [DELETE] in the upper right-hand corner of the screen.
- 2 Select the schedules you wish to delete.
- 3 Click [DELETE].
- 4 Check that the schedules have been deleted.

**[Calendar View]**

- 1 When you have registered schedules, click [Calendar View].
- 2 You can see that the schedules registered are displayed in the form of a timetable.

**[Distribute]**

- 1 Click [Distribute] in the upper right-hand corner of the screen.
- 2 Go to the Group Manager app to distribute the created schedules.

**✓ NOTE**

- If the schedule creation time overlaps, the previously created schedule is deleted.
- When a schedule that has not been set repeatedly is completed, the schedule is automatically deleted.
- Schedule does not work while Scheduling list app is running.

**[Editor]**

**HOME /**    (Editor)

The Content Manager app's editor feature enables you to add your desired templates.

- 1 Select the template of your desired format. (You can choose between Landscape mode and Portrait mode.)
- 2 Modify the template's text.
  - 2-1. Apply your desired font style (Size, Weight, Underline, Italic)
- 3 Modify the media file.
  - 3-1. Select and apply the rate you want.
- 4 Save the template by clicking [Save] in the top right-hand corner of the screen.
- 5 Check that the template you saved is shown in the template list.

## Supported Photo & Video Files

### ✓ NOTE

- Subtitles are not supported.

### Supported video codecs

Extension	Codec	
.asf, .wmv	Video	VC-1 Advanced Profile (except for WMVA), VC-1 Simple and Main Profiles
	Audio	WMA Standard (excluding WMA v1/WMA Speech)
.avi	Video	Xvid (except for GMC), H.264/AVC, Motion Jpeg, MPEG-4
	Audio	MPEG-1 Layer I, II, MPEG-1 Layer III (MP3), Dolby Digital, LPCM, ADPCM
.mp4, .m4v, .mov	Video	H.264/AVC, MPEG-4, HEVC
	Audio	Dolby Digital, Dolby Digital Plus, AAC, MPEG-1 Layer III (MP3), Dolby AC-4
.3gp, .3g2	Video	H.264/AVC, MPEG-4
	Audio	AAC, AMR-NB, AMR-WB
.mkv	Video	MPEG-2, MPEG-4, H.264/AVC, VP8, VP9, HEVC
	Audio	Dolby Digital, Dolby Digital Plus, AAC, PCM, MPEG-1 Layer I, II, MPEG-1 Layer III (MP3)
.ts, .trp, .tp, .mts	Video	H.264/AVC, MPEG-2, HEVC
	Audio	MPEG-1 Layer I, II, MPEG-1 Layer III (MP3), Dolby Digital, Dolby Digital Plus, AAC, PCM, Dolby AC-4
.mpg, .mpeg, .dat	Video	MPEG-1, MPEG-2
	Audio	MPEG-1 Layer I, II, MPEG-1 Layer III (MP3)
.vob	Video	MPEG-1, MPEG-2
	Audio	Dolby Digital, MPEG-1 Layer I, II, DVD-LPCM

- Dolby AC-4: Some models may not be supported.

Maximum transmit ratio	
Full HD movie	H.264 1920 x 1080@60P BP/MP/HP@L4.2 40Mbps HEVC 1920 x 1080@60P Main/Main10@L4.1 40Mbps
ULTRA HD movie (UHD models only.)	H.264 3840 x 2160@30P BP/MP/HP@L5.1 50Mbps HEVC 3840 x 2160@60P Main/Main10@L5.1 60Mbps

### Supported Photo File Formats

File type	Format	Resolution
.jpeg, .jpg, .jpe	JPEG	<ul style="list-style-type: none"> <li>• Minimum: 64 x 64</li> <li>• Maximum: Normal Type: 15360 (W) x 8640 (H) Progressive Type: 1920 (W) x 1440 (H)</li> </ul>
.png	PNG	<ul style="list-style-type: none"> <li>• Minimum: 64 x 64</li> <li>• Maximum: 5760 (W) x 5760 (H)</li> </ul>
.bmp	BMP	<ul style="list-style-type: none"> <li>• Minimum: 64 x 64</li> <li>• Maximum: 1920 (W) x 1080 (H)</li> </ul>

### Cautions for Video Playback

- Streams that include Global Motion Compensation (GMC) and Quarterpel Motion Estimation (Qpel) are not supported.
- ULTRA HD video (ULTRA HD models only): 3840 X 2160, 4096 X 2160
- Some HEVC-encoded ULTRA HD videos other than the content officially provided by LG Electronics may not be played.
- Some codecs can be supported after a software upgrade.

Extension	Codec	
.mkv, .mp4, .ts	Video	H.265/AVC, HEVC
	Audio	Dolby Digital, Dolby Digital Plus, AAC

- Only Window Media Audio V7 and later are supported.
- The AAC Main Profile is not supported.
- Video files created by some encoders may not be played.
- Video files in a different format than specified may not be played properly.
- Video files stored on a USB storage device that does not support High Speed may not be played properly.
- Videos with unsupported audio only play video or do not play.

**Tips for using USB storage devices**

- Only USB storage devices are recognised.
- USB storage devices connected to the Projector through a USB hub may not work properly.
- USB storage devices that use an automatic recognition program may not be recognised.
- USB storage devices that use their own drivers may not be recognised.
- The recognition speed of a USB storage device may depend on each device.
- Please do not turn off the display or unplug the USB device when the connected USB storage device is working. When the device is suddenly separated or unplugged, the stored files or the USB storage device may be damaged.
- Please do not connect the USB storage device which was artificially maneuvered on the PC. The device may cause the product to malfunction or fail to be played. Remember to only use USB storage devices that store normal music, image, and/or movie files.
- Storage devices formatted with utility programs that are not supported by Windows may not be recognised.
- Please connect power to a USB storage device (over 0.5 A) which requires an external power supply. Otherwise, the device may not be recognised.
- Please connect a USB storage device with the cable offered by the device maker.
- Some USB storage devices may not be supported or operated smoothly.
- File alignment methods of the USB storage device is similar to Windows and filenames can include up to 100 English characters.
- Be sure to back up important files since data stored in a USB memory device may be damaged. We will not be responsible for any data loss.
- If the USB HDD does not have an external power source, the USB device may not be detected. So make sure to connect it to an external power source.
  - Please use a power adapter for an external power source. No USB cable is provided for an external power source.

- If your USB storage device has multiple partitions, or if you use a USB multi-card reader, you can use up to four partitions or USB memory devices.
- If a USB storage device is connected to a USB multi-card reader, its volume data may not be detected.
- If the USB storage device does not work properly, remove it and connect it again.
- If the USB storage device is connected in Standby Mode, a specific hard disk will automatically be loaded when the display is turned on.
- The recommended capacity is 1 TB or less for a USB external hard disk and 32 GB or less for USB memory.
- Any device with more than the recommended capacity may not work properly.
- If a USB external hard disk with an [Energy Saving] feature does not work, turn the hard disk off and on again to make it work properly.
- USB storage devices (USB 2.0 or below) are also supported. However, they may not work properly in the videos list.
- A maximum of 999 folders or files can be recognised under one folder.
- When distributing contents to USB while playing a video in UHD resolution, the video might experience temporary stuttering.
- USB storage devices supported by a mobile device may not be recognised.
- Even if multiple USB storage devices are connected, up to three USB storage devices can be used.
- When using SuperSign CMS, it is recommended to use only one USB storage device.

## Group Manager 2.0

This feature enables you to group together multiple Projector sets on a single network into the same group and to distribute content (schedules and playlists) or copy setting data on a group basis. This feature has two modes, Master and Slave, and it can access the browser on your PC or mobile device.

### [Master]

- Add, edit, and delete group.
- Clone your device's settings data.
- Distribute [Schedule] and [Playlists] on a group basis.
- All Projector sets initially come in Master mode.

### [Slave]

- Play [Schedule] and [Playlists] distributed in Master mode.
- Remove Projector sets for their groups.
- Projector sets that have been added to a group are automatically switched to Slave mode. Conversely, when a Projector set has been deleted from a group, it is automatically initialized and switched to Master mode.
- If a new Slave has been added to an existing group, or if the [Data Cloning] or the distribution of [Schedule]/[Playlist] has not been properly performed, the [Data Cloning] or [Sync] button will be activated.
- You can duplicate the master device's setting data to the group by using [Data Cloning].
- You can re-download the content distributed to the group by using [Sync].

## **GROUP MANAGEMENT**

- **Creating a New Group**
  1. Click [Add New Group].
  2. Enter a group name.
  3. Click [Add Device], select the devices you wish to add to the group, and add them.
  4. Click [Done], and you will see that a new group has been created.
- **Editing a Group**
  1. Click the group you wish to edit.
  2. Add a new device by using [Add Device].
  3. Delete a device by using [Delete Device].
  4. Check whether the devices in the group are connected to a network by using [Device Check].
  5. If there are any sets of devices in the group that are not [Data Cloning] or content synchronized, [Data Cloning] or [Sync] button will be activated.
  6. You can re-copy the master device's setting data to the group by using [Data Cloning].
  7. You can re-distribute the content distributed to the group by using [Sync].
- **Deleting a Group**
  1. Click [Delete Group].
  2. Select the group you wish to delete and click [Delete].
  3. Check that the group you selected has been deleted.
- **All Devices View:** This page enables you to manage all slave Projector sets that are connected to the same network.
  1. Click [All Devices View].
  2. Click [Reset Device Mode].
  3. Select the slave Projector set whose device mode you wish to change and click [Reset].



### **[Setting Data Cloning]**

- 1 Select your desired group and click Clone.
- 2 Check that the data have been copied on the slave sets.

### **[Content Distribute]**

- 1 Select the type of content you wish to distribute (Schedules or Playlists).
- 2 Select the content you wish to distribute.
- 3 Select the group to which you wish to distribute the content and click [Distribute].
- 4 Run the Content Manager app on the slave sets and check that the content has been distributed.

#### **How to Use**

- Projector: Run, add, delete or edit app on the home screen.
- Mobile devices: Run the app in the Launcher bar or access the app from a mobile device using the QR code or URL provided.



#### **CAUTION**

- You can create up to 25 groups.
- You can add up to 12 slave devices to a group.
- You can distribute the schedules stored on external devices after executing Content Manager's import operation.
- Make sure to delete all schedules stored on the slave sets before distributing any schedules.
- A list of devices you can add to your desired group appears only when the following conditions have been met:
  - The devices you wish to add must be on the same network as the master device.
  - The devices you wish to add must be in Master mode, and they must not belong to any existing group.
  - Port 1900 (UDP) needs to be activated ([Setting] > [General] > [Network] > [Port Control]: Port 1900 (UDP) unregistered).
- It may not work properly in wireless network environments. It is recommended you use a wired network.
- Run the initial settings for Slave function when deleting the group.

## Screen Share

This feature allows the screen of a user's device such as a mobile or PC Windows to be shared with a display using a wireless connection such as WiDi or Miracast.

### How to Use [Screen Share]

INPUT /  →  → [Screen Share]

- 1 Connect according to the instructions provided by the guide that can be accessed through the CONNECTION GUIDE button in the upper right.
- 2 Once the connection is established, Screen Share between the user device and the Projector is enabled.

---

#### NOTE

- For the information on how to use Intel WiDi, visit PC/laptop manufacturer webpage.
  - This feature only works properly with WiDi 3.5 or later versions.
  - This feature only works on Windows 8.1 or later.
-

## LG Presenter

This feature uses the web browser on your PC to display the PC screen on the Projector that is connected to your PC via cable or wireless.

### How to use LG Presenter

#### On Projector

INPUT /  → LG Presenter

#### On PC

Enter the URL provided on the Projector into the address bar of your web browser.

---

#### NOTE

- This feature may not be supported depending on the product.
- Only PC screen sharing is supported. Audio sharing is not supported.
- Some web browsers do not support screen sharing. We recommend using the latest version of Chrome.
- When connecting via a web browser, a warning may appear indicating that the connection is unsafe. This is not a security issue, and you can proceed as usual.
- Since some UIs related to screen sharing are provided by the PC browser, the displayed language or the action may be different.
- The handover feature is used to share another client's screen when one client is already connected. It requests the currently connected client to hand over the screen sharing privilege.
- The handover request notification appears only if the user has allowed notifications.

---

#### CAUTION

- The Projector and PC must be on a network where they can be connected to each other.
- If Screen Share does not work or if a normal connection cannot be made to the Projector device, check the firewall settings on your PC.
- LG Presenter does not support video playback.

# MANAGEMENT TOOLS

## Control Manager

Control and check the status of the display through the Web browser.

This function is available for PCs and mobile devices.

Different features are supported depending on the product.

### Function

- [Dashboard]: Display a summary of the product's status and provides links to each page.
- [Display & sound]: Provides features such as Screen Brightness, Sound, Input, and Reboot.
- [Time & Date]: Enable/disable Set Automatically feature and displays/changes the time set for the product.
- [Network]: Set the name and IP address of your Projector.
- [Tile Mode]: Display the tile mode settings of the product.
- [Fail Over]: Turns the Fail Over feature on or off and sets related items.
- [Play via URL]: Turn Play via URL on or off and set URLs.
- [S/W Update]: Update the firmware of the product.
- [Charts]: Output the product's status information such as its temperature and fan status.
- [Log]: Output product malfunction records.
- [System Information]: Output information such as the product's software version and model name.

## Picture ID

[Picture ID] is used to change the settings of a specific set (display) using a single IR receiver for multi-vision. Communication is possible between a Projector with an IR receiver and other Projectors using RS-232C cables. Each Projector is identified by a Set ID. Setting [Picture ID] allows you to only use the remote control with Projectors with a [Set ID] that matches the [Picture ID].

- 1 Assign [Set ID] to the installed Projectors as shown below:

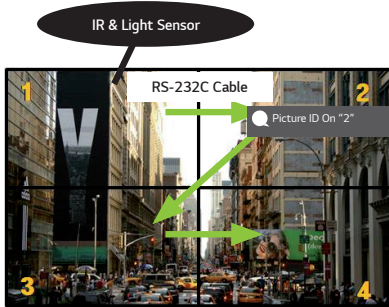







- 2 Press the PICTURE ID ON (red) button on the remote control.
  - 3 Make sure that the Picture ID you set is identical to the [Set ID] of the Projector you wish to control.
- A set with a [Set ID] that is different from the [Picture ID] cannot be controlled by IR signals.

### NOTE

- If [Picture ID] has been set to 2, only the upper right Projector, which has a [Set ID] of 2, can be controlled by IR signals.
- If you press the PICTURE ID OFF (green) button on your remote control, the [Picture ID] for all Projectors are turned off. If you then press any button on the remote control, all Projectors can be controlled by IR signals regardless of their [Set ID]s.

# IR CODE

- All models do not support the HDMI/USB function.
- Some key codes may not be supported depending on the model.

Code (Hex)	Function	Remarks
08	 (Power)	Remote control button
C4	MONITOR ON (Projector on)	Remote control button
C5	MONITOR OFF (Projector off)	Remote control button
95	ENERGY SAVING	Remote control button
0B	INPUT (Select input)	Remote control button
10	Number Key 0	Remote control button
11	Number Key 1	Remote control button
12	Number Key 2	Remote control button
13	Number Key 3	Remote control button
14	Number Key 4	Remote control button
15	Number Key 5	Remote control button
16	Number Key 6	Remote control button
17	Number Key 7	Remote control button
18	Number Key 8	Remote control button
19	Number Key 9	Remote control button
02	 (Vol +)	Remote control button
03	 (Vol -)	Remote control button
E0	BRIGHTNESS (PAGE)  (Brightness/Page Up)	Remote control button
E1	BRIGHTNESS (PAGE)  (Brightness/Page Down)	Remote control button
98	LENS	Remote control button
32	1/a/A	Remote control button
2F	CLEAR	Remote control button
7E	 SIMPLINK	Remote control button
79	ARC (Mark/Aspect Ratio)	Remote control button
4D	PSM (Picture Mode)	Remote control button
09	 (MUTE)	Remote control button

Code (Hex)	Function	Remarks
43	⚙️ (Settings/Menu)	Remote control button
AA	ℹ️ (Information)	Remote control button
40	⬆️ (Up)	Remote control button
41	⬇️ (Down)	Remote control button
06	➤ (Right)	Remote control button
07	➤ (Left)	Remote control button
44	Ⓞ OK (OK)	Remote control button
28	↶ (BACK)	Remote control button
57	INSTALL (Installation Wizard)	Remote control button
5B	EXIT (Exit)	Remote control button
72	PICTURE ID ON (red)	Remote control button
71	PICTURE ID OFF (green)	Remote control button
63	Yellow	Remote control button
61	Blue	Remote control button
5F	W.BAL (White Balance)	Remote control button
84	BLANK/* (Blank)	Remote control button
7C	🏠 (Home Menu)	Remote control button

# CONTROLLING MULTIPLE PRODUCTS

- This only applies to certain models.

Use this method to connect several products to a single PC. You can control several products at a time by connecting them to a single PC.

In the Option menu, the Set ID must be between 1 and 1000 without being duplicated.

## Connecting cables

- Images may differ according to the model.

Connect the RS-232C cable as shown in the picture.

The RS-232C protocol is used for communication between the PC and product. You can turn the product on/off, select an input source and adjust the OSD menu from your PC.

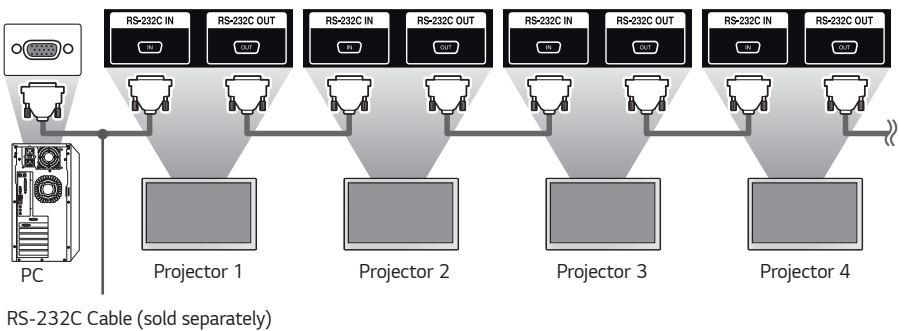
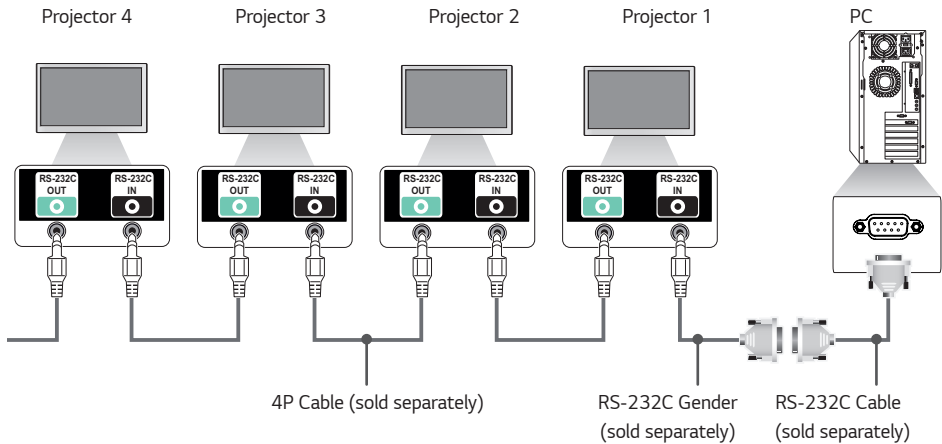



## Communication Parameter

- Baud Rate: 9600 bps
- Data Length: 8 bits
- Parity Bit: None
- Stop Bit: 1 bit
- Flow Control: None
- Communication Code: ASCII code

---

### NOTE

- When using 3-wire connections (non-standard), an IR daisy chain cannot be used.
- Be sure to only use the provided gender to connect properly.
- When you have daisy-chained multiple Projector products to control them simultaneously, if you attempt to turn on/off the master device in a continuous manner, some products may not turn on. In this case, you can turn those Projectors on by pressing the Projector **MONITOR ON** button, not the Power button.

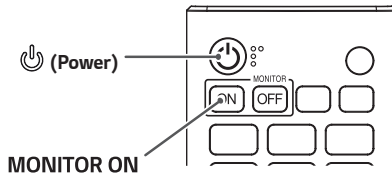

## Command Reference List

The configurable items differ depending upon model.

	Command		Data (Hexadecimal)
	1	2	
01. [Power]	k	a	00 to 02
02. Select Input	x	b	See Select Input
03. [Aspect Ratio]	k	c	See [Aspect Ratio]
04. [Brightness Control]	j	q	00 to 03
05. [Picture Mode]	d	x	See [Picture Mode]
06. [Contrast]	k	g	00 to 64
07. [Brightness]	k	h	00 to 64
08. [Sharpness]	k	k	00 to 32
09. [Color]	k	i	00 to 64
10. [Tint]	k	j	00 to 64
11. [Color Temperature]	x	u	70 to D3
12. [Balance]	k	t	00 to 64
13. [Sound Mode]	d	y	See [Sound Mode]
14. [Mute on]	k	e	00 to 01
15. Volume Control	k	f	00 to 64
16. [Current Time] 1 (year/month/day)	f	a	See [Current Time] 1
17. [Current Time] 2 (hour/minute/second)	f	x	See [Current Time] 2
18. [No Signal Power Off (15 Min)]	f	g	00 to 01
19. [No IR Power Off (4hour)]	m	n	00 to 01
20. [Language]	f	i	See [Language]
21. [Default] Settings	f	k	00 to 02
22. Current Temperature	d	n	FF
23. [Key]	m	c	See [Key]
24. Time Elapsed	d	l	FF
25. Check product serial number	f	y	FF

	Command		Data (Hexadecimal)
	1	2	
26. [Software Version]	f	z	FF
27. [White Balance] Red Gain	j	m	00 to FE
28. [White Balance] Green Gain	j	n	00 to FE
29. [White Balance] Blue Gain	j	o	00 to FE
30. [White Balance] Red Offset	s	x	00 to 7F
31. [White Balance] Green Offset	s	y	00 to 7F
32. [White Balance] Blue Offset	s	z	00 to 7F
33. [Screen Off]	k	d	00 to 01
34. [Tile Mode]	d	d	00 to FF
35. Check [Tile Mode]	d	z	FF
36. [Tile ID]	d	i	See [Tile ID]
37. [DPM (Standby Mode)]	f	j	See [DPM (Standby Mode)]
38. Remote Control/Local Key Lock	k	m	00 to 01
39. [Power On Delay]	f	h	00 to FA
40. Select [Fail Over] Mode	m	i	00 to 02
41. Select [Fail Over] Input	m	j	See Select [Fail Over] Input
42. Remote Control Key Lock	t	p	00 to 02
43. [Local Key Operation Lock]	t	o	00 to 02
44. Status Check	s	v	See Status Check
45. [Daylight Saving Time]	s	d	See [Daylight Saving Time]
46. [PM Mode]	s	n, 0c	00 to 05
47. [Network Settings]	s	n, 80(81)(82)	See [Network Settings]
48. [Power On Status]	t	r	00 to 02
49. Wired [Wake On LAN (Networked Standby Mode)]	f	w	00 to 01
50. [Screen Rotation]	t	h	00 to 03

	Command		Data (Hexadecimal)
	1	2	
51. [Time Sync]	s	n, 16	00 to 01
52. [Contents Sync]	t	g	00 to 01
53. [External Input Rotation]	s	n, 85	00 to 03
54. [Beacon]	s	n, 88	00 to 01
55. [Multi Screen] Mode & Input	x	c	See [Multi Screen] Mode & Input
56. [Aspect Ratio] (Multi screen)	x	d	See [Aspect Ratio] (Multi screen)
57. [Screen Off] (Multi screen)	x	e	See [Screen Off] (Multi screen)
58. [Screen Off Always]	s	n, 0d	00 to 01
59. Stop Video	k	x	00 to 01
60. Wireless [Wake On LAN (Networked Standby Mode)]	s	n, 90	00 to 01
61. [OSD Lock]	k	l	00 to 01
62. [HDMI IT Content]	s	n, 99	00 to 01
63. [Holiday Setting]	s	n, 9b	See [Holiday Setting]
64. [UPnP]	s	n, 9c	00 to 01
65. [Home Dashboard Lock]	s	n, 9d	00 to 01
66. [USB Lock]	s	n, 9e	00 to 01
67. [Wi-Fi Lock]	s	n, 9f	00 to 01
68. [Screen Share Lock]	s	n, a0	00 to 01
69. [Play Backup Content]	s	n, a1	See [Play Backup Content]
70. [Bootimg Logo Image]	s	n, a3	00 to 01
71. [SoftAP]	s	n, a4	00 to 01
72. Play Saved Internal Media	s	n, a8	See Play Saved Internal Media
73. [No Signal Image]	s	n, a9	00 to 01
74. [Audio Out]	s	n, aa	00 to 02
75. [DPM (Standby Mode) Wake Up Control]	s	n, 0b	00 to 01

	Command		Data (Hexadecimal)
	1	2	
76. [Apply to all inputs]	s	n, 52	01
77. [Timer Power On] Scheduling	f	d	See [Timer Power On] Scheduling
78. [Timer Power Off] Scheduling	f	e	See [Timer Power Off] Scheduling
79. LCIN008 Control	s	n, b8	See LCIN008 Control
80. [Transfer Control]	s	n, cb	See [Transfer Control]
81. Multichannel	s	n, 76	01 to 09
82. Change SetID	j	x	See Change SetID
83. [Gamma]	s	n, ad	00 to 03
84. [Black Level]	s	n, ae	00 to 02
85. [UHD Deep Color]	s	n, af	See [UHD Deep Color]
86. [Sync Mode]	s	n, b0	00 to 01
87. [Input Manager]	s	n, b1	See [Input Manager]
88. [PC Power Control]	s	n, 8b	00 to 02
89. [Average Picture Level Auto Control]	s	n, be	00 to 01
90. [Stereo Mode]	s	n, c2	00 to 02
91. [HDR Picture Mode]	s	n, c4	See [HDR Picture Mode]
92. [Dynamic Tone Mapping]	s	n, c5	00 to 01
93. [Change Password]	s	n, a7	See [Change Password]
94. [Color Calibration]	s	n, d6	00 to 01
95. [Quick Start+]	s	n, 0e	00 to 01

\* Note Commands may not work when there is no external input used.

\* Some commands may not be supported on some models.

# Transmission/Reception Protocol

## Transmission

(Command1)(Command2)( )(Set ID)( )(Data)(Cr)

- \* (Command1): This command is used to identify between the adjustment setting or the user adjustment modes.
- \* (Command2): This command is used to control the Projector.
- \* (Set ID): Used for selecting a set you want to control. A unique Set ID can be assigned to each set ranging from 1 to 1000 (01H to 3E8H) under Settings in the OSD menu. Selecting '00H' for Set ID allows the simultaneous control of all connected Projectors. (The maximum value may differ depending on the model.)
- \* (Data): Transmits command data. Data count may increase depending on the command.
- \* (Cr): Carriage Return. This parameter corresponds to '0 x 0D' in ASCII code.
- \* ( ): White Space. This parameter corresponds to '0 x 20' in ASCII code.

## ACK (Acknowledgment)

(Command2)( )(Set ID)( )(OK/NG)(Data)(x)

- \* The product transmits an ACK (acknowledgment) based on this format when receiving normal data. At this point, if the data is FF, it indicates the present status data. If the data is in data write mode, it returns the data of the PC computer.
- \* If a command is sent with Set ID '00' (=0 x 00), the data is reflected to all Projectors and they do not send an acknowledgment (ACK).
- \* If you send "FF" as the value of the data in control mode via RS-232C, you can check the value currently set for the relevant feature (not applicable to some features).
- \* Some commands may not be supported on some models.

**01. [Power] (Command: k a)**

Controls the power on/off status of the Projector.

**Transmission**

(k)(a)( ) (Set ID)( ) (Data)(Cr)

Data 00: [Off]  
01: [On]  
02: Restart

**Acknowledgment**

(a)( ) (Set ID)( ) (OK/NG)(Data)(x)

- \* The Acknowledgment signal is returned properly only when the Projector is fully powered on.
- \* There may be a delay between the Transmission and Acknowledgment signals.
- \* This feature may not be available for all models.

**02. Select Input (Command: x b)**

Selects an input signal.

**Transmission**

(x)(b)( ) (Set ID)( ) (Data)(Cr)

Data 90: HDMI1 (DTV)  
A0: HDMI1 (PC)  
91: HDMI2 (DTV)  
A1: HDMI2 (PC)  
92: HDMI3/HDBaseT (DTV)  
A2: HDMI3/HDBaseT (PC)  
C0: DISPLAYPORT (DTV)  
D0: DISPLAYPORT (PC)  
E0: SuperSign webOS Player  
E1: Others  
E2: Multi Screen  
E3: Play via URL  
E8: SI App

**Acknowledgment**

(b)( ) (Set ID)( ) (OK/NG)(Data)(x)

- \* Some input signals may not be available for all models.
- \* If it is not distributed from SuperSign W, webOS Player returns NG.
- \* The SI App only supports Set operations over RS232C.

**03. [Aspect Ratio] (Command: k c)**

Adjusts the aspect ratio of your Projector.

**Transmission**

(k)(c)( ) (Set ID)( ) (Data)(Cr)

Data 02: [Full Screen]  
06: [Original]

**Acknowledgment**

(c)( ) (Set ID)( ) (OK/NG)(Data)(x)

- \* The aspect ratio may differ depending on the model's input configuration.

**04. [Brightness Control] (Command: j q)**

Sets the brightness of your Projector.

**Transmission**

(j)(q)( ) (Set ID)( ) (Data)(Cr)

Data 01: [Minimum]  
02: [Medium]  
03: [Maximum]

**Acknowledgment**

(q)( ) (Set ID)( ) (OK/NG)(Data)(x)

- \* This feature may not be available for all models.

**05. [Picture Mode] (Command: d x)**

Selects a picture mode.

**Transmission**

(d)(x)( ) (Set ID)( ) (Data)(Cr)

Data 00: [Mall/QSR]  
01: [General]  
02: [Gov./Corp.]  
03: [Transportation]  
04: [Education], [Screen Game]  
05: [Expert1]  
11: [Calibration]  
12: [Hospital]

**Acknowledgment**

(x)( ) (Set ID)( ) (OK/NG)(Data)(x)

- \* Some picture modes may not be available for all models.

**06. [Contrast] (Command: k g)**

Adjusts the screen contrast.

**Transmission**

(k)(g)( ) (Set ID)( ) (Data)(Cr)

Data 00-64: Contrast 0-100

**Acknowledgment**

(g)( ) (Set ID)( ) (OK/NG)(Data)(x)

**07. [Brightness] (Command: k h)**

Adjusts the screen brightness.

**Transmission**

(k)(h)( ) (Set ID)( ) (Data)(Cr)

Data 00-64: Brightness 0-100

**Acknowledgment**

(h)( ) (Set ID)( ) (OK/NG)(Data)(x)

**08. [Sharpness] (Command: k k)**

Adjusts the screen sharpness.

**Transmission****(k)(k)( ) (Set ID)( ) (Data)(Cr)**

Data 00-32: Sharpness 0-50

**Acknowledgment****(k)( ) (Set ID)( ) (OK/NG)(Data)(x)****09. [Color] (Command: k i)**

Adjusts the screen colors.

**Transmission****(k)(i)( ) (Set ID)( ) (Data)(Cr)**

Data 00-64: Color 0-100

**Acknowledgment****(i)( ) (Set ID)( ) (OK/NG)(Data)(x)****10. [Tint] (Command: k j)**

Adjusts the screen tints.

**Transmission****(k)(j)( ) (Set ID)( ) (Data)(Cr)**

Data 00-64: Tint Red 50-Green 50

**Acknowledgment****(j)( ) (Set ID)( ) (OK/NG)(Data)(x)****11. [Color Temperature] (Command: x u)**

Adjusts the screen color temperature.

**Transmission****(x)(u)( ) (Set ID)( ) (Data)(Cr)**

Data 70-D2: 3200K-13000K

Data 70-D3: 3200K-13000K, 13100K(Natural)

**Acknowledgment****(u)( ) (Set ID)( ) (OK/NG)(Data)(x)****12. [Balance] (Command: k t)**

Adjusts the sound balance.

**Transmission****(k)(t)( ) (Set ID)( ) (Data)(Cr)**

Data 00-64: Left 50-Right 50

**Acknowledgment****(t)( ) (Set ID)( ) (OK/NG)(Data)(x)**

\* This feature may not be available for all models.

**13. [Sound Mode] (Command: d y)**

Selects a sound mode.

**Transmission****(d)(y)( ) (Set ID)( ) (Data)(Cr)**

Data 01: [Standard]

02: [Music]

03: [Cinema]

04: [Sports]

05: [Game]

07: [Clear Voice III]

**Acknowledgment****(y)( ) (Set ID)( ) (OK/NG)(Data)(x)**

\* This feature may not be available for all models.

**14. [Mute on] (Command: k e)**

Mutes/unmutes audio.

**Transmission****(k)(e)( ) (Set ID)( ) (Data)(Cr)**

Data 00: [Mute] (Volume off)

01: Mute off (Volume on)

**Acknowledgment****(e)( ) (Set ID)( ) (OK/NG)(Data)(x)**

\* This feature may not be available for all models.

**15. Volume Control (Command: k f)**

Adjusts the playback volume.

**Transmission****(k)(f)( ) (Set ID)( ) (Data)(Cr)**

Data 00-64: Volume 0-100

**Acknowledgment****(f)( ) (Set ID)( ) (OK/NG)(Data)(x)**

\* This feature may not be available for all models.



**16. [Current Time] 1 (year/month/day) (Command: f a)**

Sets the Clock 1 (year/month/day) values and Auto Time.

**Transmission**

1. (f)(a)( )(Set ID)( )(Data1)( )(Data2)( )(Data3)(Cr)  
 2. (f)(a)( )(Set ID)( )(0)(0)( )(Data1)(Cr)

1. When setting Clock 1 (year/month/day)

Data1 00-: 2010 -

Data2 01-0C: January - December

Data3 01-1F: 1-31

- \* The minimum and maximum values for Data1 differ depending on the product's release year.
- \* Enter "fa [Set ID] ff" to view Clock 1 (year/month/day) settings.
  2. When Setting Auto Time
    - Data1 00: [Auto]
    - 01: [Manual]
- \* To view the set value of the Auto time, enter "fa [Set ID] 00 ff".

**Acknowledgment**

1. (a)( )(Set ID)( )(OK/NG)(Data1)(Data2)(Data3)(x)  
 2. (a)( )(Set ID)( )(OK/NG)(0)(0)(Data1)(x)

**17. [Current Time] 2 (hour/minute/second) (Command: f x)**

Sets the Clock 2 values (hour/minute/second).

**Transmission**

- (f)(x)( )(Set ID)( )(Data1)( )(Data2)( )(Data3)(Cr)

Data1 00-17: 00-23 hours

Data2 00-3B: 00 - 59 minutes

Data3 00-3B: 00-59 seconds

- \* Enter "fx [Set ID] ff" to view the Time 2 (hour/minute/second) settings.
- \* This feature is only available when Clock 1 (year/month/day) has been set.

**Acknowledgment**

- (x)( )(Set ID)( )(OK/NG)(Data1)(Data2)(Data3)(x)

**18. [No Signal Power Off (15 Min)] (Command: f g)**

Sets the Projector to enter Automatic Standby mode if there is no signal for 15 minutes.

**Transmission**

- (f)(g)( )(Set ID)( )(Data)(Cr)

Data 00: [Off]

01: [On]

**Acknowledgment**

- (g)( )(Set ID)( )(OK/NG)(Data)(x)

**19. [No IR Power Off (4hour)] (Command: m n)**

Activates Auto Power Off when there is no IR signal for 4 hours.

**Transmission**

- (m)(n)( )(Set ID)( )(Data)(Cr)

Data 00: [Off]

01: [On]

**Acknowledgment**

- (n)( )(Set ID)( )(OK/NG)(Data)(x)

**20. [Language] (Command: f i)**

Sets the OSD language.

**Transmission**

- (f)(i)( )(Set ID)( )(Data)(Cr)

Data 00: Czech

01: Danish

02: German

03: English

04: Spanish (Europe)

06: French

07: Italian

08: Dutch

09: Norwegian

0A: Portuguese

0B: Portuguese (Brazil)

0C: Russian

0D: Finnish

0E: Swedish

0F: Korean

10: Chinese (Mandarin)

11: Japanese

12: Chinese (Cantonese)

13: Arabic

14: Turkish

15: Polish

**Acknowledgment**

- (i)( )(Set ID)( )(OK/NG)(Data)(x)

\* Some languages may not be available for all models.

**21. [Default] Settings (Command: f k)**

Executes Reset.

(Initialize Screen can only be executed in RGB input mode.)

**Transmission**

(f)(k)( ) (Set ID)( ) (Data)(Cr)

Data 00: [Picture Reset]

02: [Reset to Initial Settings]

**Acknowledgment**

(k)( ) (Set ID)( ) (OK/NG)(Data)(x)

\* This feature may not be available for all models.

**22. Current Temperature (Command: d n)**

Checks the current temperature of the product.

**Transmission**

(d)(n)( ) (Set ID)( ) (Data)(Cr)

Data FF: Status Check

**Acknowledgment**

(n)( ) (Set ID)( ) (OK/NG)(Data)(x)

\* The temperature is displayed in hexadecimal.

**23. [Key] (Command: m c)**

Sends a key code for the IR remote control.

**Transmission**

(m)(c)( ) (Set ID)( ) (Data)(Cr)

Data IR\_KEY\_CODE

**Acknowledgment**

(c)( ) (Set ID)( ) (OK/NG)(Data)(x)

\* For key codes, see IR Codes.

\* Some key codes may not be supported depending on the model.

**24. Time Elapsed (Command: d l)**

Displays the time that has elapsed after your Projector has turned on.

**Transmission**

(d)(l)( ) (Set ID)( ) (Data)(Cr)

Data FF: Read status

**Acknowledgment**

(l)( ) (Set ID)( ) (OK/NG)(Data)(x)

\* The data received is displayed in hexadecimal.

**25. Check product serial number (Command: f y)**

Checks the serial number of the product.

**Transmission**

(f)(y)( ) (Set ID)( ) (Data)(Cr)

Data FF: Check product serial number

**Acknowledgment**

(y)( ) (Set ID)( ) (OK/NG)(Data)(x)

\* Data is in ASCII format.

**26. [Software Version] (Command: f z)**

Checks the software version of the product.

**Transmission**

(f)(z)( ) (Set ID)( ) (Data)(Cr)

Data FF: Check the software version

**Acknowledgment**

(z)( ) (Set ID)( ) (OK/NG)(Data)(x)

**27. [White Balance] Red Gain (Command: j m)**

Adjusts the red gain value for white balance.

**Transmission**

(j)(m)( ) (Set ID)( ) (Data)(Cr)

Data 00-FE: Red Gain 0-254

FF: Checks red gain value

**Acknowledgment**

(m)( ) (Set ID)( ) (OK/NG)(Data)(x)

**28. [White Balance] Green Gain (Command: j n)**

Adjusts the green gain value for white balance.

**Transmission**

(j)(n)( ) (Set ID)( ) (Data)(Cr)

Data 00-FE: Green Gain 0-254

FF: Checks green gain value

**Acknowledgment**

(n)( ) (Set ID)( ) (OK/NG)(Data)(x)

**29. [White Balance] Blue Gain (Command: j o)**

Adjusts the blue gain value for white balance.

**Transmission**

(j)(o)( ) (Set ID)( ) (Data)(Cr)

Data 00-FE: Blue Gain 0-254

FF: Checks blue gain value

**Acknowledgment**

(o)( ) (Set ID)( ) (OK/NG)(Data)(x)

**30. [White Balance] Red Offset (Command: s x)**

Adjusts the red offset value for white balance.

**Transmission**

(s)(x)( )(Set ID)( )(Data)(Cr)

Data 00-7F: Red Offset 0-127  
FF: Checks red offset value

**Acknowledgment**

(x)( )(Set ID)( )(OK/NG)(Data)(x)

**31. [White Balance] Green Offset (Command: s y)**

Adjusts the green offset value for white balance.

**Transmission**

(s)(y)( )(Set ID)( )(Data)(Cr)

Data 00-7F: Green Offset 0-127  
FF: Checks green offset value

**Acknowledgment**

(y)( )(Set ID)( )(OK/NG)(Data)(x)

**32. [White Balance] Blue Offset (Command: s z)**

Adjusts the blue offset value for white balance.

**Transmission**

(s)(z)( )(Set ID)( )(Data)(Cr)

Data 00-7F: Blue Offset 0-127  
FF: Checks blue offset value

**Acknowledgment**

(z)( )(Set ID)( )(OK/NG)(Data)(x)

**33. [Screen Off] (Command: k d)**

Turns off/off the screen.

**Transmission**

(k)(d)( )(Set ID)( )(Data)(Cr)

Data 00: Screen On  
01: Screen Off

**Acknowledgment**

(d)( )(Set ID)( )(OK/NG)(Data)(x)

\* This feature may not be available for all models.

**34. [Tile Mode] (Command: d d)**

Sets a tile mode and values for the tile rows and columns.

**Transmission**

(d)(d)( )(Set ID)( )(Data)(Cr)

Data 00-FF: The first byte - tile column  
The second byte - tile row

\* 00, 01, 10, and 11 mean that the tile mode is off.

\* The maximum value may differ depending on the model.

**Acknowledgment**

(d)( )(Set ID)( )(OK/NG)(Data)(x)

\* This feature may not be available for all models.

\* There can be up to 9 values of Tile's Row x Column.

**35. Check [Tile Mode] (Command: d z)**

Checks the tile mode.

**Transmission**

(d)(z)( )(Set ID)( )(Data)(Cr)

Data FF: Check Tile Mode

**Acknowledgment**

(z)( )(Set ID)( )(OK/NG)(Data1)(Data2)(Data3)(x)

Data1 00: Tile Mode off  
01: Tile Mode on

Data2 00-0F: Tile column

Data3 00-0F: Tile row

\* This feature may not be available for all models.

**36. [Tile ID] (Command: d i)**

Sets the tile ID value of the product.

**Transmission**

(d)(i)( )(Set ID)( )(Data)(Cr)

Data 01-E1: Tile ID 1-225  
FF: Checks the Tile ID

\* The data value cannot exceed the value of row x column.

**Acknowledgment**

(i)( )(Set ID)( )(OK/NG)(Data)(x)

\* If you enter a value that exceeds the value of row x column for the Data parameter (except for 0xFF), Ack becomes NG.

\* This feature may not be available for all models.

\* If you change the values on a Video Wall model, please reboot for it to work normally.

**37. [DPM (Standby Mode)] (Command: f j)**

Sets the DPM(Display Power Management) function.

**Transmission****(f)(j)( ) (Set ID)( ) (Data)(Cr)**

Data 00: [Off]  
 02: 10 seconds  
 04: 1 minute  
 05: 3 minutes  
 06: 5 minutes  
 07: 10 minutes

**Acknowledgment****(j)( ) (Set ID)( ) (OK/NG)(Data)(x)**

\* This feature may not be available for all models.

**38. Remote Control/Local Key Lock (Command: k m)**

Adjusts the remote control/local key (product) lock.

**Transmission****(k)(m)( ) (Set ID)( ) (Data)(Cr)**

Data 00: [Off] (Lock Off)  
 01: [On] (Lock On)

\* When the Projector is turned off, the power key works even in On (01) mode.

**Acknowledgment****(m)( ) (Set ID)( ) (OK/NG)(Data)(x)**

\* This feature may not be available for all models.

**39. [Power On Delay] (Command: f h)**

Sets the schedule delay for when the power turns on. (Unit: seconds)

**Transmission****(f)(h)( ) (Set ID)( ) (Data)(Cr)**

Data 00-FA: Min 0- Max 250 (sec)

**Acknowledgment****(h)( ) (Set ID)( ) (OK/NG)(Data)(x)**

\* The maximum value may differ depending on the model.

**40. Select [Fail Over] Mode (Command: m i)**

Selects the Fail Over mode.

**Transmission****(m)(i)( ) (Set ID)( ) (Data)(Cr)**

Data 00: [Off]  
 01: [Auto]  
 02: [User Setting]

**Acknowledgment****(i)( ) (Set ID)( ) (OK/NG)(Data)(x)****41. Select [Fail Over] Input (Command: m j)**

Selects an input source for fail over. (This feature is only available when Fail Over is set to Custom.)

**Transmission****(m)(j)( ) (Set ID)( ) (Data1)( ) (Data2)( ) (Data3)( ) (Data4) ... ( ) (DataN)(Cr)**

Data1-N (Input priority 1-N)  
 90: HDMI1  
 91: HDMI2  
 92: HDMI3/HDBaseT  
 C0: DISPLAYPORT

**Acknowledgment****(j)( ) (Set ID)( ) (OK/NG)(Data1)(Data2)(Data3)(Data4) ... (DataN)(x)**

\* Some input signals may not be available for all models.

\* The data number (N) may vary depending on the model. (The data number depends on the number of supported input signals.)

\* This feature operates as the last input, and supports data in DTV format.

**42. Remote Control Key Lock (Command: t p)**

Configures the settings of the product's remote control key.

**Transmission****(t)(p)( ) (Set ID)( ) (Data)(Cr)**

Data 00: Unlocks all keys  
 01: Locks all keys except Power key  
 02: Locks all keys

**Acknowledgment****(p)( ) (Set ID)( ) (OK/NG)(Data)(x)**

\* When the Projector is turned off, the power key works even in the locks on all of the keys (02) mode.

**43. [Local Key Operation Lock] (Command: t o)**

Configures the local key operation settings of the product.

**Transmission**

(t)(o)( )(Set ID)( )(Data)(Cr)

Data 00: Unlocks all keys  
01: Locks all keys except Power key  
02: Locks all keys

**Acknowledgment**

(o)( )(Set ID)( )(OK/NG)(Data)(x)

- \* When the Projector is turned off, the power key works even in the locks on all of the keys (02) mode.
- \* This feature may not be available for all models.

**44. Status Check (Command: s v)**

Checks the current signal of the product.

**Transmission**

(s)(v)( )(Set ID)( )(Data)( )(FF)(Cr)

Data 02: Check whether there is a signal  
03: The Projector is currently in PM Mode

**Acknowledgment**

(v)( )(Set ID)( )(OK/NG)(Data)(Data1)(x)

Data 02 (when a signal is found)  
Data1 00: No signal  
01: Signal present

Data 03 (when the Projector is currently in PM mode)  
Data1 00: Screen is on  
01: Screen is off  
02: Screen Off Always is activated  
03: Sustain Aspect Ratio is activated

- \* The data number (N) may vary depending on the model.
- \* This feature may not be available for all models.

**45. [Daylight Saving Time] (Command: s d)**

Sets Daylight Savings Time.

**Transmission**

(s)(d)( )(Set ID)( )(Data1)( )(Data2)( )(Data3)( )(Data4)( )(Data5)( )(Cr)

Data1 00: Off (Data2-5: FF)  
01: Start Time  
02: End Time  
Data2 01-0C: January - December  
Data3 01-06: Week 1 - 6

- \* The maximum value of [Data3] may vary depending on the date.

Data4 00-06: (Sunday - Saturday)  
Data5 00-17: 00 - 23 hours

- \* If you wish to read the start/end times, enter FF for parameters [Data2] through [Data5].  
(Example 1: sd 01 01 ff ff ff ff - Checks the start time.  
Example 2: sd 01 02 ff ff ff ff - Checks the end time.)

- \* This feature only works when Clock 1 (year/month/day) and Clock 2 (hour/minute/second) have been set.

**Acknowledgment**

(d)( )(Set ID)( )(OK/NG)(Data1)(Data2)(Data3)(Data4)(Data5)(x)

- \* This feature may not be available for all models.

**46. [PM Mode] (Command: s n, 0c)**

Sets the PM mode.

**Transmission**

(s)(n)( )(Set ID)( )(0)(c)( )(Data)(Cr)

Data 00: [Power Off] (Basic)  
01: [Sustain Aspect Ratio]  
02: [Screen Off]  
03: [Screen Off Always]  
05: [Network Ready]

**Acknowledgment**

(n)( )(Set ID)( )(OK/NG)(0)(c)(Data)(x)

- \* This feature may not be available for all models.

**47. [Network Settings] (Command: s n, 80 or 81 or 82)**

Configures network and DNS settings.

**Transmission**

(s)(n)( )(Set ID)( )(Data1)( )(Data2)( )  
(Data3)( )(Data4)( )(Data5)(Cr)

Data1 80: Configures/views the temporary IP mode (Auto/Manual), subnet mask, and gateway.  
81: Configures/views the temporary DNS address.  
82: Saves temporary settings and views information about the current network.

\* If Data1 is 80,

Data2 00: Auto  
01: Manual  
FF: Views the temporary IP mode (Auto/Manual), subnet mask, and gateway.

\* If Data2 is 01 (Manual),

Data3 Manual IP address  
Data4 Subnet mask address  
Data5 Gateway address

\* If Data1 is 81,

Data2 DNS address  
FF: Displays the temporary DNS address.

\* If Data1 is 82,

Data2 80: Applies the temporary IP mode (Auto/Manual), subnet mask, and gateway.  
81: Applies the temporary DNS address  
FF: Information on the current network (IP, subnet gateway and DNS)

\* An example of settings,

1. Auto: sn 01 80 00
2. Manual: sn 01 80 01 010177223241 255255254000  
010177222001(IP:10.177.223.241, subnet:  
255.255.254.0, gateway: 10.177.222.1)
3. Network read: sn 01 80 ff
4. DNS setting: sn 01 81 156147035018 (DNS:  
156.147.35.18)
5. Applying the settings: sn 01 82 80 (applies the saved IP mode (auto/manual), subnet mask, and gateway), sn 01 82 81 (applies the saved DSN)

\* Each IP address contains 12 decimal digits.

**Acknowledgment**

(n)( )(Set ID)( )(OK/NG)(Data1)(Data)(x)

\* This feature is available only for wired networks.

\* This feature may not be available for all models.

**48. [Power On Status] (Command: t r)**

Sets the Power On status of the Projector.

**Transmission**

(t)(r)( )(Set ID)( )(Data)(Cr)

Data 00: [LST(Last Status)]  
01: [STD(Standby)]  
02: [PWR(Power On)]

**Acknowledgment**

(r)( )(Set ID)( )(OK/NG)(Data)(x)

**49. Wired [Wake On LAN (Networked Standby Mode)] (Command: f w)**

Selects a Wired Wake On LAN option.

**Transmission**

(f)(w)( )(Set ID)( )(Data)(Cr)

Data 00: [Off]  
01: [On]

**Acknowledgment**

(w)( )(Set ID)( )(OK/NG)(Data)(x)

**50. [Screen Rotation] (Command: t h)**

Sets the Screen Rotation feature.

**Transmission**

(t)(h)( )(Set ID)( )(Data) (Cr)

Data 00: [Off]  
01: 90 degrees  
02: 270 degrees  
03: 180 degrees

**Acknowledgment**

(h)( )(Set ID)( )(OK/NG)(Data)(x)

\* This feature may not be available for all models.

**51. [Time Sync] (Command: s n, 16)**

Sets Time Sync.

**Transmission**

(s)(n)( )(Set ID)( )(1)(6)( )(Data)(Cr)

Data 00: [Off]

01: [On]

- \* This feature only works when the Projector is in Master mode.
- \* This feature does not work if the current time is not set.

**Acknowledgment**

(n)( )(Set ID)( )(OK/NG)(1)(6)(Data)(x)

- \* This feature may not be available for all models.

**52. [Contents Sync] (Command: t g)**

Sets Content Sync.

**Transmission**

(t)(g)( )(Set ID)( )(Data)(Cr)

Data 00: [Off]

01: [On]

**Acknowledgment**

(g)( )(Set ID)( )(OK/NG)(Data)(x)

- \* This feature may not be available for all models.

**53. [External Input Rotation] (Command: s n, 85)**

Sets the External Input Rotation feature.

**Transmission**

(s)(n)( )(Set ID)( )(8)(5)( )(Data)(Cr)

Data 00: [Off]

01: 90 degrees

02: 270 degrees

03: 180 degrees

**Acknowledgment**

(n)( )(Set ID)( )(OK/NG)(8)(5)(Data)(x)

- \* This feature may not be available for all models.

**54. [Beacon] (Command: s n, 88)**

Turns on/off Beacon.

**Transmission**

(s)(n)( )(Set ID)( )(8)( )(Data)(Cr)

Data 00: [Off]

01: [On]

**Acknowledgment**

(n)( )(Set ID)( )(OK/NG)(8)(8)(Data)(x)

- \* This feature may not be available for all models.

**55. [Multi Screen] Mode & Input (Command: x c)**

Saves and controls Multi Screen modes and inputs.

**Transmission**

(x)(c)( )(Set ID)( )(Data1)( )(Data2)( )(Data3)( )(Data4)

( )(Data5)( )(Cr)

Data1 (Sets MultiScreen mode)

10: PIP

22: PBP2

23: PBP3

24: PBP4

25: PBP3 (1:2:1)

Data2 (Sets the Main input of Multi screen)

Data3 (Sets the Sub1 input of Multi screen)

Data4 (Sets the Sub2 input of Multi screen)

Data5 (Sets the Sub3 input of Multi screen)

90: HDMI1

91: HDMI2

92: HDMI3/HDBaseT

C0: DISPLAYPORT

**Acknowledgment**

(c)( )(Set ID)( )(OK/NG)( )(Data1)(Data2)(Data3)

(Data4)(Data5)(x)

- \* This feature may not be available for all models.
- \* Only the input modes supported by the model works.
- \* This feature operates as the last input, and supports data in DTV format.
- \* When the Read operation is performed, 00 is returned if it is not for an external input.

**56. [Aspect Ratio] (Multi screen) (Command: x d)**

Controls the aspect ratio of Multi Screen.

**Transmission**`(x)(d)( ) (Set ID)( ) (Data1)( ) (Data2)(Cr)`

Data1 01: Controls the Main input  
 02: Controls the Sub1 input  
 03: Controls the Sub2 input  
 04: Controls the Sub3 input

Data2 00: Full Screen  
 01: Original

**Acknowledgment**`(d)( ) (Set ID)( ) (OK/NG)(Data1)(Data2)(x)`

\* This feature may not be available for all models.

**57. [Screen Off] (Multi screen) (Command: x e)**

Turns on/off each screen in the Multi Screen.

**Transmission**`(x)(e)( ) (Set ID)( ) (Data1)( ) (Data2)(Cr)`

Data1 01: Controls the Main input  
 02: Controls the Sub1 input  
 03: Controls the Sub2 input  
 04: Controls the Sub3 input

Data2 00: Screen On  
 01: Screen Off

\* This feature only works when the Multi Screen app is running.

\* This feature does not work when there is no signal.

**Acknowledgment**`(e)( ) (Set ID)( ) (OK/NG)(Data1)(Data2)(x)`

\* This feature may not be available for all models.

**58. [Screen Off Always] (Command: s n, 0d)**

If you activate the Screen Off Always feature, the Projector enters Screen Off mode regardless of whether or not you have activated PM mode.

**Transmission**`(s)(n)( ) (Set ID)( ) (0)(d)( ) (Data)(Cr)`

Data 00: [Off]  
 01: [On]

**Acknowledgment**`(n)( ) (Set ID)( ) (OK/NG)(0)(d)(Data)(x)`

\* This feature may not be available for all models.

**59. Stop Video (Command: k x)**

Controls Stop Video.

**Transmission**`(k)(x)( ) (Set ID)( ) (Data)(Cr)`

Data 00: The Stop Video feature is on.  
 01: The Stop Video feature is off.

\* This feature only works in single input mode.

**Acknowledgment**`(x)( ) (Set ID)( ) (OK/NG)(Data)(x)`

\* This feature may not be available for all models.

**60. Wireless [Wake On LAN (Networked Standby Mode)] (Command: s n, 90)**

Sets the Wireless Wake-on-LAN feature.

**Transmission**`(s)(n)( ) (Set ID)( ) (9)(0)( ) (Data)(Cr)`

Data 00: [Off]  
 01: [On]

**Acknowledgment**`(n)( ) (Set ID)( ) (OK/NG)(9)(0)(Data)(x)`

\* This feature may not be available for all models.

**61. [OSD Lock] (Command: k l)**

Sets OSD Lock.

**Transmission**`(k)(l)( ) (Set ID)( ) (Data)(Cr)`

Data 00: OSD Lock  
 01: Unlock OSD Lock

**Acknowledgment**`(l)( ) (Set ID)( ) (OK/NG)(Data)(x)`**62. [HDMI IT Content] (Command: s n, 99)**

Automatically sets the picture mode based on HDMI data.

**Transmission**`(s)(n)( ) (Set ID)( ) (9)(9)( ) (Data)(Cr)`

Data 00: [Off]  
 01: [On]

**Acknowledgment**`(n)( ) (Set ID)( ) (OK/NG)(9)(9)(Data)(x)`

\* This feature may not be available for all models.



**63. [Holiday Setting] (Command: s n, 9b)**

Sets holidays.

**Transmission**

1. (s)(n)( )(Set ID)( )(9)(b)( )(Data1)( )(Data2)( )(Data3)( )(Data4)( )(Data5)( )(Data6)(Cr)
2. (s)(n)( )(Set ID)( )(9)(b)( )(Data1)( )(Data2)(Cr)
3. (s)(n)( )(Set ID)( )(9)(b)( )(Data1)(Cr)

**1. Setting a Holiday**

- Data1 Start year  
00-: 2010-
- Data2 Start month  
01 - 0c: January - December
- Data3 Start date  
01 - 1F: 01-31
- Data4 For how long from the start year/month/date  
01-07: For 1 to 7 days
- Data5 Repetition  
00: None  
01: Every month  
02: Every Year
- Data6 Repeats the schedule on a date/day-of-the-week basis.  
01: On a date basis.  
02: On a day-of-the-week basis.

\* The minimum and maximum values for Data1 differ depending on the product's release year.

\* You can input a value for [Data 6] only when a value has already been set for [Data 5] (every year or every month).

**2. Checking a Schedule**

- Data1 Select the desired schedule.  
F1: Reads the 1st schedule  
F2: Reads the 2nd schedule  
F3: Reads the 3rd schedule  
F4: Reads the 4th schedule  
F5: Reads the 5th schedule  
F6: Reads the 6th schedule  
F7: Reads the 7th schedule

Data2

FF

**3. Deleting a Schedule**

- E0: Deletes all holiday schedules  
E1: Deletes the 1st holiday schedule  
E2: Deletes the 2nd holiday schedule  
E3: Deletes the 3rd holiday schedule  
E4: Deletes the 4th holiday schedule  
E5: Deletes the 5th holiday schedule  
E6: Deletes the 6th holiday schedule  
E7: Deletes the 7th holiday schedule

\* This feature does not work if the current time is not set.

**Acknowledgment**

1. (n)( )(Set ID)( )(OK/NG)(9)(b)(Data1)(Data2)(Data3)(Data4)(Data5)(Data6)(x)
2. (n)( )(Set ID)( )(OK/NG)(9)(b)(f)(1-7)(Data1)(Data2)(Data3)(Data4)(Data5)(Data6)(x)
3. (n)( )(Set ID)( )(OK/NG)(9)(b)(Data1)(x)

\* This feature may not be available for all models.

**64. [UPnP] (Command: s n, 9c)**

Sets UPnPmode.

**Transmission**`(s)(n)( )(Set ID)( )(9)(c)( )(Data)(Cr)`

Data 00: [Off]

01: [On]

**Acknowledgment**`(n)( )(Set ID)( )(OK/NG)(9)(c)(Data)(x)`

\* This feature may not be available for all models.

\* Changing UPnP mode results in a reboot.

**65. [Home Dashboard Lock] (Command: s n, 9d)**

Sets Home Dashboard Lock.

**Transmission**`(s)(n)( )(Set ID)( )(9)(d)( )(Data)(Cr)`

Data 00: Home Dashboard Unlock

01: Home Dashboard Lock

**Acknowledgment**`(n)( )(Set ID)( )(OK/NG)(9)(d)(Data)(x)`

\* This feature may not be available for all models.

**66. [USB Lock] (Command: s n, 9e)**

Sets USB Lock.

**Transmission**`(s)(n)( )(Set ID)( )(9)(e)( )(Data)(Cr)`

Data 00: USB Unlock

01: USB Lock

**Acknowledgment**`(n)( )(Set ID)( )(OK/NG)(9)(e)(Data)(x)`

\* This feature may not be available for all models.

**67. [Wi-Fi Lock] (Command: s n, 9f)**

Sets Wi-Fi Lock.

**Transmission**`(s)(n)( )(Set ID)( )(9)(f)( )(Data)(Cr)`

Data 00: Wi-Fi Unlock

01: Wi-Fi Lock

**Acknowledgment**`(n)( )(Set ID)( )(OK/NG)(9)(f)(Data)(x)`

\* This feature may not be available for all models.

**68. [Screen Share Lock] (Command: s n, a0)**

Sets Screen Share Lock.

**Transmission**`(s)(n)( )(Set ID)( )(a)(0)( )(Data)(Cr)`

Data 00: Screen Share Unlock

01: Screen Share Lock

02: Screen Share Lock (PIN)

**Acknowledgment**`(n)( )(Set ID)( )(OK/NG)(a)(0)(Data)(x)`

\* This feature may not be available for all models.

**69. [Play Backup Content] (Command: s n, a1)**

When there is no input signal, this feature automatically plays the content stored in the device or runs the set app.

**Transmission**`1. (s)(n)( )(Set ID)( )(a)(1)( )(Data1)(Cr)``2. (s)(n)( )(Set ID)( )(a)(1)( )(Data1)(Data2)(Cr)`

1. Disabling Play Backup Content.

Data1 00: Off

2. Setting Play Backup Content to Auto Capture Images

Data1 01: Auto Capture Images

Data2 01: 30 minutes

02: 1 hour

03: 2 hours

04: 3 hours

3. Setting Play Backup Content to Media Storage

Data1 02: Media Storage

4. Setting Play Backup Content to SuperSign Content

Data1 03: SuperSign Contents

5. Set to SI App/Play via URL

Data 1 04: [SI App/Play via URL]

**Acknowledgment**`1. (n)( )(Set ID)( )(OK/NG)(a)(1)(Data1)(x)``2. (n)( )(Set ID)( )(OK/NG)(a)(1)(Data1)(Data2)(x)`

\* This feature may not be available for all models.

**70. [Booting Logo Image] (Command: s n, a3)**

Sets Booting Logo Image.

**Transmission**`(s)(n)( )(Set ID)( )(a)(3)( )(Data)(Cr)`

Data 00: [Off]

01: [On]

**Acknowledgment**`(n)( )(Set ID)( )(OK/NG)(a)(3)(Data)(x)`

\* This feature may not be available for all models.

**71. [SoftAP] (Command: s n, a4)**

Sets SoftAP Mode.

**Transmission**`(s)(n)( )(Set ID)( )(a)(4)( )(Data)(Cr)`

Data 00: [Off]

01: [On]

**Acknowledgment**`(n)( )(Set ID)( )(OK/NG)(a)(4)(Data)(x)`

\* This feature may not be available for all models.

**72. Play Saved Internal Media (Command: s n, a8)**

Plays media files saved on internal storage. Internal storage media: videos and images stored on the Projector's internal storage after being exported via Contents Management Player.

\* Not applicable: Template content, SuperSign content, and playlist content.

**Transmission**`(s)(n)( )(Set ID)( )(a)(8)( )(Data)(Cr)`

Data 01: Play

**Acknowledgment**`(n)( )(Set ID)( )(OK/NG)(a)(8)( )(Data)(x)`

\* This feature may not be available for all models.

**73. [No Signal Image] (Command: s n, a9)**

Sets the No Signal Image feature.

**Transmission**`(s)(n)( )(Set ID)( )(a)(9)( )(Data)(Cr)`

Data 00: [Off]

01: [On]

**Acknowledgment**`(n)( )(Set ID)( )(OK/NG)(a)(9)(Data)(x)`

\* This feature may not be available for all models.

**74. [Audio Out] (Command: s n, aa)**

Sets Audio Out to Off/Variable/Fixed.

**Transmission**`(s)(n)( )(Set ID)( )(a)(a)( )(Data)(Cr)`

Data 00: [Off]

01: [Variable]

02: [Fixed]

**Acknowledgment**`(n)( )(Set ID)( )(OK/NG)(a)(a)(Data)(x)`

\* This feature may not be available for all models.

**75. [DPM (Standby Mode) Wake Up Control] (Command: s n, 0b)**

Controls the DPM Wake Up Control settings.

**Transmission**`(s)(n)( )(Set ID)( )(0)(b)( )(Data)(Cr)`

Data 00: [Clock]

01: [Clock+DATA]

**Acknowledgment**`(n)( )(Set ID)( )(OK/NG)(0)(b)(Data)(x)`

\* This feature may not be available for all models.

**76. [Apply to all inputs] (Command: s n, 52)**

Apply the video mode and low value of the current input to the same video value of all inputs.

**Transmission**`(s)(n)( )(Set ID)( )(5)(2)( )(Data)(Cr)`

Data 01: Apply

**Acknowledgment**`(n)( )(Set ID)( )(OK/NG)(5)(2)(Data)(x)`

\* This feature may not be available for all models.

\* Other commands do not work for a certain time after applying.

**77. [Timer Power On] Scheduling (Command: f d)**

Sets On Timer settings.

Depending on the model, the number of schedules for Timer Power On can be either 16 or 21.

**Transmission****(f)(d)( )(Set ID)( )(Data1)( )(Data2)( )(Data3)(Cr)**

Data1

1. To f1h ~ fffh, a1h ~ a6h (data reading)

F1 ~ FF: Read data for the 1st to 15th times for Timer Power On.

A1 ~ A6: Read data for the 16th to 21st times for Timer Power On.

2. e1h ~ effh, b1h~b6h (Deletes one index), e0h (Deletes all indexes)

E0: Delete all Timer Power On's

E1 ~ EF: Delete the 1st to 15th times for Timer Power On.

B1 ~ B6: Delete the 16th ~ 21st times for Timer Power On.

3. 01h to 0ch (Timer Power On days setting)

02: Repeat Daily

03: Repeat from Monday to Friday

04: Repeat from Monday to Saturday

05: Repeat from Saturday to Sunday

06: Repeat on Sunday

07: Repeat on Monday

08: Repeat on Tuesday

09: Repeat on Wednesday

0A: Repeat on Thursday

0B: Repeat on Friday

0C: Repeat on Saturday

Data2 00-17: 00 - 23 hours

Data3 00-3B: 00 - 59 minutes

\* To read or delete a Timer Power On you have set, [Data2] [Data3] must be set to FFH.

Example 1: fd 01 f1 ffff - Reads the 1st index data in Timer Power On.

Example 2: fd 01 e1 ffff - Reads the 1st index data in Timer Power On.

Example 3: fd 01 04 02 03 - Sets the Timer Power On as Monday - Saturday 02:03.

\* This feature only works when Clock 1 (year/month/day) and Clock 2 (hour/minute/second) have been set.

**Acknowledgment****(d)( )(Set ID)( )(OK/NG)(Data1)(Data2)(Data3)(x)****78. [Timer Power Off] Scheduling (Command: f e)**

Sets Off Timer settings.

Depending on the model, the number of schedules for Timer Power Off can be either 16 or 21.

**Transmission****(f)(e)( )(Set ID)( )(Data1)( )(Data2)( )(Data3)(Cr)**

Data1

1. To f1h ~ fffh, a1h ~ a6h (data reading)

F1 ~ FF: Read data for the 1st to 15th times for Timer Power On.

A1 ~ A6: Read data for the 16th to 21st times for Timer Power On.

2. e1h ~ effh, b1h ~ b6h (Deletes one index), e0h (Deletes all indexes)

E0: Delete all Timer Power Off's

E1 ~ EF: Delete the 1st to 15th times for Timer Power Off.

B1 ~ B6: Delete the 16th ~ 21st times for Timer Power Off.

3. 01h to 0ch (Timer Power Off days setting)

02: Repeat Daily

03: Repeat from Monday to Friday

04: Repeat from Monday to Saturday

05: Repeat from Saturday to Sunday

06: Repeat on Sunday

07: Repeat on Monday

08: Repeat on Tuesday

09: Repeat on Wednesday

0A: Repeat on Thursday

0B: Repeat on Friday

0C: Repeat on Saturday

Data2 00-17: 00 - 23 hours

Data3 00-3B: 00 - 59 minutes

\* To read or delete a Timer Power Off you have set, [Data2] [Data3] must be set to FF.

Example 1: fe 01 f1 ffff - Reads the 1st index data in Timer Power Off.

Example 2: fe 01 e1 ffff - Reads the 1st index data in Timer Power Off.

Example 3: fe 01 04 02 03 - Sets the Timer Power Off as Monday - Saturday 02:03.

\* This feature only works when Clock 1 (year/month/day) and Clock 2 (hour/minute/second) have been set.

**Acknowledgment****(e)( )(Set ID)( )(OK/NG)(Data1)(Data2)(Data3)(x)**

**79. LCIN008 Control (Command: s n, b8)**

It controls the LCIN008 device.

**Transmission**

(s)(n)( )(Set ID)( )(b)(8)( )(Data1)(Data2)(Cr)

Data 1 00: LCIN008 Power

01: LCIN008 Brightness

Data 2

1. For Power

0 x 00: Off

0 x 01: On

2. For Brightness

0 x ff: Read

0 x 00 ~ 0 x 64: Applies a set value

**Acknowledgment**

(n)( )(Set ID)( )(OK/NG)(b)(8)(Data1)(Data2)(x)

\* This feature may not be available for all models.

\* Other commands do not work for a certain time after applying.

**80. [Transfer Control] (Command: s n, cb)**

It transfers the command to RS232C out.

**Transmission**

(s)(n)( )(Set ID)( )(c)(b)( )(Data)(Cr)

Data Data that goes out to RS232C out

**Acknowledgment**

(n)( )(Set ID)( )(OK/NG)(c)(b)(Data)(x)

Data Response value of Data transferred to RS232C out

\* This feature may not be available for all models.

\* Other commands do not work for a certain time after applying.

**81. Multichannel (Command: s n, 76)**

It changes the channel.

**Transmission**

(s)(n)( )(Set ID)( )(7)(6)( )(Data)(Cr)

Data 01 - 09: Channel to switch to

**Acknowledgment**

(n)( )(Set ID)( )(OK/NG)(7)(6)(Data)(x)

\* This feature may not be available for all models.

**82. Change SetID (Command: j x)**

Changes and checks SetID.

Read only

**Transmission**

(j)(x)( )(Set ID)( )(Data)(Cr)

Data FF: Check the value of SetID

The returned value is indicated as a value of hexadecimal numbers corresponding to the ASCII code value.

(Return when SetID is 1: x 01 OK31x

Return when SetID is 1000: x 3e8 OK31303030x)

**Acknowledgment**

(x)( )(Set ID)( )(OK/NG)(Data)(x)

\* It works even if the SetID does not match.

\* This feature may not be available for all models.

**83. [Gamma] (Command: s n, ad)**

Sets Gamma Mode.

**Transmission**

(s)(n)( )(Set ID)( )(a)(d)( )(Data)(Cr)

Data 00: [Low](1.9)

01: [Medium](2.2)

02: [High1](2.4)

03: [High2](BT.1886)

**Acknowledgment**

(n)( )(Set ID)( )(OK/NG)(a)(d)(Data)(x)

\* This feature may not be available for all models.

**84. [Black Level] (Command: s n, ae)**

It sets the Black Level mode.

**Transmission**

(s)(n)( )(Set ID)( )(a)(e)( )(Data)(Cr)

Data 00: Low

01: High

02: Auto

**Acknowledgment**

(n)( )(Set ID)( )(OK/NG)(a)(e)(Data)(x)

\* This feature may not be available for all models.

**85. [UHD Deep Color] (Command: s n, af)**

It sets the UHD Deep Color mode for each input.

**Transmission**

(s)(n)( ) (Set ID)( )(a)(f)( )(Data1)( )(Data2)(Cr)

Data 1 90: HDMI1  
91: HDMI2  
C0: DISPLAYPORT  
Data2 00: [Off]  
01: [On]

**Acknowledgment**

(n)( ) (Set ID)( )(OK/NG)(a)(f)(Data1)(Data2)(x)

\* This feature may not be available for all models.

**86. [Sync Mode] (Command: s n, b0)**

Sets Sync Mode.

**Transmission**

(s)(n)( ) (Set ID)( )(b)(0)( )(Data)(Cr)

Data 00: [Slave Mode]  
01: [Master Mode]

**Acknowledgment**

(n)( ) (Set ID)( )(OK/NG)(b)(0)(Data)(x)

\* This feature may not be available for all models.

**87. [Input Manager] (Command: s n, b1)**

It sets labels by input.

**Transmission**

(s)(n)( ) (Set ID)( )(b)(1)( )(Data1)( )(Data2)(Cr)

Data 1 90: HDMI1  
91: HDMI2  
92: HDMI3/HDBaseT  
C0: DISPLAYPORT  
Data2 00: DTV  
01: PC

**Acknowledgment**

(n)( ) (Set ID)( )(OK/NG)(b)(1)(Data1)(Data2)(x)

\* This feature may not be available for all models.

**88. [PC Power Control] (Command: s n, 8b)**

It sets the PC Power Control mode.

**Transmission**

(s)(n)( ) (Set ID)( )(8)(b)( )(Data)(Cr)

Data 00: [Disable]  
01: [Sync(On)]  
02: [Sync(On/Off)]

**Acknowledgment**

(n)( ) (Set ID)( )(OK/NG)(8)(b)(Data)(x)

\* This feature may not be available for all models.

**89. [Average Picture Level Auto Control] (Command: s n, be)**

Sets Average Picture Level Auto Control.

**Transmission**

(s)(n)( ) (Set ID)( )(b)(e)( )(Data)(Cr)

Data 00: [Off]  
01: [On]

**Acknowledgment**

(n)( ) (Set ID)( )(OK/NG)(b)(e)(Data)(x)

\* This feature may not be available for all models.

**90. [Stereo Mode] (Command: s n, c2)**

Controls Stereo Mode.

**Transmission**

(s)(n)( ) (Set ID)( )(c)(2)( )(Data)(Cr)

Data 00: Left/Right  
01: Left/Left  
02: Right/Right

**Acknowledgment**

(n)( ) (Set ID)( )(OK/NG)(c)(2)(Data)(x)

\* This feature may not be available for all models.

**91. [HDR Picture Mode] (Command: s n, c4)**

Selects a HDR Picture Mode.

**Transmission**`(s)(n)( ) (Set ID)( ) (c)(4)( ) (Data)(Cr)`

Data 00: Mall/QSR

01: General

02: Gov./Corp.

04: Education, Screen Game

**Acknowledgment**`(n)( ) (Set ID)( ) (OK/NG)(c)(4)(Data)(x)`

\* Depending on the model, some picture modes may not be supported.

\* It works only when the HDR content is running.

**92. [Dynamic Tone Mapping] (Command: s n, c5)**

Selects Dynamic Tone Mapping.

**Transmission**`(s)(n)( ) (Set ID)( ) (c)(5)( ) (Data)(Cr)`

Data 00: [Off]

01: [On]

**Acknowledgment**`(n)( ) (Set ID)( ) (OK/NG)(c)(5)(Data)(x)`

\* Depending on the model, some picture modes may not be supported.

\* It works only when the HDR content is running.

**93. [Change Password] (Command: s n, a7)**

Changes password.

**Transmission**`(s)(n)( ) (Set ID)( ) (a)(7)( ) (Data1)(Data2)(Data3)``(Data4)(Data5)(Data6)( ) (Data7)(Data8)(Data9)``(Data10)(Data11)(Data12)(Cr)`

Data 1-6: 0-9(Previously set password)

Data 7-12: 0-9(New password)

**Acknowledgment**`(n)( ) (Set ID)( ) (OK/NG)(a)(7)( ) (Data1)(Data2)(Data3)``(Data4)(Data5)(Data6)( ) (Data7)(Data8)(Data9)``(Data10)(Data11)(Data12)(x)`

\* This feature may not be available for all models.

**94. [Color Calibration] (Command: s n, d6)**

Selects Colour Calibration.

**Transmission**`(s)(n)( ) (Set ID)( ) (d)(6)( ) (Data)(Cr)`

Data 00: Off

01: On

**Acknowledgment**`(n)( ) (Set ID)( ) (OK/NG)(d)(6)(Data)(x)`

\* It may not be supported depending on the model.

**95. [Quick Start+] (Command: s n, 0e)**

Selects Quick Start+ Mode.

**Transmission**`(s)(n)( ) (Set ID)( ) (0)(e)( ) (Data)(Cr)`

Data 00: Off

01: On

**Acknowledgment**`(n)( ) (Set ID)( ) (OK/NG)(0)(e)(Data)(x)`

\* It may not be supported depending on the model.

# TROUBLESHOOTING

Please check the list below when you experience the following symptoms during use of the product. It may not be a failure.

Information on customer service for product problems is available in **SETTINGS / ⚙️** → [General] → [System Information] on the projector.

## Troubleshooting Power/Remote Issues

Please check the list below when you experience the following symptoms during use of the product. It may not be a failure.

### **I cannot turn on the Projector.**

- Please make sure your projector power plug is correctly connected to the outlet.
- If you are using a multi-outlet, check if it is working properly. To check whether a power strip is working properly, plug the projector's power plug directly to a wall outlet and observe its operation.
- Try to power on using the button on your projector set.
- If you are using a standby power cut-off switch, turn off the standby power cut-off and turn the power on again.

### **The power is on, but the screen does not turn on for some time.**

- It is not a sign of defect because the screen may turn on later to prevent possible noise from the screen when the power is turned on.

### **I cannot turn the projector on with the remote control.**

- Please make sure your projector power plug is correctly connected to the outlet.
- Replace the batteries in the remote control. (Use alkaline batteries.)
- Check whether there are any obstacles in front of the projector's remote control sensor. Sound bars or other obstacles placed in front of the projector's lower receiver may obstruct IR signal reception.

### **The power turns off suddenly.**

- Make sure [Power Off Timer] is set.
- There is also a chance that the internal protection circuitry has activated because the internal temperature of the product has risen unusually or excessively.



## Troubleshooting Screen Issues

Please check the list below when you experience the following symptoms during use of the product. It may not be a failure.

### It says there is no signal on the screen.

- Check if the cable connected to the external device is properly connected to the projector.
- Go to **INPUT** button to choose the connected input.
- The signal from the PC (Graphics card) is out of the vertical or horizontal frequency range of the product. Adjust the frequency range by referring to the specifications in this manual.

### Part of the projected image is cut out.

- Check if the graphics card resolution and frequency are supported by the product. If the frequency exceeds the supported range, use PC settings to set the resolution to the recommended value.

### The screen shakes after the momentary appearance of vertical/horizontal lines and net pattern.

- Use a different wall outlet than where you plug wireless telephones, hairdryers, electrical drills etc. The problem is caused by high-frequency electronic devices such as another projector or strong electromagnetic sources.

### I don't see anything, or the image keeps flickering when I try to connect the HDMI cable.

- Check whether your HDMI® cable is compliant with the specifications. You may experience flickering or a blank screen if the HDMI® cable is faulty (bent, broken).
- Make sure that the cable is correctly connected to the port. Bad or loose contact may cause display problems on the screen.
- Turn off the Deep Color function for each input (HDMI1, HDMI2, DISPLAYPORT) at **SETTINGS / ⚙️** → [Display] → [Advanced Setting] → [UHD Deep Color].
  - Some models may not be supported. Some input signals may not be available for all models.

### The screen looks too dim or dark.

- Change to the desired video mode at **SETTINGS / ⚙️** → [Display] → [Picture Mode].
- Change the brightness to Minimum Energy-Saving at **SETTINGS / ⚙️** → [Display] → [Advanced Setting] → [Energy Saving].

### The screen is in black and white or displaying strange colors.

- Check the input mode or cable connection.
- Go to **INPUT** button to choose the connected input.

## Troubleshooting Sound Issues

Please check the list below when you experience the following symptoms during use of the product. It may not be a failure.

### **The screen is fine, but it does not play any sound.**

- See if the audio cable is connected properly.
- Adjust the volume of the product or external device.
- See if the sound is set properly.

### **Sound is too dull.**

- Select the appropriate equalizer sound.

### **Sound is too low.**

- Adjust the volume of the product or external device.

### **There is no sound coming from one of the speakers.**

- Adjust the balance as necessary with the Navigation button in **SETTINGS** /  → [Sound] → [Sound Mode] → [Balance].

## Troubleshooting PC Connection Issues

Please check the list below when you experience the following symptoms during use of the product. It may not be a failure.

### **The screen remains blank after it is connected to a PC.**

- Check that the PC is properly connected to the projector.
- Turn the projector off and back on using the remote control.
- Restart the PC with the projector on.
- Make sure that the output resolution set on the PC is set to the HDMI-PC supported resolution of the projector.
- To use dual monitors, check that the PC or notebook supports dual-monitor mode.
- Reconnect the high speed HDMI® cable.
- If you have connected the RGB output port of your PC to the HDMI input port or your projector. You need an RGB to HDMI gender.  
You will not see anything on the screen if you use an HDMI to RGB gender.

### **The screen is cut off or moved to one side after it is connected to a PC.**

- Set the PC's resolution to one supported by the projector.
- Set the connected HDMI device's name to PC.
  - Change to PC at **SETTINGS / ⚙** → [General] → [Advanced Setting] → [Input Manager].

### **The sound does not play when the PC is connected with an HDMI® cable.**

- In PC settings, set Control Panel → Sound → Play → LG projector as the default device.
- Consult your manufacturer on whether your graphics card supports HDMI audio output.

## Troubleshooting Movie Playback Issues

Please check the list below when you experience the following symptoms during use of the product. It may not be a failure.

For more information about supported files, see “Supported Photo & Video Files”.

### **I cannot find a file in the [Player].**

- Check that the files on the USB storage device can be read by a PC.
- Check that the file extension is supported.

### **I get a message saying “This file is not supported” or the sound is playing normally but the video is not.**

- Check that the file plays without any problems on a PC’s video player. Also check for file damage.
- Check that the file extension is supported.
- Check that the resolution is supported.
- Check that the video codec is supported.
- Check that the frame rate is supported.

### **I get a message saying “This audio is not supported” or the video is playing normally but the audio is not.**

- Check that the file plays without any problems on a PC’s video player. Also check for file damage.
- Check that the file extension is supported.
- Check that the audio codec is supported.
- Check that the bit rate is supported.
- Check that the sample rate is supported.
- Check that the audio channel separation is supported.

### **I cannot see the subtitles.**

- Subtitles are not supported.

### **My USB storage device is not recognised when connected.**

- Check whether it is a USB storage device supported by the projector.

## Troubleshooting Network Connection Issues

Please check the list below when you experience the following symptoms during use of the product. It may not be a failure.

Before connecting to a wireless network, check the name and password of the Wi-Fi device to connect.

You can check the network connection status as shown below.

- **SETTINGS** / ⚙️ → [General] → [Network] → [Wired Connection (Ethernet)]
- **SETTINGS** / ⚙️ → [General] → [Network] → [Wi-Fi Connection] → [Advanced Wi-Fi Settings]



### When X appears next to projector

- Check the projector or the AP (Router).
- Check the connection status of the projector, AP (Router) and Cable Modem.
- Power off and power on in the following order;
  1. The Cable Modem, wait for the Cable Modem to reset.
  2. Turn your cable modem off and back on, and wait for the device to reset.
  3. The projector.
- If you want to establish a wired LAN connection check whether an IP address can be obtained from your router properly. If you are setting up your network manually check whether all settings are correct.
- If you want to establish a wireless connection check the following points as well.
  1. Set your router's SSID (network name) or wireless channel.
  2. Set your router's security key.  
If you do not know this setting, check the router's instruction manual and the manual provided by the Internet provider. If you are still not sure, contact the router company or the Internet company.
- If you are using a static IP, enter the IP directly.



### When X appears next to Gateway

- Check the AP (Router) or consult your Internet service provider.
- Unplug the power cord of the AP (Router), Cable Modem, wait 10 seconds. Reapply power.
- Initialize (Reset) on the AP (Router) or Cable Modem.
- Check the AP (Router) manufacturer's website to make sure your router has the latest firmware version installed.
- If you do not know this setting, check the router's instruction manual and the manual provided by the Internet provider. If you are still not sure, contact the router company or the Internet company.



### When X appears next to DNS

- Check the AP (Router) or consult your Internet service provider.
- Unplug the power cord of the AP (Router), Cable Modem, wait 10 seconds. Reapply power.
- Initialize (Reset) on the AP (Router) or Cable Modem.
- Check that the MAC address of the projector/AP (Router) is registered with your Internet service provider. (The MAC address displayed on the pane of the network status window should be registered with your Internet service provider.)
- If you do not know this setting, check the router's instruction manual and the manual provided by the Internet provider. If you are still not sure, contact the router company or the Internet company.

