

STRONG.  
INNOVATIVE.  
COMMUNICATIONS  
SOLUTIONS.™

P R O D U C T   C A T A L O G

  
OPTICAL CABLE CORPORATION



# OCC. MORE THAN CABLE. COMMUNICATIONS SOLUTIONS.

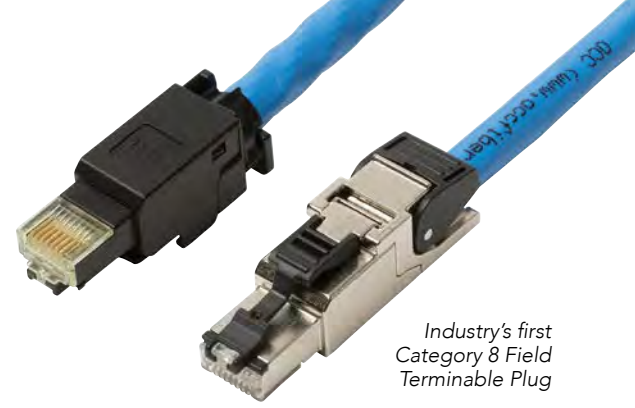

Industry's first  
Category 8 Field  
Terminable Plug

OCC's Lightweight Reel Stand for  
military deployable communications



Ruggedized fiber optic enclosures  
with MHC® III technology



Procyon® – high density  
data center solutions



Passive Optical LAN for simplified  
and cost effective enterprise networks



RTC/RTS fiber optic enclosures  
designed for easy installations



MARS® – numerous options for  
deploying field communication systems



Robust connections for fiber  
or copper installations

OCC began by revolutionizing the fiber optic cable industry. Today, OCC is changing the way the world communicates.

Since 1983, OCC's innovative fiber optic cable designs took the communications industry by storm — bringing the power of fiber optics to harsh environments never before thought possible.

This legendary spirit of innovation has enabled us to create a broad and growing suite of top-tier, integrated connectivity and cabling solutions used everywhere from buildings, campuses and data centers to sporting venues, industrial facilities and harsh environments.

From connectivity to cable. From copper to fiber optics. If you need to communicate. You want OCC.

**Today's OCC. Strong. Innovative. Communications Solutions.™**

<b>1.0 Corporate Overview</b>		
Company Narrative		2
Certified Installer/MDIS Information		4
Quality Assurance		4
Warranty Information		4
<b>2.0 OCC Solutions</b>		
2.0 Overview		6
2.1 Data Center Solutions		7
2.2 Enterprise Solutions		7
2.3 Industrial Solutions		8
2.4 Broadcast Solutions		8
2.5 Security & Monitoring		10
2.6 Oil & Gas		10
2.7 Military Solutions		12
2.8 Mining Solutions		13
2.9 Transportation Solutions		14
<b>3.0 Discover the Difference</b>		
3.1 Advanced End-to-End Network Solutions		16
3.2 Network Innovations and Featured Products		17
<b>A.3 Product Information — Appendix</b>		21
A.3.1 Laser Ultra-Fox™ Cables		22
A.3.2 Fiber Buffer Options		23
A.3.3 Fiber Cable Configurator		24
A.3.4 Laser Ultra Fox™ Fiber Performance		25
A.3.5 Ultra Fox™ Plus Fiber Performance		26
A.3.6 Choosing the Right Cabling System		28
A.3.7 Outer Cable Jacket Materials		30
A.3.8 Extended Performance Warranty		31
A.3.9 Choosing the Right Fiber Optic Enclosure		34
A.3.10 Choosing the Right Connector		35
<b>4.0 Fiber Optic Cable – Enterprise</b>		
<b>4.1 INDOOR CABLES (DATA CENTER AND ASSEMBLY)</b>		
4.1a A-Series Assembly – Riser, Plenum and LSZH IEC Rated Cables		39
4.1b A-Series Micro-Assembly – Riser, Plenum and LSZH Cables (2.0mm)		41
4.1c A-Series Micro-Assembly – Riser, Plenum and LSZH Cables (1.6mm)		43
4.1d DP-Series Assembly – Mini-Round Duplex: Riser, Plenum, and LSZH Cables		45
4.1e HD-Series – High-Density Plenum Rated Cables		47
4.1f HD-Series – High-Density Riser and LSZH IEC Rated Cables		50
4.1g Furcation Tubing		52
<b>4.2 INDOOR/OUTDOOR CABLES</b>		
4.2a D-Series Distribution – Riser Rated Cables		54
4.2b D-Series Distribution – Plenum Rated Cables		56
4.2c D-Series Distribution – LSZH OFNR-LS and IEC Rated Cables		59
4.2d B-Series Breakout – Riser Rated Cables		61
4.2e B-Series Breakout – Plenum Rated Cables		64
4.2f B-Series Breakout – LSZH OFNR-LS and IEC Rated Cables		66
4.2g B-Series Breakout – Riser Rated Tray Cables		68
4.2h G-Series Subgrouping – Riser Rated Cables		71
4.2i G-Series Subgrouping – Plenum Rated Cables		73
4.2j G-Series Subgrouping – Riser Rated Tray Cables		75
4.2k HC-Series – High Density Riser Rated Cables		77
<b>4.3 INDOOR/OUTDOOR ARMORED CABLES</b>		
4.3a D-Series Distribution – Interlocking Armor (ILA) Riser Rated Cables		79
4.3b D-Series Distribution – Interlocking Armor (ILA) Plenum Rated Cables		81
4.3c D-Series Distribution – Corrugated Steel Tape Armored Riser Rated Cables		83
4.3d D-Series Distribution – Rodent Deterrent (FRP) Riser Rated Cables		85
4.3e B-Series Breakout – Interlocking Armor (ILA) Riser Rated Cables		87
4.3f B-Series Breakout – Interlocking Armor (ILA) Plenum Rated Cables		89
4.3g B-Series Breakout – Rodent Deterrent (FRP) Riser Rated Cables		91
4.3h G-Series Subgrouping – Interlocking Armor (ILA) Riser Rated Cables		93
4.3i G-Series Subgrouping – Interlocking Armor (ILA) Plenum Rated Cables		95
4.3j G-Series Subgrouping – Rodent Deterrent (FRP) Riser Rated Cables		97
<b>4.4 INDOOR/OUTDOOR HYBRID CABLES</b>		
4.4a CX-Series Hybrid – Copper/Fiber Riser and Plenum Rated Cables		99
4.4b CX-Series Hybrid – UL 1277 Tray Cables		101
<b>4.5 OUTDOOR AND CAMPUS CABLES</b>		
4.5a D-Series Distribution – Outside Plant Cables		102
4.5b D-Series Distribution – Corrugated Steel Tape (CST) Armored Cables		104
4.5c B-Series Breakout – Corrugated Steel Tape (CST) Armored Cables		106
4.5d G-Series Subgrouping – Corrugated Steel Tape (CST) Armored Cables		108
4.5e HC-Series – High Density Outdoor Cables		110
4.5f MX-Series – Figure-8 Messenger Cables		112
4.5g RM-Series – Round Messenger Cables		114
<b>4.6 CABLE INFORMATION</b>		
4.6a Laser Ultra-Fox Fiber Performance		116
4.6b Ultra-Fox Fiber Performance		117



## 5.0 Fiber Optic Cable – Harsh Environment

### 5.1 OUTDOOR CABLES

5.1a	A-Series – Deployable Single-Fiber Cables	121
5.1b	D-Series Distribution – Arctic Fox and Arctic Fox Plus Cables	123
5.1c	B-Series Breakout – Festoon Cables	125
5.1d	CX Series – Hybrid Fiber/Copper Deployable Cables	126

### 5.2 MILITARY CABLES

5.2a	D-Series Distribution – Mil-Tac Cables	127
5.2b	D-Series Distribution – Mil-Tac Rodent Deterrent (FRP) Cables	130
5.2c	DOD QPL-85045 Qualified Products	133
5.2d	Military Tactical Fiber Optic Cables for Extreme Environments	135
5.2e	B-Series Breakout – Mil-Tac Cables	136
5.2f	B-Series Breakout – Mil-Tac Rodent Deterrent (FRP) Cables	139

### 5.3 BROADCAST DEPLOYABLE CABLES

5.3a	D-Series Distribution – Field Broadcast Cables	142
5.3b	D-Series Distribution – Field Broadcast Rodent Deterrent (FRP) Cables	145
5.3c	B-Series Breakout – Field Broadcast Cables	148
5.3d	B-Series Breakout – Field Broadcast Rodent Deterrent (FRP) Cables	150
5.3e	CX-Series – Deployable Hybrid Copper/Fiber Cables	153
5.3f	SMPTE Essential Cables	154
5.3g	SMPTE Premium Cables	155
5.3h	SMPTE Tactical Cables	156
5.3i	SMPTE Flex Cables	157
5.3j	SMPTE LSZH Cables	158

### 5.4 MINING CABLES

5.4a	D-Series Distribution – MSHA-Rated Mining Cables	159
5.4b	D-Series Distribution – MSHA-Rated Deployable Cables	161
5.4c	B-Series Breakout – MSHA-Rated Mining Cables	163
5.4d	B-Series Breakout – MSHA-Rated Deployable Cables	165
5.4e	G-Series Subgrouping - MSHA-Rated Mining Cables	167
5.4f	G-Series Subgrouping – MSHA-Rated Signal Cables	169

### 5.5 SHIPBOARD CABLES

5.5a	D-Series Distribution – LSZH ABS-Approved Cables	171
5.5b	D-Series Distribution – LSZH Braided-Armor ABS-Approved Cables	173
5.5c	DNV-Certified Shipboard Cables	175
5.5d	B-Series Breakout – LSZH ABS-Approved Cables	177
5.5e	B-Series Breakout – LSZH Braided-Armor ABS-Approved Cables	179
5.5f	Pierside Cables	181

### 5.6 INDUSTRIAL CABLES

5.6a	B-Series Breakout – Riser Rated Tray Cables	183
5.6b	G-Series Subgrouping – Riser Rated Tray Cables	186
5.6c	D-Series Distribution – Interlocking Armor (ILA) Riser Rated Cables	188
5.6d	D-Series Distribution – Interlocking Armor (ILA) Plenum Rated Cables	190
5.6e	B-Series Breakout – Interlocking Armor (ILA) Riser Rated Cables	192
5.6f	B-Series Breakout – Interlocking Armor (ILA) Plenum Rated Cables	194
5.6g	G-Series Subgrouping – Interlocking Armor (ILA) Riser Rated Cables	196
5.6h	G-Series Subgrouping – Interlocking Armor (ILA) Plenum Rated Cables	198
5.6i	HC-Series – High Density Riser Rated Cables	200
5.6j	CX-Series Hybrid – Copper/Fiber Riser and Plenum Rated Cables	202
5.6k	CX-Series Hybrid – UL 1277 Tray Cables	204

### 5.7 FIBER TO ANTENNA CABLES

5.7a	FTTA	205
------	------	-----

### 5.8 CABLE INFORMATION

5.8a	Laser Ultra-Fox Fiber Performance	206
5.8b	Ultra-Fox Fiber Performance	207

## 6.0 Fiber Optic Connectivity

### 6.1 ENTERPRISE FIBER OPTIC ENCLOSURES AND ADAPTER PLATES

6.1a	Passive Optical Lan	212
6.1b	RTC and RTS Series Enclosures – Rack Mount Fiber Enclosures	216
6.1c	Specialty Enclosures	218
6.1d	BHP Series	219
6.1e	RSC Splicing Enclosures	220
6.1f	Procyon Blade Enclosures	221
6.1g	R-Series Splice Kits	225
6.1h	Recessed Brackets	226
6.1i	WTC Cabinets – Wall Mount Fiber Enclosures	227
6.1j	W-Series Splice Kits	228
6.1k	Fiber Zone Distribution Enclosures	229
6.1l	Adapter Plates	230
6.1m	Keyed Adapter Plates	234

### 6.2 ENTERPRISE CONNECTORS

6.2a	Anaerobic Connectors	235
6.2b	Xpress Connector	236

*(See Section 8.8a for Multimedia Adapters and Connectors)*

### 6.3 ENTERPRISE FIBER OPTIC CABLE ASSEMBLIES

6.3.a	Enterprise Fiber Optic Jumpers	237
6.3.a1	Keyed LC	238
6.3.a2	Secure LC	239
6.3b	Enterprise Fiber Optic Pigtailed	241
6.3c	MT Cable Assemblies	242
6.3d	Made-to-Order Standard Trunk Cables	243

### 6.4 ENTERPRISE PRE-TERMINATED ENCLOSURES

6.4a	Procyon Fiber Enclosure	244
6.4b	Procyon MTP-MTP Cassettes	246
6.4c	Procyon MTP-LC Cassettes	247
6.4d	MT Cassettes	248
6.4e	RTC1UB Enclosures	249
6.4f	Loaded Enclosures	250

### 6.5 HARSH ENVIRONMENT ENCLOSURES

6.5a	DIN-RAIL System Enclosures	251
6.5b	NEMA 3 Enclosures	253
6.5c	NEMA 4X Enclosures	254
6.5d	Fiberguard Enclosures	255

### 6.6 HARSH ENVIRONMENT CONNECTORS

6.6a	M29504/14 and M29504/15 Fiber Optic Termini	257
6.6b	Single Terminus Connectors	259
6.6c	L-JACK Connectors	263
6.6d	COTS 83526 Connectors	267
6.6e	COTS 83526 Adapters and Loopbacks	273
6.6f	Pierside Connectors	275
6.6g	F-LINK Interconnect Solution	279

### 6.7 HARSH ENVIRONMENT CABLE ASSEMBLIES

6.7a	F-LINK Cable Assemblies	285
6.7b	Pierside Cable Assemblies	290
6.7c	COTS-83526 Cable Assemblies	294
6.7d	EZ-Mate Cable Assemblies	298
6.7e	MHC II Cable Assemblies	302
6.7f	MHC III Cable Assemblies	308
6.7g	Expanded Beam Cable Assemblies	312
6.7h	IRIS Cable Assemblies	314
6.7i	L-JACK Cable Assemblies	318
6.7j	Single Terminus (ST) Assemblies	323
6.7k	Made-to-Order Multifiber Trunk Cable Assemblies	327

### 6.8 TOOLS

6.8a	Cleaners and Tools	329
6.8b	Cleaning Kits	330

### 6.9 CABLE INFORMATION

6.9a	Laser Ultra-Fox Fiber Performance	206
6.9b	Ultra-Fox Fiber Performance	207

## 7.0 Copper Cables — Enterprise

### 7.1 CATEGORY 6A

7.1a	UTP Copper Cable	334
7.1b	F/UTP Copper Cable	336

### 7.2 CATEGORY 6

7.2a	High Performance UTP Copper Cable	338
7.2b	UTP Copper Cable	340
7.2c	Outside Plant Copper Cable	342

### 7.3 CATEGORY 5E

7.3a	UTP Copper Cable	344
------	------------------	-----

### 7.4 COPPER CABLE FIBER PERFORMANCE

7.4a	Choosing the Right Cabling System	346
------	-----------------------------------	-----



## 8.0 Copper Connectivity

### 8.1 CATEGORY 6A

8.1.a	Outlet Jacks and Direct Attach Plugs	352
8.1.b	Patch Panels	356
8.1.c	Modular Patch Cords	357

### 8.2 CATEGORY 6

8.2.a	Outlet Jacks	358
8.2.b	Patch Panels	360
8.2.c	Modular Patch Cords	361
8.2.d	110 Blocks	362

### 8.3 CATEGORY 5E

8.3.a	Outlet Jacks	363
8.3.b	Patch Panels	365
8.3.c	Modular Patch Cords	367
8.3.d	110 Blocks	368

### 8.4 VOICE PRODUCTS

8.4.a	Outlet Jacks	369
8.4.b	Patch Panels	370

### 8.5 MULTIMEDIA PANELS

8.5.a	Multimedia Panels	371
-------	-------------------	-----

### 8.6 HARSH ENVIRONMENT COPPER PRODUCTS

8.6.a	R-JACK – Industrial RJ-45 Solution	372
8.6.b	DIN Rail Enclosures – Copper	376

### 8.7 PRE-TERMINATED COPPER SOLUTIONS

8.7.a	Category 5e Pre-Terminated Cable Assemblies	378
8.7.b	Quad Box Pre-Terminated Cable Assemblies	383

### 8.8 WORK STATION

8.8.a	Multimedia Adapters and Connectors	384
8.8.b	Limited Access – Physical Layer Security Cat 6A System	387
8.8.c	Faceplates	388
8.8.d	Surface Mount Products	395

### 8.9 RESIDENTIAL

8.9.a	MSDE Enclosures	397
8.9.b	HAX Enclosures	399
8.9.c	Voice and Data Modules	400
8.9.d	Economy Distribution Solutions	401

## 9.0 Cabinets, Racks, and Enclosures

### 9.1 FREESTANDING RACKS & CABINETS

9.1.a	Rack Max	405
9.1.b	Open Frame Racks	406
9.1.c	19" Freestanding Cabinets	407

### 9.2 WALL-MOUNT RACKS, CABINETS, AND BRACKETS

9.2.a	Wall-Mount Swing Racks	408
9.2.b	Wall-Mount Enclosures	409
9.2.c	Terax Enclosures	410
9.2.d	19" Sideways Mount Enclosures	411

### 9.3 SHELVING

9.3.a	Shelving	412
-------	----------	-----

### 9.4 CABLE MANAGEMENT SOLUTIONS

9.4.a	Cable Management Solutions	413
9.4.b	Premium High-Capacity Cable Management	414
9.4.c	Standard Finger Duct Cable Managers	415
9.4.d	Ring-Style Cable Managers	416

### 9.5 ACCESSORIES

9.5.a	Accessories	393
-------	-------------	-----

## 10.0 Military/Harsh Environment Deployable Systems

### 10.1 MODULAR ADVANCED REEL SYSTEMS (MARS™)

10.1.a	MARS – Features and Benefits	421
10.1.b	MARS – Performance Specifications	422
10.1.c	MARS – Ordering Information	423
10.1.d	MARS – RiO Reel	424

### 10.2 MARS™ ACCESSORIES

10.2.a	Storage Case	426
10.2.b	Integrated Axle Reel	427
10.2.c	T-Frame	428
10.2.d	Tripod	429
10.2.e	Collapsible Tripod	430
10.2.f	Reel Acquisition Cradle	431
10.2.g	Transit Case with Acquisition Cradle	432
10.2.h	Backpack	433
10.2.i	Cartridge System	434
10.2.j	Advanced Lightweight Reel Stand (ALRS)	435



# CORPORATE OVERVIEW

Company Narrative .....	2
OCC Quality Assurance.....	3
OCC Warranties.....	3
OCC MDIS Program .....	3
OCC in the News .....	4



 Company Narrative

## OCC. SOLUTIONS AND EXPERTISE YOU CAN RELY ON.

When we first built our reputation as pioneers in the design and production of fiber optic cable, OCC made a commitment to quality, performance and customer service. That commitment remains firm as OCC, through continuous innovation, has expanded to include advanced end-to-end connectivity and copper solutions. Here's what that means for you and your business:

### High performance products that get the job done.

Today's networks are confronting an explosive growth in bandwidth demand, the migration from 10 to 40 and 100 Gbits/sec speeds, IP-based transmission, 4k Ultra HD video applications, increases in PoE demands, and the ongoing flux of yet to be determined emerging technologies. As leaders in engineering and manufacturing top-tier cabling and connectivity solutions for a wide range of industries, we partner with you to achieve your particular network vision. Whether it's for mission critical data center applications, live location transmissions for broadcast, harsh environment applications, or the development of a LAN backbone, our products are designed to be smarter than the most challenging situations, and tougher than the toughest environments. No matter what you're facing, OCC will make sure you and your network are ready.

### Expertise that makes your job easier.

Our engineering experts excel at assessing each business challenge to provide a series of viable comprehensive options. They can help you choose integrated, appropriately priced solutions that are designed to work seamlessly together, allowing you to rely on one convenient source for all your network needs. The upshot? The entire process is simpler, faster, and more reliable.

*[Learn more in the Industry Solutions Section, starting on pg. 5.]*

### OCC is:

- listed on the NASDAQ Global Market (ticker symbol: OCC)
- ISO 9001:2008 registered, and its Roanoke and Dallas facilities are MIL-STD-790G certified
- one of the largest manufacturers of fiber optic cable for the North American enterprise market
- the premier manufacturer of ground tactical fiber optic cable for the U.S. military and its allies
- the holder of many patents for innovative technologies widely used throughout the industry
- a leader in technical support and customer service
- named the 2015 recipient of the President's "E" Award for Exports; the "E" award is the highest recognition any U.S. entity may receive for expansion of U.S. exports
- the recipient of numerous certifications, recognitions and awards from the U.S. Department of Defense, the U.S. Department of Commerce, the U.S. Patent Office, the Commonwealth of Virginia, START-IT magazine and the Roanoke-Blacksburg Technology Council



## Quality Assurance, Warranties, and MDIS Program

### Warranties & assurances that let you sleep at night.

At OCC, our quality assurances and warranties are as dependable as the products themselves. We go the extra mile to vigorously test everything and back it up, so you don't have to worry.

Here's how we do it:

#### QUALITY ASSURANCE

We take quality very seriously at OCC. Our Quality Management System is certified to ISO 9001:2008. That means that each customer receives the highest quality standard on each and every product. OCC conducts rigorous inspections, including extensive environmental and mechanical testing. We employ many independent testing laboratories including UL, MSHA, and ETL, to ensure the quality and reliability of all of our products.

#### WARRANTIES

At OCC, we know how crucial reliability is to your business. The demands of modern industry require datacom components that provide both flawless performance and exceptional integrity. We're committed to providing cabling and connectivity solutions that exceed industry standards. When you purchase OCC products, you can be certain that you're getting components that are fully backed by OCC.

#### MDIS PROGRAM

OCC's Multimedia Design and Integration Specialist (MDIS) Program is designed to serve as a guarantee that our quality products are being installed to our extremely rigorous installation standards. This means the installer can rely on technical assistance, specification support and various resources for any application or project using OCC cable and connectivity products.

To participate in the MDIS Program, each installer's credentials are reviewed prior to entering the program. Once approved, they must attend certification training conducted by OCC. This training incorporates current and proposed standards, as well as installation practices and techniques. The program also provides the installer with BICSI CECs (continuing education credits). Upon completion of their initial training, the installation company is certified as a Multimedia Design and Integration Specialist (MDIS), a credential reviewed by OCC yearly.

By installing OCC cable and/or connectivity components under the stringent guidelines set forth by OCC, and by following the accepted and latest methods of the standards reviewed, the OCC MDIS can provide a 25-year extended system warranty, completely backed by OCC. So, when you use an MDIS contractor/installer, you have the highest possible assurance that your system has been built to exceed expectations and deliver exceptional performance.



REACH Compliance Statement:  
REGULATION (EC) No 2006/1907 OF THE  
EUROPEAN PARLIAMENT AND OF THE COUNCIL

Registration, Evaluation, Authorisation and  
Restriction of Chemicals (REACH)

As a manufacturer of articles under REACH definitions, Optical Cable Corporation certifies that no substances in these articles are intended to be released from these articles during normal and reasonably foreseeable conditions of use.

In addition, Optical Cable Corporation regularly monitors the list of substances of very high concern (SVHC) and candidate SVHC published by the European Chemicals Agency (ECHA) and has contacted suppliers of substances and preparations in articles and packaging for SVHC determination.

As new substances are expected to be added to the candidate list in the future, contact the factory for an up-to-date REACH certification.

### The standards review incorporates:

ANSI/TIA-568 – Commercial Building  
Telecommunication Cabling Standard

ANSI/TIA-569 – Commercial Building Standard  
for Telecommunications Pathways and Spaces

ANSI/TIA-606 – Administration Standard for  
the Telecommunications Infrastructure of  
Commercial Buildings

TIA J-STD-607 – Commercial Building  
Grounding and Bonding Requirements for  
Telecommunications



**In the News**

## In the news

### THE PRESIDENT'S "E" AWARD

In 2015, U.S. Secretary of Commerce Penny Pritzker presented Optical Cable Corporation with the President's "E" Award for Exports at a ceremony in Washington, D.C. The award is the highest recognition any U.S. entity may receive for making a significant contribution to the expansion of U.S. exports.

"Optical Cable Corporation has demonstrated a sustained commitment to export expansion. The 'E' Awards Committee was very impressed with Optical Cable's innovation in product development. The company's customized market entry strategy was also particularly impressive. Optical Cable's achievements have undoubtedly contributed to national export expansion efforts that support the U.S. economy and create American jobs," said Secretary Pritzker in her congratulatory letter to the company announcing its selection as an award recipient.

### MEDIA RECOGNITION

We're proud that a variety of media outlets in different industries have taken note of our products and services. Here are some of the articles and publications that have recently reported on OCC innovations:



Products are available for almost every application in enterprise, government, industrial, energy and military markets worldwide. OCC's products are widely selected for installation by:

- Industrial/Manufacturing Facilities
- Campus-Wide Networks
- CATV
- Insurance Companies
- Fiber-to-the-Home (FTTH)
- Colleges and Universities
- Military
- Financial Institutions
- Petrochemical/Oil/Gas
- Governments – Federal/State/Local
- Hospitals
- Healthcare Facilities
- Telco
- Utilities
- Mining
- Security
- Transportation
- Data Centers
- Office Buildings
- Broadcast

For more information, call our Sales Department at (800) 622-7711 or +1 (540) 265-0690, or visit [www.occfiber.com](http://www.occfiber.com).



We started by revolutionizing the design of a cable.

We evolved to change the way the world communicates.

# INDUSTRY SOLUTIONS

- 2.0 Overview..... 6
- 2.1 Data Center Solutions ..... 7
- 2.2 Enterprise Solutions..... 7
- 2.3 Industrial Solutions ..... 8
- 2.4 Broadcast Solutions ..... 8
- 2.5 Security & Monitoring..... 10
- 2.6 Oil & Gas ..... 10
- 2.7 Military Solutions ..... 12
- 2.8 Mining Solutions..... 13
- 2.9 Transportation Solutions..... 14



THE SAME INNOVATION THAT BROUGHT YOU THE WORLD'S FINEST CABLE IS NOW BEING FOCUSED ON SOMETHING MORE IMPORTANT: YOU AND THE RELIABILITY OF YOUR NETWORK.

Let's face it. With today's constantly changing technology and ever growing, bandwidth-hungry applications, your job is getting harder. The more complicated and specialized your industry becomes, the more challenging it can be to know which products to use, how to integrate them, how to budget them, and how to make sure they keep your network running 24-7 with zero downtime. That's a lot to manage.

We've watched and grown with our customers in a wide range of industries, and along the way, we've become experts at the whole process of building connected network infrastructures. Although we're proud to be the experts and pioneers in optical fiber cabling and copper datacom connectivity products, we now carry a broad range of advanced fiber optic, copper cabling, and connectivity solutions that are designed to work seamlessly together. The result is that instead of just relying on us for products, more and more of our customers rely on us for end-to-end cabling and connectivity solutions.

So, you see, our job is changing too. Making excellent products isn't enough anymore. You may need help and support in creating high-performance networks that work effortlessly under increasingly demanding pressures. Just like our tried and true cable products, we can be the conduit between your toughest challenges and your smartest solutions. And we're proud to do exactly that.





## 2.1 Data Center Solutions and 2.2 Enterprise Solutions

### 2.1 Data Center Solutions

The cloud, mobility, IoT, big data, and increasing capacity demands are driving data centers to adapt, evolve, and respond to keep pace with the storage, maintenance, and dissemination of a mind-boggling volume of information. To keep up with the steady flow of new and changing technologies, the physical infrastructure has become more complex, interconnected, and performance oriented than ever before.

OCC provides comprehensive solutions that reflect a deep understanding of the demands of the modern data center. OCC manufactures fiber optic and copper data communication components such as connectors, cabling, pre-terminated assemblies, patch panels, and rack solutions that deliver exceptional performance and provide scalability and reliability as you migrate from 10 to 40 to 100G with 400G on the near horizon. Our products and services ensure your data infrastructure performs flawlessly, whether the enterprise consists of one building, a campus, or multiple locations. With flexible solutions for virtually any industry, our products offer crucial data lifelines for customers around the globe. Here are some of the many benefits that our solutions provide for your data center needs:

- High-density in smaller spaces
- Smaller diameter cables for improved airflow and cooling efficiency
- Exceptional accessibility and easy installation
- Ability to add, move and make changes with little downtime
- Integrated cable management features
- Easy access to individual ports
- Improved reliability, security, and scalability
- Support of precise monitoring, temperature controls, and other environmental factors
- Reduced maintenance costs and downtime
- Greater capacity with an equal or smaller footprint than competitors
- Future proofed solutions configured for 10G now that are easily upgraded to 40G/100G

### 2.2 Enterprise Solutions

High-performance networks are essential to the profitability and viability of business, e-commerce, manufacturing, transportation, education, and a host of other vertical industries. From one building to an entire campus, OCC's products and services ensure your data infrastructure is the most reliable in the industry. From basic assemblies to complex 40/100G networks, OCC has built our reputation on creating exceptional backbone and network cabling and connectivity solutions. We bring a comprehensive, customer-centric approach to every project — offering turnkey solutions as your one-source provider to satisfy today's needs while preparing you for future changes. OCC has the expertise to evaluate your needs and provide technical solutions to even the most complex challenges. With flexible solutions for virtually any industry, our solutions are providing crucial data lifelines in projects as diverse as:

- Expansive Data Centers
- Airports
- Healthcare Facilities
- Colleges and Universities
- Office Parks
- MDUs
- MTUs
- Corporate Campuses



OCC's data center products are designed to provide a comprehensive solution with multiple components that work together seamlessly. To learn more, visit these sections:

- Assembly & Data Center Fiber Optic Cable – HD Cables
- Fiber Optic Connectivity – Pre-Terminated Solutions
- Copper Cable
- Copper Connectivity – Pre-Terminated Solutions
- Racks, Cabinets and Enclosures – Data Center Cabinets



To learn more about the innovative products that create OCC's enterprise solution, see the following sections:

- Indoor/Outdoor Fiber Optic Cable
- Assembly & Data Center Fiber Optic Cable
- Fiber Optic Connectivity
- Copper Cable
- Copper Connectivity
- Workstation Products
- Racks, Cabinets and Enclosures



## 2.3 Industrial Solutions

### 2.3 Industrial Solutions

Industrial networks must excel in harsh physical and environmental conditions not found in traditional office applications. From PLCs, real-time sensors on the factory floor, SCADA systems, to office monitoring and control, a properly designed network must deliver productivity, efficiency, safety, and reliability — day after day. OCC's solutions feature fiber optic cables originally designed for the military and DOD, along with connectivity components that withstand the harshest environments, allowing systems to continue to run and data to transfer where other systems can fail. Ultimately, this makes your company safer and more productive — both inside and outside the plant environment. OCC's experience in engineering and manufacturing fiber optic cables, connectors and enclosures designed for the harshest of environments means our systems include products that deliver exceptional performance in the industrial environment. OCC is at work in a number of industries, including:

- Alternative Energy
- Factory Automation
- Food & Beverage Processing Facilities
- Chemical Plants
- Metal Production and Fabrication Warehouses
- Industrial Surveillance & Alarm Systems
- Power Generation
- Water Treatment Plants

### 2.4 Broadcast Solutions

When a connection fails during a broadcast, the whole world knows.

OCC's Broadcast Solutions feature a broad range of fiber optic broadcast cables, a full variety of SMPTE cables and assemblies for various applications, and harsh environment connectivity and deployable systems that are specifically designed for real-time transmission of high-definition broadcast signals. These systems repeatedly withstand the abuse associated with the extreme demands in rapid deployment and retrieval applications.

In stadium and arena applications, OCC's products are optimized to withstand the rigors of installation challenges, such as difficult cable pulls, high-tensile loading, severe crush occurrences, and extreme deployment situations.

In studio, coax cabling has been used for decades for video, but has reached its limits with 4K HD video demands. OCC optical fiber and copper cabling with advanced connectivity solutions can provide performance beyond expectation with high definition resolution and elevated bandwidth requirements. In fact, we keep you ahead of the technology curve with our latest CAT8 plug-and-play solution, ideal for video applications (see pg. 17). The flexibility offered by OCC's broadcast solutions provides customers with a variety of system configurations and deployment options in these areas:

- News Networks
- Broadcast Studios
- Stadium/Arena
- Sports Venues
- Schools/Universities
- Amusement Facilities
- Conference Centers
- Casinos
- Corporate Facilities
- Houses of Worship



In addition, OCC works with customers that have specific industrial needs, offering solutions that provide the best mechanical, industrial, chemical and environmental performance. To learn more about the products that make up these solutions, see the following sections:

- Indoor/Outdoor Fiber Optic Cables
- Outdoor Fiber Optic Cables
- Industrial Tray Rated Products
- NEMA 4X Enclosures
- Harsh Environment Connectors
- Deployable Solutions
- DinRail Enclosures



For more information about the products in OCC's Broadcast solutions, visit these sections:

- Broadcast Fiber Optic Cables
- Harsh Environment Connectors
- Deployable Systems
- Assembly Fiber Optic Cable
- Fiber Optic Connectivity
- Copper Cable
- Copper Connectivity
- Indoor/Outdoor Fiber Optic Cable
- Racks, Patch Panels, Cabinets and Enclosures

## 2.4 Broadcast Solutions

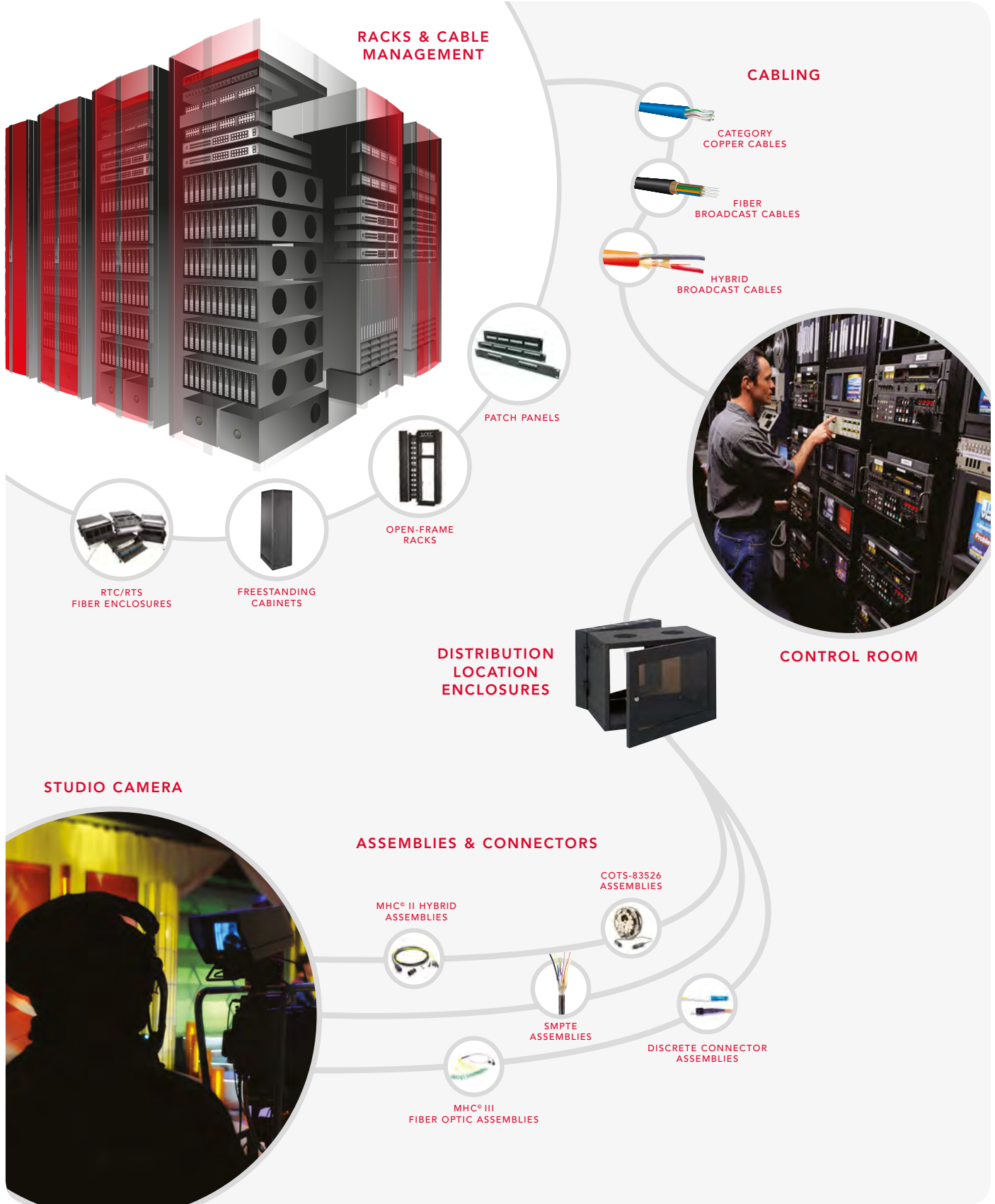

## 2.5 Security & Monitoring Solutions

### 2.5 Security & Monitoring Solutions

The dramatic growth of high-bandwidth wireless access points and IP-enabled devices, such as building surveillance equipment, has created a demand for products that not only install quickly, but also perform reliably.

OCC offers a wide variety of products that help integrate video surveillance cameras into the overall IP network. Whether the application is a handful of cameras and a single server or thousands of cameras with many servers and a massive storage system, OCC products can help maintain protection over valuable company assets.

From high bandwidth, small OD fiber cabling options, to a field installable modular copper plug that is simple to terminate and meets Cat6A performance requirements, OCC offers a complete solution ideal for easy installations and long term reliability.

OCC can also be counted on to deliver the infrastructure to support precise monitoring, temperature controls, and other environmental factors. Under any condition, OCC can deliver. OCC Security and Monitoring solutions include both off-the-shelf products and customized cable and connector technology, including:

- Indoor/outdoor riser and plenum NEC Class 2 hybrid fiber/copper cables that can remotely power and control cameras while providing HD video over fiber
- Perimeter security cables designed to detect intrusion in a variety of installation conditions — on fences, gates, underground, and on platforms
- Cables specially configured for information security to detect and alarm unauthorized attempts to access fibers, both at the ends and along the entire length of cable

For more security and monitoring products visit the sections below:

- Indoor/Outdoor Hybrid Cables
- Harsh Environment Connectors

### 2.6 Oil & Gas Solutions

Extremes in temperature, tests in tensile strength, grime, grit and dirt are just a few of the challenges that energy producers face every day. OCC's suite of solutions meets the physical demands of energy production facilities.

OCC's Oil & Gas solutions provide a robust communications network for the challenges of this industry. Designed to withstand harsh environments, OCC's products sustain end-to-end systems capable of supporting DCS/PLC automation/control architectures, SCADA systems, CCTV/IPTV/CATV networks, and numerous other essential applications. Able to deliver long-term, reliable performance for today's upstream, midstream and downstream application challenges, OCC delivers products and solutions that boost reliability, performance and efficiency for onshore and offshore oil and gas exploration and production.

Our products are currently at work in:

- Nuclear Facilities
- Offshore & Onshore Oil Exploration
- Fracking Operations
- Pipeline Operations
- Refining Facilities



OCC products for the security market are currently at work in:

- Government offices/facilities
- Warehouse and distribution facilities
- Transportation terminals and airports
- Campus environments
- Shipyards, rail yards
- Corrections facilities
- Retail facilities
- Athletic facilities

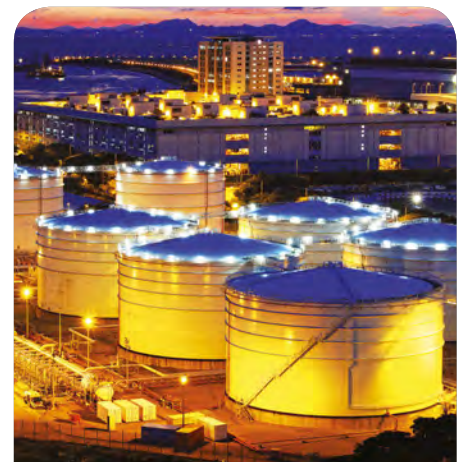

To learn more about OCC's products for the gas and oil markets, visit the sections below:

- Shipboard and Offshore FO cables
- Harsh Environment Connectivity
- Fiber Optic Connectivity
- Deployable Systems



## 2.6 Oil & Gas Solutions

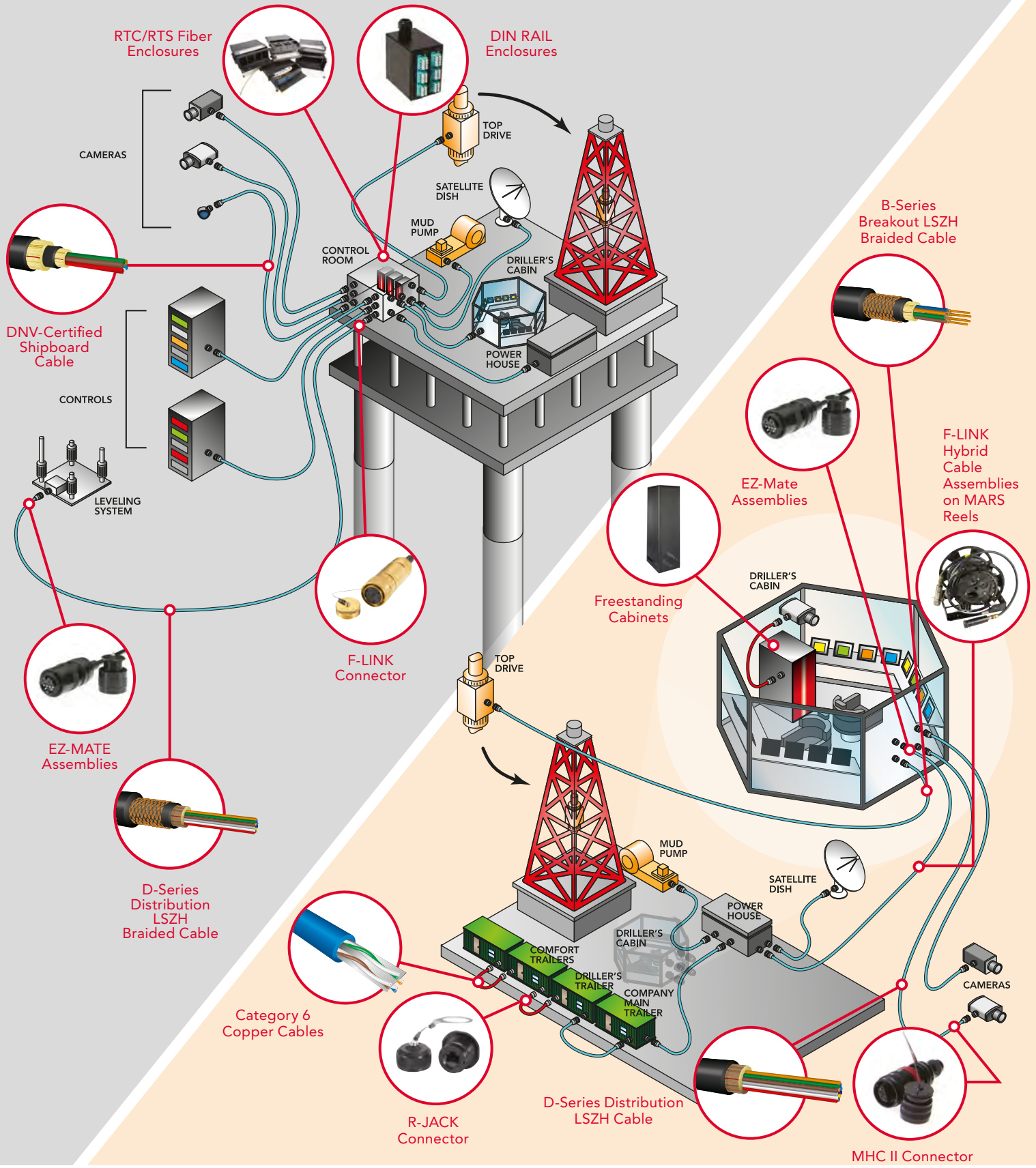

## 2.7 Military Solutions

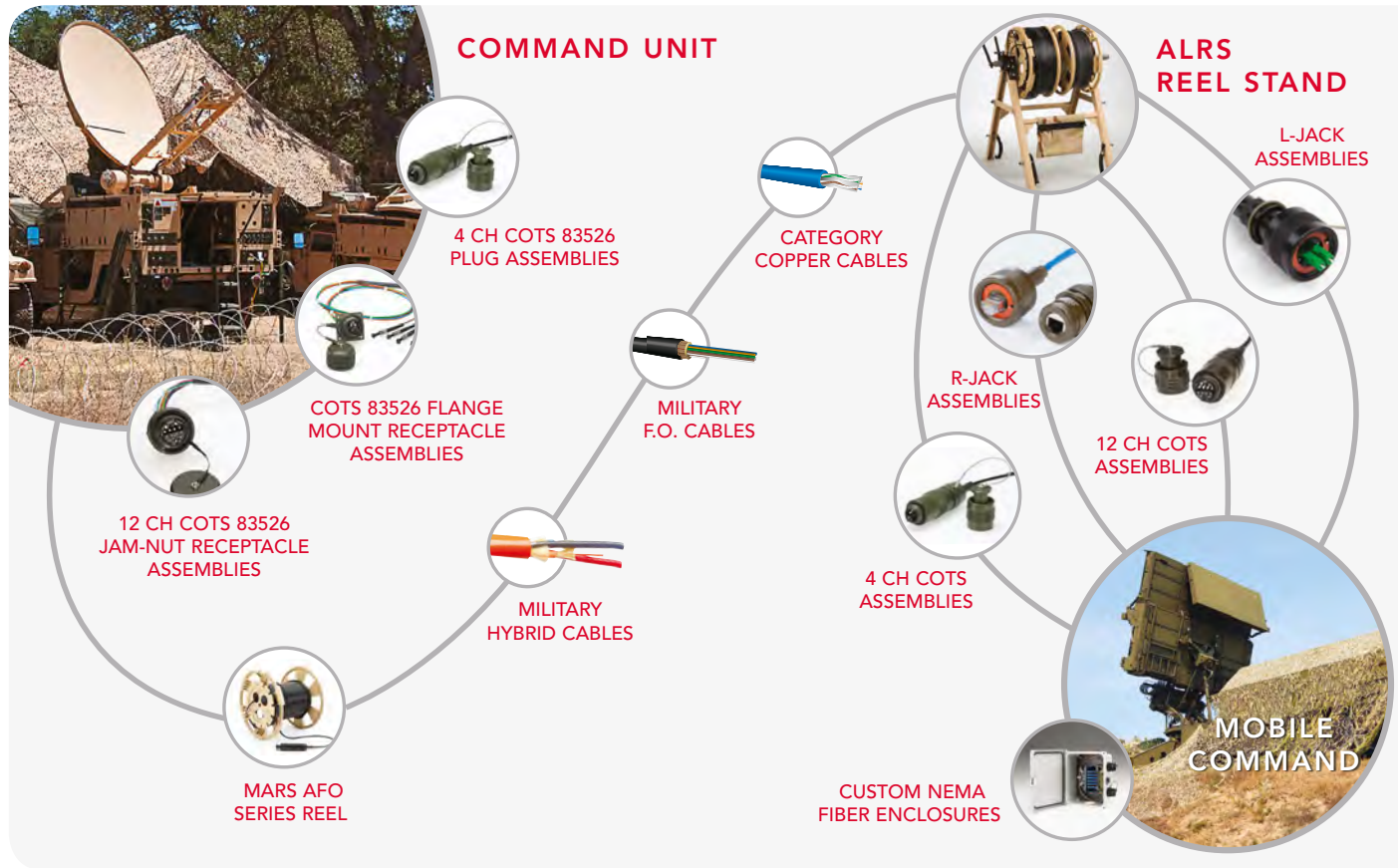

## 2.7 Military Solutions

OCC is the premier manufacturer of military ground tactical fiber optic cable and connectivity solutions for the U.S. military. Our broad product offering for military tactical applications is built on the evolution of fundamental technologies designed to provide end users with solutions that are easy to install, provide a high degree of reliability, and offer outstanding performance characteristics.

OCC's fiber optic cables and connectors have been qualified to the most demanding military specifications, including:

- MIL-PRF-85045/8B Ground Tactical Fiber Optic Cable (U.S. DOD)
- A3159879 Ground Tactical Fiber Optic Cable (U.S. Army CECOM)
- M29504/14, /15 Fiber Optic Connector Termini
- M83522/16, /17 Fiber Optic Connectors
- A3159869 and A3302584 "TFOCA" Ground Tactical Fiber Optic Connectors (U.S. Army CECOM)
- A3159864 and A3302584 Ground Tactical Fiber Optic Cable Assemblies (U.S. Army CECOM)
- Def-Stan 60-1, Part 3 Ground Tactical Fiber Optic Cable (U.K. MOD)
- DOD certified facility for MIL-STD-790G, High-Reliability Manufacturing Requirements for Military Suppliers
- A336463A MARS™ Lightweight tactical Cable Reel (U.S. Army CECOM)
- RL-309/U Advanced Lightweight Reel Stand (ALRS) (U.S. Army CECOM)

Coupled with deployable systems built for easy implementation and retrieval, OCC's military products are designed for the needs of the soldier — rugged and reliable — time and time again.



To learn more about the products used in OCC's Military solutions, see these sections:

- Military Fiber Optic Cables
- Shipboard and DNV Fiber Optic Cables
- Harsh Environment Assemblies
- Harsh Environment Connectors
- Deployable Systems



## 2.8 Mining Solutions

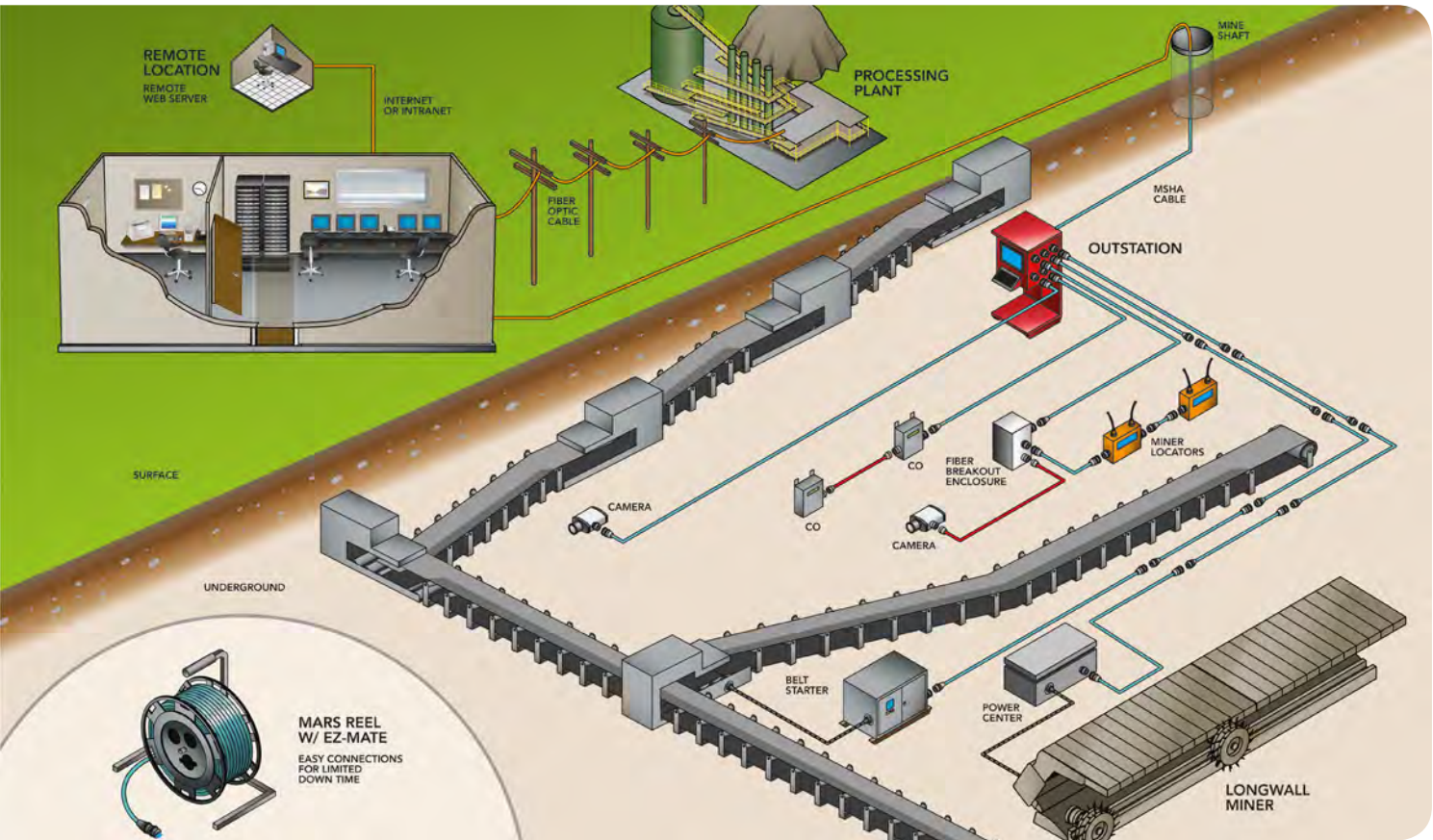

## 2.8 Mining Solutions

Infrastructure dependability for mining operations is critical for a number of reasons. Productivity demands constant uptime to protect margins and profitability, while accurate sensors and monitors are essential to insure safety. Well-designed systems and dependable gathered data are also crucial for environmental compliance.

Through the capacity and capability of fiber optic cabling systems, mines can operate more cost-effectively and with greater efficiency. OCC cables and connectivity components help facilitate higher productivity in areas such as:

- Environmental Monitoring
- Security
- Intrinsically Safe Areas
- Automation
- Production Rates and Yields
- Equipment Control and Monitoring
- Voice/Data/Video Communications

OCC's unique cabling and connectivity configurations provide long-term reliability, security and even reusability in mines. Our fiber optic cables are designed and manufactured to meet high-survivability standards to endure severe mechanical and environmental stress.

OCC's connectivity products are rugged, durable, and easy to install — providing solutions for the most demanding mining applications. OCC offers products that are MSHA approved, including products for intrinsically safe areas.

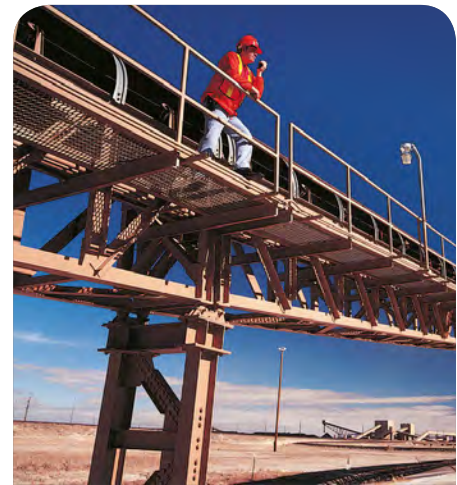

To learn more about OCC's MSHA-approved cables and connectivity products for the mining market, visit the sections below:

- Mining Cables
- Fiber Optic Connectivity – NEMA 4X Enclosures
- Harsh Environment Connectivity
- Deployable Systems



## 2.9 Transportation Solutions

### 2.9 Transportation Solutions

The transportation industry has always depended on data to help execute schedules faithfully. The integration of technology has helped the industry track, move, and secure its vital commercial operations and profitability.

OCC works hand-in-hand with a wide range of transportation industries. Our waterproof connectors are essential for marine operations. Our legendary ruggedness is at work in rail and over-the-road operations. Our sophisticated systems connect the security infrastructure of many of the nation's largest airports. OCC is the ideal partner for the transportation industry: on time, reliable, and tough.

The industries we serve include:

- Marine
- Aerospace Machinery
- Subway
- Trucking
- Automotive



To learn more about OCC's products for the transportation market, visit the sections below:

- Indoor/Outdoor Armored Cables
- NEMA 4X Enclosures
- Industrial Cables
- Shipboard Cables
- Harsh Environment Connectivity
- Harsh Environment Cable Assemblies
- Deployable Systems

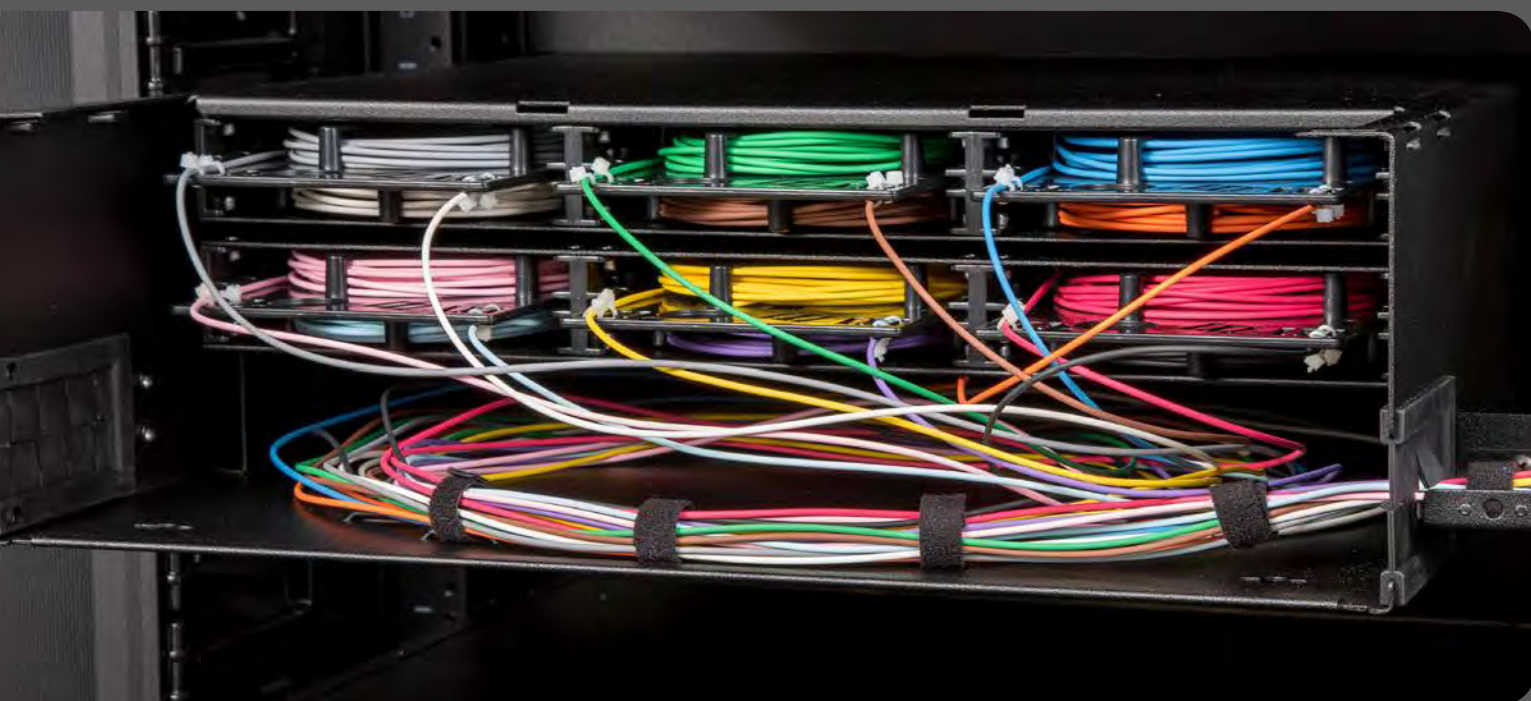

# DISCOVER THE DIFFERENCE — NEW FEATURED PRODUCTS

## Stronger and More Reliable

OCC has been and continues to be one of the largest suppliers of optical fiber solutions for the military and Department of Defense (DOD) since 1983 — making us expert developers of stronger fiber cables and connectivity that meet the most stringent military requirements for security and reliability. And we pass that dedication and expertise in optimum product reliability to all of our customers — spanning virtually every vertical industry — with solutions that exceed industry performance testing standards.

After all, OCC invented indoor and outdoor tight-buffered technology, and it's our Ultra-Fox™, Ultra-Fox™ Plus, and Easy-Strip buffering technologies that offer the most reliable and robust multimode and single-mode fiber cables that boast the best performance and longest operational distances available. And that's another major difference between our cables and others for:

- Minimization of network downtime
- Support of surging high-bandwidth and mega speed transmissions
- Immediate scalability
- Crucial future-proofing readiness of yet-to-be-identified emerging technologies

As new technologies emerged, OCC has expanded into copper and connectivity to bring our customer the most comprehensive and advanced network solutions as their one-stop solutions provider. Our commitment to reliability remains steadfast. In fact, OCC is the **ONLY** cabling and connectivity manufacturer that offers Test & Measurement Grade copper products and solutions — products that are as near to perfection to industry standards as possible. With OCC, you need not look any further.

## 3.0 Discover the Difference — New Featured Products

3.1	Advanced End-to-End Network Solutions.....	16
3.2	Network Innovations and Featured Products.....	17
A.3	Product Information — Appendix .....	21



### (3.1) Advanced End-to-End Network Solutions

## Advanced End-to-End Network Solutions

To meet the onslaught of emerging network technologies and the specific goals of our customers head-on, OCC was determined to develop one of the industry's broadest portfolios of end-to-end network infrastructure solutions... and we did just that.

No matter what your network challenge — ULTRA HD 4k Video transmission, IP and the fast growth of wireless and mobile applications, ever-increasing PoE requirements, or the network migration from 10Gbits/sec to 40, 100 and beyond — OCC partners with you to achieve your specific network vision. That's why we expanded to include the most advanced and comprehensive end-to-end network solutions and services, including:

- Fiber Cables and Connectivity
- Copper Cables and Connectivity
- Harsh Environment Solutions
- Necessary Accessories, Tools, and Individualized Kitted Components to Get Your Job Done
- Competitive and Extended Warranties
- OCC Trained and Certified Multimedia Design and Integration Specialist (MDIS) Installers Skilled for Your Perfect Install
- Impeccable Customer, Design Engineering, and Technical Service

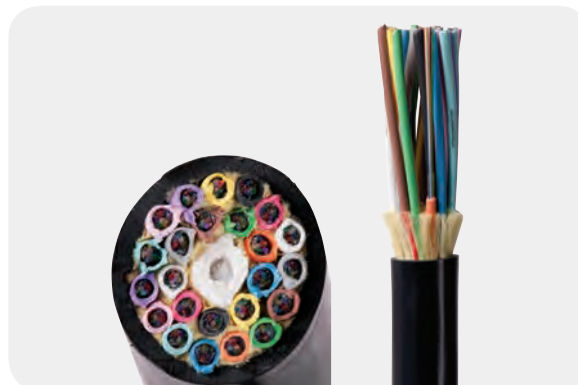

We took this expansion to another level, as well. At OCC, our engineers design every cable and connectivity solution with *value added and lower total installed costs* in mind. From easy plug-and-play connectivity and tailored pre-terminated cables to our smaller diameter HC cables for potential conduit savings, OCC solutions deliver fast, easy, cost effective, and more reliable network and data center solutions.

What does this vast portfolio of advanced end-to-end solutions mean?

- Maximum flexibility in network design
- A multitude of options to achieve your particular network vision and requirements
- Myriad solutions for any inside plant and outside plant installations within virtually any physical environment
- Facilitation of quick and easy network moves, adds, and changes (MACs)

And we don't stop there. At OCC, we want more for our customers. It's not enough that they meet current technology and minimum TIA, IEEE and other industry testing standards. Rather, we're committed to continuous innovation and exceeding industry standards to keep our customers well *ahead of the technology curve* — making our competitive advantages their competitive advantages for the mutual success of our companies.



## (3.2) Network Innovations and Featured Products

### Network Innovations and Featured Products

#### Category 8 Field Installable Plug

OCC takes continuous innovation and the advancement of technology seriously. Our latest patented innovation, the PC circuit board in OCC's new Field Installable CAT8 plug, does what we promised — it keeps our customers ahead of future-forward technology.

And, it has set a new industry standard in connectivity!



- Industry's first and only Category 8 connector meeting TIA Cat8 standards
- Designed to provide the highest level of performance for high-speed applications
- Delivers data transmission speeds of up to 40 Gbits/sec with Category 8 copper cable
- Ideal for direct-attach, high-speed links, and data center server connections
- Enables easy terminations without specialized tools
- Uses same shielded housing as OCC's Category 6A Shielded Field Installable Plug
- Backward compatible with existing RJ-45 infrastructure, including Cat 6A, Cat6, and Cat5e cabling
- Supports IEEE 40GBASE-T compliance
- Patented PCB design for Cat8 performance and beyond

#### Procyon Blade Solution

OCC's revolutionary in-line splice module Blade Solution is unique in the market as a game-changer for high-density networks. The blade solution solves the problem of having too many connectors in a system, which causes increased attenuation, decreased bandwidth results, and general degradation in signal integrity. By decreasing the number of physical connections, the Blade Solution delivers reliable signals with reduced back reflection for optimum data transmission. It's also designed to provide superior organization, accessibility, and density to fit a lot of fiber in small spaces. The Procyon system also provides network managers with a clear migration path from 10 to 40 and 100 Gigabit/sec. speeds for ultimate bandwidth management.

- Provides a complete connectivity and cabling infrastructure for campus and multi-building networks when combined with OCC's smaller diameter indoor/outdoor HC series or indoor plenum HD series cables, that are exceptional in tight bends
- Designed to service 12-fiber subgroup trunk cables
- Delivers optimum data transmission to keep your network up and running
- Ideal for long runs, such as between buildings on a campus, and multiple building network configurations
- Designed for easy access to subgroup cables from front or back of enclosure
- Delivers versatile configurations for maximum density
- Available in 2RU, 3RU, and 4RU for rack mount versions, two wall mount versions, and a variety of adapter plate options
- Makes splicing easier than ever
- Plus, much more



See Chapter 6, pages 221-224, for complete information and the many features and options available for this revolutionary network solution.



## (3.2) Network Innovations and Featured Products

### New SMPTE Cables

OCC brings to the Broadcast industry new SMPTE 311 compliant cables with OCC's notable expertise and experience of providing "military grade" durability and reliability. Our reputation as a leader in data integrity and excellence for delivering a more durable and reliable product — coupled with top notch customer service, broad assembly offerings, and dedicated repair and restoration services — proves that OCC's SMPTE is the prime product in the broadcast market. With our various SMPTE offerings, OCC delivers the perfect solution to meet your specific HD camera and video requirements.

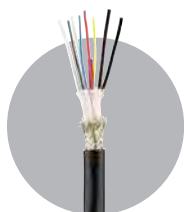

#### SMPTE ESSENTIAL

- Standard SMPTE cable
- Great value
- Perfect for indoor use and occasional outdoor deployment
- Fully SMPTE 311 compliant; contains 245 micron acrylate optical fiber

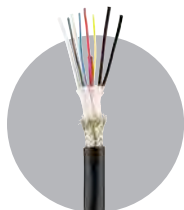

#### SMPTE PREMIUM

- Reliable cable for regular deployment in all applications
- Utilizes the Ultra-Fox™ Plus buffer system for maximum fiber protection
- Fully SMPTE 311 compliant

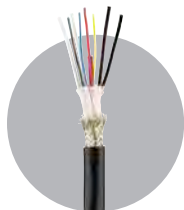

#### SMPTE TACTICAL

- Ideal for harsh outdoor deployable applications
- Utilizes the Ultra-Fox™ Plus buffer system for maximum fiber protection
- Fully SMPTE 311 compliant

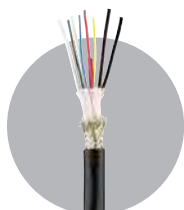

#### SMPTE LSZH

- Low smoke zero halogen cable
- Utilizes the Ultra-Fox™ Plus buffer system for maximum fiber protection
- Fully SMPTE 311 compliant

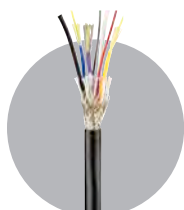

#### SMPTE FLEX

- Flexible enough to let cameras move quickly and frequently
- Aramid yarn central strength member increases flexibility
- Polyurethane jacket ensures durability
- Utilizes the Ultra-Fox™ Plus buffer system for maximum fiber protection
- Compatible with SMPTE 311 Standard

Please see Chapter 5, pages 154–158, for more information.

Note: SMPTE Premium, Tactical, LSZH, and Flex all utilize the OCC Ultra-Fox™ Plus deployable buffer system with the combination of a triple thickness 500 micron diameter acrylate coating together with a hard elastomer 900 micron tight buffer for maximum fiber protection. Available in custom lengths.

## (3.2) Network Innovations and Featured Products

### Passive Optical LAN Solutions

Many enterprise networks are increasingly adopting the Passive Optical LAN (POL) for their bandwidth-hungry, internet-based applications. One of the main attractions to POL is that it enables enterprises to simultaneously converge multiple services, such as data, IP transmission, video, building security, management services, and wireless with a much smaller cabling footprint and a futureproofed architecture that can grow with bandwidth demand. OCC offers the complete line of specifically designed products to cover the entire signal path from OLT to the ONT with the industry's most reliable end-to-end POL solutions.

POL offers many network advantages, including:

- A single POL can be connected to hundreds or thousands of individual users, providing a multitude of enterprise and outside telecommunications applications
- Elimination of electric power for electronics
- Freedom from electromagnetic interference
- Reduction in costs with the elimination of telecommunication rooms and reduced power consumption
- A complete system that integrates with other POL and structured cabling components
- Compelling value proposition
- Enhanced security, and much more

See Chapter 6, pages 212–215, for more information and a complete POL guide for zone configurations.



### MHC® III Cable Assemblies

OCC's MHC III Cable Assembly is the only hermaphroditic MPO technology connector in the industry, and yet another testimony to OCC's commitment to providing our customers with the latest and most advanced network solutions. This cable assembly also testifies to OCC's dedication in designing value added and lower total installed costs in the design of its products. The MHC III also solves current network challenges, such as space savings, delivering exceptional 4k HD video transmission, eliminating electromagnetic interference (EMI), and future-proofing your network for high-bandwidth readiness. Patent pending.

- Delivers up to 24 fibers in a 30% smaller footprint than traditional cylindrical connectors
- Reduces amount of space to connect 12 and 24 channels (available up to 48 total channels)
- Saves installation time and the associated costs of terminations
- Ensures connections can withstand wide temperature ranges and impact resistance due to all-metal construction
- Ideal for uncontrolled environments
- Includes features such as an integrated pulling eye to assist with difficult cable pulls
- IP-68 rating keeps data transmission protected against dirt, dust and water
- Perfect for a variety of applications, including deployable broadcast systems, digital HD video transmission, industrial monitoring, distributed antenna systems (DAS) and many more
- Available in multimode, single-mode and APC single-mode, the MHC III can be provisioned in various hermaphroditic plug and receptacle options



See Chapter 6, pages 308–311, for performance specifications, additional options, and ordering guide.

## OptiReel™

At OCC, we strive to devise solutions that make installations faster, easier, and more cost effective for our customers. The OptiReel does exactly that.

### Features and Applications

- OptiReel cable box saves installers time
- Cable reel features adjustable tension control for cable payout adjustments
- Always know remaining cable length with AT-A-GLANCE decreasing cable length markings
- Faster installation for multiple fiber optic cable drops
- Easy cable handling and storage, and excellent protection at job sites
- Available in popular fiber types and up to 12-fiber cables
- Can be stacked with other boxes containing data cables
- Contains optimum performance fiber optic cable

OptiReel is a self-contained payout box to facilitate storage, handling and pulling of the cables. The packaging greatly reduces set-up time for each pull. Therefore, the box is ideally suited for cable pulls through building duct systems, walls and ceilings where multiple cables may be pulled together and many relatively short runs need to be installed.

OptiReel cable boxes can be easily stacked and staged together with other types of data cables for faster installations. The compact boxes contain an internal reel so that cable stands do not have to be used. Cables in the boxes are marked with decreasing length markings, so that the installer always knows the length of the remaining cable in the box.

OptiReel cable packaging is available for Optical Cable Corporation's simplex and duplex A-Series and D-Series types of cables, either riser-rated or plenum-rated, with 62.5/125, 50/125, and single-mode fibers.

Contact your local Optical Cable Corporation representative or distributor to order your next shipment of fiber optic cable in the OptiReel cable box.

### Specifications for OptiReel

CABLE TYPE	CABLE LENGTH (FT)	TOTAL WEIGHT (LBS)	BOX TYPE
AX001	3,000	18	16" x16" x16"
AX002	1,500	19	16" x16" x16"
DX002	2,000	40	16" x16" x16"
DX004	1,500	40	16" x16" x16"
DX006	1,500	42	16" x16" x16"
DX008	1,000	35	16" x16" x16"
DX012	1,000	40	16" x16" x16"







## PRODUCT INFORMATION — APPENDIX

OCC is proud to offer our customers one of the industry's broadest and most advanced fiber and copper cabling and connectivity product offerings based on your specific application and environment. Whether you need optimum reliability for a network solution that is rugged and tough for the battlefield; you're migrating your enterprise network from 10 to 40 to 100 Gbit/s and beyond; challenged with 4k HD video transmission; or standardizing on 25GBase-T, 40GBase-T and Category 8; OCC's got you covered. Contact us at 1-800-622-7711 and ask for a Sales Representative for any inquiries or assistance with finding your perfect network solution. We're ready to assist you.

### A.3 Product Information — Appendix

A.3.1	Laser Ultra-Fox™ Cables and Laser Ultra-Fox™ Delay Equalized Cables .....	22
A.3.2	Fiber Buffer Options.....	23
A.3.3	Fiber Cable Configurator .....	24
A.3.4	Laser Ultra Fox™ Fiber Performance .....	25
A.3.5	Ultra Fox™ Plus Fiber Performance .....	26
A.3.6	Choosing the Right Cabling System .....	28
A.3.7	Outer Cable Jacket Materials.....	30
A.3.8	Extended Performance Warranty .....	31
A.3.9	Choosing the Right Fiber Optic Enclosure.....	34
A.3.10	Choosing the Right Connector.....	35



## (Appendix 3.1) Laser Ultra-Fox™ Cables and Laser Ultra-Fox™ Delay Equalized Cables

### Laser Ultra-Fox™ Cables

In addition to optimum performing single-mode cables, OCC offers its Laser Ultra-Fox multimode fiber optic cables that deliver the best performance and longest operational distances available. They're the ideal solution for the laser-based high-speed networks of today and tomorrow. Laser Ultra-Fox multimode cables are optimized for use with high-speed laser-based systems, such as Gigabit Ethernet. Laser Ultra-Fox multimode cables are also fully compliant with all LED-based standards, making them an excellent choice for any new installation where migration to Gigabit Ethernet is planned. These cables have controlled differential-mode-delay and refractive-index-profiles that are directly compatible with 850 nm VCSEL lasers, 1310 nm single-mode lasers, and LEDs. Laser Ultra-Fox multimode cables are available in both 62.5µm and 50µm fiber types.

Laser Ultra-Fox OM3 (ALT) and OM4 (ALE) multimode cables are optimized for use with laser-based systems, such as 10-Gigabit Ethernet. Laser Ultra-Fox ALT and ALE cables also achieve extended distance operation with Gigabit Ethernet systems, and are fully compatible with all 50µm LED-based standards, making them the best choice for any new installation that might require operation at 10-Gigabit speeds. Laser Ultra-Fox ALT and ALE cables are fully compliant with TIA 568 and the applicable OM3 or OM4 ISO/IEC 11801 standards.

OCC's Laser Ultra-Fox ALT and ALE cables provide extended distance operation beyond the IEEE 802.3z Gigabit Ethernet standard link lengths. Laser Ultra-Fox cables are fully compatible with all 10-155 Mb/s data standards, such as Ethernet, Fast Ethernet, FDDI, ATM, Fiber Channel, and TIA-568. Laser Ultra-Fox cables are laser-ready, eliminating the need for expensive mode conditioning patch cords.

### Laser Ultra-Fox™ Delay Equalized Cables

Optical Cable Corporation's Laser Ultra-Fox Delay Equalized fiber optic cables offer the unique combination of true-time-delay equalization and easy termination.

These cables are optimized for use in high-speed parallel data transmission, where minimal time skew of data between groups of fibers is important for proper system operation. Installations using keyboard-video-mouse (KVM) access, where the actual computers are in a secure location separate from the KVM controls, often have demanding time skew requirements. With Laser Ultra-Fox Delay Equalized cable, groups of two to six fibers may be delay-equalized. Higher fiber counts can be produced in GX-Series Subgrouping cables by using delay-equalized subunit cables.

Each individual fiber within a Laser Ultra-Fox Delay Equalized cable group is specially selected for equal group refractive index, allowing distance accuracy down to a few inches or less depending on overall cable length. In competing ribbon cable designs, unequal group refractive index can change the relative propagation delay time by as much as 0.4%.

Contact Optical Cable Corporation, and ask for more information on Laser Ultra-Fox Delay Equalized fiber optic cables.



(Appendix 3.2) Fiber Buffer Options

Optical Cable Corporation offers three distinct buffering systems, each carefully engineered and manufactured to be the best available for its respective installation/application and for the utmost reliability of your network.

### Ultra-Fox™

Our Ultra-Fox cable features 100 kpsi proof-tested fiber, a primary coating of UV-cured acrylate material to a diameter of 245µm, and a secondary buffer to 900µm. The composite primary coating and secondary buffer may be mechanically removed to the 125µm glass diameter in one step. This is typically done for direct termination with connectors. The versatile buffer system permits mechanical stripping in short lengths (about 1 cm) to remove the secondary buffer and leave the 245µm primary coating intact. This 245µm buffered fiber is, therefore, available for splicing to similar buffered fibers from loose-tube cables. The 245µm coating may then be further mechanically stripped to the 125µm glass diameter.

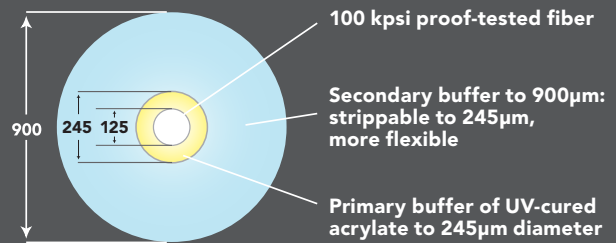

### Ultra-Fox™ Plus

Our Ultra-Fox Plus cable features 100 kpsi proof-tested fiber, a primary buffer of UV-cured acrylate material to a diameter of 500µm, and a secondary hard elastomeric buffer to 900µm diameter. This provides the best environmental and mechanical protection, and is the preferred buffering on our military tactical cables. This buffering system can easily be mechanically stripped directly to the glass for termination with connectors or for splicing.

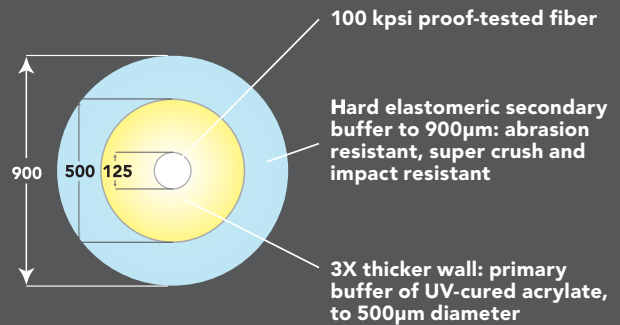

### Easy-Strip (ES) Buffer Options

Our Easy Strip options permit the easy removal of long lengths (20–30 cm) of the 900µm buffer, leaving the 245µm acrylate coating. This is convenient when the 900µm buffer must be removed to allow for splicing or ribbonizing.

ES2 features a 900µm PVC primary buffer with a release agent placed between the primary buffer and the 245µm acrylate coating.

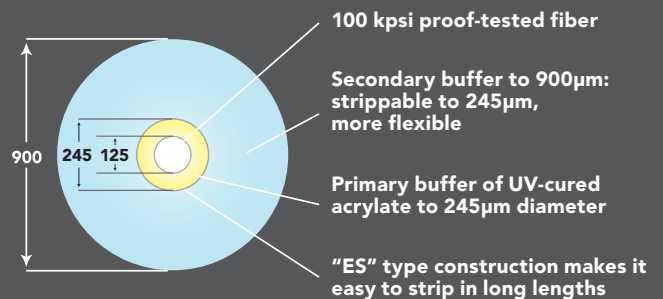



(Appendix 3.3) Fiber Cable Configurator

CABLE SERIES	
[ Digit 1 ]	[ Digit 2 ]
<b>A</b> = Assembly Cables	<b>X</b> = Ultra-Fox – 2.9 mm nominal OCD – (dash) = Ultra-Fox Plus – 2.9 mm nominal OCD
<b>B</b> = Breakout Cables	<b>X</b> = Ultra-Fox – (dash) = Ultra-Fox Plus Standard subunit sizes: Mil-Tac 2.0 mm, PVC Riser 2.5 mm, LSZH 2.5 mm, Plenum 2.0 mm
<b>C</b> = Hybrid Cables	<b>X</b> = Ultra-Fox with standard cable diameter – (dash) = Ultra-Fox Plus – 2.9 mm nominal OCD
<b>D</b> = Distribution Cables	<b>X</b> = Ultra-Fox – (dash) = Ultra-Fox Plus
<b>G</b> = Subgrouping Cables	<b>X</b> = Ultra-Fox – standard 12-fiber subgroup – (dash) = Ultra-Fox Plus – standard 12-fiber subgroup
<b>H</b> = High-Density Cables	<b>D</b> = Indoor, <b>Z</b> = Zip Style <b>C</b> = Indoor/Outdoor, Outdoor
<b>L</b> = Round Furcation Tubing	<b>X</b> = Standard 2.9 mm nominal outer cable diameter
<b>M</b> = Messenger Cables	<b>X</b> = Ultra-Fox™ Figure 8 – (dash) = Ultra-Fox™ Plus Figure 8
<b>RM</b> = Round Messenger	ADSS All-Dielectric Self-Support

FIBER COUNT
[ Digits 3–5 ]
Must be three digits for all cables. Hybrid Cable fiber count will be defined as:
<ul style="list-style-type: none"> <li>• Sum of one for each fiber</li> <li>• one for each individual wire</li> </ul>

12-fiber distribution indoor/outdoor riser cable using 62.5µm Ultra-Fox fiber, black jacket CST with Polyethylene jacket –

**Example Part Number: DX012DWLS9KAA2**

**Cable Part Number: KKKKKKKKKKKK**

UNREINFORCED JACKET MATERIAL	
[ Digit 6 ]	
<b>A</b>	Polyethylene
<b>C</b>	Polyurethane
<b>D</b>	Indoor/Outdoor PVC
<b>J</b>	Indoor/Outdoor Oil Resistant Low Temperature PVC
<b>K</b>	Fluoropolymer
<b>N</b>	Flexible PVC
<b>S</b>	Flame-Retardant Low-Smoke
<b>V</b>	Flame-Retardant Tactical Polyurethane
<b>W</b>	Flexible Fluoropolymer
<b>X</b>	Polyolefin

BUFFER SIZE	
[ Digit 10 ]	
<b>9</b>	250/900
<b>5</b>	500/900
<b>2</b>	ES2

## (Appendix 3.3) Fiber Cable Configurator

FIBER TYPE AND PERFORMANCE	
[ Digits 7–9 ]	
<b>Laser Ultra-Fox Fiber Performance</b>	
CODE	CORE/CLADDING DIAMETER (µm)
<b>WLS</b>	62.5/125 standard
<b>WLX</b>	62.5/125 XL
<b>ALS</b>	50/125 standard bend insensitive
<b>ALX</b>	50/125 XL bend insensitive
<b>ALT</b>	50/125 (300 meter 10-GbE) bend insensitive
<b>ALE</b>	50/125 (550 meter 10-GbE) bend insensitive
<b>SLX</b>	9 <sup>6</sup> /125 low water peak single-mode
<b>SLA</b>	9 <sup>6</sup> /125 bend insensitive, single-mode, G.657.A1
<b>SLB</b>	9 <sup>6</sup> /125 bend insensitive, single-mode, G.657.A2
<b>SLC</b>	9 <sup>6</sup> /125 bend insensitive, single-mode, G.657.B3
<b>Ultra-Fox Plus Fiber Performance</b>	
CODE	CORE/CLADDING DIAMETER (µm)
<b>WLS</b>	62.5/125 standard
<b>WST</b>	62.5/125/500
<b>AST</b>	50/125/500
<b>ALS</b>	50/125 standard
<b>ALT</b>	50/125 (300 meter 10-GbE)
<b>ALE</b>	50/125 (550 meter 10-GbE)
<b>SLS</b>	9/125/500 <sup>1</sup> low water peak single-mode

OUTER JACKET COLOR	
[ Digits 11 ]	
<b>Q</b>	10-Gigabit Aqua
<b>K</b>	Black
<b>B</b>	Blue
<b>Z</b>	Brown
<b>C</b>	Custom
<b>G</b>	Green
<b>A</b>	Light Blue Aqua
<b>N</b>	Natural
<b>O</b>	Orange
<b>R</b>	Red
<b>S</b>	Rose
<b>T</b>	Slate
<b>V</b>	Violet
<b>W</b>	White
<b>Y</b>	Yellow

**Standard Cable Colors**

**Black** = All Riser Cables, except AX-Series Assembly Cables

**Black** = Military Cables

**Black** = Outdoor Cables and Zero-Halogen

**10 Giga Aqua** = A-Series, D-Series Riser, Plenum, and ILA with 50µm 10 Gig Fiber

**Orange** = A-Series, Riser, Plenum, and ILA with MM fibers

**Yellow** = A-Series, Riser, Plenum and ILA with single-mode fibers

RATING		
[ Digit 12 ]		
CODE	RATING NAME	DESCRIPTION
<b>A</b>	None	No rating
<b>E</b>	IEC	Meets the requirements of IEC Standards 60332-3-24, 61034-2 and 60754-2
<b>M</b>	Military	Meets the requirements for a military cable
<b>P</b>	Plenum	Meets the requirements of ANSI/NFPA 262
<b>R</b>	Riser	Meets the requirements of UL 1666

REINFORCEMENTS	
[ Digits 13–14 ]	
(Note: Not required for certain cables, including non-reinforced riser and plenum rated cables.)	
<b>A1</b>	CST with PVC Jacket
<b>A2</b>	CST with Polyethylene Jacket
<b>A4</b>	CST with Zero Halogen Jacket
<b>D3</b>	Dielectric Messenger, 4.0mm messenger
<b>G3</b>	Galvanized Steel Messenger, 1/4" diameter messenger
<b>12</b>	Interlocked Aluminum Armor with PVC outer jacket
<b>14</b>	Interlocked Aluminum Armor with Zero-Halogen outer jacket
<b>16</b>	Interlocked Aluminum Armor with Indoor/Outdoor Fluoropolymer Plenum outer jacket
<b>17</b>	Interlocked Aluminum Armor with Indoor-only Plenum outer jacket

 (Appendix 3.4) Laser Ultra-Fox™ Fiber Performance

Fiber Code <sup>7</sup>	Industry Standard Designation	Core/Cladding Diameter (µm)	Numeric Aperture	Wavelength (nm)	Gigabit Ethernet Distance (m)	10-Gigabit Ethernet Distance (m)	Max. Cabled Attenuation (dB/km)	Min. Laser EMB Bandwidth* (MHz-km)	Min. OFL LED Bandwidth** (MHz-km)
WLS	OM1 ISO/IEC 11801	62.5/125	0.275	850/1310	300/600	33/300 <sup>^</sup>	3.5/1.5	220/500	200/500
WLX	OM1+ ISO/IEC 11801	62.5/125	0.275	850/1310	500/1000	33/300 <sup>^</sup>	3.5/1.5	385/500	200/500
ALS	Laser Grade OM2 Bend Insensitive ISO/IEC 11908	50/125	0.20	850/1310	600/600	82/300 <sup>^</sup>	3.5/1.5	510/500	500/500
ALX	Extended Length Laser Grade OM2+ Bend Insensitive ISO/IEC 11801	50/125	0.20	850/1310	750/600	150/300 <sup>^2</sup>	3.0/1.0 <sup>3</sup>	950/500	700/500
ALT	Laser Optimized OM3 Bend Insensitive ISO/IEC 11801	50/125	0.20	850/1310	1000/600	300/300 <sup>^2</sup>	3.0/1.0 <sup>3</sup>	2000/500	1500/500
ALE	Laser Optimized OM4 Bend Insensitive ISO/IEC 11801	50/125	0.20	850/1310	1040/600	550 <sup>1</sup> /300 <sup>^2</sup>	3.0/1.0 <sup>3</sup>	4700/500	3500/500
SLX	Low Water Peak Single-Mode ITU-T G.652.D	9 <sup>6</sup> /125	—	1310/1550	5 km <sup>4</sup>	10 km <sup>5</sup>	0.5/0.5	—	—
SLA	Bend Insensitive Low Water Peak Single-Mode ITU-T G.657.A1 and ITU-T G.652.D	9 <sup>6</sup> /125	—	1310/1550	5 km <sup>4</sup>	10 km <sup>5</sup>	0.5/0.5	—	—
SLB	Bend Insensitive Low Water Peak Single-Mode ITU-T G.657.A2 and ITU-T G.652.D	9 <sup>6</sup> /125	—	1310/1550	5 km <sup>4</sup>	10 km <sup>5</sup>	0.5/0.5	—	—

\* Minimum Laser Effective Modal Bandwidth (EMB)

\*\* For backward compatibility to LED based systems, overfilled launch (OFL)

<sup>^</sup> 1310 nm CWDM lasers (10GBASE-LX4)

<sup>1</sup> Reach assuming 3.0 dB maximum cabled attenuation at 850 nm and 1.3 dB total connection and splice loss

<sup>2</sup> Supports 220 meter 10GBASE-LRM distance, or 300 meter 10GBASE-LRM distance with 300 meter capable equipment

<sup>3</sup> 3.5/1.5 dB/km maximum attenuation applies for DX-Series cables greater than 36 fibers, and for all DX-Series cables with armor (corrugated steel tape or interlocked armor) or any other secondary outer jacketing

<sup>4</sup> 10 km for 1310 nm 1000BASE-LX10, and 5 km for 1310 nm 1000BASE-LX

<sup>5</sup> 10 km for 1310 nm 10GBASE-LR, and 40 km for 1550 nm 10GBASE-ER

<sup>6</sup> Typical Mode Field Diameter at 1310 nm

<sup>7</sup> Fiber Codes are available for composite cables containing a wide variety of mixed fiber types within the same cable. Call OCC Customer Service for the Fiber Code for your composite cable configuration.

(Appendix 3.5) Ultra-Fox™ Plus Fiber Performance



Fiber Code <sup>5</sup>	Industry Standard Designation	Core/Cladding Diameter (µm)	Numeric Aperture	Wavelength (nm)	Gigabit Ethernet Distance (m)	10-Gigabit Ethernet Distance (m)	Max. Cabled Attenuation (dB/km)	Min. Laser EMB Bandwidth* (MHz-km)	Min. OFL LED Bandwidth** (MHz-km)
WST	OM1 ISO/IEC 11801	62.5/125	0.275	850/1310	275/550	33/300 <sup>^</sup>	3.5/1.5	200/500	200/500
WLS	Laser Grade OM1 ISO/IEC 11801	62.5/125	0.275	850/1310	300/600	33/300 <sup>^</sup>	3.5/1.5	220/500	200/500
AST	OM2 ISO/IEC 11801	50/125	0.20	850/1310	550/550	82/300 <sup>^</sup>	3.5/1.5	500/500	500/500
ALS	Laser Grade OM2 ISO/IEC 11801	50/125	0.20	850/1310	600/600	82/300 <sup>^</sup>	3.5/1.5	510/500	500/500
ALT	Laser Optimized OM3 ISO/IEC 11801	50/125	0.20	850/1310	1000/600	300/300 <sup>^1</sup>	3.5/1.5	2000/500	1500/500
ALE	Laser Optimized OM4 ISO/IEC 11801	50/125	0.20	850/1310	1040/600	550/300 <sup>^</sup>	3.5/1.5	4700/500	3500/500
SLS	Low Water Peak Single-Mode ITU-T G.652.D <sup>6</sup>	9 <sup>2</sup> /125	—	1310/1550	5 km <sup>3</sup>	10 km <sup>4</sup>	0.5/0.5	—	—

\* Minimum Laser Effective Modal Bandwidth (EMB)

\*\* For backward compatibility to LED-based systems, overfilled launch (OFL)

<sup>^</sup> 1310nm CWDM lasers (10GBASE-LX4)

<sup>1</sup> Supports 220-meter 10GBASE-LRM distance or 300-meter 10 GBASE-LRM distance with 300-meter-capable equipment

<sup>2</sup> Typical Mode Field Diameter at 1310nm = 9 microns

<sup>3</sup> 10km for 1310nm 1000BASE-LX10 and 5km for 1310nm 1000BASE-LX

<sup>4</sup> 10km for 1310 10GBASE-LR and 40km for 1550nm 10GBASE-ER

<sup>5</sup> Fiber Codes are available for composite cables containing a wide variety of mixed fiber types within the same cable. Call OCC Customer Service for the Fiber Code for your composite cable configuration.

<sup>6</sup> For certain specialty applications SLS fiber may be ITU-T G.652.A

### Other Fiber Types Available Upon Request

OCC continues to offer the widest variety of standard off-the-shelf and nonstandard fiber types to meet the customer’s special system requirements. If your system design demands a fiber type not included on these two pages, call OCC to see if your needs can be met with one of the many fiber types available. The following fiber types are examples of some of the specialty fibers available from OCC.

Fiber Type	Description	Uses
CST/DBX	100/140 Core/Cladding	Large core fiber used in low data rate industrial applications
FST	200/230 Core/Cladding	Large core fiber used in low data rate industrial applications
Mil-PRF-49291	Single-Mode and Multimode	Military qualified fiber for specific contract QPL
Radiation Hardened	Single-Mode and Multimode	Commercial and Mil grades available
200kpsi Proof Strength	Single-Mode and Multimode	Many fiber types are available with a 200kpsi proof strength for demanding applications
Wide band multimode fiber	Wide band 50µm NextGen Fiber	CWDM ethernet 40–400 gigabit



## (Appendix 3.6) Choosing the Right Cabling System

### What Is the Best Structured Cabling System for My Application?

#### CATEGORY 5E COPPER

- For general purpose use in office, residential, and commercial spaces
- Support for systems up to 1000 Mbps (1000BASE-T)
- Support for Power over Ethernet (PoE) and PoE+; PoE provides low voltage power, up to 15.4 Watts DC; PoE+ provides DC power up to 30 Watts
- Support for Voice over Internet Protocol (VOiP); VOiP provides voice communications using standard IEEE 802.3 Internet data packets
- Optical Cable Corporation products for Category 5e systems:
  - OCC Category 5e UTP copper cables
  - OCC patch panels, multiuser outlet modules, consolidation points, and cross-connects
  - OCC Telco (25-pair) unshielded panels and pre-terminated cable assemblies
  - OCC outlet jacks, keystone and bezel mounting configurations
  - OCC modular cords (quality products made in North America)
  - OCC patch cord test adapters

#### CATEGORY 6 COPPER

- Ideal for office/commercial, colleges and universities, healthcare, and manufacturing/industrial installations
- Support for 10/100/1000/10,000 Mbps applications; UTP Cat 6 systems support 10GBASE-T to 55m
- Enhanced support for PoE and PoE+
- Support for VOiP and networked video and camera systems
- Available in unshielded (UTP) and screened (F/UTP)
- Unshielded systems best for general office, campus locations, and commercial spaces
  - Screened systems provide shielding against EMI/RF for manufacturing/industrial, banking, government, and healthcare
- Suitable for data center applications
- Optical Cable Corporation products for Category 6 systems:
  - OCC Category 6 UTP and F/UTP copper cables
  - OCC patch panels, multiuser outlet modules, consolidation points, and cross-connects, both UTP and screened
  - OCC quadbox UTP and screened patch panels and pre-terminated cable assemblies
  - OCC outlet jacks, keystone (UTP and STP) and bezel (UTP) mounting configurations
  - OCC modular cords, UTP and F/UTP (made in USA 100% performance tested)

#### CATEGORY 6A COPPER

- Recommended for 10 Gigabit applications, such as data centers and IEEE 802.11AC wireless access points
- Recommended for long term infrastructure investment security
- Support for 10/100/1000/10,000 Mbps applications; best choice for 10GBASE-T to 100m
- Best choice for PoE+ and four-pair power (50W); lowest temperature rise
- Enhanced support of networked video and camera systems
- Available in unshielded (UTP) and shielded (F/UTP)
  - Unshielded systems for general office/commercial, campus infrastructure, and manufacturing
  - Shielded systems for data centers, with enhanced 10GBASE-T and future protocol support
- Optical Cable Corporation products for Category 6A systems:
  - OCC Category 6A UTP, F/UTP copper cables
  - OCC patch panels, UTP and shielded
  - OCC Quadbox UTP and shielded patch panels and pre-terminated cable assemblies
  - OCC outlet jacks, keystone (UTP and STP) and bezel (UTP) mounting configurations
  - OCC Cat 6A patch cords (100% performance tested)
  - OCC patch cord test adapters

(Appendix 3.6) Choosing the Right Cabling System

### Ethernet Application and Distance Over OCC Fiber Optic Cabling

OCC consistently outperforms IEEE maximum supportable distances.

			MULTIMODE								SINGLE-MODE	
			62.5/125µm 200MHz (OM1)		50/125UM 500MHz (OM2)		850nm LO 2000MHz 50/125µm (OM3)		850nm LO 4700MHz 50/125µm (OM4)		OS1/OS2	
APPLICATION	IEEE STANDARD	NOMINAL WAVELENGTH (NM)	850	1300	850	1300	850	1300	850	1300	1310	1550
100BASE-FX	802.3u	Supportable Distance (meters)		2000		2000		2000		2000		
1000BASE-SX	802.3z		300 275		600 550		1000 800		1040			
1000BASE-LX	802.3z			600 550		600 550		600 550		600	5000	
10GBASE-SR	802.3ae		33		82		300		550 400			
10GBASE-LRM	802.3aq			300 220		300 220		300 220		300		
10GBASE-LR	802.3ae										10km	
10GBASE-ER	802.3ae											40km
40GBASE-SR4	802.3ba						100m		150m			
40GBASE-LR4	802.3ba										10km	
40GBASE-FR	802.3bg										2km	
100GBASE-SR10	802.3ba						100m		150m			
100GBASE-LR4	802.3ba										10km	
100GBASE-ER4	802.3ba										40km	

■ = OCC Supportable Distance  
 ■ = IEEE 802.3

### Ethernet Application and Distance Over Copper Cabling

APPLICATION	IEEE STANDARD	CAT3 (16MHz)	CAT5e (100MHz)	CAT6 (250MHz)	CAT6A (500MHz)	CAT8 (2000MHz)
10BASE-T	802.3i	100m	100m	100m	100m	100m
100BASE-TX	802.3u		100m	100m	100m	100m
1000BASE-T	802.3ab		100m	100m	100m	100m
10GBASE-T	802.3an			55m*	100m	100m
40GBASE-T	802.3bq					30m

\*TSB-155-A "Guidelines for the Assessment and Mitigation of Installed Category 6 Cabling to Support 10GBASE-T" 10GBASE-T should operate over channel lengths of up to 37 meters of category 6 cabling, and should operate over channel lengths between 37 and 55 meters of category 6 cabling depending on the alien crosstalk environment. Channel lengths over 55 meters may require mitigation.



## (Appendix 3.7) Outer Cable Jacket Materials

The table below is provided as a general reference guide for the properties and typical applications for the common jacket materials used in certain OCC fiber optic cable products. Please refer to the Product Specifications sections within this catalog for the various cable types and fiber counts available with the various jacket materials, or call OCC Sales to discuss your specific application requirements.

## Cable Jacket Material Reference Guide

	Indoor/Outdoor					Indoor		Outdoor					
	Flame-Retardant PVC	Low-Temperature Oil-Resistant PVC	Fluoropolymer Plenum	Flexible Fluoropolymer Plenum	Low-Smoke Zero-Halogen	Flame-Retardant Plenum	Flexible PVC	Medium-Density Polyethylene	Hard Polyurethane	Polyolefin	Polyurethane	Low-Smoke Zero-Halogen Polyurethane	Flame-Retardant Tactical Polyurethane
Material Code	D	J	K	W	Z	S	N	A	R	X	C	G	V
Duct Installation	■	■	■	■	■	■	■	■	■	■	■	■	■
Fungus-Resistant	■	■	■	■	■	■	■	■	■	■	■	■	■
UV-Resistant	■	■	■	■	■	■	■	■	■	■	■	■	■
Water-Resistant	■	■	■	■	■	■	■	■	■	■	■	■	■
Direct Burial	■	■	■	■	■	■	■	■	■	■	■	■	■
Aerial	■	■	■	■	■	■	■	■	■	■	■	■	■
High-Flex Life	■	■	■	■	■	■	■	■	■	■	■	■	■
Soft, Flexible	■	■	■	■	■	■	■	■	■	■	■	■	■
Tight-Bends	■	■	■	■	■	■	■	■	■	■	■	■	■
Low-Friction	■	■	■	■	■	■	■	■	■	■	■	■	■
Petrochemical Resistance	■	■	■	■	■	■	■	■	■	■	■	■	■
Severe Chemical Environments	■	■	■	■	■	■	■	■	■	■	■	■	■
Flame Resistance	■	■	■	■	■	■	■	■	■	■	■	■	■

(Appendix 3.8) Extended Performance Warranty

## Extended Performance Warranty

### Guaranteed Headroom Margin

Network integrity is an essential component of a modern building infrastructure. Increasingly, greater emphasis is being placed on Datacom components and systems that provide both exceptional performance and reliability. OCC recognizes the importance of a dependable structured communications system, and is committed to providing cabling and connectivity solutions that exceed industry standards. By purchasing OCC products, our customers can be assured that they are getting components that are fully warranted by OCC according to the applicable warranty statement.

### Extended Performance 25-Year Channel/Link Guaranteed Headroom Limited Warranty

OCC offers an extended system performance warranty with guaranteed headroom margin to assure installation confidence and dependability. The OCC MDIS Extended Performance 25-Year Channel/Link Limited Warranty certifies that all OCC passive connecting hardware, fiber optic cable and copper cable that have been installed by an MDIS Installer will support all applications designed for data transmission over Fiber Optic, Category 5e, Category 6, or Category 6A as applicable. These components will perform to the applicable channel and permanent link specifications of ANSI/TIA-568-C.2 Clause 6 and ISO/IEC 11801 for passive cabling channels. Additionally, OCC provides a guaranteed headroom margin for OCC Category 5e, Category 6 and Category 6A end-to-end solutions (see guaranteed headroom margin tables on page 2). Permanent links comprised of OCC cable and connecting hardware are automatically covered by the Extended Performance 25-year Channel Warranty when OCC patch cords are used as part of the channel.

The Extended Performance 25-Year Link Limited Warranty is also applicable to direct attach links utilizing OCC field terminable plugs and tested in a modified permanent link configuration using the appropriate OCC field plug test adapter for the performance category of the link under test. They shall be free from defects in material and workmanship for at least 25 years from the date of purchase. A warranty application and additional required project documentation must be received and recorded by OCC prior to certificate issuance.

	SYSTEM	DESCRIPTION	CONNECTOR	PATCH CORD	PATCH PANEL	CABLE
CAT 6A	Cat6A UTP OCC•C6500	Category 6A UTP 10G System	OCC K6A UTP Jack	OCC PC6AU Cat6A UTP Patch Cords	OCC 24/48-Port, Flat or Angled Panels with K6A Jacks	10G Enhanced Category 6A UTP Cable (OCC-U6A4)
	Cat6A F/UTP OCC•CS6500	Category 6A shielded 10G system	OCC K6AS Shielded Jack	OCC PC6AS Cat6A Shielded Patch Cords	OCC 24/48-Port, Flat or Angled Panels with K6A Jacks	10G Enhanced Category 6A F/UTP Cable (OCC-FTP6A4)
CAT 6	Cat6 OCC•C6300	Category 6 High Performance UTP System	OCC KMJA6 UTP Jack	OCC PCSIX Cat6 UTP Patch Cords	OCC 24/48-Port, Flat or Angled Cat6 110-Style Panels	Enhanced Category 6 UTP Cable (OCC-U64H)
	Cat6 OCC•C6000	Category 6 Standard System	KMJA6 UTP Jack	OCC PCSIX Cat6 UTP Patch Cords	OCC 24/48-Port, Flat or Angled Cat6 110-Style Panels	Category 6 UTP Cable (OCC-UE64)
CAT 5e	Cat5e OCC•C5000	Category 5e UTP System	OCC KMJASE UTP Jack	OCC PC5EB Cat5e UTP Patch Cords	OCC 24/48-Port, Flat or Angled Cat5e 110-Style Panels	Category 5e UTP Cable (OCC-U5E4)



 (Appendix 3.8) Extended Performance Warranty

## Guaranteed Headroom Margin

CATEGORY 6A	OCC•CS6500		OCC•C6500	
	CAT 6A SHIELDED (TYPICAL)	CAT 6A SHIELDED (MIN. MARGIN)	CAT 6A UTP (TYPICAL)	CAT 6A UTP (MIN. MARGIN)
Insertion Loss	10%	3%	3%	3%
NEXT	9	4	6	4
PSNEXT	10	5	8	5
ACR	11	7	8	7
PSACR	12	8	10	8
ACR-F (ELFEXT)	8	5	5	4
PSACR-F (PSELFEXT)	8	6	6	5
RL	4	3	7	4

## Cat6A Solutions

- 10GBASE-T Ethernet
- Future 2.5/5GBASE-T Ethernet
- 1000BASE-T Gigabit Ethernet
- POE, POE+, POE++
- HDBASET IEEE P1911

CATEGORY 6	OCC•C6000		OCC•C6300	
	CAT 6 STANDARD (TYPICAL)	CAT 6 STANDARD (MIN. MARGIN)	CAT 6 HI-PERF (TYPICAL)	CAT 6 HI-PERF (MIN. MARGIN)
Insertion Loss	11%	5%	12%	8%
NEXT	6	4	8	6
PSNEXT	7	5	8	7
ACR	8	6	9	7
PSACR	8	7	9	8
ACR-F (ELFEXT)	10	8	14	10
PSACR-F (PSELFEXT)	12	9	14	12

## Cat6 Solutions

- Future 2.5/5GBASE-T Ethernet
- 1000BASE-T Gigabit Ethernet
- POE, POE+, POE++
- HDBASET IEEE P1911

CATEGORY 5e	OCC•C5000	
	CAT 5e (TYPICAL)	CAT 5e (MIN. MARGIN)
Insertion Loss	13%	10%
NEXT	10	9
PSNEXT	11	10
ACR	12	11
PSACR	12	12
ACR-F (ELFEXT)	17	12
PSACR-F (PSELFEXT)	18	13

## Cat5e Solutions

- 1000BASE-T Gigabit Ethernet
- POE, POE+, POE++

(Appendix 3.8) Extended Performance Warranty

Guaranteed Headroom Margin

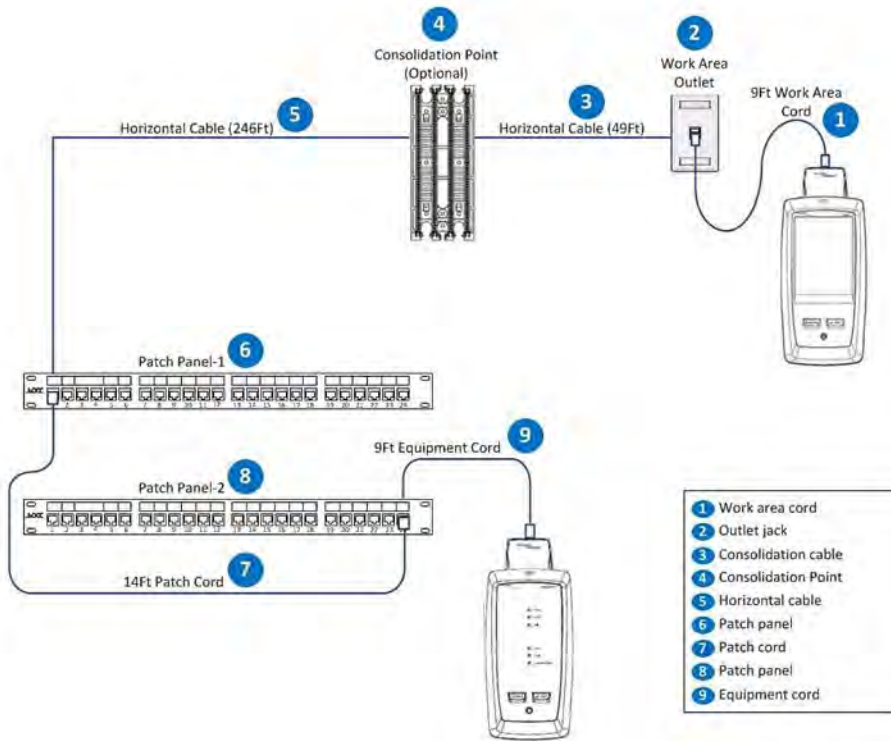

- Five Things to Consider:**
- Know your contractor
  - Ensure error-free work with trained MDIS technicians
  - Ensure a quality installation with quality products
  - Require a 25-year warranty for additional network protection and coverage
  - Request system testing results to ensure cabling system is properly functioning

4-connector channel test configuration

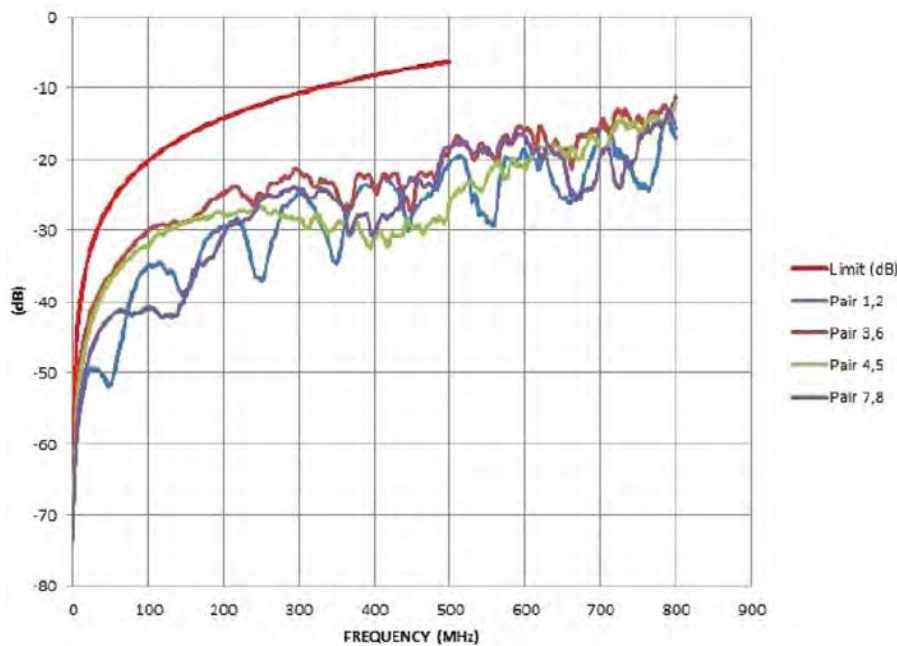

OCC Cat6A Shielded Channel: Typical PSACR-F performance



CERTIFIED INSTALLER



## (Appendix 3.9) Choosing the Right Fiber Optic Enclosure

### Choosing the Right Fiber Optic Enclosure

So much effort goes into choosing the right fiber cable for the job. Did I choose the right construction? Am I using the right jacket material? But just as important is understanding the requirements at both ends of the cable. The right enclosure to use depends on a number of factors:

- How will I mount the fiber enclosure?
- What is the environment in which I am mounting the enclosure?
- How am I terminating the fiber in the enclosure?
- Do I have to re-enter the enclosure in the future?

These and other questions demand a clearly thought out design before the cable and enclosures are chosen and installed. OCC provides a complete solution, allowing the user to contact and utilize a single source for their entire cabling infrastructure. Whether it's a data center or an oil platform, OCC has the right enclosure for any environment.

OCC offers a suite of fiber enclosure product families designed to support fiber terminations in any environment. Fiber enclosures can be broken down into the following product families:

- **RTC/RTS Rackmount Fiber Enclosures:** These products were recently redesigned based upon input from engineers and installers with a wealth of experience in working with fiber. The enclosures are designed to support direct terminations, splicing and plug-and-play applications. They are constructed of rugged, 16-gauge steel, which allows them to be installed in unprotected environments, but many can be found in the data center environment as well. While the RTC enclosure is a fixed shelf, the RTS enclosure contains a sliding and removable inner shelf within the enclosure for a more flexible and convenient work surface.
- **WTC Wallmount Fiber Enclosures:** OCC's rugged wallmount enclosures have long been an industry leader in housing fiber terminations in most any environment. The WTC enclosure is manufactured of 16-gauge, powder-coat, painted steel, making it scratch resistant and generally impervious to everyday damage. These enclosures can accommodate direct terminations, splicing, and plug-and-play applications.
- **Procyon Enclosures:** The Procyon high-density enclosures are a plug-and-play system primarily designed for the data center and enterprise networks. These enclosures provide high-density connectivity accommodating 144 LCs or 48 MTPs (1,152 fibers) in one RU. The Procyon system provides a clear migration path from 10 to 40 and 100 Gigibits/sec speeds required for today's high-bandwidth networks. The plug-and-play cassettes provide a seamless, low-loss transition within the enclosure.
- **Procyon Blade Enclosures:** As the need for high-density cable management in splice-centric applications grows, the Procyon Blade system provides a well managed connectivity solution. The core of the Procyon Blade system is the in-line splice module that houses a simple, organized splice centric work space that provides distinct separation of fiber subgroups within the enclosure. The Procyon blade is ideal for campus-type applications, such as where large quantities of fiber support multiple network applications between buildings. A single enclosure provides an organized structure to store slack cable, splice individual fibers, and take care of patching requirements. Once installed, the user still maintains a structured system for quick and easy adds, moves and changes.
- **Uncontrolled Environment Enclosures:** Whether it's the factory floor, a mining facility or an outdoor application, OCC offers a suite of enclosures for a wide variety of environments. Din Rail enclosures accommodate both copper and fiber optic connectivity and are used, for example, in today's highly connected factory floor. NEMA 3 & 4X rated enclosures seal sensitive fiber terminations from rain and dirt. Many of these products can be custom configured for our customer's specific requirements and applications. The Fibreguard closures are a re-enterable splice closure that requires no special tools. They are tested in accordance with Telcordia GR-771 CORE.



RTC/RTS Enclosures



WTC Wallmount Fiber Enclosure



Procyon Enclosures



DIN Rail Enclosures

Contact OCC for assistance selecting the enclosure that best meets your networking requirements.

## (Appendix 3.10) Choosing the Right Connector

### What You Need to Know about Selecting the Right Connector

Connectors used in Harsh Environments (HE) are not the same products used for other fiber applications, such as data centers or other controlled environments. OCC can recommend various connectors based upon the specifics of your application. These could include a wide variety of connectors, from a commercial discrete connector on a ruggedized cable, to a multifiber ruggedized circular connector to withstand extreme environments. Our wide range of connectors ensure that OCC can provide your ideal solution based on your specific environment, application, and requirements.

All fiber optic connectors used in harsh environments share one common trait: they need to be kept free of debris and humidity in order to function properly. A dirty ceramic ferrule on the tip of a fiber optic connector can attenuate optical transmission, and can even affect the mating connector with the same dirt and debris. Because of this, when commercial connectors are used, they are often placed within closed enclosures for protection from contamination. Once opened for service, the connectors generally are once again exposed to contamination. A commercial connector, however, may be used with a harsh environment cable, especially when transitioning from one environment to another.

Harsh environment connectors provide three fundamental capabilities that non-harsh environment connectors do not:

1. **TRANSITION BETWEEN CONTROLLED AND UNCONTROLLED ENVIRONMENTS**  
HE receptacles typically provide the transition between controlled and uncontrolled environments. They also provide the transition from simplex or duplex fiber link (fiber optic pigtails) to a multi-channel connector. Depending on the application, the sealing style of receptacle and how it is installed will generally dictate the type and family of connectors to be used in the application.
2. **MULTIPLE CHANNEL EFFICIENCY-PAIR GAIN**  
HE plugs and receptacles typically provide the cost advantage of combining multiple fibers into one cable sheath, thus one mated plug and receptacle. At present, OCC HE connector channels range from 2- to 48-fibers (and expanding).
3. **ABILITY TO RESIST ENVIRONMENTAL, MECHANICAL AND HUMAN-INDUCED STRESS**  
HE connectors are designed to endure extreme thermal and mechanical excursion (e.g. vibration, shock, crush, impact and human ergonomic mishaps, fiber pull, mating misalignment, durability, concrete drop). All families of OCC connectors meet various degrees of HE endurance, from temperature and humidity extremes, pressure differentials, high pulling forces on the cables, drops, roll-overs by vehicles, and overall abuse based on the specific application and installation.



### HE Plug and Receptacle Assemblies

HE applications typically involve linking two communication systems together or a remote system to a central communication shelter. HE assemblies are generally defined as "Plug to Plug" with a length of cable in between. They generally mate to panel-mounted receptacles that reduce the multi-channel cable into simplex or duplex connector pigtails, or are available "blunt" (unterminated when delivered).

While HE Plugs generally reside outdoors and are subject to the most stress, the receptacles, which are typically wall or enclosure mounted, see similar stresses. Criteria for plug and receptacle selection include:

- What type of duty cycle will the plug/receptacle experience? Semi-permanently mated or daily mating and un-mating to the receptacles?
- Will dust cover placement be rigorously practiced on all receptacles when not sealed by a mating plug?
- Does the receptacle need to maintain sealing if the dust cover is not used (e.g. "open face")?
- Are there any emergency breakaway requirements for the mated pairs?
- Is there any EMI or other grounding required for the receptacle mounted to a wall/enclosure?
- Will the receptacle be mounted from inside to out or from the outside in? Note that internal jam nut receptacles are mounted from the outside in and external jam receptacles mounted from the inside to the outside. Flange-mount receptacles can be mounted either way, but mounting the flange mount from the outside to inside typically improves sealing performance with the gasket.



## (Appendix 3.10) Choosing the Right Connector

### HE Hybrid\* Plug/Receptacle Applications

Many applications are trending toward remote power in combination with fiber channels to support remote communication or sensors. As active optical components reduce in cost, remote communication is benefiting from higher throughput, longer distance and reduced system latency. Hybrid HE applications require special configurations and connector systems that are capable of gender selection. Gender selection is necessary to maintain a “dead front” condition (insulating from electrical shock) from the source to the load. Grounding is also a major consideration in systems over 50 volts. OCC manufactures several hybrid capable connector systems to accommodate many of these requirements. Some considerations would include:

- What is the maximum power (volt-amperes) being transmitted to the remote system?
- What is the maximum distance from the source (line side) to the load side of the application?
- What is the voltage requirement for the line side device?
- What is the type of current (i.e. AC, DC)?
- How many fiber optic links or channels (one channel = 2 fibers)?
- What type of fiber (50/125µm OM3, 50/125µm OM4, 62.5/125µm, 9/125µm)?
- Will the system require one length, or does it need to expand by adding lengths of cable harness?
- Are agency certifications (UL/CSA) required?

\*Hybrid – Fiber and Copper Combined

### Other Considerations

Understanding the criteria above as it relates to a specific application allows the designer to better choose the correct HE or commercial connector product. Therefore, the specifics of the environmental and mechanical requirements should be discussed with OCC engineers to best define this selection. Other concerns related to application are listed below.

- Is the cable installation static (fixed in place) or dynamic (tactical or reeled and retrieved)?
- What are the worst anticipated temperature extremes for survivability? (including during the deployment or installation period)
- Specific sealing requirements in terms of pressures.
- Are there chemical or caustic contaminations that are of concern?
- Is connector weight a specific concern due to the application?
- Fiber Counts: the cable construction itself — is it already defined in terms of fiber counts, any copper conductors, any special shielding or metallic jacketing/braids, double jackets or rodent protection layers?
- Is the cable length (plug-to-plug) set or variable? Would it be desirable to be able to easily daisy chain assemblies (for instance, mobile systems where the point-to-point distances can vary)?
- Difficult locations (under obstacles), or tightly-spaced due to a large number of connectors entering a cabinet or shelter (must have knuckle room to properly mate).
- Once mated, is it desirable to have an added locking feature to preclude unplanned decoupling?
- Are there existing connector types that need to inter-mate with this new or replacement cable assembly? Are any agency or military certifications required for the application (Mil-Spec, MSHA or others)?

### Summary

Though the implementation for HE Fiber Optic and Hybrid cable harnesses may seem challenging, the goal remains the same as with standard fiber optic links; linking up two fibers to establish link communication. In the case of HE, the link is typically in a nasty environment. Simply contact OCC representatives and we'll gladly guide you through any issues or questions necessary to provide the right solution for your application.



# FIBER OPTIC CABLE – ENTERPRISE

Capacity, speed, scalability, security and network future-proofing are focal considerations as enterprise network infrastructures and data centers adapt and respond to the fierce exponential growth of high-bandwidth data applications, and the inevitable move from 10/40/ to 100G to best serve customers and staff. Large organizations are really a collection of individual units that provide different functions with the goal of achieving a larger, unified purpose. As a result, an organization's networks are often comprised of a range of equipment, often produced by a variety of vendors across a broad campus or remote locations.

OCC produces a wide range of solutions that allow your company to communicate as one. Our hardware, cables, and connectors bring disparate and distant systems into alignment so that your enterprise can function seamlessly.

As a global integrator of enterprise systems, we can help you get the most out of your communication network, whether you are a mature business or a new facility building from the ground up. Our products make enterprise systems work. Our people make it happen.

 Contents

## 4.0 Fiber Optic Cable – Enterprise

### 4.1 INDOOR CABLES (DATA CENTER AND ASSEMBLY)

4.1a	A-Series Assembly – Riser, Plenum and LSZH IEC Rated Cables .....	39
4.1b	A-Series Micro-Assembly – Riser, Plenum and LSZH Cables (2.0mm) .....	41
4.1c	A-Series Micro-Assembly – Riser, Plenum and LSZH Cables (1.6mm).....	43
4.1d	DP-Series Assembly – Mini-Round Duplex: Riser, Plenum, and LSZH Cables .....	45
4.1e	HD-Series – High-Density Plenum Rated Cables .....	47
4.1f	HD-Series – High-Density Riser and LSZH IEC Rated Cables .....	50
4.1g	Furcation Tubing .....	52

### 4.2 INDOOR/OUTDOOR CABLES

4.2a	D-Series Distribution – Riser Rated Cables.....	54
4.2b	D-Series Distribution – Plenum Rated Cables .....	56
4.2c	D-Series Distribution – LSZH OFNR-LS and IEC Rated Cables.....	59
4.2d	B-Series Breakout – Riser Rated Cables.....	61
4.2e	B-Series Breakout – Plenum Rated Cables .....	64
4.2f	B-Series Breakout – LSZH OFNR-LS and IEC Rated Cables.....	66
4.2g	B-Series Breakout – Riser Rated Tray Cables .....	68
4.2h	G-Series Subgrouping – Riser Rated Cables .....	71
4.2i	G-Series Subgrouping – Plenum Rated Cables .....	73
4.2j	G-Series Subgrouping – Riser Rated Tray Cables .....	75
4.2k	HC-Series – High Density Riser Rated Cables .....	77

### 4.3 INDOOR/OUTDOOR ARMORED CABLES

4.3a	D-Series Distribution – Interlocking Armor (ILA) Riser Rated Cables.....	79
4.3b	D-Series Distribution – Interlocking Armor (ILA Plenum Rated Cables .....	81
4.3c	D-Series Distribution – Corrugated Steel Tape Armored Riser Rated Cables.....	83
4.3d	D-Series Distribution – Rodent Deterrent (FRP) Riser Rated Cables.....	85
4.3e	B-Series Breakout – Interlocking Armor (ILA) Riser Rated Cables.....	87
4.3f	B-Series Breakout – Interlocking Armor (ILA Plenum Rated Cables .....	89
4.3g	B-Series Breakout – Rodent Deterrent (FRP) Riser Rated Cables.....	91
4.3h	G-Series Subgrouping – Interlocking Armor (ILA) Riser Rated Cables .....	93
4.3i	G-Series Subgrouping – Interlocking Armor (ILA) Plenum Rated Cables .....	95
4.3j	G-Series Subgrouping – Rodent Deterrent (FRP) Riser Rated Cables.....	97

### 4.4 INDOOR/OUTDOOR HYBRID CABLES

4.4a	CX-Series Hybrid – Copper/Fiber Riser and Plenum Rated Cables .....	99
4.4b	CX-Series Hybrid – UL 1277 Tray Cables .....	101

### 4.5 OUTDOOR AND CAMPUS CABLES

4.5a	D-Series Distribution – Outside Plant Cables.....	102
4.5b	D-Series Distribution – Corrugated Steel Tape (CST) Armored Cables .....	104
4.5c	B-Series Breakout – Corrugated Steel Tape (CST) Armored Cables.....	106
4.5d	G-Series Subgrouping – Corrugated Steel Tape (CST) Armored Cables .....	108
4.5e	HC-Series – High Density Outdoor Cables.....	110
4.5f	MX-Series – Figure-8 Messenger Cables.....	112
4.5g	RM-Series – Round Messenger Cables.....	114

### 4.6 CABLE INFORMATION

4.6a	Laser Ultra-Fox Fiber Performance .....	116
4.6b	Ultra-Fox Fiber Performance .....	117

# INDOOR CABLES (DATA CENTER AND ASSEMBLY)



## (4.1a) A-Series Assembly – Riser, Plenum and LSZH IEC Rated Cables

- 1. Tight-Buffer Optical Fiber
- 2. Aramid Strength Member
- 3. Outer Jacket

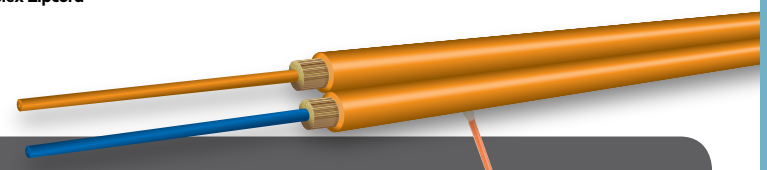
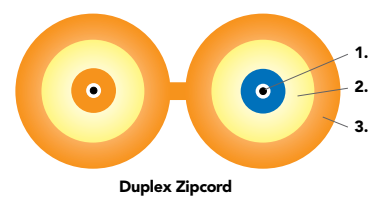
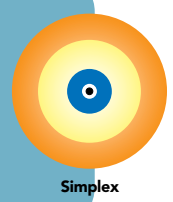

### Applications

- Resilient and flexible for jumpers, patch cords, and pigtails
- Suitable for general-purpose indoor use, such as routing connections in patching systems
- Short "patch cord" cables ideal for links between electronic equipment and main fiber optic cables

### Features

- Flame-retardant for indoor installations
- Compatible with all standard fiber optic connectors designed for small form-factor simplex and duplex connectors, such as MT-RJ and LC connectors
- High-performance tight-buffered coating on each optical fiber for environmental and mechanical protection
- Custom jacket colors are available to match connectors
- Private labeling on the cable outer jacket is also available
- 1 (simplex) and 2 (duplex) fibers available
- Available with bend-tolerant single-mode and multimode fibers
- Zero-halogen cables (Z jacket) meet the requirements of IEC 60754-2
- "N" jacket riser rated cable is flexible for use where it is desirable for cables to hang neatly

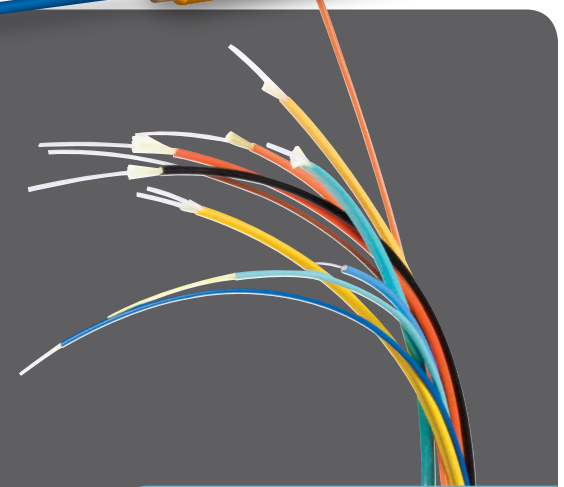

### Applicable Standards

OCC tight-buffered fiber optic assembly cables meet or exceed the functional requirements of the following standards:

- ICEA-S-83-596
- TIA-598
- GR-409-CORE ISSUE 2
- TIA-568
- IEC 60754-2, IEC 60332-3-24, and IEC 61034 for Z-jacket only

## Mechanical and Environmental Performance – A-Series Data 2.9mm

	RISER	PLENUM	ZERO HALOGEN
Jacket type	N	S	Z
Operating temperature	-40°C to +85°C	0°C to +70°C	-40°C to +85°C
Storage temperature	-40°C to +85°C	-40°C to +85°C	-40°C to +85°C
Installation temperature (cable temp.)	-10°C to +60°C	0°C to +60°C	0°C to +60°C
Flame retardancy	Riser*	Plenum**	IEC 60332-3-24 and Riser*
Crush resistance (TIA-455-41)	750 N/cm	500 N/cm	750 N/cm
Flex resistance (TIA-455-104)	7,500 cycles	2,000 cycles	2,000 cycles

\*UL listed type OFNR (UL 1666) and FT4 (CSA C22.2 No. 232) \*\*UL Listed Type OFNP (ANSI/NFPA 262) and FT6 (CSA C22.2 No. 232)





## (4.1a) A-Series Assembly – Riser, Plenum and LSZH IEC Rated Cables

### Cable Characteristics: A-Series Assembly Riser Rated Cables – 2.9mm (N)

FIBER COUNT	DIAMETER MM (IN)	WEIGHT KG/KM (LBS/1,000')	TENSILE LOAD		MINIMUM BEND RADIUS	
			INSTALLATION N (LBS)	OPERATIONAL N (LBS)	INSTALLATION CM (IN)	LONG-TERM CM (IN)
1	2.9 (0.11)	8 (5)	500 (110)	300 (70)	5.0 (2.0)	3.0 (1.2)
2	2.9 x 5.8 (0.11 x 0.23)	16 (11)	1,000 (220)	500 (110)	5.0 (2.0)	3.0 (1.2)

### A-Series Assembly Plenum Rated Cables – 2.9mm (S)

FIBER COUNT	DIAMETER MM (IN)	WEIGHT KG/KM (LBS/1,000')	TENSILE LOAD		MINIMUM BEND RADIUS	
			INSTALLATION N (LBS)	OPERATIONAL N (LBS)	INSTALLATION CM (IN)	LONG-TERM CM (IN)
1	2.9 (0.11)	9 (6)	500 (110)	300 (70)	5.0 (2.0)	3.0 (1.2)
2	2.9 x 5.8 (0.11 x 0.23)	18 (12)	1,000 (220)	500 (110)	5.0 (2.0)	3.0 (1.2)

### A-Series Assembly LSZH IEC Rated Cables – 2.9mm (Z)

FIBER COUNT	DIAMETER MM (IN)	WEIGHT KG/KM (LBS/1,000')	TENSILE LOAD		MINIMUM BEND RADIUS	
			INSTALLATION N (LBS)	OPERATIONAL N (LBS)	INSTALLATION CM (IN)	LONG-TERM CM (IN)
1	2.9 (0.11)	8 (5)	500 (110)	300 (70)	5.0 (2.0)	3.0 (1.2)
2	2.9 x 5.8 (0.11 x 0.23)	16 (11)	1,000 (220)	500 (110)	5.0 (2.0)	3.0 (1.2)

## Ordering Information

Digit No:	1	2	3	4	5	6	7	8	9	10	11	12
	<b>A</b>	<b>X</b>	<b>0</b>	<b>0</b>					<b>9</b>			
1	Assembly Series = <b>A</b>											
2	Diameter: 2.9mm = <b>X</b>											
3 – 5	Fiber count: Simplex = <b>001</b> ; Duplex = <b>002</b>											
6	Jacket type:											
	Flexible PVC = <b>N</b>											
	Plenum = <b>S</b>											
	Flame-Retardant Zero-Halogen = <b>Z</b>											
7 – 9	Fiber type: (see Laser Ultra-Fox Fiber Performance Table, pg. 116)											
10	Laser Ultra-Fox fiber with 900µm tight-buffer = <b>9</b>											
	Laser Ultra-Fox fiber with 900µm ES2 (Easy Strip) = <b>2</b>											
11	Jacket color:											
	62.5µm multimode (WLS, WLX) – Orange = <b>O</b>											
	50µm multimode (ALS, ALX) – Orange = <b>O</b>											
	50µm 10 Gigabit (ALT, ALE) – Aqua = <b>Q</b>											
	Single-mode (SLX, SLA) – Yellow = <b>Y</b>											
12	Rating: Riser = <b>R</b> ; Plenum = <b>P</b> ; Flame-Retardant Zero-Halogen = <b>E</b>											

**Example:** 2-fiber (duplex) 2.9mm assembly cable using OM3 50µm laser optimized Ultra-Fox, riser rated aqua jacket

**A X 0 0 2 N A L T 9 Q R**

# INDOOR CABLES (DATA CENTER AND ASSEMBLY)



## (4.1b) A-Series Micro-Assembly – Riser, Plenum and LSZH Cables (2.0mm)

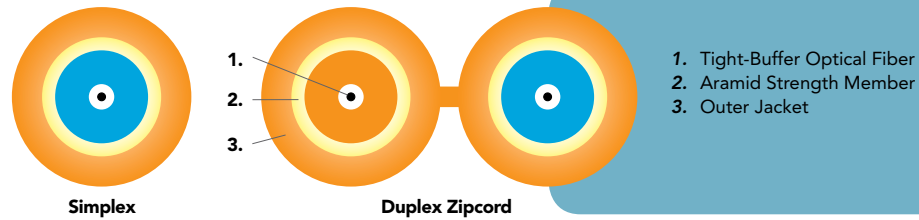

Simplex

Duplex Zipcord

1. Tight-Buffer Optical Fiber
2. Aramid Strength Member
3. Outer Jacket

### Applications

- Resilient and flexible for jumpers, patch cords, and pigtails
- Suitable for general-purpose indoor use, such as routing connections in patching systems
- Short "patch cord" cables ideal for links between electronic equipment and main fiber optic cables

### Features

- Flame-retardant for indoor installations
- Compatible with all standard fiber optic connectors designed for small form-factor simplex and duplex connectors, such as MT-RJ and LC connectors
- High-performance tight-buffered coating on each optical fiber for environmental and mechanical protection
- Custom jacket colors are available to match connectors; private labeling on the cable outer jacket is also available
- 1 (simplex) and 2 (duplex) fibers available
- Micro-assembly cables available in 2.0 or 1.6mm diameters
- Available with bend-insensitive single-mode and multimode fiber
- Zero-halogen cables (Z jacket) meet the requirements of IEC 60754-2

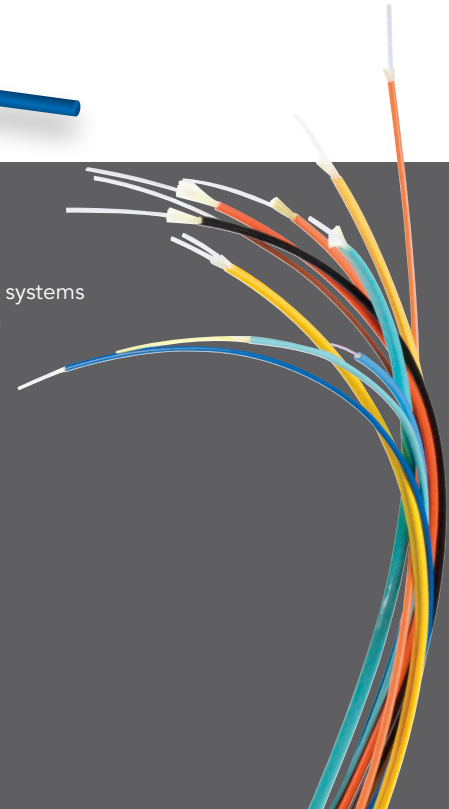

## Mechanical and Environmental Performance – Micro-Assembly Data 2.0mm

	RISER	PLENUM	ZERO HALOGEN
Jacket type	D	S	Z
Operating temperature	-40°C to +85°C	0°C to 70°C	-40°C to +85°C
Storage temperature	-55°C to +85°C	-40°C to 85°C	-40°C to +85°C
Installation temperature (cable temp.)	-10°C to +60°C	0°C to 60°C	0°C to +60°C
Flame retardancy	Riser*	Plenum**	—
Crush resistance (TIA-455-41)	500 N/cm	500 N/cm	500 N/cm
Flex resistance (TIA-455-104)	2,000 cycles	1,000 cycles	1,000 cycles

\*UL listed type OFNR (UL 1666) and FT4 (CSA C22.2 No. 232)

\*\*UL listed type OFNP (ANSI/NFPA 262) and FT6 (CSA C22.2 No. 232)



## (4.1b) A-Series Micro-Assembly – Riser, Plenum and LSZH Cables (2.0mm)

## Cable Characteristics:

## A-Series Micro-Assembly Riser Rated Cables – 2.0mm (D)

FIBER COUNT	DIAMETER MM (IN)	WEIGHT KG/KM (LBS/1,000')	TENSILE LOAD		MINIMUM BEND RADIUS	
			INSTALLATION N (LBS)	OPERATIONAL N (LBS)	INSTALLATION CM (IN)	LONG-TERM CM (IN)
1	2.0 (0.08)	4 (3)	300 (67)	160 (36)	3.8 (1.5)	2.5 (1.0)
2	2.0x4.5 (0.08x0.18)	9 (6)	600 (135)	300 (67)	3.8 (1.5)	2.5 (1.0)

## A-Series Micro-Assembly Plenum Rated Cables – 2.0mm (S)

FIBER COUNT	DIAMETER MM (IN)	WEIGHT KG/KM (LBS/1,000')	TENSILE LOAD		MINIMUM BEND RADIUS	
			INSTALLATION N (LBS)	OPERATIONAL N (LBS)	INSTALLATION CM (IN)	LONG-TERM CM (IN)
1	2.0 (0.08)	5 (3)	300 (67)	160 (36)	3.8 (1.5)	2.5 (1.0)
2	2.0x4.5 (0.08x0.18)	10 (6)	600 (135)	300 (67)	3.8 (1.5)	2.5 (1.0)

## A-Series Micro-Assembly Zero-Halogen Cables – 2.0mm (Z)

FIBER COUNT	DIAMETER MM (IN)	WEIGHT KG/KM (LBS/1,000')	TENSILE LOAD		MINIMUM BEND RADIUS	
			INSTALLATION N (LBS)	OPERATIONAL N (LBS)	INSTALLATION CM (IN)	LONG-TERM CM (IN)
1	2.0 (0.08)	5 (3)	300 (67)	160 (36)	3.8 (1.5)	2.5 (1.0)
2	2.0x4.5 (0.08x0.18)	9 (6)	600 (135)	300 (67)	3.8 (1.5)	2.5 (1.0)

## Ordering Information

Digit No:	A	E							9		
1	Assembly Series = <b>A</b>										
2	Diameter: 2.0mm = <b>E</b>										
3 – 5	Fiber count: Simplex = <b>001</b> ; Duplex = <b>002</b>										
6	Jacket type:										
	Standard Riser = <b>D</b>										
	Plenum = <b>S</b>										
	Flame-Retardant Zero-Halogen = <b>Z</b>										
7 – 9	Fiber type: (see Ultra-Fox Plus Fiber Performance Table, pg. 117)										
10	Laser Ultra-Fox fiber with 900µm tight-buffer = <b>9</b>										
11	Jacket color:										
	62.5µm multimode (WLS, WLX) – Orange = <b>O</b>										
	50µm multimode (ALS, ALX) – Orange = <b>O</b>										
	50µm 10 Gigabit (ALT, ALE) – Aqua = <b>Q</b>										
	Single-mode (SLX, SLA) – Yellow = <b>Y</b>										
12	Rating: Riser = <b>R</b> ; Plenum = <b>P</b> ; Flame-Retardant Zero-Halogen = <b>Z</b>										

**Example:** 2-fiber (duplex) 2.0mm micro-assembly cable using 62.5µm standard Laser Ultra-Fox fiber, riser rated orange jacket

**A E 0 0 2 D W L S 9 O R**

## (4.1c) A-Series Micro-Assembly – Riser, Plenum and LSZH Cables (1.6mm)



### Mechanical and Environmental Performance – Micro-Assembly Data 1.6mm

	RISER	PLENUM	ZERO HALOGEN
Jacket type	D	S	Z
Operating temperature	-40°C to +85°C	0°C to 70°C	-40°C to +85°C
Storage temperature	-55°C to +85°C	-40°C to 85°C	-40°C to +85°C
Installation temperature (cable temp.)	-10°C to +60°C	0°C to 60°C	0°C to +60°C
Flame retardancy	Riser*	Plenum**	—
Crush resistance (TIA-455-41)	500 N/cm	500 N/cm	500 N/cm
Flex resistance (TIA-455-104)	2,000 cycles	1,000 cycles	1,000 cycles

\*UL listed type OFNR (UL 1666) and FT4 (CSA C22.2 No. 232)

\*\*UL listed type OFNP (ANSI/NFPA 262) and FT6 (CSA C22.2 No. 232)

### Cable Characteristics:

#### A-Series Micro-Assembly Riser Rated Cables – 1.6mm (D)

FIBER COUNT	DIAMETER MM (IN)	WEIGHT KG/KM (LBS/1,000')	TENSILE LOAD		MINIMUM BEND RADIUS	
			INSTALLATION N (LBS)	OPERATIONAL N (LBS)	INSTALLATION CM (IN)	LONG-TERM CM (IN)
1	1.6 (0.06)	2.7 (1.8)	355 (80)	130 (30)	3.8 (1.5)	2.5 (1.0)
2	1.6x3.5 (0.06x0.14)	7 (4.7)	450 (100)	167 (38)	3.8 (1.5)	2.5 (1.0)

#### A-Series Micro-Assembly Plenum Rated Cables – 1.6mm (S)

FIBER COUNT	DIAMETER MM (IN)	WEIGHT KG/KM (LBS/1,000')	TENSILE LOAD		MINIMUM BEND RADIUS	
			INSTALLATION N (LBS)	OPERATIONAL N (LBS)	INSTALLATION CM (IN)	LONG-TERM CM (IN)
1	1.6 (0.06)	2.7 (1.8)	355 (80)	130 (30)	3.8 (1.5)	2.5 (1.0)
2	1.6x3.5 (0.06x0.14)	7 (4.7)	450 (100)	167 (38)	3.8 (1.5)	2.5 (1.0)

#### A-Series Micro-Assembly Zero-Halogen Cables – 1.6mm (Z)

FIBER COUNT	DIAMETER MM (IN)	WEIGHT KG/KM (LBS/1,000')	TENSILE LOAD		MINIMUM BEND RADIUS	
			INSTALLATION N (LBS)	OPERATIONAL N (LBS)	INSTALLATION CM (IN)	LONG-TERM CM (IN)
1	1.6 (0.06)	2.7 (1.8)	355 (80)	130 (30)	3.8 (1.5)	2.5 (1.0)
2	1.6x3.5 (0.06x0.14)	7 (4.7)	450 (135)	167 (38)	3.8 (1.5)	2.5 (1.0)





## (4.1c) A-Series Micro-Assembly – Riser, Plenum and LSZH Cables (2.0mm)

## Ordering Information

	A	C								9		
Digit No:	1	2	3	4	5	6	7	8	9	10	11	12
1	Assembly Series = <b>A</b>											
2	Diameter: 1.6mm = <b>C</b>											
3 – 5	Fiber count: Simplex = <b>001</b> ; Duplex = <b>002</b>											
6	Jacket type: Standard Riser = <b>D</b> Plenum = <b>S</b> Flame-Retardant Zero-Halogen = <b>Z</b>											
7 – 9	Fiber type: (see Ultra-Fox Plus Fiber Performance Table, pg. 117)											
10	Laser Ultra-Fox fiber with 900µm tight-buffer = <b>9</b>											
11	Jacket color: 62.5µm multimode (WLS, WLX) – Orange = <b>O</b> 50µm multimode (ALS, ALX) – Orange = <b>O</b> 50µm 10 Gigabit (ALT, ALE) – Aqua = <b>Q</b> Single-mode (SLX, SLA) – Yellow = <b>Y</b>											
12	Rating: Riser = <b>R</b> ; Plenum = <b>P</b> ; Flame-Retardant Zero-Halogen = <b>Z</b>											

**Example:** 2-fiber (duplex) 1.6mm micro-assembly cable using OM3, laser optimized bend-insensitive fiber, riser rated, aqua jacket

**A C 0 0 2 D A L T 9 Q R**

# INDOOR CABLES (DATA CENTER AND ASSEMBLY)



## (4.1d) DP-Series Assembly – Mini-Round Duplex: Riser, Plenum and LSZH Cables

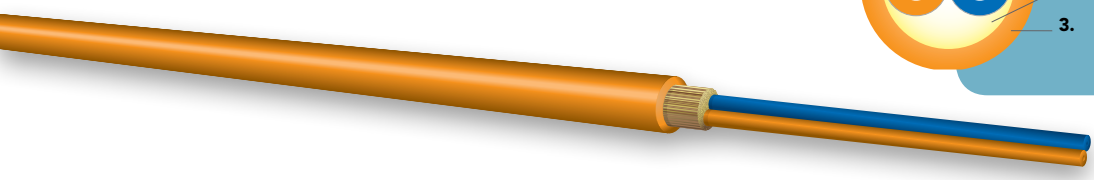

1. Tight-Buffer Optical Cable
2. Aramid Strength Member
3. Outer Jacket

### Applications

- Flexible, resilient for interconnect applications
- Small size for dense usage
- For small form-factor duplex connectors, such as MT-RJ

### Features

- 900µm buffer is standard; 600µm buffer is optional for riser rated cables
- Zero-halogen construction to IEC 60754-2 available
- 900µm tight-buffer for excellent mechanical and environmental performance

### Applicable Standards

OCC tight-buffered fiber optic mini-round cables meet or exceed the functional requirements of the following standards:

- ICEA-S-83-596
- GR-409-CORE ISSUE 2

## Mechanical and Environmental Performance – Mini-Round Duplex

	RISER	PLENUM	ZERO HALOGEN
Jacket type	N	S	Z
Operating temperature	-40°C to +85°C	0°C to +70°C	-40°C to +85°C
Storage temperature	-40°C to +85°C	-40°C to +85°C	-40°C to +85°C
Installation temperature (cable temp.)	-10°C to +60°C	0°C to +60°C	20°C to +60°C
Flame retardancy	Riser*	Plenum**	—
Crush resistance (TIA-455-41)	750 N/cm	500 N/cm	750 N/cm
Flex resistance (TIA-455-104)	5,000 cycles	1,000 cycles	1,000 cycles

\*UL listed type OFNR (UL 1666) and FT4 (CSA C22.2 No. 232)  
 \*\*UL listed type OFNP (ANSI/NFPA 262) and FT6 (CSA C22.2 No. 232)



## (4.1d) DP-Series Assembly – Mini-Round Duplex: Riser, Plenum and LSZH Cables

### Cable Characteristics: D-Series Mini-Round Duplex Riser-Assembly Cables (N)

FIBER COUNT	DIAMETER MM (IN)	WEIGHT KG/KM (ILS/1000')	INSTALLATION TENSILE LOAD N (LBS)	OPERATIONAL TENSILE LOAD N (LBS)	MINIMUM BEND RADIUS INSTALLATION CM (IN)	MINIMUM BEND RADIUS LONG-TERM CM (IN)
2	2.9 (0.11)	8 (5)	500 (110)	300 (70)	5.0 (2.0)	2.9 (1.1)

### D-Series Mini-Round Duplex Plenum-Assembly Cables (S)

FIBER COUNT	DIAMETER MM (IN)	WEIGHT KG/KM (ILS/1000')	INSTALLATION TENSILE LOAD N (LBS)	OPERATIONAL TENSILE LOAD N (LBS)	MINIMUM BEND RADIUS INSTALLATION CM (IN)	MINIMUM BEND RADIUS LONG-TERM CM (IN)
2	2.9 (0.11)	8 (5)	500 (110)	300 (70)	5.0 (2.0)	2.9 (1.1)

### D-Series Mini-Round Duplex – Zero-Halogen (Z)

FIBER COUNT	DIAMETER MM (IN)	WEIGHT KG/KM (ILS/1000')	INSTALLATION TENSILE LOAD N (LBS)	OPERATIONAL TENSILE LOAD N (LBS)	MINIMUM BEND RADIUS INSTALLATION CM (IN)	MINIMUM BEND RADIUS LONG-TERM CM (IN)
2	2.9 (0.11)	8 (5)	500 (110)	300 (70)	5.0 (2.0)	2.9 (1.1)

## Ordering Information

Digit No:	D	P	0	0	2							
1 – 2	D-Series Mini-Round Duplex 2.9mm Ultra-Fox = <b>DP</b>											
3 – 5	Fiber count = <b>002</b>											
6	Jacket type: Indoor Riser = <b>N</b> Indoor Plenum = <b>S</b> Flame Retardant Zero Halogen = <b>Z</b>											
7 – 9	Fiber type: (see Laser Ultra-Fox Fiber Performance Table, pg. 117)											
10	Ultra-Fox fiber with 900µm tight-buffer = <b>9</b> Ultra-Fox fiber with 900µm ES2 (Easy Strip) = <b>2</b>											
11	Jacket color: 62.5µm multimode (WLS, WLX) – Orange = <b>O</b> 50µm multimode (ALS, ALX) – Orange = <b>O</b> 50µm 10 Gigabit (ALT, ALE) – Aqua = <b>Q</b> Single-mode (SLX, SLA) – Yellow = <b>Y</b>											
12	Rating: Riser = <b>R</b> ; Plenum = <b>P</b> ; LSZH = <b>Z</b>											

**Example:** 2-fiber, 2.9mm mini-round duplex indoor riser cable using 62.5µm standard Laser Ultra-Fox optimized fiber, orange jacket

**D P 0 0 2 N W L S 9 O R**

## (4.1e) HD-Series – High-Density Plenum Rated Cables

### 12 Fibers

1. 250µm Acrylate Fiber
2. Aramid Strength Member
3. Flame-Retardant Low-Smoke Plenum Jacket

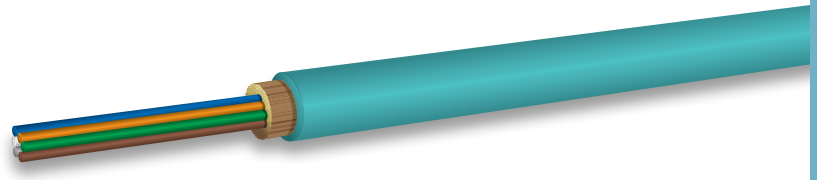
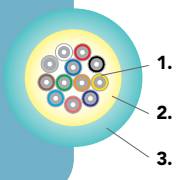

### Applications

- Ideal for use in trunk, LAN, data center, 40/100 GbE and other high-density applications where small size, lightweight, and very small bend radii are required
- Inventory one cable type to cover the complete range of legacy ST, SC, FC, LC, and advanced MPO style connectivity
- Installations in ducts, plenums, risers, and air-handling spaces
- Space-saving applications where MTP can be directly terminated to the subcables
- Small diameter, which saves space and greatly increases capacity in tray systems, improves cable management and increases cooling power efficiency and cost for under raised floor cabling systems in data centers

### Features

- Smaller and lighter than conventional subgrouped cable
- Ideal for installation in areas with limited space or tight bends
- Easily ribbonized for use with MPO-style connectors
- 8- to 216-fiber premises applications
- UL listed in accordance with NEC sections 770.179(a)
- Superior bend performance with negligible dB loss at very small bend radii
- Standard with bend-insensitive fiber: OM3 and OM4 50µm fiber or ITU-T G.657.A1 and ITU-T G.657.A2 single-mode fiber
- HZ series is ideal for use with 24-fiber MPO connectors

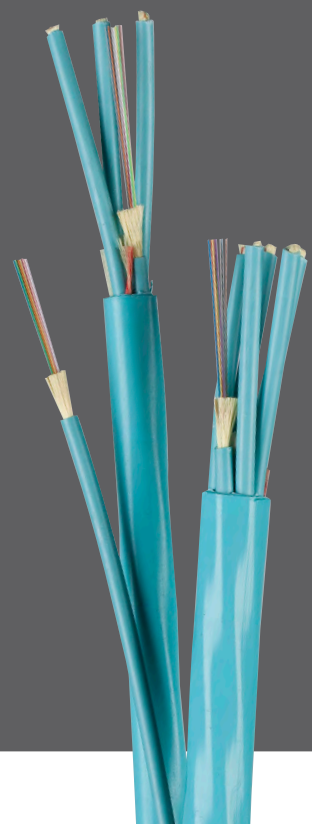

### Mechanical and Environmental Performance

	INDOOR/OUTDOOR
Operating temperature	0°C to +70°C
Storage temperature	-40°C to +70°C
Installation temperature (cable temp.)	0°C to +60°C
Flame retardancy	UL Listed Type OFNP (ANSI/NFPA 262) and FT6 (CSA C22.2 NO. 232)
Crush resistance (TIA-455-41)	35 N/cm
Flex resistance (TIA-455-104)	25 cycles

### Applicable Standards

OCC indoor high-density cables meet or exceed the functional requirement of the following standards:

- ICEA-S-83-596
- GR-409-CORE ISSUE 2
- TIA-568
- TIA-598



 (4.1e) HD-Series – High-Density Plenum Rated Cables

## Cable Characteristics: HD-Series Plenum Cable (“S” Jacket)

FIBER COUNT	DIAMETER MM (IN)	WEIGHT KG/KM (LBS/1,000')	TENSILE LOAD		MINIMUM BEND RADIUS	
			INSTALLATION N (LBS)	OPERATIONAL N (LBS)	INSTALLATION CM (IN)	LONG-TERM CM (IN)
8	3.0 (0.12)	9.1 (6)	500 (110)	300 (70)	4.5 (1.8)	3.0 (1.2)
12	3.0 (0.12)	9.1 (6)	500 (110)	300 (70)	4.5 (1.8)	3.0 (1.2)
24	10.2 (0.40)	103 (69)	1,335 (300)	667 (150)	15.3 (6.0)	10.2 (4.0)
36	10.2 (0.40)	103 (69)	1,335 (300)	667 (150)	15.3 (6.0)	10.2 (4.0)
48	10.2 (0.40)	103 (69)	1,335 (300)	667 (150)	15.3 (6.0)	10.2 (4.0)
72	11.7 (0.46)	148 (99)	1,335 (300)	667 (150)	17.6 (6.9)	11.7 (4.6)
84	13.0 (0.51)	174 (117)	1,335 (300)	667 (150)	19.5 (7.7)	13.0 (5.1)
96	14.0 (0.55)	204 (137)	1,335 (300)	667 (150)	21.0 (8.3)	14.0 (5.5)
108	15.2 (0.60)	236 (159)	1,335 (300)	667 (150)	22.8 (9.0)	15.2 (6.0)
120	15.9 (0.63)	268 (180)	1,335 (300)	667 (150)	23.9 (9.4)	15.9 (6.3)
144	16.0 (0.63)	246 (165)	1,335 (300)	667 (150)	24.0 (9.4)	16.0 (6.3)
168	16.0 (0.63)	246 (165)	1,335 (300)	667 (150)	24.0 (9.4)	16.0 (6.3)

## Cable Characteristics: HD-Series Plenum Cables (“W” Jacket)

FIBER COUNT	DIAMETER MM (IN)	WEIGHT KG/KM (LBS/1,000')	TENSILE LOAD		MINIMUM BEND RADIUS	
			INSTALLATION N (LBS)	OPERATIONAL N (LBS)	INSTALLATION CM (IN)	LONG-TERM CM (IN)
24	9.1 (0.36)	78 (52)	1,335 (300)	667 (150)	13.7 (5.4)	9.1 (3.6)
36	9.1 (0.36)	78 (52)	1,335 (300)	667 (150)	13.7 (5.4)	9.1 (3.6)
48	9.1 (0.36)	78 (52)	1,335 (300)	667 (150)	13.7 (5.4)	9.1 (3.6)
72	11.1 (0.44)	117 (79)	1,335 (500)	667 (150)	16.7 (6.6)	11.1 (4.4)
84	11.9 (0.47)	144 (97)	1,335 (500)	667 (150)	17.9 (7.0)	11.9 (4.7)
96	13.1 (0.52)	179 (120)	1,335 (500)	667 (150)	19.7 (7.8)	13.1 (5.2)
108	14.1 (0.56)	208 (140)	1,335 (500)	667 (150)	21.2 (8.3)	14.1 (5.6)
120	15.0 (0.59)	237 (159)	1,335 (500)	667 (150)	22.5 (8.9)	15.0 (5.9)
144	15.6 (0.61)	216 (145)	1335 (300)	667 (150)	23.4 (9.2)	15.6 (6.1)
168	15.6 (0.61)	216 (145)	1335 (300)	667 (150)	23.4 (9.2)	15.6 (6.1)
180	17.0 (0.67)	262 (176)	1335 (300)	667 (150)	39.3 (15.5)	17.0 (6.7)
192	17.0 (0.67)	262 (176)	1335 (300)	667 (150)	39.3 (15.5)	17.0 (6.7)
204	17.0 (0.67)	262 (176)	1335 (300)	667 (150)	39.3 (15.5)	17.0 (6.7)
216	17.0 (0.67)	262 (176)	1335 (300)	667 (150)	39.3 (15.5)	17.0 (6.7)

## (4.1e) HD-Series – High-Density Plenum Rated Cables



### Cable Characteristics: HZ-Series Plenum Cable

FIBER COUNT	DIAMETER MM (IN)	WEIGHT KG/KM (LBS/1,000')	TENSILE LOAD		MINIMUM BEND RADIUS	
			INSTALLATION N (LBS)	OPERATIONAL N (LBS)	INSTALLATION CM (IN)	LONG-TERM CM (IN)
8–24	3.0 x 6.2 (0.37 x 0.24)	18.2 (12.1)	500 (110)	300 (70)	4.5 (1.8)	3.0 (1.2)

### Ordering Information

	H					S				J		P
Digit No:	1	2	3	4	5	6	7	8	9	10	11	12
	1 – 2	High-density with individual subcables (008–168 fibers) = <b>HD</b> High-density zipcord style (008–024 fibers) = <b>HZ</b>										
	3 – 5	Fiber count: <b>008–168</b>										
	6	Jacket type:										
		Soft Plenum (Indoor) = <b>S</b> (8–168 fibers)										
		Fluoropolymer = <b>W</b> (24–216 fibers)										
	7 – 9	Fiber type: (see Laser Ultra-Fox Fiber Performance Table, pg. 116)										
	10	245µm fiber = <b>J</b>										
	11	Standard jacket color:										
		50µm 10 Gigabit multimode (ALT, ALE) – Aqua = <b>Q</b>										
		Single-mode (SLA, SLB) – Yellow = <b>Y</b>										
	12	Rating: Plenum = <b>P</b>										

**Example:** 24-fiber cable using 50µm bend-insensitive OM4 fiber, plenum rated, in a zipcord-style

**H Z 0 2 4 S A L E J Q P**

## (4.1f) HD-Series – High-Density Riser and LSZH IEC Rated Cables

1. 250µm Acrylate Fiber
2. Aramid Strength Member
3. Flame-Retardant, Low-Smoke Jacket

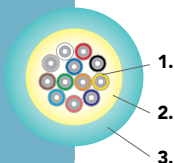

### Applications

- Ideal for use in trunk, LAN, data center, 40/100 GbE, and other high-density applications where small size, lightweight, and very small bend radii are required
- Inventory one cable type to cover the complete range of ST, SC, FC, LC, and advanced MPO-style connectivity
- Applications where tight bends and flexibility are needed
- Space-saving applications where an MPO can be directly terminated to the cable
- Small diameter, which saves space and greatly increases capacity in tray systems, improves cable management and increases cooling power efficiency and cost for under raised floor cabling systems in data centers

### Features

- Ideal for installation in areas with limited space or tight bends
- Easily ribbonized for use with MPO style connectors
- 8- and 12-fiber premises applications
- UL listed OFNR-LS in accordance with NEC sections 770.179(b) for use in vertical runs in building riser shafts or from floor to floor
- Flame-retardant, low-smoke and zero-halogen to applicable IEC standards: 60332-3-24, 61034-2 and 60754-2
- Cable materials are UV and fungus resistant
- Superior bend performance with negligible dB loss at very small bend radii



### Applicable Standards

OCC Indoor high-density cables meet or exceed the functional requirement of the following standards:

- ICEA-S-83-596
- GR-409-CORE ISSUE 2
- TIA 568
- TIA-598
- UL 1666
- IEC 60332-3-24
- IEC 60754-2
- IEC 61034-2
- UL 1685
- UL 1651

### Mechanical and Environmental Performance

	INDOOR/OUTDOOR
Operating temperature	0°C to +70°C
Storage temperature	-40°C to +70°C
Installation temperature	0°C to +60°C (actual temperature of cable)
Flame retardancy	UL listed type OFNR-LS (UL 1666 and 1685) and FT4 (CSA C22.2 No. 232)
Mechanical performance	Meets ICEA-S-83-596 interconnect cable performance requirements

## (4.1f) HD-Series – High-Density Riser and LSZH IEC Rated Cables



### Cable Characteristics: Indoor High-Density 8- and 12-fiber LSZH IEC Rated Cables

FIBER COUNT	DIAMETER MM (IN)	WEIGHT KG/KM (LBS/1,000')	TENSILE LOAD		MINIMUM BEND RADIUS	
			INSTALLATION N (LBS)	OPERATIONAL N (LBS)	INSTALLATION CM (IN)	LONG-TERM CM (IN)
8	3.0 (0.12)	8.6 (6)	500 (110)	300 (70)	4.5 (1.8)	3.0 (1.2)
12	3.0 (0.12)	8.6 (6)	500 (110)	300 (70)	4.5 (1.8)	3.0 (1.2)

### Ordering Information

	H	D				Z				J		E
Digit No:	1	2	3	4	5	6	7	8	9	10	11	12
	1 – 2	High-density = <b>HD</b>										
	3 – 5	Fiber count: 8-fiber = <b>008</b> ; 12-fiber = <b>012</b>										
	6	Jacket type: LSZH = <b>Z</b>										
	7 – 9	Fiber type: (see Laser Ultra-Fox Fiber Performance Table, pg. 116)										
	10	245µm fiber = <b>J</b>										
	11	Standard jacket color:										
		50µm 10 Gigabit multimode (ALT, ALE) – Aqua = <b>Q</b>										
		Single-mode – Yellow = <b>Y</b>										
	12	Rating: Flame-Retardant Zero-Halogen = <b>E</b>										

**Example:** 12-fiber cable using 50µm bend-insensitive OM4 fiber

H	D	0	1	2	Z	A	L	E	J	Q	E
---	---	---	---	---	---	---	---	---	---	---	---



## (4.1g) Furcation Tubing

### Applications

- Ideal for adding protection and strength to 245 $\mu$ m fibers or 900 $\mu$ m tight-buffered fibers for direct termination to connectors
- Can be used to produce fanout assemblies

### Features

- Aramid yarn included between the inner tube and outer jacket to provide strain relief for the connector
- Inner tube sizes include
  - 470 $\mu$ m ID with a 900 $\mu$ m OD used with 245 $\mu$ m fiber
  - 1,100 $\mu$ m ID with a 1,400 $\mu$ m OD used with 900 $\mu$ m buffered fibers
- Custom colors available
- Outer jacket materials to meet application requirement
- Custom tubing available upon request
- Wide operating temperature range

### Breakout Tubing

1. Hard Elastomeric Tube
2. Aramid Strength Member
3. Outer Jacket

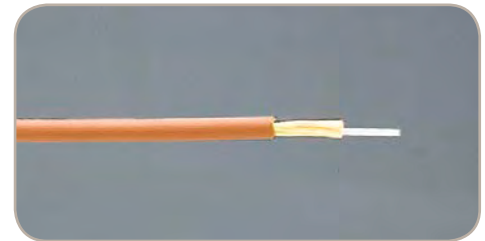
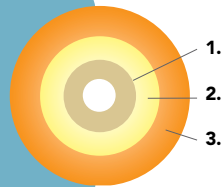

### Duplex Assembly Tubing

1. Hard Elastomeric Tube
2. Aramid Strength Member
3. Outer Jacket

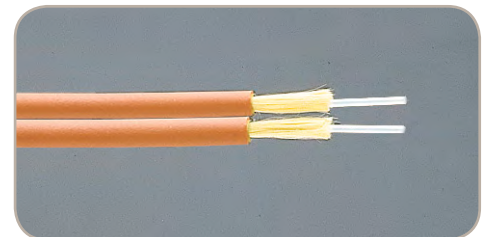
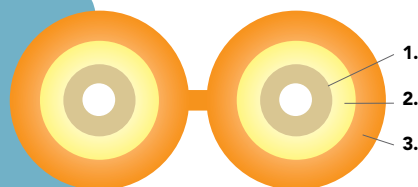

## (4.1g) Furcation Tubing – Product Specifications

### Furcation Tube Specifications

OUTER JACKET	OUTER DIAMETER (MM)	INNER TUBE DIMENSIONS (ID/OD MICRONS)	NUMBER OF TUBES	TEMPERATURE RANGE
D	2.9	470/900 and 1,100/1,400	1 or 2	-40°C to +85°C
D	2	470/900 and 1,100/1,400	1	-40°C to +85°C
Z	2.9	470/900 and 1,100/1,400	1 or 2	-20°C to +70°C
Z	2	470/900 and 1,100/1,400	1	-20°C to +70°C
V	2.9	470/900 and 1,100/1,400	1 or 2	-40°C to +85°C
V	2	470/900 and 1,100/1,400	1	-40°C to +85°C
N	2.9	470/900 and 1,100/1,400	1	-40°C to +85°C
C	2.9	470/900 and 1,100/1,400	1	-40°C to +85°C
S	2.9	470/900 and 1,100/1,400	1	-10°C to +85°C

### Cable Characteristics

TUBE OD	NUMBER OF TUBES	TENSILE LOAD		MINIMUM BEND RADIUS	
		INSTALLATION N (LBS)	OPERATIONAL N (LBS)	INSTALLATION CM (IN)	LONG-TERM CM (IN)
2.9	1	500 (110)	300 (70)	5.0 (2.0)	3.0 (1.2)
2.9	2	1,000 (225)	500 (110)	5.0 (2.0)	3.0 (1.2)
2.0	1	300 (67)	160 (36)	4.0 (1.6)	2.5 (1.0)
2.0	2	600 (135)	300 (70)	4.0 (1.6)	2.5 (1.0)

### Ordering Information

<b>L</b>		<b>0</b>	<b>0</b>						<b>T</b>		
<b>Digit No:</b>	<b>1</b>	<b>2</b>	<b>3</b>	<b>4</b>	<b>5</b>	<b>6</b>	<b>7</b>	<b>8</b>	<b>9</b>	<b>10</b>	<b>11</b>

- 1 Furcation Tubing = **L**
  - 2 Outer cable diameter 2.0mm = **E**, 2.9mm = **X**
  - 3 – 5 Number of tubes per cable: **000** = 1, **002** = 2
  - 6 Jacket type:
    - PVC = **D**
    - Flexible PVC = **N**
    - Low-Smoke Zero-Halogen = **Z**
    - Flame-Retardant Polyurethane = **V**
    - Polyurethane = **C**
    - Flame-Retardant Plenum = **S**
  - 7 – 9 Inner tube type:
    - LHT** = 1,100µm ID, 1,400µm OD (compatible with 900µm buffered fiber)
    - LBT** = 470µm ID, 900µm OD (compatible with 245µm acrylate fiber)
  - 10 Tubing = **T**
  - 11 Jacket color:
    - Orange = **O**
    - Aqua = **Q**
    - Yellow = **Y**
    - Others colors available upon request
- Other configurations are available upon request

**Example:** 2.9mm diameter; PVC jacket; single tube with 470/900µm inner tube, orange jacket

<b>L</b>	<b>X</b>	<b>0</b>	<b>0</b>	<b>0</b>	<b>D</b>	<b>L</b>	<b>B</b>	<b>T</b>	<b>T</b>	<b>O</b>
----------	----------	----------	----------	----------	----------	----------	----------	----------	----------	----------

## 4.2a) D-Series Distribution – Riser Rated Cables

1. Central Filler/Strength Member
2. Tight-Buffer Optical Fiber
3. Aramid Strength Member
4. Outer Jacket
5. Ripcord

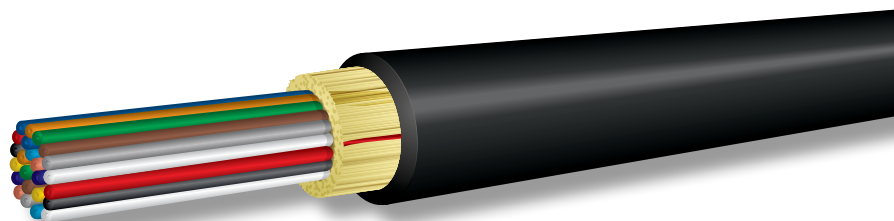
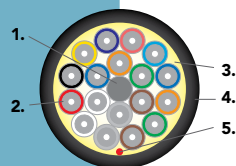

### Applications

- Indoor/outdoor tight-buffered design allows cables to be installed in intra-building backbone and inter-building campus locations without costly transitions between cable types
- Ideal configuration for a single termination point requiring multiple fibers

### Features

- High-performance components and construction
- Cable materials are indoor/outdoor – UL-listed OFNR and UV, water and fungus resistant
- UL listed in accordance with NEC section 770.179(b) for use in vertical runs in building riser shafts or from floor to floor
- Wide operating temperature range of -40°C to +85°C
- Helically stranded core for greater flexibility and mechanical protection of the optical fibers
- High strength-to-weight ratio
- 2–144 fiber configuration is smaller and lighter than comparable subgrouped cables, ideal for installation in areas with limited space or tight bends
- Can be armored for additional protection in direct burial and aerial installations
- Interlocking armor can be applied to cables as an alternative to conduit installation

### Cost Savings

- 900µm buffer eliminates the need for costly and time-consuming installation of fanout kits or pigtail splices, because connectors terminate directly to the fiber
- No need to splice outdoor cable to indoor cable at building entrance
- High crush resistance may eliminate the need for innerduct

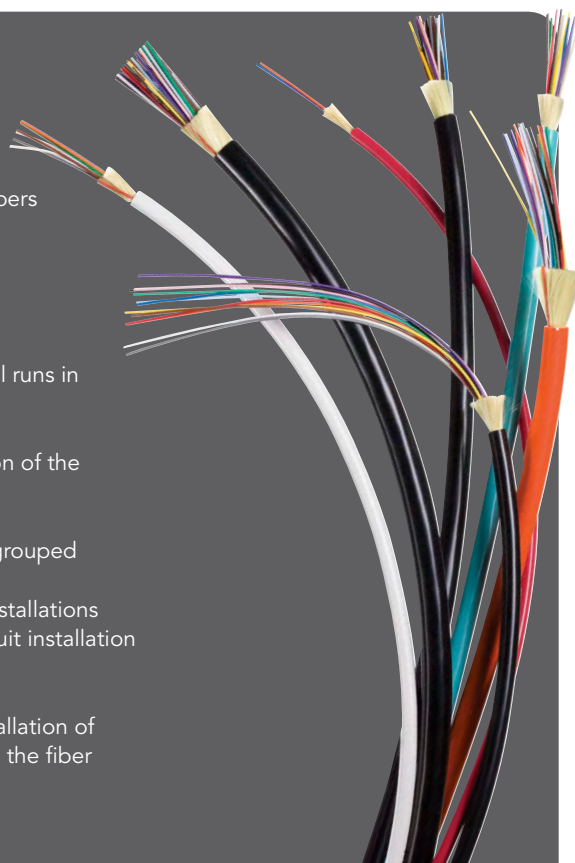

### Mechanical and Environmental Performance

	INDOOR/OUTDOOR
Operating temperature	-40°C to +85°C
Storage temperature	-55°C to +85°C
Installation temperature (cable temp.)	-10°C to +60°C
Flame retardancy	UL listed type OFNR (UL 1666)
Crush resistance (TIA-455-41)	1,800 N/cm
Flex resistance (TIA-455-104)	2,000 cycles

### Applicable Standards

OCC indoor/outdoor tight-buffered fiber optic cables meet or exceed functional requirements of the following standards:

- ICEA-S-83-596
- ICEA-S-104-696
- GR-409-CORE ISSUE 2
- TIA-568
- TIA-598
- UL 1651
- UL 1666

## (4.2a) D-Series Distribution – Riser Rated Cables

### Cable Characteristics: D-Series Distribution Riser Cables

FIBER COUNT	DIAMETER MM (IN)	WEIGHT KG/KM (LBS/1,000')	TENSILE LOAD		MINIMUM BEND RADIUS	
			INSTALLATION N (LBS)	OPERATIONAL N (LBS)	INSTALLATION CM (IN)	LONG-TERM CM (IN)
2*	4.8 (0.19)	22 (14)	660 (150)	180 (40)	7.3 (2.9)	4.8 (1.9)
4	5.1 (0.20)	24 (16)	1,400 (310)	450 (100)	7.7 (3.0)	5.1 (2.0)
6	5.7 (0.22)	32 (22)	1,400 (310)	450 (100)	8.6 (3.4)	5.7 (2.2)
8	6.0 (0.24)	34 (23)	1,600 (360)	525 (120)	9.0 (3.5)	6.0 (2.4)
10	6.5 (0.26)	43 (29)	1,800 (400)	600 (135)	9.8 (3.8)	6.5 (2.6)
12	6.5 (0.26)	38 (25)	2,700 (600)	600 (135)	9.8 (3.8)	6.5 (2.6)
18	7.3 (0.29)	48 (32)	2,700 (600)	700 (160)	11.0 (4.3)	7.2 (2.9)
24	8.9 (0.35)	67 (45)	3,000 (670)	1,000 (220)	13.4 (5.3)	8.9 (3.5)
30	9.1 (0.36)	75 (50)	3,000 (670)	1,000 (220)	13.7 (5.4)	9.1 (3.6)
36	9.1 (0.36)	73 (49)	3,000 (670)	1,000 (220)	13.7 (5.4)	9.1 (3.6)
48	10.1 (0.40)	93 (63)	4,200 (940)	1,400 (310)	15.2 (6.0)	10.1 (4.0)
60	12.3 (0.48)	135 (91)	4,800 (1,080)	1,600 (360)	18.5 (7.3)	12.3 (4.8)
72	14.0 (0.55)	177 (119)	5,400 (1,210)	1,800 (400)	21.0 (8.3)	14.0 (5.5)
84	14.4 (0.57)	190 (128)	6,000 (1,350)	2,000 (450)	21.6 (8.5)	14.4 (5.7)
96	16.0 (0.63)	225 (151)	6,000 (1,350)	2,000 (450)	24.1 (9.5)	16.0 (6.3)
108	16.8 (0.66)	246 (165)	6,000 (1,350)	2,000 (450)	25.3 (10.0)	16.8 (6.6)
120	17.9 (0.70)	271 (182)	6,000 (1,350)	2,000 (450)	26.8 (10.6)	17.9 (7.0)
132	17.8 (0.70)	291 (195)	6,000 (1,350)	2,000 (450)	26.8 (10.6)	17.8 (7.0)
144	20.3 (0.80)	339 (228)	6,000 (1,350)	2,000 (450)	30.5 (12.0)	20.3 (8.0)

NOTES:  
 \*40°C to +70°C  
 Installation loads in excess of 2,700 N (600 lbs.) are not recommended.

### Ordering Information

	<b>D</b>	<b>X</b>				<b>D</b>				<b>9</b>		<b>R</b>
Digit No:	1	2	3	4	5	6	7	8	9	10	11	12

- 1 – 2 Distribution Series Ultra-Fox = **DX**
- 3 – 5 Fiber count: (see cable characteristics chart) = **002–144**
- 6 Jacket type: Indoor/Outdoor PVC = **D**
- 7 – 9 Fiber type: (see Laser Ultra-Fox Fiber Performance Table, pg. 116)
- 10 Ultra-Fox fiber with 900µm tight-buffer = **9**
- 11 Standard jacket color: Black = **K**  
 Optional colors available:  
 62.5µm multimode (WLS, WLX): Orange = **O**  
 50µm multimode (ALS, ALX): Orange = **O**  
 50µm 10 Gigabit multimode (ALT, ALE): Aqua = **Q**  
 Single-mode: Yellow = **Y**
- 12 Rating: Riser = **R**

**Example:** 144 -fiber indoor/outdoor riser cable using Ultra-Fox Plus low water peak single-mode fiber, riser rated, yellow jacket

<b>D</b>	<b>X</b>	<b>1</b>	<b>4</b>	<b>4</b>	<b>D</b>	<b>S</b>	<b>L</b>	<b>A</b>	<b>9</b>	<b>Y</b>	<b>R</b>
----------	----------	----------	----------	----------	----------	----------	----------	----------	----------	----------	----------



## (4.2b) D-Series Distribution – Plenum Rated Cables

1. Central Filler/Strength Member
2. Tight-Buffer Optical Fiber
3. Aramid Strength Member
4. Outer Jacket
5. Ripcord

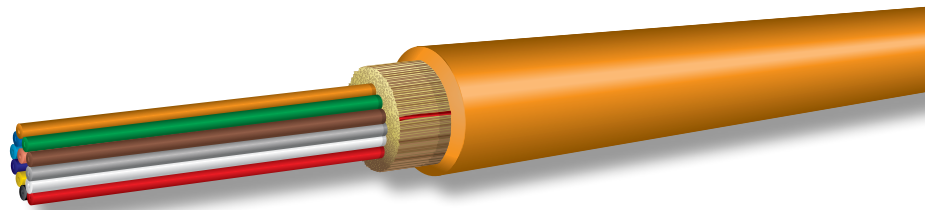
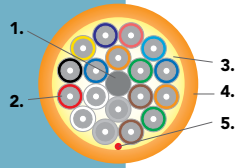

### Applications

- Used in trunking, LAN and distribution applications where small size, lightweight, and versatile installation capability are required for ducts, plenums, and air-handling spaces
- Ideal configuration for a single termination point requiring multiple fibers

### Features

- High-performance components and construction
- High specific strength-to-weight ratio and compact cable design for limited conduit space and tight bends in long cable pulls
- Helically stranded core for flexibility, survival in difficult installations, and mechanical protection for the fibers
- High-performance tight-buffered coating on each fiber for environmental and mechanical protection
- High crush resistance may eliminate the need for innerduct
- 900µm buffer eliminates the need for costly and time-consuming installation of fanout kits or pigtail splices, because connectors terminate directly to the fiber
- UL listed in accordance with NEC section 770.179(a) for use in ducts, plenums and air-handling spaces

### Indoor/Outdoor (“K” Jacket)

- Indoor/outdoor plenum cables eliminate the need for costly cable transitions in different installation environments
- Cable materials are UV, water and fungus resistant
- Higher fiber counts available than similar cables available in subcabled configuration
- Jacket is highly chemical resistant for installation in harsh industrial environments
- Interlocking armor can be applied to cables as an alternative to conduit installation
- Can be installed outside and in plenum or riser pathways inside, eliminating the need to transition cable types between environments
- 2 to 72 fiber configuration is smaller and lighter than comparable subgrouped cables
- Ideal for installation in areas with limited space or tight bends

### Indoor (“S” Jacket)

- Indoor-only flexible flame-retardant plenum jacketed cables
- 2 to 12 fibers
- Interlocking armor can be applied to cables as an alternative to conduit installation

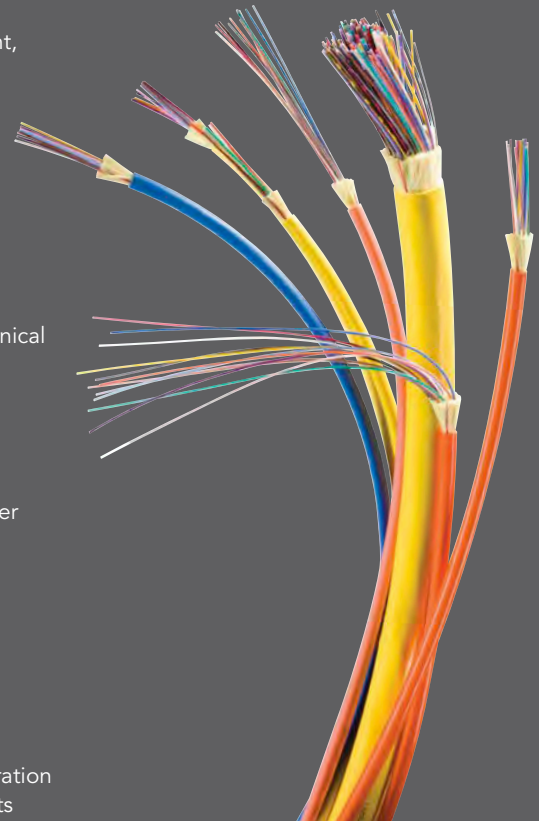

### Applicable Standards

OCC indoor/outdoor tight-buffered fiber optic cables meet or exceed functional requirements of the following standards:

- ICEA-S-83-596
- ICEA-S-104-696
- GR-409-CORE
- TIA-568
- TIA-598
- UL 1651
- ANSI/NFPA 262

## (4.2b) D-Series Distribution – Plenum Rated Cables



### Mechanical and Environmental Performance

	INDOOR (S)	INDOOR/OUTDOOR (K)
Operating temperature	0°C to +70°C	-40°C to +85°C
Storage temperature	0°C to +70°C	-40°C to +85°C
Installation temperature (cable temp.)	0°C to +60°C	0°C to +60°C
Flame retardancy	UL listed type OFNP (ANSI/NFPA 262) and FT6 (CSA C22.2 No. 232)	UL listed type OFNP (ANSI/NFPA 262) and FT6 (CSA C22.2 No. 232)
Crush resistance (TIA-455-41)	1,500 N/cm	1,500 N/cm
Flex resistance (TIA-455-104)	1,000 cycles	1,000 cycles

### Cable Characteristics: D-Series Distribution Plenum Cables (Indoor/Outdoor “K” Jacket)

FIBER COUNT	DIAMETER MM (IN)	WEIGHT KG/KM (LBS/1,000')	TENSILE LOAD		MINIMUM BEND RADIUS	
			INSTALLATION N (LBS)	OPERATIONAL N (LBS)	INSTALLATION CM (IN)	LONG-TERM CM (IN)
2	4.8 (0.19)	24 (16)	1,400 (310)	450 (100)	7.2 (2.8)	7.2 (2.8)
4	4.8 (0.19)	24 (16)	1,400 (310)	450 (100)	7.2 (2.8)	7.2 (2.8)
6	4.8 (0.19)	24 (16)	1,400 (310)	450 (100)	7.2 (2.8)	7.2 (2.8)
8	5.1 (0.20)	30 (20)	1,600 (360)	525 (120)	7.7 (3.0)	7.7 (3.0)
10	5.7 (0.22)	38 (26)	1,800 (400)	600 (135)	8.6 (3.4)	8.6 (3.4)
12	6.5 (0.26)	45 (30)	2,700 (600)	900 (200)	9.8 (3.8)	9.8 (3.8)
18	6.5 (0.26)	42 (28)	2,700 (600)	900 (200)	9.8 (3.8)	9.8 (3.8)
24	8.3 (0.31)	71 (46)	3,000 (670)	1,000 (220)	11.8 (4.6)	11.8 (4.6)
30	8.7 (0.34)	87 (59)	3,000 (670)	1,000 (220)	13.1 (5.1)	13.1 (5.1)
36	8.7 (0.34)	87 (59)	3,000 (670)	1,000 (220)	13.1 (5.1)	13.1 (5.1)
48	9.6 (0.37)	104 (70)	4,200 (940)	1,400 (310)	14.3 (5.6)	14.3 (5.6)
60	10.7 (0.42)	129 (87)	4,800 (1,080)	1,600 (360)	16.1 (6.3)	16.1 (6.3)
72	12.6 (0.51)	175 (122)	5,400 (1,200)	1,800 (400)	19.6 (7.7)	19.6 (7.7)

### D-Series Distribution Plenum Cables (Indoor “S” Jacket)

FIBER COUNT	DIAMETER MM (IN)	WEIGHT KG/KM (LBS/1,000')	TENSILE LOAD		MINIMUM BEND RADIUS	
			INSTALLATION N (LBS)	OPERATIONAL N (LBS)	INSTALLATION CM (IN)	LONG-TERM CM (IN)
2	3.8 (0.15)	15 (10)	660 (150)	180 (40)	5.7 (2.3)	3.8 (1.5)
4	4.5 (0.18)	18 (12)	1,200 (270)	400 (90)	6.7 (2.6)	4.5 (1.8)
6	4.7 (0.19)	22 (15)	1,400 (310)	450 (100)	7.1 (2.8)	4.7 (1.9)
8	5.7 (0.22)	37 (25)	1,600 (360)	525 (120)	8.6 (3.4)	5.7 (2.2)
10	6.1 (0.24)	44 (29)	1,800 (400)	600 (135)	9.1 (3.6)	6.1 (2.4)
12	6.2 (0.24)	40 (27)	1,800 (400)	600 (135)	9.3 (3.7)	6.2 (2.4)

Installation loads in excess of 2,700 N (600 lbs.) are not recommended.

 (4.2b) D-Series Distribution – Plenum Rated Cables

## Ordering Information

	D	X								9		P
Digit No:	1	2	3	4	5	6	7	8	9	10	11	12

- 1 – 2 Distribution Series Ultra-Fox = **DX**
- 3 – 5 Fiber count: (Indoor) = **002–012**, (Indoor/Outdoor) = **002–072**
- 6 Jacket type:  
Indoor/Outdoor Fluoropolymer = **K**  
Indoor Plenum = **S**
- 7 – 9 Fiber type: (see Laser Ultra-Fox Fiber Performance Table, pg. 116)
- 10 Ultra-Fox fiber with 900µm tight-buffer = **9**
- 11 Standard jacket colors:  
62.5µm multimode (WLS, WLX): Orange = **O**  
50µm multimode (ALS, ALX): Orange = **O**  
50µm 10 Gigabit multimode (ALT, ALE): Aqua = **Q**  
Single-mode: Yellow = **Y**
- 12 Rating: Plenum = **P**

**Example:** 12-fiber indoor cable using OM3 laser optimized bend-insensitive fiber, plenum rated, aqua jacket

D	X	0	1	2	S	A	L	T	9	Q	P
---	---	---	---	---	---	---	---	---	---	---	---

\*Note: Other colors available upon request. Contact your sales rep for part number details.

## (4.2c) D-Series Distribution – LSZH OFN-LS and IEC Rated Cables

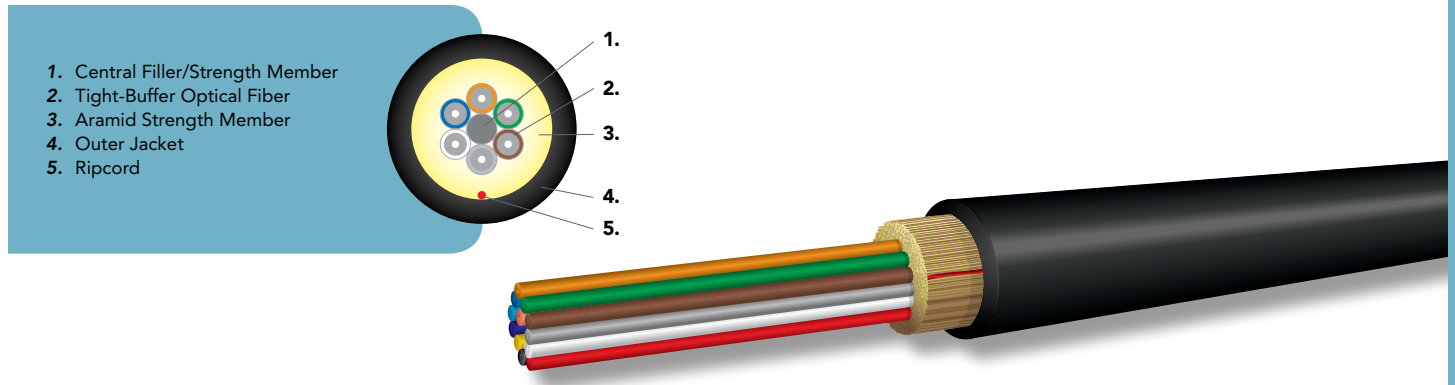

### Applications

- Indoor/outdoor tight-buffered cable design for use in installations requiring a flame-retardant, low-smoke and zero-halogen cable

### Features

- Zero-halogen construction meets IEC 60754-2
- Meets low-smoke requirements of UL-1685, OFN-LS and IEC 61034-2
- Flame-retardant per the requirements of IEC 60332-3-24 and UL 1685, OFN-LS
- Suitable for indoor or outdoor applications
- Jacket is UV, fungus and moisture resistant
- Round cable construction for easy handling and termination
- Includes ripcord for easy outer jacket removal
- Distribution-style cable with 2 to 24 fibers
- Suitable for indoor/outdoor confined spaces, including:
  - Building risers
  - Cable trays
  - Central offices
  - Mass-transit rail systems
  - Nuclear plants
  - Underground subway stations and tunnels

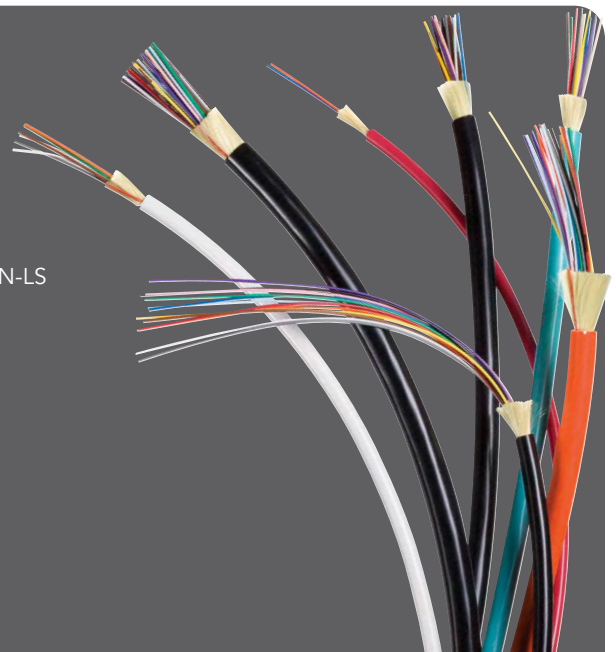

### Mechanical and Environmental Performance

	INDOOR/OUTDOOR
Operating temperature	-40°C to +85°C
Storage temperature	-40°C to +85°C
Installation temperature (cable temp.)	-20°C to +60°C
Flame retardancy	UL listed type OFN-LS (UL 1685), FT4 (CSA C22.2 No.232) and IEC 60332-3-24
Crush resistance (TIA-455-41)	1,800 N/cm
Flex resistance (TIA-455-104)	2,000 cycles

### Applicable Standards

OCC indoor/outdoor tight-buffered fiber optic cables meet or exceed the functional requirements of the following standards:

- TIA-568
- TIA-598
- IEC 60332-3-24
- IEC 60754-2
- IEC 61034-2
- UL 1685
- UL 1651
- ICEA-S-104-696





## (4.2c) D-Series Distribution – LSZH OFN-LS and IEC Rated Cables

## Cable Characteristics: D-Series Distribution OFN-LS and IEC Rated Cables

FIBER COUNT	DIAMETER MM (IN)	WEIGHT KG/KM (LBS/1,000')	TENSILE LOAD		MINIMUM BEND RADIUS	
			INSTALLATION N (LBS)	OPERATIONAL N (LBS)	INSTALLATION CM (IN)	LONG-TERM CM (IN)
2	5.4 (0.21)	30 (20)	1,400 (310)	450 (100)	8.1 (3.2)	5.4 (2.1)
4	5.6 (0.22)	32 (22)	1,400 (310)	450 (100)	8.4 (3.3)	5.6 (2.2)
6	5.9 (0.23)	38 (26)	1,400 (310)	450 (100)	8.9 (3.5)	5.9 (2.3)
8	6.4 (0.25)	47 (32)	1,600 (360)	525 (120)	9.6 (3.8)	6.4 (2.5)
10	6.9 (0.27)	56 (38)	1,800 (400)	600 (135)	10.4 (4.1)	6.9 (2.7)
12	7.6 (0.30)	64 (43)	2,700 (600)	600 (135)	11.4 (4.5)	7.6 (3.0)
18	7.6 (0.30)	61 (41)	2,700 (600)	700 (160)	11.4 (4.5)	7.6 (3.0)
24	9.2 (0.36)	84 (56)	3,000 (670)	1,000 (220)	13.8 (5.4)	9.2 (3.6)

Other fiber counts available upon request.

## Ordering Information

	D	X				Z				9	K	E
Digit No:	1	2	3	4	5	6	7	8	9	10	11	12

- 1 – 2 Distribution Series Low-Smoke Zero-Halogen Ultra-Fox = **DX**
- 3 – 5 Fiber count: (see cable characteristics chart) = **002–024**
- 6 Jacket type: Indoor/Outdoor Zero-Halogen = **Z**
- 7 – 9 Fiber type: (see Laser Ultra-Fox Fiber Performance Table, pg. 116)
- 10 Ultra-Fox fiber with 900µm tight-buffer = **9**
- 11 Standard jacket color: Black = **K**
- 12 Rating: Flame-Retardent Zero-Halogen = **E**

**Example:** 12-fiber LSZH distribution cable using 62.5µm standard laser Ultra-Fox fiber; black jacket

D	X	0	1	2	Z	W	L	S	9	K	E
---	---	---	---	---	---	---	---	---	---	---	---

## (4.2d) B-Series Breakout – Riser Rated Cables



1. Central Filler/Strength Member
  2. Subcable
  3. Outer Jacket
  4. Ripcord
- Subcable**
5. Tight-Buffer Optical Fiber
  6. Aramid Strength Member
  7. Subcable Jacket

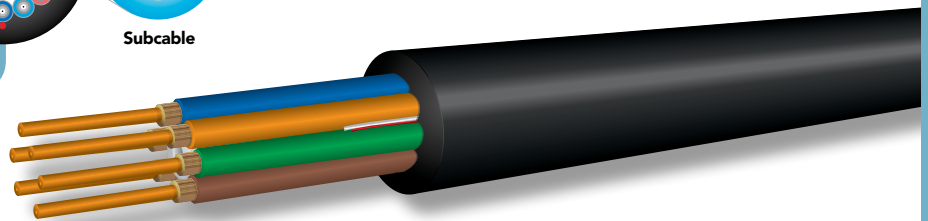
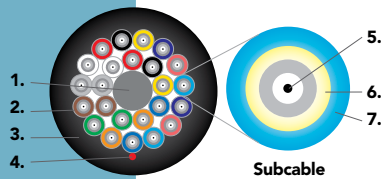

### Applications

- Ideal for installations requiring an extremely rugged and reliable cable design where maximum mechanical and environmental protection are necessary
- Easiest cable to install where direct termination of the subcable to a connector and a direct run to panels and equipment are desired

### Features

- High-performance components and construction
- UL listed in accordance with NEC sections 770.179(b) for use in vertical runs in building riser shafts or from floor to floor
- Most rugged and easy to install cable design for enterprise cabling applications
- Core-Locked™ outer jacket design for installation survivability and long-term, trouble-free service
- Ideal for use in long, vertical installations
- 2.0mm subcables can be direct-terminated with standard connectors (2.5mm and 2.9mm subcables also available)
- Subcabled fiber is environmentally and mechanically protected
- Ideal for use in point-to-point runs in adverse environments
- Direct termination to subcable provides additional strain relief for better connector retention during moves, adds, and changes
- Design is ideal for direct pulling with mesh grips
- Cable materials are indoor/outdoor – UV, water and fungus resistant
- Wide operating temperature range of -40°C to +85°C
- High-performance 900µm tight-buffered coating on each optical fiber for environmental and mechanical protection
- Interlocking armor can be applied to cables as an alternative to conduit installation
- 2 to 72 fibers

### Cost Savings

- Direct termination to subcable may eliminate the need for patch panels and patch cords and reduce connector loss
- 900µm buffer eliminates the need for costly and time-consuming installation of fanout kits or pigtail splices, because connectors terminate directly to the subcable
- High crush resistance may eliminate the need for innerduct

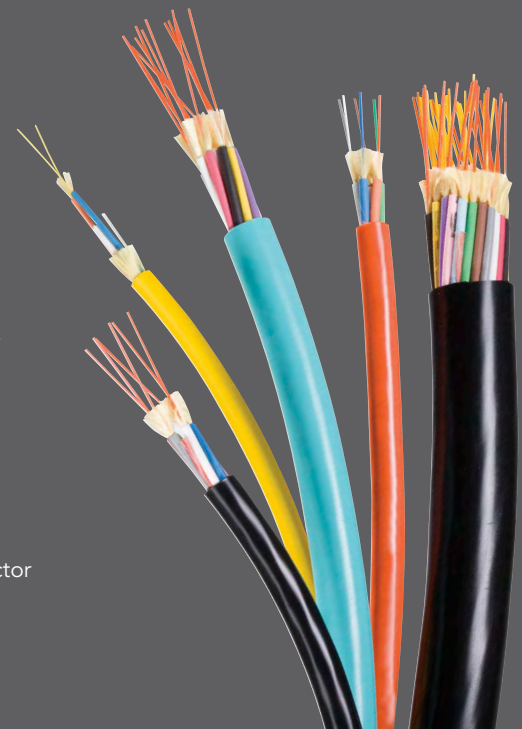

### Applicable Standards

OCC indoor/outdoor tight-buffered fiber optic cables meet or exceed the functional requirements of the following standards:

- ICEA-S-83-596
- ICEA-S-104-696
- GR-409-CORE ISSUE 2
- TIA-568
- TIA-598
- UL 1651
- UL 1666

 (4.2d) B-Series Breakout – Riser Rated Cables

## Mechanical and Environmental Performance

	INDOOR/OUTDOOR
Operating temperature	-40°C to +85°C
Storage temperature	-55°C to +85°C
Installation temperature (cable temp.)	-10°C to +60°C
Flame retardancy	UL listed type OFNR (UL 1666) and FT4 (CSA C22.2 No. 232)
Crush resistance (TIA-455-41)	2,200 N/cm
Flex resistance (TIA-455-104)	2,000 cycles

## Cable Characteristics: B-Series Breakout Riser Cables (with 2.0mm subcables)

FIBER COUNT	DIAMETER MM (IN)	WEIGHT KG/KM (LBS/1,000')	TENSILE LOAD		MINIMUM BEND RADIUS	
			INSTALLATION N (LBS)	OPERATIONAL N (LBS)	INSTALLATION CM (IN)	LONG-TERM CM (IN)
2	6.0 (0.24)	37 (25)	800 (180)	200 (40)	9.0 (3.5)	6.0 (2.4)
4	7.0 (0.28)	49 (33)	1,600 (360)	400 (90)	10.5 (4.1)	7.0 (2.8)
6	8.0 (0.31)	63 (42)	2,400 (540)	600 (130)	12.0 (4.7)	8.0 (3.1)
8	9.5 (0.37)	83 (56)	3,200 (720)	800 (180)	14.3 (5.6)	9.5 (3.7)
12	11.0 (0.43)	103 (69)	4,800 (1,000)	1,200 (270)	16.5 (6.5)	11.0 (4.3)
18	12.5 (0.49)	148 (99)	6,000 (1,350)	1,500 (340)	18.8 (7.4)	12.5 (4.9)
24	14.7 (0.58)	208 (140)	7,200 (1,600)	1,800 (400)	22.1 (8.7)	14.7 (5.8)
30	16.8 (0.66)	253 (170)	9,600 (2,100)	2,400 (540)	25.2 (9.9)	16.8 (6.6)
36	16.8 (0.66)	253 (170)	9,600 (2,100)	2,400 (540)	25.2 (9.9)	16.8 (6.6)
48	20.1 (0.79)	368 (247)	12,000 (2,700)	3,000 (680)	30.2 (11.9)	20.1 (7.9)
60	22.7 (0.89)	467 (314)	15,000 (3,400)	3,750 (850)	34.1 (13.4)	22.7 (8.9)
72	26.0 (1.02)	623 (419)	16,800 (3,800)	4,200 (900)	39.0 (15.4)	26.0 (10.2)

## (4.2d) B-Series Breakout – Riser Rated Cables

### Cable Characteristics: B-Series Breakout Riser Cables (with 2.5mm subcables)

FIBER COUNT	DIAMETER MM (IN)	WEIGHT KG/KM (LBS/1,000')	TENSILE LOAD		MINIMUM BEND RADIUS	
			INSTALLATION N (LBS)	OPERATIONAL N (LBS)	INSTALLATION CM (IN)	LONG-TERM CM (IN)
2	7.0 (0.28)	41 (28)	1,200 (270)	500 (110)	10.5 (4.1)	7.0 (2.8)
4	8.3 (0.33)	65 (44)	2,000 (450)	800 (180)	12.2 (4.8)	8.1 (3.2)
6	9.6 (0.38)	84 (56)	3,000 (670)	1,200 (270)	14.4 (5.7)	9.6 (3.8)
8	11.6 (0.46)	126 (85)	4,000 (900)	1,700 (380)	17.5 (6.9)	11.6 (4.6)
12	14.1 (0.55)	159 (107)	6,000 (1,350)	2,500 (560)	21.2 (8.3)	14.1 (5.5)
18	15.3 (0.60)	216 (145)	8,000 (1,800)	3,500 (790)	23.1 (9.1)	15.3 (6.0)
24	17.6 (0.69)	279 (188)	10,000 (2,250)	3,800 (850)	26.5 (10.4)	17.6 (6.9)
30	20.9 (0.80)	360 (242)	14,000 (3,150)	6,000 (1,350)	31.4 (12.3)	20.9 (8.2)
36	20.9 (0.80)	360 (242)	14,000 (3,150)	6,000 (1,350)	31.4 (12.3)	20.9 (8.2)
48	24.2 (0.95)	483 (325)	18,000 (4,050)	7,500 (1,690)	36.3 (14.3)	24.2 (9.5)
60	28.5 (1.12)	744 (500)	22,000 (4,950)	8,800 (1,980)	42.7 (16.8)	28.5 (11.2)
72	28.9 (1.14)	738 (496)	26,000 (5,845)	11,000 (2,470)	43.4 (17.1)	28.9 (11.4)

Installation loads in excess of 2,700 N (600 lbs.) are not recommended. Other fiber counts available upon request.

Note: 2.5mm subcables standard. 2.0mm and 2.9mm subcable diameters available upon request.

### Ordering Information

<b>B</b>					<b>D</b>				<b>9</b>		<b>R</b>	
<b>Digit No:</b>	<b>1</b>	<b>2</b>	<b>3</b>	<b>4</b>	<b>5</b>	<b>6</b>	<b>7</b>	<b>8</b>	<b>9</b>	<b>10</b>	<b>11</b>	<b>12</b>

- 1 – 2 Breakout Series Ultra-Fox  
2.0mm Subcables = **BE**  
2.5mm Subcables = **BX**
- 3 – 5 Fiber count: (see cable characteristics chart) = **002–072**
- 6 Jacket type: Indoor/Outdoor PVC = **D**
- 7 – 9 Fiber type: (see Laser Ultra-Fox Fiber Performance Table, pg. 116)
- 10 Ultra-Fox fiber with 900µm tight-buffer = **9**
- 11 Standard jacket colors: Black = **K**  
Optional colors available:  
62.5µm multimode (WLS, WLX): Orange = **O**  
50µm multimode (ALS, ALX): Orange = **O**  
50µm 10 Gigabit multimode (ALT, ALE): Aqua = **Q**  
Single-mode: Yellow = **Y**
- 12 Rating: Riser = **R**

**Example:** 12-fiber cable using OM3 laser optimized bend-insensitive fiber, riser rated, aqua jacket

<b>B</b>	<b>X</b>	<b>0</b>	<b>1</b>	<b>2</b>	<b>D</b>	<b>A</b>	<b>L</b>	<b>T</b>	<b>9</b>	<b>Q</b>	<b>R</b>
----------	----------	----------	----------	----------	----------	----------	----------	----------	----------	----------	----------

## (4.2e) B-Series Breakout – Plenum Rated Cables

1. Central Filler/Strength Member
2. Subcable
3. Outer Jacket
4. Ripcord

### Subcable

5. Tight-Buffer Optical Fiber
6. Aramid Strength Member
7. Color-Coded Subcable Jacket

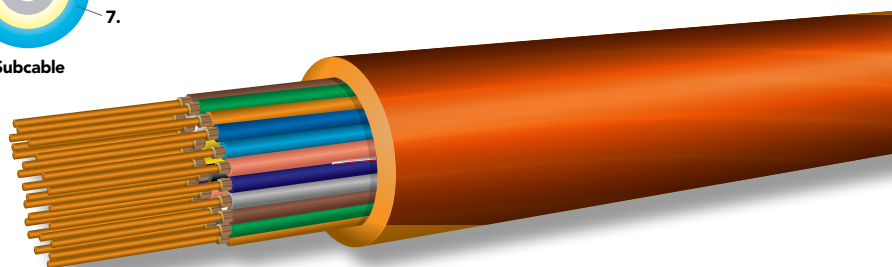
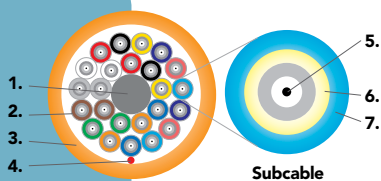

## Applications

- Ideal for installations requiring an extremely rugged and reliable cable design where maximum mechanical and environmental protection are required
- Installed in ducts, plenums, and air-handling spaces
- Easiest cable to install where direct termination of the subcable to a connector and a direct run to panels and equipment are desired

## Features

- High-performance components and construction
- UL listed in accordance with NEC sections 770.179(a) for use in ducts, plenums and air-handling spaces
- Most rugged and easy to install cable design for enterprise cabling applications
- Standard 2.0mm subcables can be directly terminated with standard connectors (2.5mm and 2.9mm subcable sizes are also available)
- Subcabled fiber is environmentally and mechanically protected
- Ideal for use in point-to-point runs in adverse environments
- Direct termination to subcable provides additional strain relief for better connector retention during moves, adds, and changes
- Design is ideal for direct pulling with mesh grips
- Cable materials are indoor/outdoor – UV, water and fungus resistant
- Wide operating temperature range of -40°C to +85°C
- High-performance 900µm tight-buffered coating on each optical fiber for environmental and mechanical protection
- Jacket highly chemical resistant for installation in harsh industrial environments
- Interlocking armor can be applied to cables as an alternative to conduit installation
- 2 to 48 fibers

## Cost Savings

- Direct termination to subcable may eliminate the need for patch panels and patch cords and reduce connector loss
- 900µm buffer eliminates the need for costly and time-consuming installation of fanout kits or pigtail splices, because connectors terminate directly to the fiber
- High crush resistance may eliminate the need for innerduct



## Applicable Standards

OCC indoor/outdoor tight-buffered fiber optic cables meet or exceed the functional requirements of the following standards:

- ICEA-S-83-596
- ICEA-S-104-696
- GR-409-CORE ISSUE 2
- TIA-568
- TIA-598
- UL 1651
- ANSI/NFPA 262



## (4.2e) B-Series Breakout – Plenum Rated Cables

### Mechanical and Environmental Performance

	INDOOR/OUTDOOR
Operating temperature	-40°C to +85°C
Storage temperature	-40°C to +85°C
Installation temperature (cable temp.)	0°C to +60°C
Flame retardancy	UL listed type OFNP (ANSI/NFPA 262) and FT6 (CSA C22.2 No. 232)
Crush resistance (TIA-455-41)	2,100 N/cm
Flex resistance (TIA-455-104)	2,000 cycles

### Cable Characteristics: B-Series Breakout Plenum Cables (with 2.0mm subcables)

FIBER COUNT	DIAMETER MM (IN)	WEIGHT KG/KM (LBS/1,000')	TENSILE LOAD		MINIMUM BEND RADIUS	
			INSTALLATION N (LBS)	OPERATIONAL N (LBS)	INSTALLATION CM (IN)	LONG-TERM CM (IN)
2	6.3 (0.26)	46 (31)	1,600 (360)	400 (90)	9.5 (3.7)	9.5 (3.7)
4	6.3 (0.26)	46 (31)	1,600 (360)	400 (90)	9.5 (3.7)	9.5 (3.7)
6	7.4 (0.29)	61 (41)	2,400 (540)	600 (130)	11.2 (4.4)	11.2 (4.4)
8	8.7 (0.34)	88 (59)	3,200 (720)	800 (180)	13.1 (5.2)	13.1 (5.2)
12	10.0 (0.39)	105 (71)	4,800 (1,080)	1,200 (270)	15.0 (5.9)	15.0 (5.9)
18	12.2 (0.48)	162 (109)	6,000 (1,350)	1,500 (340)	18.3 (7.2)	18.3 (7.2)
24	14.2 (0.56)	221 (148)	7,200 (1,620)	1,800 (400)	21.3 (8.4)	21.3 (8.4)
36	15.7 (0.62)	274 (184)	9,600 (2,160)	2,400 (540)	23.6 (9.3)	23.6 (9.3)
48	18.4 (0.72)	376 (253)	12,000 (2,700)	3,000 (670)	27.6 (10.9)	27.6 (10.9)

Installation loads in excess of 2,700 N (600 lbs.) are not recommended.

Note: 2.0mm subcables standard. 2.5mm subcables available by request. Contact Optical Cable Corporation for ordering details.

### Ordering Information

	<b>B</b>	<b>X</b>				<b>K</b>				<b>9</b>		<b>P</b>
Digit No:	<b>1</b>	<b>2</b>	<b>3</b>	<b>4</b>	<b>5</b>	<b>6</b>	<b>7</b>	<b>8</b>	<b>9</b>	<b>10</b>	<b>11</b>	<b>12</b>

- 1 – 2 Breakout Series Ultra-Fox = **BX**
- 3 – 5 Fiber count: (see cable characteristics chart) = **002-048**
- 6 Jacket type: Indoor/Outdoor Fluoropolymer = **K**
- 7 – 9 Fiber type: (see Laser Ultra-Fox Fiber Performance Table, pg. 116)
- 10 Ultra-Fox fiber with 900µm tight-buffer = **9**
- 11 Standard jacket colors:
  - 62.5µm multimode (WLS, WLX): Orange = **O**
  - 50µm multimode (ALS, ALX): Orange = **O**
  - 50µm 10 Gigabit multimode (ALT, ALE): Aqua = **Q**
  - Single-mode: Yellow = **Y**
- 12 Rating: Plenum = **P**

**Example:** 48-fiber cable using OM3 laser optimized bend-insensitive fiber, plenum rated, aqua jacket

<b>B</b>	<b>X</b>	<b>0</b>	<b>4</b>	<b>8</b>	<b>K</b>	<b>A</b>	<b>L</b>	<b>T</b>	<b>9</b>	<b>Q</b>	<b>P</b>
----------	----------	----------	----------	----------	----------	----------	----------	----------	----------	----------	----------

## (4.2f) B-Series Breakout – LSZH OFNR-LS and IEC Rated Cables

1. Central Filler/Strength Member
  2. Subcable
  3. Aramid Strength Member
  4. Outer Jacket
  5. Ripcord
- Subcable**
6. Tight-Buffer Optical Fiber
  7. Aramid Strength Member
  8. Subcable Jacket

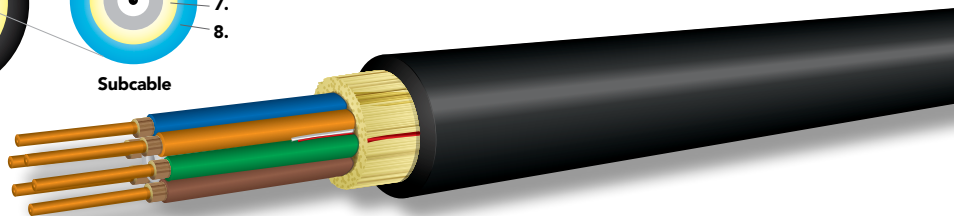
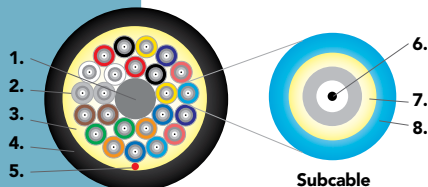

### Applications

- Low-smoke and zero-halogen cable suitable for indoor and outdoor applications requiring an extremely rugged cable where maximum mechanical and environmental protection are necessary
- Easiest cable to install where direct termination of the subcable to a connector and a direct run to panels and equipment are desired

### Features

- Zero-halogen construction meets IEC 60754-2
- Meets low-smoke requirements of IEC 61034-2 and UL 1685 OFNR-LS
- Flame-retardant to the requirements of IEC 60332-3-24 and UL 1666 OFNR
- Suitable for indoor or outdoor applications
- Jacket is UV, fungus and moisture resistant
- Round cable construction for easy handling and termination
- Breakout style cable with 2 to 24 fibers
- 2.0mm and 2.5mm subcables (2.9mm also available)
- Suitable for indoor/outdoor confined spaces, including:
  - Building risers
  - Cable trays
  - Central offices
  - Mass-transit rail systems
  - Nuclear plants
  - Underground subway stations and tunnels

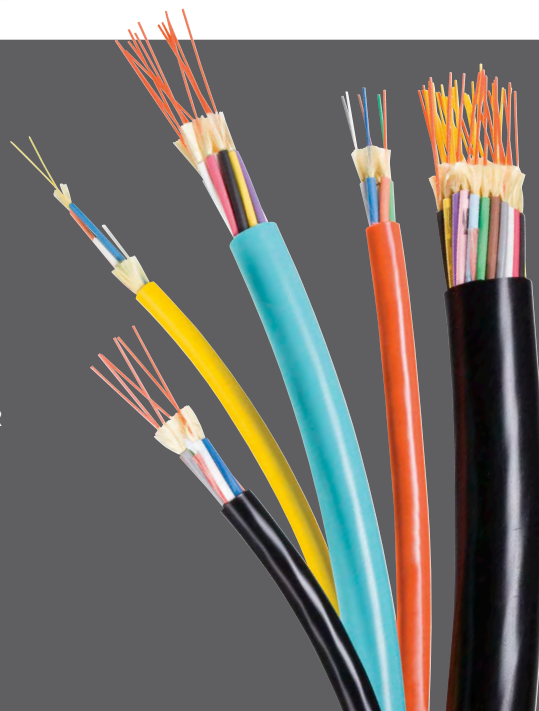

### Applicable Standards

OCC indoor/outdoor tight-buffered LSZH fiber optic cables meet or exceed the functional requirements of the following standards:

- TIA-598
- UL 1651
- UL 1666
- UL 1685
- IEC 60332-3-24
- IEC 61034-2
- IEC 60754-2

### Mechanical and Environmental Performance

	INDOOR/OUTDOOR
Operating temperature	-40°C to +85°C
Storage temperature	-40°C to +85°C
Installation temperature (cable temp.)	-20°C to +60°C
Crush resistance (TIA-455-41)	2200 N/cm
Flex resistance (TIA-455-104)	2,000 cycles

## (4.2f) B-Series Breakout – LSZH OFNR-LS and IEC Rated Cables

### Cable Characteristics: B-Series Breakout LSZH OFNR and IEC Rated Cables (with 2.0mm subcables)

FIBER COUNT	DIAMETER MM (IN)	WEIGHT KG/KM (LBS/1,000')	TENSILE LOAD		MINIMUM BEND RADIUS	
			INSTALLATION N (LBS)	OPERATIONAL N (LBS)	INSTALLATION CM (IN)	LONG-TERM CM (IN)
2	8.0 (0.31)	66 (44)	1,600 (360)	400 (90)	12.0 (4.7)	8.0 (3.1)
4	8.0 (0.31)	66 (44)	1,600 (360)	400 (90)	12.0 (4.7)	8.0 (3.1)
6	8.8 (0.36)	82 (55)	2,400 (540)	600 (130)	13.7 (5.4)	9.1 (3.6)
8	10.4 (0.41)	108 (73)	3,200 (7,20)	800 (180)	15.6 (6.1)	10.4 (4.1)
12	11.6 (0.46)	131 (88)	4,800 (1,800)	1,200 (270)	17.4 (6.9)	11.6 (4.6)
18	12.8 (0.50)	162 (109)	7,200 (1,620)	1,800 (400)	19.2 (7.6)	12.8 (5.0)
24	14.7 (0.58)	219 (147)	9,600 (2,100)	2,400 (540)	22.1 (8.7)	14.7 (5.8)

### B-Series Breakout LSZH OFNR and IEC Rated Cables (with 2.5mm subcables)

FIBER COUNT	DIAMETER MM (IN)	WEIGHT KG/KM (LBS/1,000')	TENSILE LOAD		MINIMUM BEND RADIUS	
			INSTALLATION N (LBS)	OPERATIONAL N (LBS)	INSTALLATION CM (IN)	LONG-TERM CM (IN)
2	9.2 (0.36)	59 (40)	2,000 (450)	800 (180)	13.8 (5.4)	9.2 (3.6)
4	9.2 (0.36)	84 (56)	2,000 (450)	800 (180)	13.8 (5.4)	9.2 (3.6)
6	10.6 (0.42)	107 (72)	3,000 (670)	1,200 (270)	15.9 (6.3)	10.6 (4.2)
8	12.4 (0.49)	144 (97)	4,000 (900)	1,700 (380)	18.6 (7.3)	12.4 (4.9)
12	14.2 (0.56)	171 (115)	6,000 (1,350)	2,500 (560)	21.3 (8.4)	14.2 (5.6)
18	15.9 (0.63)	225 (151)	8,000 (1,800)	3,500 (790)	23.9 (9.4)	15.9 (6.3)
24	17.9 (0.70)	290 (195)	10,000 (2,250)	3,800 (850)	26.9 (10.6)	17.9 (7.0)

## Ordering Information

	<b>B</b>					<b>Z</b>				<b>9</b>	<b>K</b>	<b>E</b>
Digit No:	1	2	3	4	5	6	7	8	9	10	11	12

- 1 – 2 Breakout Series LSZH Ultra-Fox:  
2.0mm Subcables = **BE**  
2.5mm Subcables = **BX**
- 3 – 5 Fiber count: (see cable characteristics chart) = **002-024**
- 6 Jacket type: Indoor/Outdoor Zero-Halogen = **Z**
- 7 – 9 Fiber type: (see Laser Ultra-Fox Fiber Performance Table, pg. 116)
- 10 Ultra-Fox fiber with 900µm tight-buffer = **9**
- 11 Standard jacket color: Black = **K**
- 12 Rating: Flame-Retardant Zero-Halogen = **E**

**Example:** 24 fiber LSZH breakout cable using OM3 laser optimized bend-insensitive fiber, black jacket

<b>B</b>	<b>X</b>	<b>0</b>	<b>2</b>	<b>4</b>	<b>Z</b>	<b>A</b>	<b>L</b>	<b>T</b>	<b>9</b>	<b>K</b>	<b>E</b>
----------	----------	----------	----------	----------	----------	----------	----------	----------	----------	----------	----------

## (4.2g) B-Series Breakout – Riser Rated Tray Cables

1. Central Filler/Strength Member
  2. Subcable
  3. Outer Jacket
  4. Ripcord
- Subcable**
5. Tight-Buffer Optical Fiber
  6. Aramid Strength Member
  7. Subcable Jacket

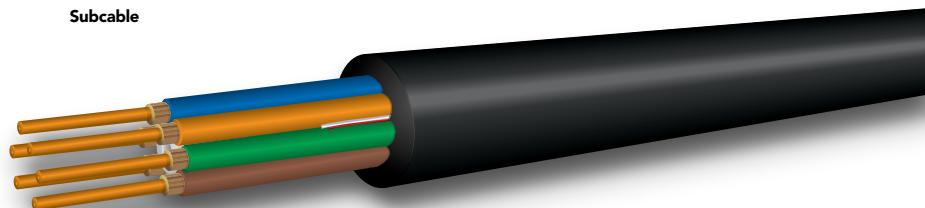
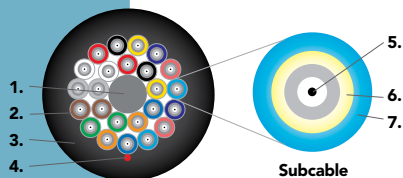

### Applications

- Ideal for installations requiring an extremely rugged and reliable cable design where maximum mechanical and environmental protection are necessary
- Typical industrial uses are factory automation, power generation and other utilities, oil and gas refining, and surface mining
- Easiest cable to install where direct termination of the subcable to a connector and a direct run to panels and equipment are desired
- Ideal for locations requiring low-temperature performance along with a flame rating

### Features

- Individual fibers and strength members protected in a subcable configuration
- Most rugged cable design with individual subcables for routing to diverse intelligent devices with direct connector termination at each device
- Independently tested to CSA C22.2 No. 230 (tray cables)
- Fibers may be directly terminated at factory devices or central locations using connectors with no further protection required
- J-jacket is UV, fungus and moisture resistant
- Designed for indoor/outdoor installations, including cable trays
- 2 to 72 fiber counts are available with 2.0mm or 2.5mm subcables
- Low-temperature PVC outer jacket (J material) provides excellent performance and flexibility at low temperatures
- Wide operating temperature range of -50°C to +75°C
- Core-Locked™ jacket prevents cable from flattening and the jacket from wrinkling in tight-bends
  - Permits pulling with direct attachment of wire mesh grip; no need to access inner aramid strength members
  - Improves crush and tear resistance
  - Contains 25% more material than conventional jackets
- High crush and tensile load ratings compared to similar tray service fiber optic cables
- Oil resistant for use in industrial applications
- UL listed in accordance with NEC section 770.179(b) for use in vertical runs in building riser shafts or from floor to floor
- Designed to exceed the flammability requirements of Chapter 8 of IEEE 383



### Applicable Standards

OCC indoor/outdoor tight-buffered fiber optic cables meet or exceed the functional requirements of the following standards:

- ICEA-S-83-596
- ICEA-S-104-696
- GR-409-CORE ISSUE 2
- TIA-568
- TIA-598
- UL 1666
- CSA C22.2 No. 232
- CSA C22.2 No. 230

## (4.2g) B-Series Breakout – Riser Rated Tray Cables



### Mechanical and Environmental Performance

	INDOOR/OUTDOOR
Operating temperature	-50°C to + 75°C
Storage temperature	-55°C to + 85°C
Installation temperature (cable temp.)	-30°C to + 60°C
Flame retardancy	UL listed type OFNR (UL 1666) and FT4 (CSA C22.2 No. 232)
Crush resistance (TIA-455-41)	2,200 N/cm
Flex resistance (TIA-455-104)	2,000 cycles

### Cable Characteristics: B-Series Breakout Riser Rated Tray Cables (with 2.0mm subcables)

FIBER COUNT	DIAMETER MM (IN)	WEIGHT KG/KM (LBS/1,000')	TENSILE LOAD		MINIMUM BEND RADIUS	
			INSTALLATION N (LBS)	OPERATIONAL N (LBS)	INSTALLATION CM (IN)	LONG-TERM CM (IN)
2	6.0 (0.24)	40 (27)	800 (180)	200 (40)	9.0 (3.5)	6.0 (2.4)
4	6.9 (0.27)	52 (35)	1,600 (360)	400 (90)	10.4 (4.1)	6.9 (2.7)
6	8.1 (0.32)	67 (45)	2,400 (540)	600 (130)	12.2 (4.8)	8.1 (3.2)
8	9.4 (0.37)	88 (59)	3,200 (720)	800 (180)	14.1 (5.6)	9.4 (3.7)
12	10.9 (0.43)	108 (73)	4,800 (1,000)	1,200 (270)	16.4 (6.5)	10.9 (4.3)
18	12.6 (0.50)	156 (105)	6,000 (1,350)	1,500 (340)	18.9 (7.4)	12.6 (5.0)
24	14.7 (0.58)	218 (146)	7,200 (1,600)	1,800 (400)	22.1 (8.7)	14.7 (5.8)
30	16.8 (0.66)	268 (180)	9,600 (2,100)	2,400 (540)	25.2 (9.9)	16.8 (6.6)
36	16.8 (0.66)	266 (179)	9,600 (2,100)	2,400 (540)	25.2 (9.9)	16.8 (6.6)
48	20.1 (0.79)	387 (260)	12,000 (2,700)	3,000 (680)	30.2 (11.9)	20.1 (7.9)
60	22.7 (0.89)	489 (329)	15,000 (3,400)	3,750 (850)	34.1 (13.4)	22.7 (8.9)
72	26.0 (1.02)	652 (438)	16,800 (3,800)	4,200 (900)	39.0 (15.4)	26.0 (10.2)

Installation loads in excess of 2,700 N (600 lbs.) are not recommended.



 (4.2g) B-Series Breakout – Riser Rated Tray Cables

## Cable Characteristics: Breakout Tray Cables (with 2.5mm subcables)

FIBER COUNT	DIAMETER MM (IN)	WEIGHT KG/KM (LBS/1,000')	TENSILE LOAD		MINIMUM BEND RADIUS	
			INSTALLATION N (LBS)	OPERATIONAL N (LBS)	INSTALLATION CM (IN)	LONG-TERM CM (IN)
2	7.0 (0.28)	41 (28)	1,200 (270)	500 (110)	10.5 (4.1)	7.0 (2.8)
4	8.3 (0.33)	68 (46)	2,000 (450)	800 (180)	12.5 (4.9)	8.3 (3.3)
6	9.6 (0.38)	88 (59)	3,000 (670)	1,200 (270)	14.4 (5.7)	9.6 (3.8)
8	11.6 (0.46)	133 (89)	4,000 (900)	1,700 (380)	17.4 (6.9)	11.6 (4.6)
12	14.1 (0.55)	159 (107)	6,000 (1,350)	2,500 (560)	21.2 (8.3)	14.1 (5.5)
18	15.3 (0.60)	226 (152)	8,000 (1,800)	3,500 (790)	23.0 (9.1)	15.3 (6.0)
24	17.6 (0.69)	292 (196)	10,000 (2,250)	3,800 (850)	26.4 (10.4)	17.6 (6.9)
30	20.9 (0.82)	383 (257)	14,000 (3,150)	6,000 (1,350)	31.4 (12.3)	20.9 (8.2)
36	20.9 (0.82)	375 (252)	14,000 (3,150)	6,000 (1,350)	31.4 (12.3)	20.9 (8.2)
48	24.2 (0.95)	501 (336)	18,000 (4,050)	7,500 (1,690)	36.3 (14.3)	24.2 (9.5)
60	28.5 (1.12)	773 (519)	22,000 (4,950)	8,800 (1,980)	42.8 (16.8)	28.5 (11.2)
72	28.9 (1.14)	768 (516)	26,000 (5,845)	11,000 (2,470)	43.4 (17.1)	28.9 (11.4)

Installation loads in excess of 2,700 N (600 lbs.) are not recommended.  
Other fiber counts available upon request.

## Ordering Information

	<b>B</b>					<b>J</b>				<b>9</b>	<b>K</b>	<b>R</b>
Digit No:	1	2	3	4	5	6	7	8	9	10	11	12

- 1 – 2 Breakout Series Ultra-Fox Tray Cables:  
2.0mm Subcables = **BE**  
2.5mm Subcables = **BX**
- 3 – 5 Fiber count: (see cable characteristics chart) = **002–072**
- 6 Jacket type: Indoor/Outdoor Tray = **J**
- 7 – 9 Fiber type: (see Laser Ultra-Fox Fiber Performance Table, pg. 116)
- 10 Ultra-Fox fiber with 900µm tight-buffer = **9**
- 11 Standard jacket color: Black = **K**
- 12 Rating: Riser = **R**

**Example:** 72-fiber riser rated tray cabling using OM3 laser optimized bend-insensitive fiber, 2.5mm subcable, black jacket

<b>B</b>	<b>X</b>	<b>0</b>	<b>7</b>	<b>2</b>	<b>J</b>	<b>S</b>	<b>L</b>	<b>A</b>	<b>9</b>	<b>K</b>	<b>R</b>
----------	----------	----------	----------	----------	----------	----------	----------	----------	----------	----------	----------

## (4.2h) G-Series Subgrouping – Riser Rated Cables

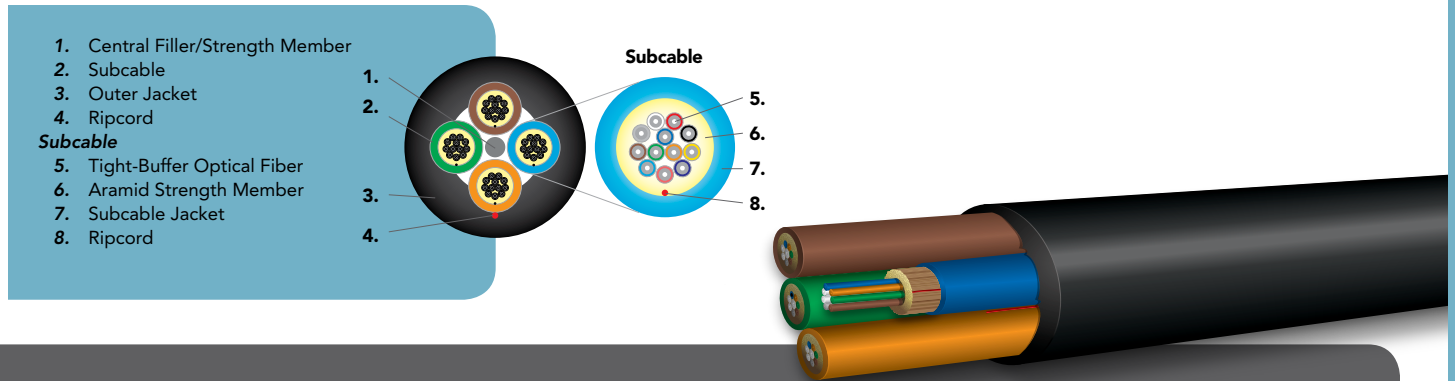

### Applications

- Indoor/outdoor tight-buffered design allows cables to be installed in intra-building backbone and inter-building campus locations without costly transitions between cable types
- Design allows multifiber subcables to be routed to multiple locations, such as wiring racks and closets

### Features

- High-performance components and construction
- UL listed in accordance with NEC sections 770.179(b) for use in vertical runs in building riser shafts or from floor to floor
- Cable materials are indoor/outdoor — UV, water and fungus resistant
- Wide operating temperature range of -40°C to +85°C
- Helically stranded core for greater flexibility and mechanical protection of the optical fibers
- Core-Locked™ outer jacket surrounds the subcables for excellent crush resistance, survivability and use in long, vertical installations
- Multifiber color-coded subcables, each similar to the D-Series Distribution cable, are easy to identify for improved cable management during installation
- Subcabling cable design permits mid-span access
- Best design for multimode and single-mode fiber composite cables
- Ideal for direct pulling with wire mesh grips
- Available with 6-fiber (4.5mm) or 12-fiber (5.5mm) subcables
- Interlocking armor can be applied to cables as an alternative to conduit installation

### Cost Savings

- 900µm buffer eliminates the need for costly and time-consuming installation of fanout kits or pigtail splices, because connectors terminate directly to the fiber
- No need to splice outdoor cable to indoor cable at building entrance
- High crush resistance may eliminate the need for innerduct

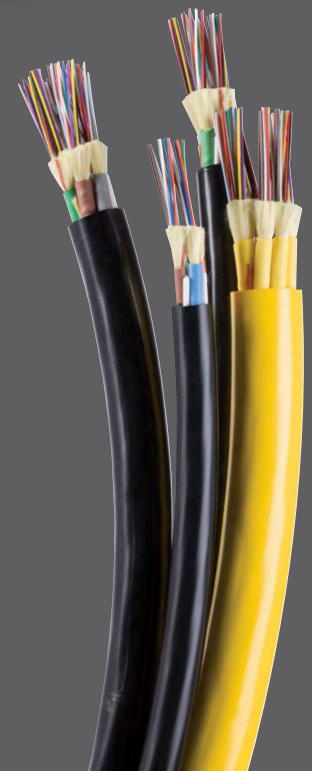

### Applicable Standards

OCC indoor/outdoor tight-buffered fiber optic cables meet or exceed the functional requirements of the following standards:

- ICEA-S-83-596
- ICEA-S-104-696
- GR-409-CORE ISSUE2
- TIA-568
- TIA-598
- UL 1651
- UL 1666

### Mechanical and Environmental Performance

	INDOOR/OUTDOOR
Operating temperature	-40°C to +85°C
Storage temperature	-55°C to +85°C
Installation temperature (cable temp.)	-10°C to +60°C
Flame retardancy	UL listed type OFNR (UL 1666) and FT4 (CSA C22.2 No. 232)
Crush resistance (TIA-455-41)	2,100 N/cm
Flex resistance (TIA-455-104)	2,000 cycles

Consistent with the definition in TIA-440-B "Fiber Optic Terminology," hybrid cable is defined as a cable containing both optical fibers and electrical conductors. Composite cable is defined as a cable containing mixed fiber types. Prior to 2012 some U.S. standards documents use definitions for hybrid and composite which are opposite of those stated here. The change in convention was made in the interest of harmonization with International standards and other National standards.

**(4.2h) G-Series Subgrouping – Riser Rated Cables**

**Cable Characteristics:  
G-Series Subgrouping Riser Cable with 6-Fiber Subcables (4.5mm subcables)**

FIBER COUNT	DIAMETER MM (IN)	WEIGHT KG/KM (LBS/1,000')	TENSILE LOAD		MINIMUM BEND RADIUS	
			INSTALLATION N (LBS)	OPERATIONAL N (LBS)	INSTALLATION CM (IN)	LONG-TERM CM (IN)
12	14.6 (0.57)	207 (139)	3,800 (850)	1,200 (270)	21.9 (8.6)	14.6 (5.7)
18	14.6 (0.57)	208 (140)	4,700 (1,060)	1,800 (400)	21.9 (8.6)	14.6 (5.7)
24	14.6 (0.57)	209 (140)	5,600 (1,260)	1,900 (420)	21.9 (8.6)	14.6 (5.7)
30	15.6 (0.61)	240 (161)	7,500 (1,690)	2,400 (540)	23.4 (9.2)	15.6 (6.1)
36	16.9 (0.67)	282 (189)	8,900 (2,000)	2,850 (640)	25.4 (10.0)	16.9 (6.7)

**G-Series Subgrouping Riser Cable with 12-Fiber Subcables (5.5mm subcables)**

FIBER COUNT	DIAMETER MM (IN)	WEIGHT KG/KM (LBS/1,000')	TENSILE LOAD		MINIMUM BEND RADIUS	
			INSTALLATION N (LBS)	OPERATIONAL N (LBS)	INSTALLATION CM (IN)	LONG-TERM CM (IN)
24	16.6 (0.65)	259 (174)	4,600 (1,030)	1,500 (340)	24.9 (9.8)	16.6 (6.5)
36	16.6 (0.65)	258 (173)	5,900 (1,330)	1,050 (440)	24.9 (9.8)	16.6 (6.5)
48	16.6 (0.65)	257 (173)	7,200 (1,620)	2,400 (540)	24.9 (9.8)	16.6 (6.5)
60	18.4 (0.72)	308 (207)	9,500 (2,140)	3,150 (710)	27.6 (10.9)	18.4 (7.2)
72	20.1 (0.79)	364 (245)	11,300 (2,540)	3,750 (840)	30.2 (11.9)	20.1 (7.9)
84	21.8 (0.86)	425 (286)	13,100 (2,950)	4,350 (980)	32.7 (12.9)	21.8 (8.6)
96	23.6 (0.93)	495 (333)	14,900 (3,350)	4,950 (1,110)	35.4 (13.9)	23.6 (9.3)
108	25.7 (1.01)	587 (394)	18,200 (4,090)	6,000 (1,350)	38.6 (15.2)	25.7 (10.1)
120	27.7 (1.09)	684 (460)	19,500 (4,380)	6,450 (1,450)	41.6 (16.4)	27.7 (10.9)
132	28.1 (1.11)	646 (434)	20,800 (4,680)	6,900 (1,550)	42.2 (16.6)	28.1 (11.1)
144	28.1 (1.11)	645 (433)	22,100 (4,970)	7,350 (1,650)	42.2 (16.6)	28.1 (11.1)

Installation loads in excess of 2,700 N (600 lbs.) are not recommended

**Ordering Information**

Digit No:	1	2	3	4	5	6	7	8	9	10	11	12
	<b>G</b>					<b>D</b>				<b>9</b>		<b>R</b>
1	Subgrouping Series Ultra-Fox = <b>G</b>											
2	6-fiber subcables = <b>B</b> ; 12-fiber subcables = <b>X</b>											
3 – 5	Fiber count: 6-fiber subcables = <b>012–036</b> , 12-fiber subcables = <b>024–144</b>											
6	Jacket type: Indoor/Outdoor PVC = <b>D</b>											
7 – 9	Fiber type: (see Laser Ultra-Fox Fiber Performance Table, pg. 116)											
10	Ultra-Fox fiber with 900µm tight-buffer = <b>9</b>											
11	Standard jacket colors: Black = <b>K</b>											
	Optional colors available:											
	62.5µm multimode (WLS, WLX): Orange = <b>O</b>											
	50µm multimode (ALS, ALX): Orange = <b>O</b>											
	50µm 10 Gigabit multimode (ALT, ALE): Aqua = <b>Q</b>											
	Single-mode: Yellow = <b>Y</b>											
12	Rating: Riser = <b>R</b>											

**Example:** 144-fiber cable (12-fiber subcables) using Ultra-Fox single-mode low water peak fiber, yellow jacket

**G X 1 4 4 D S L X 9 Y R**

## (4.2i) G-Series Subgrouping – Plenum Rated Cables

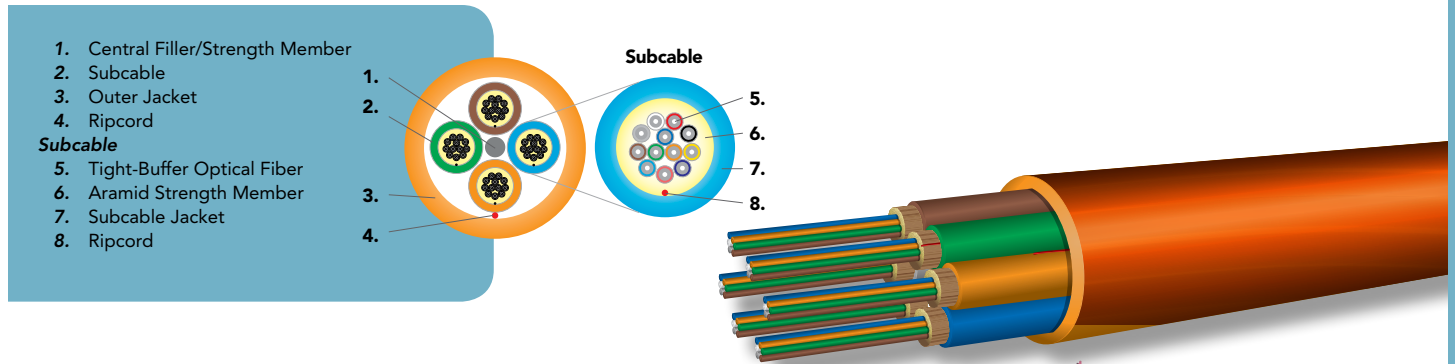

### Applications

- Used in trunking, LAN and distribution applications where versatile installation capability is required for ducts, plenums, and air-handling spaces
- Design allows subcables to be routed to multiple locations such as wiring racks and closets
- Suitable for both indoor plenum and outdoor installation – no need to splice outdoor cable to indoor cable at the building entrance

### Features

- High-performance components and construction
- UL listed in accordance with NEC sections 770.179(a) for use in ducts, plenums and air-handling spaces
- Cable materials are indoor/outdoor – UV, water and fungus resistant
- Wide operating temperature range of -40°C to +85°C
- Helically stranded core for greater flexibility and mechanical protection of the optical fibers
- Multifiber color-coded subcables, each similar to the D-Series Distribution cable, are easy to identify for improved cable management during installation
- Best design for multimode and single-mode fiber composite cables
- Available with 6-fiber (4.5mm) or 12-fiber (5.5mm) subcables
- Jacket highly chemical resistant for installation in harsh industrial environments
- Interlocking armor can be applied to cables as an alternative to conduit installation

### Cost Savings

- 900µm buffer eliminates the need for costly and time-consuming installation of fanout kits or pigtail splices, because connectors terminate directly to the fiber
- No need to splice outdoor cable to indoor cable at building entrance
- High crush resistance may eliminate the need for innerduct

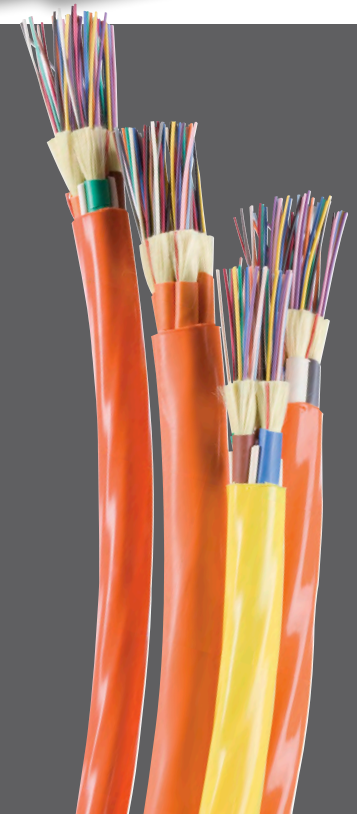

### Mechanical and Environmental Performance

	INDOOR/OUTDOOR
Operating temperature	-40°C to +85°C
Storage temperature	-40°C to +85°C
Installation temperature (cable temp.)	0°C to +60°C
Flame retardancy	UL listed type OFNP (ANSI/NFPA 262) and FT6 (CSA C22.2 No. 232)
Crush resistance (TIA-455-41)	2,100 N/cm
Flex resistance (TIA-455-104)	2,000 cycles

### Applicable Standards

OCC indoor/outdoor tight-buffered fiber optic cables meet or exceed the functional requirements of the following standards:

- ICEA-S-83-596
- ICEA-S-104-696
- GR-409-CORE ISSUE 2
- TIA-568
- TIA-598
- UL 1651
- ANSI/NFPA 262

Consistent with the definition in TIA-440-B "Fiber Optic Terminology," hybrid cable is defined as a cable containing both optical fibers and electrical conductors. Composite cable is defined as a cable containing mixed fiber types. Prior to 2012 some U.S. standards documents use definitions for hybrid and composite which are opposite of those stated here. The change in convention was made in the interest of harmonization with International standards and other National standards.

(4.2i) G-Series Subgrouping – Plenum Rated Cables

Cable Characteristics:  
G-Series Subgrouping Plenum Cable with 6-Fiber Subcables (4.5mm subcables)

FIBER COUNT	DIAMETER MM (IN)	WEIGHT KG/KM (LBS/1,000')	TENSILE LOAD		MINIMUM BEND RADIUS	
			INSTALLATION N (LBS)	OPERATIONAL N (LBS)	INSTALLATION CM (IN)	LONG-TERM CM (IN)
12	14.1 (0.56)	217 (146)	3,800 (850)	1,200 (270)	21.2 (8.3)	21.2 (8.3)
18	14.1 (0.56)	211 (142)	4,700 (1,060)	1,500 (340)	21.2 (8.3)	21.2 (8.3)
24	14.1 (0.56)	206 (138)	5,600 (1,260)	1,800 (400)	21.2 (8.3)	21.2 (8.3)
30	14.7 (0.58)	243 (163)	7,500 (1,690)	2,400 (540)	22.1 (8.7)	22.1 (8.7)
36	16.1 (0.63)	262 (176)	8,900 (2,000)	2,850 (640)	24.2 (9.5)	24.2 (9.5)

G-Series Subgrouping Plenum Cable with 12-Fiber Subcables (5.5mm subcables)

FIBER COUNT	DIAMETER MM (IN)	WEIGHT KG/KM (LBS/1,000')	TENSILE LOAD		MINIMUM BEND RADIUS	
			INSTALLATION N (LBS)	OPERATIONAL N (LBS)	INSTALLATION CM (IN)	LONG-TERM CM (IN)
24	15.4 (0.61)	273 (183)	4,600 (1,030)	1,500 (340)	23.2 (9.1)	23.2 (9.1)
36	15.4 (0.61)	263 (177)	5,900 (1,330)	1,950 (440)	23.2 (9.1)	23.2 (9.1)
48	15.4 (0.61)	254 (170)	7,200 (1,620)	2,400 (540)	23.2 (9.1)	23.2 (9.1)
60	16.9 (0.67)	293 (197)	9,500 (2,140)	3,150 (710)	25.4 (10.0)	25.4 (10.0)
72	18.4 (0.72)	317 (213)	11,300 (2,540)	3,750 (840)	27.6 (10.9)	27.6 (10.9)
84	20.2 (0.80)	352 (237)	13,100 (2,950)	4,350 (980)	30.3 (11.9)	30.3 (11.9)
96	21.7 (0.85)	397 (267)	14,900 (3,350)	4,950 (1,113)	32.6 (12.8)	32.6 (12.8)
108	23.4 (0.92)	445 (299)	18,200 (4,090)	6,000 (1,350)	35.1 (13.8)	35.1 (13.8)
120	25.3 (1.00)	484 (325)	19,500 (4,380)	6,450 (1,450)	38.0 (14.9)	38.0 (14.9)
132	25.5 (1.00)	620 (416)	20,800 (4,680)	6,900 (1,550)	38.3 (15.1)	38.3 (15.1)
144	25.5 (1.00)	620 (416)	22,100 (4,970)	7,350 (1,650)	38.3 (15.1)	38.3 (15.1)

Installation loads in excess of 2,700 N (600 lbs.) are not recommended. Other fiber counts available upon request.

Ordering Information

Digit No:	1	2	3	4	5	6	7	8	9	10	11	12
	<b>G</b>								<b>9</b>			<b>P</b>
1	Subgrouping Series Ultra-Fox = <b>G</b>											
2	6-fiber subcables = <b>B</b> ; 12-fiber subcables = <b>X</b>											
3 – 5	Fiber count: 6-fiber subcables = <b>012–036</b> , 12-fiber subcables = <b>024–072</b>											
6	Jacket type: Indoor/Outdoor Fluoropolymer (12–72 fiber) = <b>K</b> , (84–144 fiber) = <b>W</b>											
7 – 9	Fiber type: (see Laser Ultra-Fox Fiber Performance Table, pg. 116)											
10	Ultra-Fox fiber with 900µm tight-buffer = <b>9</b>											
11	Standard jacket colors: 62.5µm multimode (WLS, WLX): Orange = <b>O</b> 50µm multimode (ALS, ALX): Orange = <b>O</b> 50µm 10 Gigabit multimode (ALT, ALE): Aqua = <b>Q</b> Single-mode: Yellow = <b>Y</b>											
12	Rating: Plenum = <b>P</b>											

**Example:** 48-fiber cable (12-fiber subcables) plenum rated using bend-insensitive low water peak single-mode fiber, yellow jacket

**G X 0 4 8 K S L A 9 Y P**



## (4.2j) G-Series Subgrouping – Riser Rated Tray Cable

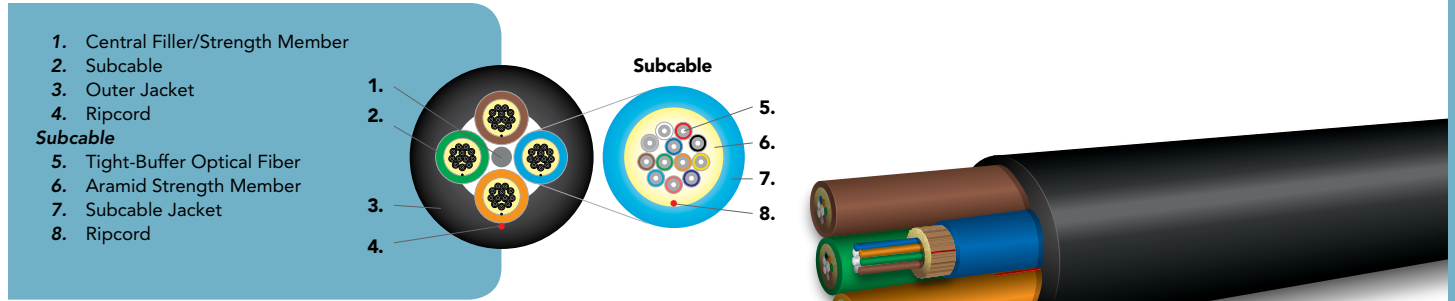

### Applications

- Ideal for installations requiring a rugged and reliable cable design where maximum mechanical and environmental protection are necessary
- Typical industrial uses are factory automation, power generation and other utilities, oil and gas refining, and surface mining

### Features

- Best design for multimode and single-mode fiber hybrid/composite cables
- Design allows multi-fiber subcables to be routed to multiple locations such as wiring racks and closets
- Independently tested to CSA C22.2 No. 230 (tray cables)
- Color-coded subcables are easy to identify for improved cable management in routing and termination
- Designed for indoor/outdoor installations, including cable trays
- 12- to 144-fiber configurations are available with 6 or 12 fibers per subcable
- Low-temperature PVC outer jacket (J material) provides excellent performance and flexibility at low temperatures
- Jacket is UV, fungus and moisture resistant
- Wide operating temperature range of -50°C to +75°C
- Core-Locked™ jacket prevents cable from flattening and the jacket from wrinkling in tight bends
  - Permits pulling with direct attachment of wire mesh grip; no need to access inner aramid strength members
  - Improves crush and tear resistance
  - Contains 25% more material than conventional jackets
- High crush and tensile load ratings compared to similar tray service fiber optic cables
- Oil resistant for use in industrial applications
- UL listed in accordance with NEC section 770.179(b) for use in vertical runs in building riser shafts or from floor to floor
- Designed to exceed the flammability requirements of Chapter 8 IEEE 383



### Applicable Standards

OCC indoor/outdoor tight-buffered fiber optic cables meet or exceed the functional requirements of the following standards:

- ICEA-S-83-596
- ICEA-S-104-696
- GR-409-CORE ISSUE 2
- TIA-568
- TIA-598
- UL 1666
- CSA C22.2 NO. 232
- CSA C22.2 NO. 230

### Mechanical and Environmental Performance

	INDOOR/OUTDOOR
Operating temperature	-50°C to +75°C
Storage temperature	-55°C to +85°C
Installation temperature (cable temp.)	-30°C to +60°C
Flame retardancy	UL listed type OFNR (UL 1666) FT4 (CSA C22.2 No. 232)
Crush resistance (TIA-455-41)	2,100 N/cm
Flex resistance (TIA-455-104)	2,000 cycles

Consistent with the definition in TIA-440-B "Fiber Optic Terminology," hybrid cable is defined as a cable containing both optical fibers and electrical conductors. Composite cable is defined as a cable containing mixed fiber types. Prior to 2012 some U.S. standards documents use definitions for hybrid and composite which are opposite of those stated here. The change in convention was made in the interest of harmonization with International standards and other National standards.

 (4.2j) G-Series Subgrouping – Riser Rated Tray Cables

## G-Series Subgrouping Tray Cable with 6-Fiber Subcables (4.5mm subcables)

FIBER COUNT	DIAMETER MM (IN)	WEIGHT KG/KM (LBS/1,000')	TENSILE LOAD		MINIMUM BEND RADIUS	
			INSTALLATION N (LBS)	OPERATIONAL N (LBS)	INSTALLATION CM (IN)	LONG-TERM CM (IN)
12	14.6 (0.57)	221 (149)	3,800 (850)	1,200 (270)	21.9 (8.6)	14.6 (5.7)
18	14.6 (0.57)	222 (149)	4,700 (1,060)	1,800 (400)	21.9 (8.6)	14.6 (5.7)
24	14.6 (0.57)	223 (150)	5,600 (1,260)	1,900 (420)	21.9 (8.6)	14.6 (5.7)
30	15.6 (0.61)	254 (171)	7,500 (1,690)	2,400 (540)	23.4 (9.2)	15.6 (6.1)
36	16.9 (0.67)	297 (200)	8,900 (2,000)	2,850 (640)	25.4 (10.0)	16.9 (6.7)

## G-Series Subgrouping Tray Cable with 12-Fiber Subcables (5.5mm subcables)

FIBER COUNT	DIAMETER MM (IN)	WEIGHT KG/KM (LBS/1,000')	TENSILE LOAD		MINIMUM BEND RADIUS	
			INSTALLATION N (LBS)	OPERATIONAL N (LBS)	INSTALLATION CM (IN)	LONG-TERM CM (IN)
24	16.6 (0.65)	274 (184)	4,600 (1,030)	1,500 (340)	24.9 (9.8)	16.6 (6.5)
36	16.6 (0.65)	272 (183)	5,900 (1,330)	1,050 (440)	24.9 (9.8)	16.6 (6.5)
48	16.6 (0.65)	270 (181)	7,200 (1,620)	2,400 (540)	24.9 (9.8)	16.6 (6.5)
60	18.4 (0.72)	323 (217)	9,500 (2,140)	3,150 (710)	27.6 (10.9)	18.4 (7.2)
72	20.1 (0.79)	380 (255)	11,300 (2,540)	3,750 (840)	30.2 (11.9)	20.1 (7.9)
84	21.8 (0.86)	443 (298)	13,100 (2,950)	4,350 (980)	32.7 (12.9)	21.8 (8.6)
96	23.6 (0.93)	513 (345)	14,900 (3,350)	4,950 (1,110)	35.4 (13.9)	23.6 (9.3)
108	25.7 (1.01)	608 (409)	18,200 (4,090)	6,000 (1,350)	38.6 (15.2)	25.7 (10.1)
120	27.7 (1.09)	707 (475)	19,500 (4,380)	6,450 (1,450)	41.6 (16.4)	27.7 (10.9)
132	28.1 (1.11)	669 (450)	20,800 (4,680)	6,900 (1,550)	42.2 (16.6)	28.1 (11.1)
144	28.1 (1.11)	668 (449)	22,100 (4,970)	7,350 (1,650)	42.2 (16.6)	28.1 (11.1)

Installation loads in excess of 2,700 N (600 lbs.) are not recommended.  
Other fiber counts available upon request.

## Ordering Information

<b>G</b>					<b>J</b>				<b>9</b>	<b>K</b>	<b>R</b>	
<b>Digit No:</b>	<b>1</b>	<b>2</b>	<b>3</b>	<b>4</b>	<b>5</b>	<b>6</b>	<b>7</b>	<b>8</b>	<b>9</b>	<b>10</b>	<b>11</b>	<b>12</b>

- 1 Subgrouping Series Ultra-Fox = **G**
- 2 6-fiber subcables = **B**; 12-fiber subcables = **X**
- 3 – 5 Fiber count: 6-fiber subcables = **012–036**, 12-fiber subcables = **024–144**
- 6 Jacket type: Indoor/Outdoor Tray = **J**
- 7 – 9 Fiber type: (see Laser Ultra-Fox Fiber Performance Table, pg. 116)
- 10 Ultra-Fox fiber with 900µm tight-buffer = **9**
- 11 Standard jacket colors: Black = **K** (other jacket colors available upon request)
- 12 Rating: Riser = **R**

**Example:** 144-fiber riser rated tray cable (12-fiber subcables) using bend-insensitive low water peak single-mode fiber, black jacket

<b>G</b>	<b>X</b>	<b>1</b>	<b>4</b>	<b>4</b>	<b>J</b>	<b>S</b>	<b>L</b>	<b>A</b>	<b>9</b>	<b>K</b>	<b>R</b>
----------	----------	----------	----------	----------	----------	----------	----------	----------	----------	----------	----------

## (4.2k) HC-Series – High-Density Riser Rated Cables

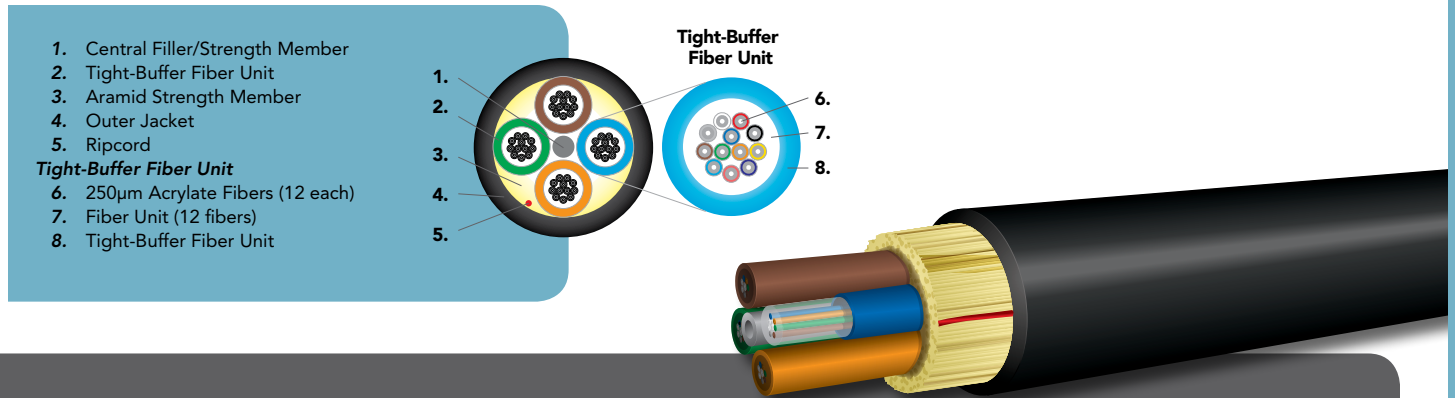

### Applications

- Designed for installation in an underground duct for data transmission between nodes or hubs
- Cable can also be routed vertically inside buildings

### Features

- Rugged tight-buffer fiber unit construction
- Cable materials are indoor/outdoor: UV, fungus and water resistant
- The high-density breakout cables offer a >20% reduction in diameter and a >20% reduction in weight relative to conventional loose-tube cables, allowing for greater fiber density and cable packing within a duct
- UL listed in accordance with NEC section 770.179(b) for use in vertical runs in building riser shafts or from floor to floor
- Core-Locked™ outer jacket design for installation survivability
- Helically stranded core for greater flexibility and mechanical protection of the optical fiber units
- Cable offers a cost savings by eliminating the need to splice outdoor cable to indoor cable at building entrance
- Cable can be terminated with 900µm fanout kit for LC connectorization
- Suitable for direct pulling with wire mesh grips



### Applicable Standards

OCC indoor/outdoor tight-buffered fiber optic cables meet or exceed the functional requirements of the following standards:

- ICEA-S-104-696
- ICEA-S-83-596
- TIA-568
- TIA-598
- UL 1666
- CSA C22.2 NO. 232

### Mechanical and Environmental Performance

	INDOOR/OUTDOOR
Operating temperature	-40°C to +85°C
Storage temperature	-55°C to +85°C
Installation temperature	-10°C to +60°C
Flame retardancy	UL listed type OFNR (UL 1666) and FT4 (CSA C22.2 No.232)
Crush resistance (TIA-455-41)	1,800 N/cm
Flex resistance (TIA-455-104)	2,000 cycles

 (4.2k) HC-Series – High-Density Riser Rated Cables

**Cable Characteristics:**  
**HC-Series High-Density Riser Cables (with 2.0mm fiber units)**

FIBER COUNT	DIAMETER MM (IN)	WEIGHT KG/KM (LBS/1,000')	TENSILE LOAD		MINIMUM BEND RADIUS	
			INSTALLATION N (LBS)	OPERATIONAL N (LBS)	INSTALLATION CM (IN)	LONG-TERM CM (IN)
24	7.6 (0.30)	72 (48)	2,700 (600)	600 (135)	11.4 (4.5)	7.6 (3.0)
48	7.6 (0.30)	72 (48)	2,700 (600)	600 (135)	11.4 (4.5)	7.6 (3.0)
72	9.0 (0.35)	93 (63)	2,700 (600)	600 (135)	13.5 (5.3)	9.0 (3.5)
96	10.3 (0.41)	111 (75)	2,700 (600)	600 (135)	15.5 (6.1)	10.3 (4.1)
120	11.7 (0.46)	136 (91)	2,700 (600)	600 (135)	17.6 (6.9)	11.7 (4.6)
144	11.7 (0.46)	146 (98)	2,700 (600)	600 (135)	17.6 (6.9)	11.7 (4.6)
168	11.7 (0.46)	146 (98)	2,700 (600)	600 (135)	17.6 (6.9)	11.7 (4.6)
192	12.9 (0.51)	172 (116)	2,700 (600)	600 (135)	19.4 (7.6)	12.9 (5.1)
216	12.9 (0.51)	172 (116)	2,700 (600)	600 (135)	19.4 (7.6)	12.9 (5.1)
288	15.0 (0.59)	218 (147)	2,700 (600)	600 (135)	22.8 (9.0)	15.0 (5.9)

\*\*Installation loads in excess of 2,700 N (600 lbs.) are not recommended.

## Ordering Information

	H	C				D					R	
Digit No:	1	2	3	4	5	6	7	8	9	10	11	12

1 – 2 High Count Series with 12-fiber bundled fiber units 2.0mm in diameter = **HC**

3 – 5 Fiber count: (see cable characteristics chart)

6 Jacket type: indoor/outdoor PVC = **D**

7 – 9 Fiber type: **SLA, ALT, ALE, WLS**

10 Jacketed fiber unit: **A** = Direct MTP termination, **C** = No direct MTP termination,

11 Standard jacket color: Black = **K**

12 Rating: Riser = **R**

**Example:** 24-fiber cable with 12-fiber units, 2.0mm in diameter using bend-insensitive single-mode fiber, indoor/outdoor PVC, black jacket riser rated, printed in feet

H	C	0	2	4	D	S	L	A	C	K	R
---	---	---	---	---	---	---	---	---	---	---	---

## (4.3a) D-Series Distribution – Interlocking Armor (ILA) Riser Rated Cables

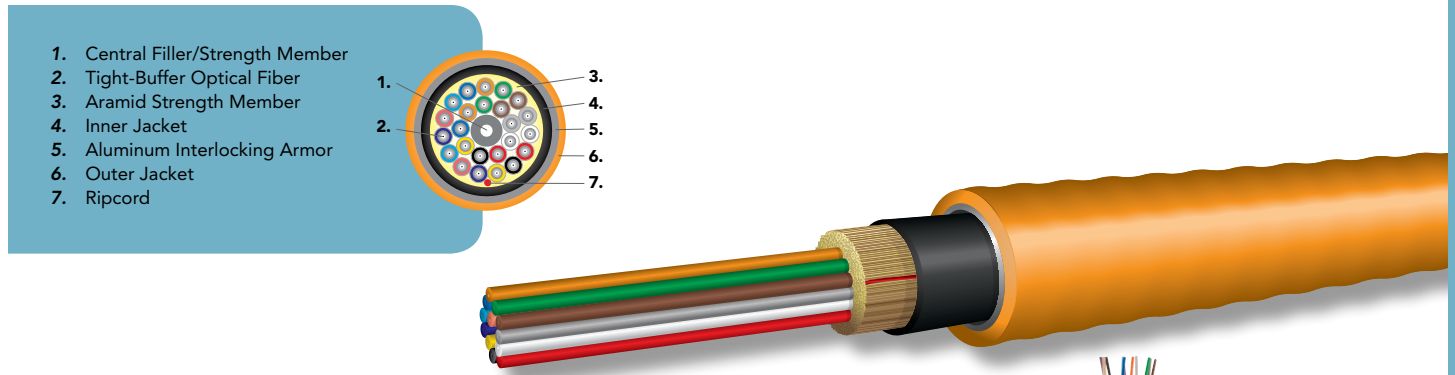

### Applications

- Ideal for industrial and other installations requiring a metallic conduit
- Interlocking preloaded armor may eliminate the need for conduit, reducing installation costs

### Features

- Inner cable is a fully functional D-Series Distribution Riser Rated Cable
- Cable materials for D-jacket type are indoor/outdoor – UL-listed OFCR and UV, water and fungus resistant
- UL listed in accordance with NEC section 770.179(b) for use in vertical runs in building risers or from floor to floor
- Aluminum interlocking armor with PVC overjacket
- Interlocking armor can be easily removed, leaving an intact inner cable
- Greater flexibility than standard corrugated steel-armored (CST) cables
- Ideal for locations that would otherwise require conduit for cable protection
- Wide operating temperature of -40°C to +85°C

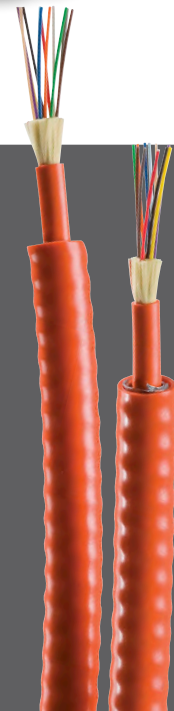

### Applicable Standards

OCC indoor/outdoor tight-buffered fiber optic cables meet or exceed the functional requirements of the following standards:

- UL 1666
- UL 1651
- ICEA-S-83-596

### Mechanical and Environmental Performance

	INDOOR/OUTDOOR
Operating temperature	-40°C to +85°C
Storage temperature	-55°C to +85°C
Installation temperature (cable temp.)	0°C to +60°C
Flame retardancy	UL listed type OFCR (UL 1666)
Crush resistance (TIA-455-41)	650 N/cm
Flex resistance (TIA-455-104)	25 cycles





## (4.3a) D-Series Distribution – Interlocking Armor (ILA) Riser Rated Cables

### Cable Characteristics: D-Series Distribution Interlocking Armor (ILA) Riser Rated Cables

FIBER COUNT	DIAMETER MM (IN)	WEIGHT KG/KM (LBS/1,000')	TENSILE LOAD		MINIMUM BEND RADIUS	
			INSTALLATION N (LBS)	OPERATIONAL N (LBS)	INSTALLATION CM (IN)	LONG-TERM CM (IN)
2	13.1 (0.52)	158 (106)	1,350 (300)	400 (90)	26.2 (10.3)	19.7 (7.8)
4	13.1 (0.52)	158 (106)	1,350 (300)	400 (90)	26.2 (10.3)	19.7 (7.8)
6	13.1 (0.52)	158 (106)	1,350 (300)	400 (90)	26.2 (10.3)	19.7 (7.8)
8	13.6 (0.54)	167 (112)	1,350 (300)	400 (90)	27.2 (10.7)	20.4 (8.0)
10	14.1 (0.56)	180 (121)	1,350 (300)	400 (90)	28.2 (11.1)	21.2 (8.3)
12	15.1 (0.59)	201 (135)	1,350 (300)	400 (90)	30.2 (11.9)	22.7 (8.9)
18	15.1 (0.59)	200 (134)	1,350 (300)	400 (90)	30.2 (11.9)	22.7 (8.9)
24	16.7 (0.66)	239 (161)	1,350 (300)	400 (90)	33.4 (13.1)	25.1 (9.9)
30	17.2 (0.68)	255 (171)	1,350 (300)	400 (90)	34.4 (13.5)	25.8 (10.2)
36	17.2 (0.68)	253 (170)	1,350 (300)	400 (90)	34.4 (13.5)	25.8 (10.2)
48	18.2 (0.72)	284 (191)	1,350 (300)	400 (90)	36.4 (14.3)	27.3 (10.7)

### Ordering Information

Digit No:	1	2	3	4	5	6	7	8	9	10	11	12	13	14
	D	X				D				9		R	I	2
1 – 2	DX-Series Distribution Ultra-Fox = <b>DX</b>													
3 – 5	Fiber count: (see cable characteristics chart) = <b>002–048</b>													
6	Jacket type: Indoor/Outdoor PVC = <b>D</b>													
7 – 9	Fiber type: (see Laser Ultra-Fox Fiber Performance Table, pg. 116)													
10	Ultra-Fox fiber with 900µm tight-buffer = <b>9</b>													
11	Standard jacket color: (outer armor)													
	62.5µm multimode (WLS, WLX): Orange = <b>O</b>													
	50µm multimode (ALS, ALX): Orange = <b>O</b>													
	50µm 10 Gigabit multimode (ALT, ALE): Aqua = <b>Q</b>													
	Single-mode: Yellow = <b>Y</b>													
12	Rating: Riser = <b>R</b>													
13 – 14	Indoor/Outdoor PVC jacket with Interlocking Armor = <b>I2</b>													

**Example:** 12-fiber distribution cable using 62.5µm Laser Ultra-Fox fiber, orange, PVC, printed in feet

**D X 0 1 2 D W L S 9 O R I 2**

## (4.3b) D-Series Distribution – Interlocking Armor (ILA) Plenum Rated Cables



1. Central Filler/Strength Member
2. Tight-Buffer Optical Fiber
3. Aramid Strength Member
4. Inner Jacket
5. Aluminum Interlocking Armor
6. Outer Jacket
7. Ripcord

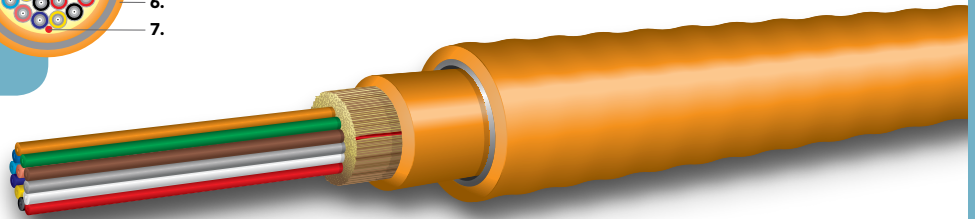
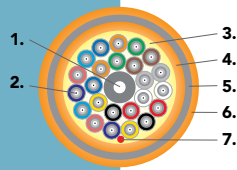

### Applications

- Ideal for industrial and other installations requiring a metallic conduit
- Interlocking preloaded armor may eliminate the need for conduit, reducing installation costs

### Features

- UL listed in accordance with NEC section 770.179(a) for use in ducts, plenums and air-handling spaces
- Cable materials for K-jacket type are indoor/outdoor – UL-listed OFCP and UV, water and fungus resistant
- Aluminum interlocking armor with flexible plenum (S) or fluoropolymer (K) overjacket
- Greater flexibility than standard corrugated steel-armored (CST) cables
- Interlocking armor can be easily removed, leaving an intact inner plenum rated cable for installation into plenums and air-handling spaces
- Wide operating temperature of -40°C to +85°C for indoor/outdoor (K Jacket)

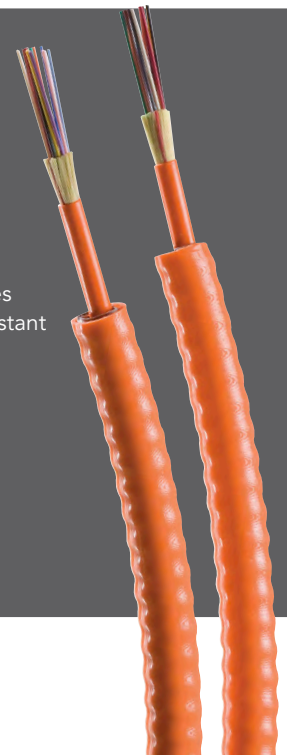

### Mechanical and Environmental Performance

	INDOOR/OUTDOOR (K)	INDOOR (S)
	PVDF Plenum	Soft Plenum
Jacket type	K	S
Operating temperature	-40°C to +85°C	0°C to +70°C
Storage temperature	-40°C to +85°C	-40°C to +70°C
Installation temperature (cable temp.)	0°C to +60°C	0°C to +60°C
Flame retardancy	UL listed type OFCP (ANSI/NFPA 262) and FT6 (CSA C22.2 No. 232)	UL listed type OFCP (ANSI/NFPA 262) and FT6 (CSA C22.2 No. 232)
Crush resistance (TIA-455-41)	650 N/cm	650 N/cm
Flex cycles (TIA-455-104)	25	25

### Applicable Standards

OCC indoor/outdoor tight-buffered fiber optic cables meet or exceed the functional requirements of the following standards:

- ANSI/NFPA 262
- ICEA-S-83-596
- UL 1651
- CSA C22.2 NO. 232



## (4.3b) D-Series Distribution – Interlocking Armor (ILA) Plenum Rated Cables

### Cable Characteristics: D-Series Distribution Interlocking Armor (ILA) Plenum Cables (Indoor/Outdoor “K” Jacket)

FIBER COUNT	DIAMETER MM (IN)	WEIGHT KG/KM (LBS/1,000')	TENSILE LOAD		MINIMUM BEND RADIUS	
			INSTALLATION N (LBS)	OPERATIONAL N (LBS)	INSTALLATION CM (IN)	LONG-TERM CM (IN)
2	13.1 (0.52)	175 (118)	1,350 (300)	400 (90)	26.2 (10.3)	19.7 (7.8)
4	13.1 (0.52)	175 (118)	1,350 (300)	400 (90)	26.2 (10.3)	19.7 (7.8)
6	13.1 (0.52)	175 (118)	1,350 (300)	400 (90)	26.2 (10.3)	19.7 (7.8)
8	13.1 (0.52)	179 (120)	1,350 (300)	400 (90)	26.2 (10.3)	19.7 (7.8)
12	14.1 (0.56)	209 (140)	1,350 (300)	400 (90)	28.2 (11.1)	21.2 (8.3)
18	14.1 (0.56)	209 (140)	1,350 (300)	400 (90)	28.2 (11.1)	21.2 (8.3)
24	16.1 (0.63)	264 (177)	1,350 (300)	400 (90)	32.2 (12.7)	24.2 (9.5)
36	16.7 (0.66)	280 (188)	1,350 (300)	400 (90)	25.1 (9.9)	25.1 (9.9)
48	17.7 (0.70)	320 (215)	1,350 (300)	400 (90)	35.4 (13.9)	26.6 (10.5)

### D-Series Distribution Interlocking Armor (ILA) Plenum Cables (Indoor “S” Jacket)

FIBER COUNT	DIAMETER MM (IN)	WEIGHT KG/KM (LBS/1,000')	TENSILE LOAD		MINIMUM BEND RADIUS	
			INSTALLATION N (LBS)	OPERATIONAL N (LBS)	INSTALLATION CM (IN)	LONG-TERM CM (IN)
2	11.8 (0.46)	123 (83)	1,350 (300)	400 (90)	23.6 (9.3)	17.7 (7.0)
4	11.8 (0.46)	123 (83)	1,350 (300)	400 (90)	23.6 (9.3)	17.7 (7.0)
6	11.8 (0.46)	123 (83)	1,350 (300)	400 (90)	23.6 (9.3)	17.7 (7.0)
8	11.8 (0.46)	137 (92)	1,350 (300)	400 (90)	23.6 (9.3)	17.7 (7.0)
12	12.8 (0.50)	161 (108)	1,350 (300)	400 (90)	25.6 (10.1)	19.2 (7.6)

### Ordering Information

Digit No:	1	2	3	4	5	6	7	8	9	10	11	12	13	14
	D	X							9		P			
1 – 2	Distribution Series Ultra-Fox = <b>DX</b>													
3 – 5	Fiber count: (see cable characteristics chart) S Jacket = <b>002-012</b> K Jacket = <b>002-048</b>													
6	Jacket type: Indoor/Outdoor Fluoropolymer = <b>K</b> ; Indoor Plenum = <b>S</b>													
7 – 9	Fiber type: (see Laser Ultra-Fox Fiber Performance Table, pg. 116)													
10	Ultra-Fox fiber with 900µm tight-buffer = <b>9</b>													
11	Standard jacket color: 62.5µm multimode (WLS, WLX) – Orange = <b>O</b> 50µm multimode (ALS, ALX) – Orange = <b>O</b> 50µm 10 Gigabit (ALT, ALE) – Aqua = <b>Q</b> Single-mode – Yellow = <b>Y</b>													
12	Rating: Plenum = <b>P</b>													
13 – 14	Indoor/Outdoor Interlocking Armor = <b>I6</b> ; Indoor Interlocking Armor = <b>I7</b>													

**Example:** 12-fiber distribution cable using laser optimized OM3 bend-insensitive fiber, indoor/outdoor interlocking armor, Aqua jacket, printed in feet

**D X 0 1 2 K A L T 9 Q P I 6**

# INDOOR/OUTDOOR ARMORED CABLES



## (4.3c) D-Series Distribution – Corrugated Steel Tape Armored Riser Rated Cables

1. Central Filler/Strength Member
2. Tight-Buffer Optical Fiber
3. Aramid Strength Member
4. Inner Jacket
5. Corrugated Steel Tape Armor
6. Outer Jacket
7. Ripcords

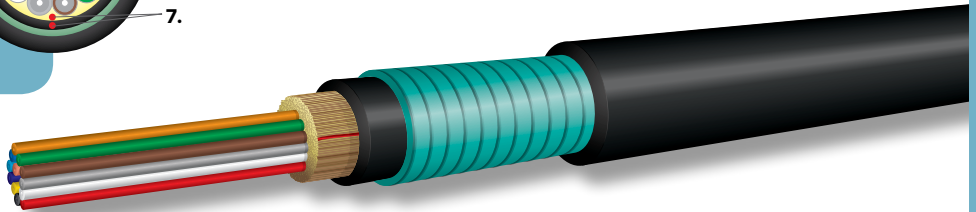
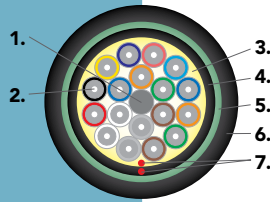

### Applications

- Ideal for installation where direct burial or rodent protection is required
- OFCR rated to allow entry into riser spaces in unlimited lengths

### Features

- Cable materials for D-jacket type are indoor/outdoor – UL-listed OFCR and UV, water and fungus resistant
- The steel armor is easily removed with an internal ripcord, leaving a fully functional intact riser rated inner cable, with original cable markings for identification
- UL listed in accordance with NEC section 770.179(b) for use in vertical runs in building riser shafts or from floor to floor
- UL listed OFCR cables with riser rated outer armor jacket. This feature eliminates the need to splice the outdoor cable to the indoor cable within 50 feet of the building entrance
- Inner tight-buffered cable is suitable for direct field termination with standard optical connectors



### Mechanical and Environmental Performance

	INDOOR/OUTDOOR
Operating temperature	-40°C to +85°C
Storage temperature	-55°C to +85°C
Installation temperature (cable temp.)	-10°C to +60°C
Flame retardancy	UL listed type OFCR (UL 1666)
Crush resistance (TIA-455-41)	440 N/cm
Flex resistance (TIA-455-104)	25 cycles

### Applicable Standards

OCC indoor/outdoor tight-buffered fiber optic cables meet or exceed the functional requirements of the following standards:

- TIA-568
- TIA-598
- ICEA-S-104-696
- UL 1666
- UL 1651



## (4.3c) D-Series Distribution – Corrugated Steel Tape Armored Riser Rated Cables

### Cable Characteristics: D-Series Distribution Corrugated Steel Tape Armored Riser Rated Cables

FIBER COUNT	DIAMETER MM (IN)	WEIGHT KG/KM (LBS/1,000')	TENSILE LOAD		MINIMUM BEND RADIUS	
			INSTALLATION N (LBS)	OPERATIONAL N (LBS)	INSTALLATION CM (IN)	LONG-TERM CM (IN)
2	11.4 (0.45)	131 (88)	1,400 (310)	450 (100)	17.1 (6.7)	11.4 (4.5)
4	11.4 (0.45)	131 (88)	1,400 (310)	450 (100)	17.1 (6.7)	11.4 (4.5)
6	11.4 (0.45)	131 (88)	1,400 (310)	450 (100)	17.1 (6.7)	11.4 (4.5)
8	11.4 (0.45)	137 (92)	1,600 (360)	525 (120)	17.1 (6.7)	11.4 (4.5)
10	12.3 (0.48)	156 (105)	1,800 (400)	600 (135)	18.5 (7.3)	12.3 (4.8)
12	13.4 (0.53)	181 (122)	2,700 (600)	900 (200)	20.1 (7.9)	13.4 (5.3)
18	13.4 (0.53)	181 (122)	2,700 (600)	900 (200)	20.1 (7.9)	13.4 (5.3)
24	14.9 (0.59)	214 (144)	3,000 (670)	1,000 (220)	22.4 (8.8)	14.9 (5.9)

Installation loads in excess of 2,700 N (600 lbs) are not recommended.

### Ordering Information

Digit No:	1	2	3	4	5	6	7	8	9	10	11	12	13	14
	D	X				D				9	K	R	A	1
1 – 2	Distribution Series Laser Ultra-Fox = <b>DX</b>													
3 – 5	Fiber count: (see cable characteristics chart) = <b>002–024</b>													
6	Jacket type: Indoor/Outdoor PVC = <b>D</b>													
7 – 9	Fiber type: (see Laser Ultra-Fox Fiber Performance Table, pg. 116)													
10	Ultra-Fox fiber with 900µm tight-buffer = <b>9</b>													
11	Standard jacket color: Black = <b>K</b>													
12	Rating: Riser = <b>R</b>													
13 – 14	Corrugated Steel Tape Armor Indoor/Outdoor PVC Jacket = <b>A1</b>													

**Example:** 12-fiber distribution cable using 62.5µm Laser Ultra-Fox fiber, black jacket, riser rated, corrugated steel tape armored, printed in feet

**D X 0 1 2 D W L S 9 K R A 1**



## (4.3d) D-Series Distribution – Rodent Deterrent (FRP) Riser Rated Cable

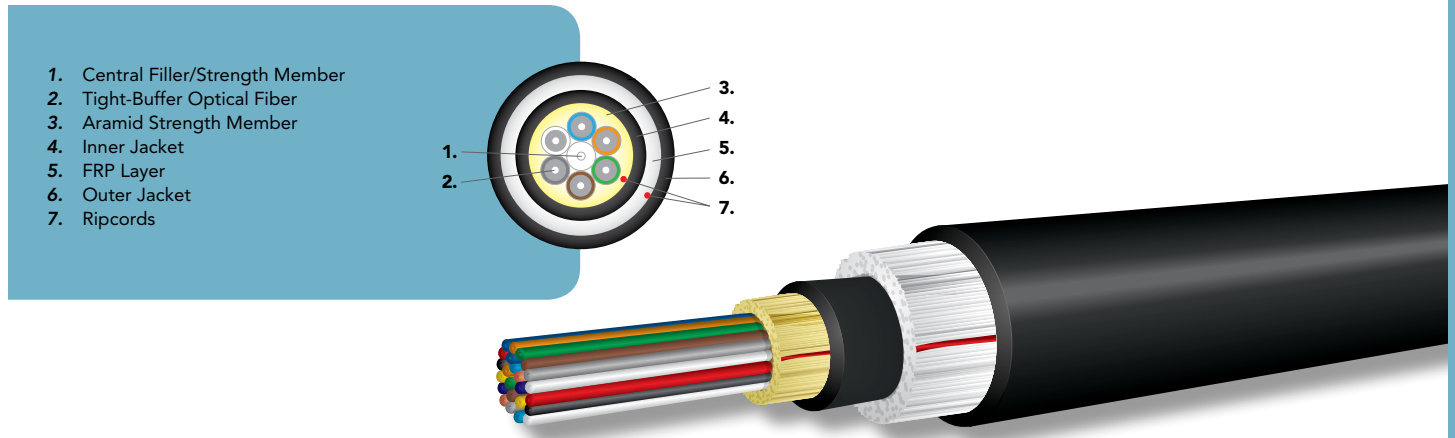

1. Central Filler/Strength Member
2. Tight-Buffer Optical Fiber
3. Aramid Strength Member
4. Inner Jacket
5. FRP Layer
6. Outer Jacket
7. Ripcords

### Applications

- Used in areas that require a riser rating and are susceptible to damage from small non-burrowing rodents

### Features

- Includes a layer of fiberglass yarn that provides an effective deterrent to damage caused by small non-burrowing rodents (not recommended for direct burial applications)
- FRP is ideal for use in surface installations
- 2 to 144 fibers
- Helically stranded cable core for flexibility, survival in difficult pulls, and excellent mechanical protection for the optical fibers
- Cables are suitable for use with single, as well as multichannel connectors
- Water resistant and UV resistant for extreme environments



### Mechanical and Environmental Performance

	INDOOR/OUTDOOR
Operating temperature	-40°C to +85°C
Storage temperature	-55°C to +85°C
Installation temperature (cable temp.)	-10°C to +60°C
Flame retardancy	UL listed type OFNR (UL 1666)
Crush resistance (TIA-455-41)	1,800 N/cm
Flex resistance (TIA-455-104)	2,000 cycles

### Applicable Standards

OCC indoor/outdoor tight-buffered fiber optic cables meet or exceed the functional requirements of the following standards:

- GR-409-CORE ISSUE 2
- ICEA-S-104-696
- ICEA-S-83-596
- TIA-568
- TIA-598
- UL 1666
- UL 1651



## (4.3d) D-Series Distribution – Rodent Deterrent (FRP) Riser Rated Cables

### Cable Characteristics: D-Series Distribution Rodent Deterrent (FRP) Riser Cables

FIBER COUNT	DIAMETER MM (IN)	WEIGHT KG/KM (LBS/1,000')	TENSILE LOAD		MINIMUM BEND RADIUS	
			INSTALLATION N (LBS)	OPERATIONAL N (LBS)	INSTALLATION CM (IN)	LONG-TERM CM (IN)
2	9.7 (0.38)	95 (64)	1,400 (310)	450 (100)	14.6 (5.7)	9.7 (3.8)
4	9.7 (0.38)	95 (64)	1,400 (310)	450 (100)	14.6 (5.7)	9.7 (3.8)
6	9.7 (0.38)	95 (64)	1,400 (310)	450 (100)	14.6 (5.7)	9.7 (3.8)
8	10.0 (0.39)	101 (68)	1,600 (360)	525 (120)	15.0 (5.9)	10.0 (3.9)
10	10.8 (0.43)	119 (80)	2,100 (472)	700 (157)	16.2 (6.4)	10.8 (4.3)
12	11.4 (0.45)	130 (87)	2,700 (600)	600 (135)	17.1 (6.7)	11.4 (4.5)
18	11.4 (0.45)	129 (87)	2,700 (600)	600 (135)	17.1 (6.7)	11.4 (4.5)
24	13.1 (0.52)	159 (107)	3,000 (674)	1,000 (220)	19.7 (7.8)	13.1 (5.2)
30	13.2 (0.52)	167 (112)	3,000 (674)	1,000 (220)	19.8 (7.8)	13.2 (5.2)
36	13.2 (0.52)	163 (110)	3,000 (670)	1,000 (220)	19.8 (7.8)	13.2 (5.2)
48	14.2 (0.56)	188 (126)	4,200 (940)	1,400 (310)	21.3 (8.4)	14.2 (5.6)
60	16.3 (0.64)	250 (168)	4,800 (1080)	1,600 (360)	24.5 (9.6)	16.3 (6.4)
72	18.3 (0.72)	312 (210)	5,400 (1214)	1,800 (405)	27.5 (10.8)	18.3 (7.2)
84	18.9 (0.74)	323 (217)	6,000 (1,350)	2,000 (450)	28.4 (11.2)	18.9 (7.4)
96	19.6 (0.77)	353 (237)	6,000 (1,350)	2,000 (450)	29.4 (11.6)	19.6 (7.7)
108	20.9 (0.82)	401 (269)	6,000 (1,350)	2,000 (450)	31.4 (12.4)	20.9 (8.2)
120	21.8 (0.86)	436 (293)	6,000 (1,350)	2,000 (450)	32.7 (12.9)	21.8 (8.6)
132	22.0 (0.87)	456 (306)	6,000 (1,350)	2,000 (450)	33.0 (13.0)	22.0 (8.7)
144	23.0 (0.91)	496 (333)	6,000 (1,350)	2,000 (450)	34.5 (13.6)	23.0 (9.1)

Installation loads in excess of 2,700 N (600 lbs.) are not recommended.

### Ordering Information

	<b>D</b>	<b>X</b>				<b>D</b>				<b>9</b>	<b>K</b>	<b>R</b>	<b>F</b>	<b>1</b>
<b>Digit No:</b>	<b>1</b>	<b>2</b>	<b>3</b>	<b>4</b>	<b>5</b>	<b>6</b>	<b>7</b>	<b>8</b>	<b>9</b>	<b>10</b>	<b>11</b>	<b>12</b>	<b>13</b>	<b>14</b>

- 1 – 2 Distribution Series Laser Ultra-Fox = **DX**
- 3 – 5 Fiber count: (see cable characteristics chart) = **002–144**
- 6 Jacket type: Indoor/Outdoor PVC = **D**
- 7 – 9 Fiber type: (see Laser Ultra-Fox Fiber Performance Table, pg. 116)
- 10 Ultra-Fox fiber with 900µm tight-buffer = **9**
- 11 Standard jacket color: Black = **K**
- 12 Rating: Riser = **R**
- 13 – 14 FRP Layer with Indoor/Outdoor PVC Jacket = **F1**

**Example:** 144-fiber distribution cable with FRP rodent deterrent layer, riser rated using OM3 bend-insensitive fiber, black jacket

<b>D</b>	<b>X</b>	<b>1</b>	<b>4</b>	<b>4</b>	<b>D</b>	<b>S</b>	<b>L</b>	<b>X</b>	<b>9</b>	<b>K</b>	<b>R</b>	<b>F</b>	<b>1</b>
----------	----------	----------	----------	----------	----------	----------	----------	----------	----------	----------	----------	----------	----------

# INDOOR/OUTDOOR ARMORED CABLES



## (4.3e) B-Series Breakout – Interlocking Armor (ILA) Riser Rated Cables

- 1. Central Filler/Strength Member
  - 2. Subcable
  - 3. Interlocking Armor
  - 4. Outer Jacket
  - 5. Ripcord
- Subcable**
- 6. Tight-Buffer Optical Fiber
  - 7. Aramid Strength Member
  - 8. Subcable Jacket

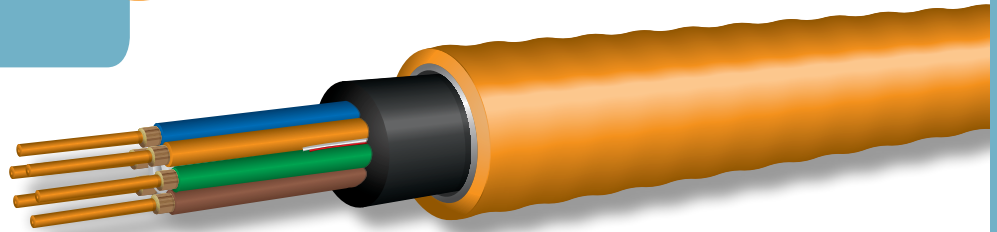

### Applications

- Ideal for industrial and other installations requiring a metallic conduit
- Interlocking armor may eliminate the need for conduit or innerduct, reducing installation costs

### Features

- Inner cable is a fully functional B-Series Breakout Rise Rated Cable
- Cable materials for D-jacket type are indoor/outdoor – UL-listed OFCR and UV, water and fungus resistant
- UL listed in accordance with NEC section 770.179(b) for use in vertical runs in building risers or from floor to floor
- Aluminum interlocking armor with PVC overjacket
- Interlocking armor can be easily removed, leaving an intact inner cable
- Greater flexibility than standard corrugated steel-armored (CST) cables
- Ideal for locations that require conduit for cable protection
- Wide operating temperature of -40°C to +85°C
- 2.0mm and 2.5mm subunits available
- Inner cable is riser rated with PVC jacket



### Applicable Standards

OCC indoor/outdoor tight-buffered fiber optic cables meet or exceed the functional requirements of the following standards:

- UL 1666
- ICEA-S-83-596
- UL 1651
- CSA C22.2 NO. 232

### Mechanical and Environmental Performance

	INDOOR/OUTDOOR
Operating temperature	-40°C to +85°C
Storage temperature	-40°C to +85°C
Installation temperature	-10°C to +60°C
Flame retardancy	UL listed type OFCR (UL 1666) and FT4 (CSA C22.2No. 232)
Crush resistance (TIA-455-41)	650 N/cm
Flex resistance (TIA-455-104)	25 cycles

 (4.3e) B-Series Breakout – Interlocking Armor (ILA) Riser Rated Cables

**Cable Characteristics:**  
**B-Series Breakout Interlocking Armor (ILA) Riser Cables (with 2.0mm subcables)**

FIBER COUNT	DIAMETER MM (IN)	WEIGHT KG/KM (LBS/1,000')	TENSILE LOAD		MINIMUM BEND RADIUS	
			INSTALLATION N (LBS)	OPERATIONAL N (LBS)	INSTALLATION CM (IN)	LONG-TERM CM (IN)
2	13.6 (0.54)	168 (113)	1,350 (300)	400 (90)	27.2 (10.7)	20.4 (8.8)
4	14.6 (0.57)	194 (130)	1,350 (300)	400 (90)	29.2 (11.5)	21.9 (8.6)
6	15.6 (0.61)	220 (148)	1,350 (300)	400 (90)	31.2 (12.3)	23.4 (9.2)
8	17.2 (0.68)	259 (174)	1,350 (300)	400 (90)	34.4 (13.5)	25.8 (10.2)
12	18.7 (0.74)	297 (200)	1,350 (300)	400 (90)	37.4 (14.7)	28.1 (11.1)
18	20.7 (0.81)	368 (247)	1,350 (300)	400 (90)	41.4 (16.3)	31.1 (12.2)
24	22.8 (0.90)	453 (304)	1,350 (300)	400 (90)	45.6 (18.0)	34.2 (13.5)

**B-Series Breakout Interlocking Armor (ILA) Riser Cables (with 2.5mm subcables)**

FIBER COUNT	DIAMETER MM (IN)	WEIGHT KG/KM (LBS/1,000')	TENSILE LOAD		MINIMUM BEND RADIUS	
			INSTALLATION N (LBS)	OPERATIONAL N (LBS)	INSTALLATION CM (IN)	LONG-TERM CM (IN)
2	14.6 (0.57)	189 (127)	1,350 (300)	400 (90)	29.2 (11.5)	21.9 (8.6)
4	16.1 (0.63)	226 (152)	1,350 (300)	400 (90)	32.2 (12.7)	24.2 (9.5)
6	17.7 (0.70)	263 (177)	1,350 (300)	400 (90)	35.4 (13.9)	26.6 (10.5)
8	19.7 (0.78)	332 (223)	1,350 (300)	400 (90)	39.4 (15.5)	29.6 (11.7)
12	22.2 (0.87)	397 (267)	1,350 (300)	400 (90)	44.4 (17.5)	33.3 (13.1)
18	23.3 (0.92)	452 (304)	1,350 (300)	400 (90)	46.6 (18.3)	35.0 (13.8)
24	25.8 (1.02)	555 (373)	1,350 (300)	400 (90)	51.6 (20.3)	38.7 (15.2)

## Ordering Information

	<b>B</b>					<b>D</b>				<b>9</b>	<b>O</b>	<b>R</b>	<b>I</b>	<b>2</b>
Digit No:	1	2	3	4	5	6	7	8	9	10	11	12	13	14

- 1 – 2 Breakout Series Ultra-Fox Cables:  
 2.0mm Subcables = **BE**  
 2.5mm Subcables = **BX**
- 3 – 5 Fiber count: (see cable characteristics chart) = **002–024**
- 6 Jacket type: Indoor/Outdoor PVC = **D**
- 7 – 9 Fiber type: (see Laser Ultra-Fox Fiber Performance Table, pg. 116)
- 10 Ultra-Fox fiber with 900µm tight-buffer = **9**
- 11 Jacket color:  
 62.5µm multimode (WLS, WLX) – Orange = **O**  
 50µm multimode (ALS, ALX) – Orange = **O**  
 50µm 10 Gigabit (ALT, ALE) – Aqua = **Q**  
 Single-mode – Yellow = **Y**
- 12 Rating: Riser = **R**
- 13 – 14 Indoor/Outdoor PVC jacket over Interlocking armor = **I2**

**Example:** 12-fiber breakout cable with 2.0mm subunits, Interlocking Armor using 62.5µm Ultra-Fox fiber, orange jacket

**B E 0 1 2 D W L S 9 O R I 2**

## (4.3f) B-Series Breakout – Interlocking Armor (ILA) Plenum Rated Cables



1. Central Filler/Strength Member
  2. Subcable
  3. Interlocking Armor
  4. Outer Jacket
  5. Ripcord
- Subcable**
6. Tight-Buffer Optical Fiber
  7. Aramid Strength Member
  8. Subcable Jacket

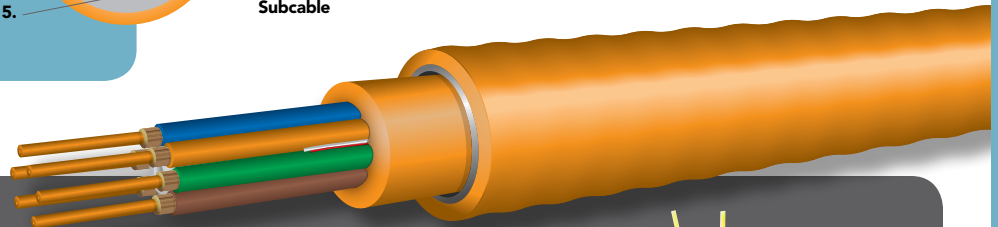
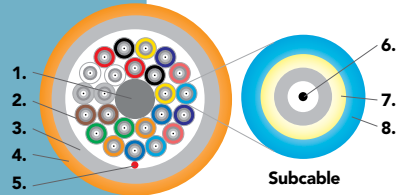

### Applications

- Ideal for industrial and other installations requiring a metallic armor
- Interlocking armor may eliminate the need for conduit, reducing installation costs

### Features

- Inner cable is a fully functional B-Series Breakout plenum rated cable
- Cable materials for K-jacket type are indoor/outdoor – UL-listed OFCP and UV, water and fungus resistant
- UL listed in accordance with NEC section 770.179(a) for use in ducts, plenums and air-handling spaces
- Aluminum interlocking armor with plenum fluoropolymer (K) overjacket
- Greater flexibility than standard corrugated steel-armored (CST) cables
- Interlocking armor can be easily removed, leaving an intact inner cable
- 2.0mm subunits are standard
- Wide operating temperature of -40°C to +85°C for (K jacket) cables



### Mechanical and Environmental Performance

	INDOOR/OUTDOOR
Operating temperature	-40°C to +85°C
Storage temperature	-40°C to +85°C
Installation temperature	0°C to +60°C (cable temp.)
Flame retardancy	UL listed type OFCP (ANSI/NFPA 262) and FT6 (CSA C22.2 No. 232)
Crush resistance (TIA-455-41)	650 N/cm
Flex resistance (TIA-455-104)	25 cycles

### Applicable Standards

OCC indoor/outdoor tight-buffered fiber optic cables meet or exceed the functional requirements of the following standards:

- ANSI/NFPA 262
- UL 1651
- ICEA-S-83-596
- CSA C22.2 NO. 232





## (4.3f) B-Series Breakout – Interlocking Armor (ILA) Plenum Rated Cables

### Cable Characteristics: B-Series Breakout Interlocking Armor (ILA) Plenum Cables (with 2.0mm subcables)

FIBER COUNT	DIAMETER MM (IN)	WEIGHT KG/KM (LBS/1,000')	TENSILE LOAD		MINIMUM BEND RADIUS	
			INSTALLATION N (LBS)	OPERATIONAL N (LBS)	INSTALLATION CM (IN)	LONG-TERM CM (IN)
2	14.1 (0.56)	189 (127)	1,350 (300)	400 (90)	28.2 (11.1)	21.2 (8.3)
4	14.1 (0.56)	189 (127)	1,350 (300)	400 (90)	28.2 (11.1)	21.2 (8.3)
6	15.1 (0.59)	218 (146)	1,350 (300)	400 (90)	30.2 (11.9)	22.7 (8.9)
8	16.7 (0.66)	263 (177)	1,350 (300)	400 (90)	33.4 (13.1)	25.1 (9.9)
12	17.7 (0.70)	304 (204)	1,350 (300)	400 (90)	36.4 (14.3)	27.3 (10.7)
18	20.2 (0.80)	385 (259)	1,350 (300)	400 (90)	35.4 (13.9)	26.6 (10.5)
24	22.3 (0.88)	468 (314)	1,350 (300)	400 (90)	44.6 (17.6)	33.5 (13.2)

### Ordering Information

	<b>B</b>	<b>X</b>				<b>K</b>				<b>9</b>		<b>P</b>	<b>I</b>	<b>6</b>
Digit No:	1	2	3	4	5	6	7	8	9	10	11	12	13	14

- 1 – 2 Breakout Series Ultra-Fox with 2.0mm subunits = **BX**
- 3 – 5 Fiber count: (see cable characteristics chart) = **002–024**
- 6 Jacket type: Indoor/Outdoor Fluoropolymer = **K**
- 7 – 9 Fiber type: (see Laser Ultra-Fox Fiber Performance Table, pg. 116)
- 10 Ultra-Fox fiber with 900µm tight-buffer = **9**
- 11 Jacket color:
  - 62.5µm multimode (WLS, WLX) – Orange = **O**
  - 50µm multimode (ALS, ALX) – Orange = **O**
  - 50µm 10 Gigabit (ALT, ALE) – Aqua = **Q**
  - Single-mode – Yellow = **Y**
- 12 Rating: Plenum = **P**
- 13 – 14 PVDF jacket over Interlocking Armor = **I6**

**Example:** 12-fiber breakout cable, Interlocking Armor using 62.5µm Laser Ultra-Fox fiber, orange jacket

<b>B</b>	<b>X</b>	<b>0</b>	<b>1</b>	<b>2</b>	<b>K</b>	<b>W</b>	<b>L</b>	<b>S</b>	<b>9</b>	<b>O</b>	<b>P</b>	<b>I</b>	<b>6</b>
----------	----------	----------	----------	----------	----------	----------	----------	----------	----------	----------	----------	----------	----------

## (4.3g) B-Series Breakout – Rodent Deterrent (FRP) Riser Rated Cables



1. Central Filler/Strength Member
  2. Subcable
  3. FRP Layer
  4. Outer Jacket
  5. Ripcord
- Subcable**
6. Tight-Buffer Optical Fiber
  7. Aramid Strength Member
  8. Subcable Jacket

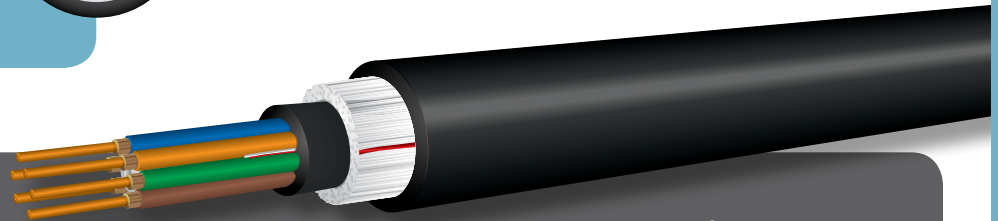
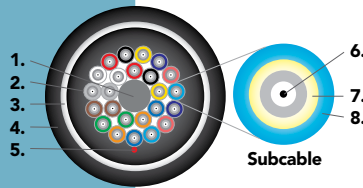

### Applications

- Used in areas that require a riser rating and are susceptible to damage from small non-burrowing rodents
- Easiest cable to install where direct termination of the subcable to a connector and a direct run to panels and equipment are desired

### Features

- Includes a layer of fiberglass yarn that provides an effective deterrent to damage caused by small non-burrowing rodents (not recommended for direct burial applications)
- FRP is ideal for use in surface installations
- UL listed in accordance with NEC section 770.179(b) for use in vertical runs in building risers or from floor to floor
- 2 to 48 fibers with 2.0mm or 2.5mm subcables available
- Helically stranded cable core for flexibility, survival in difficult pulls, and excellent mechanical protection for the optical fibers
- Cables are suitable for use with single, as well as multichannel connectors
- Water, fungus and UV resistant for extreme environments



### Applicable Standards

OCC indoor/outdoor tight-buffered fiber optic cables meet or exceed the functional requirements of the following standards:

- GR-409-CORE ISSUE 2
- ICEA-S-104-696
- ICEA-S-83-596
- TIA-568
- TIA-598
- UL 1666
- UL 1651
- CSA C22.2 NO. 232

### Mechanical and Environmental Performance

	INDOOR/OUTDOOR
Operating temperature	-40°C to +85°C
Storage temperature	-55°C to +85°C
Installation temperature	-10°C to +60°C
Flame retardancy	UL listed type OFNR (UL 1666) and FT4 (CSA C22.2No. 232)
Crush resistance (TIA-455-41)	2,200 N/cm
Flex resistance (TIA-455-104)	2,000 cycles

 (4.3g) B-Series Breakout – Rodent Deterrent (FRP) Riser Rated Cables

**Cable Characteristics:**  
**B-Series Breakout Rodent Deterrent (FRP) Riser Cables (with 2.0mm subcables)**

FIBER COUNT	DIAMETER MM (IN)	WEIGHT KG/KM (LBS/1,000')	TENSILE LOAD		MINIMUM BEND RADIUS	
			INSTALLATION N (LBS)	OPERATIONAL N (LBS)	INSTALLATION CM (IN)	LONG-TERM CM (IN)
2	11.1 (0.44)	137 (92)	1,600 (360)	400 (90)	16.7 (6.6)	11.1 (4.4)
4	11.1 (0.44)	127 (85)	1,600 (360)	400 (90)	16.7 (6.6)	11.1 (4.4)
6	12.1 (0.48)	146 (98)	2,400 (540)	600 (130)	18.2 (7.2)	12.1 (4.8)
8	13.4 (0.53)	173 (116)	3,200 (720)	800 (180)	20.1 (7.9)	13.4 (5.3)
12	14.8 (0.58)	201 (135)	4,800 (1,000)	1,200 (270)	22.2 (8.7)	14.8 (5.8)
18	16.6 (0.65)	262 (176)	6,000 (1,350)	1,500 (340)	24.9 (9.8)	16.6 (6.5)
24	18.6 (0.73)	333 (224)	7,200 (1,600)	1,800 (400)	27.9 (11.0)	18.6 (7.3)
36	21.0 (0.83)	410 (276)	9,600 (2,160)	2,400 (540)	31.5 (12.4)	21.0 (8.3)
48	24.2 (0.95)	540 (363)	12,000 (2,700)	3,000 (670)	36.3 (14.3)	24.2 (9.5)

**B-Series Breakout Rodent Deterrent (FRP) Riser Cables (with 2.5mm subcables)**

FIBER COUNT	DIAMETER MM (IN)	WEIGHT KG/KM (LBS/1,000')	TENSILE LOAD		MINIMUM BEND RADIUS	
			INSTALLATION N (LBS)	OPERATIONAL N (LBS)	INSTALLATION CM (IN)	LONG-TERM CM (IN)
2	12.5 (0.49)	149 (100)	2,000 (450)	800 (180)	18.8 (7.4)	12.5 (4.9)
4	12.5 (0.49)	148 (99)	2,000 (450)	800 (180)	18.8 (7.4)	12.5 (4.9)
6	13.6 (0.54)	172 (116)	3,000 (670)	1,200 (270)	20.4 (8.0)	13.6 (5.4)
8	15.5 (0.61)	235 (158)	4,000 (900)	1,700 (380)	23.3 (9.2)	15.5 (6.1)
12	18.0 (0.71)	280 (188)	6,000 (1,350)	2,500 (560)	27 (10.6)	18.0 (7.1)
18	19.2 (0.76)	331 (222)	8,000 (1,800)	3,500 (790)	28.8 (11.3)	19.2 (7.6)
24	21.5 (0.85)	431 (290)	10,000 (2,250)	3,800 (850)	32.3 (12.7)	21.5 (8.5)
36	25.0 (0.98)	538 (362)	14,000 (3,150)	6,000 (1,350)	37.5 (14.8)	25.0 (9.8)
48	28.2 (1.11)	676 (454)	18,000 (4,050)	7,500 (1,690)	42.3 (16.7)	28.2 (11.1)

Installation loads in excess of 2,700 N (600 lbs.) are not recommended.

**Ordering Information**

	<b>B</b>					<b>D</b>				<b>9</b>	<b>K</b>	<b>R</b>	<b>F</b>	<b>1</b>
Digit No:	1	2	3	4	5	6	7	8	9	10	11	12	13	14

- 1 – 2 Breakout Series Ultra-Fox with 2.0mm Subunits = **BE**
- Breakout Series Ultra-Fox with 2.5mm Subunits = **BX**
- 3 – 5 Fiber count: (see cable characteristics chart) = **002–048**
- 6 Jacket type: Indoor/outdoor PVC = **D**
- 7 – 9 Fiber type: (see Laser Ultra-Fox Fiber Performance Table, pg. 116)
- 10 Ultra-Fox fiber with 900µm tight-buffer = **9**
- 11 Jacket color: Black = **K**
- 12 Rating: Riser Rated = **R**
- 13 – 14 FRP Layer with Indoor/Outdoor PVC Jacket = **F1**

**Example:** 12-fiber breakout cable with FRP rodent deterrent layer, riser rated using OM3 laser optimized bend-insensitive fiber, black jacket

<b>B</b>	<b>X</b>	<b>0</b>	<b>1</b>	<b>2</b>	<b>D</b>	<b>A</b>	<b>L</b>	<b>T</b>	<b>9</b>	<b>K</b>	<b>R</b>	<b>F</b>	<b>1</b>
----------	----------	----------	----------	----------	----------	----------	----------	----------	----------	----------	----------	----------	----------

## (4.3h) G-Series Subgrouping – Interlocking Armor (ILA) Riser Rated Cables



- 1. Central Filler/Strength Member
  - 2. Subcable
  - 3. Aluminum Interlocking Armor
  - 4. Outer Jacket
  - 5. Ripcord
- Subcable**
- 6. Tight-Buffer Optical Fiber
  - 7. Aramid Strength Member
  - 8. Subcable Jacket
  - 9. Ripcord

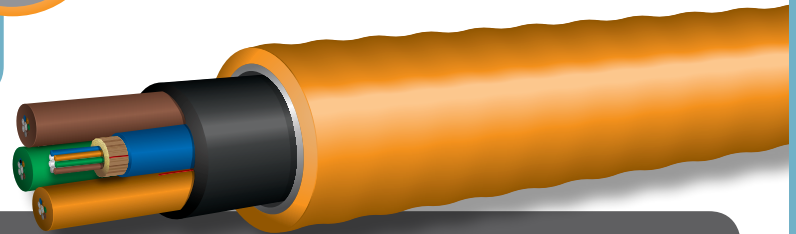
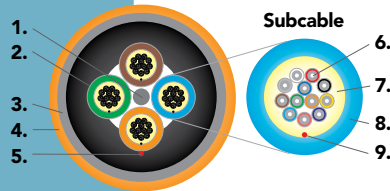

### Applications

- Ideal for industrial and other installations requiring a metallic conduit
- Interlocking armor may eliminate the need for conduit, reducing installation costs

### Features

- Inner cable is a fully functional G-Series Subgrouping Riser Rated cable
- Cable materials are indoor/outdoor – UL-listed OFCR and UV, water and fungus resistant
- UL listed in accordance with NEC section 770.179(b) for use in vertical runs in building risers or from floor to floor
- Aluminum interlocking armor with PVC overjacket
- Interlocking armor can be easily removed, leaving an intact riser rated inner cable
- Greater flexibility than standard corrugated steel-armored (CST) cables
- Ideal for locations that require conduit for cable protection
- Wide operating temperature of -40°C to +85°C



### Mechanical and Environmental Performance

	INDOOR/OUTDOOR
Operating temperature	-40°C to +85°C
Storage temperature	-40°C to +85°C
Installation temperature (cable temp.)	0°C to +60°C
Flame retardancy	UL listed type OFCR (UL 1666) and FT4 (CSA C22.2No. 232)
Crush resistance (TIA-455-41)	650 N/cm
Flex resistance (TIA-455-104)	25 cycles

### Applicable Standards

OCC indoor/outdoor tight-buffered fiber optic cables meet or exceed the functional requirements of the following standards:

- UL 1666
- ICEA-S-83-596
- UL 1651
- CSA C22.2 NO. 232

Consistent with the definition in TIA-440-B "Fiber Optic Terminology," hybrid cable is defined as a cable containing both optical fibers and electrical conductors. Composite cable is defined as a cable containing mixed fiber types. Prior to 2012 some U.S. standards documents use definitions for hybrid and composite which are opposite of those stated here. The change in convention was made in the interest of harmonization with International standards and other National standards.



## (4.3h) G-Series Subgrouping – Interlocking Armor (ILA) Riser Rated Cables

## Cable Characteristics:

## G-Series Subgrouping Interlocking Armor (ILA) Riser with 6-fiber subcables (4.5mm subcables)

FIBER COUNT	DIAMETER MM (IN)	WEIGHT KG/KM (LBS/1,000')	TENSILE LOAD		MINIMUM BEND RADIUS	
			INSTALLATION N (LBS)	OPERATIONAL N (LBS)	INSTALLATION CM (IN)	LONG-TERM CM (IN)
12	22.8 (0.9)	453 (304)	1,350 (300)	400 (90)	45.6 (18)	34.2 (13.5)
18	22.8 (0.9)	453 (304)	1,350 (300)	400 (90)	45.6 (18)	34.2 (13.5)
24	22.8 (0.9)	453 (304)	1,350 (300)	400 (90)	45.6 (18)	34.2 (13.5)
30	24.9 (0.98)	552 (371)	1,350 (300)	400 (90)	49.8 (19.6)	37.4 (14.7)
36	25.9 (1.02)	609 (409)	1,350 (300)	400 (90)	51.8 (20.4)	38.9 (15.3)

## G-Series Subgrouping Interlocking Armor (ILA) Riser with 12-fiber subcables (5.5mm subcables)

FIBER COUNT	DIAMETER MM (IN)	WEIGHT KG/KM (LBS/1,000')	TENSILE LOAD		MINIMUM BEND RADIUS	
			INSTALLATION N (LBS)	OPERATIONAL N (LBS)	INSTALLATION CM (IN)	LONG-TERM CM (IN)
24	25.9 (1.02)	586 (394)	1,350 (300)	400 (90)	51.8 (20.4)	38.9 (15.3)
36	25.9 (1.02)	586 (394)	1,350 (300)	400 (90)	51.8 (20.4)	38.9 (15.3)
48	25.9 (1.02)	586 (394)	1,350 (300)	400 (90)	51.8 (20.4)	38.9 (15.3)

## Ordering Information

Digit No:	1	2	3	4	5	6	7	8	9	10	11	12	13	14
	<b>G</b>					<b>D</b>			<b>9</b>			<b>R</b>	<b>I</b>	<b>2</b>
1	Subgrouping Series Ultra-Fox = <b>G</b>													
2	6-fiber subcables = <b>B</b> ; 12-fiber subcables = <b>X</b>													
3 – 5	Fiber count: 6-fiber subcables = <b>012–036</b> , 12-fiber subcables = <b>024–048</b>													
6	Jacket type: Indoor/Outdoor PVC = <b>D</b>													
7 – 9	Fiber type: (see Laser Ultra-Fox Fiber Performance Table, pg. 116)													
10	Ultra-Fox fiber with 900µm tight-buffer = <b>9</b>													
11	Jacket color:													
	62.5µm multimode (WLS, WLX) – Orange = <b>O</b>													
	50µm multimode (ALS, ALX) – Orange = <b>O</b>													
	50µm 10 Gigabit (ALT, ALE) – Aqua = <b>Q</b>													
	Single-mode – Yellow = <b>Y</b>													
12	Rating: Riser = <b>R</b>													
13 – 14	Interlocking Armor with Indoor/Outdoor PVC Jacket = <b>I2</b>													

**Example:** 48-fiber subgrouping cable using 12-fiber subcables with 62.5µm Laser Ultra-Fox fiber, interlocking armor, orange jacket, printed in feet

**G X 0 4 8 D W L S 9 O R I 2**

## (4.3i) G-Series Subgrouping – Interlocking Armor (ILA) Plenum Rated Cables

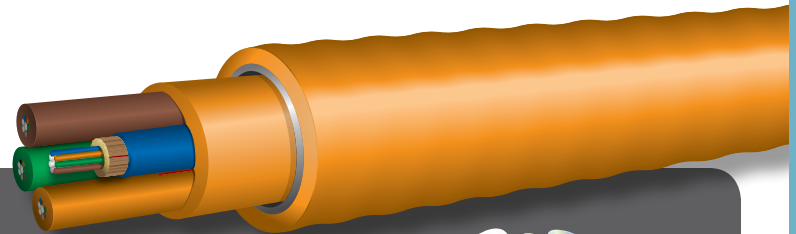
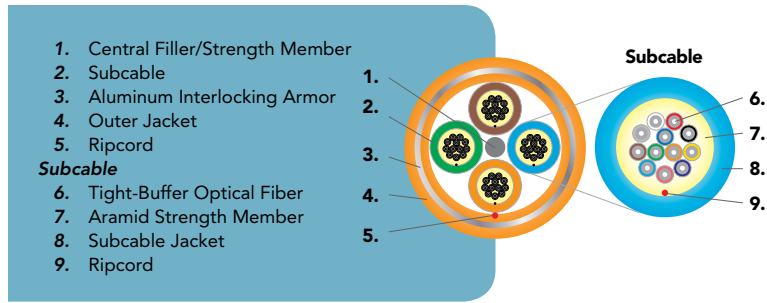

### Applications

- Ideal for industrial and other installations requiring a metallic conduit
- Interlocking armor may eliminate the need for conduit, reducing installation costs

### Features

- Inner cable is a fully functional G-Series Subgrouping Plenum Rated cable
- Cable materials for K-jacket type are indoor/outdoor – UL-listed OFCP and UV, water and fungus resistant
- UL listed in accordance with NEC section 770.179(a) for use in ducts, plenums and air-handling spaces
- Aluminum interlocking armor with a fluoropolymer (K) overjacket
- Greater flexibility than standard corrugated steel-armored (CST) cables
- Interlocking armor can be easily removed, leaving an intact plenum rated inner cable
- Wide operating temperature of -40°C to +85°C (K jacket)



### Applicable Standards

OCC indoor/outdoor tight-buffered fiber optic cables meet or exceed the functional requirements of the following standards:

- ANSI/NFPA 262
- ICEA-S-83-596
- UL 1651
- CSA C22.2 NO. 232

### Mechanical and Environmental Performance

	INDOOR/OUTDOOR
Operating temperature	-40°C to +85°C
Storage temperature	-40°C to +85°C
Installation temperature (cable temp.)	0°C to +60°C
Flame retardancy	UL listed type OFCP (ANSI/NFPA 262) and FT6 (CSA C22.2 No. 232)
Crush resistance (TIA-455-41)	650 N/cm
Flex resistance (TIA-455-104)	25 cycles

Consistent with the definition in TIA-440-B "Fiber Optic Terminology," hybrid cable is defined as a cable containing both optical fibers and electrical conductors. Composite cable is defined as a cable containing mixed fiber types. Prior to 2012 some U.S. standards documents use definitions for hybrid and composite which are opposite of those stated here. The change in convention was made in the interest of harmonization with International standards and other National standards.





## (4.3i) G-Series Subgrouping – Interlocking Armor (ILA) Plenum Rated Cables

## Cable Characteristics:

## G-Series Subgrouping Interlocking Armor (ILA) Plenum Cables with 6-fiber subcables (4.5mm subcables)

FIBER COUNT	DIAMETER MM (IN)	WEIGHT KG/KM (LBS/1,000')	TENSILE LOAD		MINIMUM BEND RADIUS	
			INSTALLATION N (LBS)	OPERATIONAL N (LBS)	INSTALLATION CM (IN)	LONG-TERM CM (IN)
12	22.7 (0.89)	504 (339)	1,350 (300)	400 (90)	45.4 (17.9)	34.1 (13.4)
18	22.7 (0.89)	502 (337)	1,350 (300)	400 (90)	45.4 (17.9)	34.1 (13.4)
24	22.7 (0.89)	500 (336)	1,350 (300)	400 (90)	45.4 (17.9)	34.1 (13.4)
30	23.8 (0.94)	550 (370)	1,350 (300)	400 (90)	47.6 (18.7)	35.7 (14.1)
36	24.8 (0.98)	538 (362)	1,350 (300)	400 (90)	49.6 (19.5)	37.2 (14.7)

## G-Series Subgrouping Interlocking Armor (ILA) Plenum Cables with 12-fiber subcables (5.5mm subcables)

FIBER COUNT	DIAMETER MM (IN)	WEIGHT KG/KM (LBS/1,000')	TENSILE LOAD		MINIMUM BEND RADIUS	
			INSTALLATION N (LBS)	OPERATIONAL N (LBS)	INSTALLATION CM (IN)	LONG-TERM CM (IN)
24	23.8 (0.94)	569 (382)	1,350 (300)	400 (90)	47.6 (18.7)	35.7 (14.1)
36	23.8 (0.94)	565 (380)	1,350 (300)	400 (90)	47.6 (18.7)	35.7 (14.1)
48	23.8 (0.94)	561 (377)	1,350 (300)	400 (90)	47.6 (18.7)	35.7 (14.1)

## Ordering Information

Digit No:	1	2	3	4	5	6	7	8	9	10	11	12	13	14
	<b>G</b>					<b>K</b>				<b>9</b>		<b>P</b>	<b>I</b>	<b>6</b>
1	Subgrouping Series Ultra-Fox = <b>G</b>													
2	6-fiber subcables = <b>B</b> ; 12-fiber subcables = <b>X</b>													
3 – 5	Fiber count: 6-fiber subcables = <b>012–036</b> , 12-fiber subcables = <b>024–048</b>													
6	Jacket type: PVDF = <b>K</b>													
7 – 9	Fiber type: (see Laser Ultra-Fox Fiber Performance Table, p.116)													
10	Ultra-Fox fiber with 900µm tight-buffer = <b>9</b>													
11	Jacket Color:													
	62.5µm multimode (WLS, WLX) – Orange = <b>O</b>													
	50µm multimode (ALS, ALX) – Orange = <b>O</b>													
	50µm 10 Gigabit (ALT, ALE) – Aqua = <b>Q</b>													
	Single-mode – Yellow = <b>Y</b>													
12	Rating: Plenum = <b>P</b>													
13 – 14	Interlocking armor with Indoor/Outdoor Fluoropolymer jacket = <b>I6</b>													

**Example:** 12-fiber subgrouping cable with 6-fiber subcables using OM3 bend-insensitive fiber, interlocking armor, aqua, K-jacket, plenum rated, printed in feet

**G B 0 1 2 K A L T 9 Q P I 6**

## (4.3j) G-Series Subgrouping – Rodent Deterrent (FRP) Riser Rated Cables



1. Central Filler/Strength Member
  2. Subcable
  3. FRP Layer
  4. Outer Jacket
  5. Ripcord
- Subcable**
6. Tight-Buffer Optical Fiber
  7. Aramid Strength Member
  8. Subcable Jacket
  9. Ripcord

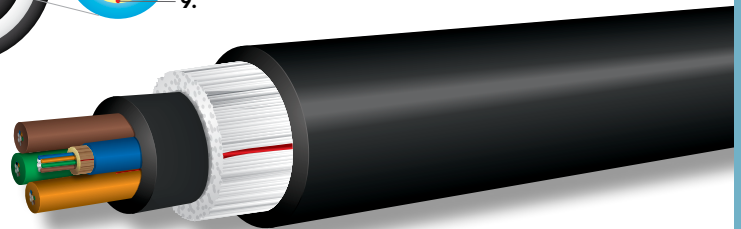
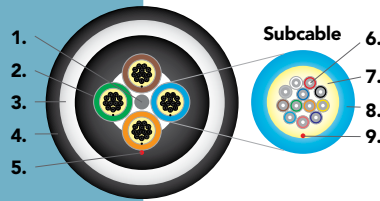

### Applications

- Used in areas that require a riser rating and are susceptible to damage from small non-burrowing rodents

### Features

- Includes a layer of fiberglass yarn that provides an effective deterrent to damage caused by small non-burrowing rodents (not recommended for direct burial applications)
- FRP is ideal for use in surface installations
- UL listed in accordance with NEC section 770.179(b) for use in vertical runs in building risers or from floor to floor
- 2 to 72 fibers
- Helically stranded cable core for flexibility, survival in difficult pulls, and excellent mechanical protection for the optical fibers
- Water resistant and UV resistant for extreme environments



### Mechanical and Environmental Performance

	INDOOR/OUTDOOR
Operating temperature	-40°C to +85°C
Storage temperature	-55°C to +85°C
Installation temperature	-10°C to +60°C
Flame retardancy	UL listed type OFNR (UL 1666) and FT4 (CSA C22.2No. 232)
Crush resistance (TIA-455-41)	2,100 N/cm
Flex resistance (TIA-455-104)	2,000 cycles

### Applicable Standards

OCC indoor/outdoor tight-buffered fiber optic cables meet or exceed the functional requirements of the following standards:

- GR-409-CORE ISSUE 2
- ICEA-S-104-696
- TIA-568
- TIA-598
- UL 1666
- UL 1651
- CSA C22.2 NO. 232

Consistent with the definition in TIA-440-B "Fiber Optic Terminology," hybrid cable is defined as a cable containing both optical fibers and electrical conductors. Composite cable is defined as a cable containing mixed fiber types. Prior to 2012 some U.S. standards documents use definitions for hybrid and composite which are opposite of those stated here. The change in convention was made in the interest of harmonization with International standards and other National standards.



## (4.3j) G-Series Subgrouping – Rodent Deterrent (FRP) Riser Rated Cables

### Cable Characteristics: G-Series Subgrouping Rodent Deterrent (FRP) Riser Cables (with 6-fiber subcables)

FIBER COUNT	DIAMETER MM (IN)	WEIGHT KG/KM (LBS/1,000')	TENSILE LOAD		MINIMUM BEND RADIUS	
			INSTALLATION N (LBS)	OPERATIONAL N (LBS)	INSTALLATION CM (IN)	LONG-TERM CM (IN)
12	18.5 (0.73)	332 (223)	3,800 (850)	1,200 (270)	27.8 (10.9)	18.5 (7.3)
18	18.5 (0.73)	332 (223)	4,700 (1,060)	1,800 (400)	27.8 (10.9)	18.5 (7.3)
24	18.5 (0.73)	332 (223)	5,600 (1,260)	1,900 (420)	27.8 (10.9)	18.5 (7.3)
30	19.4 (0.76)	368 (247)	7,500 (1,690)	2,400 (540)	29.1 (11.5)	19.4 (7.6)
36	21.1 (0.83)	436 (293)	8,900 (2,000)	2,850 (640)	31.7 (12.5)	21.1 (8.3)

### G-Series Subgrouping Rodent Deterrent (FRP) Riser Cables (with 12-fiber subcables)

FIBER COUNT	DIAMETER MM (IN)	WEIGHT KG/KM (LBS/1,000')	TENSILE LOAD		MINIMUM BEND RADIUS	
			INSTALLATION N (LBS)	OPERATIONAL N (LBS)	INSTALLATION CM (IN)	LONG-TERM CM (IN)
24	20.8 (0.82)	410 (276)	4,600 (1,030)	1,500 (340)	31.2 (12.3)	20.8 (8.2)
36	20.8 (0.82)	410 (276)	5,900 (1,330)	1,050 (440)	31.2 (12.3)	20.8 (8.2)
48	20.8 (0.82)	410 (276)	7,200 (1,620)	2,400 (540)	31.2 (12.3)	20.8 (8.2)

Installation loads in excess of 2,700 N (600 lbs.) are not recommended.

### Ordering Information

	<b>G</b>					<b>D</b>				<b>9</b>	<b>K</b>	<b>R</b>	<b>F</b>	<b>1</b>
Digit No:	1	2	3	4	5	6	7	8	9	10	11	12	13	14

- 1 Subgrouping Series Ultra-Fox = **G**
- 2 6-fiber subcables = **B**; 12-fiber subcables = **X**
- 3 – 5 Fiber count: 6-fiber subcables = **012–036**, 12-fiber subcables = **024–048**
- 6 Jacket type: Indoor/outdoor PVC = **D**
- 7 – 9 Fiber type: (see Laser Ultra-Fox Fiber Performance Table, p.116)
- 10 Ultra-Fox fiber with 900µm tight-buffer = **9**
- 11 Jacket color: Black = **K**
- 12 Rating: Riser = **R**
- 13 – 14 FRP Layer with PVC Jacket = **F1**

**Example:** 24-fiber G-series subgrouping cable with 12-fiber subcables, FRP rodent deterrent layer, indoor/outdoor PVC jacket, riser rated using 62.5µm Laser Ultra-Fox fiber, black jacket

<b>G</b>	<b>X</b>	<b>0</b>	<b>2</b>	<b>4</b>	<b>D</b>	<b>S</b>	<b>L</b>	<b>X</b>	<b>9</b>	<b>K</b>	<b>R</b>	<b>F</b>	<b>1</b>
----------	----------	----------	----------	----------	----------	----------	----------	----------	----------	----------	----------	----------	----------

## (4.4a) CX-Series Hybrid – Copper/Fiber Riser and Plenum Rated Cables



1. Ripcord
2. Copper Wire
3. Optical Fiber Subcable
4. Aramid Strength Member
5. Outer Jacket

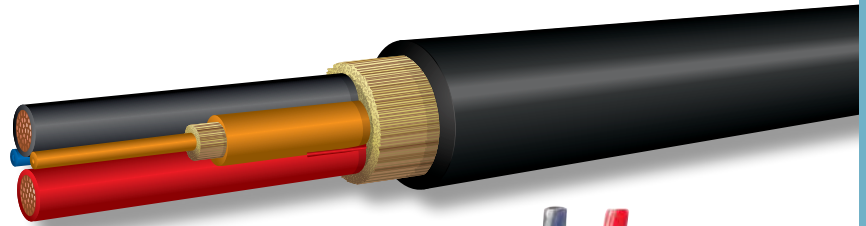
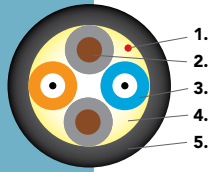

### Applications

- Ideal for data communication and control installations that require fiber and copper under one cable jacket
- Hybrid fiber/copper cables are intended for use on Class 2 power-limited circuits as described in Article 725 of the National Electrical Code

### Features

- Various combinations of copper conductors and optical fibers in a single hybrid cable
- Chemical-resistant outer jacket available for harsh industrial or outdoor environments
- 12-, 14-, 16-, 18-gauge single-stranded copper wire available for power, communication, control sensor, signal, and video
- Multimode (62.5µm or 50µm) and single-mode fiber available – contact Optical Cable Corporation for specifications and part numbers
- Larger gauge wires overcome powering distance limitations of unshielded twisted pair
- Copper and fiber individually subcabled for ease of separation, handling and termination
- Round cable design for easy installation and survivability
- Many combinations available with CL2R riser ratings or CL2P plenum ratings per UL 13
- Interlocking armor available for riser and plenum hybrid cables



### Cable Characteristics: Hybrid Cables

	PLENUM (INDOOR/OUTDOOR)	RISER (INDOOR/OUTDOOR)
Minimum bend radius: Installation load	20X outside diameter	20X outside diameter
Minimum bend radius: Long-term load	15X outside diameter	15X outside diameter
Flame retardancy	UL listed type CL2P-OF (UL 13)	UL listed type CL2R-OF (UL 13)

### Applicable Standards

OCC indoor/outdoor tight-buffered fiber optic cables meet or exceed the functional requirements of the following standard:

- UL 13

\*Many combinations of optical fibers and wires can be manufactured to your specific requirements. Please contact Optical Cable Corporation for a price quotation and specifications for the Composite Fiber/Copper Cable design that meets all your special application requirements.

Consistent with the definition in TIA-440-B "Fiber Optic Terminology," hybrid cable is defined as a cable containing both optical fibers and electrical conductors. Composite cable is defined as a cable containing mixed fiber types. Prior to 2012 some U.S. standards documents use definitions for hybrid and composite which are opposite of those stated here. The change in convention was made in the interest of harmonization with International standards and other National standards.



## (4.4a) CX-Series Hybrid – Copper/Fiber Riser and Plenum Rated Cables

## Ordering Information: Indoor/Outdoor Riser and Plenum Hybrid Cables

	C	X								9		
Digit No:	1	2	3	4	5	6	7	8	9	10	11	12
1 – 2	Hybrid Series Ultra-Fox = <b>CX</b>											
3 – 5	Fiber count: Number of fibers ( <b>002–012</b> ) + Copper Conductors ( <b>002–004</b> ) Example 1: 2-fiber/2-copper = <b>004</b> Example 2: 12-fiber/4-copper = <b>016</b>											
6	Jacket type: Indoor/Outdoor Fluoropolymer = <b>K</b> ; Indoor/Outdoor PVC = <b>D</b>											
7 – 9	Fiber/Copper type: Contact Optical Cable Corporation for three-digit part number code											
10	Ultra-Fox fiber with 900µm tight-buffer = <b>9</b>											
11	Standard jacket color: PVC (all fiber types) – Black = <b>K</b> Fluoropolymer = 62.5µm multimode (WLS, WLX) – Orange = <b>O</b> 50µm multimode (ALS, ALX) – Orange = <b>O</b> 50µm 10 Gigabit (ALT, ALE) – Aqua = <b>Q</b> Single-mode – Yellow = <b>Y</b>											
12	Rating: Plenum = <b>P</b> Riser = <b>R</b>											

**Example:** 2-fiber/2AWG-18 copper cable using 62.5µm standard Laser Ultra-Fox fiber, orange jacket

**C X 0 0 4 K • • • 9 O P \***

\* Contact OCC for specific part number

Due to the wide range of constructions possible, call for construction details.  
Call 1-800-622-7711 and ask for a Sales Representative. We're ready to assist you.

## (4.4b) CX-Series Hybrid – UL 1277 Tray Cables



1. Ripcord
2. Tight-Buffer Optical Fiber
3. Copper Wire
4. Central Fill/Strength Member
5. Aramid Strength Member
6. Outer Jacket
7. Subcable Jacket

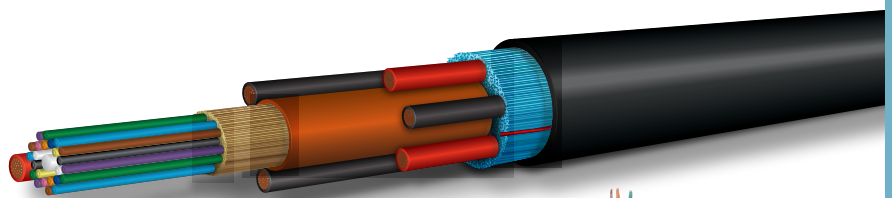
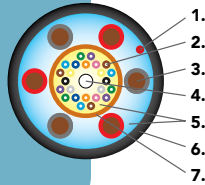

### Applications

- Used for power and control circuits that require both power conductors and fiber optic communication links
- Hybrid fiber/copper cables as described in NEC Article 336 Power and Control Tray Cable Type TC
- Type TC-ER cable can transition from a cable tray to the equipment

### Features and Benefits

- Corrugated copper shielding is available
- Type TC-ER cable is also approved for use between the cable tray and equipment when installed to NEC 336.10(7)
- 600V rating for 90°C dry locations
- Cable constructed of copper conductors, fiber optical components, flame retardant fillers and tape wrap
- Bare grounding conductor for TC-ER cables
- Individual conductors are Type THHN and can be AWG 10 to AWG 4
- Sunlight resistant jacket for continuous sunlight exposure performance
- UL 1685 Vertical Flame Test performance (70,000 BTU/hr)
- The fiber optic components can vary from individual to multifiber subunits as determined by the construction, which includes the number of fibers, number of conductors and the conductor size
- For fiber type options see the Section 3.1 – Fiber Product Information
- Many fiber count options available
- Incorporating fiber optic elements into the power cable provides protection for the optical fibers and reduced costs by installing one cable in the place of several individual cables

### Cable Characteristics

- Due to the wide variety of cable constructions, including conductor counts, conductor sizes, fiber types and fiber counts; individual cable characters are available upon request

### Ordering Information

- Due to the custom nature of this cable, contact OCC Sales for ordering information

Consistent with the definition in TIA-440-B "Fiber Optic Terminology," hybrid cable is defined as a cable containing both optical fibers and electrical conductors. Composite cable is defined as a cable containing mixed fiber types. Prior to 2012 some U.S. standards documents use definitions for hybrid and composite which are opposite of those stated here. The change in convention was made in the interest of harmonization with International standards and other National standards.

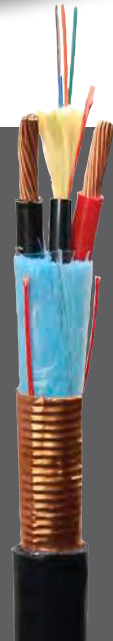

### Applicable Standards

OCC indoor/outdoor tight-buffered fiber optic cables meet or exceed the functional requirements of the following standards:

- UL 1277
- UL 1685 Vertical Flame Test
- UL 83 – THHN conductors
- NEC – NFPA 70 Section 336



## (4.5a) D-Series Distribution – Outside Plant Cables

1. Central Filler/  
Strength Member
2. Tight-Buffer Optical Fiber
3. Aramid Strength Member
4. Outer Jacket
5. Ripcord

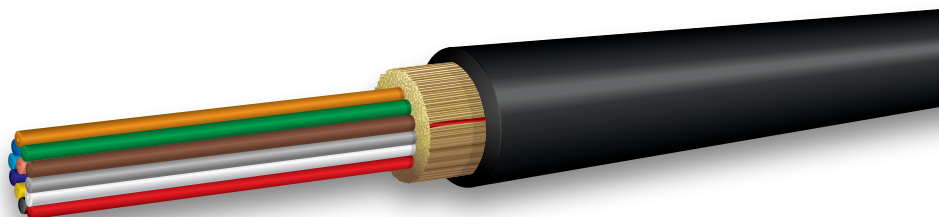
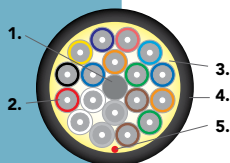

### Applications

- Outdoor distribution cable for duct or aerial lash installations along utility poles for cable television, telecom or other outside plant campus backbone applications

### Features

- Tight-buffered construction for easy, direct connector termination or splicing
- Polyethylene outer cable jacket for excellent UV and weather resistance
- High-performance tight-buffer on the optical fibers for excellent environmental and mechanical protection
- Wide operating temperature of -40°C to +85°C
- 900µm buffer eliminates the need for costly and time-consuming installation of fanout kits or pigtail splices, because connectors terminate directly to the fiber
- All-dielectric design does not require grounding or bonding



### Mechanical and Environmental Performance

	OUTDOOR
Operating temperature	-40°C to +85°C
Storage temperature	-55°C to +85°C
Installation temperature (cable temp.)	-30°C to +60°C
Crush resistance (TIA-455-41)	1,500 N/cm
Flex resistance (TIA-455-104)	1,000 cycles

### Applicable Standards

OCC outside plant tight-buffered fiber optic cables meet or exceed the functional requirements of the following standards:

- ICEA S-87-640
- TIA-568
- TIA-598

## (4.5a) D-Series Distribution – Outside Plant Cables

### Cable Characteristics: D-Series Outside Plant Cables

FIBER COUNT	DIAMETER MM (IN)	WEIGHT KG/KM (LBS/1,000')	TENSILE LOAD		MINIMUM BEND RADIUS	
			INSTALLATION N (LBS)	OPERATIONAL N (LBS)	INSTALLATION CM (IN)	LONG-TERM CM (IN)
2	6.3 (0.25)	29 (20)	2,670 (600)	890 (200)	12.6 (5.0)	6.3 (2.5)
4	6.3 (0.25)	29 (20)	2,670 (600)	890 (200)	12.6 (5.0)	6.3 (2.5)
6	6.3 (0.25)	29 (20)	2,670 (600)	890 (200)	12.6 (5.0)	6.3 (2.5)
8	6.9 (0.27)	39 (26)	2,800 (630)	900 (202)	13.8 (5.4)	6.9 (2.7)
12	7.9 (0.31)	53 (36)	2,800 (630)	900 (202)	15.8 (6.2)	7.9 (3.1)
18	7.9 (0.31)	57 (38)	2,800 (630)	900 (202)	15.8 (6.2)	7.9 (3.1)
24	9.5 (0.37)	77 (52)	3,000 (670)	1,000 (220)	19.0 (7.5)	9.5 (3.7)
30	9.7 (0.38)	72 (48)	3,000 (670)	1,000 (220)	19.4 (7.6)	9.7 (3.8)
36	9.7 (0.38)	71 (48)	3,000 (670)	1,000 (220)	19.4 (7.6)	9.7 (3.8)
48	10.8 (0.43)	91 (61)	4,200 (942)	1,400 (313)	21.5 (8.5)	10.8 (4.3)

Installation loads in excess of 2,700 N (600 lbs.) are not recommended.  
 Ideal for harsh chemical environments including petrochemical.  
 Other fiber counts available upon request.

### Ordering Information

	D	X				A				9	K	A
Digit No:	1	2	3	4	5	6	7	8	9	10	11	12
	1 – 2	Aerial Distribution Series Ultra-Fox= <b>DX</b>										
	3 – 5	Fiber count: (see cable characteristics chart) = <b>002–048</b>										
	6	Jacket type: Polyethylene = <b>A</b>										
	7 – 9	Fiber type: (see Laser Ultra-Fox Fiber Performance Table, pg. 116)										
	10	Ultra-Fox fiber with 900µm tight-buffer = <b>9</b>										
	11	Jacket color: Black = <b>K</b>										
	12	Rating: None/outdoor = <b>A</b>										

**Example:** 12-fiber cable using OM3 laser optimized bend-insensitive fiber, black jacket

D	X	0	1	2	A	A	L	T	9	K	A
---	---	---	---	---	---	---	---	---	---	---	---

## (4.5b) D-Series Distribution – Corrugated Steel Tape (CST) Armored Cables

1. Central Filler/Strength Member
2. Tight-Buffer Optical Fiber
3. Aramid Strength Member
4. Inner Jacket
5. Corrugated Steel Tape Armor
6. Outer Jacket
7. Ripcords

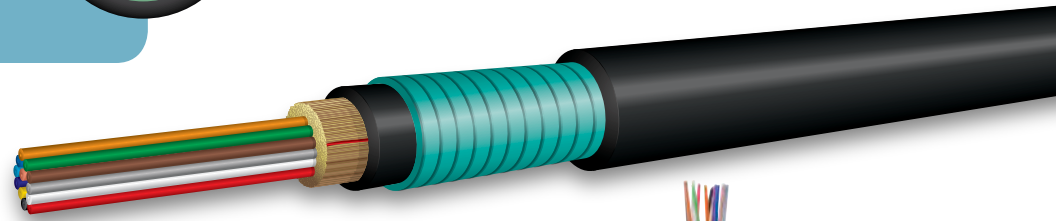
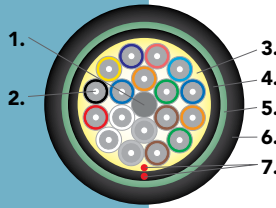

### Applications

- Ideal for installation where direct burial or rodent protection is required

### Features

- The steel-armor is easily removed with an internal ripcord, leaving a fully functional, intact riser-rated inner cable, with original cable markings for identification
- Armored jacket is an add-on option that can be applied to most outdoor and indoor/outdoor riser-rated cables
- Inner tight-buffered cable is suitable for direct field termination with standard optical connectors



### Mechanical and Environmental Performance

	OUTDOOR
Operating temperature	-40°C to +85°C
Storage temperature	-55°C to +85°C
Installation temperature (cable temp.)	-10°C to +60°C
Crush resistance (TIA-455-41)	440 N/cm
Flex resistance (TIA-455-104)	25 cycles

### Applicable Standards

OCC CST armored tight-buffered fiber optic cables meet or exceed the functional requirements of the following standards:

- TIA-568
- TIA-598
- ICEA S-104-696

## (4.5b) D-Series Distribution – Corrugated Steel Tape (CST) Armored Cables

### Cable Characteristics: CST Armored Cables (Using Distribution Series Riser Inner-Cable)

FIBER COUNT	DIAMETER MM (IN)	WEIGHT KG/KM (LBS/1,000')	TENSILE LOAD		MINIMUM BEND RADIUS	
			INSTALLATION N (LBS)	OPERATIONAL N (LBS)	INSTALLATION CM (IN)	LONG-TERM CM (IN)
2	11.4 (0.45)	118 (79)	1,400 (310)	450 (100)	17.1 (6.7)	11.4 (4.5)
4	11.4 (0.45)	118 (79)	1,400 (310)	450 (100)	17.1 (6.7)	11.4 (4.5)
6	11.4 (0.45)	118 (79)	1,400 (310)	450 (100)	17.1 (6.7)	11.4 (4.5)
8	11.4 (0.45)	121 (81)	1,600 (360)	525 (120)	17.1 (6.7)	11.4 (4.5)
10	12.3 (0.48)	138 (93)	1,800 (400)	600 (135)	18.5 (7.3)	12.3 (4.8)
12	13.4 (0.53)	160 (108)	2,700 (600)	900 (200)	20.1 (7.9)	13.4 (5.3)
18	13.4 (0.53)	160 (108)	2,700 (600)	900 (200)	20.1 (7.9)	13.4 (5.3)
24	14.9 (0.59)	190 (128)	3,000 (670)	1,000 (220)	22.4 (8.8)	14.9 (5.9)
30	15.5 (0.61)	207 (139)	3,000 (670)	1,000 (220)	23.3 (9.2)	15.5 (6.1)
36	15.5 (0.61)	205 (138)	3,000 (670)	1,000 (220)	23.3 (9.2)	15.5 (6.1)
48	16.5 (0.65)	233 (157)	4,200 (940)	1,400 (310)	24.8 (9.8)	16.5 (6.5)
60	18.9 (0.77)	292 (196)	4,800 (1,080)	1,600 (360)	28.4 (11.2)	18.9 (7.4)
72	20.9 (0.82)	358 (241)	5,400 (1,210)	1,800 (400)	31.4 (12.4)	20.9 (8.2)
84	21.4 (0.84)	382 (257)	6,000 (1,350)	2,000 (450)	32.1 (12.6)	21.4 (8.4)
96	22.4 (0.88)	410 (276)	6,000 (1,350)	2,000 (450)	33.6 (13.2)	22.4 (8.8)
108	23.5 (0.93)	453 (304)	6,000 (1,350)	2,000 (450)	35.3 (13.9)	23.5 (9.3)
120	24.5 (0.96)	484 (325)	6,000 (1,350)	2,000 (450)	36.8 (14.5)	24.5 (9.6)
132	25.0 (0.98)	502 (337)	6,000 (1,350)	2,000 (450)	37.5 (14.8)	25.0 (9.8)
144	26.3 (1.04)	556 (374)	6,000 (1,350)	2,000 (450)	39.5 (15.6)	26.3 (10.4)

Mechanical specifications vary by fiber type.  
Installation loads in excess of 2,700 N (600 lbs.) are not recommended.  
Other fiber counts available upon request.

**See application engineering note:**  
Interlocking Armor Cable Pulling Grip Installation Procedure available online at [www.occfiber.com](http://www.occfiber.com).

### Ordering Information

**D X     D     9 K A A 2**

Digit No: **1 2 3 4 5 6 7 8 9 10 11 12 13 14**

- 1 – 2     Distribution Series Laser Ultra-Fox = **DX**
- 3 – 5     Fiber count: (see cable characteristics chart) = **002–144**
- 6         Jacket type: Indoor/Outdoor PVC = **D**
- 7 – 9     Fiber type: (see Laser Ultra-Fox Fiber Performance Table, pg. 116)
- 10        Ultra-Fox fiber with 900µm tight-buffer = **9**
- 11        Jacket color: Black = **K**
- 12        Rating: None/outdoor = **A**
- 13 – 14   Corrugated Steel Tape Armor with Polyethylene Jacket = **A2**

**Example:** 144-fiber CST armored distribution cable using OM3 laser optimized bend-insensitive fiber, black jacket

**D X 1 4 4 D S L X 9 K A A 2**



### (4.5c) B-Series Breakout – Corrugated Steel Tape (CST) Armored Cables

1. Central Filler/Strength Member
2. Subcable
3. Corrugated Steel Tape Armor
4. Outer Jacket
5. Ripcord

#### Subcable

6. Tight-Buffer Optical Fiber
7. Aramid Strength Member
8. Subcable Jacket

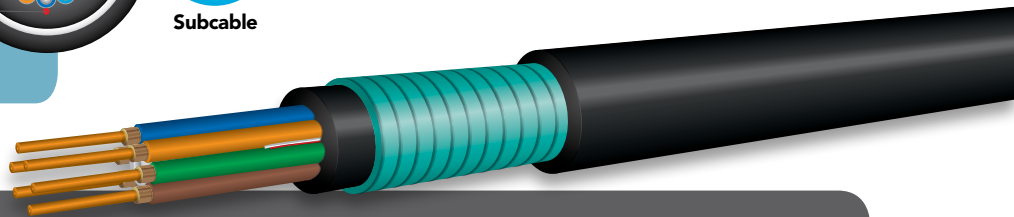
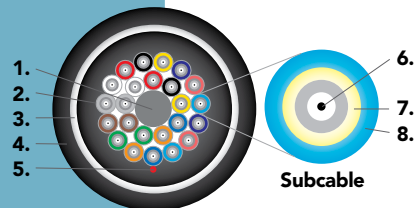

### Applications:

- Ideal for installations where direct burial or rodent protection is required
- Ideal for installations requiring an extremely rugged and reliable cable design where maximum mechanical and environmental protection are necessary
- Easiest cable to install where direct termination of connectors to subunits and direct run to panels and equipment is desired

### Features:

- Inner cable is a fully functional B-Series Breakout riser-rated cable
- High-performance components and construction
- Most rugged and easy to install cable design for enterprise cabling applications
- 2.5mm subcables and 2.0mm subcables can be direct-terminated with standard connectors (2.9mm subcables also available)
- The steel-armor is easily removed with an internal ripcord, leaving a fully functional intact riser-rated inner cable with original cable marking for identification
- Polyethylene (A) outer jacket for excellent UV and weathering resistance
- Subcabled fiber is environmentally and mechanically protected
- Ideal for use in point-to-point runs in adverse environments
- Direct termination to subcable provides additional strain-relief for better connector retention during moves, adds, and changes
- Cable materials are indoor/outdoor – UV, water and fungus resistant
- Wide operating temperature range of -40°C to +85°C
- High-performance 900µm tight-buffered coating on each optical fiber for environmental and mechanical protection
- 2 to 36 fibers



### Mechanical and Environmental Performance

	OUTDOOR
Operating temperature	-40°C to +85°C
Storage temperature	-55°C to +85°C
Installation temperature (cable temp.)	-10°C to +60°C
Crush resistance (TIA-455-41)	440 N/cm
Flex resistance (TIA-455-104)	25 cycles

## (4.5c) B-Series Breakout – Corrugated Steel Tape (CST) Armored Cables

### Cable Characteristics: B-Series Breakout CST Armored Cables (with 2.0mm subcables)

FIBER COUNT	DIAMETER MM (IN)	WEIGHT KG/KM (LBS/1,000')	TENSILE LOAD		MINIMUM BEND RADIUS	
			INSTALLATION N (LBS)	OPERATIONAL N (LBS)	INSTALLATION CM (IN)	LONG-TERM CM (IN)
2	12.9 (0.51)	152 (102)	1,600 (360)	400 (90)	19.4 (7.6)	12.9 (5.1)
4	12.9 (0.51)	152 (102)	1,600 (360)	400 (90)	19.4 (7.6)	12.9 (5.1)
6	14.4 (0.57)	182 (122)	2,400 (540)	600 (130)	21.6 (8.5)	14.4 (5.7)
8	15.5 (0.61)	211 (142)	3,200 (720)	800 (180)	23.3 (9.2)	15.5 (6.1)
12	17.5 (0.69)	249 (167)	4,800 (1080)	1,200 (270)	26.3 (10.4)	17.5 (6.9)
18	18.9 (0.74)	301 (202)	6,000 (1350)	1,500 (340)	28.4 (11.2)	18.9 (7.4)
24	21.4 (0.84)	391 (263)	7,200 (1600)	1,800 (400)	32.1 (12.6)	21.4 (8.4)
36	23.5 (0.93)	455 (306)	9,600 (2100)	2,400 (540)	35.3 (13.9)	23.5 (9.3)

### B-Series Breakout CST Armored Cables (with 2.5mm subcables)

FIBER COUNT	DIAMETER MM (IN)	WEIGHT KG/KM (LBS/1,000')	TENSILE LOAD		MINIMUM BEND RADIUS	
			INSTALLATION N (LBS)	OPERATIONAL N (LBS)	INSTALLATION CM (IN)	LONG-TERM CM (IN)
2	14.4 (0.57)	183 (123)	1,200 (270)	500 (110)	21.6 (8.5)	14.4 (5.7)
4	14.4 (0.57)	183 (123)	2,000 (450)	800 (180)	21.6 (8.5)	14.4 (5.7)
6	16.0 (0.63)	211 (142)	3,000 (670)	1,200 (270)	24.0 (9.4)	16.0 (6.3)
8	18.4 (0.72)	275 (185)	4,000 (900)	1,700 (380)	27.6 (10.9)	18.4 (7.2)
12	20.9 (0.82)	330 (222)	6,000 (1,350)	2,500 (560)	31.4 (12.4)	20.9 (8.2)
18	21.9 (0.86)	386 (259)	8,000 (1,800)	3,500 (790)	32.9 (13.0)	21.9 (8.6)
24	24.5 (0.96)	478 (321)	10,000 (2,250)	3,800 (850)	36.8 (14.5)	24.5 (9.6)
36	28.3 (1.11)	607 (408)	14,000 (3,150)	6,000 (1350)	42.5 (16.7)	28.3 (11.1)

### Ordering Information

**B** **D** **9** **K** **A** **A** **2**

Digit No: **1** **2** **3** **4** **5** **6** **7** **8** **9** **10** **11** **12** **13** **14**

- 1 – 2 Breakout Series Ultra-Fox  
2.0mm Subcables = **BE**  
2.5mm Subcables = **BX**
- 3 – 5 Fiber count: (see cable characteristics chart) = **002–036**
- 6 Jacket type: Indoor/Outdoor PVC = **D**
- 7 – 9 Fiber type: (see Laser Ultra-Fox Fiber Performance Table, pg. 116)
- 10 Ultra-Fox fiber with 900µm tight-buffer = **9**
- 11 Jacket color: Black = **K**
- 12 Rating: Unrated = **A**
- 13 – 14 Corrugated Steel Tape Armor Indoor/Outdoor Polyethylene jacket = **A2**

**Example:** 12-fiber B-series breakout corrugated steel tape armored cable with 2.5mm subcables using 62.5µm Laser Ultra-Fox fiber, black jacket

**B** **X** **0** **1** **2** **D** **W** **L** **S** **9** **K** **A** **A** **2**





### (4.5d) G-Series Subgrouping – Corrugated Steel Tape (CST) Armored Cable

1. Central Filler/Strength Member
  2. Subcable
  3. Corrugated Steel Tape Armor
  4. Outer Jacket
  5. Ripcord
- Subcable**
6. Tight-Buffer Optical Fiber
  7. Aramid Strength Member
  8. Color-Coded Subcable Cable Jacket
  9. Ripcord

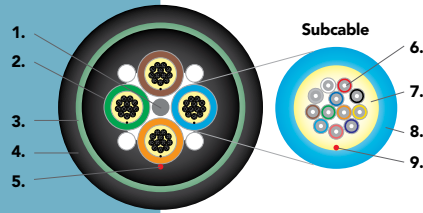

### Applications:

- Ideal for installations where direct burial or rodent protection is required
- Design allows subcables to be routed to multiple locations such as wiring racks and closets
- Ideal for installations requiring an extremely rugged and reliable cable design where maximum mechanical and environmental protection are necessary
- Easiest cable to install where routing of cables to multiple locations is desired

### Features:

- Inner cable is a fully functional G-Series Subgrouping riser-rated cable
- High-performance components and construction
- 6-fiber or 12-fiber subgroups are available
- The steel-armor is easily removed with an internal ripcord, leaving a fully functional intact riser-rated inner cable with original cable marking for identification
- Helically stranded core for greater flexibility and mechanical protection of the optical fibers
- Multifiber color-coded subcables, each similar to the D-Series Distribution cable, are easy to identify for improved cable management during installation
- Subgrouping cable design permits mid-span access
- Polyethylene (A) outer jacket for excellent UV and weathering resistance
- Ideal for use in point-to-point runs in adverse environments
- Wide operating temperature range of -40°C to +85°C
- High-performance 900µm tight-buffered coating on each optical fiber for environmental and mechanical protection
- Best design for multimode and single-mode fiber composite cables
- Available with 6-fiber (4.5mm) or 12-fiber (5.5mm) subgroups
- 12 to 72 fibers

### Mechanical and Environmental Performance

	OUTDOOR
Operating temperature	-40°C to +85°C
Storage temperature	-55°C to +85°C
Installation temperature (cable temp.)	-10°C to +60°C
Crush resistance (TIA-455-41)	440 N/cm
Flex resistance (TIA-455-104)	25 cycles

Consistent with the definition in TIA-440-B "Fiber Optic Terminology," hybrid cable is defined as a cable containing both optical fibers and electrical conductors. Composite cable is defined as a cable containing mixed fiber types. Prior to 2012 some U.S. standards documents use definitions for hybrid and composite which are opposite of those stated here. The change in convention was made in the interest of harmonization with International standards and other National standards.

## (4.5d) G-Series Subgrouping – Corrugated Steel Tape (CST) Armored Cable

### Cable Characteristics: G-Series CST Armored Cables (with 6-fiber subcables)

FIBER COUNT	DIAMETER MM (IN)	WEIGHT KG/KM (LBS/1,000')	TENSILE LOAD		MINIMUM BEND RADIUS	
			INSTALLATION N (LBS)	OPERATIONAL N (LBS)	INSTALLATION CM (IN)	LONG-TERM CM (IN)
12	21.4 (0.84)	392 (263)	2,700 (600)	600 (135)	32.1 (12.6)	21.4 (8.4)
18	21.4 (0.84)	392 (263)	2,700 (600)	600 (135)	32.1 (12.6)	21.4 (8.4)
24	21.4 (0.84)	392 (263)	2,700 (600)	600 (135)	32.1 (12.6)	21.4 (8.4)
30	22.4 (0.88)	427 (287)	2,700 (600)	600 (135)	33.6 (13.2)	22.4 (8.8)
36	24.0 (0.94)	486 (327)	2,700 (600)	600 (135)	35.3 (13.9)	23.5 (9.3)

### G-Series CST Armored Cables (with 12-fiber subcables)

FIBER COUNT	DIAMETER MM (IN)	WEIGHT KG/KM (LBS/1,000')	TENSILE LOAD		MINIMUM BEND RADIUS	
			INSTALLATION N (LBS)	OPERATIONAL N (LBS)	INSTALLATION CM (IN)	LONG-TERM CM (IN)
24	23.5 (0.93)	460 (309)	2,700 (600)	600 (135)	35.3 (13.9)	23.5 (9.3)
36	23.5 (0.93)	460 (309)	2,700 (600)	600 (135)	35.3 (13.9)	23.5 (9.3)
48	23.5 (0.93)	460 (309)	2,700 (600)	600 (135)	35.3 (13.9)	23.5 (9.3)
60	25.5 (1.0)	528 (355)	2,700 (600)	600 (135)	38.3 (15.1)	25.5 (10.0)
72	27.3 (1.07)	601 (404)	2,700 (600)	600 (135)	41 (16.1)	27.3 (10.7)

### Ordering Information

**G** **D** **9** **K** **A** **A** **2**

Digit No: 1 2 3 4 5 6 7 8 9 10 11 12 13 14

- 1 Subgrouping Series Ultra-Fox = **G**
- 2 6-fiber subcables = **B**; 12-fiber subcables = **G**
- 3 – 5 Fiber count: 6-fiber subcables = **012–036**, 12-fiber subcables = **024–072**
- 6 Inner jacket material = **D**
- 7 – 9 Fiber type: (see Laser Ultra-Fox Fiber Performance Table, pg. 116)
- 10 Laser Ultra-Fox fiber with 900µm tight-buffer = **9**
- 11 Jacket color: Black = **K**
- 12 Rating: Unrated = **A**
- 13-14 Corrugated Steel Tape Armor Indoor/Outdoor Polyethylene jacket = **A2**

**Example:** 36-fiber G-series subgrouping corrugated steel tape armored using single-mode bend-insensitive low water peak, Ultra-Fox fiber, 12-fiber subcables, black jacket

**G** **X** **0** **3** **6** **D** **S** **L** **A** **9** **K** **A** **A** **2**

## (4.5e) HC-Series – High-Density Outdoor Rated Cables

1. Central Filler/Strength Member
  2. Tight-Buffer Fiber Unit
  3. Aramid Strength Member
  4. Outer Jacket
  5. Ripcord
- Tight-Buffer Fiber Unit**
6. 250µm Acrylate Fiber
  7. Fiber Unit
  8. Tight-Buffer Fiber Unit

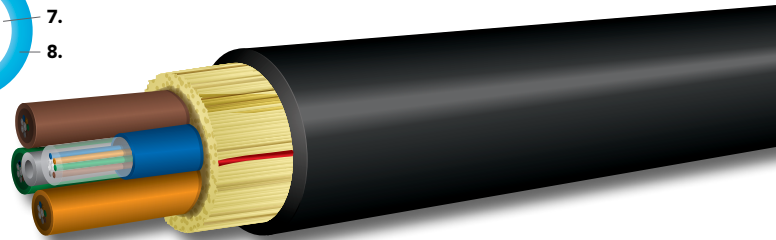
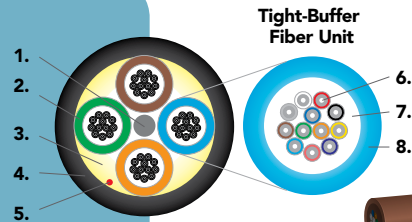

### Applications

- Outdoor tight-buffer fiber unit cable for duct or aerial lash installations

### Features

- Rugged tight-buffer fiber unit construction
- Cable materials are outdoor: UV, fungus and water resistant
- The high-density breakout cables offer a >20% reduction in diameter and a >20% reduction in weight relative to conventional loose-tube cables, allowing for greater fiber density and cable packing within a duct
- Core-Locked™ outer jacket design for installation survivability
- Helically stranded core for greater flexibility and mechanical protection of the optical fiber units
- Corrugated steel tape (CST) option available
- Cable can be terminated with 900µm fanout kit for LC connectorization
- Suitable for direct pulling with wire mesh grips



### Applicable Standards

OCC indoor/outdoor tight-buffered fiber optic cables meet or exceed the functional requirements of the following standards:

- ICEA-S-87-640
- TIA-568
- TIA-598

### Mechanical and Environmental Performance

	INDOOR/OUTDOOR
Operating temperature	-40°C to +85°C
Storage temperature	-55°C to +85°C
Installation temperature (cable temp.)	-30°C to +60°C
Crush resistance (TIA-455-41)	1,800 N/cm
Flex resistance (TIA-455-104)	2,000 cycles

## (4.5e) HC-Series – High-Density Outdoor Rated Cables

### Cable Characteristics: HC-Series High-Density Outdoor Cables (with 2.0mm fiber units)

FIBER COUNT	DIAMETER MM (IN)	WEIGHT KG/KM (LBS/1,000')	TENSILE LOAD		MINIMUM BEND RADIUS	
			INSTALLATION N (LBS)	OPERATIONAL N (LBS)	INSTALLATION CM (IN)	LONG-TERM CM (IN)
24	7.6 (0.30)	75 (50)	2,700 (600)	600 (135)	11.4 (4.5)	7.6 (3.0)
48	7.6 (0.30)	75 (50)	2,700 (600)	600 (135)	11.4 (4.5)	7.6 (3.0)
72	9.0 (0.35)	97 (65)	2,700 (600)	600 (135)	13.5 (5.3)	9.0 (3.5)
96	10.3 (0.41)	116 (78)	2,700 (600)	600 (135)	15.5 (6.1)	10.3 (4.1)
120	11.7 (0.46)	141 (95)	2,700 (600)	600 (135)	17.6 (6.9)	11.7 (4.6)
144	11.7 (0.46)	152 (102)	2,700 (600)	600 (135)	17.6 (6.9)	11.7 (4.6)
168	11.7 (0.46)	152 (102)	2,700 (600)	600 (135)	17.6 (6.9)	11.7 (4.6)
192	12.9 (0.51)	179 (120)	2,700 (600)	600 (135)	19.4 (7.6)	12.9 (5.1)
216	12.9 (0.51)	179 (120)	2,700 (600)	600 (135)	19.4 (7.6)	12.9 (5.1)
288	15.0 (0.59)	226 (152)	2,700 (600)	600 (135)	22.8 (9.0)	15.0 (5.9)

\*\*Installation loads in excess of 2,700 N (600 lbs.) are not recommended.

### Ordering Information

	<b>H</b>	<b>C</b>				<b>A</b>						<b>A</b>
<b>Digit No:</b>	1	2	3	4	5	6	7	8	9	10	11	12

- 1 – 2 High Count Series with 12-fiber bundled fiber units 2.0mm in diameter = **HC**
- 3 – 5 Fiber count: (see cable characteristics chart)
- 6 Jacket type: Polyethylene = **A**
- 7 – 9 Fiber type: **SLA, ALT, ALE, WLS**
- 10 Jacketed fiber unit: **A** = Direct MTP termination, **C** = No direct MTP termination,
- 11 Standard jacket color: Black = **K**
- 12 Rating: None/Outdoor = **A**

**Example:** 24-fiber cable with 12-fiber units, 2.0mm in diameter using bend-insensitive single-mode fiber, outdoor Polyethylene, black jacket outdoor rated, printed in feet

<b>H</b>	<b>C</b>	<b>0</b>	<b>2</b>	<b>4</b>	<b>A</b>	<b>S</b>	<b>L</b>	<b>A</b>	<b>C</b>	<b>K</b>	<b>A</b>
----------	----------	----------	----------	----------	----------	----------	----------	----------	----------	----------	----------



## (4.5f) MX-Series – Figure-8 Messenger Cables (Steel/E-Glass)

1. Messenger
2. Central Filler
3. Tight-Buffer Optical Fiber
4. Aramid Strength Member
5. Outer Jacket
6. Ripcord

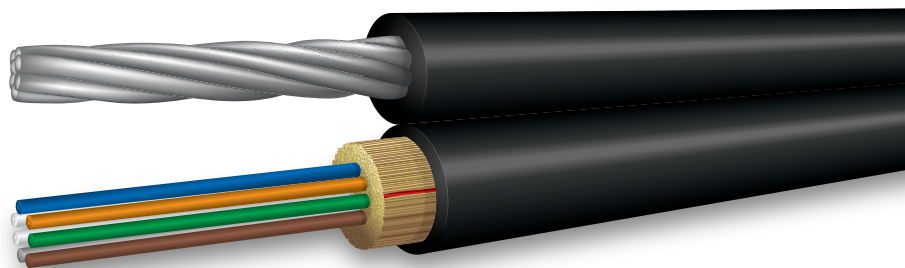
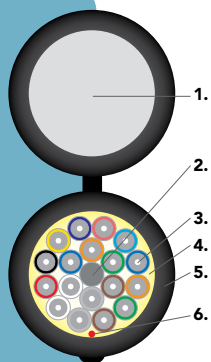

## Applications

- Outdoor aerial installations along utility poles for cable television, telecom or other outside plant campus backbone applications without the need for cable lashing

## Features

- Figure-eight construction for use with standard messenger clamping and support hardware
- Ideal for new installations; the figure-eight messenger cable reduces installation time and cost by approximately 50% compared to separate installation of a messenger wire and the lashing of the cable to the messenger
- Wide operating temperature range of -40°C to +85°C
- 1/4-inch galvanized messenger standard
- Polyethylene outer cable jacket for excellent UV and weather resistance
- Designed to the NESC requirements for light, medium and heavy storm loads (see cable characteristics table for maximum span lengths)

\*All-dielectric messenger available upon request.

## Mechanical and Environmental Performance

	OUTDOOR
Operating temperature	-40°C to +85°C
Storage temperature	-55°C to +85°C
Installation temperature (cable temp.)	-30°C to +60°C
Crush resistance	1,800 N/cm

## Applicable Standards

OCC figure-eight tight-buffered fiber optic cables meet or exceed the functional requirements of the following standards:

- TIA-568
- TIA-598
- ICEA S-87-640

## (4.5f) MX-Series – Figure-8 Messenger Cables (Steel/E-Glass)

### Storm Load Map

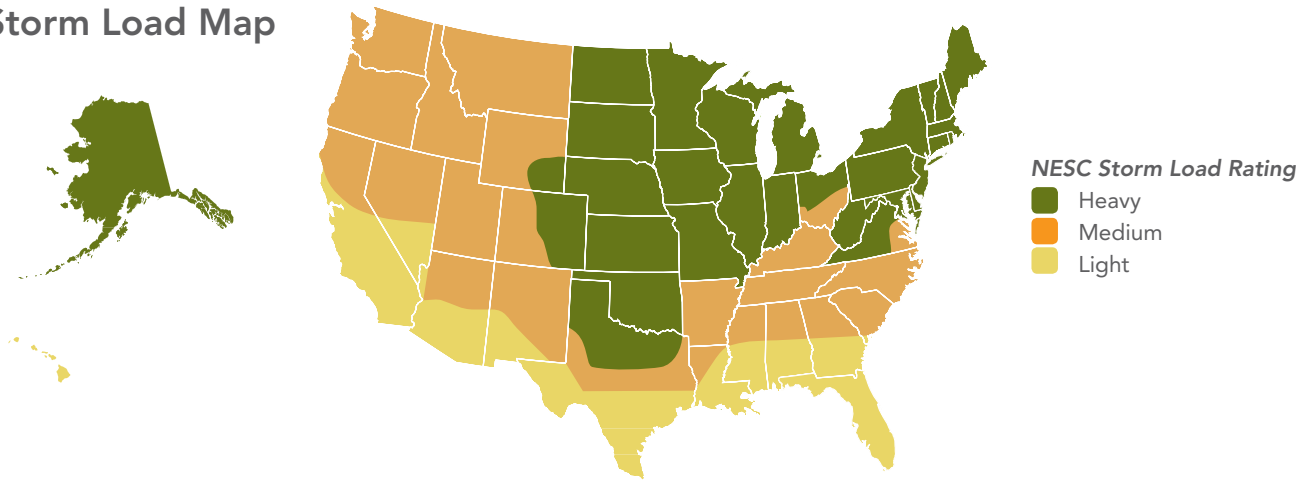

### Cable Characteristics: MX-Series Figure-8 Cable with 1/4-inch Steel Messenger

FIBER COUNT	WEIGHT KG/KM (LBS/1,000')	NESC SPAN LENGTH (M) † SEE STORM LOAD MAP (HEAVY/MEDIUM/LIGHT)
2	261 (175)	115/190/250
4	261 (175)	115/190/250
6	261 (175)	115/190/250
8	261 (175)	115/190/250
12	261 (175)	115/190/250
18	264 (177)	115/190/250
24	273 (183)	110/180/230
36	290 (195)	105/180/220
48	307 (206)	95/175/220

† Span lengths based on 1% installation sag. Other size messengers available. Contact OCC for specifications.

### Ordering Information

	<b>M</b>	<b>X</b>				<b>A</b>				<b>9</b>	<b>K</b>	<b>A</b>	<b>G</b>	<b>3</b>
Digit No:	1	2	3	4	5	6	7	8	9	10	11	12	13	14

- 1 – 2 Messenger Series Ultra-Fox = **MX**
- 3 – 5 Fiber count: (see cable characteristics chart) = **002–048**
- 6 Jacket type: Polyethylene = **A**
- 7 – 9 Fiber type: (see Laser Ultra-Fox Fiber Performance Table, pg. 116)
- 10 Ultra-Fox fiber with 900µm tight-buffer = **9**
- 11 Jacket color: Black = **K**
- 12 Rating: None/Outdoor = **A**
- 13 – 14 Messenger Code: 1/4-inch Galvanized Steel = **G3**

**Example:** 12-fiber messenger cable using OM3 laser optimized bend-insensitive, 1/4-inch messenger, black jacket

<b>M</b>	<b>X</b>	<b>0</b>	<b>1</b>	<b>2</b>	<b>A</b>	<b>S</b>	<b>L</b>	<b>X</b>	<b>9</b>	<b>K</b>	<b>A</b>	<b>G</b>	<b>3</b>
----------	----------	----------	----------	----------	----------	----------	----------	----------	----------	----------	----------	----------	----------



## (4.5g) RM-Series – Round Messenger Cables

1. Central Filler/Strength Member
2. Tight-Buffer Optical Fiber
3. Aramid Strength Member
4. Outer Jacket
5. Ripcord

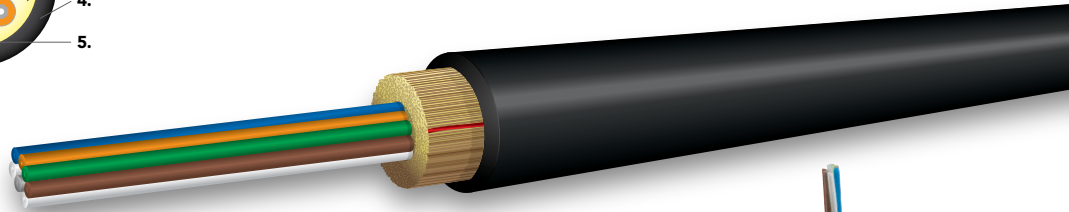
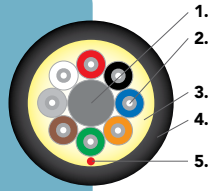

### Applications

- Outdoor aerial installations along utility poles for cable television, telecom or other outside plant campus backbone applications without the need for cable lashing or grounding

### Features

- Lightweight, all-dielectric self-supporting (ADSS) construction is ideal for use near electrical power lines and in areas of frequent lightning
- No messenger or lashing is required
- Round cable construction for minimum wind drag and ice buildup
- Aramid strength members reduce weight for longer span lengths
- Wide operating temperature range of -55°C to +85°C
- 900µm tight-buffer eliminates the need for costly and time-consuming installation of fanout kits or pigtail splices, because connectors terminate directly to the fiber
- Standard with Ultra-Fox Plus fiber (500µm)



### Environmental Performance

	OUTDOOR
Operating temperature	-55°C to +85°C
Storage temperature	-70°C to +85°C
Installation temperature (cable temp.)	-30°C to +60°C
Crush resistance (TIA-455-41)	1,800 N/cm
Flex resistance (TIA-455-104)	2,000 cycles

### Applicable Standards

OCC Round Messenger tight-buffered fiber optic cables meet or exceed the functional requirements of the following standards:

- TIA-568
- TIA-598
- ICEA S-87-640
- IEEE 1222

## (4.5g) RM-Series – Round Messenger Cables

### Storm Load Map

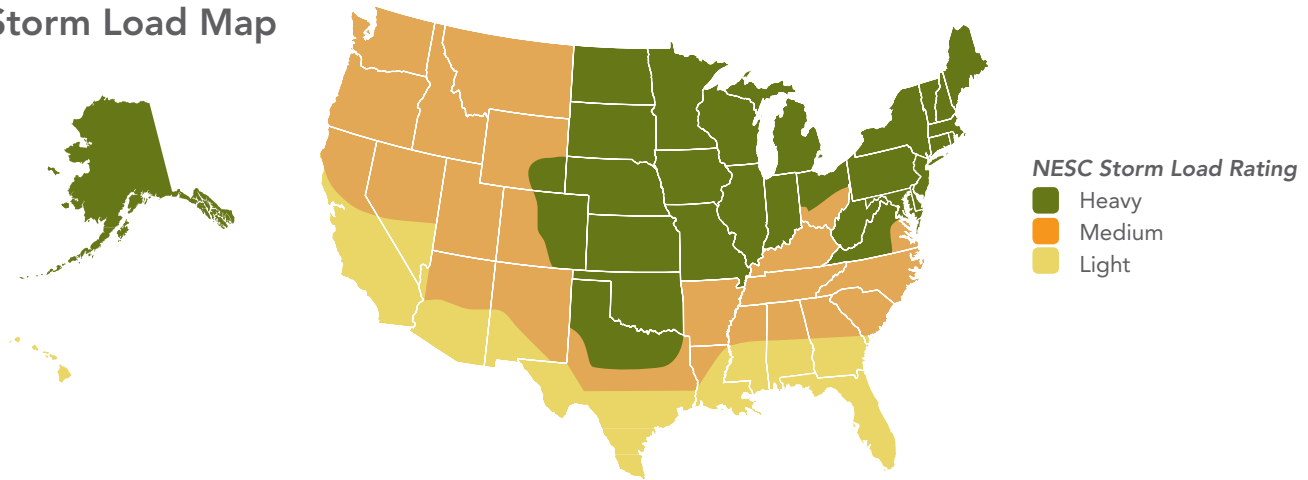

### Cable Characteristics: RM-Series Round Messenger Cables

FIBER COUNT	DIAMETER MM (IN)	WEIGHT KG/KM (LBS/1,000')	MAX RATED CABLE TENSION N (LBS)	MAXIMUM SPAN LENGTH BASED ON 1% INSTALLATION SAG					
				NESC HEAVY		NESC MEDIUM		NESC LIGHT	
				METERS	FEET	METERS	FEET	METERS	FEET
2	8.9 (0.35)	57 (38)	12,800 (2,880)	68	224	125	409	223	730
4	8.9 (0.35)	57 (38)	12,800 (2,880)	68	224	125	409	223	730
6	8.6 (0.34)	55 (37)	12,800 (2,880)	69	226	126	414	229	751
8	9.5 (0.37)	68 (46)	12,800 (2,880)	67	219	121	398	210	689
12	9.8 (0.38)	70 (47)	12,800 (2,880)	66	217	120	394	205	671
18	9.8 (0.38)	70 (47)	12,800 (2,880)	66	217	120	394	205	671
24	10.4 (0.41)	83 (56)	12,800 (2,880)	65	213	117	383	194	636
36	10.8 (0.42)	91 (61)	12,800 (2,880)	64	210	115	376	187	614
48	12.2 (0.48)	118 (79)	12,800 (2,880)	61	200	108	355	168	550

\*Please contact Optical Cable Corporation with span lengths, storm load rating and sag requirements.

### Ordering Information

	<b>R</b>	<b>M</b>				<b>X</b>				<b>5</b>	<b>K</b>	
<b>Digit No:</b>	1	2	3	4	5	6	7	8	9	10	11	
	1 – 2	Round Messenger Series Ultra-Fox Plus = <b>RM</b>										
	3 – 5	Fiber count: (see cable characteristics chart) = <b>002–048</b>										
	6	Jacket type: Polyolefin = <b>X</b>										
	7 – 9	Fiber type: (see Ultra-Fox Plus Fiber Performance Table, pg. 117)										
	10	Ultra-Fox Plus fiber with 900µm tight-buffer = <b>5</b>										
	11	Jacket color – Black = <b>K</b>										

**Example:** 12-fiber round messenger cable using OM3 laser optimized bend-insensitive fiber, black jacket

<b>R</b>	<b>M</b>	<b>0</b>	<b>1</b>	<b>2</b>	<b>X</b>	<b>S</b>	<b>L</b>	<b>X</b>	<b>5</b>	<b>K</b>
----------	----------	----------	----------	----------	----------	----------	----------	----------	----------	----------

 (4.6a) Laser Ultra-Fox™ Fiber Performance

Fiber Code <sup>7</sup>	Industry Standard Designation	Core/Cladding Diameter (μm)	Numeric Aperture	Wavelength (nm)	Gigabit Ethernet Distance (m)	10-Gigabit Ethernet Distance (m)	Max. Cabled Attenuation (dB/km)	Min. Laser EMB Bandwidth* (MHz-km)	Min. OFL LED Bandwidth** (MHz-km)
WLS	OM1 ISO/IEC 11801	62.5/125	0.275	850/1310	300/600	33/300 <sup>^</sup>	3.5/1.5	220/500	200/500
WLX	OM1+ ISO/IEC 11801	62.5/125	0.275	850/1310	500/1000	33/300 <sup>^</sup>	3.5/1.5	385/500	200/500
ALS	Laser Grade OM2 Bend Insensitive ISO/IEC 11908	50/125	0.20	850/1310	600/600	82/300 <sup>^</sup>	3.5/1.5	510/500	500/500
ALX	Extended Length Laser Grade OM2+ Bend Insensitive ISO/IEC 11801	50/125	0.20	850/1310	750/600	150/300 <sup>^2</sup>	3.0/1.0 <sup>3</sup>	950/500	700/500
ALT	Laser Optimized OM3 Bend Insensitive ISO/IEC 11801	50/125	0.20	850/1310	1000/600	300/300 <sup>^2</sup>	3.0/1.0 <sup>3</sup>	2000/500	1500/500
ALE	Laser Optimized OM4 Bend Insensitive ISO/IEC 11801	50/125	0.20	850/1310	1040/600	550 <sup>1</sup> /300 <sup>^2</sup>	3.0/1.0 <sup>3</sup>	4700/500	3500/500
SLX	Low Water Peak Single-Mode ITU-T G.652.D	9 <sup>6</sup> /125	—	1310/1550	5 km <sup>4</sup>	10 km <sup>5</sup>	0.5/0.5	—	—
SLA	Bend Insensitive Low Water Peak Single-Mode ITU-T G.657.A1 and ITU-T G.652.D	9 <sup>6</sup> /125	—	1310/1550	5 km <sup>4</sup>	10 km <sup>5</sup>	0.5/0.5	—	—
SLB	Bend Insensitive Low Water Peak Single-Mode ITU-T G.657.A2 and ITU-T G.652.D	9 <sup>6</sup> /125	—	1310/1550	5 km <sup>4</sup>	10 km <sup>5</sup>	0.5/0.5	—	—
SLC	Bend Insensitive Low Water Peak Single-Mode ITU-T G.657.B3 and ITU-T G.652.D	9 <sup>6</sup> /125	—	1310/1550	5 km <sup>4</sup>	10 km <sup>5</sup>	0.5/0.5	—	—

\* Minimum Laser Effective Modal Bandwidth (EMB)

\*\* For backward compatibility to LED based systems, overfilled launch (OFL)

<sup>^</sup> 1310 nm CWDM lasers (10GBASE-LX4)

<sup>1</sup> Reach assuming 3.0 dB maximum cabled attenuation at 850 nm and 1.3 dB total connection and splice loss

<sup>2</sup> Supports 220 meter 10GBASE-LRM distance, or 300 meter 10GBASE-LRM distance with 300 meter capable equipment

<sup>3</sup> 3.5/1.5 dB/km maximum attenuation applies for DX-Series cables greater than 36 fibers, and for all DX-Series cables with armor (corrugated steel tape or interlocked armor) or any other secondary outer jacketing

<sup>4</sup> 10 km for 1310 nm 1000BASE-LX10, and 5 km for 1310 nm 1000BASE-LX

<sup>5</sup> 10 km for 1310 nm 10GBASE-LR, and 40 km for 1550 nm 10GBASE-ER

<sup>6</sup> Typical Mode Field Diameter at 1310 nm

<sup>7</sup> Fiber Codes are available for composite cables containing a wide variety of mixed fiber types within the same cable. Call OCC Customer Service for the Fiber Code for your composite cable configuration.

## (4.6b) Ultra-Fox™ Plus Fiber Performance

Fiber Code <sup>5</sup>	Industry Standard Designation	Core/Cladding Diameter (µm)	Numeric Aperture	Wavelength (nm)	Gigabit Ethernet Distance (m)	10-Gigabit Ethernet Distance (m)	Max. Cabled Attenuation (dB/km)	Min. Laser EMB Bandwidth* (MHz-km)	Min. OFL LED Bandwidth** (MHz-km)
WST	OM1 ISO/IEC 11801	62.5/125	0.275	850/1310	275/550	33/300 <sup>^</sup>	3.5/1.5	200/500	200/500
WLS	Laser Grade OM1 ISO/IEC 11801	62.5/125	0.275	850/1310	300/600	33/300 <sup>^</sup>	3.5/1.5	220/500	200/500
AST	OM2 ISO/IEC 11801	50/125	0.20	850/1310	550/550	82/300 <sup>^</sup>	3.5/1.5	500/500	500/500
ALS	Laser Grade OM2 ISO/IEC 11801	50/125	0.20	850/1310	600/600	82/300 <sup>^</sup>	3.5/1.5	510/500	500/500
ALT	Laser Optimized OM3 ISO/IEC 11801	50/125	0.20	850/1310	1000/600	300/300 <sup>^1</sup>	3.5/1.5	2000/500	1500/500
ALE	Laser Optimized OM4 ISO/IEC 11801	50/125	0.20	850/1310	1040/600	550/300 <sup>^</sup>	3.5/1.5	4700/500	3500/500
SLS	Low Water Peak Single-Mode ITU-T G.652.D <sup>6</sup>	9 <sup>2</sup> /125	—	1310/1550	5 km <sup>3</sup>	10 km <sup>4</sup>	0.5/0.5	—	—
SLA	Bend Insensitive Low Water Peak Single-Mode ITU-T G.657.A1 and ITU-T G.652.D	9 <sup>2</sup> /125	—	1310/1550	5 km <sup>3</sup>	10 km <sup>4</sup>	0.5/0.5	—	—

\* Minimum Laser Effective Modal Bandwidth (EMB)

\*\* For backward compatibility to LED-based systems, overfilled launch (OFL)

<sup>^</sup> 1310nm CWDM lasers (10GBASE-LX4)

<sup>1</sup> Supports 220-meter 10GBASE-LRM distance or 300-meter 10 GBASE-LRM distance with 300-meter-capable equipment

<sup>2</sup> Typical Mode Field Diameter at 1310nm = 9 microns

<sup>3</sup> 10km for 1310nm 1000BASE-LX10 and 5km for 1310nm 1000BASE-LX

<sup>4</sup> 10km for 1310 10GBASE-LR and 40km for 1550nm 10GBASE-ER

<sup>5</sup> Fiber Codes are available for composite cables containing a wide variety of mixed fiber types within the same cable. Call OCC Customer Service for the Fiber Code for your composite cable configuration.

<sup>6</sup> For certain specialty applications SLS fiber may be ITU-T G.652.A

## Other Fiber Types Available Upon Request

OCC continues to offer the widest variety of standard off-the-shelf and nonstandard fiber types to meet the customer's special system requirements. If your system design demands a fiber type not included on these two pages, call OCC to see if your needs can be met with one of the many fiber types available. The following fiber types are examples of some of the specialty fibers available from OCC.

Fiber Type	Description	Uses
CST/DBX	100/140 Core/Cladding	Large core fiber used in low data rate industrial applications
FST	200/230 Core/Cladding	Large core fiber used in low data rate industrial applications
Mil-PRF-49291	Single-Mode and Multimode	Military qualified fiber for specific contract QPL
Radiation Hardened	Single-Mode and Multimode	Commercial and Mil grades available
200kpsi Proof Strength	Single-Mode and Multimode	Many fiber types are available with a 200kpsi proof strength for demanding applications
Wide band multimode fiber	Wide band 50µm NextGen Fiber	CWDM ethernet 40–400 gigabit





# FIBER OPTIC CABLE – HARSH ENVIRONMENT

When you build your company on cabling products designed for the military, harsh environment design is part of your DNA. OCC has harnessed this attitude for products for mining, shipping, aerospace, marine, broadcast, energy and many other applications where variations in temperature and conditions associated with everyday use may impede or interrupt the performance of your communications network. With OCC, you'll be deploying the most robust and advanced network infrastructure — ensuring your network is up and running with the most reliable transmission of broadcast HD video and crucial process automation systems for your particular industry.

OCC fiber optic cabling solutions are easy to install, even under the most difficult conditions. OCC also offers a diverse line of connectivity solutions, including connectors and enclosures that hold tight under stress and tension while resisting dust, grime and moisture.

Harsh conditions test your mettle, and that's our specialty. OCC made it happen on the battlefield, and we're ready for any network challenges you may throw at us.



## 5.0 Fiber Optic Cable – Harsh Environment

<b>5.1</b>	<b>OUTDOOR CABLES</b>	
5.1a	A-Series – Deployable Single-Fiber Cables.....	121
5.1b	D-Series Distribution – Arctic Fox and Arctic Fox Plus Cables .....	123
5.1c	B-Series Breakout – Festoon Cables.....	125
5.1d	CX Series – Hybrid Fiber/Copper Deployable Cables .....	126
<b>5.2</b>	<b>MILITARY CABLES</b>	
5.2a	D-Series Distribution – Mil-Tac Cables .....	127
5.2b	D-Series Distribution – Mil-Tac Rodent Deterrent (FRP) Cables.....	130
5.2c	DOD QPL-85045 Qualified Products.....	133
5.2d	Military Tactical Fiber Optic Cables for Extreme Environments .....	135
5.2e	B-Series Breakout – Mil-Tac Cables.....	136
5.2f	B-Series Breakout – Mil-Tac Rodent Deterrent (FRP) Cables.....	139
<b>5.3</b>	<b>BROADCAST DEPLOYABLE CABLES</b>	
5.3a	D-Series Distribution – Field Broadcast Cables .....	142
5.3b	D-Series Distribution – Field Broadcast Rodent Deterrent (FRP) Cables.....	145
5.3c	B-Series Breakout – Field Broadcast Cables.....	148
5.3d	B-Series Breakout – Field Broadcast Rodent Deterrent (FRP) Cables.....	150
5.3e	CX-Series – Deployable Hybrid Copper/Fiber Cables .....	153
5.3f	SMPTE Essential Cables.....	154
5.3g	SMPTE Premium Cables.....	155
5.3h	SMPTE Tactical Cables.....	156
5.3i	SMPTE Flex Cables.....	157
5.3j	SMPTE LSZH Cables.....	158
<b>5.4</b>	<b>MINING CABLES</b>	
5.4a	D-Series Distribution – MSHA-Rated Mining Cables .....	159
5.4b	D-Series Distribution – MSHA-Rated Deployable Cables.....	161
5.4c	B-Series Breakout – MSHA-Rated Mining Cables.....	163
5.4d	B-Series Breakout – MSHA-Rated Deployable Cables.....	165
5.4e	G-Series Subgrouping - MSHA-Rated Mining Cables.....	167
5.4f	G-Series Subgrouping – MSHA-Rated Signal Cables.....	169
<b>5.5</b>	<b>SHIPBOARD CABLES</b>	
5.5a	D-Series Distribution – LSZH ABS-Approved Cables.....	171
5.5b	D-Series Distribution – LSZH Braided-Armor ABS-Approved Cables .....	173
5.5c	DNV-Certified Shipboard Cables .....	175
5.5d	B-Series Breakout – LSZH ABS-Approved Cables.....	177
5.5e	B-Series Breakout – LSZH Braided-Armor ABS-Approved Cables .....	179
5.5f	Pierside Cables.....	181
<b>5.6</b>	<b>INDUSTRIAL CABLES</b>	
5.6a	B-Series Breakout – Riser Rated Tray Cables.....	183
5.6b	G-Series Subgrouping – Riser Rated Tray Cables.....	186
5.6c	D-Series Distribution – Interlocking Armor (ILA) Riser Rated Cables.....	188
5.6d	D-Series Distribution – Interlocking Armor (ILA Plenum Rated Cables .....	190
5.6e	B-Series Breakout – Interlocking Armor (ILA) Riser Rated Cables.....	192
5.6f	B-Series Breakout – Interlocking Armor (ILA Plenum Rated Cables .....	194
5.6g	G-Series Subgrouping – Interlocking Armor (ILA) Riser Rated Cables .....	196
5.6h	G-Series Subgrouping – Interlocking Armor (ILA) Plenum Rated Cables .....	198
5.6i	HC-Series – High Density Riser Rated Cables .....	200
5.6j	CX-Series Hybrid – Copper/Fiber Riser and Plenum Rated Cables .....	202
5.6k	CX-Series Hybrid – UL 1277 Tray Cables .....	204
<b>5.7</b>	<b>FIBER TO ANTENNA CABLES</b>	
5.7a	FTTA .....	205
<b>5.8</b>	<b>CABLE INFORMATION</b>	
5.8a	Laser Ultra-Fox Fiber Performance .....	206
5.8b	Ultra-Fox Fiber Performance.....	207

## (5.1a) A-Series – Deployable Single-Fiber Cables



1. Tight-Buffer Optical Fiber
2. Aramid Strength Member
3. Outer Jacket

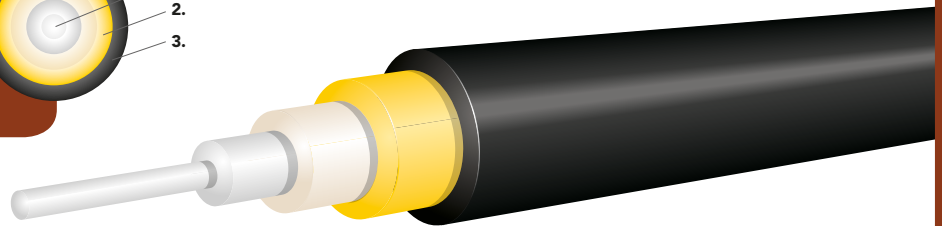
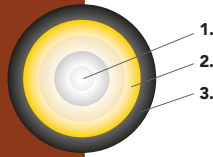

### Product Overview

OCC has produced many deployable single-fiber military tactical field cable designs to meet particular environmental, mechanical, or system requirements. Some have evolved into standard products, described elsewhere in this catalog. Others are fully developed, have been produced for specific applications, and are readily reproducible. All the cables are designed with our extensive and well-proven tight-buffer technology. Generally, for OCC, they are straightforward implementations of proven designs, or combinations thereof. Your deployable cable requirements, though new, can be easily implemented with assurance of success.

Below are some of our most popular single-fiber deployable cables. Please contact our sales department about your particular requirements for an assessment or quotation.

### Payout Cables

#### APPLICATIONS

- Payout from precision coil packs
- Detailed design is based on the environment, payout speed, cable length, and cable physical properties

#### FEATURES

- Precise outer jacket diameter tolerances
- Relatively stiff and hard jacket materials to reduce friction and avoid kinking after payout
- As strong, crush-proof and survivable as their small size allows
- 500µm primary acrylate buffer
- Some include a secondary 900µm buffer
- Can use 200 kpsi fiber

### Land and Air Rapid Payout Cables

#### APPLICATIONS

- High-speed land or air-deployed cable
- Land deployments up to 60 mph (100 kph)
- Air deployment up to 130 mph (210 kph)

#### FEATURES

- Hard elastomeric pressure-extruded outer jacket to ensure mechanical integrity under stress
- Designed to withstand crush and impact after deployment
- Land-deployable cables are commonly 2.5mm and 2.0mm
- Long continuous lengths

### Simplex Military Tactical Cables

#### APPLICATIONS

- Temporarily deployed cables that can be retrieved for repeated use

#### FEATURES

- Wide temperature range (typically -55°C to 85°C)
- 500µm primary acrylate buffer with 900µm secondary hard elastomeric buffer (Ultra-Fox Plus)
- Excellent crush and impact resistance due to their polyurethane Core-Locked™ outer jacket
- Strong, lightweight and extremely durable cable
- 2.5, 2.9, 4.0 and 4.5mm cable designs available depending on the application

 (5.1a) A-Series – Deployable Single-Fiber Cables

## Cable Characteristics

DIAMETER MM (IN)	JACKET MATERIAL	RATING	WEIGHT KG/KM (LBS/1,000')	BREAKING STRENGTH N (LBS)	SPECIFIC GRAVITY	APPLICATION
4.5 (0.18)	C	M	19 (13)	2,300 (520)	1.15	TFC
4.0 (0.16)	C	M	15 (10)	1,700 (380)	1.15	TFC
2.9 (0.12)	C	M	8.4 (6)	1,700 (380)	1.15	LBD
2.5 (0.10)	C	M	5.8 (4)	1,300 (290)	1.15	LBD
2.5 (0.10)	R	M	6.0 (4)	1,000 (220)	1.18	HAD/LBD
2.0 (0.08)	R	M	3.7 (2)	1,000 (220)	1.18	HAD/LBD

TFC = Tactical field cable for ground-based deployment

LBD = Land-based deployment for communications or remote vehicle control

HAD = High-speed air-deployable from coil packs

## Ordering Information

Digit No:	1	2	3	4	5	6	7	8	9	10	11	12
	<b>A</b>		<b>0</b>	<b>0</b>	<b>1</b>					<b>5</b>		
1	Assembly Series = <b>A</b>											
2	Diameter:											
	2.0mm = <b>E</b>											
	2.5mm = <b>J</b>											
	2.9mm = – (for Ultra-Fox Plus Fiber)											
	4.0mm = <b>U</b>											
	4.5mm = <b>V</b>											
3–5	Fiber count: = <b>001</b>											
6	Jacket material: As defined above in the Cable Characteristics table											
7–9	Fiber type: (see Ultra-Fox Plus Fiber Performance Table, pg. 207)											
10	Ultra-Fox Plus fiber with 900µm tight-buffer = <b>5</b>											
11	Jacket color: Black = <b>K</b>											
12	Rating: Military = <b>M</b>											

**Example:** 1-fiber 4.0mm assembly cable for tactical field cable for ground-based deployment using low water peak Ultra-Fox Plus single-mode fiber

**A U 0 0 1 C S L S 5 K M**

## (5.1b) D-Series Distribution – Arctic Fox™ and Arctic Fox™ Plus Cables

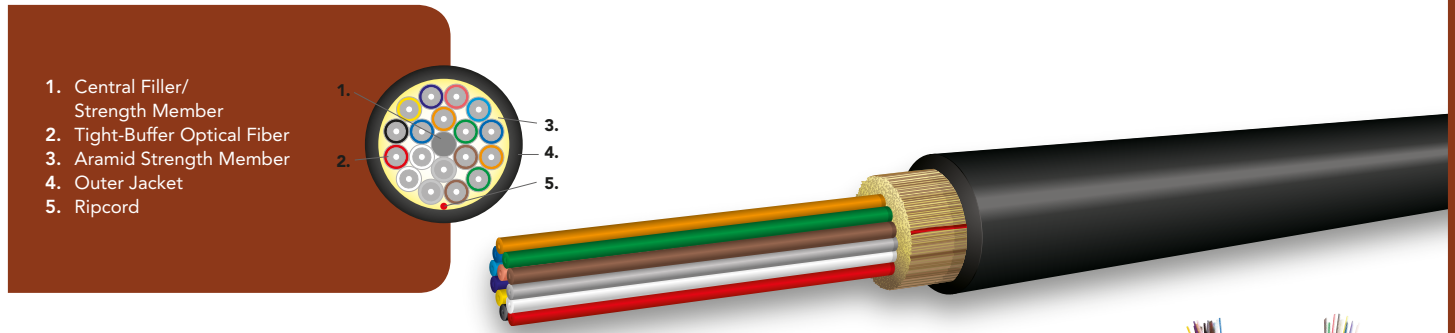

### Applications

- Ideal for extreme low temperatures where crush due to ice and jacket flexibility are concerns, while maintaining excellent attenuation performance

### Features

- Optimized for use in extreme low-temperature applications
- Better attenuation performance than other commercially available cables
- Better jacket flexibility performance than other commercially available cables
- Excellent ice-crush performance
- Can be installed in duct
- Can have CST Armor applied for direct buried applications

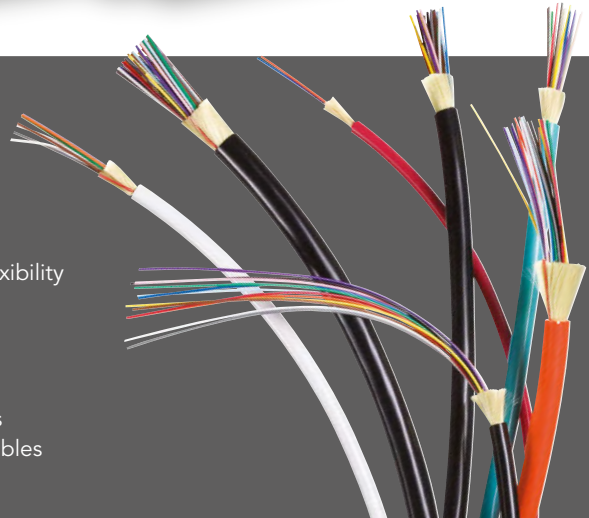

### Applicable Standards

OCC D-Series Arctic Fox and Arctic Fox Plus Distribution Cables meet or exceed the functional requirements of the following standards:

- ICEA S-87-640

### Mechanical and Environmental Performance

	ARCTIC FOX	ARCTIC FOX PLUS
Operating temperature	-40°C to +85°C	-55°C to +85°C
Storage temperature	-55°C to +85°C	-55°C to +85°C
Installation temperature (cable temp.)	-40°C to +60°C	-40°C to +60°C
Flexible to	-60°C	-80°C
Crush resistance (TIA-455-41)	1,500 N/cm*	1,500 N/cm*
Flex resistance (TIA-455-104)	1,000 cycles*	1,000 cycles*

\*Meets or exceeds the functional requirements of ANSI/ICEA and 87-640-1999 ANNEX C requirements for very-low temperature applications.

 (5.1b) D-Series Distribution – Arctic Fox™ and Arctic Fox™ Plus Cables

## Cable Characteristics: D-Series Arctic Fox Cables

FIBER COUNT	DIAMETER MM (IN)	WEIGHT KG/KM (LBS/1,000')	TENSILE LOAD		MINIMUM BEND RADIUS	
			INSTALLATION N (LBS)	OPERATIONAL N (LBS)	INSTALLATION CM (IN)	LONG-TERM CM (IN)
2	6.3 (0.25)	29 (19)	2,700 (600)	900 (200)	25.2 (9.9)	12.6 (5.0)
4	6.3 (0.25)	29 (19)	2,700 (600)	900 (200)	25.2 (9.9)	12.6 (5.0)
6	6.3 (0.25)	29 (19)	2,700 (600)	900 (200)	25.2 (9.9)	12.6 (5.0)
8	6.9 (0.27)	35 (24)	2,700 (600)	900 (200)	27.6 (10.9)	13.8 (5.4)
10	7.1 (0.28)	40 (27)	2,700 (600)	900 (200)	28.4 (11.2)	14.2 (5.6)
12	7.9 (0.31)	47 (32)	2,700 (600)	900 (200)	31.6 (12.4)	15.8 (6.2)
18	7.9 (0.31)	47 (32)	2,700 (600)	900 (200)	31.6 (12.4)	15.8 (6.2)
24	9.5 (0.37)	65 (44)	2,700 (600)	900 (200)	38.0 (15.0)	19.0 (7.5)
30	9.7 (0.38)	72 (48)	2,700 (600)	900 (200)	38.8 (15.3)	19.4 (7.6)
36	9.7 (0.38)	71 (48)	2,700 (600)	900 (200)	38.8 (15.3)	19.4 (7.6)
48	10.7 (0.42)	91 (61)	2,700 (600)	900 (200)	42.8 (16.9)	21.4 (8.4)

## Arctic Fox Plus Cables

FIBER COUNT	DIAMETER MM (IN)	WEIGHT KG/KM (LBS/1,000')	TENSILE LOAD		MINIMUM BEND RADIUS	
			INSTALLATION N (LBS)	OPERATIONAL N (LBS)	INSTALLATION CM (IN)	LONG-TERM CM (IN)
2	6.3 (0.25)	26 (17)	3,000 (670)	1,000 (220)	25.2 (9.9)	12.6 (5.0)
4	6.3 (0.25)	26 (17)	3,000 (670)	1,000 (220)	25.2 (9.9)	12.6 (5.0)
6	6.3 (0.25)	26 (17)	3,000 (670)	1,000 (220)	25.2 (9.9)	12.6 (5.0)
8	6.9 (0.27)	39 (26)	3,000 (670)	1,000 (220)	27.6 (10.9)	13.8 (5.4)
10	7.1 (0.28)	45 (30)	3,000 (670)	1,000 (220)	28.4 (11.2)	14.2 (5.6)
12	7.9 (0.31)	53 (36)	3,000 (670)	1,000 (220)	31.6 (12.4)	15.8 (6.2)
18	7.9 (0.31)	57 (38)	3,000 (670)	1,000 (220)	31.6 (12.4)	15.8 (6.2)
24	9.5 (0.37)	77 (52)	3,000 (670)	1,000 (220)	38.0 (15.0)	19.0 (7.5)

Installation loads in excess of 2,700 N (600 lbs.) are not recommended.

## Ordering Information

<b>D</b>											<b>K</b>	<b>A</b>	<b>A</b>	<b>F</b>
<b>Digit No:</b>	1	2	3	4	5	6	7	8	9	10	11	12	13	14

- 1 – 2 Distribution Series Laser Ultra-Fox Arctic Fox = **DX**  
Distribution Series Laser Ultra-Fox Arctic Fox Plus = **D-**
- 3 – 5 Fiber count: (see characteristics chart)
- 6 Jacket type: Arctic Fox = **X**, Arctic Fox Plus = **A**
- 7 – 9 Fiber type: Arctic Fox (see Laser Ultra-Fox Fiber Performance Table, pg. 206)  
Arctic Fox Plus (see Ultra-Fox Plus Fiber Performance Table, pg. 207)
- 10 Laser Ultra-Fox fiber with 900µm tight-buffer (Arctic Fox) = **9**  
Ultra-Fox Plus fiber with 900µm tight-buffer (required for Arctic Fox Plus) = **5**
- 11 Jacket color: Black = **K**
- 12 Rating: None = **A**
- 13 – 14 **AF**

**Example:** 12-fiber Arctic Fox distribution cable using bend-insensitive low water peak single-mode fiber, black jacket, printed in feet

<b>D</b>	<b>X</b>	<b>0</b>	<b>1</b>	<b>2</b>	<b>X</b>	<b>S</b>	<b>L</b>	<b>A</b>	<b>9</b>	<b>K</b>	<b>A</b>	<b>A</b>	<b>F</b>
----------	----------	----------	----------	----------	----------	----------	----------	----------	----------	----------	----------	----------	----------

## (5.1c) B-Series Breakout – Festoon Cables

### Applications

- Flexible, rugged, polyurethane outer cable jacket
- Each fiber has military-grade hard elastomeric 900µm buffer, aramid strength members and 2.5mm subcable jacket for excellent fiber protection
- Resistant to oils and gases
- Wide operating and storage temperature range
- UV protected, fungus and water resistant
- For use in overhead cranes, hoists and other industrial applications

### Features

- Minimum operating bend radius of 10 times the cable outside diameter
- Capable of withstanding 100 mph side-wind loading
- Tight-buffered cable design — no gel to migrate down the cable due to vibration or vertical installation, and no axial migration of fibers
- Capable of vertical distances greater than 1,000 meters — still meets and maintains performance requirements
- Helically stranded subunits ensure flexibility and increased mechanical strength
- Core-Locked™ outer jacket for excellent crush and impact protection and improved tear resistance
- Festoon cables utilize OCC's Ultra-Fox Plus fiber for the ultimate in environmental and mechanical protection



### Mechanical and Environmental Performance

	OUTDOOR
Operating temperature	-55°C to +85°C
Storage temperature	-70°C to +85°C
Impact resistance	1,500 impacts
Crush resistance	2,200 N/cm
Flex resistance	2,000 cycles

### B-Series Breakout Festoon Cables (with 2.5mm Subcables)

FIBER COUNT	DIAMETER MM (IN)	WEIGHT KG/KM (LBS/1,000')	TENSILE LOAD		MINIMUM BEND RADIUS	
			INSTALLATION N (LBS)	OPERATIONAL N (LBS)	INSTALLATION CM (IN)	LONG-TERM CM (IN)
4	16.0 (0.63)	203 (136)	1,600 (360)	400 (90)	24.0 (9.4)	16.0 (6.3)
6	16.0 (0.63)	206 (138)	1,600 (360)	400 (90)	24.0 (9.4)	16.0 (6.3)
8	16.0 (0.63)	209 (140)	2,400 (540)	600 (130)	24.0 (9.4)	16.0 (6.3)
10	18.0 (0.71)	272 (183)	3,200 (720)	800 (180)	27.0 (10.6)	18.0 (7.1)
12	18.0 (0.71)	254 (171)	6,000 (1,350)	1,500 (340)	27.0 (10.6)	18.0 (7.1)
18	18.0 (0.71)	249 (167)	6,000 (1,350)	1,500 (340)	27.0 (10.6)	18.0 (7.1)
24	18.0 (0.71)	237 (159)	7,200 (1,600)	1,800 (400)	27.0 (10.6)	18.0 (7.1)

### Ordering Information

FIBER COUNT	SINGLE-MODE ULTRA-FOX PLUS	ULTRA-FOX PLUS 62.5/125 MULTIMODE	ULTRA-FOX PLUS 50/125 MULTIMODE
4	OC020912-33	OC020912-32	OC020912-35
6	OC020912-01	OC020912-11	OC020912-21
8	OC020912-02	OC020912-12	OC020912-22
10	OC020912-03	OC020912-13	OC020912-23

FIBER COUNT	SINGLE-MODE ULTRA-FOX PLUS	ULTRA-FOX PLUS 62.5/125 MULTIMODE	ULTRA-FOX PLUS 50/125 MULTIMODE
12	OC020912-04	OC020912-14	OC020912-24
18	OC020912-05	OC020912-15	OC020912-25
24	OC020912-06	OC020912-16	OC020912-34



## 5.1.d) CX-Series Hybrid – Fiber/Copper Deployable Cables

1. Ripcord
2. Stranded Copper Wire
3. Optical Fiber Subcable
4. Aramid Strength Member
5. Outer Jacket

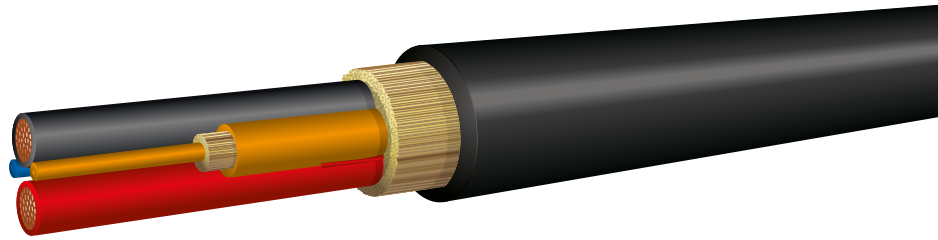
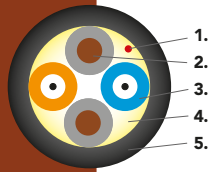

### Applications

- Used in outdoor applications that require both optical fiber and copper wire elements for communication and power
- Copper wire can power remote electronics used in fiber optic communications
- Copper wire can also be used for low data rate data transmission
- Deployable cables have been used in network and private broadcast applications around the world
- Cables can be designed for your custom applications
- Designed for use with United States National Electric Code (NEC) Class 2 power sources

### Features

- Includes both fiber optic subunits and copper, individually jacketed wire
- Fiber optic subunits both protect the optical fiber and provide aramid yarn to strain relieve the optical fiber when individual connectors are used
- The individual copper wire is rated to 600V
- Up to 4 copper wires are standard
- Standard copper wire used includes high-strand-count wire for greater cable flexibility
- Standard wire gauges range from 18 to 12 AWG
- Additional aramid yarn included around the cable core for strain-relief in multi-element connectors, such as F-LINK
- Polyurethane jacket materials provide a rugged jacket and provide flexibility to the cable
- C, V and G jacket materials are available for use
- Polyurethane jackets are chemical resistant
- Water, fungus and UV resistant for extreme environments
- The customer is responsible for ensuring compliance with all local and national safety and electrical code during use
- Appropriate electrical safety protection is required whenever the copper wire is energized



### Cable Characteristics CX-Series Hybrid Fiber/Copper Deployable Cables

- Due to the wide range of constructions possible, call for construction details.

### Ordering Information

- Please call for part numbers. Call 1-800-622-7711 and ask for a Sales Representative. We're ready to assist you.

Consistent with the definition in TIA-440-B "Fiber Optic Terminology," hybrid cable is defined as a cable containing both optical fibers and electrical conductors. Composite cable is defined as a cable containing mixed fiber types. Prior to 2012 some U.S. standards documents use definitions for hybrid and composite which are opposite of those stated here. The change in convention was made in the interest of harmonization with International standards and other National standards.



## (5.2a) D-Series Distribution Mil-Tac Cables

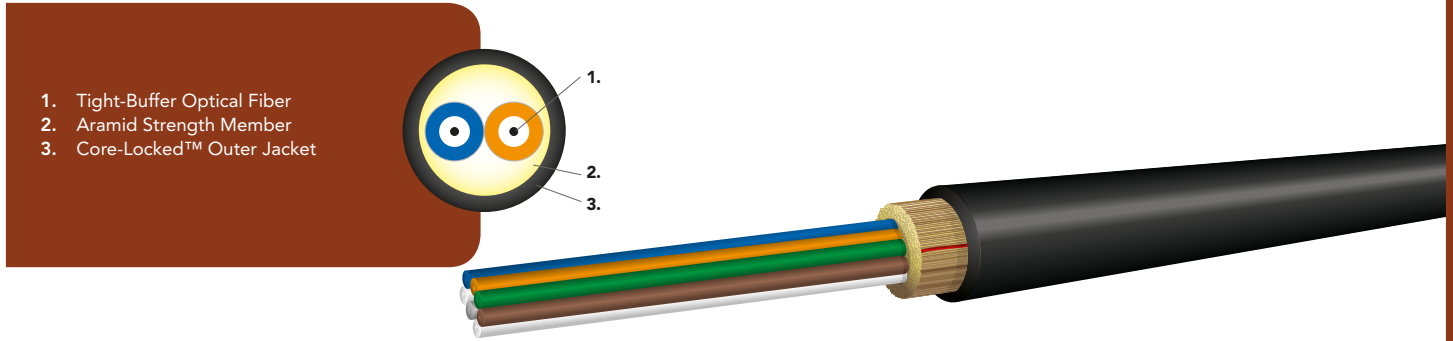

### Applications

- Ground-tactical cable that is ideal for use in harsh environments where deployment and retrieval for reuse are required

### Features

- Extremely strong, lightweight, rugged, survivable tight-buffered cables designed for military tactical field use and commercial applications
- Compact, round cable design for ease of transportation and deployment
- Core-Locked™ jacket for improved mechanical performance
- Designed for use in adverse environments where reduced size and weight are important
- Helically stranded cable core for flexibility, deployment survivability and exceptional mechanical protection for the optical fibers
- Cables have been tested and are in use in military data communications applications worldwide
- Can be used outdoors for temporary deployment directly on the ground in all terrains, including severe environments
- Suitable for industrial, mining and petrochemical environments
- Crush resistant and resilient with a thick layer of aramid strength members
- Polyurethane jacketed for abrasion, cut and chemical resistance
- Most commonly used with ruggedized military tactical field connectors, for maximum connector retention (400 lbs.)
- Tactical Polyurethane (C) outer jacket material is standard; Flame-retardant Tactical (V) and Low-Smoke Zero-Halogen (G) outer jacket materials are available
- Ultra-Fox Plus Fiber (500µm) used for environmental and mechanical protection
- MIL-PRF-49291 QPL fiber available when specified or required

### OCC Provided Options

- Mil-Tac cables prespooled on MARS deployable reels for a ready-to-use product
- Mil-Tac cables can be pre-terminated with single fiber or ruggedized multichannel connectors upon request



### Applicable Standards

OCC Military cables meet or exceed the functional requirements of the following standards

- MIL-PRF-85048/8B ground tactical test methods as applicable
- TIA-455 commercial and military requirements

### Mechanical and Environmental Performance

	(TESTED TO MIL PRF 85045 METHODS)
Operating temperature	-55°C to +85°C
Storage temperature	-70°C to +85°C
Impact resistance	1,500 impacts
Crush resistance	1,800 N/cm
Flex resistance	2,000 cycles

 (5.2a) D-Series Distribution Mil-Tac Cables

## Cable Characteristics: D-Series Mil-Tac Cables (C Jacket)

FIBER COUNT	DIAMETER MM (IN)	WEIGHT KG/KM (LBS/1,000')	TENSILE LOAD		MINIMUM BEND RADIUS	
			INSTALLATION N (LBS)	OPERATIONAL N (LBS)	INSTALLATION CM (IN)	LONG-TERM CM (IN)
2	5.0 (0.20)	21 (14)	1,800 (400)	600 (130)	5.0 (2.0)	2.5 (1.0)
4	5.5 (0.22)	27 (18)	1,800 (400)	600 (130)	5.5 (2.2)	2.8 (1.1)
6	6.0 (0.24)	32 (22)	1,800 (400)	600 (130)	6.0 (2.4)	3.0 (1.2)
8	6.5 (0.26)	37 (25)	1,800 (400)	600 (130)	6.5 (2.6)	3.3 (1.3)
10	6.5 (0.26)	38 (26)	2,100 (470)	700 (160)	6.5 (2.6)	3.3 (1.3)
12	6.5 (0.26)	41 (28)	2,100 (470)	700 (160)	6.5 (2.6)	3.3 (1.3)
18	7.5 (0.30)	48 (32)	2,400 (540)	800 (180)	7.5 (3.0)	3.8 (1.5)
24	8.5 (0.33)	60 (40)	3,000 (670)	1,000 (220)	8.5 (3.3)	4.3 (1.7)

## D-Series Mil-Tac Cables (V Jacket)

FIBER COUNT	DIAMETER MM (IN)	WEIGHT KG/KM (LBS/1,000')	TENSILE LOAD		MINIMUM BEND RADIUS	
			INSTALLATION N (LBS)	OPERATIONAL N (LBS)	INSTALLATION CM (IN)	LONG-TERM CM (IN)
2	5.0 (0.20)	24 (16)	1,800 (400)	600 (130)	5.0 (2.0)	2.5 (1.0)
4	5.5 (0.22)	29 (19)	1,800 (400)	600 (130)	5.5 (2.2)	2.8 (1.1)
6	6.0 (0.24)	34 (23)	1,800 (400)	600 (130)	6.0 (2.4)	3.0 (1.2)
8	6.5 (0.26)	39 (26)	1,800 (400)	600 (130)	6.5 (2.6)	3.3 (1.3)
10	6.5 (0.26)	40 (27)	2,100 (470)	700 (160)	6.5 (2.6)	3.3 (1.3)
12	6.5 (0.26)	43 (29)	2,100 (470)	700 (160)	6.5 (2.6)	3.3 (1.3)
18	7.5 (0.30)	51 (34)	2,400 (540)	800 (180)	7.5 (3.0)	3.8 (1.5)
24	8.5 (0.33)	63 (42)	3,000 (670)	1,000 (220)	8.5 (3.3)	4.3 (1.7)

## D-Series Mil-Tac Cables (G Jacket)

FIBER COUNT	DIAMETER MM (IN)	WEIGHT KG/KM (LBS/1,000')	TENSILE LOAD		MINIMUM BEND RADIUS	
			INSTALLATION N (LBS)	OPERATIONAL N (LBS)	INSTALLATION CM (IN)	LONG-TERM CM (IN)
2	5.0 (0.20)	22 (15)	1,800 (400)	600 (130)	5.0 (2.0)	2.5 (1.0)
4	5.5 (0.22)	28 (19)	1,800 (400)	600 (130)	5.5 (2.2)	2.8 (1.1)
6	6.0 (0.24)	33 (22)	1,800 (400)	600 (130)	6.0 (2.4)	3.0 (1.2)
8	6.5 (0.26)	38 (26)	1,800 (400)	600 (130)	6.5 (2.6)	3.3 (1.3)
10	6.5 (0.26)	39 (26)	2,100 (470)	700 (160)	6.5 (2.6)	3.3 (1.3)
12	6.5 (0.26)	42 (28)	2,100 (470)	700 (160)	6.5 (2.6)	3.3 (1.3)
18	7.5 (0.30)	49 (33)	2,400 (540)	800 (180)	7.5 (3.0)	3.8 (1.5)
24	8.5 (0.33)	62 (42)	3,000 (670)	1,000 (220)	8.5 (3.3)	4.3 (1.7)

## (5.2a) D-Series Distribution Mil-Tac Cables

### Ordering Information

	D	-								5	K	M
<b>Digit No:</b>	1	2	3	4	5	6	7	8	9	10	11	12
1 – 2	Mil-Tac Distribution Series Ultra-Fox Plus= <b>D-</b>											
3 – 5	Fiber count: (See Cable Characteristics Chart) = <b>002-024</b>											
6	Jacket type:											
	Tactical Polyurethane = <b>C</b>											
	Low-Smoke Zero-Halogen Polyurethane = <b>G</b>											
	Tactical Flame-Retardant Polyurethane = <b>V</b>											
7 – 9	Fiber type: (see Ultra-Fox Plus Fiber Performance Table, pg. 207)											
10	Ultra-Fox Plus Fiber with 900µm tight-buffer = <b>5</b>											
11	Jacket color: Black = <b>K</b>											
12	Rating: Mil-Tac Cable Rating = <b>M</b>											

**Example:** 12-fiber Mil-Tac distribution cable using low water peak Ultra-Fox Plus single-mode fiber, black jacket

D	-	0	1	2	C	S	L	S	5	K	M
---	---	---	---	---	---	---	---	---	---	---	---

(5.2b) D-Series Distribution – Mil-Tac Rodent Deterrent (FRP) Cables

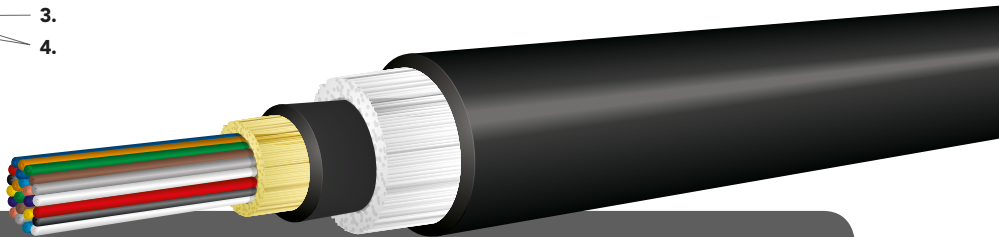

Applications

- Ground-tactical cable that is ideal for use in harsh environments where deployment and retrieval for reuse are required
- Used in areas susceptible to damage from small non-burrowing rodents

Features

- Standard OCC D-Series Mil-Tac inner cable with an added layer of fiberglass yarn that provides an effective deterrent to damage caused by small, non-burrowing rodents (not recommended for direct burial applications)
- FRP is ideal for use for surface installations (not recommended for direct buried applications)
- Mil-Tac cable can be made in a variety of colors for easy identification or to blend into the environment
- Helically stranded cable core for flexibility, deployment survivability, and excellent mechanical protection for the optical fibers
- Cables are suitable for use with single, as well as multichannel, connectors
- Excellent crush resistance to withstand crowd and vehicle traffic
- High tensile load rating for quick deployment and retrieval
- Water, fungus and UV resistant for extreme environments
- Outdoor, field-proven cables are easily deployed and retrieved for temporary or long-term data communications in harsh environments
- Standard Polyurethane (C), Flame-Retardant Tactical Polyurethane (V) and Low-Smoke Zero-Halogen (G) jackets are available

OCC Provided Options

- Mil-Tac cables prespooled on MARS deployable reels for a ready-to-use product
- Mil-Tac cables can be pre-terminated with single-fiber or ruggedized multichannel connectors upon request



Applicable Standards

OCC Military cables meet or exceed the functional requirements of the following standards

- MIL-PRF-85048/8B ground tactical test methods as applicable
- TIA-455 commercial and military requirements

Mechanical and Environmental Performance

	(TESTED TO MIL PRF 85045 METHODS)
Operating temperature	-55°C to +85°C
Storage temperature	-70°C to +85°C
Impact resistance	1,500 impacts
Crush resistance	1,800 N/cm
Flex resistance	2,000 cycles

## (5.2b) D-Series Distribution – Mil-Tac Rodent Deterrent (FRP) Cables

### Cable Characteristics: D-Series Mil-Tac Rodent Deterrent FRP Cables (C Jacket)

FIBER COUNT	DIAMETER MM (IN)	WEIGHT KG/KM (LBS/1,000')	TENSILE LOAD		MINIMUM BEND RADIUS	
			INSTALLATION N (LBS)	OPERATIONAL N (LBS)	INSTALLATION CM (IN)	LONG-TERM CM (IN)
2	10.7 (0.42)	104 (70)	1,800 (400)	600 (130)	16.1 (6.3)	10.7 (4.2)
4	10.7 (0.42)	104 (70)	1,800 (400)	600 (130)	16.1 (6.3)	10.7 (4.2)
6	10.7 (0.42)	104 (70)	1,800 (400)	600 (130)	16.1 (6.3)	10.7 (4.2)
8	11.6 (0.46)	123 (83)	1,800 (400)	600 (130)	17.4 (6.9)	11.6 (4.6)
10	11.6 (0.46)	125 (84)	2,100 (470)	700 (160)	17.4 (6.9)	11.6 (4.6)
12	12.7 (0.50)	145 (97)	2,100 (470)	700 (160)	19.1 (7.5)	12.7 (5.0)
18	12.4 (0.49)	139 (93)	2,400 (540)	800 (180)	18.6 (7.3)	12.4 (4.9)
24	13.2 (0.52)	156 (105)	3,000 (670)	1,000 (220)	19.8 (7.8)	13.2 (5.2)

### D-Series Mil-Tac Rodent Deterrent FRP Cables (V Jacket)

FIBER COUNT	DIAMETER MM (IN)	WEIGHT KG/KM (LBS/1,000')	TENSILE LOAD		MINIMUM BEND RADIUS	
			INSTALLATION N (LBS)	OPERATIONAL N (LBS)	INSTALLATION CM (IN)	LONG-TERM CM (IN)
2	10 (0.39)	101 (68)	1,800 (400)	600 (130)	15.0 (5.9)	10.0 (3.9)
4	10 (0.39)	101 (68)	1,800 (400)	600 (130)	15.0 (5.9)	10.0 (3.9)
6	10 (0.39)	101 (68)	1,800 (400)	600 (130)	15.0 (5.9)	10.0 (3.9)
8	10.8 (0.43)	118 (79)	1,800 (400)	600 (130)	16.2 (6.4)	10.8 (4.3)
10	10.8 (0.43)	119 (80)	2,100 (470)	700 (160)	16.2 (6.4)	10.8 (4.3)
12	11.9 (0.47)	140 (94)	2,100 (470)	700 (160)	17.9 (7.0)	11.9 (4.7)
18	11.6 (0.46)	138 (93)	2,400 (540)	800 (180)	17.4 (6.9)	11.6 (4.6)
24	12.5 (0.49)	159 (107)	3,000 (670)	1,000 (220)	18.8 (7.4)	12.5 (4.9)

### D-Series Mil-Tac Rodent Deterrent FRP Cables (G Jacket)

FIBER COUNT	DIAMETER MM (IN)	WEIGHT KG/KM (LBS/1,000')	TENSILE LOAD		MINIMUM BEND RADIUS	
			INSTALLATION N (LBS)	OPERATIONAL N (LBS)	INSTALLATION CM (IN)	LONG-TERM CM (IN)
2	10 (0.39)	98 (66)	1,800 (400)	600 (130)	15.0 (5.9)	10.0 (3.9)
4	10 (0.39)	98 (66)	1,800 (400)	600 (130)	15.0 (5.9)	10.0 (3.9)
6	10 (0.39)	98 (66)	1,800 (400)	600 (130)	15.0 (5.9)	10.0 (3.9)
8	10.8 (0.43)	115 (77)	1,800 (400)	600 (130)	16.2 (6.4)	10.8 (4.3)
10	10.8 (0.43)	117 (79)	2,100 (470)	700 (160)	16.2 (6.4)	10.8 (4.3)
12	11.9 (0.47)	137 (92)	2,100 (470)	700 (160)	17.9 (7.0)	11.9 (4.7)
18	11.6 (0.46)	135 (91)	2,400 (540)	800 (180)	17.4 (6.9)	11.6 (4.6)
24	12.5 (0.49)	155 (104)	3,000 (670)	1,000 (220)	18.8 (7.4)	12.5 (4.9)

"Mil-Tac" designated and tested cables available to 24 fibers.  
Other fiber counts available with polyurethane outer jacket  
Installation loads in excess of 2,700N (600lbs.) are not recommended.





## (5.2b) D-Series Distribution – Mil-Tac Rodent Deterrent (FRP) Cables

## Ordering Information

	D	-								5	K	M	F	
Digit No:	1	2	3	4	5	6	7	8	9	10	11	12	13	14
1 – 2	Mil-Tac Distribution Series Ultra-Fox Plus= <b>D</b> –													
3 – 5	Fiber count: (See Cable Characteristics Chart) = <b>002-024</b>													
6	Jacket type:													
	Tactical Polyurethane = <b>C</b>													
	Low-Smoke Zero-Halogen Polyurethane = <b>G</b>													
	Tactical Flame-Retardant Polyurethane = <b>V</b>													
7 – 9	Fiber type: (see Ultra-Fox Plus Fiber Performance Table, pg. 207)													
10	Ultra-Fox Plus fiber with 900µm tight-buffer = <b>5</b>													
11	Jacket color: Black = <b>K</b>													
12	Rating: Mil-Tac Cable Rating = <b>M</b>													
13	FRP Layer = <b>F</b>													
14	Outer jacket													
	C jacket = <b>9</b>													
	G jacket = <b>B</b>													
	V jacket = <b>8</b>													

**Example:** 12-fiber Mil-Tac distribution cable with C jacket using 62.5µm Ultra-Fox Plus, black jacket with FRP

D	-	0	1	2	C	W	S	T	5	K	M	F	9
---	---	---	---	---	---	---	---	---	---	---	---	---	---

## (5.2c) DOD QPL-85045 Qualified Products



1. Tight-Buffer Optical Fiber
2. Aramid Strength Member
3. Outer Jacket

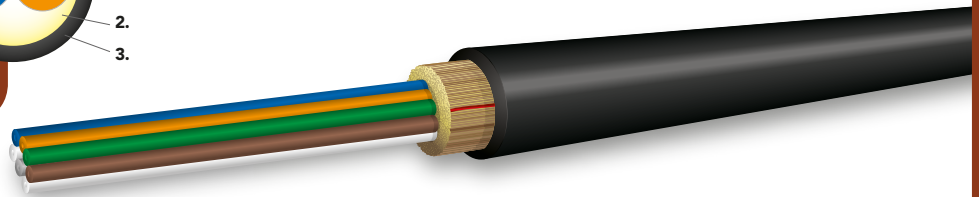
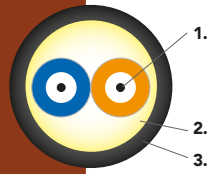

### Applications

- Used when contracts demand qualified products included on the QPL-85045 Qualified Products List for cable qualified to MIL-PRF-85045/8B
- Specifically designed and qualified for use in extreme environmental conditions, as defined by MIL-PRF-85045/8B
- Qualified to DEF STAN 60-1 (Part 3)

### Features

- United States Defense Logistics Agency certified manufacturer per MIL-STD-790F
- Rugged, tight-buffered fiber optic cable construction for the highest possible survivability in severe crush, impact, vehicle rollover, deployment and retrieval conditions
- Tested to the most demanding military tactical cable qualification standards
- High tensile load capability for excellent termination strength with military tactical connectors
- 100% compatible with 2- and 4-fiber TFOCA connectors
- Based on more than 30 years of Optical Cable Corporation's military tactical fiber optic cable production



Courtesy of USASOC

### Cable Characteristics: DOD QPL-85045 Qualified Cables

FIBER COUNT	DIAMETER MM (IN)	WEIGHT KG/KM (LBS/1,000')	TENSILE LOAD		MINIMUM BEND RADIUS	
			INSTALLATION N (LBS)	OPERATIONAL N (LBS)	INSTALLATION CM (IN)	LONG-TERM CM (IN)
2	5.8 (0.23)	31 (21)	1,800N (400)	600N (135)	9.3 (3.7)	4.6 (1.8)
4	5.8 (0.23)	31 (21)	1,800N (400)	600N (135)	9.3 (3.7)	4.6 (1.8)

### Ordering Information: Base Part Number = OC040522

FIBER TYPE	MINIMUM LED BANDWIDTH (MHZ-KM)		MINIMUM LASER BANDWIDTH (MHZ-KM)		FIBER COUNT	
	850 NM	1,300 NM	850 NM	1,300 NM	2	4
62.5/125	500	500	510	500	-04	-06

Example: 4-fiber 62.5 – OC040522-06

## (5.2c) DOD QPL-85045 Qualified Products

## MIL-PRF-85045 Compliance Summary

SPECIFICATION	TEST	REQUIREMENT
MIL-PRF-85045 (TIA-455-42)	Crosstalk	< -60 dB
MIL-PRF-85045 (TIA-455-71)	Thermal shock	-57°C to +85°
MIL-PRF-85045 (TIA-455-190)	Barometric pressure (Altitude)	3,000 meters (op), 12,2000 meters (non-op)
MIL-PRF-85045 (TIA-455-12)	Fluid immersion	Diameter change ≤ 10%
MIL-PRF-85045 (TIA-455-3)	Temperature cycling	-46°C to +71°C
MIL-PRF-85045 Sec 4.7.6.4	Storage temperature	-57°C to +85°C
MIL-PRF-85045 (TIA-455-5)	Temperature/humidity	95%
MIL-PRF-85045 (TIA-455-4)	Life aging	240 hrs. at +110°C
MIL-PRF-85045 Sec 4.7.6.12.1	Flammability	60° angle
MIL-PRF-85045 (TIA-455-88)	Corner bend	500N test load
MIL-PRF-85045 (TIA-455-87)	Knot force (mandrel, non-mandrel)	500N test load
MIL-PRF-85045 (TIA-455-25)	Impact (1.5kg hammer)	100 impacts @ 25°C 50 impacts @ -46°C and +71°C
MIL-PRF-85045 (TIA-455-104)	Cyclic flexing	2,000 cycles @ -46°C, +25° and +71°C
MIL-PRF-85045 (TIA-455-41)	Crush	2,000 N/cm for 3 minutes
MIL-PRF-85045 (TIA-455-91)	Cable twist testing	100N test load 2,000 cycles @ -46°C, +25° and +71°C
MIL-PRF-85045 (TIA-455-33)	Tensile loading and elongation	≤ 0.5dB multimode, ≤ 0.2dB single-mode
MIL-PRF-85045 (TIA-455-33)	Operational tensile	290N , 72 hours
MIL-PRF-85045 (TIA-455-98)	Ice crush	No degradation after exposure
MIL-PRF-85045 (TIA-455-37)	Low-temperature, flexibility (cold bend)	-46°C 10kg mass
MIL-PRF-85045 (TIA-455-56)	Fungus resistance	No degradation after exposure

## (5.2d) Military Tactical Fiber Optic Cables for Extreme Environments

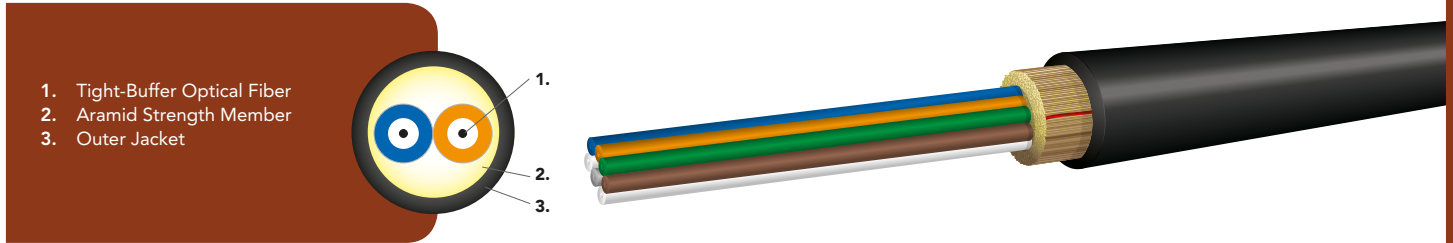

1. Tight-Buffer Optical Fiber
2. Aramid Strength Member
3. Outer Jacket

### Applications

- Designed specifically for tactical/harsh environment connectors such as MIL-C-28876, MIL-C-38899 and other standard commercial connectors
- Specifically designed for extreme environmental conditions – temperature, humidity, ice, fungus, and fluid immersion
- Cables are used in DOD and MOD projects domestically and worldwide

### Features

- Rugged, tight-buffered fiber optic cable construction for the highest possible survivability in severe crush, impact, vehicle runover, deployment and retrieval conditions
- Tested to the most demanding military tactical cable qualification standards
- High tensile load capability for excellent termination strength with military tactical connectors
- Available with radiation hardened or non-radiation hardened optical fibers
- Based on more than 30 years of Optical Cable Corporation's military tactical fiber optic cable production
- RK981104 series cables conform to design requirements of U.S. Army CECOM specification A3159879 for tactical fiber optic cable

### Cable Characteristics: Military Tactical Fiber Optic Cables for Extreme Environments

FIBER COUNT	DIAMETER MM (IN)	WEIGHT KG/KM (LBS/1,000')	TENSILE LOAD		MINIMUM BEND RADIUS	
			INSTALLATION N (LBS)	OPERATIONAL N (LBS)	INSTALLATION CM (IN)	LONG-TERM CM (IN)
2	5.8 (0.23)	31 (21)	1,800N (400)	600N (135)	8.7 (3.4)	5.8 (2.3)
4	5.8 (0.23)	31 (21)	1,800N (400)	600N (135)	8.7 (3.4)	5.8 (2.3)

### Ordering Information: Base Part Number = RK981104

FIBER TYPE	BANDWIDTH (MHZ-KM)		FIBER COUNT	
	850 NM	1,300 NM	2	4
Radiation Hardened (RH)				
62.5/125 Rad Hard	160	500	-06	-09
	220	800	-06-A	-09-A
50/125 Rad Hard	500	500	-07	-10
	600	1,000	-07-A	-10-A
Single-Mode Rad Hard	–	–	-08	-11

FIBER TYPE	BANDWIDTH (MHZ-KM)		FIBER COUNT	
	850 NM	1,300 NM	2	4
Non-Radiation Hardened				
62.5/125	160	500	(none)	-01
	220	800	-A	-01-A
50/125	500	500	-02	-03
	600	1,000	-02-A	-03-A
Single-Mode	–	–	-04	-05

**Example:** 4-fiber 62.5 RH 220/800 bandwidth – RK981104-09-A

## (5.2e) B-Series Breakout – Mil-Tac Cables

1. Tight-Buffer Optical Fiber
  2. Subcable
  3. Aramid Strength Member
  4. Outer Jacket
- Subcable**
5. Tight-Buffer Optical Fiber
  6. Aramid Strength Member
  7. Subcable Jacket

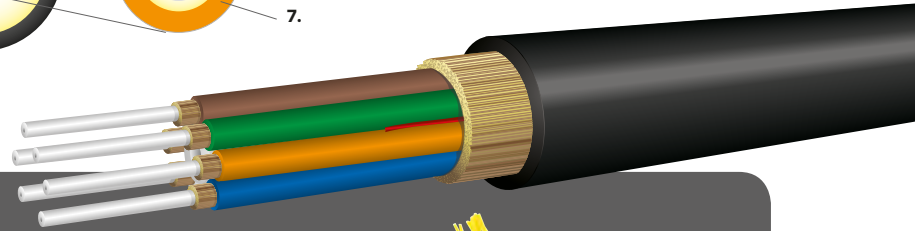
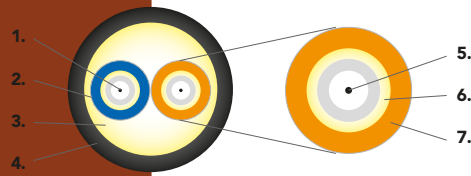

### Applications

- Ground-tactical cable that is ideal for use in harsh environments where deployment and retrieval for reuse are required
- Ideal for applications that require termination of the subcables to a connector

### Features

- Extremely strong, lightweight, rugged, survivable tight-buffered cables designed for military tactical field use and commercial applications
- Polyurethane jacketed for abrasion, cut and chemical resistance
- Core-Locked™ jacket for improved mechanical performance
- Breakout cable design with individual color-coded subcables protecting each optical fiber
- Crush resistant and resilient, with two separate layers of aramid strength members in the subcables for individual single-fiber connector and termination pin, and overall for termination to multiway connector backshells or other housings
- Helically stranded cable core for flexibility, deployment survivability and exceptional mechanical protection for the optical fibers
- Cables have been tested and are in use in military data communications applications worldwide
- Can be used outdoors for temporary deployment directly on the ground, in all terrains, including severe environments
- Suitable for industrial, mining and petrochemical environments; chemical resistant
- Round cable design for easy installation and survivability
- Often used with military tactical connectors for maximum connector retention (400 lbs.)
- Ideally suited for use with MIL-C-38999 style military connectors; subcables terminate to individual pins, and overall aramid strength member terminates to backshell
- 2.0 mm subcables standard
- Tactical Polyurethane (C) outer jacket material is standard; Flame-Retardant Tactical (V) and Low-Smoke Zero-Halogen (G) outer jacket materials are available
- Ultra-Fox Plus fiber used for the ultimate environmental and mechanical protection

### OCC Provided Options

- Mil-Tac cables prespooled on MARS deployable reels for a ready-to-use product
- Mil-Tac cables can be pre-terminated with single-fiber or ruggedized multichannel connectors upon request

### Mechanical and Environmental Performance

	(TESTED TO MIL PRF 85045 METHODS)
Operating temperature	-55°C to +85°C
Storage temperature	-70°C to +85°C
Impact resistance	1,500 impacts
Crush resistance	2,200 N/cm
Flex resistance	2,000 cycles

### Applicable Standards

OCC Military cables meet or exceed the functional requirements of the following standards

- Mil 85045 8B ground tactical test methods as applicable
- TIA-455 commercial and military requirements

## (5.2e) B-Series Breakout – Mil-Tac Cables



### Cable Characteristics: B-Series Breakout Mil-Tac Cables (C Jacket)

FIBER COUNT	DIAMETER MM (IN)	WEIGHT KG/KM (LBS/1,000')	TENSILE LOAD		MINIMUM BEND RADIUS	
			INSTALLATION N (LBS)	OPERATIONAL N (LBS)	INSTALLATION CM (IN)	LONG-TERM CM (IN)
2	6.5 (0.26)	36 (24)	2,200 (490)	550 (120)	6.5 (2.6)	3.3 (1.3)
4	7.5 (0.30)	47 (32)	2,200 (490)	550 (120)	7.5 (3.0)	3.8 (1.5)
6	8.5 (0.33)	55 (37)	2,400 (540)	600 (130)	8.5 (3.3)	4.3 (1.7)
8	10.0 (0.39)	76 (51)	3,200 (720)	800 (180)	10.0 (3.9)	5.0 (2.0)
10	11.5 (0.45)	99 (67)	4,000 (900)	1,000 (220)	11.5 (4.5)	5.8 (2.3)
12	11.0 (0.43)	86 (58)	4,800 (1080)	1,200 (270)	11.0 (4.3)	5.5 (2.2)
18	13.5 (0.53)	135 (91)	7,200 (1620)	1,800 (400)	13.5 (5.3)	6.8 (2.7)
24	14.5 (0.57)	150 (101)	9,600 (2160)	2,400 (540)	14.5 (5.7)	7.3 (2.9)

### B-Series Breakout Mil-Tac Cables (V Jacket)

FIBER COUNT	DIAMETER MM (IN)	WEIGHT KG/KM (LBS/1,000')	TENSILE LOAD		MINIMUM BEND RADIUS	
			INSTALLATION N (LBS)	OPERATIONAL N (LBS)	INSTALLATION CM (IN)	LONG-TERM CM (IN)
2	6.5 (0.26)	39 (26)	2,200 (490)	550 (120)	6.5 (2.6)	3.3 (1.3)
4	7.5 (0.30)	49 (33)	2,200 (490)	550 (120)	7.5 (3.0)	3.8 (1.5)
6	8.5 (0.33)	57 (38)	2,400 (540)	600 (130)	8.5 (3.3)	4.3 (1.7)
8	10.0 (0.39)	79 (53)	3,200 (720)	800 (180)	10.0 (3.9)	5.0 (2.0)
10	11.5 (0.45)	104 (70)	4,000 (900)	1,000 (220)	11.5 (4.5)	5.8 (2.3)
12	11.0 (0.43)	90 (60)	4,800 (1080)	1,200 (270)	11.0 (4.3)	5.5 (2.2)
18	13.5 (0.53)	141 (95)	7,200 (1620)	1,800 (400)	13.5 (5.3)	6.8 (2.7)
24	14.5 (0.57)	155 (104)	9,600 (2160)	2,400 (540)	14.5 (5.7)	7.3 (2.9)

### B-Series Breakout Mil-Tac Cables (G Jacket)

FIBER COUNT	DIAMETER MM (IN)	WEIGHT KG/KM (LBS/1,000')	TENSILE LOAD		MINIMUM BEND RADIUS	
			INSTALLATION N (LBS)	OPERATIONAL N (LBS)	INSTALLATION CM (IN)	LONG-TERM CM (IN)
2	6.5 (0.26)	38 (26)	2,200 (490)	550 (120)	6.5 (2.6)	3.3 (1.3)
4	7.5 (0.30)	48 (32)	2,200 (490)	550 (120)	7.5 (3.0)	3.8 (1.5)
6	8.5 (0.33)	56 (38)	2,400 (540)	600 (130)	8.5 (3.3)	4.3 (1.7)
8	10.0 (0.39)	78 (52)	3,200 (720)	800 (180)	10.0 (3.9)	5.0 (2.0)
10	11.5 (0.45)	102 (69)	4,000 (900)	1,000 (220)	11.5 (4.5)	5.8 (2.3)
12	11.0 (0.43)	89 (60)	4,800 (1080)	1,200 (270)	11.0 (4.3)	5.5 (2.2)
18	13.5 (0.53)	138 (93)	7,200 (1620)	1,800 (400)	13.5 (5.3)	6.8 (2.7)
24	14.5 (0.57)	153 (103)	9,600 (2160)	2,400 (540)	14.5 (5.7)	7.3 (2.9)

"Mil-Tac" designated and tested cables available to 24 fibers. Other fiber counts available with polyurethane outer jacket. Installation loads in excess of 2,700 N (600 lbs.) are not recommended.





## (5.2e) B-Series Breakout – Mil-Tac Cables

## Ordering Information

	<b>B</b>	<b>-</b>								<b>5</b>	<b>K</b>	<b>M</b>
<b>Digit No:</b>	<b>1</b>	<b>2</b>	<b>3</b>	<b>4</b>	<b>5</b>	<b>6</b>	<b>7</b>	<b>8</b>	<b>9</b>	<b>10</b>	<b>11</b>	<b>12</b>
1 – 2	Mil-Tac Breakout Series Ultra-Fox Plus = <b>B-</b>											
3 – 5	Fiber count: (See Cable Characteristics Chart) = <b>002-024</b>											
6	Jacket type:											
	Tactical Polyurethane = <b>C</b>											
	Low-Smoke Zero-Halogen Polyurethane = <b>G</b>											
	Flame-Retardant Tactical Polyurethane = <b>V</b>											
7 – 9	Fiber type: (see Ultra-Fox Plus Fiber Performance Table, pg. 207)											
	62.5µm multimode = <b>WST</b>											
	50µm multimode = <b>AST</b>											
	Single-mode = <b>SLS</b>											
10	Ultra-Fox Plus fiber with 900µm tight-buffer = <b>5</b>											
11	Jacket color: Black = <b>K</b>											
12	Rating: Mil-Tac Cable Rating = <b>M</b>											

**Example:** 12-fiber Mil-Tac breakout cable using single-mode fiber, Ultra-Fox Plus, black jacket

**B - 0 1 2 C S L S 5 K M**

## (5.2f) B-Series Breakout – Mil-Tac Rodent Deterrent (FRP) Cables

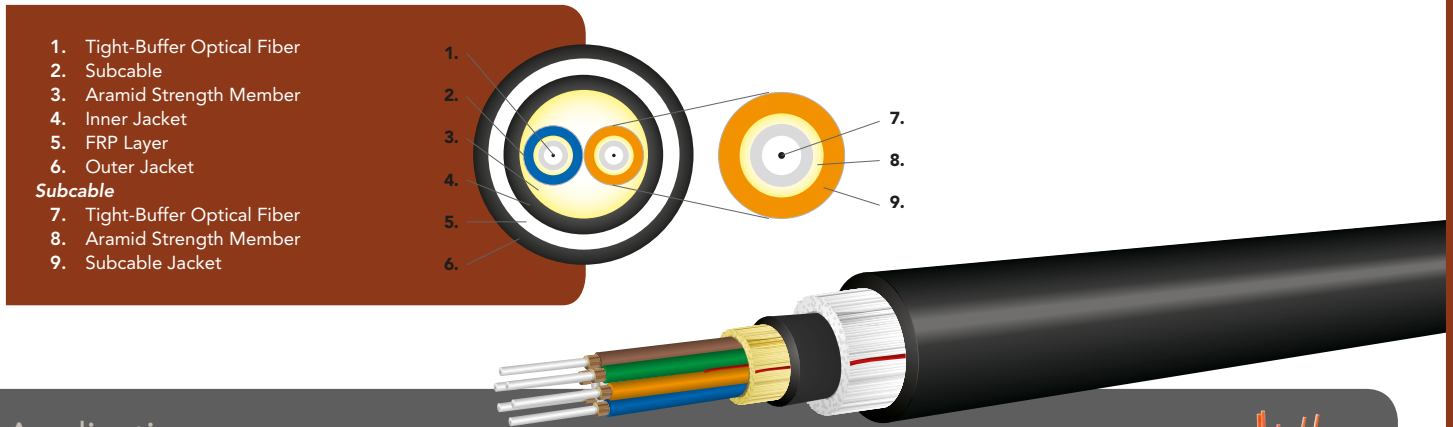

### Applications

- Mil-Tac cable that is ideal for use in harsh environments where deployment and retrieval for reuse are required
- Used in areas susceptible to damage from small non-burrowing rodents

### Features

- Standard OCC B-Series Mil-Tac inner cable with an added layer of fiberglass yarn that provides an effective deterrent to damage caused by small non-burrowing rodents
- Most rugged, high-strength cable design incorporating subcables for direct termination
- Includes a layer of fiberglass yarn that provides an effective deterrent to damage caused by small non-burrowing rodents
- FRP is ideal for use for surface installations (not recommended for direct buried applications)
- Polyurethane jacketed for abrasion, cut and chemical resistance
- Mil-Tac cables can be made in a variety of colors for easy identification or to blend into the environment
- 2 to 24 fibers
- Helically stranded cable core for flexibility, deployment survivability, and excellent mechanical protection for the optical fibers
- Mil-Tac is suitable for use with single, as well as multichannel, connectors
- Excellent crush resistance to withstand crowd and vehicle traffic
- High tensile load rating for quick deployment and retrieval
- Water, fungus and UV resistant for extreme environments
- Outdoor, field-proven cables are easily deployed and retrieved for temporary or long-term military data communication in harsh environments
- Ideally suited for use with MIL-C-38999 style military connectors; subcables terminate to individual pins, and overall aramid strength member terminates to backshell
- 2.0 mm subcables standard
- Standard Polyurethane (C), Flame-Retardant Tactical Polyurethane (V) and Low-Smoke Zero-Halogen (G) jackets are available

### OCC Provided Options:

- Mil-Tac cables prespooled on MARS deployable reels for a ready-to-use product
- Mil-Tac cables can be pre-terminated with single-fiber or ruggedized multichannel connectors upon request

### Mechanical and Environmental Performance

	(TESTED TO MIL PRF 85045 METHODS)
Operating temperature	-55°C to +85°C
Storage temperature	-70°C to +85°C
Impact resistance	1,500 impacts
Crush resistance	2,100 N/cm
Flex resistance	2,000 cycles

### Applicable Standards

OCC Military cables meet or exceed the functional requirements of the following standards

- MIL-PRF-85045/8B ground tactical test methods as applicable
- TIA-455 commercial and military requirements

 (5.2f) B-Series Breakout – Mil-Tac Rodent Deterrent (FRP) Cables

**Cable Characteristics:**  
**B-Series Mil-Tac Rodent Deterrent (FRP) Cables (C Jacket)**

FIBER COUNT	DIAMETER MM (IN)	WEIGHT KG/KM (LBS/1,000')	TENSILE LOAD		MINIMUM BEND RADIUS	
			INSTALLATION N (LBS)	OPERATIONAL N (LBS)	INSTALLATION CM (IN)	LONG-TERM CM (IN)
2	12.4 (0.49)	137 (92)	2,200 (490)	550 (120)	18.6 (7.3)	12.4 (4.9)
4	12.4 (0.49)	138 (93)	2,200 (490)	550 (120)	18.6 (7.3)	12.4 (4.9)
6	13.2 (0.52)	150 (101)	2,400 (540)	600 (130)	19.8 (7.8)	13.2 (5.2)
8	14.7 (0.58)	180 (121)	3,200 (720)	800 (180)	22.1 (8.7)	14.7 (5.8)
10	16.4 (0.65)	222 (149)	4,000 (900)	1,000 (220)	24.6 (9.7)	16.4 (6.5)
12	15.6 (0.61)	196 (132)	4,800 (1,080)	1,200 (270)	23.4 (9.2)	15.6 (6.1)
18	18.2 (0.72)	267 (179)	7,200 (1,620)	1,800 (400)	27.3 (10.7)	18.2 (7.2)
24	19.2 (0.76)	290 (195)	9,600 (2,160)	2,400 (540)	28.8 (11.3)	19.2 (7.6)

**B-Series Mil-Tac Rodent Deterrent (FRP) Cables (V Jacket)**

FIBER COUNT	DIAMETER MM (IN)	WEIGHT KG/KM (LBS/1,000')	TENSILE LOAD		MINIMUM BEND RADIUS	
			INSTALLATION N (LBS)	OPERATIONAL N (LBS)	INSTALLATION CM (IN)	LONG-TERM CM (IN)
2	11.6 (0.46)	128 (86)	2,200 (490)	550 (120)	17.4 (6.9)	11.6 (4.6)
4	11.6 (0.46)	130 (87)	2,200 (490)	550 (120)	17.4 (6.9)	11.6 (4.6)
6	12.5 (0.49)	144 (97)	2,400 (540)	600 (130)	18.8 (7.4)	12.5 (4.9)
8	12.9 (0.51)	173 (116)	3,200 (720)	800 (180)	19.4 (7.6)	12.9 (5.1)
10	15.4 (0.61)	213 (143)	4,000 (900)	1,000 (220)	23.1 (9.1)	15.4 (6.1)
12	14.7 (0.58)	191 (128)	4,800 (1,080)	1,200 (270)	22.1 (8.7)	14.7 (5.8)
18	17.2 (0.68)	263 (177)	7,200 (1,620)	1,800 (400)	25.8 (10.2)	17.2 (6.8)
24	18.2 (0.72)	287 (193)	9,600 (2,160)	2,400 (540)	27.3 (10.7)	18.2 (7.2)

**B-Series Mil-Tac Rodent Deterrent (FRP) Cables (G Jacket)**

FIBER COUNT	DIAMETER MM (IN)	WEIGHT KG/KM (LBS/1,000')	TENSILE LOAD		MINIMUM BEND RADIUS	
			INSTALLATION N (LBS)	OPERATIONAL N (LBS)	INSTALLATION CM (IN)	LONG-TERM CM (IN)
2	11.6 (0.46)	125 (84)	2,200 (490)	550 (120)	17.4 (6.9)	11.6 (4.6)
4	11.6 (0.46)	127 (85)	2,200 (490)	550 (120)	17.4 (6.9)	11.6 (4.6)
6	12.5 (0.49)	141 (95)	2,400 (540)	600 (130)	18.8 (7.4)	12.5 (4.9)
8	12.9 (0.51)	145 (97)	3,200 (720)	800 (180)	19.4 (7.6)	12.9 (5.1)
10	15.4 (0.61)	209 (140)	4,000 (900)	1,000 (220)	23.1 (9.1)	15.4 (6.1)
12	14.7 (0.58)	187 (126)	4,800 (1,080)	1,200 (270)	22.1 (8.7)	14.7 (5.8)
18	17.2 (0.68)	258 (173)	7,200 (1,620)	1,800 (400)	25.8 (10.2)	17.2 (6.8)
24	18.2 (0.72)	282 (189)	9,600 (2,160)	2,400 (540)	27.3 (10.7)	18.2 (7.2)

"Mil-Tac" designated and tested cables available to 24 fibers.  
 Other fiber counts available with polyurethane outer jacket  
 Installation loads in excess of 2,700N (600lbs.) are not recommended

## (5.2f) B-Series Breakout – Mil-Tac Rodent Deterrent (FRP) Cables



### Ordering Information

	B	-								5	K	M	F	
<b>Digit No:</b>	1	2	3	4	5	6	7	8	9	10	11	12	13	14
1 – 2	Mil-Tac Breakout Series Ultra-Fox Plus= <b>B-</b>													
3 – 5	Fiber count: (See Cable Characteristics Chart) = <b>002-024</b>													
6	Jacket type:													
	Tactical Polyurethane = <b>C</b>													
	Low-Smoke Zero-Halogen Polyurethane = <b>G</b>													
	Flame-Retardant Tactical Polyurethane = <b>V</b>													
7 – 9	Fiber type: (see Ultra-Fox Plus Fiber Performance Table, pg. 207)													
10	Ultra-Fox Plus fiber with 900µm tight-buffer = <b>5</b>													
11	Jacket color: Black = <b>K</b>													
12	Rating: Mil Tac Cable Rating = <b>M</b>													
13	FRP Layer = <b>F</b>													
14	Outer jacket:													
	C jacket = <b>9</b>													
	G jacket = <b>B</b>													
	V jacket = <b>8</b>													

**Example:** 12-fiber Mil-Tac Breakout cable with C jacket using single-mode fiber, Ultra-Fox Plus, black jacket with FRP

B	-	0	1	2	C	S	L	S	5	K	M	F	9
---	---	---	---	---	---	---	---	---	---	---	---	---	---

## (5.3a) D-Series Distribution – Field Broadcast Cables

1. Tight-Buffer Optical Fiber
2. Aramid Strength Member
3. Outer Jacket

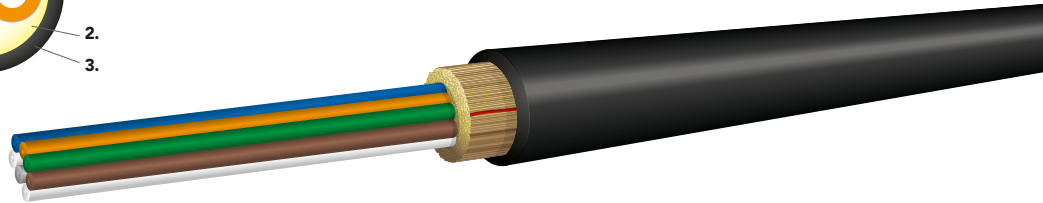
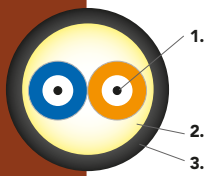

### Applications

- Deployable cable that is ideal for use in harsh environments where deployment and retrieval for reuse are required

### Features

- Extremely strong, lightweight, rugged, survivable tight-buffered cables designed for broadcast field use and commercial applications
- Compact, round cable design for ease of transportation and deployment
- Core-Locked™ jacket for improved mechanical performance
- Designed for use in adverse environments where reduced size and weight are important
- Helically stranded cable core for flexibility, deployment survivability and exceptional mechanical protection for the optical fibers
- Cables have been tested and are in use in broadcast data communications applications worldwide
- Can be used outdoors for temporary deployment directly on the ground in all terrains, including severe environments
- Suitable for industrial, mining and petrochemical environments; chemical resistant
- Crush resistant and resilient with a thick layer of aramid strength members
- Polyurethane jacketed for abrasion, cut and chemical resistance
- Most commonly used with ruggedized multiway military tactical field connectors, for maximum connector retention (400lbs.)
- Tactical Polyurethane (C) outer jacket material is standard; Flame-Retardant Tactical (V) and Low-Smoke Zero-Halogen (G) outer jacket materials are available

### OCC Provided Options

- Broadcast cables pre-spooled on deployable reels for a ready-to-use product
- Broadcast cables can be pre-terminated with single-fiber or ruggedized multichannel connectors upon request

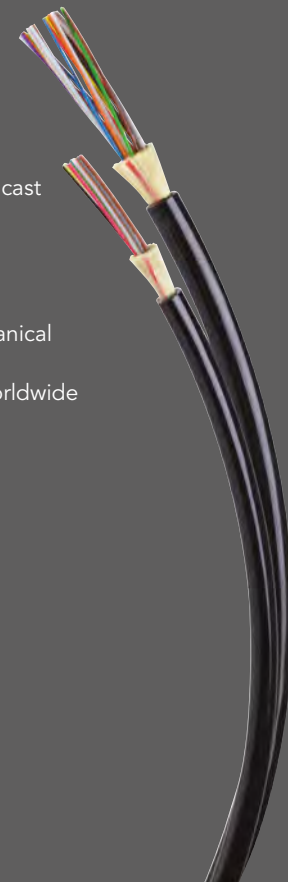

## Mechanical and Environmental Performance

	(TESTED TO MIL PRF 85045 METHODS)
Operating temperature	-40°C to +85°C
Storage temperature	-70°C to +85°C
Crush resistance (TIA-455-41)	1,800 N/cm
Flex resistance (TIA-455-104)	2,000 cycles

## (5.3a) D-Series Distribution – Field Broadcast Cables

### Cable Characteristics: D-Series Distribution Field Broadcast Cables (C Jacket)

FIBER COUNT	DIAMETER MM (IN)	WEIGHT KG/KM (LBS/1,000')	TENSILE LOAD		MINIMUM BEND RADIUS INSTALLATION CM (IN)	MINIMUM BEND RADIUS LONG-TERM CM (IN)
			INSTALLATION N (LBS)	OPERATIONAL N (LBS)		
2	5.0 (0.20)	21 (14)	1,800 (400)	600 (130)	5.0 (2.0)	2.5 (1.0)
4	5.5 (0.22)	27 (18)	1,800 (400)	600 (130)	5.5 (2.2)	2.8 (1.1)
6	6.0 (0.24)	32 (22)	1,800 (400)	600 (130)	6.0 (2.4)	3.0 (1.2)
8	6.5 (0.26)	37 (25)	1,800 (400)	600 (130)	6.5 (2.6)	3.3 (1.3)
10	6.5 (0.26)	38 (26)	2,100 (470)	700 (160)	6.5 (2.6)	3.3 (1.3)
12	6.5 (0.26)	41 (28)	2,100 (470)	700 (160)	6.5 (2.6)	3.3 (1.3)
18	7.5 (0.30)	48 (32)	2,400 (540)	800 (180)	7.5 (3.0)	3.8 (1.5)
24	8.5 (0.33)	60 (40)	3,000 (670)	1,000 (220)	8.5 (3.3)	4.3 (1.7)

### D-Series Distribution Field Broadcast Cables (V Jacket)

FIBER COUNT	DIAMETER MM (IN)	WEIGHT KG/KM (LBS/1,000')	TENSILE LOAD		MINIMUM BEND RADIUS INSTALLATION CM (IN)	MINIMUM BEND RADIUS LONG-TERM CM (IN)
			INSTALLATION N (LBS)	OPERATIONAL N (LBS)		
2	5.0 (0.20)	24 (16)	1,800 (400)	600 (130)	5.0 (2.0)	2.5 (1.0)
4	5.5 (0.22)	29 (19)	1,800 (400)	600 (130)	5.5 (2.2)	2.8 (1.1)
6	6.0 (0.24)	34 (23)	1,800 (400)	600 (130)	6.0 (2.4)	3.0 (1.2)
8	6.5 (0.26)	39 (26)	1,800 (400)	600 (130)	6.5 (2.6)	3.3 (1.3)
10	6.5 (0.26)	40 (27)	2,100 (470)	700 (160)	6.5 (2.6)	3.3 (1.3)
12	6.5 (0.26)	43 (29)	2,100 (470)	700 (160)	6.5 (2.6)	3.3 (1.3)
18	7.5 (0.30)	51 (34)	2,400 (540)	800 (180)	7.5 (3.0)	3.8 (1.5)
24	8.5 (0.33)	63 (42)	3,000 (670)	1,000 (220)	8.5 (3.3)	4.3 (1.7)

### D-Series Distribution Field Broadcast Cables (G Jacket)

FIBER COUNT	DIAMETER MM (IN)	WEIGHT KG/KM (LBS/1,000')	TENSILE LOAD		MINIMUM BEND RADIUS INSTALLATION CM (IN)	MINIMUM BEND RADIUS LONG-TERM CM (IN)
			INSTALLATION N (LBS)	OPERATIONAL N (LBS)		
2	5.0 (0.20)	22 (15)	1,800 (400)	600 (130)	5.0 (2.0)	2.5 (1.0)
4	5.5 (0.22)	28 (19)	1,800 (400)	600 (130)	5.5 (2.2)	2.8 (1.1)
6	6.0 (0.24)	33 (22)	1,800 (400)	600 (130)	6.0 (2.4)	3.0 (1.2)
8	6.5 (0.26)	38 (26)	1,800 (400)	600 (130)	6.5 (2.6)	3.3 (1.3)
10	6.5 (0.26)	39 (26)	2,100 (470)	700 (160)	6.5 (2.6)	3.3 (1.3)
12	6.5 (0.26)	42 (28)	2,100 (470)	700 (160)	6.5 (2.6)	3.3 (1.3)
18	7.5 (0.30)	49 (33)	2,400 (540)	800 (180)	7.5 (3.0)	3.8 (1.5)
24	8.5 (0.33)	62 (42)	3,000 (670)	1,000 (220)	8.5 (3.3)	4.3 (1.7)





## (5.3a) D-Series Distribution – Field Broadcast Cables

## Ordering Information

	D	X							9	K	B	
Digit No:	1	2	3	4	5	6	7	8	9	10	11	12
1 – 2	Distribution Series Ultra-Fox = <b>DX</b>											
3 – 5	Fiber count: (see cable characteristics chart) = <b>002-024</b>											
6	Jacket type:											
	Tactical Polyurethane = <b>C</b>											
	Low-Smoke Zero-Halogen Polyurethane = <b>G</b>											
	Flame-Retardant Tactical Polyurethane = <b>V</b>											
7 – 9	Fiber type: (see Laser Ultra-Fox Fiber Performance Table, pg. 206)											
10	Ultra-Fox Fiber with 900µm tight buffer = <b>9</b>											
11	Jacket color: Black = <b>K</b>											
12	Rating: Field Broadcast Cable = <b>B</b>											

**Example:** 12-fiber distribution cable using bend-insensitive low water peak single-mode fiber, black jacket

**D X 0 1 2 C S L A 9 K B**

## (5.3b) D-Series Distribution – Field Broadcast Rodent Deterrent (FRP) Cables



1. Central Filler/Strength Member
2. Tight-Buffer Optical Fiber
3. Aramid Strength Member
4. Inner Jacket
5. FRP Layer
6. Outer Jacket
7. Ripcords

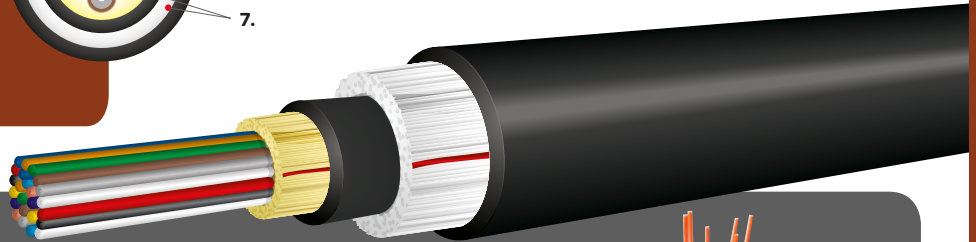
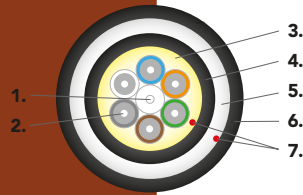

### Applications

- Deployable cable that is ideal for use in harsh environments where deployment and retrieval for reuse are required for temporary broadcast networks
- Used in areas susceptible to damage from small non-burrowing rodents

### Features

- Includes a layer of fiberglass yarn that provides an effective deterrent to damage caused by small non-burrowing rodents
- FRP is ideal for use for surface installations (not recommended for direct burial applications)
- Broadcast cables made in a variety of colors for easy identification or to blend into the environment
- 2 to 24 fibers, higher fiber counts are available on request
- Helically stranded cable core for flexibility, deployment survivability, and excellent mechanical protection for the optical fibers
- Cables are suitable for use with single, as well as multichannel, connectors
- Excellent crush resistance to withstand crowd and vehicle traffic
- High tensile load rating for quick deployment and retrieval
- Water, fungus and UV resistant for extreme environments
- Outdoor, field-proven cables are easily deployed and retrieved for remote news gatherings and sporting events
- Standard Polyurethane (C), Flame-Retardant Tactical Polyurethane (V) and Low-Smoke Zero-Halogen (G) jackets are available

### OCC Provided Options

- Broadcast cables pre-spooled on deployable reels for a ready-to-use product
- Broadcast cables can be pre-terminated with single fiber or ruggedized multi-channel connectors upon request



### Mechanical and Environmental Performance

	BASED ON INNER CABLE PERFORMANCE
Operating temperature	-40°C to +85°C
Storage temperature	-70°C to +85°C
Crush resistance (TIA-455-41)	1,800 N/cm
Flex resistance (TIA-455-104)	2,000 cycles



## (5.3b) D-Series Distribution – Field Broadcast Rodent Deterrent (FRP) Cables

### Cable Characteristics: D-Series Field Broadcast Rodent Deterrent (FRP) Cables (C Jacket)

FIBER COUNT	DIAMETER MM (IN)	WEIGHT KG/KM (LBS/1,000')	TENSILE LOAD		MINIMUM BEND RADIUS	
			INSTALLATION N (LBS)	OPERATIONAL N (LBS)	INSTALLATION CM (IN)	LONG-TERM CM (IN)
2	10.7 (0.42)	104 (70)	1,800 (400)	600 (130)	16.1 (6.3)	10.7 (4.2)
4	10.7 (0.42)	104 (70)	1,800 (400)	600 (130)	16.1 (6.3)	10.7 (4.2)
6	10.7 (0.42)	104 (70)	1,800 (400)	600 (130)	16.1 (6.3)	10.7 (4.2)
8	11.6 (0.46)	123 (83)	1,800 (400)	600 (130)	17.4 (6.9)	11.6 (4.6)
10	11.6 (0.46)	125 (84)	2,100 (470)	700 (160)	17.4 (6.9)	11.6 (4.6)
12	12.7 (0.50)	145 (97)	2,100 (470)	700 (160)	19.1 (7.5)	12.7 (5.0)
18	12.4 (0.49)	139 (93)	2,400 (540)	800 (180)	18.6 (7.3)	12.4 (4.9)
24	13.2 (0.52)	156 (105)	3,000 (670)	1,000 (220)	19.8 (7.8)	13.2 (5.2)

### D-Series Field Broadcast Rodent Deterrent (FRP) Cables (V Jacket)

FIBER COUNT	DIAMETER MM (IN)	WEIGHT KG/KM (LBS/1,000')	TENSILE LOAD		MINIMUM BEND RADIUS	
			INSTALLATION N (LBS)	OPERATIONAL N (LBS)	INSTALLATION CM (IN)	LONG-TERM CM (IN)
2	10 (0.39)	101 (68)	1,800 (400)	600 (130)	15.0 (5.9)	10.0 (3.9)
4	10 (0.39)	101 (68)	1,800 (400)	600 (130)	15.0 (5.9)	10.0 (3.9)
6	10 (0.39)	101 (68)	1,800 (400)	600 (130)	15.0 (5.9)	10.0 (3.9)
8	10.8 (0.43)	118 (79)	1,800 (400)	600 (130)	16.2 (6.4)	10.8 (4.3)
10	10.8 (0.43)	119 (80)	2,100 (470)	700 (160)	16.2 (6.4)	10.8 (4.3)
12	11.9 (0.47)	140 (94)	2,100 (470)	700 (160)	17.9 (7.0)	11.9 (4.7)
18	11.6 (0.46)	138 (93)	2,400 (540)	800 (180)	17.4 (6.9)	11.6 (4.6)
24	12.5 (0.49)	159 (107)	3,000 (670)	1,000 (220)	18.8 (7.4)	12.5 (4.9)

### D-Series Field Broadcast Rodent Deterrent (FRP) Cables (G Jacket)

FIBER COUNT	DIAMETER MM (IN)	WEIGHT KG/KM (LBS/1,000')	TENSILE LOAD		MINIMUM BEND RADIUS	
			INSTALLATION N (LBS)	OPERATIONAL N (LBS)	INSTALLATION CM (IN)	LONG-TERM CM (IN)
2	10 (0.39)	98 (66)	1,800 (400)	600 (130)	15.0 (5.9)	10.0 (3.9)
4	10 (0.39)	98 (66)	1,800 (400)	600 (130)	15.0 (5.9)	10.0 (3.9)
6	10 (0.39)	98 (66)	1,800 (400)	600 (130)	15.0 (5.9)	10.0 (3.9)
8	10.8 (0.43)	115 (77)	1,800 (400)	600 (130)	16.2 (6.4)	10.8 (4.3)
10	10.8 (0.43)	117 (79)	2,100 (470)	700 (160)	16.2 (6.4)	10.8 (4.3)
12	11.9 (0.47)	137 (92)	2,100 (470)	700 (160)	17.9 (7.0)	11.9 (4.7)
18	11.6 (0.46)	135 (91)	2,400 (540)	800 (180)	17.4 (6.9)	11.6 (4.6)
24	12.5 (0.49)	155 (104)	3,000 (670)	1,000 (220)	18.8 (7.4)	12.5 (4.9)

Installation loads in excess of 2,700N (600lbs.) are not recommended.

## (5.3b) D-Series Distribution – Field Broadcast Rodent Deterrent (FRP) Cables



### Ordering Information

	D	X								9	K	B	F	
Digit No:	1	2	3	4	5	6	7	8	9	10	11	12	13	14
1 – 2	Distribution Series Ultra-Fox = <b>DX</b>													
3 – 5	Fiber count: (see cable characteristics chart) = <b>002-024</b>													
6	Inner jacket type:													
	Tactical Polyurethane = <b>C</b>													
	Low-Smoke Zero-Halogen Polyurethane = <b>G</b>													
	Flame-Retardant Tactical Polyurethane = <b>V</b>													
7 – 9	Fiber type: (see Laser Ultra-Fox Fiber Performance Table, pg. 206)													
10	Ultra-Fox fiber with 900µm tight buffer = <b>9</b>													
11	Jacket color: Black = <b>K</b>													
12	Rating: Field Broadcast Cable Rating = <b>B</b>													
13	FRP Layer = <b>F</b>													
14	Outer jacket:													
	C jacket = <b>9</b>													
	G jacket = <b>B</b>													
	V jacket = <b>8</b>													

**Example:** 12-fiber field broadcast distribution cable with C jacket using 62.5µm Laser Ultra-Fox fiber, black jacket, FRP rodent deterrence

D	X	0	1	2	C	W	L	S	9	K	B	F	9
---	---	---	---	---	---	---	---	---	---	---	---	---	---

## (5.3c) B-Series Breakout – Field Broadcast Cables

- 1. Tight-Buffer Optical Fiber
  - 2. Subcable
  - 3. Aramid Strength Member
  - 4. Outer Jacket
- Subcable**
- 5. Tight-Buffer Optical Fiber
  - 6. Aramid Strength Member
  - 7. Subcable Jacket

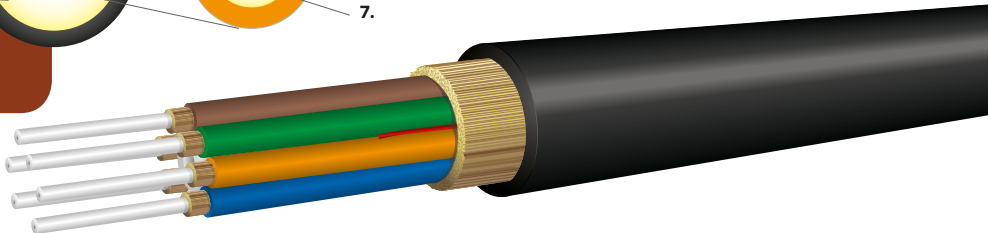
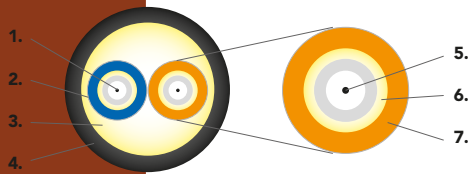

### Application

- Deployable cable that is ideal for use in harsh environments where deployment and retrieval for reuse are required for temporary broadcast networks

### Features

- Extremely strong, lightweight, rugged, survivable tight-buffered cables designed for broadcast field use and commercial applications
- Polyurethane jacketed for abrasion, cut and chemical resistance
- Core-Locked™ jacket for improved mechanical performance
- Breakout cable design with individual color-coded subcables protecting each optical fiber
- Crush resistant and resilient, with two separate layers of aramid strength members in the subcables for individual single-fiber connector and termination pin, and overall for termination to multiway connector backshells or other housings
- Helically stranded cable core for flexibility, deployment survivability and exceptional mechanical protection for the optical fibers
- Cables have been tested and are in use in field broadcast data communications applications worldwide
- Can be used outdoors for temporary deployment directly on the ground, in all terrains, including severe environments
- Suitable for industrial, mining and petrochemical environments; chemical resistant
- Round cable design for easy installation and survivability
- Often used with multiway military tactical connectors for maximum connector retention (400lbs.)
- Ideally suited for use with MIL-C-38999 style military connectors; subcables terminate to individual pins, and overall aramid strength member terminates to backshell
- 2.0mm subcables standard
- Tactical Polyurethane (C) outer jacket material is standard. Flame-Retardant Tactical (V) and Low-Smoke Zero-Halogen (G) outer jacket materials are available



### Mechanical and Environmental Performance

	(TESTED TO MIL PRF 85045 METHODS)
Operating temperature	-40°C to +85°C
Storage temperature	-70°C to +85°C
Crush resistance (TIA-455-41)	2,100 N/cm
Flex resistance (TIA-455-104)	2,000 cycles

## (5.3c) B-Series Breakout – Field Broadcast Cables



### Cable Characteristics: B-Series Breakout Field Broadcast Cables

FIBER COUNT	DIAMETER MM (IN)	WEIGHT KG/KM (LBS/1,000')	TENSILE LOAD		MINIMUM BEND RADIUS	
			INSTALLATION N (LBS)	OPERATIONAL N (LBS)	INSTALLATION CM (IN)	LONG-TERM CM (IN)
2	6.5 (0.26)	36 (24)	2,200 (490)	550 (120)	10.4 (4.1)	5.2 (2.0)
4	7.5 (0.30)	47 (32)	2,200 (490)	550 (120)	12.0 (4.7)	6.0 (2.4)
6	8.5 (0.33)	56 (37)	2,400 (540)	600 (130)	13.6 (5.4)	6.8 (2.7)
8	10.0 (0.39)	75 (51)	3,200 (720)	800 (180)	16.0 (6.3)	8.0 (3.1)
10	11.5 (0.45)	100 (67)	4,000 (900)	1,000 (220)	18.4 (7.2)	9.2 (3.6)
12	11.0 (0.43)	88 (59)	4,800 (1,080)	1,200 (270)	17.6 (6.9)	8.8 (3.5)
18	13.5 (0.53)	138 (93)	7,200 (1,620)	1,800 (400)	21.6 (8.5)	10.8 (4.3)
24	14.5 (0.57)	150 (101)	9,600 (2,160)	2,400 (540)	23.2 (9.1)	11.6 (4.6)

Other fiber counts available with polyurethane outer jacket.  
Installation loads in excess of 2,700 N (600 lbs.) are not recommended.

### Ordering Information

	B	X							9	K	B	
Digit No:	1	2	3	4	5	6	7	8	9	10	11	12
1 – 2	Field Broadcast Breakout Series Ultra-Fox = <b>BX</b>											
3 – 5	Fiber count: (see cable characteristics chart) = <b>002-024</b>											
6	Jacket type:											
	Tactical Polyurethane = <b>C</b>											
	Low-Smoke Zero-Halogen Polyurethane = <b>G</b>											
	Tactical Flame-Retardant Polyurethane = <b>V</b>											
7 – 9	Fiber type: (see Laser Ultra-Fox Fiber Performance Table, pg. 206)											
10	Ultra-Fox fiber with 900µm tight buffer = <b>9</b>											
11	Jacket color: Black = <b>K</b>											
12	Rating: Field Broadcast Cable = <b>B</b>											

**Example:** 12-fiber field broadcast breakout cable using single-mode fiber, Ultra-Fox, black jacket

B	X	0	1	2	C	S	L	X	9	K	B
---	---	---	---	---	---	---	---	---	---	---	---





## (5.3d) B-Series Breakout – Field Broadcast Rodent Deterrent (FRP) Cables

- 1. Tight-Buffer Optical Fiber
  - 2. Subcable
  - 3. Aramid Strength Member
  - 4. Inner Jacket
  - 5. FRP Layer
  - 6. Outer Jacket
- Subcable**
- 7. Tight-Buffer Optical Fiber
  - 8. Aramid Strength Member
  - 9. Subcable Jacket

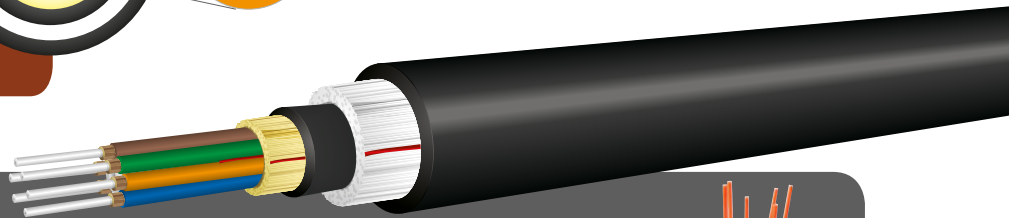
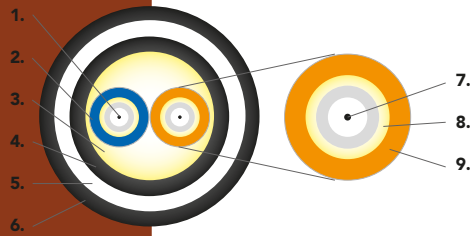

### Applications

- Deployable cable that is ideal for use in harsh environments where deployment and retrieval are required for temporary broadcast networks
- Used in areas susceptible to damage from small non-burrowing rodents

### Features

- Includes a layer of fiberglass yarn that provides an effective deterrent to damage caused by small non-burrowing rodents
- FRP is ideal for use in surface installations (not recommended for direct burial applications)
- Broadcast cables made in a variety of colors for easy identification or to blend into the environment
- Breakout cable design with individual color-coded subcables protecting each optical fiber
- 2.0mm subcables are standard
- 2 to 24 fibers, higher fiber counts are available on request
- Compact, round cable design for ease of transportation and deployment
- Helically stranded cable core for flexibility, deployment survivability, and excellent mechanical protection for the optical fibers
- Cables are suitable for use with single, as well as multichannel, connectors
- Excellent crush resistance to withstand crowd and vehicle traffic
- High tensile load rating for quick deployment and retrieval
- Water, fungus and UV resistant for extreme environments
- Outdoor, field-proven cables are easily deployed and retrieved for remote news gatherings and sporting events
- Standard Polyurethane (C), Flame-Retardant Tactical Polyurethane (V) and Low-Smoke Zero-Halogen (G) jackets are available

### OCC Provided Options

- Broadcast cables pre-spoolled on deployable reels for a ready-to-use product
- Broadcast cables can be pre-terminated with single-fiber or ruggedized multichannel connectors upon request



### Mechanical and Environmental Performance

	BASED ON INNER CABLE PERFORMANCE
Operating temperature	-40°C to +85°C
Storage temperature	-70°C to +85°C
Crush resistance (TIA-455-41)	2,100 N/cm
Flex resistance (TIA-455-104)	2,000 cycles

## (5.3d) B-Series Breakout – Field Broadcast Rodent Deterrent (FRP) Cables



### Cable Characteristics:

#### B-Series Field Broadcast Rodent Deterrent (FRP) Cables (C Jacket)

FIBER COUNT	DIAMETER MM (IN)	WEIGHT KG/KM (LBS/1,000')	TENSILE LOAD		MINIMUM BEND RADIUS	
			INSTALLATION N (LBS)	OPERATIONAL N (LBS)	INSTALLATION CM (IN)	LONG-TERM CM (IN)
2	12.4 (0.49)	137 (92)	2,200 (490)	550 (120)	18.6 (7.3)	12.4 (4.9)
4	12.4 (0.49)	138 (93)	2,200 (490)	550 (120)	18.6 (7.3)	12.4 (4.9)
6	13.2 (0.52)	150 (101)	2,400 (540)	600 (130)	19.8 (7.8)	13.2 (5.2)
8	14.7 (0.58)	180 (121)	3,200 (720)	800 (180)	22.1 (8.7)	14.7 (5.8)
10	16.4 (0.65)	222 (149)	4,000 (900)	1,000 (220)	24.6 (9.7)	16.4 (6.5)
12	15.6 (0.61)	196 (132)	4,800 (1080)	1,200 (270)	23.4 (9.2)	15.6 (6.1)
18	18.2 (0.72)	267 (179)	7,200 (1,620)	1,800 (400)	27.3 (10.7)	18.2 (7.2)
24	19.2 (0.76)	290 (195)	9,600 (2,160)	2,400 (540)	28.8 (11.3)	19.2 (7.6)

#### B-Series Field Broadcast Rodent Deterrent (FRP) Cables (V Jacket)

FIBER COUNT	DIAMETER MM (IN)	WEIGHT KG/KM (LBS/1,000')	TENSILE LOAD		MINIMUM BEND RADIUS	
			INSTALLATION N (LBS)	OPERATIONAL N (LBS)	INSTALLATION CM (IN)	LONG-TERM CM (IN)
2	11.6 (0.46)	128 (86)	2,200 (490)	550 (120)	17.4 (6.9)	11.6 (4.6)
4	11.6 (0.46)	130 (87)	2,200 (490)	550 (120)	17.4 (6.9)	11.6 (4.6)
6	12.5 (0.49)	144 (97)	2,400 (540)	600 (130)	18.8 (7.4)	12.5 (4.9)
8	12.9 (0.51)	173 (116)	3,200 (720)	800 (180)	19.4 (7.6)	12.9 (5.1)
10	15.4 (0.61)	213 (143)	4,000 (900)	1,000 (220)	23.1 (9.1)	15.4 (6.1)
12	14.7 (0.58)	191 (128)	4,800 (1080)	1,200 (270)	22.1 (8.7)	14.7 (5.8)
18	17.2 (0.68)	263 (177)	7,200 (1,620)	1,800 (400)	25.8 (10.2)	17.2 (6.8)
24	18.2 (0.72)	287 (193)	9,600 (2,160)	2,400 (540)	27.3 (10.7)	18.2 (7.2)

#### B-Series Field Broadcast Rodent Deterrent (FRP) Cables (G Jacket)

FIBER COUNT	DIAMETER MM (IN)	WEIGHT KG/KM (LBS/1,000')	TENSILE LOAD		MINIMUM BEND RADIUS	
			INSTALLATION N (LBS)	OPERATIONAL N (LBS)	INSTALLATION CM (IN)	LONG-TERM CM (IN)
2	11.6 (0.46)	125 (84)	2,200 (490)	550 (120)	17.4 (6.9)	11.6 (4.6)
4	11.6 (0.46)	127 (85)	2,200 (490)	550 (120)	17.4 (6.9)	11.6 (4.6)
6	12.5 (0.49)	141 (95)	2,400 (540)	600 (130)	18.8 (7.4)	12.5 (4.9)
8	12.9 (0.51)	145 (97)	3,200 (720)	800 (180)	19.4 (7.6)	12.9 (5.1)
10	15.4 (0.61)	209 (140)	4,000 (900)	1,000 (220)	23.1 (9.1)	15.4 (6.1)
12	14.7 (0.58)	187 (126)	4,800 (1080)	1,200 (270)	22.1 (8.7)	14.7 (5.8)
18	17.2 (0.68)	258 (173)	7,200 (1,620)	1,800 (400)	25.8 (10.2)	17.2 (6.8)
24	18.2 (0.72)	282 (189)	9,600 (2,160)	2,400 (540)	27.3 (10.7)	18.2 (7.2)

Installation loads in excess of 2,700N (600lbs.) are not recommended.



## (5.3d) B-Series Breakout – Field Broadcast Rodent Deterrent (FRP) Cables

### Ordering Information

	B	X							9	K	B	F		
Digit No:	1	2	3	4	5	6	7	8	9	10	11	12	13	14
1 – 2	Breakout Series Ultra-Fox = <b>BX</b>													
3 – 5	Fiber count: (see cable characteristics chart) = <b>002-024</b>													
6	Inner jacket material:													
	Tactical Polyurethane = <b>C</b>													
	Low-Smoke Zero-Halogen Polyurethane = <b>G</b>													
	Tactical Flame-Retardant Polyurethane = <b>V</b>													
7 – 9	Fiber type: (see Ultra-Fox Plus Fiber Performance Table, pg. 207)													
10	250µm fiber with 900µm tight buffer = <b>9</b>													
11	Jacket color: Black = <b>K</b>													
12	Rating: Field Broadcast Cable Rating = <b>B</b>													
13	FRP Layer = <b>F</b>													
14	Outer jacket:													
	C jacket = <b>9</b>													
	G jacket = <b>B</b>													
	V jacket = <b>8</b>													

**Example:** 12-fiber field broadcast breakout cable with C jacket using 62.5µm Laser Ultra-Fox fiber, black jacket with FRP rodent deterrence

**B X 0 1 2 C W L S 9 K B F 9**



### Applications

- Used in outdoor applications that require both optical fiber and copper wire elements for communication and power
- Copper wire can power remote electronics used in fiber optic communications
- Copper wire can also be used for low data rate data transmission
- Deployable cables have been used in network and private broadcast applications around the world
- Cables can be designed for your custom applications
- Cable is designed for use with United States National Electrical Code (NEC) class 2 power sources

### Features

- Includes both fiber optic subunits and copper individually jacketed wire
- Fiber optic subunits both protect the optical fiber and provide aramid yarn to strain relieve the optical fiber when individual connectors are used
- The individual copper wire is rated to 600V
- Up to 4 copper wires are standard
- Standard copper wire used includes high strand count wire for greater cable flexibility
- Standard wire gauges range from 18 to 12 AWG
- Additional aramid yarn included around the cable core for strain-relief in multielement connectors such as F-LINK
- Polyurethane jacket materials provide a rugged jacket and provide flexibility to the cable
- C, V and G jacket materials are available for use
- Polyurethane jackets are chemical resistant
- Water, fungus and UV resistant for extreme environments
- The customer is responsible for ensuring compliance with all local and national safety and electrical code during use
- Appropriate electrical safety protection is required whenever the copper wire is energized

### OCC Provided Options

- Broadcast hybrid deployable cables pre-spooled on reels for a ready-to-use product
- Broadcast cables can be pre-terminated with single-fiber or ruggedized multichannel connectors upon request

### Cable Characteristics: CX-Series Hybrid Fiber/Copper Deployable Cables

- Due to the wide range of constructions possible, call for construction details.

### Ordering Information

- Please call for part numbers. Call 1-800-622-7711 and ask for a Sales Representative. We're ready to assist you.

Consistent with the definition in TIA-440-B "Fiber Optic Terminology," hybrid cable is defined as a cable containing both optical fibers and electrical conductors. Composite cable is defined as a cable containing mixed fiber types. Prior to 2012 some U.S. standards documents use definitions for hybrid and composite which are opposite of those stated here. The change in convention was made in the interest of harmonization with International standards and other National standards.

## (5.3f) SMPTE Essential Cables

1. 20 AWG Copper Conductor (x4)
2. Cotton Filler
3. 24 AWG Copper Conductor (x2)
4. Single-mode Fiber Optic Cable (x2)
5. Tinned Copper Shield, 98% Coverage
6. TPE Outer Jacket
7. Central Steel Strength Member
8. Nylon Tape Wrap, 100% Coverage

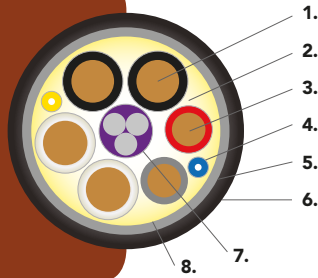

SMPTE® Essential  
Part Number: CX008HBAA9KB

CONDUCTORS	
	20 AWG 19 Strand Class C Annealed Tinned Copper PE Insulated
1	Black
2	Black/White
3	White/Black
4	White
	24 AWG 7 Strand Class B Annealed Tinned Copper PE Insulated
5	Red
6	Gray

### Applications

- OCC's Essential Cable is a standard SMPTE 311 compliant cable perfect for indoor and outdoor HD camera connectivity and broadcasting deployment
- Available in bulk cable or pre-terminated assembly with SMPTE 304 connectors for quick and easy Plug-and-Play installations

### Features

- Budget friendliness without compromising performance and durability
- Standard 245 micron acrylate fiber with full SMPTE 311 compliance
- OCC's outstanding customer service, broad assembly offerings, and dedicated repair and restoration that make OCC SMPTE the prime product in the Broadcast market today
- Available in custom lengths

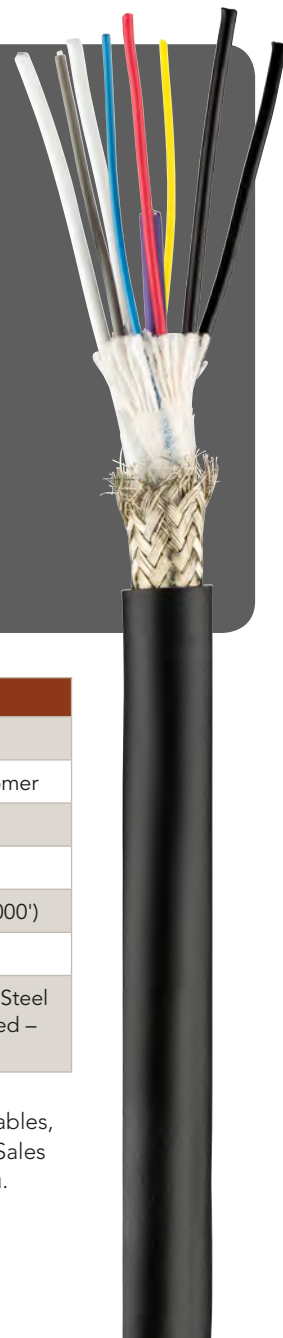

ULTRA-FOX PLUS FIBER PERFORMANCE	
Fiber code/count	SLA/2
Industry standard designation	Bend-insensitive Single-mode ITU-T G.657.A1 ITU-T G.652.D (Yellow and Blue)
Core/cladding diameter (µm)	9/125
Wavelength (nm)	1310/1550
Maximum cable attenuation (dB/km)	0.5/0.5
Primary coating diameter (µm)	245
Secondary buffer diameter (µm)	900
Zero dispersion slope (ps/nm <sup>2</sup> -km)	0.092
Proof test level (kpsi)	100

CABLE CHARACTERISTICS	
Jacket Color	Black
Jacket Material	Thermoplastic Elastomer
Buffer material	Hard Elastomer
Subunit OD	0.9 mm
Cable Weight	144 kg/km (97 lbs/1000')
Cable Diameter	9.2 mm (0.36 in)
Strength Member	16 AWG Galvanized Steel Polyurethane Insulated – Purple

For inquiries or to order OCC's SMPTE cables, please call 1-800-622-7711 and ask for a Sales Representative. We're ready to assist you.

## (5.3g) SMPTE Premium Cables

1. 20 AWG Copper Conductor (x4)
2. Cotton Filler
3. 24 AWG Copper Conductor (x2)
4. Single-mode Fiber Optic Cable (x2)
5. Tinned Copper Shield, 98% Coverage
6. TPE Outer Jacket
7. Central Steel Strength Member
8. Nylon Tape Wrap, 100% Coverage

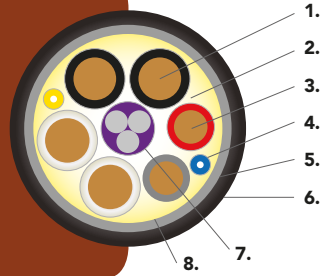

SMPTE® Premium  
Part #: C-008HBAA5KB

CONDUCTORS	
	20 AWG 19 Strand Class C Annealed Tinned Copper PE Insulated
1	Black
2	Black/White
3	White/Black
4	White
	24 AWG 7 Strand Class B Annealed Tinned Copper PE Insulated
5	Red
6	Gray

### Applications

- OCC's Premium SMPTE 311 compliant cable is ideal for regular broadcasting deployments and HD applications
- Unlike many SMPTE 311 cables, 500 micron acrylate coating is used for maximum protection of the single-mode core and cladding, lending additional protection to that available with OCC's SMPTE Essential cable — this added protection makes SMPTE Premium a perfect solution for most any broadcast venue.
- Available in bulk cable or pre-terminated assembly with SMPTE 304 connectors for quick and easy Plug-and-Play installations

### Features

- Maximum fiber protection using 500 micron acrylate coating; many manufacturers do not offer this feature, but OCC does
- Versatile broadcast uses and deployments
- OCC's outstanding customer service, broad assembly offerings, and dedicated repair and restoration make OCC SMPTE the prime product in the Broadcast market today
- Full SMPTE 311 compliance
- Available in custom lengths

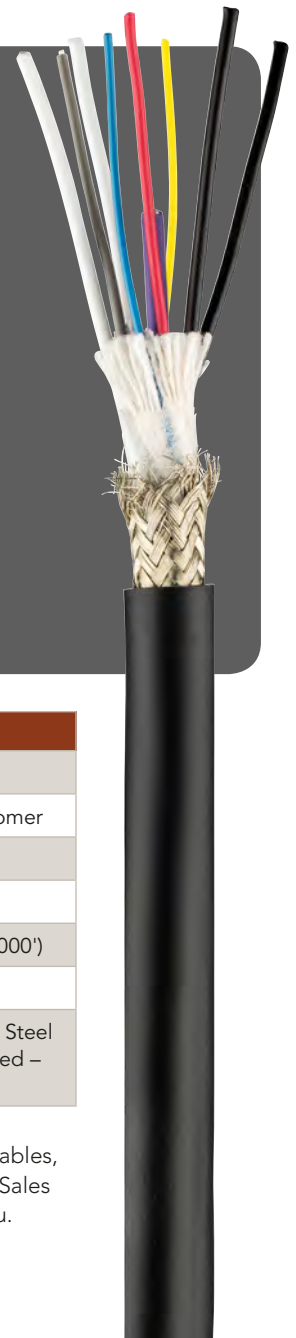

ULTRA-FOX PLUS FIBER PERFORMANCE	
Fiber code/count	SLA/2
Industry standard designation	Bend-insensitive Single-mode ITU-T G.657.A1 ITU-T G.652.D (Yellow and Blue)
Core/cladding diameter (µm)	9/125
Wavelength (nm)	1310/1550
Maximum cable attenuation (dB/km)	0.5/0.5
Primary coating diameter (µm)	500
Secondary buffer diameter (µm)	900
Zero dispersion slope (ps/nm <sup>2</sup> -km)	0.092
Proof test level (kpsi)	100

CABLE CHARACTERISTICS	
Jacket Color	Black
Jacket Material	Thermoplastic Elastomer
Buffer material	Hard Elastomer
Subunit OD	0.9 mm
Cable Weight	144 kg/km (97 lbs/1000')
Cable Diameter	9.2 mm (0.36 in)
Strength Member	16 AWG Galvanized Steel Polyurethane Insulated – Purple

For inquiries or to order OCC's SMPTE cables, please call 1-800-622-7711 and ask for a Sales Representative. We're ready to assist you.



## (5.3h) SMPTE Tactical Cables

1. 20 AWG Copper Conductor (x4)
2. Cotton Filler
3. 24 AWG Copper Conductor (x2)
4. Single-mode Fiber Optic Cable (x2)
5. Tinned Copper Shield, 98% Coverage
6. TPE Outer Jacket
7. Central Steel Strength Member
8. Nylon Tape Wrap, 100% Coverage

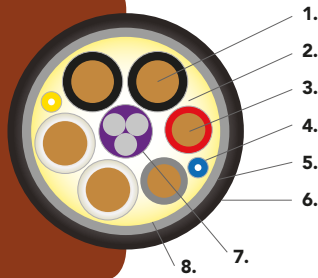

SMPTE® Tactical  
Part #: C-008HBAA5KM

CONDUCTORS	
	20 AWG 19 Strand Class C Annealed Tinned Copper PE Insulated
1	Black
2	Black/White
3	White/Black
4	White
	24 AWG 7 Strand Class B Annealed Tinned Copper PE Insulated
5	Red
6	Gray

### Applications

- OCC's Tactical SMPTE 311 compliant cable offers extra durability with its polyurethane jacket for the most harsh broadcasting environments and venues
- Unlike many SMPTE 311 cables in the market, OCC's polyurethane jacket is less sticky, simpler to coil, and causes less friction for easy installations and reliable HD signal transmission
- Available in bulk cable or pre-terminated assembly with SMPTE 304 connectors for quick and easy Plug-and-Play installations

### Features

- Rugged combination of 500 micron acrylate fiber plus a cut-resistant/wear-resistant polyurethane jacket
- Ideal for harsh deployable broadcast applications
- Full SMPTE 311 compliance
- Available in custom lengths
- OCC's outstanding customer service, broad assembly offerings, and dedicated repair and restoration make OCC SMPTE the prime product in the Broadcast market today



ULTRA-FOX PLUS FIBER PERFORMANCE	
Fiber code/count	SLA/2
Industry standard designation	Bend-insensitive Single-mode ITU-T G.657.A1 ITU-T G.652.D (Yellow and Blue)
Core/cladding diameter (µm)	9/125
Wavelength (nm)	1310/1550
Maximum cable attenuation (dB/km)	0.5/0.5
Primary coating diameter (µm)	500
Secondary buffer diameter (µm)	900
Zero dispersion slope (ps/nm <sup>2</sup> -km)	0.092
Proof test level (kpsi)	100

CABLE CHARACTERISTICS	
Jacket Color	Black
Jacket Material	Polyurethane
Buffer material	Hard Elastomer
Subunit OD	0.9 mm
Cable Weight	144 kg/km (97 lbs/1000')
Cable Diameter	9.2 mm (0.36 in)
Strength Member	16 AWG Galvanized Steel Polyurethane Insulated – Purple

For inquiries or to order OCC's SMPTE cables, please call 1-800-622-7711 and ask for a Sales Representative. We're ready to assist you.

## (5.3i) SMPTE Flex Cables

1. 16 AWG Copper Conductor (x2)
2. Cotton Filler
3. Single-mode Fiber Optic Cable (x2)
4. 24 AWG Copper Conductor (x2)
5. Tinned Copper Shield
6. Polyurethane Outer Jacket
7. Central Aramid Strength Member

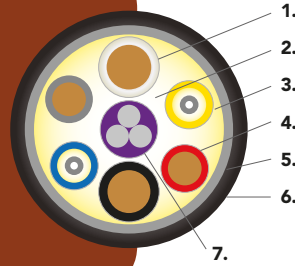

CONDUCTORS	
	16 AWG 65 Strand Class C Annealed Tinned Copper PE Insulated
1	Black
2	White
	24 AWG 19 Strand Class B Annealed Tinned Copper PE Insulated
3	Red
4	Gray

### SMPTE® Flex Part Number: C-006HBAD5KB

#### Applications

- OCC's SMPTE 311 compliant FLEX cables feature less voltage drop over the same distance as other flexible cables on the market due to different size copper conductors – offering maximum flexibility, durability, and reliability for quick and frequent camera moves and changes
- Available in bulk cable or pre-terminated assembly with SMPTE 304 connectors for a fast and easy Plug-and-Play solution, the SMPTE FLEX, characterized by OCC's superior cable durability and reliability, is the ideal solution for high performance HD transmission even in the harshest broadcasting environments

#### Features

- Aramid central strength member makes the SMPTE FLEX both flexible and durable
- OCC's military grade durability and reliability
- Polyurethane jacket for even greater durability
- 500 micron acrylate fiber in 1.6 mm subunits
- OCC's outstanding customer service, broad assembly offerings, and dedicated repair and restoration make OCC SMPTE the prime product in the Broadcast market today



ULTRA-FOX PLUS FIBER PERFORMANCE	
Fiber code/count	SLA/2
Industry standard designation	Bend-insensitive Single-mode ITU-T G.657.A1 ITU-T G.652.D (Yellow and Blue)
Core/cladding diameter (µm)	9/125
Wavelength (nm)	1310/1550
Maximum cable attenuation (dB/km)	0.5/0.5
Primary coating diameter (µm)	500
Secondary buffer diameter (µm)	900
Zero dispersion slope (ps/nm <sup>2</sup> -km)	0.092
Proof test level (kpsi)	100

CABLE CHARACTERISTICS	
Jacket Color	Black
Jacket Material	Polyurethane
Buffer material	Hard Elastomer
Subunit OD	1.6 mm
Cable Weight	100 kg/km (67 lbs/1000')
Cable Diameter	7.8 mm (0.31 in)
Strength Member	Jacketed Aramid

For inquiries or to order OCC's SMPTE cables, please call 1-800-622-7711 and ask for a Sales Representative. We're ready to assist you.

## (5.3j) SMPTE LSZH Cables

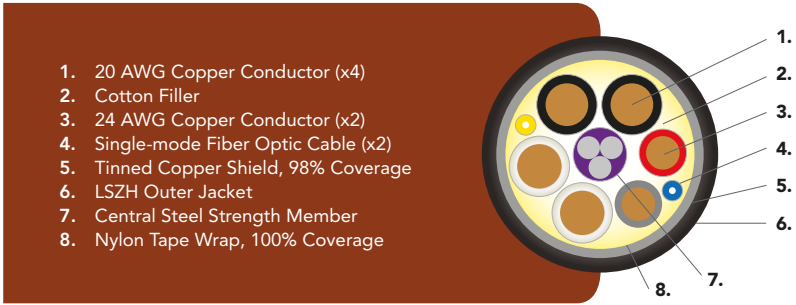

SMPTE®  
Part #: C-008HBAA5KZ

CONDUCTORS	
	20 AWG 19 Strand Class C Annealed Tinned Copper PE Insulated
1	Black
2	Black/White
3	White/Black
4	White
	24 AWG 7 Strand Class B Annealed Tinned Copper PE Insulated
5	Red
6	Gray

### Applications

- OCC's LSZH (low smoke zero halogen) SMPTE 311 compliant cable addresses the many international, government/military, and other broadcast venues that require this special jacketed cable
- Available in bulk cable or pre-terminated assembly with SMPTE 304 connectors for quick and easy Plug-and-Play installations

### Features

- OCC's SMPTE Premium core with an LSZH jacket
- 500 micron fiber protection, which many manufacturers do not offer, but OCC does
- Full SMPTE 311 compliance
- Available in custom lengths
- OCC's outstanding customer service, broad assembly offerings, and dedicated repair and restoration makes OCC SMPTE the prime product in the broadcast market today



ULTRA-FOX PLUS FIBER PERFORMANCE	
Fiber code/count	SLA/2
Industry standard designation	Bend-insensitive Single-mode ITU-T G.657.A1 ITU-T G.652.D (Yellow and Blue)
Core/cladding diameter (µm)	9/125
Wavelength (nm)	1310/1550
Maximum cable attenuation (dB/km)	0.5/0.5
Primary coating diameter (µm)	500
Secondary buffer diameter (µm)	900
Zero dispersion slope (ps/nm <sup>2</sup> -km)	0.092
Proof test level (kpsi)	100

CABLE CHARACTERISTICS	
Jacket Color	Black
Jacket Material	LSZH
Buffer material	Hard Elastomer
Subunit OD	0.9 mm
Cable Weight	161 kg/km (108 lbs/1000')
Cable Diameter	9.2 mm (0.36 in)
Strength Member	16 AWG Galvanized Steel Polyurethane Insulated – Purple

## (5.4a) D-Series Distribution – MSHA-Rated Mining Cables

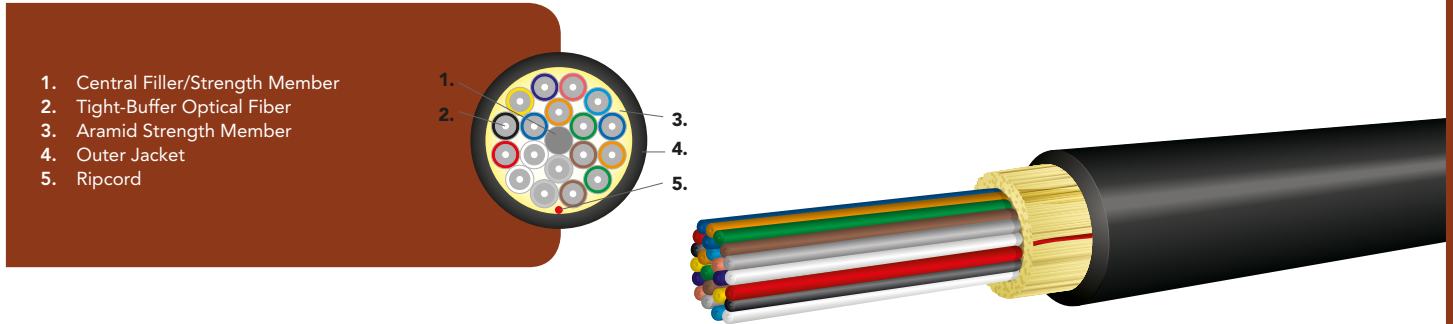

### Applications

- Can be installed in locations that require compliance with MSHA's Part 7, Subpart K of Title 30 of the Code of Federal Regulations (CFR) signal cables
- Suitable for permanent installations

### Features

- Multiple tight-buffered fibers stranded within a single jacket with common strength members
- Ideal configuration for a single cable termination point requiring multiple fibers
- Flame-retardant – MSHA-approved to Part 7, Subpart K of Title 30 Code of Federal Regulations
- Compact, lightweight cable design with the highest strength-to-weight ratio
- Flexible, rugged, high-strength construction for long cable pulls
- May be directly terminated with connectors with physical protection at termination points
- Lower total installed costs
- Helically stranded cable core for flexibility, deployment survivability, and mechanical protection for the optical fibers
- High-performance tight-buffered coating on each optical fiber for environmental and mechanical protection



### Applicable Standards

OCC indoor/outdoor tight-buffered MSHA-rated mining cables meet or exceed the functional requirements of the following standards:

- ICEA –S-83-596
- ICEA-S-104-696
- GR-409-CORE
- TIA-568
- TIA-598
- Part 7, Subpart K of Title 30 Code of Federal Regulations

### Mechanical and Environmental Performance

	DISTRIBUTION MINING CABLES
Operating temperature	-40°C to +85°C
Storage temperature	-55°C to +85°C
Installation temperature (cable temp.)	-10°C to +60°C
Flame retardancy	Part 7, Subpart K of Title 30 Code of Federal Regulations
Crush resistance (TIA-455-41)	1,800 N/cm
Flex resistance (TIA-455-104)	2,000 cycles

 (5.4a) D-Series Distribution – MSHA-Rated Mining Cables

## Cable Characteristics: D-Series MSHA-Rated Mining Cables

FIBER COUNT	DIAMETER MM (IN)	WEIGHT KG/KM (LBS/1,000')	TENSILE LOAD		MINIMUM BEND RADIUS	
			INSTALLATION N (LBS)	OPERATIONAL N (LBS)	INSTALLATION CM (IN)	LONG-TERM CM (IN)
2*	4.8 (0.19)	22 (14)	660 (150)	180 (40)	7.3 (2.9)	4.9 (1.9)
4	5.1 (0.20)	24 (16)	1,400 (310)	450 (100)	7.7 (3.0)	5.1 (2.0)
6	5.7 (0.22)	32 (22)	1,400 (310)	450 (100)	8.6 (3.4)	5.8 (2.2)
8	5.9 (0.23)	34 (23)	1,600 (360)	525 (120)	8.9 (3.5)	5.9 (2.3)
10	7.0 (0.28)	43 (29)	1,800 (400)	600 (135)	10.6 (4.1)	7.1 (2.8)
12	6.5 (0.26)	38 (25)	2,700 (600)	600 (135)	9.8 (3.8)	6.5 (2.6)
18	7.2 (0.28)	48 (32)	2,700 (600)	700 (160)	10.8 (4.3)	7.2 (2.8)
24	8.9 (0.35)	67 (45)	3,000 (670)	1,000 (220)	13.4 (5.3)	8.9 (3.5)
30	9.1 (0.36)	73 (49)	3,000 (670)	1,000 (220)	13.7 (5.4)	9.1 (3.6)
36	9.1 (0.36)	73 (49)	3,000 (670)	1,000 (220)	13.7 (5.4)	9.1 (3.6)
48	10.1 (0.40)	93 (63)	4,200 (940)	1,400 (310)	15.2 (6.0)	10.1 (4.0)

\* -40°C to +70°C  
Installation loads in excess of 2,700 N (600 lbs.) are not recommended.  
Other fiber counts available upon request.

## Ordering Information

	<b>D</b>	<b>X</b>				<b>D</b>				<b>9</b>	<b>K</b>	<b>S</b>
Digit No:	1	2	3	4	5	6	7	8	9	10	11	12

- 1 – 2 Distribution Series Ultra-Fox = **DX**
- 3 – 5 Fiber count: (see cable characteristics chart) = **002–048**
- 6 Jacket type: Indoor/Outdoor PVC = **D**
- 7 – 9 Fiber type: (see Laser Ultra-Fox Fiber Performance Table, pg. 206)
- 10 Ultra-Fox fiber with 900µm tight-buffer = **9**
- 11 Standard jacket color: Black = **K** (other jacket colors available upon request)
- 12 Rating: MSHA = **S**

**Example:** 12-fiber Ultra-Fox MSHA-approved distribution cable using bend-insensitive low water peak single-mode fiber, black jacket

<b>D</b>	<b>X</b>	<b>0</b>	<b>1</b>	<b>2</b>	<b>D</b>	<b>S</b>	<b>L</b>	<b>A</b>	<b>9</b>	<b>K</b>	<b>S</b>
----------	----------	----------	----------	----------	----------	----------	----------	----------	----------	----------	----------



## (5.4b) D-Series Distribution – MSHA-Rated Deployable Cables

1. Optical Fiber
2. Acrylate Fiber Coating
3. Color-Coded 900µm Diameter Hard Elastomeric Tight-Buffer
4. Aramid Strength Member
5. Core-Locked™ Flame-Retardant Tactical Polyurethane Jacket

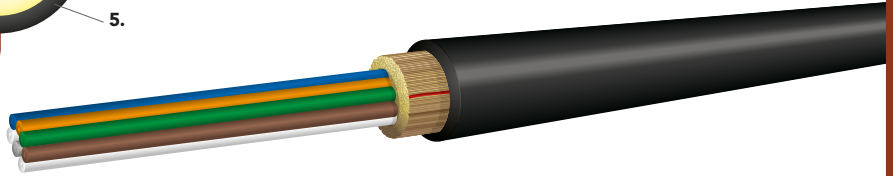
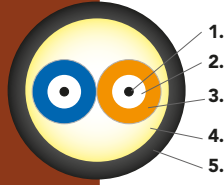

### Applications

- Can be installed in locations that require compliance with MSHA's Part 7, Subpart K of Title 30 of the Code of Federal Regulations (CFR) signal cables
- Suitable for temporary deployment and retrieval applications

### Features

- Most rugged, high-strength cable design
- Excellent for use in deployment/retrieval applications
- Core-Locked™ jacket for improved mechanical performance
- Designed for use in adverse environments
- Helically stranded cable core for flexibility, deployment survivability, and mechanical protection for the optical fibers
- Crush resistant and resilient with additional strength members
- Exceptional crush and impact resistance, flexibility, deployment/retrieval, twist temperature, chemical resistance from the cable jacket, strength members, and fiber buffer coatings
- UV resistant, water and fungus resistant
- Multiple 900µm tight-buffered fibers stranded with common strength members within a tight-bound outer jacket
- Ideal distribution cable configuration for most demanding applications — crush, impact, twist, bend, flex continuous movement, deployment/retrieval, etc.
- Flame-retardant – MSHA-approved to Part 7, Subpart K of Title 30 Code of Federal Regulations

### OCC Provided Options

- Mil-Tac Style MSHA cables can be prespooled on deployable reels for a ready-to-use product
- Mil-Tac Style MSHA cables can be pre-terminated with single-fiber or ruggedized with multichannel connectors upon request



### Applicable Standards

OCC D-Series Distribution MSHA-rated deployable cables meet or exceed the functional requirements of the following standards:

- TIA-568
- TIA-598
- Part 7, Subpart K of Title 30 Code of Federal Regulations





## (5.4b) D-Series Distribution – MSHA-Rated Deployable Cables

## Mechanical and Environmental Performance

	MIL-TAC STYLE MINING CABLES
Operating temperature	-40°C to +85°C
Storage temperature	-70°C to +85°C
Flame retardancy	Part 7, Subpart K of Title 30 Code of Federal Regulations
Crush resistance (TIA-455-41)	1,800 N/cm
Flex resistance (TIA-455-104)	2,000 cycles

## Cable Characteristics: D-Series MSHA-Rated Deployable Cables

FIBER COUNT	DIAMETER MM (IN)	WEIGHT KG/KM (LBS/1,000')	TENSILE LOAD		MINIMUM BEND RADIUS	
			INSTALLATION N (LBS)	OPERATIONAL N (LBS)	INSTALLATION CM (IN)	LONG-TERM CM (IN)
2	5.8 (0.23)	31 (21)	1,800 (400)	600 (130)	5.8 (2.3)	2.9 (1.1)
4	5.8 (0.23)	31 (21)	1,800 (400)	600 (130)	5.8 (2.3)	2.9 (1.1)
6	6.1 (0.24)	34 (23)	1,800 (400)	600 (130)	6.1 (2.4)	3.0 (1.2)
8	6.8 (0.26)	43 (29)	1,800 (400)	600 (130)	6.8 (2.7)	3.4 (1.3)
10	7.2 (0.28)	50 (34)	2,100 (470)	700 (160)	7.2 (2.8)	3.6 (1.4)
12	7.1 (0.28)	51 (34)	2,100 (470)	700 (160)	7.1 (2.8)	3.5 (1.4)
18	7.8 (0.31)	56 (38)	2,400 (540)	800 (180)	7.8 (3.1)	3.9 (1.5)
24	9.0 (0.35)	71 (48)	3,000 (670)	1,000 (220)	9.0 (3.5)	4.5 (1.8)

Specifications vary by fiber type.  
Installation loads in excess of 2,700 N (600 lbs.) are not recommended.  
Other fiber counts available upon request.

## Ordering Information

	<b>D</b>	<b>X</b>				<b>V</b>				<b>9</b>	<b>K</b>	<b>S</b>
Digit No:	1	2	3	4	5	6	7	8	9	10	11	12

- 1 – 2 Distribution Series Ultra-Fox = **DX**
- 3 – 5 Fiber count: (see cable characteristics chart) = **002–024**
- 6 Jacket type: Flame-Retardant Tactical Polyurethane = **V**
- 7 – 9 Fiber type: (see Laser Ultra-Fox Fiber Performance Table, pg. 206)
- 10 Ultra-Fox fiber with 900µm tight-buffer = **9**
- 11 Jacket color: Black = **K**
- 12 Rating: MSHA = **S**

**Example:** 12-fiber Mil-Tac style MSHA-approved distribution cable using single-mode fiber, Ultra-Fox, black jacket

<b>D</b>	<b>X</b>	<b>0</b>	<b>1</b>	<b>2</b>	<b>V</b>	<b>S</b>	<b>L</b>	<b>X</b>	<b>9</b>	<b>K</b>	<b>S</b>
----------	----------	----------	----------	----------	----------	----------	----------	----------	----------	----------	----------



## (5.4c) B-Series Breakout – MSHA-Rated Mining Cables

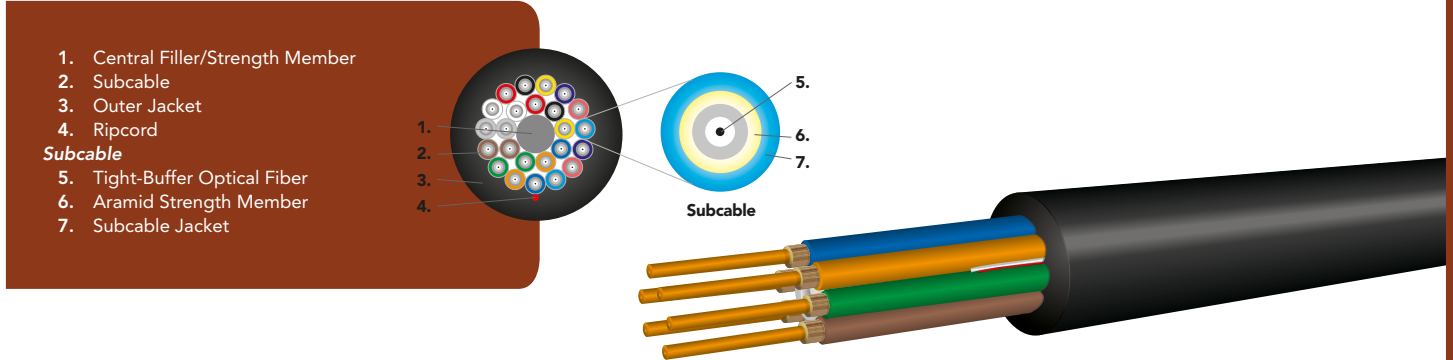

### Applications

- Can be installed in locations that require compliance with MSHA's Part 7, Subpart K of Title 30 of the Code of Federal Regulations (CFR) signal cables
- Suitable for permanent installations
- Ideal for applications that require individual connectors added to subcables

### Features

- Most rugged cable design with individual subcables for routing and direct connector termination
- Helically stranded cable core for flexibility, deployment survivability, and mechanical protection for the optical fibers
- High-performance tight-buffered coating on each optical fiber for environmental and mechanical protection
- Fibers may be directly terminated using connectors, with no further protection required
- UV resistant, water and fungus resistant
- Core-Locked™ outer jacket surrounds the subcables for exceptional crush resistance, survivability, and use in long, vertical installations
- Designed for direct lashing, "J" hook applications, and vertical installations in mines
- Cable is ideal for direct pulling with wire mesh grips
- Individual fibers and strength members protected in a subcable configuration
- Ideal configuration for multiple termination point locations where subcables provide excellent strength and mechanical protection for connector termination
- Flame-retardant – MSHA-approved to Part 7, Subpart K of Title 30 Code of Federal Regulations



### Applicable Standards

OCC B-Series MSHA-rated cables meet or exceed the functional requirements of the following standards:

- ICEA-S-83-596
- ICEA-S-104-696
- GR-409-CORE
- TIA-568
- TIA-598
- Part 7, Subpart K of Title 30 Code of Federal Regulations

### Mechanical and Environmental Performance

	BREAKOUT MINING CABLES
Operating temperature	-40°C to +85°C
Storage temperature	-55°C to +85°C
Installation temperature (cable temp.)	-10°C to +60°C
Flame retardancy	Part 7, Subpart K of Title 30 Code of Federal Regulations
Crush resistance (TIA-455-41)	2,200 N/cm
Flex resistance (TIA-455-104)	2,000 cycles

 (5.4c) B-Series Breakout – MSHA-Rated Mining Cables

## Cable Characteristics: B-Series MSHA-Rated Mining Cables

FIBER COUNT	DIAMETER MM (IN)	WEIGHT KG/KM (LBS/1,000')	TENSILE LOAD		MINIMUM BEND RADIUS	
			INSTALLATION N (LBS)	OPERATIONAL N (LBS)	INSTALLATION CM (IN)	LONG-TERM CM (IN)
2	7.0 (0.28)	41 (28)	1,200 (270)	500 (110)	10.5 (4.1)	7.0 (2.8)
4	8.3 (0.33)	65 (44)	2,000 (450)	800 (180)	12.5 (4.9)	8.3 (3.3)
6	9.6 (0.38)	84 (56)	3,000 (670)	1,200 (270)	14.4 (5.7)	9.6 (3.8)
8	11.6 (0.46)	126 (85)	4,000 (900)	1,700 (380)	17.5 (6.9)	11.6 (4.6)
12	14.1 (0.56)	159 (107)	6,000 (1,350)	2,500 (560)	21.2 (8.3)	14.1 (5.6)
18	15.3 (0.60)	216 (145)	8,000 (1,800)	3,500 (790)	23.1 (9.1)	15.3 (6.0)
24	17.6 (0.69)	279 (188)	10,000 (2,250)	3,800 (850)	26.5 (10.4)	17.6 (6.9)
36	20.9 (0.82)	360 (242)	14,000 (3,150)	6,000 (1,350)	31.4 (12.4)	20.9 (8.2)
48	24.2 (0.95)	483 (325)	18,000 (4,050)	7,500 (1,690)	36.3 (14.3)	24.2 (9.5)

## Ordering Information

	<b>B</b>	<b>X</b>				<b>D</b>				<b>9</b>	<b>K</b>	<b>S</b>
Digit No:	1	2	3	4	5	6	7	8	9	10	11	12

- 1 – 2 Breakout Series Ultra-Fox = **BX**
- 3 – 5 Fiber count: (see cable characteristics chart) = **002-048**
- 6 Jacket type: Indoor/Outdoor PVC = **D**
- 7 – 9 Fiber type: (see Laser Ultra-Fox Fiber Performance Table, pg. 206)
- 10 Ultra-Fox fiber with 900µm tight-buffer = **9**
- 11 Standard jacket color: Black = **K** (other jacket colors available upon request)
- 12 Rating: MSHA = **S**



**Example:** 12-fiber MSHA breakout cable using 62.5µm standard Laser Ultra-Fox fiber, black jacket

<b>B</b>	<b>X</b>	<b>0</b>	<b>1</b>	<b>2</b>	<b>D</b>	<b>W</b>	<b>L</b>	<b>S</b>	<b>9</b>	<b>K</b>	<b>S</b>
----------	----------	----------	----------	----------	----------	----------	----------	----------	----------	----------	----------

## (5.4d) B-Series Breakout – MSHA-Rated Deployable Cables

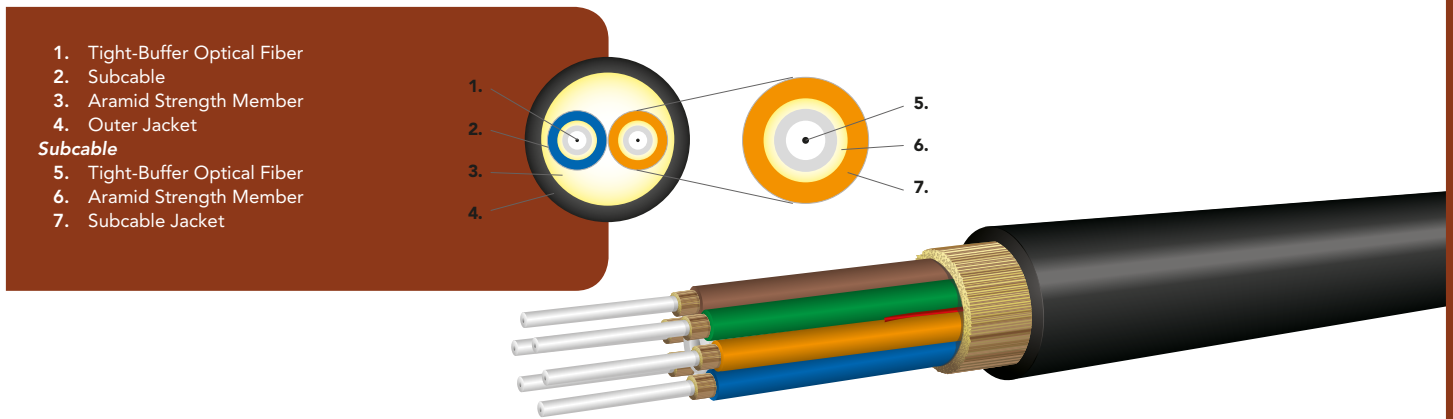

### Applications

- Used in mining applications where cables may need to be temporarily deployed or where a rugged jacket is required
- Deployable cable that is ideal for use in harsh environments where deployment and retrieval for reuse are required
- Ideal for applications that require termination of the subcable to a connector and a direct run to panels and equipment

### Features

- Most rugged, high-strength cable design incorporating subcables for direct termination
- Polyurethane jacketed for abrasion, cut and chemical resistance
- Core-Locked™ jacket for improved mechanical performance
- Breakout cable design with individual color-coded subcables protecting each optical fiber
- Crush resistant and resilient, with two separate layers of aramid strength members in the subcables for individual single-fiber connector and termination pin, and overall for termination to multiway connector backshells or other housings
- Helically stranded cable core for flexibility, deployment survivability and exceptional mechanical protection for the optical fibers
- Can be used outdoors for temporary deployment directly on the ground, in all terrains, including severe environments
- Suitable for industrial, mining and petrochemical environments; chemical resistant
- Round cable design for easy installation and survivability
- Often used with multiway military tactical connectors for maximum connector retention (400 lbs)
- Ideally suited for use with MIL-C-38999 style military connectors; subcables terminate to individual pins, and overall aramid strength member terminates to backshell
- 2.0mm subcables standard
- Flame-retardant and MSHA-approved to Part 7, Subpart K of Title 30 Code of Federal Regulations (CFR)



### OCC Provided Options

- MSHA-rated deployable cables prespooled on deployable reels for a ready-to-use product
- MSHA-rated deployable cables can be pre-terminated with single-fiber or ruggedized multichannel connectors upon request

**(5.4d) B-Series Breakout – MSHA-Rated Deployable Cables**

## Mechanical and Environmental Performance

	BREAKOUT MINING CABLES
Operating temperature	-40°C to +85°C
Storage temperature	-70°C to +85°C
Flame retardancy	MSHA-approved 30FR 7.408
Crush resistance (TIA-455-41)	2,100 N/cm
Flex resistance (TIA-455-104)	2,000 cycles

### Applicable Standards

OCC B-Series Breakout MSHA-rated Deployable cables meet or exceed the functional requirements of the following standards:

- TIA-568
- TIA-598
- MSHA 30CFR Signal Cables

## Cable Characteristics: B-Series MSHA-Rated Deployable Cables

FIBER COUNT	DIAMETER MM (IN)	WEIGHT KG/KM (LBS/1,000')	TENSILE LOAD		MINIMUM BEND RADIUS	
			INSTALLATION N (LBS)	OPERATIONAL N (LBS)	INSTALLATION CM (IN)	LONG-TERM CM (IN)
2	7.0 (0.28)	49 (33)	2,200 (490)	550 (120)	7.0 (2.8)	3.5 (1.4)
4	7.9 (0.31)	60 (40)	2,200 (490)	550 (120)	7.9 (3.1)	3.9 (1.5)
6	9.0 (0.36)	73 (49)	2,400 (540)	600 (130)	9.0 (3.6)	4.5 (1.8)
8	10.3 (0.41)	96 (64)	3,200 (720)	800 (180)	10.3 (4.1)	5.1 (2.0)
10	11.7 (0.46)	124 (83)	4,000 (900)	1,000 (220)	11.7 (4.6)	5.8 (2.3)
12	11.0 (0.43)	102 (69)	4,800 (1080)	1,200 (270)	11.0 (4.3)	5.5 (2.2)

## Ordering Information

	<b>B</b>	<b>X</b>				<b>V</b>				<b>9</b>	<b>K</b>	<b>S</b>
Digit No:	1	2	3	4	5	6	7	8	9	10	11	12

- 1 – 2 Breakout Series Ultra-Fox = **BX**
- 3 – 5 Fiber count: (see cable characteristics chart) = **002–012**
- 6 Jacket type: Flame-Retardant Tactical Polyurethane = **V**
- 7 – 9 Fiber type: (see Laser Ultra-Fox Fiber Performance Table, pg. 206)
- 10 Ultra-Fox fiber with 900µm tight-buffer = **9**
- 11 Jacket color: Black = **K**
- 12 Rating: MSHA = **S**



**Example:** 12-fiber MSHA breakout cable using OM3 laser optimized bend-insensitive fiber, Ultra-Fox black jacket

<b>B</b>	<b>X</b>	<b>0</b>	<b>1</b>	<b>2</b>	<b>V</b>	<b>A</b>	<b>L</b>	<b>T</b>	<b>9</b>	<b>K</b>	<b>S</b>
----------	----------	----------	----------	----------	----------	----------	----------	----------	----------	----------	----------

## (5.4e) G-Series Subgrouping – MSHA-Rated Mining Cables

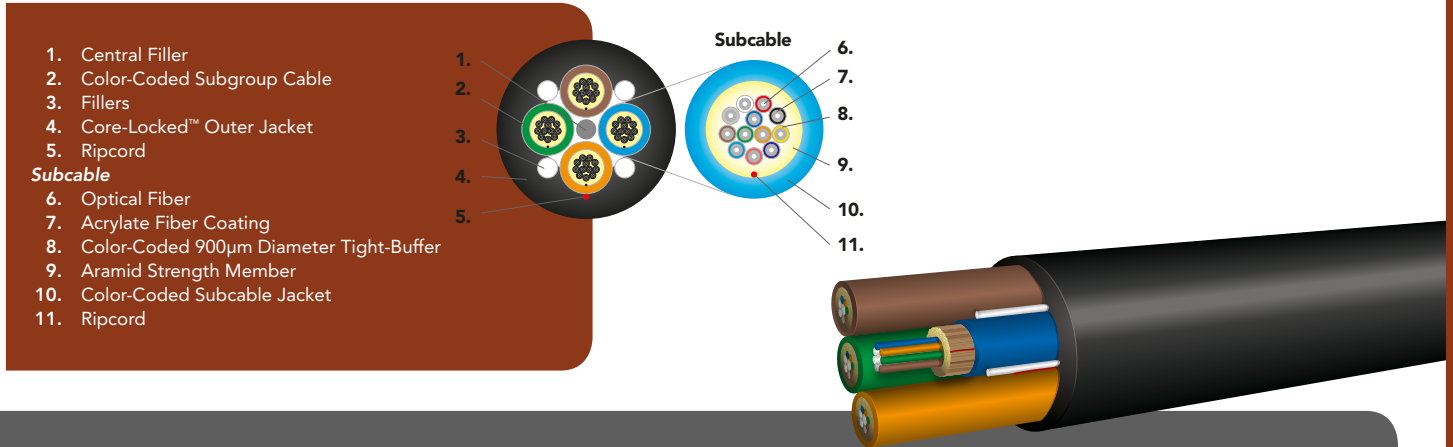

### Applications

- Ideal separation and identification of single-mode and multimode fibers in a single cable
- Design allows subcables to be routed to multiple locations such as wiring racks and closets

### Features

- Tight-buffered multifiber cable design allows subcables to be routed to multiple locations
- Ideal for midspan access applications
- Core-Locked™ outer jacket surrounds the subcables for superior crush resistance, survivability, and use in long, vertical installations
- UV resistant, water and fungus resistant
- Helically stranded cable core for flexibility, deployment survivability, and mechanical protection for the optical fibers
- High-performance tight-buffered coating on each optical fiber for environmental and mechanical protection
- Designed for direct lashing, "J" hook applications, and vertical installations in mines
- Multiple distribution style subcables within a common jacket with each subcable having its own flexible aramid strength member
- Flame-retardant – MSHA-approved to Part 7, Subpart K of Title 30 Code of Federal Regulations



### Applicable Standards

OCC indoor/outdoor tight-buffered fiber optic tray cables meet or exceed the functional requirements of the following standards:

- ICEA –S-83-596
- ICEA-S-104-696
- GR-409-CORE
- TIA-568
- TIA-598
- Part 7, Subpart K of Title 30 Code of Federal Regulations

### Mechanical and Environmental Performance

	SUBGROUPING MINING CABLES
Operating temperature	-40°C to +85°C
Storage temperature	-55°C to +85°C
Installation temperature (cable temp.)	-10°C to +60°C
Flame retardancy	Part 7, Subpart K of Title 30 Code of Federal Regulations
Crush resistance (TIA-455-41)	2,100 N/cm
Flex resistance (TIA-455-104)	2,000 cycles

Consistent with the definition in TIA-440-B "Fiber Optic Terminology," hybrid cable is defined as a cable containing both optical fibers and electrical conductors. Composite cable is defined as a cable containing mixed fiber types. Prior to 2012 some U.S. standards documents use definitions for hybrid and composite which are opposite of those stated here. The change in convention was made in the interest of harmonization with International standards and other National standards.



 (5.4e) G-Series Subgrouping – MSHA-Rated Mining Cables

**Cable Characteristics:**  
**G-Series MSHA-Rated Mining Cables 6-Fiber Subcables (4.5mm subcables)**

FIBER COUNT	DIAMETER MM (IN)	WEIGHT KG/KM (LBS/1,000')	TENSILE LOAD		MINIMUM BEND RADIUS	
			INSTALLATION N (LBS)	OPERATIONAL N (LBS)	INSTALLATION CM (IN)	LONG-TERM CM (IN)
12	14.6 (0.57)	207 (139)	3,800 (850)	1,200 (270)	21.9 (8.6)	14.6 (5.7)
18	14.6 (0.57)	208 (140)	4,700 (1,060)	1,800 (400)	21.9 (8.6)	14.6 (5.7)
24	14.6 (0.57)	209 (140)	5,600 (1,260)	1,800 (400)	21.9 (8.6)	14.6 (5.7)
30	15.6 (0.61)	240 (161)	7,500 (1,690)	2,400 (540)	23.4 (9.2)	15.6 (6.1)
36	16.9 (0.67)	282 (189)	8,900 (2,000)	2,850 (640)	25.4 (10.0)	16.9 (6.7)

**G-Series MSHA-Rated Mining Cables 12-Fiber Subcables (5.5mm subcables)**

FIBER COUNT	DIAMETER MM (IN)	WEIGHT KG/KM (LBS/1,000')	TENSILE LOAD		MINIMUM BEND RADIUS	
			INSTALLATION N (LBS)	OPERATIONAL N (LBS)	INSTALLATION CM (IN)	LONG-TERM CM (IN)
24	16.6 (0.65)	243 (164)	4,600 (1,030)	1,500 (340)	25.0 (9.8)	16.6 (6.5)
36	16.6 (0.65)	240 (161)	5,900 (1,330)	1,050 (440)	25.0 (9.8)	16.6 (6.5)
48	16.6 (0.65)	237 (159)	7,200 (1,620)	2,400 (540)	25.0 (9.8)	16.6 (6.5)
60	18.4 (0.72)	308 (207)	9,500 (2,140)	3,150 (710)	27.6 (10.9)	18.4 (7.2)
72	19.2 (0.76)	330 (222)	11,300 (2,540)	3,750 (840)	28.9 (11.4)	19.2 (7.6)

Installation loads in excess of 2,700 N (600 lbs.) are not recommended.  
 Other fiber counts with 6-fiber subunits available upon request.

**Ordering Information**

	<b>G</b>					<b>D</b>				<b>9</b>	<b>K</b>	<b>S</b>
Digit No:	1	2	3	4	5	6	7	8	9	10	11	12

- 1 Subgrouping Series Ultra-Fox = **G**
- 2 12-fiber subcables = **X**  
6-fiber subcables = **B**
- 3 – 5 Fiber count: (see cable characteristics chart) = **012–072**
- 6 Jacket type: Indoor/Outdoor PVC = **D**
- 7 – 9 Fiber type: (see Laser Ultra-Fox Fiber Performance Table, pg. 206)
- 10 Ultra-Fox fiber with 900µm tight-buffer = **9**
- 11 Standard jacket colors: Black = **K** (other jacket colors available upon request)
- 12 Rating: MSHA = **S**



**Example:** 24-fiber MSHA 12-fiber subgrouping cable using 62.5µm standard Laser Ultra-Fox optimized fiber, black jacket

**G X 0 2 4 D W L S 9 K S**

## (5.4f) CX-Series Hybrid – MSHA-Rated Signal Cables

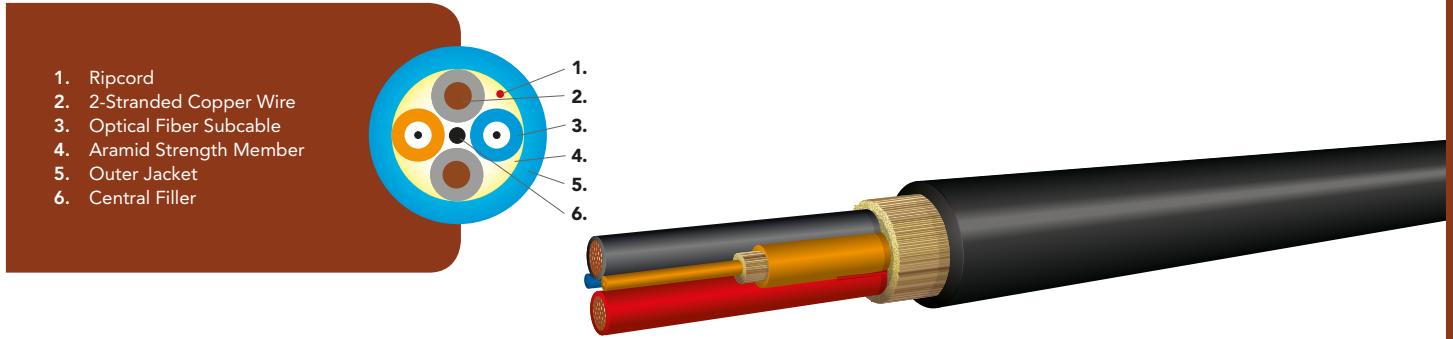

### Applications

- Various combinations of copper wire and fiber for electro-optical applications
- For signaling applications power voltages less than 50 volts

### Features

- Chemical-resistant outer jacket for indoor/outdoor plant environments; 10-, 12-, 14-, 16-, 18-gauge single-stranded copper wire available for low-power, communication, control sensor, signal, and video
- Multimode (62.5µm or 50µm) and single-mode fiber available – contact Optical Cable Corporation for specifications and part numbers
- UV resistant, water and fungus resistant
- Available with PVC (D) or Fluoropolymer (K) jackets
- Hundreds of combinations of wire and fiber possible – contact OCC for a cable design to match your requirements
- Flame-retardant – MSHA-approved to Part 7, Subpart K of Title 30 Code of Federal Regulations (CFR)



### Mechanical and Environmental Performance

	HYBRID MINING SIGNAL CABLES
Minimum bend radius:	
Installation load	20X outside diameter
Operational load	15X outside diameter
Flame retardancy	Part 7, Subpart K of Title 30 Code of Federal Regulations (CFR)

### Applicable Standards

OCC hybrid tight-buffered fiber optic and copper cables meet or exceed the functional requirements of the following standards:

- UL 13
- Part 7, Subpart K of Title 30 Code of Federal Regulations

Consistent with the definition in TIA-440-B "Fiber Optic Terminology," hybrid cable is defined as a cable containing both optical fibers and electrical conductors. Composite cable is defined as a cable containing mixed fiber types. Prior to 2012 some U.S. standards documents use definitions for hybrid and composite which are opposite of those stated here. The change in convention was made in the interest of harmonization with International standards and other National standards.

**(5.4f) CX-Series Hybrid – MSHA-Rated Signal Cables**

### Ordering Information

	C	X								9	K	S
Digit No:	1	2	3	4	5	6	7	8	9	10	11	12
1 – 2	Hybrid Series Ultra-Fox = <b>CX</b>											
3 – 5	Fiber count: Number of fibers ( <b>002–036</b> ) + Copper Conductors ( <b>002–004</b> ) Example: 2-fiber/2-copper = <b>004</b>											
6	Jacket type: Indoor/Outdoor Fluoropolymer = <b>K</b> Indoor/Outdoor PVC = <b>D</b>											
7 – 9	Fiber/Copper type: Contact OCC for code											
10	Ultra-Fox fiber with 900µm tight-buffer = <b>9</b>											
11	Standard jacket color: Black = <b>K</b> (other colors available)											
12	Rating: MSHA = <b>S</b>											



**Example:** 2-fiber/2AWG-18 copper cable using 62.5µm Ultra-Fox fiber, K jacket, black

C	X	0	0	4	K	.	.	.	9	K	S
---	---	---	---	---	---	---	---	---	---	---	---

## (5.5a) D-Series Distribution LSZH ABS-Approved Cables

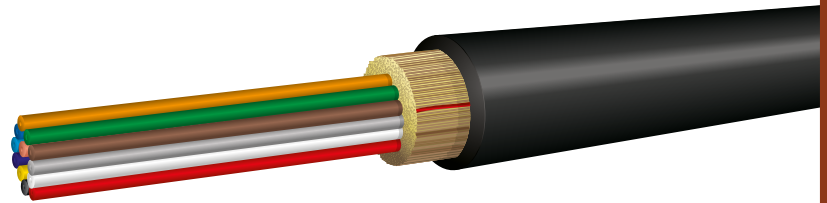

### Applications

- Approved by the American Bureau of Shipping (ABS)
- Marine and offshore tight-buffered cable design for use in installations requiring a flame-retardant, low-smoke and zero-halogen cable intended for single point terminations
- Can be used in applications requiring ABS-approved fiber optic cables

### Features

- Zero-halogen construction meets IEC 60754-2
- Meets low-smoke requirements of UL 1685 and IEC 61034-2
- Flame-retardant per the requirements of IEC 60332-3-24
- UL listed OFN-LS
- ABS-approved for 2007 Steel Vessels Rules 1-1-4/7.7, 4-8-3/9.13
- ABS-approved for 2006 MODU Rules 4-3-4/13.1.6
- Suitable for indoor or outdoor applications
- Jacket is UV, fungus and moisture resistant
- Round cable construction for easy handling and termination
- Includes ripcord for easy outer jacket removal
- Rugged distribution-style cable with 2 to 24 for deck applications
- Optical fiber types include 62.5/125, 50/125, and single-mode
- Available with 500µm primary acrylate-coated fiber for maximum mechanical and environmental protection of the optical fiber



### Applicable Standards

OCC D-Series Distribution Low-Smoke Zero-Halogen ABS-Approved Cable meet or exceed the functional requirements of the following standards:

- IEC 60332-3-24
- IEC 60754-2
- IEC 61034-2
- UL 1685
- ICEA-S-104-696
- MIL-C-24643
- TIA-568
- TIA-598
- ABS Steel Vessels and MODU Rules

### Mechanical and Environmental Performance

Operating temperature	-40°C to +70°C
Storage temperature	-40°C to +70°C
Installation temperature (cable temp.)	-20°C to +60°C
Flame retardancy	IEC 60332-3-24; UL listed OFN-LS (UL 1685) ABS type approved 07-HS274922
Zero-halogen	IEC 60754-2
Smoke generation	IEC 61034-2
Crush resistance (TIA-455-41)	1,800 N/cm
Flex resistance (TIA-455-104)	2,000 cycles



**(5.5a) D-Series Distribution LSZH ABS-Approved Cables**

## Cable Characteristics: D-Series Distribution LSZH ABS-Approved Cables

FIBER COUNT	DIAMETER MM (IN)	WEIGHT KG/KM (LBS/1,000')	TENSILE LOAD		MINIMUM BEND RADIUS	
			INSTALLATION N (LBS)	OPERATIONAL N (LBS)	INSTALLATION CM (IN)	LONG-TERM CM (IN)
2	5.4 (0.21)	30 (20)	1,400 (310)	450 (100)	8.1 (3.2)	5.4 (2.1)
4	5.6 (0.22)	32 (22)	1,400 (310)	450 (100)	8.4 (3.3)	5.6 (2.2)
6	5.9 (0.23)	37 (25)	1,400 (310)	450 (100)	8.9 (3.5)	5.9 (2.3)
8	6.4 (0.25)	43 (29)	1,600 (360)	525 (120)	9.6 (3.8)	6.4 (2.5)
10	6.9 (0.27)	56 (38)	1,800 (400)	600 (135)	10.4 (4.1)	6.9 (2.7)
12	7.6 (0.30)	61 (41)	2,700 (600)	600 (135)	11.4 (4.5)	7.6 (3.0)
18	7.5 (0.30)	59 (40)	2,700 (600)	700 (160)	11.3 (4.4)	7.5 (3.0)
24	9.1 (0.36)	92 (62)	3,000 (670)	1,000 (220)	13.7 (5.4)	9.1 (3.6)

Installation loads in excess of 2,700 N (600 lbs.) are not recommended.

### Ordering Information

	<b>D</b>					<b>Z</b>				<b>9</b>	<b>K</b>	<b>E</b>	<b>-</b>		<b>A</b>	<b>B</b>	<b>S</b>
Digit No:	1	2	3	4	5	6	7	8	9	10	11	12	13	14	15	16	17
	1	Distribution Series = <b>D</b>															
	2	Ultra-Fox = <b>X</b>															
		Ultra-Fox Plus Fiber = <b>-</b>															
	3-5	Fiber count: <b>002-024</b>															
	6	Jacket type: Low-Smoke Zero-Halogen Jacket = <b>Z</b>															
	7-9	Fiber type: (see Laser Ultra-Fox or Ultra-Fox Plus Fiber Performance Table, pg. 206-207)															
	10	Ultra-Fox fiber with 900µm tight-buffer = <b>9</b> ;															
		Ultra-Fox Plus 900µm tight-buffer = <b>5</b>															
	11	Jacket color: Black = <b>K</b>															
	12	Rating: Flame-Retardant, Low-Smoke Zero-Halogen = <b>E</b>															
	14	Print in feet marks = <b>F</b> ; Print in meter marks = <b>M</b>															
	15-17	ABS-approved version = <b>ABS</b>															

**Example:** 12-fiber ABS-approved low-smoke zero-halogen, distribution cable using OM3 laser optimized bend-insensitive fiber, Ultra-Fox, black jacket printed in feet

**D X 0 1 2 Z A L T 9 K E - F A B S**

## (5.5b) D-Series Distribution LSZH Braided Armor ABS-Approved Cables

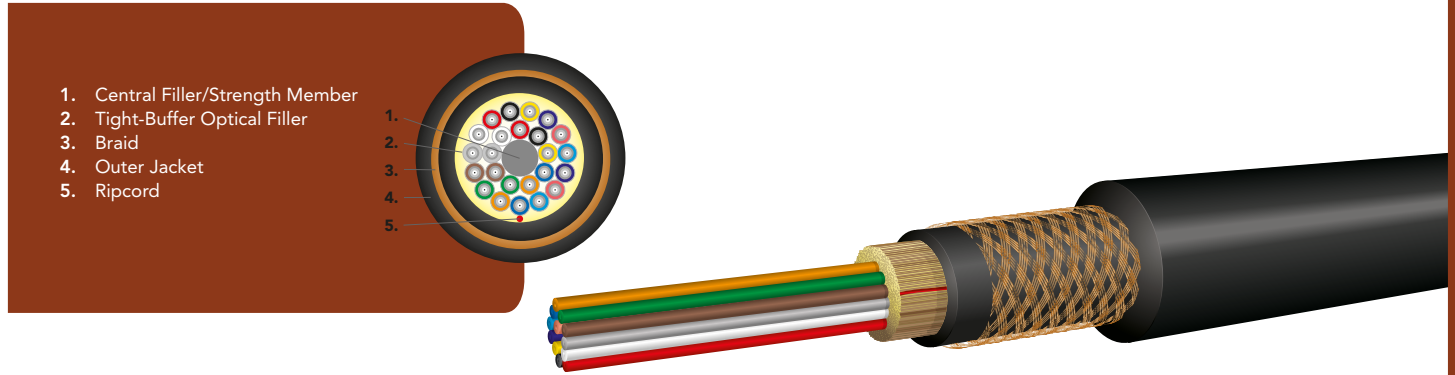

### Applications

- Approved by the American Bureau of Shipping (ABS)
- Marine and offshore tight-buffered cable design for use in installations requiring a flame-retardant, low-smoke and zero-halogen cable

### Features

- Zero-halogen construction meets IEC 60754-2
- Meets low-smoke requirements of UL 1685
- Flame-retardant per the requirements of UL 1685 OFC-LS
- UL listed OFC-LS
- Suitable for indoor or outdoor applications
- Jacket is UV, fungus and moisture resistant
- Bronze braid armor adds a degree of durability to limit damage due to abrasion
- Round cable construction for easy handling and termination
- Includes ripcord for easy outer jacket removal
- Distribution-style cable with 2 to 24 fibers
- ABS-approved for 2007 Steel Vessels Rules 1-1-4/7.7, 4-8-3/9.13
- ABS-approved for 2006 MODU Rules 4-3-4/13.1.6
- Optical fiber types include 62.5/125, 50/125, and single-mode
- Available with 500µm primary acrylate-coated fiber for maximum mechanical and environmental protection of the optical fiber
- Braid applied per IEEE 1580



### Applicable Standards

OCC D-Series Distribution Low-Smoke Zero-Halogen Braided-Armor ABS-Approved Cables meet or exceed the functional requirements of the following standards:

- IEC 60754-2
- UL 1685 OFC-LS
- ICEA-S-104-696
- MIL-C-24643
- TIA-568
- TIA-598
- IEEE 1580 (Braid Application)

### Mechanical and Environmental Performance

Operating temperature	-40°C to +70°C
Storage temperature	-40°C to +70°C
Installation temperature (cable temp.)	-20°C to +60°C
Flame retardancy	OFC-LS, ABS type approved 07-HS274922
Crush resistance (TIA-455-41)	1,800 N/cm
Flex resistance (TIA-455-104)	2,000 cycles







## (5.5b) D-Series Distribution LSZH Braided Armor ABS-Approved Cables

### Cable Characteristics: D-Series Distribution LSZH Braided Armor ABS-Approved Cables

FIBER COUNT	DIAMETER MM (IN)	WEIGHT KG/KM (LBS/1,000')	TENSILE LOAD		MINIMUM BEND RADIUS	
			INSTALLATION N (LBS)	OPERATIONAL N (LBS)	INSTALLATION CM (IN)	LONG-TERM CM (IN)
2	9.3 (0.37)	126 (85)	1,400 (310)	450 (100)	14 (5.5)	9.3 (3.7)
4	9.5 (0.37)	132 (89)	1,400 (310)	450 (100)	14.3 (5.6)	9.5 (3.7)
6	9.9 (0.39)	144 (97)	1,400 (310)	450 (100)	14.9 (5.9)	9.9 (3.9)
8	10.4 (0.41)	158 (106)	1,600 (360)	525 (120)	15.6 (6.1)	10.4 (4.1)
10	10.8 (0.43)	171 (115)	1,800 (400)	600 (135)	16.2 (6.4)	10.8 (4.3)
12	11.5 (0.45)	193 (130)	2,700 (600)	600 (135)	17.3 (6.8)	11.5 (4.5)
18	11.5 (0.45)	190 (128)	2,700 (600)	700 (160)	17.3 (6.8)	11.5 (4.5)
24	13.1 (0.52)	237 (159)	3,000 (670)	1,000 (220)	19.7 (7.8)	13.1 (5.2)

Installation loads in excess of 2,700 N (600 lbs.) are not recommended.

### Ordering Information

Digit No:	D	X				Z					K	A	B	2	-	
1	Distribution Series = <b>D</b>															
2	Ultra-Fox = <b>X</b>															
	Ultra-Fox Plus Fiber = <b>--</b>															
3 – 5	Fiber count: (see cable characteristics chart) = <b>002–024</b>															
6	Jacket type: Low-Smoke Zero-Halogen Jacket = <b>Z</b>															
7 – 9	Fiber type: (see Laser Ultra-Fox or Ultra-Fox Plus Fiber Performance Table, pg. 206–207)															
10	Ultra-Fox fiber with 900µm tight-buffer = <b>9</b>															
	Ultra-Fox Plus fiber with 900µm tight-buffer = <b>5</b>															
11	Jacket color: Black = <b>K</b>															
12	Rating: OFC-LS = <b>A</b>															
13 – 14	Braided cable with Z jacket = <b>B2</b>															
16	Print in feet marks = <b>F</b> ; Print in meter marks = <b>M</b>															
17 – 19	For ABS-approved cable = <b>ABS</b>															

**Example:** 12-fiber low-smoke zero-halogen, distribution cable using 62.5µm Ultra-Fox fiber, black jacket printed in feet, braided and ABS-approved

**D X 0 1 2 Z W L S 9 K A B 2 - F A B S**

## (5.5c) DNV-Certified Shipboard Cables

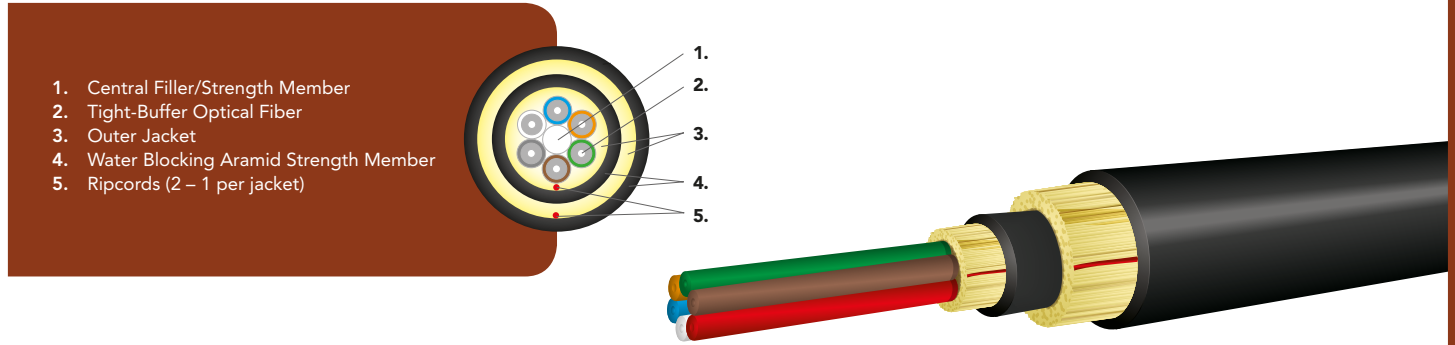

### Applications

- Approved by Det Norske Veritas (DNV)
- Signaling, communication, and data transmission for fixed and deployable networks on board ships and offshore structures with applications including; Mobile Offshore Drilling Units (MODUs), Floating Production Storage and Offloading (FPSO), Tension Leg Platforms (TLP), Liquefied Natural Gas (LNG)

### Features

- Low-Smoke Zero-Halogen (LSZH) cable
- Rugged cable for deck applications
- Flame-retardant
- 2- to 6-fiber double jacketed D-Series Distribution cable constructions are available
- Optical fiber types include 62.5/125, 50/125, and single-mode
- Available with 500µm primary acrylate-coated fiber for maximum mechanical and environmental protection of the optical fiber
- DNV Certified — DNV Type approval certificate No. E-14194
- Meets IEC standards for flame spread, smoke density and halogen content

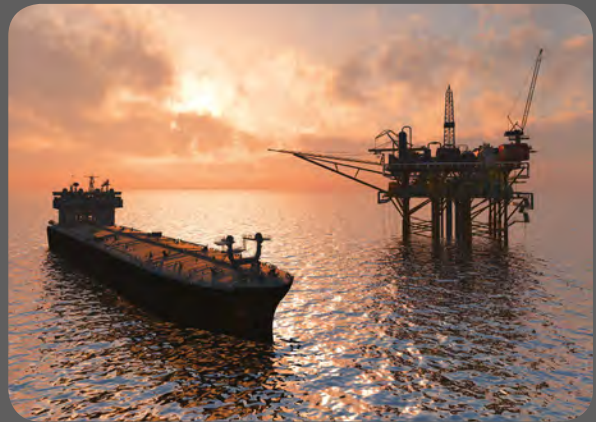

### Mechanical and Environmental Performance

Operating temperature	-40°C to +85°C
Storage temperature	-55°C to +85°C
Installation temperature (cable temp.)	-10°C to +60°C
Flame retardancy	IEC 60332-1, 60332-3
Impact resistance	IEC 60794-1-2-E4 Cat. A
Crush resistance	IEC 60794-1-2-E3 Cat. A



### Cable Characteristics: DNV Certified Shipboard Cables

FIBER COUNT	DIAMETER MM (IN)	WEIGHT KG/KM (LBS/1,000')	TENSILE LOAD		MINIMUM BEND RADIUS	
			INSTALLATION N (LBS)	OPERATIONAL N (LBS)	INSTALLATION CM (IN)	LONG-TERM CM (IN)
2-6	9.5 (0.37)	95 (64)	1,200 (270)	400 (90)	14.3 (3.2)	9.5 (2.1)

 (5.5c) DNV-Certified Shipboard Cables

## General Cable and Fiber Specifications

SPECIFICATION	TEST
IEC 60794-1-2-E1	Tensile Strength
IEC 60794-1-2-E3	Crush
IEC 60794-1-2-E4	Impact
IEC 60794-1-2-E6	Repeated Bending
IEC 60794-1-2-E7	Torsion
IEC 60794-1-2-E10	Kink
IEC 60794-1-2-E11	Cable Bend
IEC 60794-1-2-E11	Cold Bend Test
IEC 60794-2-F5	Water Penetration
IEC 60794-1-2-F1	Temperature Cycling
IEC 60332-1	Flame-Retardant
IEC 60332-3	Test on Bunched Wires or Cables, Cat. A

SPECIFICATION	TEST
IEC 60754-1	Halogen-Free Test
IEC 60754-2	Determination of Degree of Acidity of Gases
IEC 61034-2	Smoke Density
IEC 60811-1-1 Clause 9	Mechanical Characteristics Without Aging
IEC 60811-1-2 Subclause 8.1	Mechanical Characteristics After Aging in Air Oven
IEC 60811-3-1 Subclause 8.2	Maximum Permissible Deformation
IEC 60811-3-1	Heat Shock Test
IEC 60811-1-4	Elongation Test
IEC 60811-1-4 Sub clause 8.5	Cold Impact Test

## Ordering Information

Base cable part number is OC031016. The suffix indicated in the table is added to complete the part number based on the fiber type needed.

Example: 4-fiber DNV-Certified cable with WLS fiber = **OC031016-01**

FIBER COUNT	FIBER TYPE	FIBER BUFFER	SUFFIX
2	WLS	Ultra-Fox	-13
2	WST	Ultra-Fox Plus	-14
2	ALS	Ultra-Fox	-15
2	AST	Ultra-Fox Plus	-16
2	SLX	Ultra-Fox	-17
2	SLS	Ultra-Fox Plus	-18
4	WLS	Ultra-Fox	-01
4	WST	Ultra-Fox Plus	-02
4	ALS	Ultra-Fox	-03
4	AST	Ultra-Fox Plus	-04
4	SLX	Ultra-Fox	-05
4	SLS	Ultra-Fox Plus	-06
6	WLS	Ultra-Fox	-07
6	WST	Ultra-Fox Plus	-08
6	ALS	Ultra-Fox	-09
6	AST	Ultra-Fox Plus	-10
6	SLX	Ultra-Fox	-11
6	SLS	Ultra-Fox Plus	-12

## (5.5d) B-Series Breakout LSZH ABS-Approved Cables

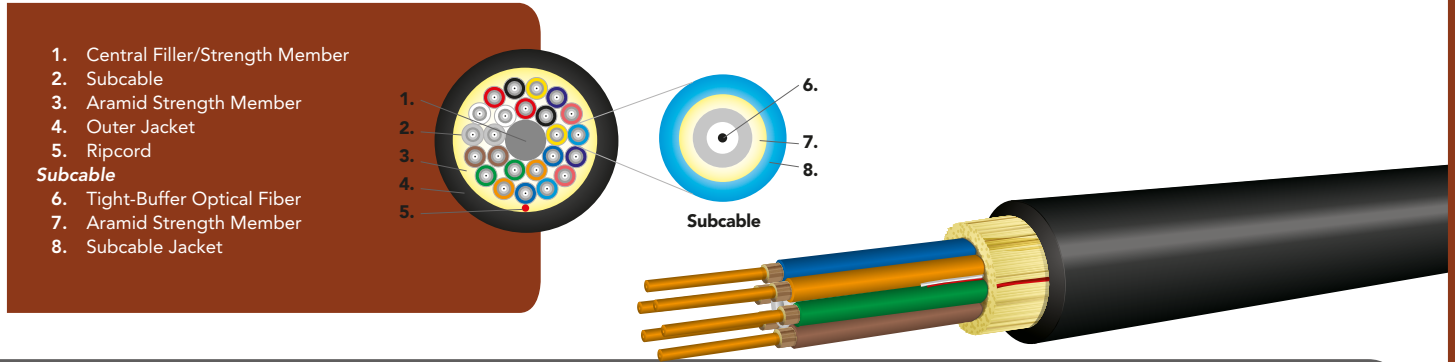

### Applications

- Approved by the American Bureau of Shipping (ABS)
- Marine and offshore tight-buffered cable design for use in installations requiring a flame-retardant, low-smoke and zero-halogen cable incorporating individual subcables for direct termination

### Features

- Zero-halogen construction meets IEC 60754-2
- Meets low-smoke requirements of UL 1685 and IEC 61034-2
- Flame-retardant per the requirements of IEC 60332-3-24 and UL 1666
- UL listed in accordance with NEC sections 770.179(b) for use in vertical runs in building riser shafts or from floor to floor
- ABS-approved for 2010 Steel Vessels Rules 1-1-4/7.7. 1-1 – Appendix 3, 4-8-3/9.1, 4-8-3/9.5 (I & II), 4-8-3/9.13
- ABS-approved for 2008 MODU Rules 4-3-3/5.1, 4-3-3/5.21, 4-3-4/13.1.6
- Suitable for indoor or outdoor applications
- Jacket is UV, fungus and moisture resistant
- Round cable construction for easy handling and termination
- Includes ripcord for easy outer jacket removal
- Rugged cable for deck applications
- Breakout style cable with 2 to 24 fibers
- Optical fiber types include 62.5/125, 50/125, and single-mode
- Available with 500µm primary acrylate-coated fiber for maximum mechanical and environmental protection of the optical fiber



### Applicable Standards

OCC B-Series Breakout Low-Smoke Zero-Halogen ABS-Approved Cables meet or exceed the functional requirements of the following standards:

- IEC 60332-3-24
- IEC 60754-2
- IEC 61034-2
- UL 1666 OFNR
- UL 1685 OFN-LS
- ICEA-S-104-696
- MIL-C-24643
- TIA-568
- TIA-598
- ABS Steel Vessels Rules
- ABS MODU Rules

### Mechanical and Environmental Performance

Operating temperature	-40°C to +70°C
Storage temperature	-40°C to +70°C
Installation temperature (cable temp.)	-20°C to +60°C
Flame retardancy	IEC 60332-3-24 UL listed OFNR-LS (UL 1666 & 1685), ABS type approved 06-HS166303
Smoke generation	IEC 61034-2
Zero-halogen	IEC 60754-2
Crush resistance (TIA-455-41)	2,200 N/cm
Flex resistance (TIA-455-104)	2,000 cycles



**(5.5d) B-Series Breakout LSZH ABS-Approved Cables**

## Cable Characteristics: B-Series Breakout LSZH ABS-Approved Cables (with 2.0mm subcables)

FIBER COUNT	DIAMETER MM (IN)	WEIGHT KG/KM (LBS/1,000')	TENSILE LOAD		MINIMUM BEND RADIUS	
			INSTALLATION N (LBS)	OPERATIONAL N (LBS)	INSTALLATION CM (IN)	LONG-TERM CM (IN)
2	8.1 (0.32)	66 (44)	1,600 (360)	400 (90)	12.1 (4.8)	8.1 (3.2)
4	8.1 (0.32)	66 (44)	1,600 (360)	400 (90)	12.1 (4.8)	8.1 (3.2)
6	9.1 (0.36)	82 (55)	2,400 (540)	600 (130)	13.7 (5.4)	9.1 (3.6)
8	10.4 (0.41)	108 (73)	3,200 (720)	800 (180)	15.6 (6.1)	10.4 (4.1)
12	11.6 (0.46)	131 (88)	4,800 (1,800)	1,200 (270)	17.4 (6.9)	11.6 (4.6)
18	12.8 (0.50)	162 (109)	7,200 (1,620)	1,800 (400)	19.2 (7.6)	12.8 (5.0)
24	15.0 (0.59)	219 (147)	9,600 (2,100)	2,400 (540)	22.5 (8.9)	15.0 (5.9)

## B-Series Breakout LSZH ABS-Approved Cables (with 2.5mm subcables)

FIBER COUNT	DIAMETER MM (IN)	WEIGHT KG/KM (LBS/1,000')	TENSILE LOAD		MINIMUM BEND RADIUS	
			INSTALLATION N (LBS)	OPERATIONAL N (LBS)	INSTALLATION CM (IN)	LONG-TERM CM (IN)
2	9.2 (0.36)	84 (56)	2,000 (450)	800 (180)	13.8 (5.4)	9.2 (3.6)
4	9.2 (0.36)	84 (56)	2,000 (450)	800 (180)	13.8 (5.4)	9.2 (3.6)
6	10.6 (0.42)	107 (72)	3,000 (670)	1,200 (270)	15.9 (6.3)	10.6 (4.2)
8	12.4 (0.49)	144 (97)	4,000 (900)	1,700 (3,800)	18.6 (7.3)	12.4 (4.9)
12	14.0 (0.55)	171 (115)	6,000 (1,350)	2,500 (560)	21.0 (8.3)	14.0 (5.5)
18	15.9 (0.63)	225 (151)	8,000 (1,800)	3,500 (790)	23.9 (9.4)	15.9 (6.3)
24	17.9 (0.70)	290 (195)	10,000 (2,250)	3,800 (850)	26.9 (10.6)	17.9 (7.0)

Installation loads in excess of 2,700N (600lbs.) are not recommended.

## Ordering Information

Digit No:	1	2	3	4	5	6	7	8	9	10	11	12	13	14	15	16	17
	<b>B</b>					<b>Z</b>				<b>9</b>	<b>K</b>	<b>E</b>	-		<b>A</b>	<b>B</b>	<b>S</b>
1	Breakout Series = <b>B</b>																
2	Ultra-Fox with 2.5mm subunits = <b>X</b> Ultra-Fox with 2.0mm subunits = <b>E</b>																
3 – 5	Fiber count: (see cable characteristics chart) = <b>002–024</b>																
6	Jacket type: Low-Smoke Zero-Halogen Jacket = <b>Z</b>																
7 – 9	Fiber type: (see Laser Ultra-Fox or Ultra-Fox Plus Fiber Performance Table, pg. 206–207)																
10	Ultra-Fox fiber with 900µm tight-buffer = <b>9</b> ; Ultra-Fox Plus fiber with 900µm tight-buffer = <b>5</b>																
11	Jacket color: Black = <b>K</b>																
12	Rating: Flame-Retardant Low-Smoke and Zero-Halogen = <b>E</b>																
14	For print in feet marks = <b>F</b> ; and for print in meter marks = <b>M</b>																
15 – 17	ABS-approved version = <b>ABS</b>																

**Example:** 12-fiber ABS-approved, 2.5mm subunits, low-smoke zero-halogen, breakout cable using 62.5µm Laser Ultra-Fox fiber, black jacket printed in feet

**B X 0 1 2 Z W L S 9 K E - F A B S**

## (5.5e) B-Series Breakout LSZH Braided Armor ABS-Approved Cables

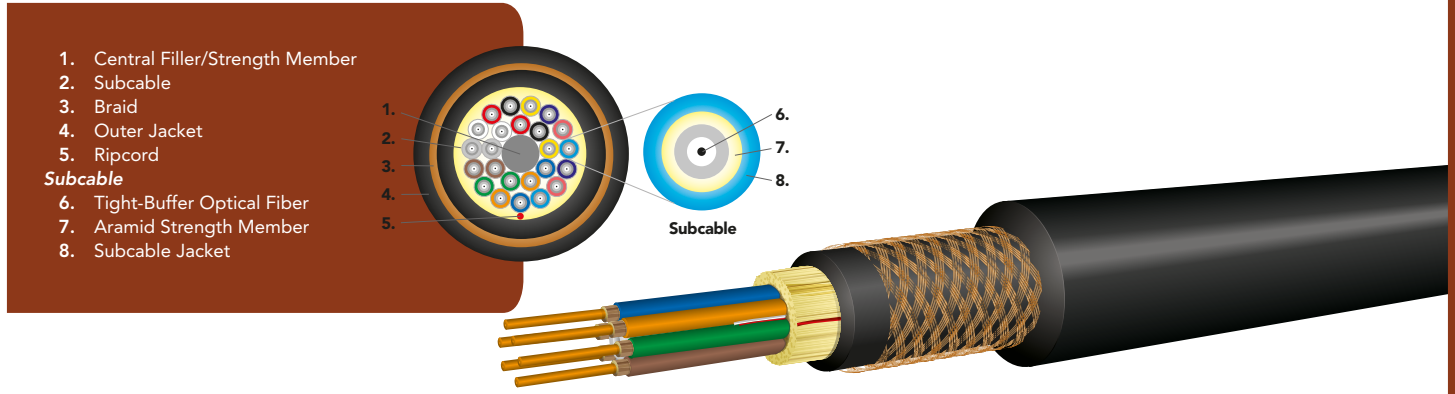

### Applications

- Approved by the American Bureau of Shipping (ABS)
- Marine and offshore tight-buffered cable design for use in installations requiring a flame-retardant, low-smoke and zero-halogen cable incorporating individual subcables for direct termination

### Features

- Zero-halogen construction meets IEC 60754-2
- Meets low-smoke requirements of UL 1685
- UL listed OFCR-LS
- ABS-Approved for 2010 Steel Vessels Rules 1-1-4/7.7, 1-1 – Appendix 3, 4-8-3/9.1, 4-8-3/9.5 (I & II), 4-8-3/9.13
- ABS-Approved for 2008 MODU Rules 4-3-3/5.1, 4-3-3/5.21, 4-3-4/13.1.6
- Bronze braid armor adds a degree of durability to limit damage due to abrasion
- Suitable for indoor or outdoor applications
- Jacket is UV, fungus and moisture resistant
- Round cable construction for easy handling and termination
- Includes ripcord for easy outer jacket removal
- Rugged breakout-style cable for deck applications with 2 to 24 fibers
- Optical fiber types include 62.5/125, 50/125, and single-mode
- Available with 500µm primary acrylate-coated fiber for maximum mechanical and environmental protection of the optical fiber
- Braid layer applied per IEEE 1580
- 2.0mm and 2.5mm subcables available



### Applicable Standards

OCC B-Series Breakout Low-Smoke Zero-Halogen Braided Armor ABS-Approved Cables meet or exceed the functional requirements of the following standards:

- IEC 60754-2
- UL 1666 OFCR
- UL 1685 OFCR-LS
- ICEA-S-104-696
- MIL-C-24643
- TIA-568
- TIA-598

### Mechanical and Environmental Performance

	ZERO-HALOGEN
Operating temperature	-40°C to +70°C
Storage temperature	-40°C to +70°C
Flame retardancy	UL 1666 OFCR UL 1685 OFCR-LS, ABS type approved 10-HS639311
Installation temperature (cable temp.)	-20°C to +60°C
Crush resistance (TIA-455-41)	2,200 N/cm





## (5.5e) B-Series Breakout LSZH Braided-Armor ABS-Approved Cables

### Cable Characteristics: B-Series Breakout LSZH Braided-Armor ABS-Approved Cables (with 2.0mm subcables)

FIBER COUNT	DIAMETER MM (IN)	WEIGHT KG/KM (LBS/1,000')	TENSILE LOAD		MINIMUM BEND RADIUS	
			INSTALLATION N (LBS)	OPERATIONAL N (LBS)	INSTALLATION CM (IN)	LONG-TERM CM (IN)
2	12.0 (0.47)	198 (133)	1,600 (360)	400 (90)	18.0 (7.1)	12.0 (4.7)
4	12.0 (0.47)	198 (133)	1,600 (360)	400 (90)	18.0 (7.1)	12.0 (4.7)
6	13.0 (0.51)	233 (157)	2,400 (540)	600 (130)	19.5 (7.7)	13.0 (5.1)
8	14.3 (0.56)	278 (187)	3,200 (720)	800 (180)	21.5 (8.5)	14.3 (5.6)
12	15.5 (0.61)	319 (214)	4,800 (1,800)	1,200 (270)	23.3 (9.2)	15.5 (6.1)
18	16.7 (0.66)	368 (247)	7,200 (1,620)	1,800 (400)	25.1 (9.9)	16.7 (6.6)
24	18.9 (0.74)	454 (305)	9,600 (2,100)	2,400 (540)	28.3 (11.1)	18.9 (7.4)

### B-Series Breakout LSZH Braided-Armor ABS-Approved Cables (with 2.5mm subcables)

FIBER COUNT	DIAMETER MM (IN)	WEIGHT KG/KM (LBS/1,000')	TENSILE LOAD		MINIMUM BEND RADIUS	
			INSTALLATION N (LBS)	OPERATIONAL N (LBS)	INSTALLATION CM (IN)	LONG-TERM CM (IN)
2	13.2 (0.52)	238 (160)	2,000 (450)	800 (180)	19.8 (7.8)	13.2 (5.2)
4	13.2 (0.52)	238 (160)	2,000 (450)	800 (180)	19.8 (7.8)	13.2 (5.2)
6	14.5 (0.57)	280 (188)	3,000 (670)	1,200 (270)	21.8 (8.6)	14.5 (5.7)
8	16.3 (0.64)	344 (231)	4,000 (900)	1,700 (3,800)	24.5 (9.6)	16.3 (6.4)
12	17.9 (0.70)	400 (269)	6,000 (1,350)	2,500 (560)	26.9 (10.5)	17.9 (7.0)
18	19.8 (0.78)	477 (321)	8,000 (1,800)	3,500 (790)	29.7 (11.7)	19.8 (7.8)
24	21.8 (0.86)	572 (384)	10,000 (2,250)	3,800 (850)	32.7 (12.9)	21.8 (8.6)

Installation loads in excess of 2,700N (600lbs.) are not recommended.

### Ordering Information

	<b>B</b>					<b>Z</b>				<b>9</b>	<b>K</b>	<b>R</b>	<b>B</b>	<b>2</b>	<b>-</b>		<b>A</b>	<b>B</b>	<b>S</b>
Digit No:	1	2	3	4	5	6	7	8	9	10	11	12	13	14	15	16	17	18	19

- 1 Breakout Series = **B**
- 2 Ultra-Fox with 2.5mm subunits = **X**  
Ultra-Fox with 2.0mm subunits = **E**
- 3 – 5 Fiber count: (see cable characteristics chart) = **002–024**
- 6 Jacket type: Low-Smoke Zero-Halogen Jacket = **Z**
- 7 – 9 Fiber type: (see Laser Ultra-Fox Fiber Performance Table, pg. 206)
- 10 Ultra-Fox fiber with 900µm tight-buffer = **9**  
Ultra-Fox Plus fiber with 900µm tight-buffer = **5**
- 11 Jacket color: Black = **K**
- 12 Rating: Riser = **R**
- 13 – 14 Braid Option: Zero-Halogen Braid = **B2**
- 16 Print in feet marks = **F**; Print in meter marks = **M**
- 17 – 19 For ABS-approved cable = **ABS**

**Example:** 12-fiber low-smoke zero-halogen, distribution cable using 62.5µm Laser Ultra-Fox fiber, black jacket printed in feet, braided and ABS-approved

<b>B</b>	<b>X</b>	<b>0</b>	<b>1</b>	<b>2</b>	<b>Z</b>	<b>W</b>	<b>L</b>	<b>S</b>	<b>9</b>	<b>K</b>	<b>R</b>	<b>B</b>	<b>2</b>	<b>-</b>	<b>F</b>	<b>A</b>	<b>B</b>	<b>S</b>
----------	----------	----------	----------	----------	----------	----------	----------	----------	----------	----------	----------	----------	----------	----------	----------	----------	----------	----------

## (5.5f) Pierside Cables

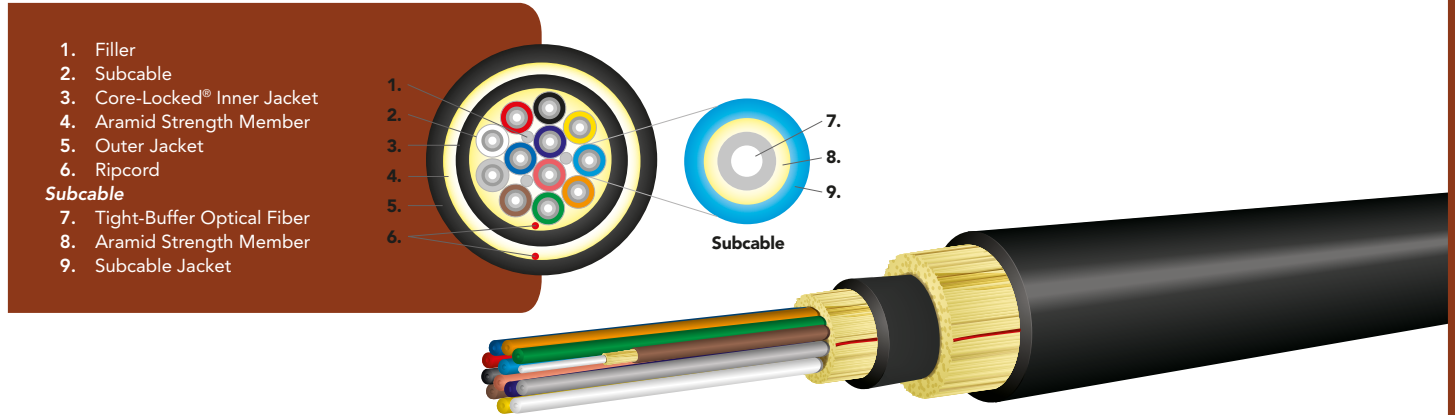

### Applications

- Ship-to-shore communications in a fiber optic cable meeting the requirements of NAVSEA Specification 7379173
- Cables designed to be integrated with OCC's Pierside connectors designed to meet NAVSEA 7379171 specification

### Features

- Dual jacketed, 12-fiber cable with 4 single-mode and 8 multimode fibers is designed to the NAVSEA 7379173 specification
- 2-, 4-, 6- and 8-fiber cables are designed with the NAVSEA 7379173 specification as a guide. See the Cable Characteristics section for cable performance requirements
- Available in composite single-mode and multimode fiber combinations, with fibers appropriate to the performance characteristics required by the application
- Compatible with Pierside connectors as defined in NAVSEA 7379171 (see OCC Pierside Connectors in the Harsh Environment Connectors, section 6.6b of the catalog)
- Polyurethane jacket provides durability in harsh environments encountered on ships and docks
- Polyurethane jacketed for abrasion, cut, crush, impact, and chemical resistance
- Second layer of aramid yarns provides the necessary strain-relief for multichannel hermaphroditic connectors
- Extremely strong, lightweight, rugged, survivable tight-buffered design
- Breakout cable design utilizes individual color-coded subcables that protect each individual fiber and have their own aramid for capture to the crimp on the terminus when desired
- Special jacket colors are available to distinguish (at a glance) from other Pierside cables and utilities
- Triple thickness fiber acrylate coating, three layers of aramid yarn, and three individual cable jackets provide the ultimate in fiber protection
- Suitable for daisy chain over-the-deck, on-the-pier, and through-the-ship nested ship deployments
- Helically stranded cable core for flexibility, deployment survivability and exceptional mechanical protection for the optical fibers
- Wide Temperature ranges for adverse conditions
- 2.0mm breakout subcables standard
- Compatible with OCC's Pierside hermaphroditic connectors in Section 6.7b



U.S. Navy photo by Mass Communication Specialist 2nd Class James R. Evans



### Applicable Standards

OCC Pierside cables meet or exceed the functional requirements of the following standards:

- NAVSEA Specification 7379173
- TIA-455 commercial and military requirements

 (5.5f) Pierside Cables

## Mechanical and Environmental Performance

Operating temperature	-55°C to +85°C
Storage temperature	-70°C to +85°C
Impact resistance	1,500 impacts
Crush resistance	2,200 N/cm
Flex resistance	2,000 cycles

## Cable Characteristics: Pierside

FIBER COUNT	DIAMETER MM (IN)	WEIGHT KG/KM (LBS/1,000')	TENSILE LOAD		MINIMUM BEND RADIUS	
			INSTALLATION N (LBS)	OPERATIONAL N (LBS)	INSTALLATION CM (IN)	LONG-TERM CM (IN)
2	11.3 (0.44)	112 (75)	6,400 (1,500)	1,200 (270)	17.0 (6.7)	11.3 (4.4)
4	11.3 (0.44)	112 (75)	6,400 (1,500)	1,200 (270)	17.0 (6.7)	11.3 (4.4)
6	12.2 (0.48)	125 (84)	6,400 (1,500)	1,200 (270)	18.3 (7.2)	12.2 (4.8)
8	13.6 (0.54)	153 (103)	6,400 (1,500)	1,200 (270)	20.4 (8.0)	13.6 (5.4)
12	14.5 (0.57)	168 (113)	6,400 (1,500)	1,200 (270)	21.8 (8.6)	14.5 (5.7)

Note: Multimode, single-mode and composite designs available

## Cable Outer Diameter Limits for Cable Plug Strain Relief

CONNECTOR PLUG TYPE	MINIMUM CABLE OUTER DIAMETER MM (INCHES)	MAXIMUM CABLE OUTER DIAMETER MM (INCHES)
CP-6	6.5 (0.256)	9.5 (0.374)
CP-8	11.0 (0.433)	13.7 (0.540)
CP-12	14.0 (0.551)	16.2 (0.639)

## Ordering Information

	<b>B</b>	-				<b>C</b>				<b>5</b>	<b>K</b>	<b>M</b>	<b>P</b>	<b>S</b>
Digit No:	1	2	3	4	5	6	7	8	9	10	11	12	13	14

- 1 – 2 Breakout Series Ultra-Fox Plus = **B** –
- 3 – 5 Fiber count: (see cable characteristics chart) = **002–012**
- 6 Jacket type: Polyurethane = **C**
- 7 – 9 Fiber type:  
Standard is 8 WST and 4 SLS = **ZBK**
- 10 Ultra-Fox Plus fiber with 900µm tight-buffer = **5**
- 11 Jacket color: Black = **K**
- 12 Rating: Military Cable Rating = **M**
- 13 – 14 Pierside Cable Construction = **PS**

**Example:** 12-fiber Pierside cable with C jacket, low water peak single-mode fiber, Ultra-Fox Plus, black jacket

<b>B</b>	-	<b>0</b>	<b>1</b>	<b>2</b>	<b>C</b>	<b>S</b>	<b>L</b>	<b>S</b>	<b>5</b>	<b>K</b>	<b>M</b>	<b>P</b>	<b>S</b>
----------	---	----------	----------	----------	----------	----------	----------	----------	----------	----------	----------	----------	----------

## (5.6a) B-Series Breakout – Riser Rated Tray Cables

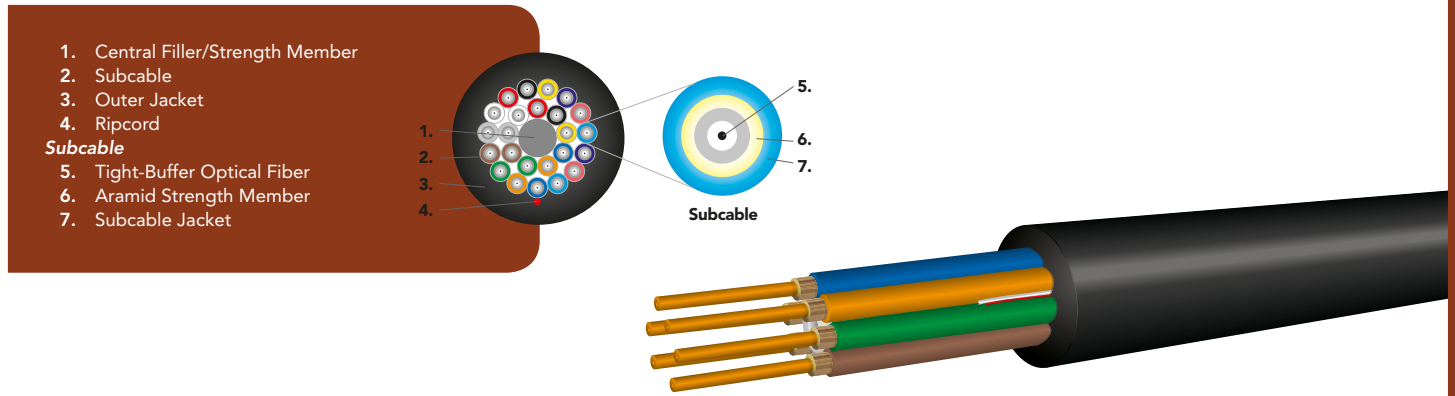

### Applications

- Ideal for installations requiring an extremely rugged and reliable cable design where maximum mechanical and environmental protection are necessary
- Typical industrial uses are factory automation, power generation and other utilities, oil and gas refining, and surface mining
- Easiest cable to install where direct termination of the subcable to a connector and a direct run to panels and equipment are desired
- Ideal for locations requiring low-temperature performance along with a flame rating

### Features

- Individual fibers and strength members protected in a subcable configuration
- Most rugged cable design with individual subcables for routing to diverse intelligent devices with direct connector termination at each device
- Independently tested to CSA C22.2 No. 230 (tray cables)
- Fibers may be directly terminated at factory devices or central locations using connectors with no further protection required
- J jacket is UV, fungus and moisture resistant
- Designed for indoor/outdoor installations, including cable trays
- 2 to 72 fiber counts are available with 2.0mm or 2.5mm subcables
- Low-temperature PVC outer jacket (J material) provides excellent performance and flexibility at low temperatures
- Wide operating temperature range of -50°C to +75°C
- Core-Locked™ jacket prevents cable from flattening and the jacket from wrinkling in tight-bends
  - Permits pulling with direct attachment of wire mesh grip; no need to access inner aramid strength members
  - Improves crush and tear resistance
  - Contains 25% more material than conventional jackets
- High crush and tensile load ratings compared to similar tray service fiber optic cables
- Oil resistant for use in industrial applications
- UL listed in accordance with NEC section 770.179(b) for use in vertical runs in building riser shafts or from floor to floor
- Designed to exceed the flammability requirements of Chapter 8 of IEEE 383



 (5.6a) B-Series Breakout – Riser Rated Tray Cables

## Mechanical and Environmental Performance

	INDOOR/OUTDOOR
Operating temperature	-50°C to +75°C
Storage temperature	-55°C to +85°C
Installation temperature (cable temp.)	-30°C to +60°C
Flame retardancy	UL listed type OFNR (UL 1666) and FT4 (CSA C22.2 No. 232)
Crush resistance (TIA-455-41)	2,200 N/cm
Flex resistance (TIA-455-104)	2,000 cycles

### Cable Characteristics: B-Series Breakout Riser Rated Tray Cables (with 2.0mm subcables)

FIBER COUNT	DIAMETER MM (IN)	WEIGHT KG/KM (LBS/1,000')	TENSILE LOAD		MINIMUM BEND RADIUS	
			INSTALLATION N (LBS)	OPERATIONAL N (LBS)	INSTALLATION CM (IN)	LONG-TERM CM (IN)
2	6.0 (0.24)	40 (27)	800 (180)	200 (40)	9.0 (3.5)	6.0 (2.4)
4	6.9 (0.27)	52 (35)	1,600 (360)	400 (90)	10.4 (4.1)	6.9 (2.7)
6	8.1 (0.32)	67 (45)	2,400 (540)	600 (130)	12.2 (4.8)	8.1 (3.2)
8	9.4 (0.37)	88 (59)	3,200 (720)	800 (180)	14.1 (5.6)	9.4 (3.7)
12	10.9 (0.43)	108 (73)	4,800 (1,000)	1,200 (270)	16.4 (6.5)	10.9 (4.3)
18	12.6 (0.50)	156 (105)	6,000 (1,350)	1,500 (340)	18.9 (7.4)	12.6 (5.0)
24	14.7 (0.58)	218 (146)	7,200 (1,600)	1,800 (400)	22.1 (8.7)	14.7 (5.8)
30	16.8 (0.66)	268 (180)	9,600 (2,100)	2,400 (540)	25.2 (9.9)	16.8 (6.6)
36	16.8 (0.66)	266 (179)	9,600 (2,100)	2,400 (540)	25.2 (9.9)	16.8 (6.6)
48	20.1 (0.79)	387 (260)	12,000 (2,700)	3,000 (680)	30.2 (11.9)	20.1 (7.9)
60	22.7 (0.89)	489 (329)	15,000 (3,400)	3,750 (850)	34.1 (13.4)	22.7 (8.9)
72	26.0 (1.02)	652 (438)	16,800 (3,800)	4,200 (900)	39.0 (15.4)	26.0 (10.2)

Installation loads in excess of 2,700 N (600 lbs.) are not recommended.

## (5.6a) B-Series Breakout – Riser Rated Tray Cables

### Cable Characteristics: Breakout Tray Cables (with 2.5mm subcables)

FIBER COUNT	DIAMETER MM (IN)	WEIGHT KG/KM (LBS/1,000')	TENSILE LOAD		MINIMUM BEND RADIUS	
			INSTALLATION N (LBS)	OPERATIONAL N (LBS)	INSTALLATION CM (IN)	LONG-TERM CM (IN)
2	7.0 (0.28)	41 (28)	1,200 (270)	500 (110)	10.5 (4.1)	7.0 (2.8)
4	8.3 (0.33)	68 (46)	2,000 (450)	800 (180)	12.5 (4.9)	8.3 (3.3)
6	9.6 (0.38)	88 (59)	3,000 (670)	1,200 (270)	14.4 (5.7)	9.6 (3.8)
8	11.6 (0.46)	133 (89)	4,000 (900)	1,700 (380)	17.4 (6.9)	11.6 (4.6)
12	14.1 (0.55)	159 (107)	6,000 (1,350)	2,500 (560)	21.2 (8.3)	14.1 (5.5)
18	15.3 (0.60)	226 (152)	8,000 (1,800)	3,500 (790)	23.0 (9.1)	15.3 (6.0)
24	17.6 (0.69)	292 (196)	10,000 (2,250)	3,800 (850)	26.4 (10.4)	17.6 (6.9)
30	20.9 (0.82)	383 (257)	14,000 (3,150)	6,000 (1,350)	31.4 (12.3)	20.9 (8.2)
36	20.9 (0.82)	375 (252)	14,000 (3,150)	6,000 (1,350)	31.4 (12.3)	20.9 (8.2)
48	24.2 (0.95)	501 (336)	18,000 (4,050)	7,500 (1,690)	36.3 (14.3)	24.2 (9.5)
60	28.5 (1.12)	773 (519)	22,000 (4,950)	8,800 (1,980)	42.8 (16.8)	28.5 (11.2)
72	28.9 (1.14)	768 (516)	26,000 (5,845)	11,000 (2,470)	43.4 (17.1)	28.9 (11.4)

Installation loads in excess of 2,700 N (600 lbs.) are not recommended. Other fiber counts available upon request.

### Ordering Information

	<b>B</b>					<b>J</b>				<b>9</b>	<b>K</b>	<b>R</b>
Digit No:	1	2	3	4	5	6	7	8	9	10	11	12

- 1 – 2 Breakout Series Ultra-Fox Tray Cables:  
2.0mm Subcables = **BE**  
2.5mm Subcables = **BX**
- 3 – 5 Fiber count: (see cable characteristics chart) = **002–072**
- 6 Jacket type: Indoor/Outdoor Tray = **J**
- 7 – 9 Fiber type: (see Laser Ultra-Fox Fiber Performance Table, pg. 206)
- 10 Ultra-Fox fiber with 900µm tight-buffer = **9**
- 11 Standard jacket color: Black = **K**
- 12 Rating: Riser = **R**

**Example:** 12-fiber riser rated tray cable using OM3 laser optimized bend-insensitive fiber, Ultra-Fox, 2.5mm subcable, black jacket

<b>B</b>	<b>X</b>	<b>0</b>	<b>1</b>	<b>2</b>	<b>J</b>	<b>A</b>	<b>L</b>	<b>T</b>	<b>9</b>	<b>K</b>	<b>R</b>
----------	----------	----------	----------	----------	----------	----------	----------	----------	----------	----------	----------





## (5.6b) G-Series Subgrouping – Riser Rated Tray Cables

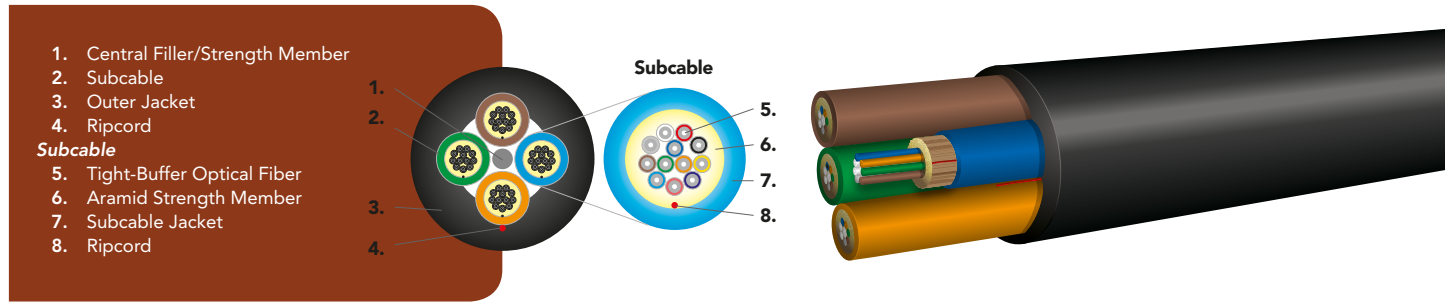

### Applications

- Ideal for installations requiring a rugged and reliable cable design where maximum mechanical and environmental protection are necessary
- Typical industrial uses are factory automation, power generation and other utilities, oil and gas refining, and surface mining

### Features

- Best design for multimode and single-mode fiber hybrid/composite cables
- Design allows multi-fiber subcables to be routed to multiple locations such as wiring racks and closets
- Independently tested to CSA C22.2 No. 230 (tray cables)
- Color-coded subcables are easy to identify for improved cable management in routing and termination
- Designed for indoor/outdoor installations, including cable trays
- 12- to 144-fiber configurations are available with 6 or 12 fibers per subcable
- Low-temperature PVC outer jacket (J material) provides excellent performance and flexibility at low temperatures
- Jacket is UV, fungus and moisture resistant
- Wide operating temperature range of -50°C to +75°C
- Core-Locked™ jacket prevents cable from flattening and the jacket from wrinkling in tight bends
  - Permits pulling with direct attachment of wire mesh grip; no need to access inner aramid strength members
  - Improves crush and tear resistance
  - Contains 25% more material than conventional jackets
- High crush and tensile load ratings compared to similar tray service fiber optic cables
- Oil resistant for use in industrial applications
- UL listed in accordance with NEC section 770.179(b) for use in vertical runs in building riser shafts or from floor to floor
- Designed to exceed the flammability requirements of Chapter 8 IEEE 383



### Mechanical and Environmental Performance

	INDOOR/OUTDOOR
Operating temperature	-50°C to +75°C
Storage temperature	-55°C to +85°C
Installation temperature (cable temp.)	-30°C to +60°C
Flame retardancy	UL listed type OFNR (UL 1666) FT4 (CSA C22.2 No. 232)
Crush resistance (TIA-455-41)	2,100 N/cm
Flex resistance (TIA-455-104)	2,000 cycles

### Applicable Standards

OCC indoor/outdoor tight-buffered fiber optic cables meet or exceed the functional requirements of the following standards:

- ICEA-S-83-596
- ICEA-S-104-696
- GR-409-CORE ISSUE 2
- TIA-568
- TIA-598
- UL 1666
- CSA C22.2 NO. 232
- CSA C22.2 NO. 230

Consistent with the definition in TIA-440-B "Fiber Optic Terminology," hybrid cable is defined as a cable containing both optical fibers and electrical conductors. Composite cable is defined as a cable containing mixed fiber types. Prior to 2012 some U.S. standards documents use definitions for hybrid and composite which are opposite of those stated here. The change in convention was made in the interest of harmonization with International standards and other National standards.

## (5.6b) G-Series Subgrouping – Riser Rated Tray Cables

### G-Series Subgrouping Tray Cable with 6-Fiber Subcables (4.5mm subcables)

FIBER COUNT	DIAMETER MM (IN)	WEIGHT KG/KM (LBS/1,000')	TENSILE LOAD		MINIMUM BEND RADIUS	
			INSTALLATION N (LBS)	OPERATIONAL N (LBS)	INSTALLATION CM (IN)	LONG-TERM CM (IN)
12	14.6 (0.57)	221 (149)	3,800 (850)	1,200 (270)	21.9 (8.6)	14.6 (5.7)
18	14.6 (0.57)	222 (149)	4,700 (1,060)	1,800 (400)	21.9 (8.6)	14.6 (5.7)
24	14.6 (0.57)	223 (150)	5,600 (1,260)	1,900 (420)	21.9 (8.6)	14.6 (5.7)
30	15.6 (0.61)	254 (171)	7,500 (1,690)	2,400 (540)	23.4 (9.2)	15.6 (6.1)
36	16.9 (0.67)	297 (200)	8,900 (2,000)	2,850 (640)	25.4 (10.0)	16.9 (6.7)

### G-Series Subgrouping Tray Cable with 12-Fiber Subcables (5.5mm subcables)

FIBER COUNT	DIAMETER MM (IN)	WEIGHT KG/KM (LBS/1,000')	TENSILE LOAD		MINIMUM BEND RADIUS	
			INSTALLATION N (LBS)	OPERATIONAL N (LBS)	INSTALLATION CM (IN)	LONG-TERM CM (IN)
24	16.6 (0.65)	274 (184)	4,600 (1,030)	1,500 (340)	24.9 (9.8)	16.6 (6.5)
36	16.6 (0.65)	272 (183)	5,900 (1,330)	1,050 (440)	24.9 (9.8)	16.6 (6.5)
48	16.6 (0.65)	270 (181)	7,200 (1,620)	2,400 (540)	24.9 (9.8)	16.6 (6.5)
60	18.4 (0.72)	323 (217)	9,500 (2,140)	3,150 (710)	27.6 (10.9)	18.4 (7.2)
72	20.1 (0.79)	380 (255)	11,300 (2,540)	3,750 (840)	30.2 (11.9)	20.1 (7.9)
84	21.8 (0.86)	443 (298)	13,100 (2,950)	4,350 (980)	32.7 (12.9)	21.8 (8.6)
96	23.6 (0.93)	513 (345)	14,900 (3,350)	4,950 (1,110)	35.4 (13.9)	23.6 (9.3)
108	25.7 (1.01)	608 (409)	18,200 (4,090)	6,000 (1,350)	38.6 (15.2)	25.7 (10.1)
120	27.7 (1.09)	707 (475)	19,500 (4,380)	6,450 (1,450)	41.6 (16.4)	27.7 (10.9)
132	28.1 (1.11)	669 (450)	20,800 (4,680)	6,900 (1,550)	42.2 (16.6)	28.1 (11.1)
144	28.1 (1.11)	668 (449)	22,100 (4,970)	7,350 (1,650)	42.2 (16.6)	28.1 (11.1)

Installation loads in excess of 2,700 N (600 lbs.) are not recommended. Other fiber counts available upon request.

## Ordering Information

Digit No:	G					J				9	K	R
1	1	2	3	4	5	6	7	8	9	10	11	12
1	Subgrouping Series Ultra-Fox = <b>G</b>											
2	6-fiber subcables = <b>B</b> ; 12-fiber subcables = <b>X</b>											
3 – 5	Fiber count: 6-fiber subcables = <b>012–036</b> , 12-fiber subcables = <b>024–144</b>											
6	Jacket type: Indoor/Outdoor Tray = <b>J</b>											
7 – 9	Fiber type: (see Laser Ultra-Fox Fiber Performance Table, pg. 206)											
10	Ultra-Fox fiber with 900µm tight-buffer = <b>9</b>											
11	Standard jacket colors: Black = <b>K</b> (other jacket colors available upon request)											
12	Rating: Riser = <b>R</b>											

**Example:** 48-fiber riser rated tray cable (12-fiber subcables) using 62.5µm standard Laser Ultra-Fox fiber, black jacket

**G X 0 4 8 J W L S 9 K R**

### (5.6c) D-Series Distribution – Interlocking Armor (ILA) Riser Rated Cables

1. Central Filler/Strength Member
2. Tight-Buffer Optical Fiber
3. Aramid Strength Member
4. Inner Jacket
5. Aluminum Interlocking Armor
6. Outer Jacket
7. Ripcord

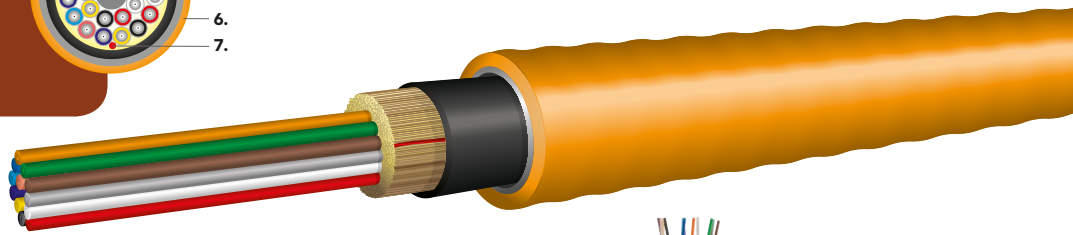
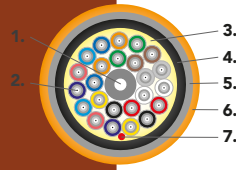

#### Applications

- Ideal for industrial and other installations requiring a metallic conduit
- Interlocking preloaded armor may eliminate the need for conduit, reducing installation costs

#### Features

- Inner cable is a fully functional D-Series Distribution Riser Rated Cable
- UL listed in accordance with NEC section 770.179(b) for use in vertical runs in building risers or from floor to floor
- Aluminum interlocking armor with PVC overjacket
- Interlocking armor can be easily removed, leaving an intact inner cable
- Greater flexibility than standard corrugated steel-armored (CST) cables
- Ideal for locations that would otherwise require conduit for cable protection
- Wide operating temperature of -40°C to +85°C



#### Mechanical and Environmental Performance

	INDOOR/OUTDOOR
Operating temperature	-40°C to +85°C
Storage temperature	-55°C to +85°C
Installation temperature (cable temp.)	0°C to +60°C
Flame retardancy	UL listed type OFCR (UL 1666)
Crush resistance (TIA-455-41)	650 N/cm
Flex resistance (TIA-455-104)	25 cycles

#### Applicable Standards

OCC indoor/outdoor tight-buffered fiber optic cables meet or exceed the functional requirements of the following standards:

- UL 1666
- UL 1651
- ICEA-S-83-596

## (5.6c) D-Series Distribution – Interlocking Armor (ILA) Riser Rated Cables

### Cable Characteristics: D-Series Distribution Interlocking Armor (ILA) Riser Rated Cables

FIBER COUNT	DIAMETER MM (IN)	WEIGHT KG/KM (LBS/1,000')	TENSILE LOAD		MINIMUM BEND RADIUS	
			INSTALLATION N (LBS)	OPERATIONAL N (LBS)	INSTALLATION CM (IN)	LONG-TERM CM (IN)
2	13.1 (0.52)	158 (106)	1,350 (300)	400 (90)	26.2 (10.3)	19.7 (7.8)
4	13.1 (0.52)	158 (106)	1,350 (300)	400 (90)	26.2 (10.3)	19.7 (7.8)
6	13.1 (0.52)	158 (106)	1,350 (300)	400 (90)	26.2 (10.3)	19.7 (7.8)
8	13.6 (0.54)	167 (112)	1,350 (300)	400 (90)	27.2 (10.7)	20.4 (8.0)
10	14.1 (0.56)	180 (121)	1,350 (300)	400 (90)	28.2 (11.1)	21.2 (8.3)
12	15.1 (0.59)	201 (135)	1,350 (300)	400 (90)	30.2 (11.9)	22.7 (8.9)
18	15.1 (0.59)	200 (134)	1,350 (300)	400 (90)	30.2 (11.9)	22.7 (8.9)
24	16.7 (0.66)	239 (161)	1,350 (300)	400 (90)	33.4 (13.1)	25.1 (9.9)
30	17.2 (0.68)	255 (171)	1,350 (300)	400 (90)	34.4 (13.5)	25.8 (10.2)
36	17.2 (0.68)	253 (170)	1,350 (300)	400 (90)	34.4 (13.5)	25.8 (10.2)
48	18.2 (0.72)	284 (191)	1,350 (300)	400 (90)	36.4 (14.3)	27.3 (10.7)

### Ordering Information

Digit No:	1	2	3	4	5	6	7	8	9	10	11	12	13	14
	D	X				D				9		R	I	2
1 – 2	DX-Series Distribution Ultra-Fox = <b>DX</b>													
3 – 5	Fiber count: (see cable characteristics chart) = <b>002–048</b>													
6	Jacket type: Indoor/Outdoor PVC = <b>D</b>													
7 – 9	Fiber type: (see Laser Ultra-Fox Fiber Performance Table, pg. 206)													
10	Ultra-Fox fiber with 900µm tight-buffer = <b>9</b>													
11	Standard jacket color: (outer armor)													
	62.5µm multimode (WLS, WLX): Orange = <b>O</b>													
	50µm multimode (ALS, ALX): Orange = <b>O</b>													
	50µm 10 Gigabit multimode (ALT, ALE): Aqua = <b>Q</b>													
	Single-mode: Yellow = <b>Y</b>													
12	Rating: Riser = <b>R</b>													
13 – 14	Indoor/Outdoor PVC jacket with Interlocking Armor = <b>I2</b>													

**Example:** 12-fiber distribution cable using OM3 laser optimized bend-insensitive fiber, Ultra-Fox, aqua, PVC, printed in feet

**D X 0 1 2 D A L T 9 Q R I 2**

### (5.6d) D-Series Distribution – Interlocking Armor (ILA) Plenum Rated Cables

1. Central Filler/Strength Member
2. Tight-Buffer Optical Fiber
3. Aramid Strength Member
4. Inner Jacket
5. Aluminum Interlocking Armor
6. Outer Jacket
7. Ripcord

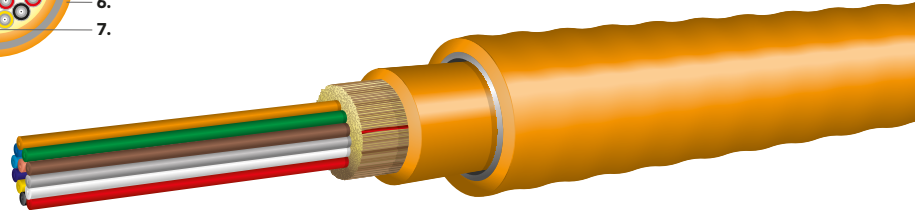
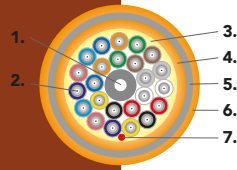

### Applications

- Ideal for industrial and other installations requiring a metallic conduit
- Interlocking preloaded armor may eliminate the need for conduit, reducing installation costs

### Features

- UL listed in accordance with NEC section 770.179(a) for use in ducts, plenums and air-handling spaces
- Aluminum interlocking armor with flexible plenum (S) or fluoropolymer (K) overjacket
- Greater flexibility than standard corrugated steel-armored (CST) cables
- Interlocking armor can be easily removed, leaving an intact inner plenum rated cable for installation into plenums and air-handling spaces
- Wide operating temperature of -40°C to +85°C for indoor/outdoor (K Jacket)

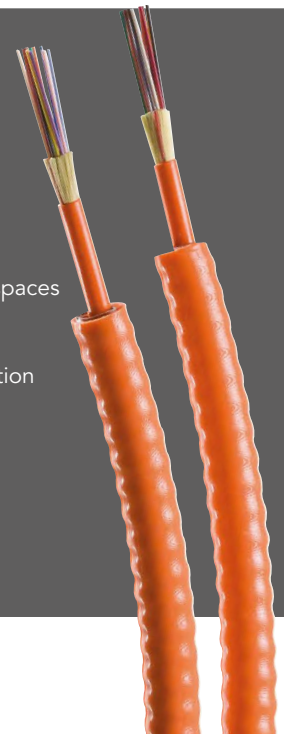

### Mechanical and Environmental Performance

	INDOOR/OUTDOOR (K)	INDOOR (S)
	PVDF Plenum	Soft Plenum
Jacket type	K	S
Operating temperature	-40°C to +85°C	0°C to +70°C
Storage temperature	-40°C to +85°C	-40°C to +70°C
Installation temperature (cable temp.)	0°C to +60°C	0°C to +60°C
Flame retardancy	UL listed type OFCP (ANSI/NFPA 262) and FT6 (CSA C22.2 No. 232)	UL listed type OFCP (ANSI/NFPA 262) and FT6 (CSA C22.2 No. 232)
Crush resistance (TIA-455-41)	650 N/cm	650 N/cm
Flex cycles (TIA-455-104)	25	25

### Applicable Standards

OCC indoor/outdoor tight-buffered fiber optic cables meet or exceed the functional requirements of the following standards:

- ANSI/NFPA 262
- ICEA-S-83-596
- UL 1651
- CSA C22.2 No. 232

## (5.6d) D-Series Distribution – Interlocking Armor (ILA) Plenum Rated Cables

### Cable Characteristics: D-Series Distribution Interlocking Armor (ILA) Plenum Cables (Indoor/Outdoor “K” Jacket)

FIBER COUNT	DIAMETER MM (IN)	WEIGHT KG/KM (LBS/1,000')	TENSILE LOAD		MINIMUM BEND RADIUS	
			INSTALLATION N (LBS)	OPERATIONAL N (LBS)	INSTALLATION CM (IN)	LONG-TERM CM (IN)
2	13.1 (0.52)	175 (118)	1,350 (300)	400 (90)	26.2 (10.3)	19.7 (7.8)
4	13.1 (0.52)	175 (118)	1,350 (300)	400 (90)	26.2 (10.3)	19.7 (7.8)
6	13.1 (0.52)	175 (118)	1,350 (300)	400 (90)	26.2 (10.3)	19.7 (7.8)
8	13.1 (0.52)	179 (120)	1,350 (300)	400 (90)	26.2 (10.3)	19.7 (7.8)
12	14.1 (0.56)	209 (140)	1,350 (300)	400 (90)	28.2 (11.1)	21.2 (8.3)
18	14.1 (0.56)	209 (140)	1,350 (300)	400 (90)	28.2 (11.1)	21.2 (8.3)
24	16.1 (0.63)	264 (177)	1,350 (300)	400 (90)	32.2 (12.7)	24.2 (9.5)
36	16.1 (0.63)	273 (183)	1,350 (300)	400 (90)	32.2 (12.7)	24.2 (9.5)
48	17.7 (0.70)	320 (215)	1,350 (300)	400 (90)	35.4 (13.9)	26.6 (10.5)

### D-Series Distribution Interlocking Armor (ILA) Plenum Cables (Indoor “S” Jacket)

FIBER COUNT	DIAMETER MM (IN)	WEIGHT KG/KM (LBS/1,000')	TENSILE LOAD		MINIMUM BEND RADIUS	
			INSTALLATION N (LBS)	OPERATIONAL N (LBS)	INSTALLATION CM (IN)	LONG-TERM CM (IN)
2	11.8 (0.46)	123 (83)	1,350 (300)	400 (90)	23.6 (9.3)	17.7 (7.0)
4	11.8 (0.46)	123 (83)	1,350 (300)	400 (90)	23.6 (9.3)	17.7 (7.0)
6	11.8 (0.46)	123 (83)	1,350 (300)	400 (90)	23.6 (9.3)	17.7 (7.0)
8	11.8 (0.46)	137 (92)	1,350 (300)	400 (90)	23.6 (9.3)	17.7 (7.0)
12	12.8 (0.50)	161 (108)	1,350 (300)	400 (90)	25.6 (10.1)	19.2 (7.6)

### Ordering Information

	<b>D</b>	<b>X</b>							<b>9</b>		<b>P</b>			
Digit No:	1	2	3	4	5	6	7	8	9	10	11	12	13	14
1 – 2	Distribution Series Ultra-Fox = <b>DX</b>													
3 – 5	Fiber count: (see cable characteristics chart) S Jacket = <b>002-012</b> K Jacket = <b>002-048</b>													
6	Jacket type: Indoor/Outdoor Fluoropolymer = <b>K</b> ; Indoor Plenum = <b>S</b>													
7 – 9	Fiber type: (see Laser Ultra-Fox Fiber Performance Table, pg. 206)													
10	Ultra-Fox fiber with 900µm tight-buffer = <b>9</b>													
11	Standard jacket color: 62.5µm multimode (WLS, WLX) – Orange = <b>O</b> 50µm multimode (ALS, ALX) – Orange = <b>O</b> 50µm 10 Gigabit (ALT, ALE) – Aqua = <b>Q</b> Single-mode – Yellow = <b>Y</b>													
12	Rating: Plenum = <b>P</b>													
13 – 14	Indoor/Outdoor Interlocking Armor = <b>I6</b> ; Indoor Interlocking Armor = <b>I7</b>													

**Example:** 12-fiber distribution cable using 62.5µm standard Laser Ultra-Fox fiber, indoor/outdoor interlocking armor, orange jacket, printed in feet

**D X 0 1 2 K W L S 9 O P I 6**





## (5.6e) B-Series Breakout – Interlocking Armor (ILA) Riser Rated Cables

1. Central Filler/Strength Member
  2. Subcable
  3. Interlocking Armor
  4. Outer Jacket
  5. Ripcord
- Subcable**
6. Tight-Buffer Optical Fiber
  7. Aramid Strength Member
  8. Subcable Jacket

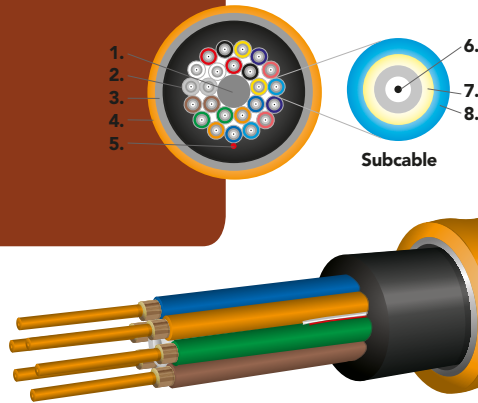

### Applications

- Ideal for industrial and other installations requiring a metallic conduit
- Interlocking armor may eliminate the need for conduit or innerduct, reducing installation costs

### Features

- Inner cable is a fully functional B-Series Breakout Rise Rated Cable
- UL listed in accordance with NEC section 770.179(b) for use in vertical runs in building risers or from floor to floor
- Aluminum interlocking armor with PVC overjacket
- Interlocking armor can be easily removed, leaving an intact inner cable
- Greater flexibility than standard corrugated steel-armored (CST) cables
- Ideal for locations that require conduit for cable protection
- Wide operating temperature of -40°C to +85°C
- 2.0mm and 2.5mm subunits available
- Inner cable is riser rated with PVC jacket

### Mechanical and Environmental Performance

	INDOOR/OUTDOOR
Operating temperature	-40°C to +85°C
Storage temperature	-40°C to +85°C
Installation temperature	-10°C to +60°C
Flame retardancy	UL listed type OFCR (UL 1666) and FT4 (CSA C22.2No. 232)
Crush resistance (TIA-455-41)	650 N/cm
Flex resistance (TIA-455-104)	25 cycles

### Applicable Standards

OCC indoor/outdoor tight-buffered fiber optic cables meet or exceed the functional requirements of the following standards:

- UL 1666
- ICEA-S-83-596
- UL 1651

## (5.6e) B-Series Breakout – Interlocking Armor (ILA) Riser Rated Cables

### Cable Characteristics: B-Series Breakout Interlocking Armor (ILA) Riser Cables (with 2.0mm subcables)

FIBER COUNT	DIAMETER MM (IN)	WEIGHT KG/KM (LBS/1,000')	TENSILE LOAD		MINIMUM BEND RADIUS	
			INSTALLATION N (LBS)	OPERATIONAL N (LBS)	INSTALLATION CM (IN)	LONG-TERM CM (IN)
2	13.6 (0.54)	168 (113)	1,350 (300)	400 (90)	27.2 (10.7)	20.4 (8.8)
4	14.6 (0.57)	194 (130)	1,350 (300)	400 (90)	29.2 (11.5)	21.9 (8.6)
6	15.6 (0.61)	220 (148)	1,350 (300)	400 (90)	31.2 (12.3)	23.4 (9.2)
8	17.2 (0.68)	259 (174)	1,350 (300)	400 (90)	34.4 (13.5)	25.8 (10.2)
12	18.7 (0.74)	297 (200)	1,350 (300)	400 (90)	37.4 (14.7)	28.1 (11.1)
18	20.7 (0.81)	368 (247)	1,350 (300)	400 (90)	41.4 (16.3)	31.1 (12.2)
24	22.8 (0.90)	453 (304)	1,350 (300)	400 (90)	45.6 (18.0)	34.2 (13.5)

### B-Series Breakout Interlocking Armor (ILA) Riser Cables (with 2.5mm subcables)

FIBER COUNT	DIAMETER MM (IN)	WEIGHT KG/KM (LBS/1,000')	TENSILE LOAD		MINIMUM BEND RADIUS	
			INSTALLATION N (LBS)	OPERATIONAL N (LBS)	INSTALLATION CM (IN)	LONG-TERM CM (IN)
2	14.6 (0.57)	189 (127)	1,350 (300)	400 (90)	29.2 (11.5)	21.9 (8.6)
4	16.1 (0.63)	226 (152)	1,350 (300)	400 (90)	32.2 (12.7)	24.2 (9.5)
6	17.7 (0.70)	263 (177)	1,350 (300)	400 (90)	35.4 (13.9)	26.6 (10.5)
8	19.7 (0.78)	332 (223)	1,350 (300)	400 (90)	39.4 (15.5)	29.6 (11.7)
12	22.2 (0.87)	397 (267)	1,350 (300)	400 (90)	44.4 (17.5)	33.3 (13.1)
18	23.3 (0.92)	452 (304)	1,350 (300)	400 (90)	46.6 (18.3)	35.0 (13.8)
24	25.8 (1.02)	555 (373)	1,350 (300)	400 (90)	51.6 (20.3)	38.7 (15.2)

### Ordering Information

**B**   **D**   **9**   **O**   **I**   **2**

Digit No: 1 2 3 4 5 6 7 8 9 10 11 12 13 14

- 1 – 2 Breakout Series Ultra-Fox Cables:  
2.0mm Subcables = **BE**  
2.5mm Subcables = **BX**
- 3 – 5 Fiber count: (see cable characteristics chart) = **002–024**
- 6 Jacket type: Indoor/Outdoor PVC = **D**
- 7 – 9 Fiber type: (see Laser Ultra-Fox Fiber Performance Table, pg. 206)
- 10 Ultra-Fox fiber with 900µm tight-buffer = **9**
- 11 Jacket color:  
62.5µm multimode (WLS, WLX) – Orange = **O**  
50µm multimode (ALS, ALX) – Orange = **O**  
50µm 10 Gigabit (ALT, ALE) – Aqua = **Q**  
Single-mode – Yellow = **Y**
- 12 Rating: Riser = **R**
- 13-14 Indoor/Outdoor PVC jacket over Interlocking armor = **I2**

**Example:** 12-fiber breakout cable with 2.0mm subunits, Interlocking Armor using single-mode bend-insensitive fiber, Ultra Fox, yellow jacket

**B E 0 1 2 D S L A 9 Y R I 2**



## (5.6f) B-Series Breakout – Interlocking Armor (ILA) Plenum Rated Cables

1. Central Filler/Strength Member
  2. Subcable
  3. Interlocking Armor
  4. Outer Jacket
  5. Ripcord
- Subcable**
6. Tight-Buffer Optical Fiber
  7. Aramid Strength Member
  8. Subcable Jacket

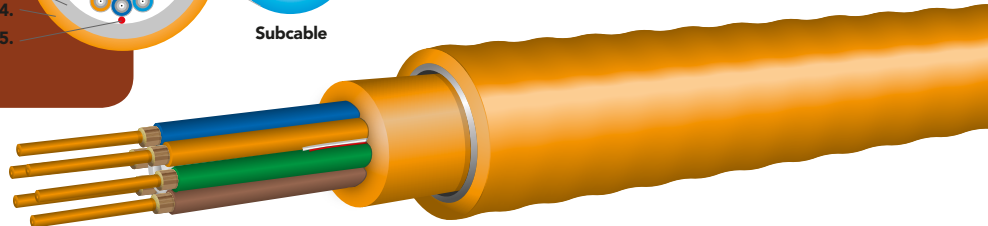
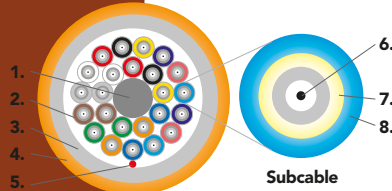

### Applications

- Ideal for industrial and other installations requiring a metallic armor
- Interlocking armor may eliminate the need for conduit, reducing installation costs

### Features

- Inner cable is a fully functional B-Series Breakout plenum rated cable
- UL listed in accordance with NEC section 770.179(a) for use in ducts, plenums and air-handling spaces
- Aluminum interlocking armor with plenum fluoropolymer (K) overjacket
- Greater flexibility than standard corrugated steel-armored (CST) cables
- Interlocking armor can be easily removed, leaving an intact inner cable
- 2.0mm subunits are standard
- Wide operating temperature of -40°C to +85°C for (K jacket) cables



### Mechanical and Environmental Performance

	INDOOR/OUTDOOR
Operating temperature	-40°C to +85°C
Storage temperature	-40°C to +85°C
Installation temperature (cable temp.)	0°C to +60°C
Flame retardancy	UL listed type OFCP (ANSI/NFPA 262) and FT6 (CSA C22.2 No. 232)
Crush resistance (TIA-455-41)	650 N/cm
Flex resistance (TIA-455-104)	25 cycles

### Applicable Standards

OCC indoor/outdoor tight-buffered fiber optic cables meet or exceed the functional requirements of the following standards:

- ANSI/NFPA 262
- UL 1651
- ICEA-S-83-596

## (5.6f) B-Series Breakout – Interlocking Armor (ILA) Plenum Rated Cables

### Cable Characteristics: B-Series Breakout Interlocking Armor (ILA) Plenum Cables (with 2.0mm subcables)

FIBER COUNT	DIAMETER MM (IN)	WEIGHT KG/KM (LBS/1,000')	TENSILE LOAD		MINIMUM BEND RADIUS	
			INSTALLATION N (LBS)	OPERATIONAL N (LBS)	INSTALLATION CM (IN)	LONG-TERM CM (IN)
2	14.1 (0.56)	189 (127)	1,350 (300)	400 (90)	28.2 (11.1)	21.2 (8.3)
4	14.1 (0.56)	189 (127)	1,350 (300)	400 (90)	28.2 (11.1)	21.2 (8.3)
6	15.1 (0.59)	218 (146)	1,350 (300)	400 (90)	30.2 (11.9)	22.7 (8.9)
8	16.7 (0.66)	263 (177)	1,350 (300)	400 (90)	33.4 (13.1)	25.1 (9.9)
12	17.7 (0.70)	304 (204)	1,350 (300)	400 (90)	36.4 (14.3)	27.3 (10.7)
18	20.2 (0.80)	385 (259)	1,350 (300)	400 (90)	35.4 (13.9)	26.6 (10.5)
24	22.3 (0.88)	468 (314)	1,350 (300)	400 (90)	44.6 (17.6)	33.5 (13.2)

### Ordering Information

	<b>B</b>	<b>X</b>				<b>K</b>				<b>9</b>		<b>P</b>	<b>I</b>	<b>6</b>
Digit No:	1	2	3	4	5	6	7	8	9	10	11	12	13	14

- 1 – 2 Breakout Series Ultra-Fox with 2.0mm subunits = **BX**
- 3 – 5 Fiber count: (see cable characteristics chart) = **002–024**
- 6 Jacket type: Indoor/Outdoor Fluoropolymer = **K**
- 7 – 9 Fiber type: (see Laser Ultra-Fox Fiber Performance Table, pg. 206)
- 10 Ultra-Fox fiber with 900µm tight-buffer = **9**
- 11 Jacket color:
  - 62.5µm multimode (WLS, WLX) – Orange = **O**
  - 50µm multimode (ALS, ALX) – Orange = **O**
  - 50µm 10 Gigabit (ALT, ALE) – Aqua = **Q**
  - Single-mode – Yellow = **Y**
- 12 Rating: Plenum = **P**
- 13-14 PVDF jacket over Interlocking Armor = **I6**

**Example:** 12-fiber breakout cable, Interlocking Armor using 62.5µm Laser Ultra-Fox fiber, orange jacket

<b>B</b>	<b>X</b>	<b>0</b>	<b>1</b>	<b>2</b>	<b>K</b>	<b>W</b>	<b>L</b>	<b>S</b>	<b>9</b>	<b>O</b>	<b>P</b>	<b>I</b>	<b>6</b>
----------	----------	----------	----------	----------	----------	----------	----------	----------	----------	----------	----------	----------	----------



### (5.6g) G-Series Subgrouping – Interlocking Armor (ILA) Riser Rated Cables

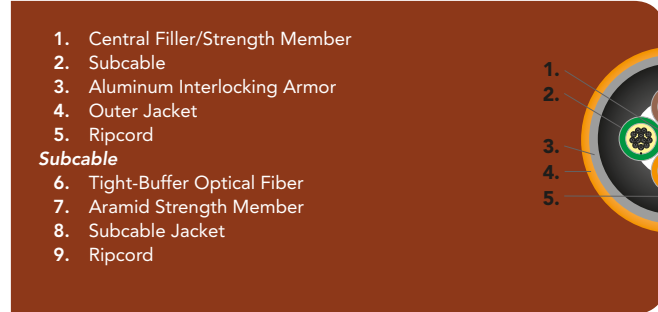

1. Central Filler/Strength Member
  2. Subcable
  3. Aluminum Interlocking Armor
  4. Outer Jacket
  5. Ripcord
- Subcable**
6. Tight-Buffer Optical Fiber
  7. Aramid Strength Member
  8. Subcable Jacket
  9. Ripcord

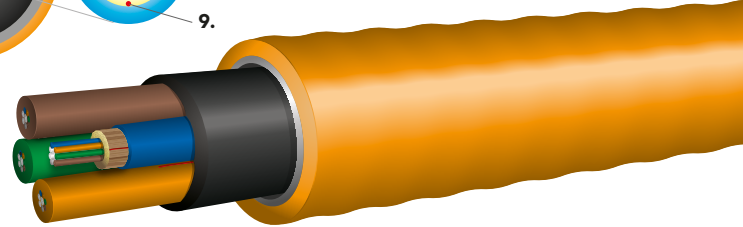

## Applications

- Ideal for industrial and other installations requiring a metallic conduit
- Interlocking armor may eliminate the need for conduit, reducing installation costs

## Features

- Inner cable is a fully functional G-Series Subgrouping Riser Rated cable
- UL listed in accordance with NEC section 770.179(b) for use in vertical runs in building risers or from floor to floor
- Aluminum interlocking armor with PVC overjacket
- Interlocking armor can be easily removed, leaving an intact riser rated inner cable
- Greater flexibility than standard corrugated steel-armored (CST) cables
- Ideal for locations that require conduit for cable protection
- Wide operating temperature of -40°C to +85°C



## Mechanical and Environmental Performance

	INDOOR/OUTDOOR
Operating temperature	-40°C to +85°C
Storage temperature	-40°C to +85°C
Installation temperature (cable temp.)	0°C to +60°C
Flame retardancy	UL listed type OFCR (UL 1666) and FT4 (CSA C22.2No. 232)
Crush resistance (TIA-455-41)	650 N/cm
Flex resistance (TIA-455-104)	25 cycles

## Applicable Standards

OCC indoor/outdoor tight-buffered fiber optic cables meet or exceed the functional requirements of the following standards:

- UL 1666
- ICEA-S-83-596
- UL 1651

Consistent with the definition in TIA-440-B "Fiber Optic Terminology," hybrid cable is defined as a cable containing both optical fibers and electrical conductors. Composite cable is defined as a cable containing mixed fiber types. Prior to 2012 some U.S. standards documents use definitions for hybrid and composite which are opposite of those stated here. The change in convention was made in the interest of harmonization with International standards and other National standards.

## (5.6g) G-Series Subgrouping – Interlocking Armor (ILA) Riser Rated Cables

### Cable Characteristics: G-Series Subgrouping Interlocking Armor (ILA) Riser with 6-fiber subcables (4.5mm subcables)

FIBER COUNT	DIAMETER MM (IN)	WEIGHT KG/KM (LBS/1,000')	TENSILE LOAD		MINIMUM BEND RADIUS	
			INSTALLATION N (LBS)	OPERATIONAL N (LBS)	INSTALLATION CM (IN)	LONG-TERM CM (IN)
12	22.8 (0.9)	453 (304)	1,350 (300)	400 (90)	45.6 (18)	34.2 (13.5)
18	22.8 (0.9)	453 (304)	1,350 (300)	400 (90)	45.6 (18)	34.2 (13.5)
24	22.8 (0.9)	453 (304)	1,350 (300)	400 (90)	45.6 (18)	34.2 (13.5)
30	24.9 (0.98)	552 (371)	1,350 (300)	400 (90)	49.8 (19.6)	37.4 (14.7)
36	25.9 (1.02)	609 (409)	1,350 (300)	400 (90)	51.8 (20.4)	38.9 (15.3)

### G-Series Subgrouping Interlocking Armor (ILA) Riser with 12-fiber subcables (5.5mm subcables)

FIBER COUNT	DIAMETER MM (IN)	WEIGHT KG/KM (LBS/1,000')	TENSILE LOAD		MINIMUM BEND RADIUS	
			INSTALLATION N (LBS)	OPERATIONAL N (LBS)	INSTALLATION CM (IN)	LONG-TERM CM (IN)
24	25.9 (1.02)	586 (394)	1,350 (300)	400 (90)	51.8 (20.4)	38.9 (15.3)
36	25.9 (1.02)	586 (394)	1,350 (300)	400 (90)	51.8 (20.4)	38.9 (15.3)
48	25.9 (1.02)	586 (394)	1,350 (300)	400 (90)	51.8 (20.4)	38.9 (15.3)

## Ordering Information

	<b>G</b>					<b>D</b>				<b>9</b>		<b>R</b>	<b>I</b>	<b>2</b>	
Digit No:	1	2	3	4	5	6	7	8	9	10	11	12	13	14	
	1	Subgrouping Series Ultra-Fox = <b>G</b>													
	2	6-fiber subcables = <b>B</b> ; 12-fiber subcables = <b>X</b>													
	3 – 5	Fiber count: 6-fiber subcables = <b>012–036</b> , 12-fiber subcables = <b>024–048</b>													
	6	Jacket type: Indoor/Outdoor PVC = <b>D</b>													
	7 – 9	Fiber type: (see Laser Ultra-Fox Fiber Performance Table, pg. 206)													
	10	Ultra-Fox fiber with 900µm tight-buffer = <b>9</b>													
	11	Jacket color:													
		62.5µm multimode (WLS, WLX) – Orange = <b>O</b>													
		50µm multimode (ALS, ALX) – Orange = <b>O</b>													
		50µm 10 Gigabit (ALT, ALE) – Aqua = <b>Q</b>													
		Single-mode – Yellow = <b>Y</b>													
	12	Rating: Riser = <b>R</b>													
	13 – 14	Interlocking Armor with Indoor/Outdoor PVC Jacket = <b>I2</b>													

**Example:** 48-fiber subgrouping cable using 12-fiber subcables with OM3 laser optimized bend-insensitive fiber, Ultra-Fox, interlocking armor, aqua jacket, printed in feet

**G X 0 4 8 D A L T 9 Q R I 2**





## (5.6h) G-Series Subgrouping – Interlocking Armor (ILA) Plenum Rated Cables

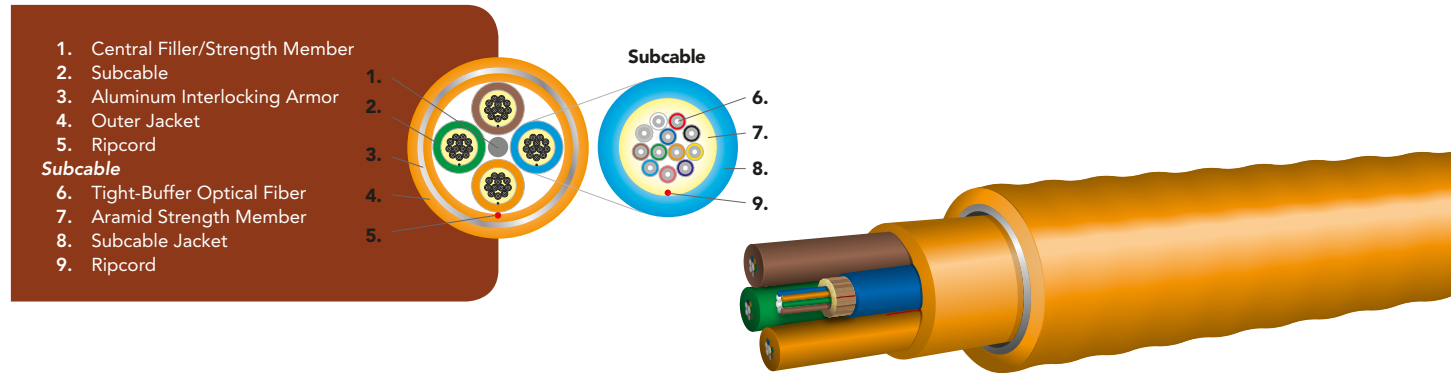

1. Central Filler/Strength Member
  2. Subcable
  3. Aluminum Interlocking Armor
  4. Outer Jacket
  5. Ripcord
- Subcable**
6. Tight-Buffer Optical Fiber
  7. Aramid Strength Member
  8. Subcable Jacket
  9. Ripcord

## Applications

- Ideal for industrial and other installations requiring a metallic conduit
- Interlocking armor may eliminate the need for conduit, reducing installation costs

## Features

- Inner cable is a fully functional G-Series Subgrouping Plenum Rated cable
- UL listed in accordance with NEC section 770.179(a) for use in ducts, plenums and air-handling spaces
- Aluminum interlocking armor with a fluoropolymer (K) overjacket
- Greater flexibility than standard corrugated steel-armored (CST) cables
- Interlocking armor can be easily removed, leaving an intact plenum rated inner cable
- Wide operating temperature of -40°C to +85°C (K jacket)

## Mechanical and Environmental Performance

	INDOOR/OUTDOOR
Operating temperature	-40°C to +85°C
Storage temperature	-40°C to +85°C
Installation temperature (cable temp.)	0°C to +60°C
Flame retardancy	UL listed type OFCP (ANSI/NFPA 262) and FT6 (CSA C22.2 No. 232)
Crush resistance (TIA-455-41)	650 N/cm
Flex resistance (TIA-455-104)	25 cycles

Consistent with the definition in TIA-440-B "Fiber Optic Terminology," hybrid cable is defined as a cable containing both optical fibers and electrical conductors. Composite cable is defined as a cable containing mixed fiber types. Prior to 2012 some U.S. standards documents use definitions for hybrid and composite which are opposite of those stated here. The change in convention was made in the interest of harmonization with International standards and other National standards.

## Applicable Standards

OCC indoor/outdoor tight-buffered fiber optic cables meet or exceed the functional requirements of the following standards:

- ANSI/NFPA 262
- ICEA-S-83-596
- UL 1651
- CSA C22.2 No. 232

## (5.6h) G-Series Subgrouping – Interlocking Armor (ILA) Plenum Rated Cables

### Cable Characteristics:

### G-Series Subgrouping Interlocking Armor (ILA) Plenum Cables with 6-fiber subcables (4.5mm subcables)

FIBER COUNT	DIAMETER MM (IN)	WEIGHT KG/KM (LBS/1,000')	TENSILE LOAD		MINIMUM BEND RADIUS	
			INSTALLATION N (LBS)	OPERATIONAL N (LBS)	INSTALLATION CM (IN)	LONG-TERM CM (IN)
12	22.7 (0.89)	504 (339)	1,350 (300)	400 (90)	45.4 (17.9)	34.1 (13.4)
18	22.7 (0.89)	502 (337)	1,350 (300)	400 (90)	45.4 (17.9)	34.1 (13.4)
24	22.7 (0.89)	500 (336)	1,350 (300)	400 (90)	45.4 (17.9)	34.1 (13.4)
30	23.8 (0.94)	550 (370)	1,350 (300)	400 (90)	47.6 (18.7)	35.7 (14.1)
36	24.8 (0.98)	538 (362)	1,350 (300)	400 (90)	49.6 (19.5)	37.2 (14.7)

### G-Series Subgrouping Interlocking Armor (ILA) Plenum Cables with 12-fiber subcables (5.5mm subcables)

FIBER COUNT	DIAMETER MM (IN)	WEIGHT KG/KM (LBS/1,000')	TENSILE LOAD		MINIMUM BEND RADIUS	
			INSTALLATION N (LBS)	OPERATIONAL N (LBS)	INSTALLATION CM (IN)	LONG-TERM CM (IN)
24	23.8 (0.94)	569 (382)	1,350 (300)	400 (90)	47.6 (18.7)	35.7 (14.1)
36	23.8 (0.94)	565 (380)	1,350 (300)	400 (90)	47.6 (18.7)	35.7 (14.1)
48	23.8 (0.94)	561 (377)	1,350 (300)	400 (90)	47.6 (18.7)	35.7 (14.1)

## Ordering Information

	<b>G</b>					<b>K</b>				<b>9</b>		<b>P</b>	<b>I</b>	<b>6</b>
Digit No:	1	2	3	4	5	6	7	8	9	10	11	12	13	14
1	Subgrouping Series Ultra-Fox = <b>G</b>													
2	6-fiber subcables = <b>B</b> ; 12-fiber subcables = <b>X</b>													
3 – 5	Fiber count: 6-fiber subcables = <b>012–036</b> , 12-fiber subcables = <b>024–048</b>													
6	Jacket type: PVDF = <b>K</b>													
7 – 9	Fiber type: (see Laser Ultra-Fox Fiber Performance Table, pg. 206)													
10	Ultra-Fox fiber with 900µm tight-buffer = <b>9</b>													
11	Jacket Color:													
	62.5µm multimode (WLS, WLX) – Orange = <b>O</b>													
	50µm multimode (ALS, ALX) – Orange = <b>O</b>													
	50µm 10 Gigabit (ALT, ALE) – Aqua = <b>Q</b>													
	Single-mode – Yellow = <b>Y</b>													
12	Rating: Plenum = <b>P</b>													
13 – 14	Interlocking armor with Indoor/Outdoor Fluoropolymer jacket = <b>I6</b>													

**Example:** 12-fiber subgrouping cable with 6-fiber subcables using 62.5µm Laser Ultra-Fox fiber, interlocking armor, orange, K-jacket, plenum rated, printed in feet

**G B 0 1 2 K W L S 9 O P I 6**

## (5.6i) HC-Series – High-Density Riser Rated Cables

1. Central Filler/Strength Member
  2. Tight-Buffer Fiber Unit
  3. Aramid Strength Member
  4. Outer Jacket
  5. Ripcord
- Tight-Buffer Fiber Unit**
6. 250µm Acrylate Fiber
  7. Fiber Unit
  8. Tight-Buffer Fiber Unit

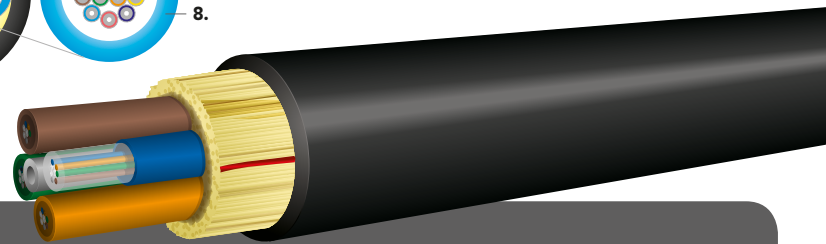
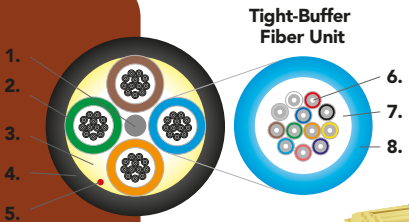

### Applications

- Designed for installation in an underground duct for data transmission between nodes or hubs
- Cable can also be routed vertically inside buildings

### Features

- Rugged tight-buffer fiber unit construction
- Cable materials are indoor/outdoor: UV, fungus and water resistant
- The high-density breakout cables offer a >20% reduction in diameter and a >20% reduction in weight relative to conventional loose-tube cables, allowing for greater fiber density and cable packing within a duct
- UL listed in accordance with NEC section 770.179(b) for use in vertical runs in building riser shafts or from floor to floor
- Core-Locked™ outer jacket design for installation survivability
- Helically stranded core for greater flexibility and mechanical protection of the optical fiber units
- Cable offers a cost savings by eliminating the need to splice outdoor cable to indoor cable at building entrance
- Cable can be terminated with 900µm fanout kit for LC connectorization
- Construction options available for direct termination of tight-buffered fiber units to MPO/MTP connectors
- Suitable for direct pulling with wire mesh grips



### Applicable Standards

OCC indoor/outdoor tight-buffered fiber optic cables meet or exceed the functional requirements of the following standards:

- ICEA-S-104-696
- ICEA-S-83-596
- TIA-568
- TIA-598
- UL 1666
- CSA C22.2 No. 232

### Mechanical and Environmental Performance

	INDOOR/OUTDOOR
Operating temperature	-40°C to +85°C
Storage temperature	-55°C to +85°C
Installation temperature (cable temp.)	-20°C to +60°C
Flame retardancy	UL listed type OFNR (UL 1666) and FT4 (CSA C22.2 No.232)
Crush resistance (TIA-455-41)	1,800 N/cm
Flex resistance (TIA-455-104)	2,000 cycles

## (5.6i) HC-Series High-Density Riser Rated Cables

### Cable Characteristics: HC-Series High-Density Riser Cables (with 2.0mm fiber units)

FIBER COUNT	DIAMETER MM (IN)	WEIGHT KG/KM (LBS/1,000')	TENSILE LOAD		MINIMUM BEND RADIUS	
			INSTALLATION N (LBS)	OPERATIONAL N (LBS)	INSTALLATION CM (IN)	LONG-TERM CM (IN)
24	7.6 (0.30)	75 (50)	2,700 (600)	600 (135)	11.4 (4.5)	7.6 (3.0)
48	7.6 (0.30)	75 (50)	2,700 (600)	600 (135)	11.4 (4.5)	7.6 (3.0)
72	9.0 (0.35)	97 (65)	2,700 (600)	600 (135)	13.5 (5.3)	9.0 (3.5)
96	10.3 (0.41)	116 (78)	2,700 (600)	600 (135)	15.5 (6.1)	10.3 (4.1)
120	11.4 (0.45)	141 (95)	2,700 (600)	600 (135)	17.1 (6.7)	11.4 (4.5)
144	11.7 (0.46)	152 (102)	2,700 (600)	600 (135)	17.6 (6.9)	11.7 (4.6)
168	11.7 (0.46)	152 (102)	2,700 (600)	600 (135)	17.6 (6.9)	11.7 (4.6)
192	12.9 (0.51)	179 (120)	2,700 (600)	600 (135)	19.4 (7.6)	12.9 (5.1)
216	12.9 (0.51)	179 (120)	2,700 (600)	600 (135)	19.4 (7.6)	12.9 (5.1)
288	15.0 (0.59)	226 (152)	2,700 (600)	600 (135)	22.8 (9.0)	15.0 (5.9)

\*\*Installation loads in excess of 2,700 N (600 lbs.) are not recommended.

## Ordering Information

	H	C				D						R
Digit No:	1	2	3	4	5	6	7	8	9	10	11	12

- 1 – 2 High Count Series with 12-fiber bundled fiber units 2.0mm in diameter = **HC**
- 3 – 5 Fiber count: (see cable characteristics chart)
- 6 Jacket type: Low temperature oil resistant indoor/outdoor PVC = **D**
- 7 – 9 Fiber type: **SLA, ALT, ALE, WLS**
- 10 Jacketed fiber unit: **A** = Direct MTP termination, **C** = No direct MTP termination,
- 11 Standard jacket color: Black = **K**
- 12 Rating: Riser = **R**

**Example:** 24-fiber cable with 12-fiber units, 2.0mm in diameter using bend-insensitive, single-mode fiber, low temperature oil-resistant indoor/outdoor PVC, black jacket riser rated, printed in feet

<b>H</b>	<b>C</b>	<b>0</b>	<b>2</b>	<b>4</b>	<b>D</b>	<b>S</b>	<b>L</b>	<b>A</b>	<b>C</b>	<b>K</b>	<b>R</b>
----------	----------	----------	----------	----------	----------	----------	----------	----------	----------	----------	----------

## (5.6j) CX-Series Hybrid – Copper/Fiber Riser and Plenum Rated Cables

1. Ripcord
2. Copper Wire
3. Optical Fiber Subcable
4. Aramid Strength Member
5. Outer Jacket

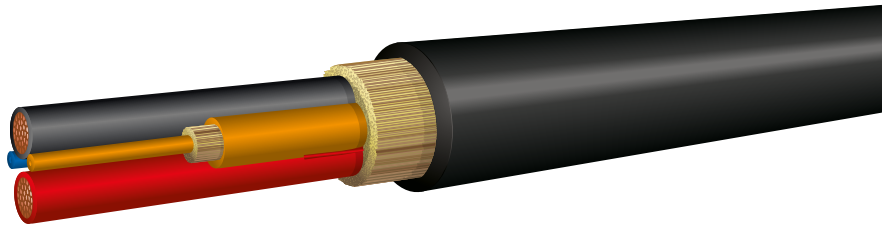
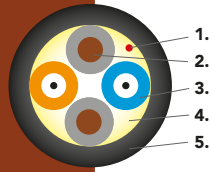

### Applications

- Ideal for data communication and control installations that require fiber and copper under one cable jacket
- Hybrid fiber/copper cables are intended for use on Class 2 power-limited circuits, as described in Article 725 of the National Electrical Code

### Features

- Various combinations of copper conductors and optical fibers in a single hybrid cable
- Chemical-resistant outer jacket available for harsh industrial or outdoor environments
- 12-, 14-, 16-, 18-gauge single-stranded copper wire available for power, communication, control sensor, signal, and video
- Multimode (62.5µm or 50µm) and single-mode fiber available – contact Optical Cable Corporation for specifications and part numbers
- Larger gauge wires overcome powering distance limitations of unshielded twisted pair
- Copper and fiber individually subcabled for ease of separation, handling and termination
- Round cable design for easy installation and survivability
- Many combinations available with CL2R riser ratings or CL2P plenum ratings per UL 13
- Interlocking armor available for riser and plenum hybrid cables



### Cable Characteristics: Hybrid Cables

	PLENUM (INDOOR/OUTDOOR)	RISER (INDOOR/OUTDOOR)
Minimum bend radius: Installation load	20X outside diameter	20X outside diameter
Minimum bend radius: Long-term load	15X outside diameter	15X outside diameter
Flame retardancy	UL listed type CL2P-OF (UL 13)	UL listed type CL2R-OF (UL 13)

\*Many combinations of optical fibers and wires can be manufactured to your specific requirements. Please contact Optical Cable Corporation for a price quotation and specifications for the Composite Fiber/Copper Cable design that meets all your special application requirements.

Consistent with the definition in TIA-440-B “Fiber Optic Terminology,” hybrid cable is defined as a cable containing both optical fibers and electrical conductors. Composite cable is defined as a cable containing mixed fiber types. Prior to 2012 some U.S. standards documents use definitions for hybrid and composite which are opposite of those stated here. The change in convention was made in the interest of harmonization with International standards and other National standards.

### Applicable Standards

OCC indoor/outdoor tight-buffered fiber optic cables meet or exceed the functional requirements of the following standard:

- UL 13

## (5.6j) CX-Series Hybrid – Copper/Fiber Riser and Plenum Rated Cables



### Ordering Information: Indoor/Outdoor Riser and Plenum Hybrid Cables

	<b>C</b>	<b>X</b>								<b>9</b>		
<b>Digit No:</b>	<b>1</b>	<b>2</b>	<b>3</b>	<b>4</b>	<b>5</b>	<b>6</b>	<b>7</b>	<b>8</b>	<b>9</b>	<b>10</b>	<b>11</b>	<b>12</b>

- 1 – 2 Hybrid Series Ultra-Fox = **CX**
- 3 – 5 Fiber count: Number of fibers (**002–012**) + Copper Conductors (**002–004**)  
Example: 2-fiber/2-copper = **004**
- 6 Jacket type: Indoor/Outdoor Fluoropolymer = **K**; Indoor/Outdoor PVC = **D**
- 7 – 9 Fiber/Copper type: Contact Optical Cable Corporation for three-digit part number code
- 10 Ultra-Fox fiber with 900µm tight-buffer = **9**
- 11 Standard jacket color:  
PVC (all fiber types) – Black = **K**  
Fluoropolymer = 62.5µm multimode (WLS, WLX) – Orange = **O**  
50µm multimode (ALS, ALX) – Orange = **O**  
50µm 10 Gigabit (ALT, ALE) – Aqua = **Q**  
Single-mode – Yellow = **Y**
- 12 Rating:  
Plenum = **P**  
Riser = **R**

**Example:** 2-fiber/2AWG-18 copper cable using 62.5µm standard Laser Ultra-Fox fiber, orange jacket

<b>C</b>	<b>X</b>	<b>0</b>	<b>0</b>	<b>4</b>	<b>K</b>	<b>.</b>	<b>.</b>	<b>.</b>	<b>9</b>	<b>O</b>	<b>P</b>	<b>*</b>
----------	----------	----------	----------	----------	----------	----------	----------	----------	----------	----------	----------	----------

\*For the specific part number, please call 1-800-622-7711 and ask for a Sales Representative. We're ready to assist you.

## (5.6k) CX-Series Hybrid – UL 1277 Tray Cables

1. Ripcord
2. Tight-Buffer Optical Fiber
3. Copper Wire
4. Central Fill/Strength Member
5. Aramid Strength Member
6. Outer Jacket
7. Subcable Jacket

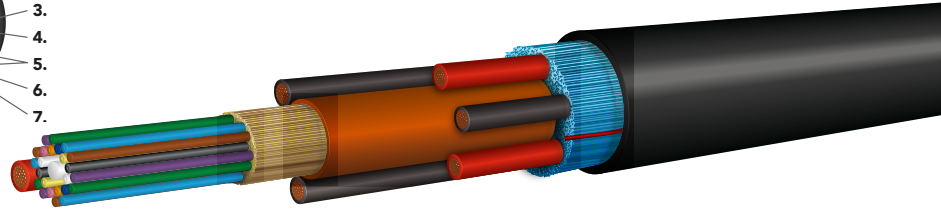
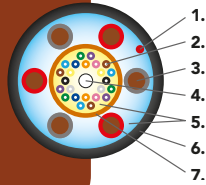

### Applications

- Used for power and control circuits that require both power conductors and fiber optic communication links
- Hybrid fiber/copper cables as described in NEC Article 336 Power and Control Tray Cable Type TC-OF
- Type TC-ER cable can transition from a cable tray to the equipment

### Features and Benefits

- Corrugated copper shielding is available
- Type TC-ER cable is also approved for use between the cable tray and equipment when installed to NEC 336.10(7)
- 600V rating for 90°C dry locations
- Cable constructed of copper conductors, fiber optical components, flame retardant fillers and tape wrap
- Bare grounding conductor for TC-ER cables
- Individual conductors are Type THHN and can be AWG 10 to AWG 4
- Sunlight resistant jacket for continuous sunlight exposure performance
- UL 1685 Vertical Flame Test performance (70,000 BTU/hr)
- The fiber optic components can vary from individual to multifiber subunits as determined by the construction which includes the number of fibers, number of conductors and the conductor size
- For fiber type options see the Section 3.1 – Fiber Product Information
- Many fiber count options available
- Incorporating fiber optic elements into the power cable provides protection for the optical fibers and reduced installation costs by installing one cable in the place of several individual cables

### Applicable Standards

OCC indoor/outdoor tight-buffered fiber optic cables meet or exceed the functional requirements of the following standards:

- UL 1277
- UL 1685 Vertical Flame Test
- UL 83 – THHN conductors
- NEC – NFPA 70 Section 336

### Cable Characteristics

- Due to the wide variety of cable constructions, including conductor counts, conductor sizes, fiber types and fiber counts, individual cable characters are available upon request.

### Ordering Information

- Due to the custom nature of this cable, contact OCC Sales for ordering information. Please call 1-800-622-7711 and ask for a Sales Representative. We're ready to assist you.

Consistent with the definition in TIA-440-B "Fiber Optic Terminology," hybrid cable is defined as a cable containing both optical fibers and electrical conductors. Composite cable is defined as a cable containing mixed fiber types. Prior to 2012 some U.S. standards documents use definitions for hybrid and composite which are opposite of those stated here. The change in convention was made in the interest of harmonization with International standards and other National standards.





## FTTA Cabling

With the growing consumer appetite for higher speeds and the constant evolution of wireless services, fiber-to-the-antenna (FTTA) cabling is quickly becoming the norm over traditional coaxial-based systems. Contributing factors to this rise in popularity include ease of installation, improved signal quality and increased energy efficiency.

Above all, the quality of data transmission to the end user is greatly increased with FTTA due to the direct connection between the base station and remote radio unit.

For more than 30 years, OC FTTA is no different.

To find out how OCC can prepare you for a better future and to learn more about FTTA, please contact the OCC Inside Sales Team.

Call 1-800-622-7711 and ask for a Sales Representative. We're ready to assist you.

 (5.8a) Laser Ultra-Fox™ Fiber Performance

Fiber Code <sup>7</sup>	Industry Standard Designation	Core/Cladding Diameter (μm)	Numeric Aperture	Wavelength (nm)	Gigabit Ethernet Distance (m)	10-Gigabit Ethernet Distance (m)	Max. Cabled Attenuation (dB/km)	Min. Laser EMB Bandwidth* (MHz-km)	Min. OFL LED Bandwidth** (MHz-km)
WLS	OM1 ISO/IEC 11801	62.5/125	0.275	850/1310	300/600	33/300 <sup>^</sup>	3.5/1.5	220/500	200/500
WLX	OM1+ ISO/IEC 11801	62.5/125	0.275	850/1310	500/1000	33/300 <sup>^</sup>	3.5/1.5	385/500	200/500
ALS	Laser Grade OM2 Bend Insensitive ISO/IEC 11908	50/125	0.20	850/1310	600/600	82/300 <sup>^</sup>	3.5/1.5	510/500	500/500
ALX	Extended Length Laser Grade OM2+ Bend Insensitive ISO/IEC 11801	50/125	0.20	850/1310	750/600	150/300 <sup>^2</sup>	3.0/1.0 <sup>3</sup>	950/500	700/500
ALT	Laser Optimized OM3 Bend Insensitive ISO/IEC 11801	50/125	0.20	850/1310	1000/600	300/300 <sup>^2</sup>	3.0/1.0 <sup>3</sup>	2000/500	1500/500
ALE	Laser Optimized OM4 Bend Insensitive ISO/IEC 11801	50/125	0.20	850/1310	1040/600	550 <sup>1</sup> /300 <sup>^2</sup>	3.0/1.0 <sup>3</sup>	4700/500	3500/500
SLX	Low Water Peak Single-Mode ITU-T G.652.D	9 <sup>6</sup> /125	—	1310/1550	5 km <sup>4</sup>	10 km <sup>5</sup>	0.5/0.5	—	—
SLA	Bend Insensitive Low Water Peak Single-Mode ITU-T G.657.A1 and ITU-T G.652.D	9 <sup>6</sup> /125	—	1310/1550	5 km <sup>4</sup>	10 km <sup>5</sup>	0.5/0.5	—	—
SLB	Bend Insensitive Low Water Peak Single-Mode ITU-T G.657.A2 and ITU-T G.652.D	9 <sup>6</sup> /125	—	1310/1550	5 km <sup>4</sup>	10 km <sup>5</sup>	0.5/0.5	—	—
SLC	Bend Insensitive Low Water Peak Single-Mode ITU-T G.657.B3 and ITU-T G.652.D	9 <sup>6</sup> /125	—	1310/1550	5 km <sup>4</sup>	10 km <sup>5</sup>	0.5/0.5	—	—

\* Minimum Laser Effective Modal Bandwidth (EMB)

\*\* For backward compatibility to LED based systems, overfilled launch (OFL)

<sup>^</sup> 1310 nm CWDM lasers (10GBASE-LX4)

<sup>1</sup> Reach assuming 3.0 dB maximum cabled attenuation at 850 nm and 1.3 dB total connection and splice loss

<sup>2</sup> Supports 220 meter 10GBASE-LRM distance, or 300 meter 10GBASE-LRM distance with 300 meter capable equipment

<sup>3</sup> 3.5/1.5 dB/km maximum attenuation applies for DX-Series cables greater than 36 fibers, and for all DX-Series cables with armor (corrugated steel tape or interlocked armor) or any other secondary outer jacketing

<sup>4</sup> 10 km for 1310 nm 1000BASE-LX10, and 5 km for 1310 nm 1000BASE-LX

<sup>5</sup> 10 km for 1310 nm 10GBASE-LR, and 40 km for 1550 nm 10GBASE-ER

<sup>6</sup> Typical Mode Field Diameter at 1310 nm

<sup>7</sup> Fiber Codes are available for composite cables containing a wide variety of mixed fiber types within the same cable. Call OCC Customer Service for the Fiber Code for your composite cable configuration.

## (5.8b) Ultra-Fox™ Plus Fiber Performance

Fiber Code <sup>5</sup>	Industry Standard Designation	Core/Cladding Diameter (µm)	Numeric Aperture	Wavelength (nm)	Gigabit Ethernet Distance (m)	10-Gigabit Ethernet Distance (m)	Max. Cabled Attenuation (dB/km)	Min. Laser EMB Bandwidth* (MHz-km)	Min. OFL LED Bandwidth** (MHz-km)
WST	OM1 ISO/IEC 11801	62.5/125	0.275	850/1310	275/550	33/300 <sup>^</sup>	3.5/1.5	200/500	200/500
WLS	Laser Grade OM1 ISO/IEC 11801	62.5/125	0.275	850/1310	300/600	33/300 <sup>^</sup>	3.5/1.5	220/500	200/500
AST	OM2 ISO/IEC 11801	50/125	0.20	850/1310	550/550	82/300 <sup>^</sup>	3.5/1.5	500/500	500/500
ALS	Laser Grade OM2 ISO/IEC 11801	50/125	0.20	850/1310	600/600	82/300 <sup>^</sup>	3.5/1.5	510/500	500/500
ALT	Laser Optimized OM3 ISO/IEC 11801	50/125	0.20	850/1310	1000/600	300/300 <sup>^1</sup>	3.5/1.5	2000/500	1500/500
ALE	Laser Optimized OM4 ISO/IEC 11801	50/125	0.20	850/1310	1040/600	550/300 <sup>^</sup>	3.5/1.5	4700/500	3500/500
SLS	Low Water Peak Single-Mode ITU-T G.652.D <sup>6</sup>	9 <sup>2</sup> /125	—	1310/1550	5 km <sup>3</sup>	10 km <sup>4</sup>	0.5/0.5	—	—
SLA	Bend Insensitive Low Water Peak Single-Mode ITU-T G.657.A1 and ITU-T G.652.D	9 <sup>2</sup> /125	—	1310/1550	5 km <sup>3</sup>	10 km <sup>4</sup>	0.5/0.5	—	—

\* Minimum Laser Effective Modal Bandwidth (EMB)

\*\* For backward compatibility to LED-based systems, overfilled launch (OFL)

<sup>^</sup> 1310nm CWDM lasers (10GBASE-LX4)

<sup>1</sup> Supports 220-meter 10GBASE-LRM distance or 300-meter 10 GBASE-LRM distance with 300-meter-capable equipment

<sup>2</sup> Typical Mode Field Diameter at 1310nm = 9 microns

<sup>3</sup> 10km for 1310nm 1000BASE-LX10 and 5km for 1310nm 1000BASE-LX

<sup>4</sup> 10km for 1310 10GBASE-LR and 40km for 1550nm 10GBASE-ER

<sup>5</sup> Fiber Codes are available for composite cables containing a wide variety of mixed fiber types within the same cable. Call OCC Customer Service for the Fiber Code for your composite cable configuration.

<sup>6</sup> For certain specialty applications SLS fiber may be ITU-T G.652.A

## Other Fiber Types Available Upon Request

OCC continues to offer the widest variety of standard off-the-shelf and nonstandard fiber types to meet the customer's special system requirements. If your system design demands a fiber type not included on these two pages, call OCC to see if your needs can be met with one of the many fiber types available. The following fiber types are examples of some of the specialty fibers available from OCC.

Fiber Type	Description	Uses
CST/DBX	100/140 Core/Cladding	Large core fiber used in low data rate industrial applications
FST	200/230 Core/Cladding	Large core fiber used in low data rate industrial applications
Mil-PRF-49291	Single-Mode and Multimode	Military qualified fiber for specific contract QPL
Radiation Hardened	Single-Mode and Multimode	Commercial and Mil grades available
200kpsi Proof Strength	Single-Mode and Multimode	Many fiber types are available with a 200kpsi proof strength for demanding applications
Wide band multimode fiber	Wide band 50µm NextGen Fiber	CWDM ethernet 40–400 gigabit





# FIBER OPTIC CONNECTIVITY

Connectivity is the key to a reliable and efficient network. OCC offers one of the industry's most comprehensive lines of connectors, connectivity and cable management systems, patch panels, enclosures, cassettes, adapters, accessories, pre-terminated cable assemblies, and easy plug-and-play modules to keep your enterprise network and data center running strong. These connectivity components provide versatile and proven solutions for today's high bandwidth applications and the migration from 10 to 40 to 100 Gb/s data rates — maximizing performance, modularity, and scalability for your network today and tomorrow.

Engineered for efficient installation and ease of use, the OCC family of connectivity products, including our Procyon enclosures and adapter plates, is sturdy, versatile, and provides years of worry-free service.

Effective connectivity must adapt to change. And with OCC's family of connectivity products, change has never been easier.

 Contents

## 6.0 Fiber Optic Connectivity

### 6.1 ENTERPRISE FIBER OPTIC ENCLOSURES AND ADAPTER PLATES

6.1a	Passive Optical Lan .....	212
6.1b	RTC and RTS Series Enclosures – Rack Mount Fiber Enclosures.....	216
6.1c	Specialty Enclosures .....	218
6.1d	BHP Series .....	219
6.1e	RSC Splicing Enclosures.....	220
6.1f	Procyon Blade Enclosures.....	221
6.1g	R-Series Splice Kits.....	225
6.1h	Recessed Brackets .....	226
6.1i	WTC Cabinets – Wall Mount Fiber Enclosures.....	227
6.1j	W-Series Splice Kits .....	228
6.1k	Fiber Zone Distribution Enclosures .....	229
6.1l	Adapter Plates.....	230
6.1m	Keyed Adapter Plates.....	234

### 6.2 ENTERPRISE CONNECTORS

6.2a	Anaerobic Connectors .....	235
6.2b	Xpress Connector .....	236

See Section 8.8a for Multimedia Adapters and Connectors.

### 6.3 ENTERPRISE FIBER OPTIC CABLE ASSEMBLIES

6.3.a	Enterprise Fiber Optic Jumpers .....	237
6.3.a.1	Keyed LC .....	238
6.3.a.2	Secure LC .....	239
6.3.b	Enterprise Fiber Optic Pigtailed.....	241
6.3.c	MT Cable Assemblies .....	242
6.3.d	Made-to-Order Standard Trunk Cables.....	243

### 6.4 ENTERPRISE PRE-TERMINATED ENCLOSURES

6.4a	Procyon Fiber Enclosure .....	244
6.4b	Procyon MPO-MPO Cassettes.....	246
6.4c	Procyon MPO-LC Cassettes.....	247
6.4d	MT Cassettes.....	248
6.4e	RTC1UB Enclosures .....	249
6.4f	Loaded Enclosures.....	250

### 6.5 HARSH ENVIRONMENT ENCLOSURES

6.5a	DIN-RAIL System Enclosures .....	251
6.5b	NEMA 3 Enclosures.....	253
6.5c	NEMA 4X Enclosures .....	254
6.5d	Fiberguard Enclosures .....	255

### 6.6 HARSH ENVIRONMENT CONNECTORS

6.6a	M29504/14 and M29504/15 Fiber Optic Termini .....	257
6.6b	Single Terminus Connectors .....	259
6.6c	L-JACK Connectors.....	263
6.6d	COTS 83526 Connectors .....	267
6.6e	COTS 83526 Adapters and Loopbacks .....	273
6.6f	Pierside Connectors.....	275
6.6g	F-LINK Interconnect Solution.....	279



## 6.7 HARSH ENVIRONMENT CABLE ASSEMBLIES

6.7a	F-LINK Cable Assemblies.....	285
6.7b	Pierside Cable Assemblies.....	290
6.7c	COTS-83526 Cable Assemblies.....	294
6.7d	EZ-Mate Cable Assemblies.....	298
6.7e	MHC II Cable Assemblies.....	302
6.7f	MHC III Cable Assemblies.....	308
6.7g	Expanded Beam Cable Assemblies.....	312
6.7h	IRIS Cable Assemblies.....	314
6.7i	L-JACK Cable Assemblies.....	318
6.7j	Single Terminus (ST) Assemblies.....	323
6.7k	Made-to-Order Multifiber Trunk Cable Assemblies.....	327

See Section 6.3 for more information on Jumpers, Trunk Cables, and Pigtailed.

## 6.8 TOOLS

6.8a	Cleaners and Tools.....	329
6.8b	Cleaning Kits.....	330

## 6.9 CABLE INFORMATION

6.9a	Laser Ultra-Fox Fiber Performance.....	331
6.9b	Ultra-Fox Fiber Performance.....	332



 (6.1a) Passive Optical Lan (POL)

## Passive Optical LAN

When looking to install a passive optical network with reliable technology, look no further than OCC's newly developed POL Solution. POL systems afford substantial improvements in energy savings, and are more environmentally friendly than many traditional cabling infrastructures. As a leader in fiber optic infrastructure, OCC provides a complete system with intuitive components that make installation nearly effortless. With OCC's legendary ruggedness, this system will last through years of use, and is ready for future upgrades.

### OCC's POL Solution offers:

- **A complete system that integrates with other POL and structured cabling components**  
OCC offers flexible options based on application needs and infrastructure requirements. In addition, OCC's POL Solution integrates seamlessly with all our structured cabling fiber optic components.
- **Components that allow for effortless installations**  
As with other OCC products, our components are easy to install and manage. A retraction mechanism for ceiling/floor mount enclosures enables easy access to bulkhead for adapter/cassette placement, cable routing and cross connecting. Recessed hinges create a seamless appearance in drop ceilings.
- **System components that are rugged, but ready for upgrades**  
OCC is known for our tough components, and our POL Solutions are no different. Our standard simplex cables are renowned for providing significant mechanical and environmental performance over our competitors, with greater pull strength, greater impact and crush resistance, and truly bend-insensitive fibers. And if the application calls for the toughest cable on the market, OCC has a cable for that, too. The POL connectivity components are founded on the rugged RTC enclosures, and are the most resilient in the market.

OCC manufactures the best cabling in the industry and the most practical and durable connectivity available today. Couple that with the service and tailor-made options from OCC, and your choice for a POL fiber optic access network becomes clear.



## (6.1a) Passive Optical Lan (POL)

### Applications

Studies have shown that employing passive optical LAN cabling system provides significant cost savings in both CAPex and OPex year over year versus traditional structured cabling infrastructures. POL systems afford substantial improvements in energy savings and are more environmentally friendly. The need for a telecommunications room is replaced with zone enclosures that reduce power consumption and energy demands. Plus, the amount of cabling within a building is diminished significantly, thereby reducing the weight and capacity within the horizontal cabling support structure, and providing better airflow and cooling capabilities.

In addition, passive optical LANs take advantage of high-bandwidth single-mode fiber optics to support converged networks and provide an infrastructure with future upgrades in mind.

OCC's history and innovation in fiber optic components makes us uniquely qualified to provide the best passive optical LAN system on the market. Whether you're choosing a traditional structured cabling system or a passive optical LAN, OCC can provide solutions that deliver exceptional flexibility and performance for years.



### Zone Layout



MDF

RTC-RTS Fiber enclosure



ZONE

Ceiling mount Zone Distribution Enclosure

WORKSTATION



### Star Layout



MDF

RTC-RTS Fiber enclosure



IDF

RTC-RTS Fiber enclosure

WORKSTATION





## (6.1a) Passive Optical Lan (POL)

## POL Enclosures

PART NUMBER	DESCRIPTION
ZED12AP	Zone enclosure, ceiling/floor/wall mount, 2'h x 2'w x 6" d, accommodates 12 inserts
ZES6AP	Zone enclosure, ceiling/floor /wall mount, 2'h x 2'w x 3" d, accommodates 6 inserts
ZEWM5AP	Zone enclosure, wall mount, accommodates 5 inserts
RTC1U1PBK	Rack mount enclosure, 1RU, with (1) cassette module bracket, holds 3 adapter plates
RTC2U1PBK	Rack mount enclosure, 2RU, with (1) cassette module bracket, holds 6 adapter plates
RTC2U2PBK	Rack mount enclosure, 2RU, with (2) cassette module bracket, holds 6 adapter plates
ZETRIMKIT	Ceiling trim kit for zone enclosure

## Cassette Modules and Adapter Plates

PART NUMBER	DESCRIPTION
PONCMTP3SCAPC	Fiber breakout cassette module, SM, MPO to 3 SC APC
PONCMTP12SCAPC	Fiber breakout cassette module, SM, MPO to 12 SC APC
PONC1x32SCAPC	Fiber splitter cassette module, SM, 1x32, SC APC
PONC2x32SCAPC	Fiber splitter cassette module, SM, 2x32, SC APC
PONC1x16SCAPC	Fiber splitter cassette module, SM, 1x16, SC APC
PONC2x16SCAPC	Fiber splitter cassette module, SM, 2x16, SC APC
616SCAPC	Fiber adapter plate, 6 port, SC APC
818SCAPC	Fiber adapter plate, 8 port, SC APC
6112SMDSCAPC	Fiber adapter plate, 12 port, SC APC

## Faceplates

PART NUMBER	DESCRIPTION
FPSK01A12	Faceplate, 1 port, angled, bright white
AKSCAPCxx*	Faceplate adapter, SC/APC, non-shuttered
AKSCAPCS04	Faceplate adapter, SC/APC, green, shuttered
FPSK01ASCA12	Faceplate kit, 1 port, angled, bright white, with SC insert
FPSK01ASCAS12	Faceplate kit, 1 port, angled, bright white, with shuttered SC insert

\*Note: Other adapter colors are available. Contact OCC for ordering information.

Please call 1-800-622-7711 and ask for a Sales Representative. We're ready to assist you.

## (6.1a) Passive Optical Lan (POL)



### Fiber Optic Jumpers

PART NUMBER	DESCRIPTION
S8PSCAPC-SCAPCXXX	Simplex jumper, SC APC to SC APC, single-mode, ITU-T G.657.A1 fiber, plenum, yellow
S8PBSCAPCSCAPCXXX	Simplex jumper, SC APC to SC APC, single-mode, ITU-T G.657.A2 fiber, plenum, yellow
S8PCSCAPCSCAPCXXX	Simplex jumper, SC APC to SC APC, single-mode, ITU-T G.657.A3 fiber, plenum, yellow

Note: Replace "XXX" with length in feet. Also available in riser. Contact OCC for ordering information.

### Pre-Terminated Fiber Optic Cable Assemblies

PART NUMBER	DESCRIPTION
MT12PRF8TK-XXXX	Fiber cable, 12 fiber, SM, MPO/MPO, plenum
MT06PRF8TK-XXXX	Fiber cable, 6 fiber, SM, MPO/MPO, plenum

Note: Replace "XXXX" with length of cable assembly. Other fiber types available, contact OCC for ordering information.

### Fiber Optic Cable

PART NUMBER	DESCRIPTION
AX001DSLx9YR	2.9mm fiber cable, 1 fiber, SM, yellow, riser
AX001SSLx9YP	2.9mm fiber cable, 1 fiber, SM yellow, plenum
AX002DSLx9YR	2.9mm fiber cable, 2 fiber, SM yellow, riser
AX002SSLx9YP	2.9mm fiber cable, 2 fiber, SM yellow, plenum
DX006DSLx2YR	Distribution style fiber cable, 6-fiber, SM yellow, riser
DX006SSLx2YP	Distribution style fiber cable, 6-fiber, SM yellow, plenum
DX012DSLx2YR	Distribution style fiber cable, 12-fiber, SM yellow, riser
DX012SSLx2YP	Distribution style fiber cable, 12-fiber, SM yellow, plenum

Note: Replace "x" with the following for single-mode fiber type:  
 A = Bend-insensitive, Low Water Peak, Single-Mode, ITU-T G.657.A1 and ITU-T G.652.D  
 B = Bend-insensitive, Low Water Peak, Single-Mode, ITU-T G.657.A2 and ITU-T G.652.D  
 C = Bend-insensitive, Low Water Peak, Single-Mode, ITU-T G.657.A3 and ITU-T G.652.D







## (6.1b) RTC and RTS Series – Rack Mount Fiber Enclosures

### Fiber Termination Enclosures

OCC is committed to providing the best fiber cabling system in the industry. Our newly redesigned fiber termination enclosures introduce new features to a well-established product line, making them easier to work with and more aesthetically pleasing while maintaining the ruggedness expected from OCC. These new fiber optic enclosures allow for easier terminations, greater capacity and uncomplicated cable management. Fabricated from 16-gauge steel to withstand years of adds, moves, and changes, the new RTC and RTS enclosures incorporate features designed to reduce installation time and cost.



### Features & Benefits:

Designed with features that benefit both the end user and the installer, OCC's new enclosures offer the following:

- Available in both fixed (RTC) and sliding (RTS) versions
- 1RU, 2RU, and 4RU configurations available to accommodate project size
- Sliding (RTS) version incorporates a unique shelf, allowing easy access from the front or rear of the enclosure
- The RTS shelf can be removed entirely from the enclosure for use as a convenient work surface
- RTC and RTS enclosures are built on the same chassis for rack uniformity
- RTC and RTS enclosures accept OCC standard 600 series adapter plates
- RTC-HD and RTS-HD enclosures accept new HD adapter plates for high density applications
- External cable management is enhanced with new modular strain relief brackets that reduce fiber stress and provide support for proper cable bends and efficient cable management
- Fiber hoops in the rear of the cabinet are stackable and allow for greater segregation of incoming fiber cables
- Fiber retention teeth on the cable hoops retain the fiber within the hoop, simplifying cable management during installation
- New slam latches on the front and rear of the enclosures make access easier
- Both the RTC and RTS series enclosures provide a transparent cover for visual inspection of ports and a defined labeling field for TIA 606A compliance
- Hardware for 19" or 23" rack mounting
- Numerous internal locations to secure slack cable



## (6.1b) RTC and RTS Series – Rack Mount Fiber Enclosures



### Fiber Termination Enclosures

The complete fiber optic infrastructure transport system from OCC includes cable, connectors, adapters, enclosures, splice tray kits, and outside plant closures. These components are designed to work seamlessly to maximize the installer experience and optimize system performance. Count on OCC to supply strong, durable, high-density patch and splice solutions for fiber optic networking. With a sleek new look and features designed to streamline cable management and ease of termination, OCC's versatile and flexible fiber optic enclosures are ideal for today's high bandwidth and high density communication networks that require immediate scalability for the 10 to 40 to 100GB/s migration.

OCC's fiber optic infrastructure components can be found in the harshest industrial and military environments. Whether it's broadcast video or high speed Ethernet, our fiber optic infrastructure system is the ideal choice for the most reliable signal transmission. Coupled with our copper infrastructure solution, OCC supplies one of the most complete communications infrastructure systems in the industry.

### Ordering Information — Fiber Enclosures

PART NUMBER	DESCRIPTION
RTC1U-3APB	Enclosure, rack mount, 1RU, 3 adapter plates, black
RTC1U-3APBL	Enclosure, rack mount, 1RU, 3 adapter plates, black, locking
RTC1U-HD4APB	Enclosure, rack mount, 1RU, 4 adapter plates, black
RTC1U-HD4APBL	Enclosure, rack mount, 1RU, 4 adapter plates, black, locking
RTS1U-3APB	Enclosure, rack mount, 1RU, sliding, 3 adapter plates, black
RTS1U-3APBL	Enclosure, rack mount, 1RU, sliding, 3 adapter plates, black, locking
RTS1U-HD4APB	Enclosure, rack mount, 1RU, sliding, 4 adapter plates, black
RTS1U-HD4APBL	Enclosure, rack mount, 1RU, sliding, 4 adapter plates, black, locking
RTC2U-6APB	Enclosure, rack mount, 2RU, 6 adapter plates, black
RTC2U-6APBL	Enclosure, rack mount, 2RU, 6 adapter plates, black, locking
RTC2U-HD8APB	Enclosure, rack mount, 2RU, 8 adapter plates, black
RTC2U-HD8APBL	Enclosure, rack mount, 2RU, 8 adapter plates, black, locking
RTS2U-6APB	Enclosure, rack mount, 2RU, sliding, 6 adapter plates, black
RTS2U-6APBL	Enclosure, rack mount, 2RU, sliding, 6 adapter plates, black, locking
RTS2U-HD8APB	Enclosure, rack mount, 2RU, sliding, 8 adapter plates, black
RTS2U-HD8APBL	Enclosure, rack mount, 2RU, sliding, 8 adapter plates, black, locking
RTC4U-12APB	Enclosure, rack mount, 4RU, 12 adapter plates, black
RTC4U-12APBL	Enclosure, rack mount, 4RU, 12 adapter plates, black, locking
RTC4U-HD16APB	Enclosure, rack mount, 4RU, 16 adapter plates, black
RTC4U-HD16APBL	Enclosure, rack mount, 4RU, 16 adapter plates, black, locking
RTS4U-12APB	Enclosure, rack mount, 4RU, sliding, 12 adapter plates, black
RTS4U-12APBL	Enclosure, rack mount, 4RU, sliding, 12 adapter plates, black, locking
RTS4U-HD16APB	Enclosure, rack mount, 4RU, sliding, 16 adapter plates, black
RTS4U-HD16APBL	Enclosure, rack mount, 4RU, sliding, 16 adapter plates, black, locking
TCSR	Strain relief bracket for RTC/RTS fiber enclosures

**Note:** Additional fiber hoops may be ordered. Contact OCC for more information.



## (6.1c) Specialty Enclosures

### RTC1UB

Optical Cable Corporation's RTC1UB series fiber optic cabinets offer a quick solution for easy high-density connectivity. Whether ordering empty for field installations or completely pre-terminated for easy plug-and-play installations, the RTC1UB rack-mount enclosures are a versatile and flexible option for your advanced fiber optic structured cabling system.

- Constructed of 16-gauge steel with a black powder-coat finish
- High-density patch and splice in a 1RU rack space
- Left and right rear cable entry
- Removable top access panel
- Cable management hoops included
- Accommodates OCC 600-series snap-in adapter plate or cassette module
- May be ordered pre-terminated for plug-and-play operability
- Splice tray compatible using R24S1UB kit



### RTC1UB Series Enclosures

PART NUMBER	DESCRIPTION
RTC1UB	Rack-mount enclosure, with cover and fiber management, 3 adapter plates, 1RU, black

### RTR12B

When higher density applications are required, OCC RTR12B enclosures offer a compact solution. This rack-mountable cabinet offers rugged durability and complete application flexibility, making it ideal for small racks and closets. The RTR offers not only high-density capabilities, but also left and right rear cable entry and a removable top access panel.

- Constructed of 16-gauge steel with a black powder-coat finish
- High-density patch and splice in a 1RU rack space
- Left and right rear cable entry
- Removable top access panel
- Recessed feature for small rack form factor
- Includes eight bridge lances and one rear metal quarter-turn bail lock
- Accommodates OCC 600-series snap-in adapter plate or cassette module and R12S splicing kit



### RTR12B Enclosures

PART NUMBER	DESCRIPTION
RTR12B	Rack-mount enclosure, recessed, high-density, 2 adapter plates, 1RU, black

Port capacity based on standard 6-port adapter plates; higher density may be achieved through 8-, 12-, and 24-port adapter plates.



## (6.1d) BHP Series

### BHP Series

For multimedia applications, OCC offers a universal rack-mount patch panel for termination and cable management only. The BHP panel system is well suited for multi-application cabling environments. With OCC's snap-in adapter plates and cassette modules, these panels can be installed in a variety of combinations.

- Constructed of 16-gauge steel with a black powder-coat finish
- Strain-relief bar offers enhanced cable management
- Tie wraps included for controlled cable
- Accommodates OCC 600-series snap-in adapter plate or cassette module

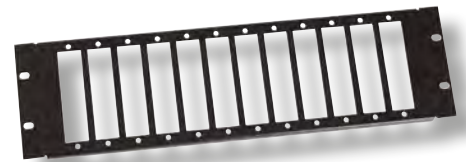
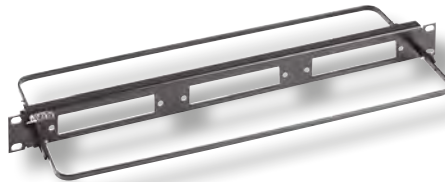
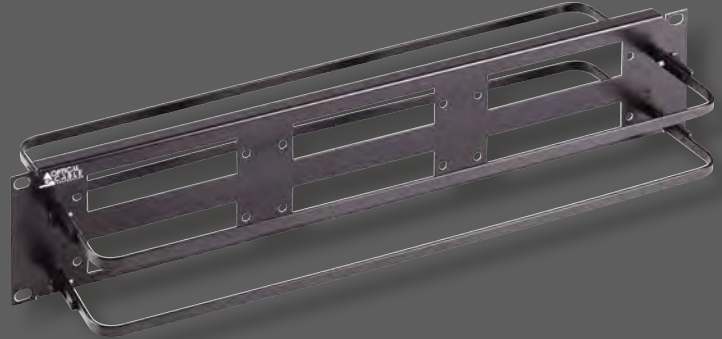

### Universal Fiber Patch Panels

PART NUMBER	RACK UNITS	ADAPTER PLATES
BHP3 – Panel	1	3
BHP6 – Panel	2	6
BHP72 – Plate	3	12
BHP144 – Plate	6	24

**Note:** Port capacity based on standard 6-port adapter plates. Higher density may be achieved with 8-, 12-, and 24-port adapter plates. Strain relief bar(s) are only included with the BHP3 and BHP6 panels.



## (6.1e) RSC Splicing Enclosures

## RSC Rack-Mount Splice Enclosures

- Constructed of 16-gauge steel with durable powder-coat finish
- High-density patch and splice features
- Front and rear locking options available
- Two-tier fiber storage hoops designed to maintain orderly fiber management included
- Full rubber grommets offer dust protection for all cable entry and exit points
- Removable front and rear access panel
- Mounting hardware included for 19" or 23" rack-mounting
- Available in Almond or Black

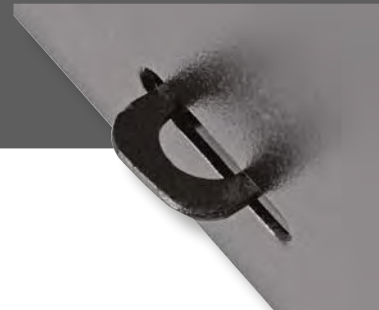
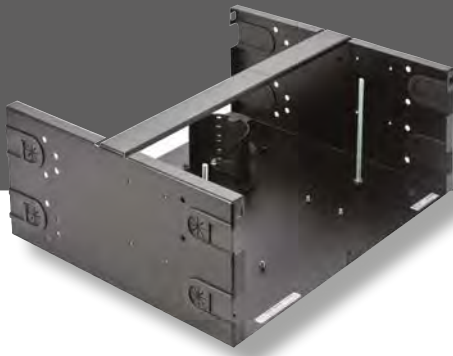
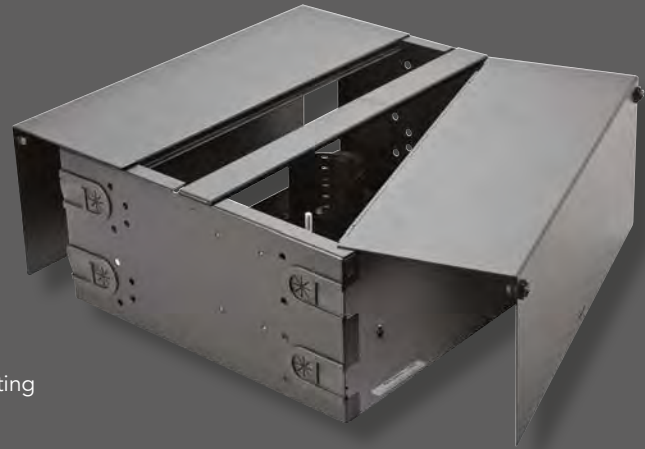

## RSC Rack-Mount Splice Enclosures

PART NUMBER	RACK UNITS	SPLICE CAPACITY
RSC-1UB	1	24
RSC-x (no splice trays installed)	4	144
RSC-72x (includes R72S kit)	4	72
RSC-144x (includes R144S kit)	4	144
"x" denotes cabinet color; replace with <b>A</b> = Almond or <b>B</b> = Black		

**Note:** Higher splice capacity is possible with additional fiber splice kits. Contact OCC for more information.

Call 1-800-622-7711 and ask for a Sales Representative. We're ready to assist you.

## (6.1f) Procyon Blade Enclosures

### Overview

OCC's Procyon® Blade™ is the newest addition to the Procyon product family of high-density network solutions. Designed to provide superior organization, accessibility, and density, the Blade system enclosures and in-line splice modules maintain the highest optical performance over the longest runs, making it ideal for multiple building network configurations. This reliable and reconfigurable system is inherently suited for multi-building complexes such as hospitals, corporate centers, government facilities and universities, and supports immediate scalability and the increasing growth for future applications.



### Features & Benefits

- **Maintains superior connections for inter- and intra-building cable runs.** OCC's Procyon Blade connectivity and cabling system is based on a splicing-centric installation architecture. By decreasing the number of physical connections, the Blade solution minimizes signal loss typically associated with multiple terminations, and improves signal integrity with reduced back reflection. This makes the system well suited for longer runs, such as between buildings on a campus.
- **Simple access for easy installations.** Blade enclosures are designed for easy access to subgroup cables with Blade in-line splice modules. OCC's patent-pending in-line splice modules have "blade-like" attributes that allow them to be accessed from either the front or rear of the enclosure. This unique feature minimizes the risk of disturbing co-located, adjacent subgroups and makes moves, adds, and changes much easier. Dedicated slack storage and splicing for each subgroup cable eliminates the inherent tangle and disorder associated with conventional transition and splice tray installations.
- **Versatile configurations for maximum density.** The Blade enclosures are available in three rack mount versions (2RU, 3RU, and 4RU) and two wall mount options, as well as a variety of adapter plate options. By utilizing any Blade enclosure with its revolutionary in-line splice modules, providing high-density connections is only multiplied by the variety of ways you can configure them.
- **A singular source for a full solution.** Combined with OCC's HC- and HD-Series cables, the Blade solution can provide a complete connectivity and cabling infrastructure for campus and multi-building networks. The Blade enclosures are designed to service 12-fiber subgroup trunk cables, such as the OCC HC- and HD-Series cables. HC-Series cables have an outer diameter much smaller than conventional cables, exceptional mechanical and environmental performance, and a high-duct efficiency that is ideal for long inter-building runs. HD-Series cables are lightweight, exceptional in tight bends, and perfect for trunk, LAN or data center applications. Together with OCC's Blade enclosures and in-line splice modules, this full solution provides a single source for a well organized, easily accessible, and dense network system.

### Applications

- Healthcare Facilities and Hospitals
- Colleges and Universities
- Data Center and Processing Networks
- Corporate Campuses
- Any high-density splicing application



## (6.1f) Procyon Blade – Rack Mount Enclosures

### Blade Rack Mount Enclosures

- Available in 2RU, 3RU and 4RU sizes to accommodate various fiber counts
- Internal rails securely hold the Blade In-line Splice Modules in place for normal use and allow them to be accessed easily from either the front or rear of the enclosure
- All enclosures include storage space for slack cables
- Lockable rear compartment option for security is available
- External strain relief brackets that reduce fiber stress are available to secure cables upon entry and exit to the enclosure and provide support for proper cable bends and efficient cable management
- All enclosures include a transparent cover that provides visual inspection of ports and a defined labeling field for TIA 606A compliance
- Hardware included for 19" or 23" mounting
- Fabricated from 16 gauge steel to withstand environmental challenges for years of adds, moves, and changes



### Ordering Information

PART NUMBER	DESCRIPTION
PRORTC2U-3ISM	Rack mount enclosure, 2RU, accommodates 3 in-line splice modules (36 SC ports or 72 LC ports max)
PRORTC3U-6ISM	Rack mount enclosure, 3RU, accommodates 6 in-line splice modules (72 SC ports or 144 LC ports max)
PRORTC4U-12ISM	Rack mount enclosure, 4RU, accommodates 12 in-line splice modules (144 SC ports or 288 LC ports max)
FOCBKTB	Strain relief bracket
FOCBKTV	Vertical strain relief bracket



## (6.1f) Procyon Blade – Wall Mount Enclosures

### Blade Wall Mount Enclosures

- Available in two sizes to accommodate various fiber counts
- Internal rails securely hold the Blade In-line Splice Modules in place for normal use and allow them to be accessed easily from within the enclosure's inner compartment
- Pivoting inner compartment allows easy access to in-line splice modules and provides storage for slack cables underneath
- External strain relief brackets that reduce fiber stress are available to secure cables upon entry and exit to the enclosure and provide support for proper cable bends and efficient cable management
- Numerous internal locations for securing slack cable
- Defined labeling field for TIA 606A compliance included
- Fabricated from 16-gauge steel to withstand environmental challenges for years of adds, moves, and changes

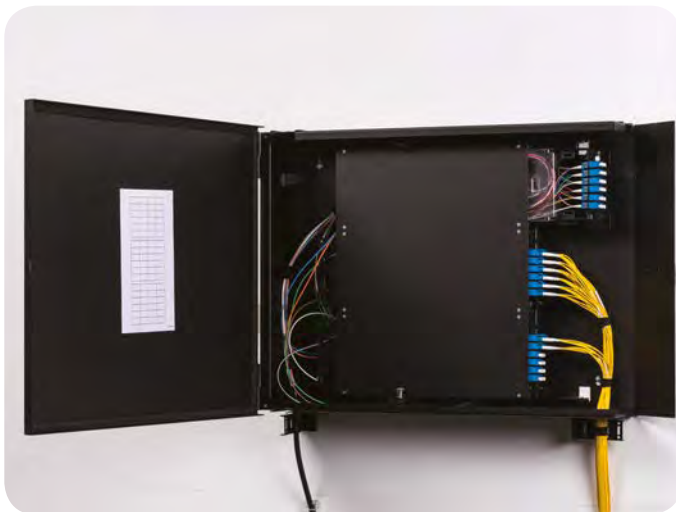

### Ordering Information

PART NUMBER	DESCRIPTION
PROWTC-2ISM	Wall mount enclosure, 13.6"H x 24.6"W x 4.3"D, accommodates 2 in-line splice modules (24 SC ports or 48 LC ports max)
PROWTC-3ISM	Wall mount enclosure, 18.6"H x 24.6"W x 4.3"D, accommodates 3 in-line splice modules (36 SC ports or 72 LC ports max)
FOCBKTB	Strain relief bracket
FOCBKTV	Vertical strain relief bracket

## (6.1f) Procyon Blade – In-Line Splice Modules

### In-line Splice Modules (Blades)

- Available in 12 and 24 fiber configurations
- Each in-line splice module includes splice tray(s) and populated adapter plate as ordered
- Each in-line splice module includes a slack storage area capable of storing several meters of slack subgroup cable
- Splice trays include a patented “quick strap” splice protection sleeve holder designed for higher density and quicker installations
- Clear tray covers allow for quick and easy visual inspection of fiber optic splices
- Blue felt adhesive strips, Velcro strips and cable ties are included for securing fibers and cable
- In-line splice modules may be pre-loaded with pigtails. Contact OCC for ordering information



### Ordering Information

PART NUMBER	DESCRIPTION
PROISM12MMSC*	In-line splice module, (1) splice tray, 12-port, multimode dual SC adapter plate included
PROISM12SMSC*	In-line splice module, (1) splice tray, 12-port, single-mode dual SC adapter plate included
PROISM125GSC*	In-line splice module, (1) splice tray, 12-port, multimode OM3 dual SC adapter plate included
PROISM125QSC*	In-line splice module, (1) splice tray, 12-port, multimode OM4 dual SC adapter plate included
PROISM12APSC*	In-line splice module, (1) splice tray, 12-port, single-mode dual SC angle polish adapter plate included
PROISM24MMLC*	In-line splice module, (2) splice trays, 24-port, multimode quad LC adapter plate included
PROISM24SMLC*	In-line splice module, (2) splice trays, 24-port, single-mode quad LC adapter plate included
PROISM245GLC*	In-line splice module, (2) splice trays, 24-port, multimode OM3 quad LC adapter plate included
PROISM245QLC*	In-line splice module, (2) splice trays, 24-port, multimode OM4 quad LC adapter plate included
PROISM24APLC*	In-line splice module, (2) splice trays, 24-port, single-mode quad LC angle polish adapter plate included
PROISMTRAY	Single splice tray for 12 fiber splices (1 subgroup cable)

\* Insert “P” at the end of the part number to order pre-loaded with pigtails.

**Note:** Additional in-line splice module configurations available. Contact OCC for ordering information.

Please call 1-800-622-7711 and ask for a Sales Representative. We're ready to assist you.



## (6.1g) R-Series Splice Kits

### R-Series Splice Kits

Optical Cable Corporation offers user friendly rack-mount splice kits for all applications. All OCC splice kits are injection-molded and have hinged, clear plastic covers for fiber visibility and maximum protection. Tabs along the tray's side allow for easy fiber routing. All OCC splice kits are available for smaller fiber capacities.

- All 2U and 4U kits include transition tray(s) for cable management and radius control
- Accessories included for adapting the trays into the cabinets
- Felt strips and cable ties included for securing and strain relieving buffered fibers



### Rack-Mount Splice Kits

PART NUMBER	DESCRIPTION
RS1U1T	Rack mount splice tray kit, (1) splice tray, for use with RTC/RTS1U
RS2U1T	Rack mount splice tray kit, (1) splice tray, for use with RTC/RTS2U
RS2U2T	Rack mount splice tray kit, (2) splice trays, for use with RTC/RTS2U
RTS4U2T	Rack mount splice tray kit, (2) splice trays, for use with RTC/RTS4U
RTS4U4T	Rack mount splice tray kit, (4) splice trays, for use with RTC/RTS4U
RS1U1TR	Rack mount splice tray kit, (1) ribbon splice tray, for use with RTC/RTS1U
RS2U1TR	Rack mount splice tray kit, (1) ribbon splice tray, for use with RTC/RTS2U
RS2U2TR	Rack mount splice tray kit, (2) ribbon splice trays, for use with RTC/RTS2U
RS4U2TR	Rack mount splice tray kit, (2) ribbon splice trays, for use with RTC/RTS4U
RTS4U4TR	Rack mount splice tray kit, (4) ribbon splice trays, for use with RTC/RTS4U

**Note:** Other splice kits available. Contact OCC for ordering information.

Please call 1-800-622-7711 and ask for a Sales Representative. We're ready to assist you.

 (6.1h) Locking Kits and Brackets

### Rack-Mount Recess Brackets

OCC's recess brackets allow RTC series cabinets to easily mount into any enclosure that has a front door. By using OCC's recess brackets, the cabinet will be flush with the rack's mounting rails, allowing sufficient room between the cabinet and the door.



### Recess Brackets for New RTC/RTS Cabinets

PART NUMBER	DESCRIPTION
BKTR1UB	Recess bracket for RTC1U and RTS1U
BKTR2UB	Recess bracket for RTC2U and RTS2U
BKTR4UB	Recess bracket for RTC4U and RTS4U

## (6.1i) WTC Cabinets – Wall Mount Fiber Enclosures

### WTC Cabinets

OCC's Wall-Mount Cabinets (WTC) provide a solid foundation for any fiber optic application, with features such as integrated fiber management and easy cable distribution. Each cabinet may be ordered empty or loaded to meet exact specifications. Every WTC cabinet easily accommodates all cross-connect functions, including splicing, termination and inter-connects for outside plant backbone and building cables. The WTC series cabinets are scalable, modular and constructed for durability. With OCC's variety of adapter plates, cassette modules and splicing features, the application options are endless.

- Constructed of 16-gauge steel with durable powder-coat finish
- Accommodates OCC 600-series snap-in adapter plates and cassette modules
- Removable hinged door provides easy front access and lockable hasp
- Two-tier fiber storage hoops designed to maintain orderly fiber management
- Top and bottom accesses have cable tie-downs/strain-relief and full grommets
- Lockable inner door is removable and can be used as a work surface by inserting the tabs into slots provided at the bottom frame of the cabinet
- Port identification sheets are included
- All WTC Series enclosures meet NEMA 12 rated requirements
- Mounting hardware included
- Available in Almond or Black



### Wall-Mount Cabinets (Empty)

PART NUMBER	ADAPTER PLATES	SPLICE CAPACITY	SPLICE TRAY/ KIT	BOX DIMENSIONS (H x W x D)
WMC12A (available in Almond only)	2	–	–	11" x 7" x 3"
WTC12/24x (2 blank plates included for 12-port applications)	4	24	–	13" x 12" x 3.5"
WTC48x	8	48	W48S	13" x 17" x 5.5"
WTC72x	12	72	W72S	17" x 12" x 11"
WTC144x	24	144	W144S	23" x 17" x 11"

"x" denotes cabinet color; replace with **A** = Almond or **B** = Black. Port capacity based on standard 6-port adapter plates. Higher density may be achieved with 8-, 12-, and 24-port adapter plates.

### Wall-Mount Splice Cabinets (Empty)

PART NUMBER	ADAPTER PLATES	SPLICE CAPACITY	SPLICE TRAY/KIT	BOX DIMENSIONS (H x W x D)
WSV24x – (splice cabinet)	–	24	W24S	17" x 8.18" x 4"
WSV72x – (splice cabinet)	–	72	W72S	17" x 8.18" x 4"
WSV144x – (splice cabinet)	–	144	W144S	17" x 8.18" x 4"
WSV288x – (splice cabinet)	–	288	W144S & W288S	23" x 17" x 11"

"x" denotes cabinet color; replace with **A** = Almond or **B** = Black. Port capacity based on standard 6-port adapter plates. Higher density may be achieved with 8-, 12-, and 24-port adapter plates.

Please see the next page for Splice Tray/Kit descriptions.

 (6.1j) W-Series Splice Kits

## W-Series Splice Kits

Optical Cable Corporation offers user-friendly wall-mount splice kits for all applications. All OCC splice kits are injection-molded and have hinged, clear plastic covers for fiber visibility and maximum protection. Tabs along the tray's side allow for easy fiber routing and all OCC splice kits are available for smaller fiber capacities.

- All kits include transition trays for cable management and radius control
- Accessories are included for adapting the trays into the cabinets
- Felt strips and cable ties included for securing and strain relieving buffered fibers

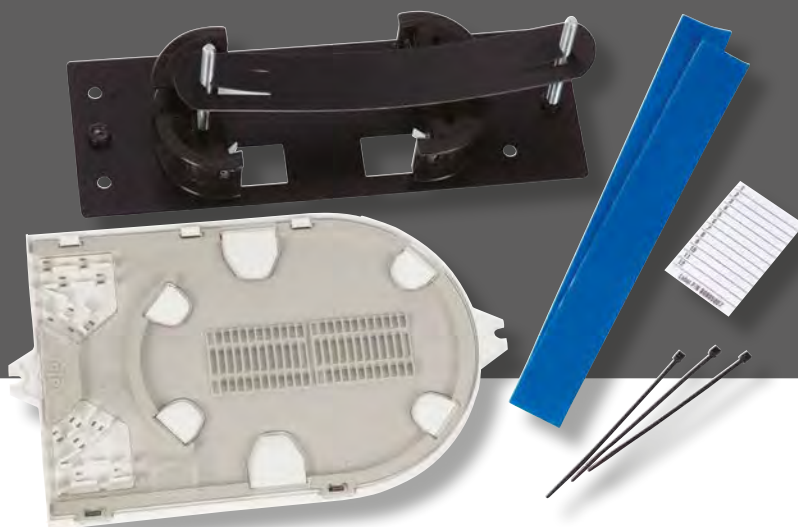

## Wall-Mount Splice Kits

PART NUMBER	DESCRIPTION
W12RT	Wall-mount splice kit for WTC12/24x cabinet, 12-fiber splice tray
W24PT	Wall-mount splice kit for WTC12/24x cabinet, 24-fiber splice tray
W48S	Wall-mount splice kit for 48-fiber splices
W48RS	Wall-mount splice kit, ribbon tray, for 48-fiber splices
W72S	Wall-mount splice kit for 72-fiber splices
W72RS	Wall-mount splice kit, ribbon tray, for 72-fiber splices
W96S	Wall-mount splice kit for 96-fiber splices
W144S	Wall-mount splice kit for 144-fiber splices
W144RS	Wall-mount splice kit, ribbon tray, for 144-fiber splices
W288S	Wall-mount splice kit for 288-fiber splices

**Note:** Additional splice trays are available, please call OCC for ordering information.

Please call 1-800-622-7711 and ask for a Sales Representative. We're ready to assist you.

## (6.1k) Fiber Zone Distribution Enclosures

### Zone Distribution Enclosure ZDMB6B

OCC's new ZDMB6B offers a compact and reliable patch and splice fiber optic enclosure ideal for:

- Telecommunication rooms, enclosures and cabinets
- Traffic control and industrial cabinets
- Indoor wall-mount applications
- Zone distribution applications
- Any small space where real estate for cross-connect applications is a premium

This small enclosure accepts OCC 600-series fiber optic adapter plates and provides splicing options for up to 12 fibers. The ZDMB6B is an affordable solution that provides easy installations and customizable configurations.

### Features & Benefits

- Cost-effective for small fiber optic applications
- Can be used for both splicing and patching applications
- Cable entry grommets help protect fiber optic cable from dust and debris
- Fiber management clips are included for fiber storage
- MPO compatible for zone applications
- Lockable for secure access
- Low-profile design is less than 2", including the plunger and lock tab
- Accepts one OCC fiber optic adapter plate



## Zone Distribution Enclosure

PART NUMBER	DESCRIPTION	DIMENSIONS (H x W x D)
ZDMB6B	Zone distribution enclosure, accomodates 1 adapter plate	6" x 7" x 1.92"
ZDMB-SB	Zone distribution enclosure, splice only, 1 blank adapter plate	6" x 7" x 1.92"

**Note:** Zone Distribution Enclosures can be pre-loaded with adapter plates and pigtail assemblies.

 (6.1) Adapter Plates

### Fiber Optic Adapter Plates

To accompany all OCC fiber optic enclosures, Optical Cable Corporation developed snap-in fiber adapter plates that are versatile enough to meet any fiber application and durable enough to withstand field installations. All OCC fiber adapter plates guarantee performance parameters for the application specified, and can be preloaded into OCC fiber cabinets for easy plug-and-play operability.

- Available in 6-, 8-, and 12-port fiber configurations
- Panel options available include ST, SC, FC, MT-RJ, LC, and others
- High-density applications can be reached through Dual and quad LC applications
- Composite, metal, or ceramic sleeve options
- Blank panels are available for use as dust covers
- Plates are available for mounting bezel style jacks, creating a mixed-media environment



### SC Adapter Plates

PART NUMBER	DESCRIPTION
616MMSC	Fiber adapter plate, 6-port, SC, multimode, composite sleeve
616SC	Fiber adapter plate, 6-port, SC, multimode/single-mode, metal sleeve
616SC50G	Fiber adapter plate, 6-port, SC, multimode, 50µm, composite sleeve, 10GbE
616SMSC	Fiber adapter plate, 6-port, SC, single-mode, ceramic sleeve
616MMDSC	Fiber adapter plate, 6-port, dual SC, multimode, composite sleeve
616DSC	Fiber adapter plate, 6-port, dual SC, multimode/single-mode, metal sleeve
616SMDSC	Fiber adapter plate, 6-port, dual SC, single-mode, ceramic sleeve
616DSC50G	Fiber adapter plate, 6-port, dual SC, multimode, 50µm, composite sleeve, 10GbE
616SCAPC	Fiber adapter plate, 6-port, SC, single-mode, angled, composite sleeve
818MMSC	Fiber adapter plate, 8-port, SC, multimode, composite sleeve
818SC	Fiber adapter plate, 8-port, SC, multimode/single-mode, metal sleeve
818SMSC	Fiber adapter plate, 8-port, SC, single-mode, ceramic sleeve
818SCAPC	Fiber adapter plate, 8-port, SC, single-mode, angled, composite sleeve
6112MMDSC	Fiber adapter plate, 12-port, dual SC, multimode, composite sleeve
6112DSC	Fiber adapter plate, 12-port, dual SC, multimode/single-mode, metal sleeve
6112SMDSC	Fiber adapter plate, 12-port, dual SC, single-mode, ceramic sleeve
6112DSC50G	Fiber adapter plate, 12-port, dual SC, multimode, 50µm, composite sleeve, 10GbE
6112SMDSCAPC	Fiber adapter plate, 12-port, dual SC, single-mode, angled, ceramic sleeve

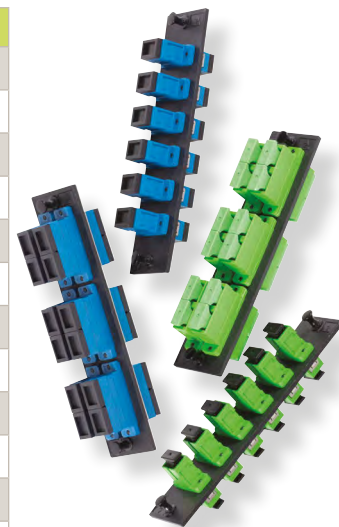



## (6.1) Adapter Plates

### LC Adapter Plates

PART NUMBER	DESCRIPTION
616MMDLC	Fiber adapter plate, 6-port, dual LC, multimode, composite sleeve
616DLC	Fiber adapter plate, 6-port, dual LC, multimode/single-mode, metal sleeve
616SMDLC	Fiber adapter plate, 6-port, dual LC, single-mode, ceramic sleeve
616DLC50G	Fiber adapter plate, 6-port, dual LC, multimode, 50µm, composite sleeve, 10GbE
818DLC	Fiber adapter plate, 8-port, dual LC, multimode/single-mode, composite sleeve
818SMDLC	Fiber adapter plate, 8-port, dual LC, single-mode, metal sleeve
6112DLC	Fiber adapter plate, 12-port, dual LC, multimode/single-mode, metal sleeve
6112MMDLC	Fiber adapter plate, 12-port, dual LC, multimode, ceramic sleeve
6112DLC50G	Fiber adapter plate, 12-port, dual LC, multimode, 50µm, composite sleeve, 10GbE
6112SMDLC	Fiber adapter plate, 12-port, dual LC, single-mode, ceramic sleeve
6124MMQLC	Fiber adapter plate, 24-port, quad LC, multimode, metal sleeve
6124SMQLC	Fiber adapter plate, 24-port, quad LC, single-mode, ceramic sleeve
616SMDLCAPC	Fiber adapter plate, 6-port, dual LC, APC, single-mode, ceramic sleeve
6112DLCAPC	Fiber adapter plate, 12-port, dual LC, APC, single-mode, metal sleeve
6124QLC50G	Fiber adapter plate, 24-port, quad LC, multimode, 50µm, composite sleeve, 10GbE

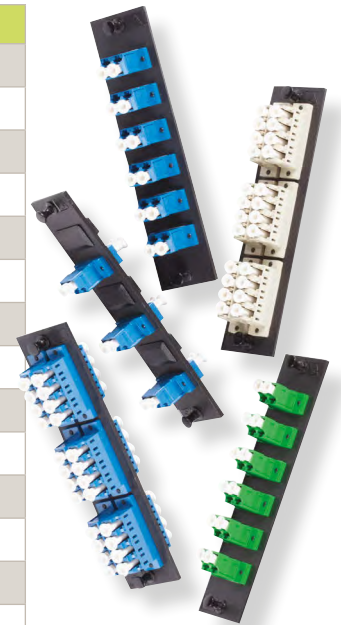

### ST Adapter Plates

PART NUMBER	DESCRIPTION
616MMST	Fiber adapter plate, 6-port, ST, multimode, composite sleeve
616ST	Fiber adapter plate, 6-port, ST, multimode/single-mode, metal sleeve
616SMST	Fiber adapter plate, 6-port, ST, single-mode, ceramic sleeve
616ST/SC	Fiber adapter plate, 6-port, ST to SC patch, multimode/single-mode, composite sleeve
818MMST	Fiber adapter plate, 8-port, ST, multimode, composite sleeve
818ST	Fiber adapter plate, 8-port, ST, multimode/single-mode, metal sleeve
818SMST	Fiber adapter plate, 8-port, ST, single-mode, ceramic sleeve
6112MMDST	Fiber adapter plate, 12-port, dual ST, multimode, composite sleeve
6112DST	Fiber adapter plate, 12-port, dual ST, multimode/single-mode, metal sleeve
6112SMDST	Fiber adapter plate, 12-port, dual ST, single-mode, ceramic sleeve

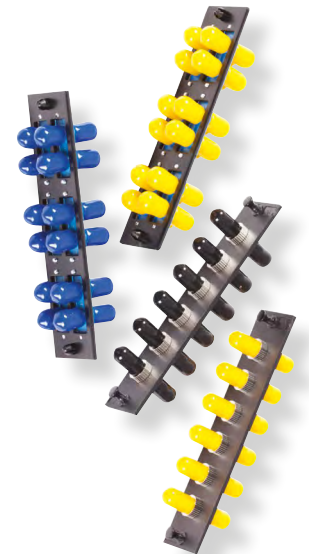

### MT Adapter Plates

PART NUMBER	DESCRIPTION
616MMMT	Fiber adapter plate, 6-adapter, multimode, MPO
616SMMT	Fiber adapter plate, 6-adapter, single-mode, MPO
6112MMMT	Fiber adapter plate, 12-adapter, multimode, MPO
6112SMMT	Fiber adapter plate, 12-adapter, single-mode, MPO
6112MT50G	Fiber adapter plate, 12-adapter, multimode, 50µm, MPO, 10GbE



 (6.1) Adapter Plates

## 50µm 10 Gig Adapter Plates

PART NUMBER	DESCRIPTION
616SC50G	Fiber adapter plate, 6-port, SC, multimode, 50µm, composite sleeve
616DSC50G	Fiber adapter plate, 6-port, dual SC, multimode, 50µm, composite sleeve
6112DSC50G	Fiber adapter plate, 12-port, dual SC, multimode, 50µm, composite sleeve
616DLC50G	Fiber adapter plate, 6-port, dual LC, multimode, 50µm, composite sleeve
6112DLC50G	Fiber adapter plate, 12-port, dual LC, multimode, 50µm, composite sleeve
6124QLC50G	Fiber adapter plate, 24-port, quad LC, multimode, 50µm, composite sleeve



616SC50G



6112DLC50G

## FC Adapter Plates

PART NUMBER	DESCRIPTION
616FC	Fiber adapter plate, 6-port, FC, multimode/single-mode, metal sleeve
616SMFC	Fiber adapter plate, 6-port, FC, single-mode, ceramic sleeve
616FCAPC	Fiber adapter plate, 6-port, FC, single-mode, angled, ceramic sleeve
818MMFC	Fiber adapter plate, 8-port, FC, multimode, composite sleeve
818FC	Fiber adapter plate, 8-port, FC, multimode/single-mode, metal sleeve
818SMFC	Fiber adapter plate, 8-port, FC, single-mode, ceramic sleeve
818FCAPC	Fiber adapter plate, 8-port, FC, single-mode, angled, ceramic sleeve



## MT-RJ Adapter Plates

PART NUMBER	DESCRIPTION
616MMRJ	Fiber adapter plate, 6-port, MT-RJ, multimode, composite sleeve
616MMDRJ	Fiber adapter plate, 6-port, dual MT-RJ, multimode, composite sleeve
818MMRJ	Fiber adapter plate, 8-port, MT-RJ, multimode, composite sleeve
6112MMDRJ	Fiber adapter plate, 12-port, dual MT-RJ, multimode, composite sleeve
6112SMDRJ	Fiber adapter plate, 12-port, dual MT-RJ, single-mode, composite sleeve



## Specialty Adapter Plates

PART NUMBER	DESCRIPTION
600	Fiber adapter plate, 6-port, blank
616BNC	Fiber adapter plate, 6-port, BNC adapters loaded
616F	Fiber adapter plate, 6-port, F adapters loaded
616SMA	Fiber adapter plate, 6-port, SMA adapters loaded



## (6.1) Adapter Plates

### HD Adapter Plates

PART NUMBER	DESCRIPTION
600HD	HD blank plate
616FCHD	HD adapter plate, 6-port, FC, SM/MM
616SMFCHD	HD adapter plate, 6-port, FC, single-mode
616FCAPCHD	HD adapter plate, 6-port, FC, APC polish, single-mode
616SCHD	HD adapter plate, 6-port, SC, SM/MM
616SMSCHD	HD adapter plate, 6-port, SC, single-mode
616SCAPCHD	HD adapter plate, 6-port, SC, APC polish, single-mode
616MMSCHD	HD adapter plate, 6-port, SC, multimode
616SC50GHD	HD adapter plate, 6-port, SC, 50µm OM3
616SC50QHD	HD adapter plate, 6-port, SC, 50µm OM4
616SC/STHD	HD adapter plate, 6-port, SC to ST, SM/MM
616STHD	HD adapter plate, 6-port, ST, SM/MM
616SMSTHD	HD adapter plate, 6-port, ST, single-mode
616MMSTHD	HD adapter plate, 6-port, ST, multimode
616MMSTGHD	HD adapter plate, 6-port, ST, 50µm OM3
616MMSTQHD	HD adapter plate, 6-port, ST, 50µm OM4
6112DLCHD	HD adapter plate, 12-port, dual LC, SM/MM
6112SMDLCHD	HD adapter plate, 12-port, dual LC, single-mode
6112DLCAPCHD	HD adapter plate, 12-port, dual LC, APC polish, single-mode
6112MMDLCHD	HD adapter plate, 12-port, dual LC, multimode
6112DLC50GHD	HD adapter plate, 12-port, dual LC, 50µm, OM3
6112DLC50QHD	HD adapter plate, 12-port, dual LC, 50µm, OM4
6112DSCHD	HD adapter plate, 12-port, dual SC, SM/MM
6112MMDSCHD	HD adapter plate, 12-port, dual SC, multimode
6112SMDSCHD	HD adapter plate, 12-port, dual SC, single-mode
6112SMDSCAPCHD	HD adapter plate, 12-port, dual SC, APC polish, single-mode
6112DSC50GHD	HD adapter plate, 12-port, dual SC, 50µm OM3
6112DSC50QHD	HD adapter plate, 12-port, dual SC, 50µm OM4
6124MMQLCHD	HD adapter plate, 24-port, quad LC, multimode
6124QLCHD	HD adapter plate, 24-port, quad LC, SM/MM
6124SMQLCHD	HD adapter plate, 24-port, quad LC, single-mode
6124QLCAPCHD	HD adapter plate, 24-port, quad LC, APC polish, single-mode
6124QLC50GHD	HD adapter plate, 24-port, quad LC, 50µm OM3
6124QLC50QHD	HD adapter plate, 24-port, quad LC, 50µm OM4

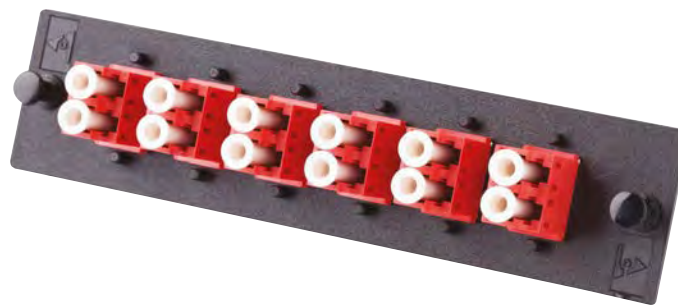
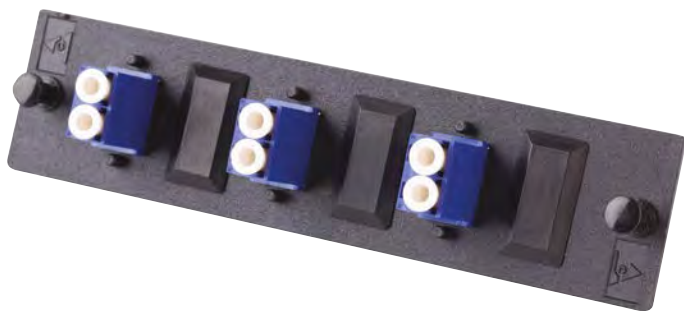
 (6.1m) Keyed Adapter Plates

## Keyed Adapter Plates

PART NUMBER	6-PORT ADAPTER PLATES
LAX616DLCBL	Adapter plate, DLCX3, keyed, SM/MM, blue
LAX616DLCGN	Adapter plate, DLCX3, keyed, SM/MM, green
LAX616DLCRD	Adapter plate, DLCX3, keyed, SM/MM, red
LAX616DLCYL	Adapter plate, DLCX3, keyed, SM/MM, yellow
LAX616DLCPK	Adapter plate, DLCX3, keyed, SM/MM, pink
LAX616DLCWT	Adapter plate, DLCX3, keyed, SM/MM, white
LAX616DLCOR	Adapter plate, DLCX3, keyed, SM/MM, orange
LAX616DLCPL	Adapter plate, DLCX3, keyed, SM/MM, purple
LAX616DLCSL	Adapter plate, DLCX3, keyed, SM/MM, slate
LAX616DLCBN	Adapter plate, DLCX3, keyed, SM/MM, brown
LAX616DLCAQ	Adapter plate, DLCX3, keyed, SM/MM, aqua
LAX616DLCRS	Adapter plate, DLCX3, keyed, SM/MM, rose

PART NUMBER	24-PORT ADAPTER PLATES
LAX6124QLCBL	Adapter plate, QLCX6, keyed, SM/MM, blue
LAX6124QLCGN	Adapter plate, QLCX6, keyed, SM/MM, green
LAX6124QLCRD	Adapter plate, QLCX6, keyed, SM/MM, red
LAX6124QLCYL	Adapter plate, QLCX6, keyed, SM/MM, yellow
LAX6124QLCPK	Adapter plate, QLCX6, keyed, SM/MM, pink
LAX6124QLCWT	Adapter plate, QLCX6, keyed, SM/MM, white
LAX6124QLCOR	Adapter plate, QLCX6, keyed, SM/MM, orange
LAX6124QLCPL	Adapter plate, QLCX6, keyed, SM/MM, purple
LAX6124QLCSL	Adapter plate, QLCX6, keyed, SM/MM, slate
LAX6124QLCBN	Adapter plate, QLCX6, keyed, SM/MM, brown
LAX6124QLCAQ	Adapter plate, QLCX6, keyed, SM/MM, aqua
LAX6124QLCRS	Adapter plate, QLCX6, keyed, SM/MM, rose

PART NUMBER	12-PORT ADAPTER PLATES
LAX6112DLCBL	Adapter plate, DLCX6, keyed, SM/MM, blue
LAX6112DLCGN	Adapter plate, DLCX6, keyed, SM/MM, green
LAX6112DLCRD	Adapter plate, DLCX6, keyed, SM/MM, red
LAX6112DLCYL	Adapter plate, DLCX6, keyed, SM/MM, yellow
LAX6112DLCPK	Adapter plate, DLCX6, keyed, SM/MM, pink
LAX6112DLCWT	Adapter plate, DLCX6, keyed, SM/MM, white
LAX6112DLCOR	Adapter plate, DLCX6, keyed, SM/MM, orange
LAX6112DLCPL	Adapter plate, DLCX6, keyed, SM/MM, purple
LAX6112DLCSL	Adapter plate, DLCX6, keyed, SM/MM, slate
LAX6112DLCBN	Adapter plate, DLCX6, keyed, SM/MM, brown
LAX6112DLCAQ	Adapter plate, DLCX6, keyed, SM/MM, aqua
LAX6112DLCRS	Adapter plate, DLCX6, keyed, SM/MM, rose

PART NUMBER	8-PORT ADAPTER PLATES
LAX818DLCBL	Adapter plate, DLCX4, SM/MM, blue
LAX818DLCGN	Adapter plate, DLCX4, SM/MM, green
LAX818DLCRD	Adapter plate, DLCX4, SM/MM, red
LAX818DLCYL	Adapter plate, DLCX4, SM/MM, yellow
LAX818DLCPK	Adapter plate, DLCX4, SM/MM, pink
LAX818DLCWT	Adapter plate, DLCX4, SM/MM, white
LAX818DLCOR	Adapter plate, DLCX4, SM/MM, orange
LAX818DLCPL	Adapter plate, DLCX4, SM/MM, purple
LAX818DLCSL	Adapter plate, DLCX4, SM/MM, slate
LAX818DLCBN	Adapter plate, DLCX4, SM/MM, brown
LAX818DLCAQ	Adapter plate, DLCX4, SM/MM, aqua
LAX818DLCRS	Adapter plate, DLCX4, SM/MM, rose

## (6.2a) Anaerobic Connectors

### Fiber Optic Connectors

For those who prefer to assemble connectors at the component level, OCC offers a complete line of connector kits for field terminations. Each connector kit offers exceptional optical performance in an easy-to-install form factor.

- Available in FC, LC, SC, and ST connector styles.
- Single-mode and multimode
- Low insertion loss and back reflection

### Fiber Optic Connectors

PART NUMBER	DESCRIPTION
FC-FC-APC	FC connector kit, single-mode, APC, 3mm boot
FC-FC-SM	FC connector kit, single-mode, 3mm boot
FC-FC-MM	FC connector kit, multimode, 3mm boot
FC-LC-3MM	LC connector kit, multimode, 3mm boot
FC-LC-3MM-BLK	LC connector kit, multimode, 3mm black boot
FC-LC-3SM	LC connector kit, single-mode, 3mm boot
FC-LC-3SM-BLK	LC connector kit, single-mode, 3mm black boot
FC-LC-APC	LC connector kit, single-mode, APC, 2mm boot
FC-LC-SM	LC connector kit, single-mode, blue housing, 2mm boot
FC-LC-MM	LC connector kit, multimode, beige housing, 2mm boot
FC-LC-MM-Q/Q	LC connector kit, multimode, 2mm aqua boot
FC-ST-SM	ST connector kit, single-mode, 3mm boot
FC-ST-SM-BLK	ST connector kit, single-mode, 3mm black boot
FC-ST-MM	ST connector kit, multimode, 3mm boot
FC-ST-MM-BLK	ST connector kit, multimode, 3mm black boot
FC-ST-MM-AQU	ST connector kit, multimode, 3mm aqua boot
FC-ST-2MM	ST connector kit, multimode, 2mm boot
FC-SC-SM	SC connector kit, single-mode, blue housing, 3mm boot
FC-SC-MM	SC connector kit, multimode, beige housing, 3mm boot
FC-SC-APC	SC connector kit, single-mode, APC, 3mm boot
FC-SC-MM-Q/Q	SC connector kit, multimode, 3mm aqua boot

**Note:** Additional anaerobic boots available from factory. Please call OCC for details.

### Specifications

PARAMETER	VALUE				
Insertion loss (average)	0.2 dB				
Reflectance	<table border="0"> <tr> <td>&lt; -30 dB for PC</td> <td>&lt; -55 dB for Ultra PC</td> </tr> <tr> <td>&lt; -40 dB for Super PC</td> <td>&lt; -65 dB for Angled PC</td> </tr> </table>	< -30 dB for PC	< -55 dB for Ultra PC	< -40 dB for Super PC	< -65 dB for Angled PC
< -30 dB for PC	< -55 dB for Ultra PC				
< -40 dB for Super PC	< -65 dB for Angled PC				
Durability	≤ 0.2 dB change, 500 rematings, FOTP -21				
Tensile strength	≤ 0.2 dB change, 15 lb, FOTP -6				
Temperature cycling	-40° to +75°C, 21 cycles, < 0.3 dB change				
Material	Ferrule: preradiused zirconia, Housing: thermoplastic				

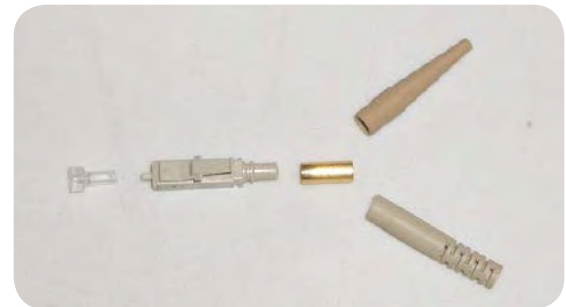
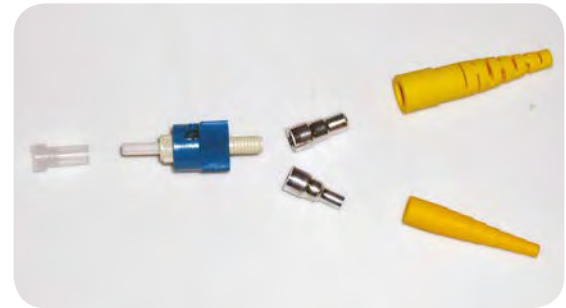

Please call 1-800-622-7711 and ask for a Sales Representative. We're ready to assist you.

 (6.2b) Xpress Connectors

## Xpress Connectors

OCC's Xpress Fiber Connectors are the new generation in field-installable fiber terminations. These connectors eliminate the need for messy epoxies and expensive tools by offering a pre-polished solution that can be installed in minutes. Xpress Connectors have a pre-stubbed factory-polished ferrule that joins to the fiber using a precise mechanical alignment and a special low-loss index matching gel. Each connector comes with a specially designed clip that holds the clamping devices open for the fiber to be inserted. Once the fiber is inserted, squeeze the clip to release the blades, remove clip and discard.

- Available for single-mode and multimode fibers and options of SC, ST, and LC termination styles
- Easy to assemble
- No expensive tools or epoxy required
- No polishing required
- Fiber can be reinstalled
- Meets TIA/EIA 568 performance requirements
- All connectors include 900 $\mu$ m boot – 2mm and 3mm boots sold separately

## Xpress Fiber Connectors

PART NUMBER	DESCRIPTION
FXC-SCx-6	Xpress SC connector, 6-pack
FXC-STx-6	Xpress ST connector, 6-pack
FXC-LCx-6	Xpress LC connector, 6-pack
FXC-BOOT-2MM	2.0mm boot for Xpress connectors, 6-pack
FXC-BOOT-3MM	3.0mm boot for Xpress connectors, 6-pack
FXC-SCAPC8-6	Xpress SC connector, SM, APC, 6-pack
Replace "x" with <b>5</b> = 50 $\mu$ m, <b>5G</b> =50 $\mu$ m OM3/OM4, <b>6</b> = 62.5 $\mu$ m, or <b>8</b> = single-mode	

## Specifications

PARAMETER	VALUE
Insertion loss: Single-mode 50/125 62.5/125	Average: 0.2 dB, Maximum: 0.5 dB Average: 0.1 dB, Maximum: 0.5 dB Average: 0.1 dB, Maximum: 0.5 dB
Return loss (single-mode)	Average: 56.4 dB, Maximum: 45 dB
Operating temperature	-40°C to +75°C

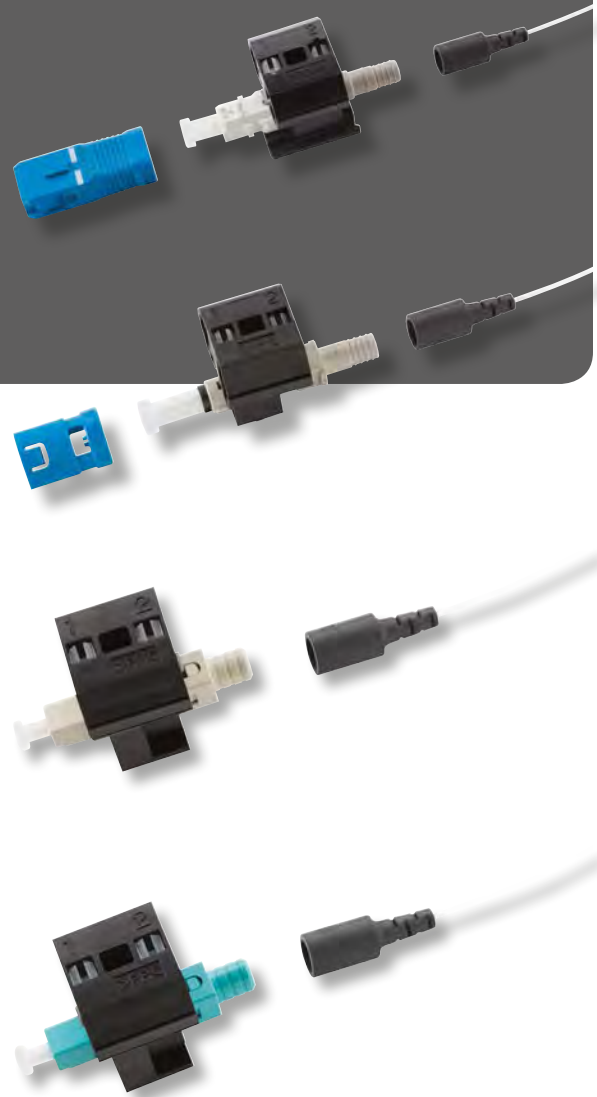



## (6.3a) Enterprise Fiber Optic Jumpers

### Fiber Optic Jumpers and Pigtails

Get exactly the jumper you need to make the transition from cross-connect point to the electronics. With unmatched insertion loss and exceptional return loss performance, OCC's comprehensive line of fiber jumpers ensures the right connection every time. Available in simplex or duplex, multimode 50/125, 62.5/125, or single-mode in a variety of connector types and lengths.

OCC's jumpers feature:

- Automated polishing equipment
- Multi-fiber distribution cables, single or dual ended terminations
- Discrete connectors utilizing ceramic ferrules
- Custom jacket colors for security applications
- Availability of any specified length
- Standard riser rated cable with PC polish for multimode (If UPC or APC polish or custom length is required, please call 1-800-622-7711 and ask for a Sales Representative. We're ready to assist you).

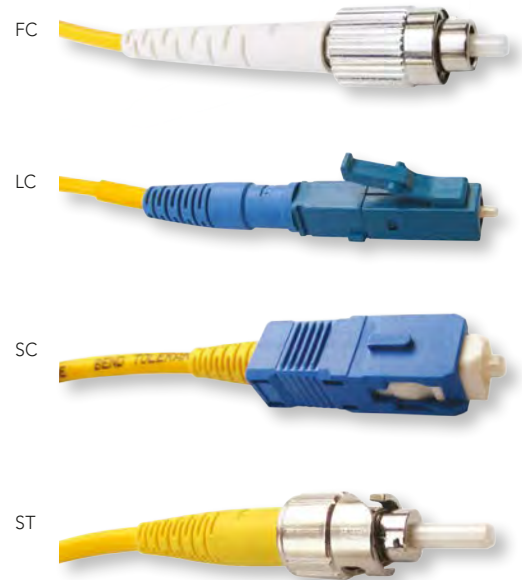

### Fiber Optic Jumpers

FIBER COUNT	FIBER TYPE	CONNECTOR TYPE	POLISH TYPE	CONNECTOR TYPE	POLISH TYPE	LENGTH IN METERS	FIBER BANDWIDTH	CABLE TYPE
06	5 = 50µm OM2 ALS*	ST	Leave Blank for Standard PC	ST	Leave Blank for Standard PC	1M	G = 50µm OM3 ALT	Leave Blank for Riser rated
12	6 = 62.5µm OM1 WLS	SC	UPC = Ultra	SC	UPC = Ultra	2M	Q = 50µm OM4 ALE	P = Plenum rated
24		LC		LC		3M		L = LSZH
	8 = Single-mode SLA*	FC	APC = Angled	FC	APC = Angled	5M		
	*Bend-insensitive fiber					10M		
						Any custom length available		

#### Examples:

D6SC-SC-1M = Duplex 62.5µm, SC to SC, 1 meter in length  
 S8LCUPC-LCUPC-3M = Simplex Ultra Polish, LC to LC, 3 meters in length

**Note:** See Ultra-Fox fiber performance chart, pg. 332.

### Polishes-Discretetes

SINGLE-MODE	TYPICAL INSERTION LOSS		TYPICAL RETURN LOSS	
	TYPICAL	MAX	TYPICAL	MAX
UPC	0.15 dB	0.25 dB	-55 dB	-50 dB
APC	0.15 dB	0.25 dB	-65 dB	-60 dB

MULTIMODE	TYPICAL INSERTION LOSS		TYPICAL RETURN LOSS	
	TYPICAL	MAX	TYPICAL	MAX
PC	0.15 dB	0.25 dB	-30 dB	-25dB

## (6.3a.1) Enterprise Fiber Optic Jumpers – Keyed LC

### Keyed LC Fiber Optic Connectors

OCC's keyed LC connectors offer limited accessibility to fiber optic networks through a physically restrictive cross-connect system. By utilizing the LC fiber optic connectors, network administrators can easily segregate networks for security or confidentiality applications.

The LAX-series adapter plates and patch cables are available in 12 keyed, color-coded options that limit unauthorized access to network ports. All LAX adapter plates are accepted in any of OCC's fiber optic enclosures and can even be pre-terminated for easy plug-and-play installations.



### Features and Benefits

- 12 keyed, standard color-coded options: Red, Blue, Green & Yellow
- Keyed LC adapters prevent improper connection of separate networks with common access points

### Keyed LC Patch Cable Configuration

TYPE	FIBER TYPE	CABLE TYPES	END A	END B	LENGTH IN METERS	COLOR
<b>S</b> = Simplex <b>D</b> = Duplex	<b>8</b> = Single-mode SLA* <b>6</b> = 62.5µm OM1 WLS <b>5</b> = 50µm OM2 ALS* <b>5G</b> = 50µm OM3 ALT* <small>*Bend-insensitive fiber</small>	Leave blank for Riser rated <b>P</b> = Plenum rated <b>L</b> = LSZH	<b>LCK</b> = Keyed LC	<b>LCK</b> = Keyed LC <b>LC</b> = LC Connector <b>SC</b> = SC Connector <b>SCAPC</b> = SC Angled Connector <b>ST</b> = ST Connector <b>FC</b> = FC Connector	<b>1M</b> <b>2M</b> <b>3M</b> <b>5M</b> <b>10M</b> Any custom length available	<b>BL</b> = Blue <b>GR</b> = Green <b>RD</b> = Red <b>YL</b> = Yellow <b>PK</b> = Pink <b>WT</b> = White <b>OR</b> = Orange <b>PL</b> = Purple <b>SL</b> = Slate <b>BN</b> = Brown <b>AQ</b> = Aqua <b>RS</b> = Rose

**Example:**

D5GPLCK-LC-003BL = Duplex, OM3 10 Gig, plenum, Keyed LC to Standard LC, 3 meters, blue

**Note:** See Ultra-Fox fiber performance chart, pg. 332.

## (6.3a.2) Enterprise Fiber Optic Jumpers – Secure LC

### Secure LC Fiber Optic Connectors

OCC introduces a new Secure LC fiber optic connector designed to provide an extra layer of secure access to network ports. The secure LC connectors utilize a special extraction tool to help prevent unauthorized release of the connector from the network panel. This added level of protection is ideal for military and government applications, as well as in data centers that require additional security against tampering. The connectors include secure LC patch cables available in eight color options, extraction tools, and port plugs. The connectors install easily in any industry-standard LC fiber adapter. Patch cables are available in a multitude of configurations using OCC's HD bend-insensitive cables, including multimode and single-mode options.



### Features and Benefits

- When inserted, the tamper-proof Secure LC becomes locked to the port and requires a keyed extraction tool for removal
- Return loss = 55dB typical for UPC
- Mates with standard LC duplex & quad adapters and interfaces
- Compact, single-body duplex format
- Dust cap "retention" feature
- Suitable for 3mm mini-duplex cables
- 8 colors available
- Installs in any industry-standard LC fiber adapter
- Extraction tools and plugs may be ordered separately



### Ordering Information

OCC PART NUMBER	CABLE TYPE	CONNECTOR SIDE "A"	CONNECTOR SIDE "B"
D6PLCSxx-LCSxx-xxM	62.5/125 WLS orange plenum	LC Secure	LC Secure
D5PLCSxx-LCSxx-xxM	50/125 ABT aqua OM3 plenum	LC Secure	LC Secure
D8PLCSxx-LCSxx-xxM	9/125 SLA single-mode yellow plenum	LC Secure	LC Secure
D6RLCSxx-LCSxx-xxM	62.5/125 WLS orange riser	LC Secure	LC Secure
D5RLCSxx-LCSxx-xxM	50/125 ABT aqua OM3 riser	LC Secure	LC Secure
D8RLCSxx-LCSxx-xxM	9/125 SLA single-mode yellow riser	LC Secure	LC Secure
D6PLCSxx-LC-xxM	62.5/125 WLS orange plenum	LC Secure	LC Singlebody
D5PLCSxx-LC-xxM	50/125 ABT aqua OM3 plenum	LC Secure	LC Singlebody
D8PLCSxx-LC-xxM	9/125 SLA single-mode yellow plenum	LC Secure	LC Singlebody
D6RLCSxx-LC-xxM	62.5/125 WLS orange riser	LC Secure	LC Singlebody
D5RLCSxx-LC-xxM	50/125 ABT aqua OM3 riser	LC Secure	LC Singlebody
D8RLCSxx-LC-xxM	9/125 SLA single-mode yellow riser	LC Secure	LC Singlebody
D6PLCSxx-SC-xxM	62.5/125 WLS orange plenum	LC Secure	SC Singlebody
D5PLCSxx-SC-xxM	50/125 ABT aqua OM3 plenum	LC Secure	SC Singlebody
D8PLCSxx-SC-xxM	9/125 SLA single-mode yellow plenum	LC Secure	SC Singlebody
D6RLCSxx-SC-xxM	62.5/125 WLS orange riser	LC Secure	SC Singlebody
D5RLCSxx-SC-xxM	50/125 ABT aqua OM3 riser	LC Secure	SC Singlebody
D8RLCSxx-SC-xxM	9/125 SLA single-mode yellow riser	LC Secure	SC Singlebody

Replace "xx" with color code from chart.

#### "XX" COLOR CODES

OR – Orange
GR – Green
RD – Red
BK – Black
YW – Yellow
WH – White
BL – Blue
SL – Gray
VI – Purple

**Note:** See Ultra-Fox fiber performance chart, pg. 332.



## (6.3a.2) Enterprise Fiber Optic Jumpers – Secure LC

PART NUMBER	LC SECURED EXTRACTION HARDWARE	COLOR
LCS-ETOR	Extraction tool	Orange
LCS-ETGR	Extraction tool	Green
LCS-ETRD	Extraction tool	Red
LCS-ETBK	Extraction tool	Black
LCS-ETYW	Extraction tool	Yellow
LCS-ETWH	Extraction tool	White
LCS-ETBL	Extraction tool	Blue
LCS-ETSL	Extraction tool	Gray
LCS-METVI	Master extraction tool	Purple

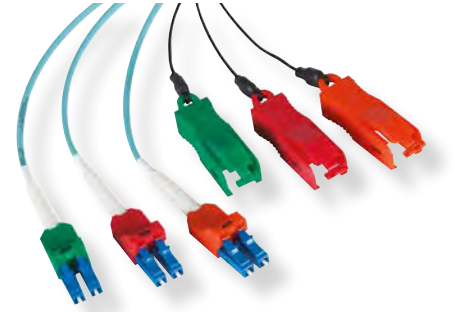

PART NUMBER	LC SECURED LOCKING PLUG HARDWARE	COLOR
LCS-LPOR	Locking plug	Orange
LCS-LPGR	Locking plug	Green
LCS-LPRD	Locking plug	Red
LCS-LPBK	Locking plug	Black
LCS-LPYW	Locking plug	Yellow
LCS-LPWH	Locking plug	White
LCS-LPBL	Locking plug	Blue
LCS-LPSL	Locking plug	Gray

PART NUMBER	LC SECURED DUST CAP HARDWARE	COLOR
LCS-DCBL	Dust cap	Blue

## (6.3b) Enterprise Fiber Optic Pigtails

### Fiber Optic Pigtails

OCC's fiber optic pigtail assemblies are designed for reliability and performance. All OCC pigtail assemblies may be ordered pre-terminated in any OCC rack- or wall-mount cabinet or custom configured for field installations. Either way, Optical Cable Corporation's pigtail assemblies combine high-precision zirconia ferrules and rugged composite hardware to provide the optical performance, durability and repeatability necessary for today's most challenging network applications.

- Available in 6- or 12-bundle pigtails
- Color-coded 900µm designed for splicing in enclosure environments
- Fiber sleeve is color coded to differentiate multimode, single-mode, and 50µm
- Jacketed cable pigtails also available
- Any specified length available

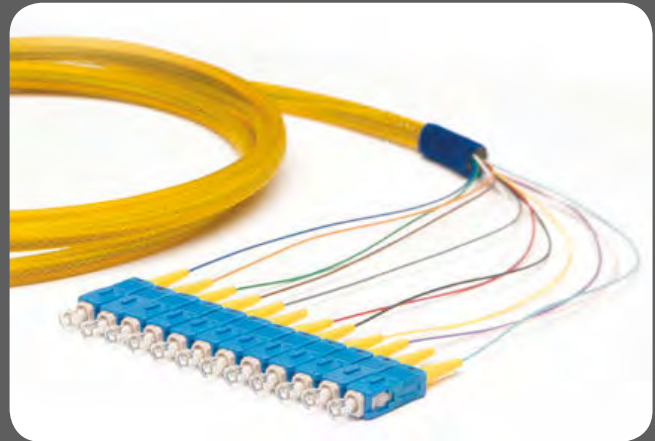

### Pigtail Assemblies

P					
				-	
FIBER TYPE	CONNECTOR TYPE	POLISH TYPE	FIBER COUNT	LENGTH IN METERS	FIBER MATERIAL
5 = 50µm OM2 ALS*	ST	UPC = Ultra Polish	06	1M	R = Riser rated
5G = 62.5µm OM3 ALT*	SC	APC = Angled Polish	12	2M	P = Plenum rated
5Q = 62.5µm OM4 ALE*	LC	PC = Standard**		3M	L = LSZH
6 = 62.5µm OM1 WLS	FC	**Multimode available in PC only.		5M	
8 = Single-Mode SLA*		If UPC is required, please call 540-265-0690 and ask for a Sales Representative. We are ready to assist you.		Any custom length available	
*Bend-insensitive fiber					

**Example:** P8SCUPC12-3MR = Pigtail assembly, single-mode, SC, ultra polish, 12-fiber, 3 meters in length, Riser rated

**Note:** See Ultra-Fox fiber performance chart, pg. 332.

### Polishes-Discretetes

SINGLE-MODE	TYPICAL INSERTION LOSS		TYPICAL RETURN LOSS	
	FERRULE TYPE	TYPICAL	MAX	TYPICAL
UPC	0.15 dB	0.25 dB	-55 dB	-50 dB
APC	0.15 dB	0.25 dB	-65 dB	-60 dB

MULTIMODE	TYPICAL INSERTION LOSS		TYPICAL RETURN LOSS	
	FERRULE TYPE	TYPICAL	MAX	TYPICAL
PC	0.15 dB	0.25 dB	-30 dB	-25dB

## (6.3c) MT Cable Assemblies

### MPO Fiber Optic Cable Assemblies

The OCC MPO-to-MPO Cable Assembly, coupled with OCC's MPO Cassette Modules, offers a true plug-and-play connectivity solution that effectively eliminates standard labor costs associated with fiber field installations. The MPO solution ensures guaranteed performance through 100% testing to ISO procedures and provides a low-profile, cross-connect solution designed for reliability in today's high-density and high-speed network applications. Included with the MPO solution, OCC's pulling eye simplifies connectivity needs by streamlining connectors for snag-less installations. This product can be used for pulling connected cable through conduit or other channels, enabling quick connections.



- Available in 50/125µm or 62.5/125µm multimode
- Single-mode also available
- Plenum rated and Riser rated cable can be ordered in any length
- MPO connectors are MTP® compatible

MTP is a registered trademark of US Conec.

### MPO to MPO Cable Assemblies

MT	FIBER COUNT	CABLE TYPE	FIBER STYLE	CONNECTOR ENDS	FIBER TYPE	FIBER BANDWIDTH	LENGTH IN FEET	PULLING EYE KIT
	06	P = Plenum rated	R = Round	F = Female	5 = 50µm OM2 ALS/ALX*	TK = OM1, OM2, SM		PK = 1 end
	12	R = Riser rated		M = Male	6 = 62.5µm OM1 WLS	TG = 50µm OM3 ALT		PK2 = 2 ends
	24	L = LSZH			8 = Single-mode SLA/SLX*	TQ = 50µm OM4 ALE		

\*Bend-insensitive fiber

#### Example:

MT12PRM8TK-3PK = MPO riser cable assembly, 12-fiber, plenum, round, male connectors, single-mode bend-insensitive fiber, 3 feet in length with one end pulling kit

**Note:** When ordering single-mode assemblies please state whether application requires standard polish or APC polish.

### Optical Performance per Connection

MTP/MPO SINGLE-MODE	TYPICAL INSERTION LOSS		TYPICAL RETURN LOSS	
	TYPICAL	MAX	TYPICAL	MAX
Standard UPC	0.35 dB	0.75 dB	-55 dB	-50 dB
Elite APC	0.25 dB	0.35 dB	-65 dB	-60 dB
24-fiber Elite APC	0.50 dB	0.75 dB	-55 dB	-50 dB

MTP/MPO MULTIMODE	INSERTION LOSS		RETURN LOSS	
	TYPICAL	MAX	TYPICAL	MAX
Standard PC	0.35 dB	0.60 dB	-25 dB	-20 dB
Elite PC	0.20 dB	0.35 dB	-25 dB	-20 dB
24-fiber Elite	0.50 dB	0.75 dB	-25 dB	-20 dB



## (6.3d) Made-to-Order Standard Trunk Cables

### Made-to-Order Standard Trunk Cables

Smaller diameter, higher density MPO (MTP® compatible) Nano trunk multicore cable assemblies streamline installation and reduce total cost for facilities that require high density backbone cabling.

Application examples consist of the following:

- Data Centers
- Passive Optical LAN applications
- High Density Industrial
- Broadcast/AV
- Extreme Performance Requirement Applications
- Security/Monitoring

OCC offers a wide variety of MPO-MTP multi-fiber cable assemblies, including:

- Arrays for cassettes
- Panels
- MPO/MTP fanouts
- Spanning MDA, HDA and EDA zones

There are many benefits to pre-terminated trunk cable assemblies:

- Smaller size
- Higher density
- Reduces installation time
- Reduces labor costs
- Indoor and outdoor applications
- Temperature and water-resistant
- Tested to customer performance requirements prior to leaving factory

OCC manufactures a wide variety of cable constructions as required by even the most demanding application. In addition to standard enterprise type connectors, OCC manufactures many harsh environment connectors that can be terminated on our cable at the factory.

Contact the OCC team of cable experts to help customize your pre-terminated cable assembly and leverage the advantages of lower total cost and faster installation.

MTP is a registered trademark of US Conec, Ltd.



### Information required to customize your pre-terminated fiber assembly:

Cable construction	See Fiber Cable Construction Configurator in New Appendix, pg. 24–25.
Fiber type	See Laser Ultra-Fox Fiber Performance Table, pg. 331.
Fiber count	See available fiber counts on product pages of interest
Cable length	Most pre-terminated cable assemblies can be built to your length requirements and various reel put ups
Connector type on each end	See Enterprise Connectors, pg. 235–236.
Pulling Kits	Are pulling kits required on one or both ends of the cable assembly?

## (6.4a) Procyon™ Fiber Enclosure

### OCC's Procyon™ family of high-performance, easy-to-install data center solutions

The Procyon fiber enclosure by OCC is designed for high density with comprehensive trunk and patch cord cable management features. The unit accommodates 144 LCs or 48 MPOs in 1RU. The unit is designed to be easily accessible when fully populated, can be horizontally or vertically mounted (with hardware), and is intended to be used for switching, server and storage applications.

### Features & Benefits

- High-density connectivity — containing 144 LC in 1RU (10G) or 48 MT in 1RU (40/100G)
- Accommodates 12 Procyon cassettes simultaneously, with each column containing three cassettes vertically, four columns left to right
- Combined cassette and panel chassis cable management for easy access to all connectivity during high-density installations
- Forward maneuverability of the sliding panel allows spatial offset from other panels for easy access during servicing
- Bow clip technology allows for easy positioning of the chassis during single-person service and installation
- The patent-pending forward side-exit cable management creates distinct 3-tier routing paths for each vertical cassette, allows for direct coupling with integrated cassette cable management, and includes a waterfall feature for routing to the top or bottom of the cabinet
- Removable front and rear covers
- Labeling protected on the inside of front panel cover, accessible when panel is open
- TempGrip rear trunk cable management technology for easy installation and can be permanently locked down with covering bracket when installation is completed
- Vertical or horizontal orientation of the connectivity hardware
- Vertical mounting kit available with horizontal cable management, accommodating 10 1RU panels vertically, left to right

### Applications

- High-density (144 LC/48 MT/1152 fiber)
- Data center
- Vertically-oriented core switches
- Server cabinets
- Switching cabinets
- Fiber channel for storage area networks



*Procyon fiber panels mounted vertically*

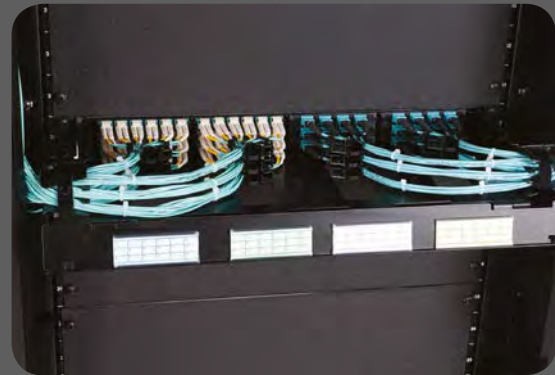

*Horizontal Procyon panel populated with cassettes*

## (6.4a) Procyon™ Fiber Enclosure

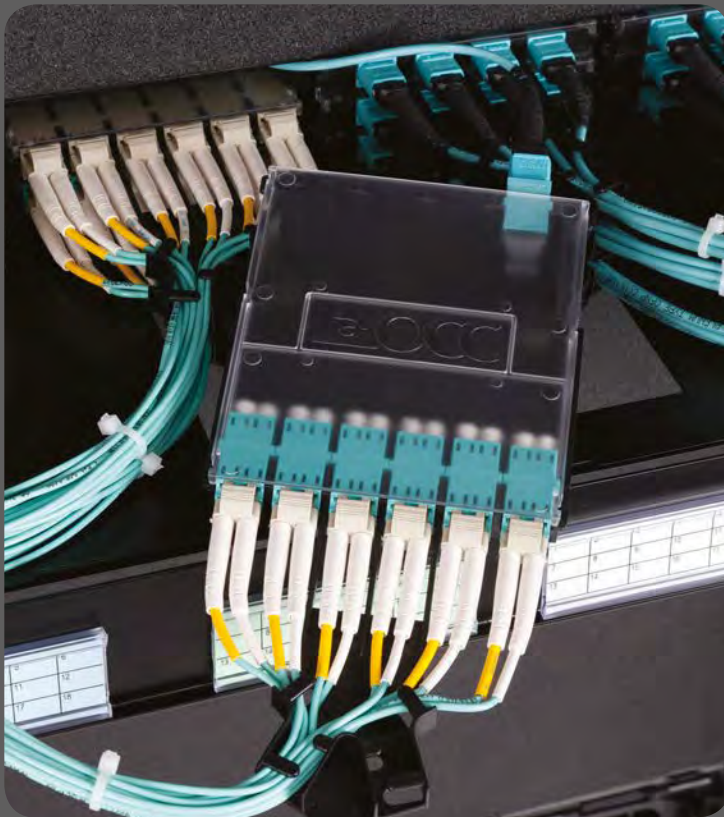

Procyon fiber enclosure loaded with cassettes



TempGrip cable management



Vertical mounting brackets with cable manager



Procyon fiber enclosure

### Physical Specifications

DIMENSION	VALUE
Height:	1.70"
Width:	22.17"
Depth:	19.80"

### Ordering Information

PART NUMBER	DESCRIPTION
PROF1U	Slim-line panel for mounting in 24" Data Center Cabinet, fiber, 1RU empty
PROVBKT	Vertical-mounting bracket with integrated cable management for PROF1U and PROF1USL

**PROCYON**  
part of the OCC family  
of data center solutions

## (6.4b) Procyon™ MPO-MPO Cassettes

### Part of OCC's Procyon family of high-performance, easy-to-install data center solutions

The Procyon Fiber Cassette by OCC is designed to provide easy transition of trunk cables terminated with MPO-to-MPO patch cords for 40/100 Gbit/s Ethernet connectivity. It is part of an overall upgradable pre-terminated cabling architecture. The MPO-MPO cassette boasts a small form factor for maximum density and integrated cable management and cassette extraction features.

### Features & Benefits

- Accommodates 4 MTP connections with either 12- or 24-fiber configurations in a single cassette
- Small overall form factor
- High-density (48 MPOs in 1RU) when used with OCC fiber panel
- Left or right directivity for preferred forward exit management
- Pull tab feature for easy cassette extraction
- Proprietary bow clip positioning and retention mechanism
- Clear cover for easy visual inspection
- Available with and without forward cable management
- Bidirectional capture mechanism when reverse orientation is required during installation
- Upgradable from LC cassette for 10G to 40/100G future applications

### Applications

- High-density
- Data Center
- Horizontal panel for server/storage cabinets
- Vertical panel for switching cabinets
- Any bulk transport of MPO connections in a trunk cable
- 40G (12-fiber MT) or 100G (24-fiber)

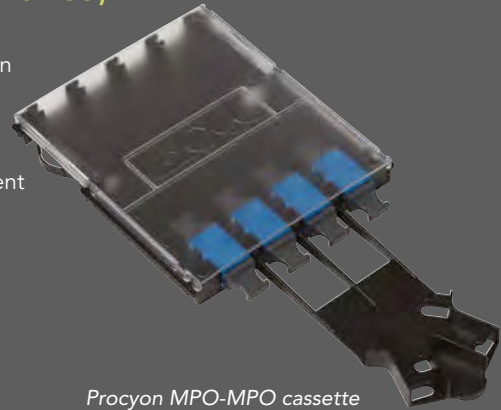

Procyon MPO-MPO cassette

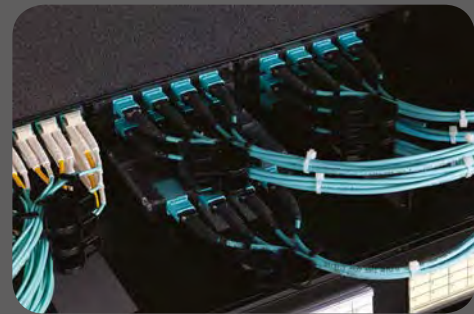

Procyon MPO-MPO cassette loaded in Procyon Panel



Close-up of pull tab



Close-up of bow clip mechanism

## Ordering Information

PART NUMBER	DESCRIPTION	HEIGHT	WIDTH	DEPTH
PROMT48MTSM	Cassette assembly, MPOX4, SM, Procyon, no fiber	.49"	3.88"	8.89" (4.40" cassette only)
PROMT48MTMMG	Cassette assembly, MPOX4, OM3, Procyon, no fiber	.49"	3.88"	8.89" (4.40" cassette only)
PROMT48MTMM	Cassette assembly, MPOX4, 62.5, Procyon, no fiber	.49"	3.88"	8.89" (4.40" cassette only)
PROMT48TMMQ	Cassette assembly, MPOX4, OM4, Procyon, no fiber	.49"	3.88"	8.89" (4.40" cassette only)



## (6.4c) Procyon™ MPO-LC Cassettes

### Part of OCC's Procyon family of high-performance, easy-to-install data center solutions

The Procyon Fiber Cassette by OCC is designed to provide easy transition of trunk cables terminated with MPO connections to LC duplex connectivity in your data center. It is part of an overall pre-terminated cabling architecture — and with a small form factor and integrated cable management and cassette extraction features — it delivers high-density while simultaneously maintaining easy accessibility.

### Features & Benefits

- Accommodates 1 MPO to 12 LC fiber connections
- Integrated left or right directional management
- Pull tab feature for easy cassette extraction
- Proprietary bow clip positioning and retention mechanism
- Clear cover for easy visual inspection
- Easily upgradeable to 40/100 Gb/s Ethernet by replacing with an MPO-MPO cassette
- Can be inserted in forward or reverse orientation

### Applications

- High-density
- Data Center
- Horizontal panel for server/storage cabinets
- Vertical panel chassis for switching cabinets
- Any bulk transport of LC duplex connections in a trunk cable
- 10Gbit/s Ethernet
- Fiber channel for storage area networks

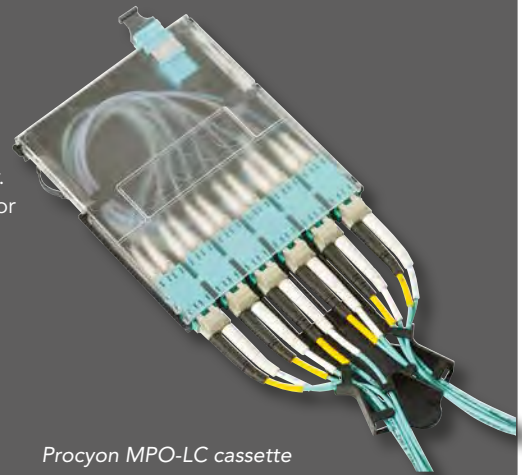

Procyon MPO-LC cassette



Procyon MPO-LC cassette loaded in Procyon Panel

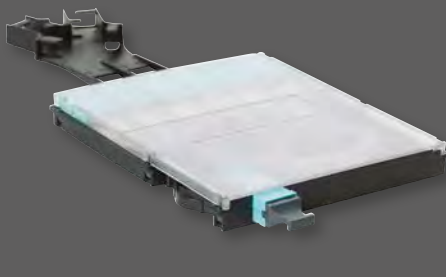

Procyon MTP-LC Cassette

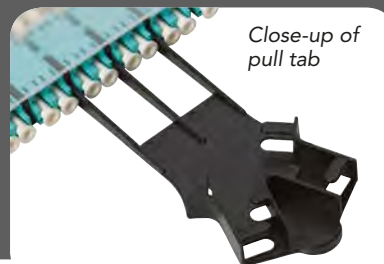

Close-up of pull tab



Close-up of bow clip mechanism

## Ordering Information

PART NUMBER	DESCRIPTION	HEIGHT	WIDTH	DEPTH
PROMT12LCSLA	Cassette assembly, DLCX6, SM, fanout, Procyon	.49"	3.88"	8.2" (4.69" cassette only)
PROMT12LCABT	Cassette assembly, DLCX6, OM3, fanout, Procyon	.49"	3.88"	8.2" (4.69" cassette only)
PROMT12LCWLS	Cassette assembly, DLCX6, 62.5, fanout, Procyon	.49"	3.88"	8.2" (4.69" cassette only)
PROMT12LCABE	Cassette assembly, OM4, fanout, Procyon	.49"	3.88"	8.2" (4.69" cassette only)
PROMT12LCAPCSLA	Cassette assembly, DLCAPCx6, SM, fanout, Procyon	.49"	3.88"	8.2" (4.69" cassette only)

 (6.4d) MT 600-Series Cassettes

### MT Plug-and-Play Cassette Modules

Designed for speed and effortless installation, OCC's fiber optic cassette modules are available with many adapter choices and offer customers a dependable, performance-driven solution. The 600-series cassettes simply snap into most OCC fiber optic rack-mount or wall-mount cabinets, and can be configured to meet most fiber optic protocols. These cassettes provide significant installation savings with no field terminations required. Simply plug-and-play!

- Available in 6-, 12-, and even 24-port adapters
- Easily field installable with snap-in pushpin design
- Fits into any OCC rack or wall-mount cabinet
- Available in 50, 62.5 or 8.3 $\mu$ m for either multimode or single-mode applications
- Both 6- and 12-port modules are available with Duplex ST, SC, and LC adapters
- 24-port modules are available with new Quad LC adapters
- Cassette modules are factory terminated and 100% tested for guaranteed performance
- Standard configuration has male MT (with pins) installed



### MPO Cassette Modules

MPO GENDER	FIBER COUNT	CONNECTOR	FIBER TYPE
<b>MTCF</b> = Female	<b>6</b>	<b>ST, SC or LC</b>	<b>5</b> = 50 $\mu$ m OM2 ALS/ALX
<b>MTCM</b> = Male	<b>12</b>	<b>ST, SC or LC</b>	<b>5G</b> = 50 $\mu$ m OM3 ALT
	<b>24*</b>	<b>LC only</b>	<b>5Q</b> = 50 $\mu$ m OM4 ALE
			<b>6</b> = 62.5 $\mu$ m OM1 WLS
			<b>8</b> = Single-mode SLA

\*24-Port cassette in LC only. (2 x 12 fiber MT Connectors.)  
Note: See Ultra-Fox fiber performance chart, pg. 332.

**Example:** MTCF6SC8 = Female MPO cassette, 6 fiber, SC connector, single-mode



## (6.4e) RTC1UB Enclosures

### Pre-configured RTC1UB Enclosures

OCC's RTC series fiber optic cabinets offer a quick solution for easy high-density connectivity. These completely pre-terminated enclosures simplify plug-and-play installations. The RTC rack-mount cabinets are a versatile and flexible option for fiber optic structured cabling systems.

- Constructed of 16-gauge steel with a black powder-coat finish
- High-density patch and splice in a 1RU rack space
- Left and right rear cable entry
- Removable top access panel
- Cable management hoops included
- Pigtailed and trays are not included, but may be ordered pre-terminated for plug-and-play operability



RTC1UB-48DLC

### Pre-configured RTC1UB Enclosures

PART NUMBER	DESCRIPTION
RTC1UB-24SC	Rack-mount cabinet, 24-port, 1RU, SC, simplex, SM/MM, black
RTC1UB-24SCMM	Rack-mount cabinet, 24-port, 1RU, SC, simplex, MM, black
RTC1UB-24SCSM	Rack-mount cabinet, 24-port, 1RU, SC, simplex, SM, black
RTC1UB-48DLC	Rack-mount cabinet, 48-port, 1RU, LC, duplex, SM/MM, black
RTC1UB-48DLCMM	Rack-mount cabinet, 48-port, 1RU, LC, duplex, MM, black
RTC1UB-48DLCSM	Rack-mount cabinet, 48-port, 1RU, LC, duplex, SM, black
RTC1UB-96QLC/MT	Rack-mount cabinet, 96-port, 1RU, LC, quad, SM/MM to MT, black
RTC1UB-96MMQLC/MT	Rack-mount cabinet, 96-port, 1RU, LC, quad, MM to MT, black
RTC1UB-96SMQLC/MT	Rack-mount cabinet, 96-port, 1RU, LC, quad, SM to MT, black



RTC1UB-24SCSM



RTC1UB-96QLCMM



## (6.4f) Loaded Enclosures

## Pre-Loaded and Pre-Terminated Fiber Enclosures

OCC strives to provide easy solutions for any structured cabling challenge. To alleviate the need for complicated fiber optic installations, OCC offers pre-terminated and pre-loaded fiber optic enclosures that minimize down time during the installation process and reduce labor costs. Every OCC pre-terminated enclosure comes complete with testing information for 100% guaranteed performance.

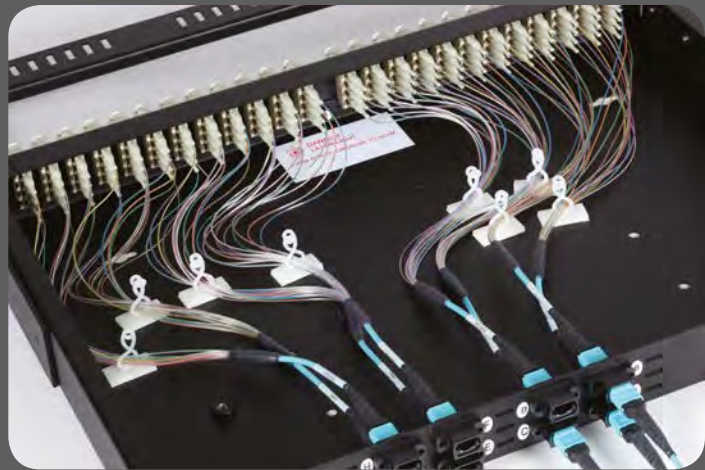

## What to Know When Ordering an OCC Pre-Terminated Enclosure

- **What type of fiber optic enclosure does your application require?**

Any OCC rack mount or wall mount fiber optic enclosure can be pre-terminated. OCC fiber optic enclosures come in a variety of styles, including:

- 1, 2 and 4RU rack mount options – see pg. 216–220
- Wall mount versions – see pg. 227
- Zone distribution – see pg. 229
- Harsh environment and industrial style – see Section 6.5a pg. 251–254

- **What type of adapters do I want to use?**

OCC offers a multitude of adapter plates in various connector types, including ST, SC, LC, FC, MT-RJ and other specialty plates. Available in 6-, 8-, 12- and 24-port options, all OCC adapter plates can be configured into any of our fiber optic enclosures. For higher density options, OCC offers HD adapter plates that can be configured with our RTC-HD and RTS-HD enclosures. See Section 6.11 Fiber Optic Adapter Plates, pg. 230–234.

- **Do you require pigtail assemblies?**

OCC's factory-terminated and tested pigtail assemblies can be provided in your pre-terminated enclosure to any specified length. Available in single-mode and multimode, OCC pigtails may be ordered in 6- or 12- bundle options and can be provisioned in a variety of industry standard connector types. See pg. 241.

- **What size splice tray kit do you require?**

OCC splice tray kits are available in a variety of sizes. Simply determine how many fibers you will need for your enclosure and we can provide the right splice tray kit to accommodate your needs. For more information about OCC's splice tray kits, see R-Series, pg. 225 or W-Series Splice Kits, pg. 228.

OCC is committed to making pre-terminated fiber optic enclosures that can be customized for your particular application. For help with configuring a pre-terminated or loaded fiber optic enclosure, please contact OCC and we will be happy to walk you through the process to find the best solution for your need.

## (6.5a) DIN-RAIL System Enclosures

### Overview

OCC's line of DIN Rail fiber optic and copper enclosures offers a rugged and versatile product line ideal for secure terminations within industrial settings. Using OCC's 600-series adapter plates, the DTC product family is based on a proven design that offers versatility and ease of installation. The enclosures can accommodate one or two OCC adapter plates and include a splice block for fusion splicing up to 12 fibers. Velcro cable ties for managing proper cable bend radius are also included. The DIN Rail enclosure features a fixed outer housing and a sliding inner housing with a hinged door that provides access to the terminated cable. A capture screw secures the inner housing and can be removed in order to detach the inner housing completely from the enclosure. Upgrades or modifications to the existing network structure can be made as easily as changing an adapter plate.

The DIN Rail enclosures are manufactured with a robust all-metal construction that protects the cable terminations in even the most adverse environmental conditions. Its compact size allows for minimum space requirements when installed in control cabinets. And most importantly, this uncomplicated family of enclosures for industrial communications fits perfectly with the entire line of fiber optic connectivity components and cable from OCC for a complete solution.

### Features & Benefits

- Accommodates both copper (shielded or unshielded) and fiber connectivity
- Compact size for limited space requirements
- Quick snap-on installation onto any standard 35mm DIN rail
- Sliding inner housing with hinged door and capture screw simplifies installations
- All-metal construction ensures durable and reliable terminations
- Interior cable management for proper bend radius requirements
- Options for cable entry and exit grommets or glands
  - Grommet hole size 1" diameter
  - Cable gland can accommodate 0.250–0.485" cable OD
- Grounding screws included for equipment protection
- Can be kitted, pre-loaded or factory pre-terminated



### Applications

- Industrial Automation
- Transportation
- Oil & Gas
- Power Generation and Transmission
- Mining



 (6.5a) DIN-RAIL System Enclosures

## DIN Rail Enclosures

PART NUMBER	DESCRIPTION
DTC1AP	DIN Rail Enclosure, accommodates 1 adapter plate, cable entry grommet, black, empty
DTC2AP	DIN Rail Enclosure, accommodates 2 adapter plates, cable entry grommet, black, empty
DTC1APG	DIN Rail Enclosure, accommodates 1 adapter plate, liquid tight cable gland, black, empty
DTC2APG	DIN Rail Enclosure, accommodates 2 adapter plates, liquid tight cable gland, black, empty

## Fiber Optic Adapter Plates

PART NUMBER	DESCRIPTION	PART NUMBER	DESCRIPTION
600	Blank adapter plate cover	6112SMDSC	12-port adapter plate, SM, dual SC
616MMSC	6-port adapter plate, MM, SC	6112MMDST	12-port adapter plate, MM, dual ST
616SMSC	6-port adapter plate, SM, SC	6112SMDST	12-port adapter plate, SM, dual ST
616MMST	6-port adapter plate, MM, ST	6112MMDLC	12-port adapter plate, MM, dual LC
616SMST	6-port adapter plate, SM, ST	6112SMDLC	12-port adapter plate, SM, dual LC
616MMDLC	6-port adapter plate, MM, dual LC	6124MMQLC	24-port adapter plate, MM, quad LC
616SMDLC	6-port adapter plate, SM, dual LC	6124SMQLC	24-port adapter plate, SM, quad LC
6112MMDSC	12-port adapter plate, MM, dual SC		

## Copper Adapter Plates

PART NUMBER	DESCRIPTION	PART NUMBER	DESCRIPTION
605AKX	5-port unloaded adapter plate for KMJ jacks	604AX	4-port unloaded adapter plate for UMJ jacks
K6Axx	Category 6A KMJ jack	U6Axx	Category 6A UMJ jack
K6AS	Category 6A shielded KMJ jack	UMJA6xx	Category 6 UMJ jack
KMJA6xx	Category 6 KMJ jack	UMJA5Exx	Category 5e UMJ jack
KMJA602S	Category 6 shielded KMJ jack	BE08Sxx	Shuttered bezel for UMJ jacks
KMJA5Exx	Category 5e KMJ jack		
KMJA5E02S	Category 5e shielded KMJ jack		

Replace "xx" with color code: 00=Electrical ivory, 01=Office white, 02=Black, 03=Red, 04=Green, 05=Blue, 06=Data Gray, 08=Orange, 09=Yellow, 10=Purple, 11=Brown, 12=Bright white.



## (6.5b) NEMA 3 Enclosures

### NEMA 3 Enclosures

OCC's NEMA 3 Wall-mount Enclosures offer the same modular features of the WTC series with the added outdoor durability for outside plant functionality. The NEMA 3 series, like all OCC wall-mount cabinets, can be ordered empty or can be easily customized to fit any exact specification. Ideal for smaller OSP and inside premise applications, the OCO6N and OCO12N are a perfect fit with the additional benefit of being NEMA Type 3 compliant.

- Accommodates any OCC snap-in adapter plate or cassette module
- Lockable clasp ideal for any padlock
- Fiber storage hoops designed to maintain orderly fiber management included
- Port identification sheets are included
- Mounting hardware included



### Outside Wall-Mount Cabinets (Empty)

PART NUMBER	ADAPTER PLATES	SPLICE CAPACITY	SPLICE TRAY/KIT	BOX DIMENSIONS (H x W x D)
OCO6N	1	–	–	10.3" x 7.7" x 3.1"
OCO6NS	1	6	Splice Block	10.3" x 7.7" x 3.1"
OCO12N	2	–	–	10.3" x 7.7" x 3.1"
OCO12NS	2	12	Splice Block	10.3" x 7.7" x 3.1"

**Note:** Port capacity based on standard 6-port adapter plates. Higher density may be achieved with 8-, 12-, and 24-port adapter plates.

### OCO6N Accessories

PART NUMBER	DESCRIPTION
10801301	.75" conduit adapter for OCO6N
10801201	1" conduit adapter for OCO6N





## (6.5c) NEMA 4X Enclosures

### NEMA 4X Enclosures

For indoor or outdoor applications where protection of components from dirt, dust, oil, or water is mandatory, OCC offers the NEMA 4X Fiber Optic Enclosures. These enclosures are designed to protect fiber optic networking components against environments where corrosive materials, caustic cleaners, and hazardous materials are used. Available in four sizes, the OCC NEMA 4X Enclosures are indoor/outdoor-rated cabinets for patching and/or splicing 12- to 96-fiber ports. Constructed of molded fiberglass-reinforced polyester material, these enclosures are well suited for high and low temperature environments as well.

### Features & Benefits

- Adheres to the rigorous NEMA 4X standard for indoor or outdoor use, including extreme environments
- Protects against windblown dust, rain, sleet, snow, splashing water, and hose-directed water
- Corrosion resistant
- Constructed of strong, molded fiberglass-reinforced polyester material with matching flat cover
- Gasket made of closed-cell neoprene cord encased in a continuous channel
- Continuous stainless-steel hinge
- Splice only and patch/splice boxes include splice block or splice tray(s)
- Accepts any standard OCC fiber adapter plate
- Includes tie wraps and kurl locks for cable management and security
- Pole-mounting options are available with a quick assembly and release feature
- Temperature range -40°F to 266°F



OCO12



OCO48



OCO72



OCO96



### NEMA 4X Enclosure Ordering

PART NO.	DIMENSIONS (H x W x D)	DESCRIPTION
OCO12NX	10" x 8" x 4"	NEMA 4X Enclosure, 12-port, holds 2 adapter plates
OCO12NXSB	10" x 8" x 4"	NEMA 4X Enclosure, 12-port patch/splice block
OCO12NXS	10" x 8" x 4"	NEMA 4X Enclosure, 12-fiber splice only
OCO48NX	16.5" x 14.5" x 8.1"	NEMA 4X Enclosure, patch and splice, holds 8 adapter plates
OCO48NXS	16.5" x 14.5" x 8.1"	NEMA 4X Enclosure, patch and splice, includes 1-W48S Kit (2-24 fiber splice trays, transition trays, mounting hardware, cable management, and port identification)
OCO72NX	24" x 24" x 9.8"	NEMA 4X Enclosure, 72-port, holds 12 adapter plates
OCO72NXS	24" x 24" x 9.8"	NEMA 4X Enclosure, patch and splice, includes 1-W72S Kit (3-24 fiber splice trays, transition trays, mounting hardware, cable management, and port identification)
OCO96NX	24" x 24" x 9.8"	NEMA 4X Enclosure, 96-port, holds 16 adapter plates
OCO96NXS	24" x 24" x 9.8"	NEMA 4X Enclosure, patch and splice, includes 1-W96S Kit (4-24 fiber splice trays, transition trays, mounting hardware, cable management, and port identification)

**Note:** Port capacity based on standard 6-port adapter plates. Higher density may be achieved with 8-, 12-, and 24-port adapter plates.

### Pole-Mounting Hardware Ordering

PART NO.	DESCRIPTION
OCC-PM12	Pole-mount kit for OCO12
OCC-PM48	Pole-mount kit for OCO48
OCC-PM72	Pole-mount kit for OCO72/96



## (6.5d) Fibreguard™ Enclosures

### Fibreguard Enclosure

Ideal for campus LANs, data centers and entrance facilities, the Fibreguard Enclosure from OCC is a complete and fully accessible closure solution. The Fibreguard Enclosure was engineered with the contractor in mind by providing an express cable port and an innovative end plate design with segmented sections that allow for individual access to each cable without disruption to surrounding cables. Additionally, a full line of multi-hole grommets ensure a high degree of flexibility.

Reentry is quick and requires no special tools or kits. Moreover, the Fibreguard enclosure provides a connectivity solution that was specifically designed for an ever-evolving telecommunications network.

- No special tools required
- Easy future drop cable installation
- No gas equipment cost
- Mechanical cable and closure sealing system
- Expandable split grommets
- Multi-drop ability from one port
- Wide-opening express cable ports
- Extensive size of cable ranges accepted
- Proven "O" ring sealing system from dome to end plate
- Flash testing to prove closure integrity
- Minimal cable preparation required
- Cost-effective
- Tested in accordance to Telcordia GR-771 CORE



### Fibreguard™ Enclosures

PART NUMBER	DESCRIPTION	EXPRESS PORTS	DROP PORTS	FIBER TRAYS INCLUDED	EXPRESS PORT GROMMETS INCLUDED
FG5-1S	Fibreguard 500 Series	2	2	(1) 12-fiber	A (2 pcs.)
FG5-2S	Fibreguard 500 Series	2	2	(2) 12-fiber	A (2 pcs.)
FG5-3S	Fibreguard 500 Series	2	2	(3) 12-fiber	A (2 pcs.)
FG5-4S	Fibreguard 500 Series	2	2	(4) 12-fiber	A (2 pcs.)
FG6-1S	Fibreguard 650 Series	2	3	(1) 24-fiber	A, B & C (2 each)
FG6-2S	Fibreguard 650 Series	2	3	(2) 24-fiber	A, B & C (2 each)
FG6-3S	Fibreguard 650 Series	2	3	(3) 24-fiber	A, B & C (2 each)
FG6-4S	Fibreguard 650 Series	2	3	(4) 24-fiber	A, B & C (2 each)
FG8-1S	Fibreguard 800 Series	2	5	(1) 24-fiber	A, B & C (2 each)
FG8-2S	Fibreguard 800 Series	2	5	(2) 24-fiber	A, B & C (2 each)
FG8-3S	Fibreguard 800 Series	2	5	(3) 24-fiber	A, B & C (2 each)
FG8-4S	Fibreguard 800 Series	2	5	(4) 24-fiber	A, B & C (2 each)
FG8-5S	Fibreguard 800 Series	2	5	(5) 24-fiber	A, B & C (2 each)
FG8-6S	Fibreguard 800 Series	2	5	(6) 24-fiber	A, B & C (2 each)
FG8-7S	Fibreguard 800 Series	2	5	(7) 24-fiber	A, B & C (2 each)
FG8-8S	Fibreguard 800 Series	2	5	(8) 24-fiber	A, B & C (2 each)
FG8-1S48	Fibreguard 800 Series	2	5	(1) 48-fiber	A, B & C (2 each)

 (6.5d) Fibreguard™ Enclosures

## Fibreguard Enclosure Information

CLOSURE DESIGNATION	EXPRESS PORT SIZES MM (INCHES)	DROP PORT SIZES MM (INCHES)	NO. OF DROP PORTS	CLOSURE LENGTH MM (INCHES)	CLOSURE DIAMETER MM (INCHES)	MAX. NO. OF SPLICE TRAYS	SPLICE CAPACITY PER ENCLOSURE
500 Series	2 x 10 -25 (.39 -1.00)	2 x 3 -25 (.11 -1.00)	2	515 (20-25)	130 (5)	4	48
650 Series	2 x 10 -25 (.39 -1.00)	3 x 3 -25 (.11 -1.00)	3	600 (24.5)	165 (6.5)	4	96
800 Series	2 x 10 -25 (.39 -1.00)	2 x 3 -25 (.11 -1.00)	5	700 (28.5)	203 (8.0)	8	192

**Note:** Splice capacity per enclosure based on 12-fiber tray for FG5 and 24-fiber tray for FG6 & FG8.



## Fibreguard Grommets

PART NUMBER	DESCRIPTION
FGD-1H	Includes A, B, and C grommets
FGD-2H	(1) 2-hole grommet
FGD-4H	(1) 4-hole grommet

## Fibreguard Splice Trays

PART NUMBER	DESCRIPTION
FG5003	12-fiber slide-n-lock tray, fusion splice
FGT-24S	24-fiber slide-n-lock tray, fusion splice
FGT-48S	48-fiber slide-n-lock tray, fusion splice

## Fibreguard Grommet Drop Port Combinations

CLOSURE DESIGNATION	CABLE RANGE MM (INCHES)	NUMBER OF ENTRIES
A	10-15 (0.39-0.59)	1
B	15-21 (0.59-0.82)	1
C	21-25 (0.82-1.00)	1
2H	7-12 (0.27-0.47)	2
4H	3-7 (0.11-0.27)	4



## Overview

OCC's MIL-PRF-29504/14 and /15 fiber optic termini are designed for outstanding optical performance in extreme environments. Widely regarded as the ideal fiber optic termini for harsh environments, OCC's MIL-PRF-29504/14 and /15 have an enhanced design that allows the terminus system to withstand challenging environmental and mechanical conditions without optical degradation.

## Features & Benefits

- **Multi-use termini system.** Intermateable and interchangeable with other M29504/14- and /15-style termini, OCC's M29504 termini assure conformance to MIL-PRF-29504 and MIL-PRF-28876 performance specifications to ensure compatibility and standardized termination techniques. Adapted for OCC's EZ-MATE connectors, the M29504 terminus system allows for double the fiber-count density in the same connector versus the traditional 2.5mm ferrule terminus. OCC's Pierside connectors also incorporate the M29504 termini.
- **Enhanced design for superior performance.** The OCC M29504/14 and /15 termini design features pre-radius 2.00mm zirconia ultra high-tolerance ferrules, an enhanced cable retention using serrated crimp areas and removable captivated split alignment sleeves. By utilizing the Belleville stacked spring design, the OCC M29504 termini provide a high spring force versus longitudinal displacement in mating conditions. In addition, the M29504 has standardized termination templates and OCC has reduced the use of Beryllium copper materials.
- **Multiple fiber accommodations.** OCC's M29504 is available in single-mode and multimode configurations, a short-body option, and an environmental sealing plug for unused cavities (M29504/03-4038).

## Applications

- Aerospace/Airborne
- U.S. and Foreign Navy Shipboard
- Mission Critical Combat Systems
- Mobile Tactical Shelters
- Mining
- Mobile Emergency Telecommunication Stations
- Broadcast Deployable
- Petro-Chemical
- Oil and Gas



## (6.6a) M29504/14 and M29504/15 Fiber Optic Termini – Product Specifications

## Performance Specifications – M29504/14 Pins and M29505/15 Sockets

PARAMETER	SPECIFICATION	PERFORMANCE
Operating temperature	TIA-455-5	-28°C to +65°C
Storage temperature	TIA-455-5	-40°C to +70°C
Cable pullout force	TIA-455-6	Axial tensile load for 10 min., 3.1 lbs. (14 N)
Fiber pullout force	TIA-455-6	Axial tensile load for 10min., 22 lbs. (98 N)
Thermal shock	TIA-455-71, schedule C	-55°C to +85°C
Temperature/humidity cycling	TIA-455-5	Method B
Thermal cycling	TIA-455-3	-54°C to +65°C
Temperature life	TIA-455-4	240 hrs., +110°C ±5°C
Vibration	TIA-455-11	Condition II & VII, Condition C, 30 min./axis
Physical shock	MIL-S-901	Grade A, class I
Mating durability	TIA-455-21	500+ cycles
Salt spray	TIA-455-16	Condition I, 500 hrs.
Terminus engagement and separation force	MIL-PRF-28876E, Section 4.6.4.4	Insertion removal force not to exceed 22 lbs. (98 N)
Terminus retention force	MIL-PRF-28876E, Section 4.6.4.4	Axial loads applied at a rate of 1 lb. (4.4 N) per second to 22 lbs. (98 N)

## Ordering Information – M29504/14 Pins and M29505/15 Sockets

QUALIFIED PARTS LIST PART NO.	OCC PART NUMBER	PRODUCT DESCRIPTION	FIBER SIZE
M29504/14-4131	M29504/14-4131	Pin termini	62.5/125µm
M29504/14-4141	M29504/14-4141	Pin termini	9/125µm
(see description)	TC1440CE	Pin termini (M29504/14-4131 w/crimp sleeve)	62.5/125µm
(see description)	TC1440CE	Pin termini (M29504/14-4141 w/crimp sleeve)	9/125µm
M29504/15-4171	M29504/15-4171	Socket termini	62.5/125µm
M29504/15-4181	M29504/15-4181	Socket termini	9/125µm
(see description)	TC1541CE	Socket termini (M29504/15-4171 w/crimp sleeve)	62.5/125µm
(see description)	TC1541CE	Socket termini (M29504/15-4181 w/crimp sleeve)	9/125µm
M29504/3-4038	TC0339AA	Dummy termini	N/A
(not listed)	TC1549DA	Socket w/o captivator	N/A
(not listed)	TC1546AA	Alignment sleeve, captivator bushing	N/A

Short versions available, contact OCC for ordering information. Call 1-800-622-7711 and ask for a Sales Representative. We're ready to assist you.

## Ordering Information – Crimp Sleeves

PART NUMBER	PRODUCT DESCRIPTION
PM83522/16-05-99B	Crimp sleeve, 2.4mm cable jacket O.D.

## (6.6b) Single Terminus (ST) Connectors



### Applications

- Navy Shipboard Systems
- Army and Marine Corp TAC COM
- Pierside/Ship-to-Shore Communications
- Disaster Recovery Emergency Communications
- Commercial and Military Antennas and Radars
- Mobile Tactical Shelters
- Mobile or Remote Broadcast Harsh Environments
- Oil and Gas Industries

### Overview

OCC's ruggedized ST connector and ST adapter products represent one of the best single-fiber connection systems available to industries where the ability to withstand extreme temperature change, shock, vibration, or corrosion is required. We offer both commercial-off-the-shelf (COTS) ST's for harsh environment applications and the fully qualified, Military ST (MIL) that meets or exceeds 100% of the military specification MIL-DTL-83522E.

### Features & Benefits

- Nickel-plated brass or stainless steel options are available
- Available to support single-mode and multimode fibers
- Accommodate fiber cables with outer jackets from 2.0mm to 3.0mm outer diameters
- The locking version features washers that prevent inadvertent optical disconnect due to stress on the cable, and are more resistant to cable pull force or repeated shock and/or vibration
- Up to 50 lbs. of pull strength protection is readily achievable using standard termination techniques
- A convenient screw-on boot feature eliminates the need for a cumbersome boot tool
- The MIL ST features a higher spring force that passes Navy High Shock (explosive) requirements
- A slightly lower spring force allows OCC's COTS ST connectors to provide the same optical performance as the MIL ST in standard shock and vibration while also allowing successful coupling with composite adapters and devices
- OCC's ST's feature a closed entry design which provides both easier mating when new and retains its mating profile for easier mating over repeated in-field mating cycles
- Ability to inter-mate with ST connectors in the field



## (6.6b) Single Terminus (ST) Connectors – Features and Benefits



ST Locking

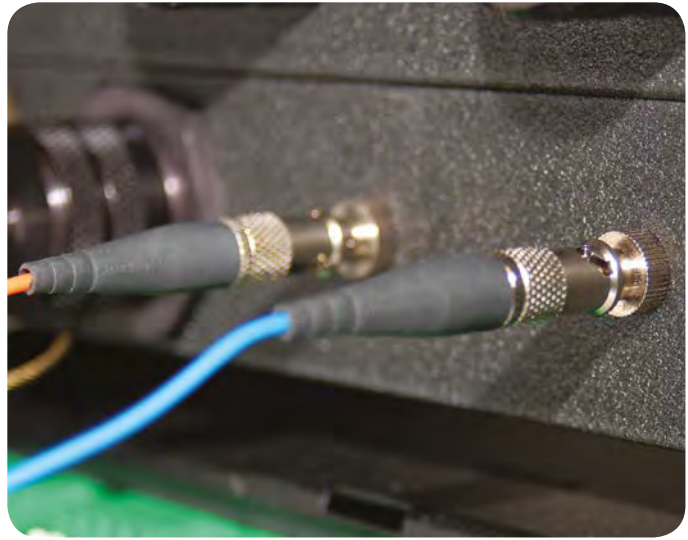

ST Mated

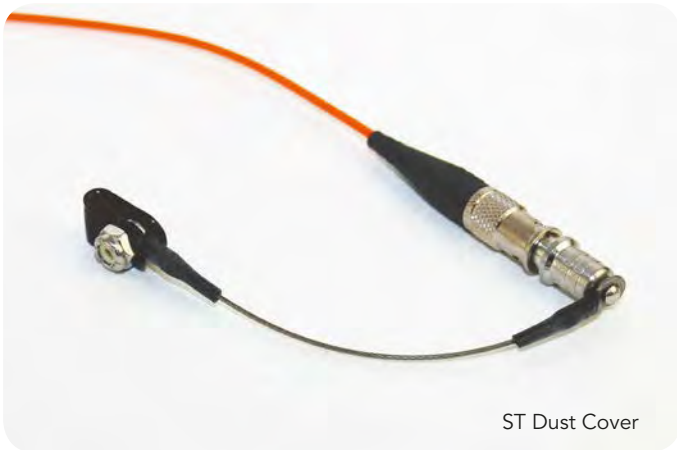

ST Dust Cover



Adapter Dust Cover



## (6.6b) Single Terminus (ST) Connectors – Performance Specifications



### Performance Specifications

PARAMETER	SPECIFICATION	PERFORMANCE
Insertion loss (multimode)	MIL-STD-1678-2 Measurement 2101	0.35dB typical, 0.75dB max.
Insertion loss (single-mode)	MIL-STD-1678-2 Measurement 2101	0.40dB typical, 0.75dB max.
Return loss (single-mode)	MIL-STD-1678-2 Measurement 2105	-50dB typical, -40dB max.
Weight	Nonterminated	< 20 GR.
Operational temperature	TIA-455-5	-46°C to +85°C
Storage temperature	TIA-455-5	-62°C to +85°C
Tensile loading <sup>1</sup>	TIA-455-6	10 min, 2.1 lbs. (230N)
Flex life	TIA-455-1	2000 cycles each at 23°C ± 5°C
Twist	TIA-455-36	1000 cycles, ±90° twist from axis
Mating durability	TIA-455-21	500 cycles
Impact	TIA-455-2	Method B, 8 drops
Vibration	TIA-455-11	Measurement 3201 of MIL-STD-1678-3
Mechanical shock	MIL-S-901	Grade A Class 1, 3 blows, per axis
Thermal shock	TIA-455-71	Test Schedule 2, -62°C to +85°C
Temperature humidity cycling	TIA-455-5	Method B
Temperature cycling	MIL-DTL-98522 Section 4.8.2	92 hours
Life aging	TIA-455-5	240 hrs., 110°C ± 5°C
Sand and dust	MIL-STD-202	Method 110, no rotation of DUT
Salt spray	TIA-455-16	MIL-STD-1678-3, measurement 3402, 96 hrs.
Flammability	ECA EIA-364-81	Exposed to a .75" (19mm) flame @ 10 sec.
Fungus resistance	TIA-455-56	Measurement 3401 of MIL-STD-1678-3



## (6.6b) Single Terminus (ST) Connectors – Ordering Information

### Nickel-Plated Brass Products

PART NUMBER	PRODUCT DESCRIPTION
M83522/16-DNX-B	MIL-ST, screw-on boot, nonlocking, multimode, nickel-plated brass
M83522/16-DNY-B	MIL-ST, screw-on boot, nonlocking, single-mode, nickel-plated brass
M83522/16-ANX-B	MIL-ST, screw-on boot, locking, multimode, nickel-plated brass
M83522/16-ANY-B	MIL-ST, screw-on boot, locking, single-mode, nickel-plated brass
M83522/16-EN	MIL-ST, dust cap
M83522/17-NY-B	MIL-ST adapter, multi- or single-mode, nickel-plated brass
SVST6011AL	COTS-ST, screw-on boot, nonlocking, multimode, nickel-plated brass
SVST6021AL	COTS-ST, screw-on boot, nonlocking, single-mode, nickel-plated brass
SVST5011AL	COTS-ST, screw-on boot, locking, multimode, nickel-plated brass
SVST5021AL	COTS-ST, screw-on boot, locking, single-mode, nickel-plated brass
SVSTB21A0	COTS-ST adapter, ceramic split sleeve, nickel-plated brass

### Stainless Steel Products

PART NUMBER	PRODUCT DESCRIPTION
M83522/16-DNX-S	MIL-ST, screw-on boot, nonlocking, multimode, stainless steel
M83522/16-DNY-S	MIL-ST, screw-on boot, nonlocking, single-mode, stainless steel
M83522/17-NY-S	MIL-ST adapter, multi- or single-mode, stainless steel
SVST6012AL	COTS-ST, screw-on boot, multimode, stainless steel
SVST6022AL	COTS-ST, screw-on boot, single-mode, stainless steel
SVST5012AL	COTS-ST, screw-on boot, locking, multimode, stainless steel
SVST5022AL	COTS-ST, screw-on boot, locking, single-mode, stainless steel
SVSTB22A0	COTS-ST adapter, ceramic split sleeve, stainless steel

### Accessories

PART NUMBER	PRODUCT DESCRIPTION
SVSTP21A0	Metal ST dust cover with lanyard, nickel-plated brass
SVSTP22A0	Metal ST dust cover with lanyard, stainless steel
SVSTQ21A0	Metal ST adapter dust cover with lanyard, nickel-plated brass
SVSTQ22A0	Metal ST adapter dust cover with lanyard, stainless steel
SVSTK000AV-KIT	Accommodates 2.5mm to 3.0 cable O.D.
PM83522/16-22	Accommodates 1.8mm to 2.5mm cable O.D.
PC83522/16-22	Accommodates 2.5mm cable O.D.
PC83522/16-20-S	Accommodates 3.0mm cable O.D.

## (6.6c) L-JACK™ Connectors



### Applications

- CATV, LAN, WAN, and PONS
- Telecommunications
- Remote Radio Heads (RRH)
- Data Center and Processing Networks
- Fiber-to-the-X (FTTC, FTTH, FTTD)
- Deployable Mobile Systems

### Overview

OCC introduces L-JACK™, a robust fiber optic duplex LC connector that couples the small form factor of traditional LCs with the known ruggedness of OCC harsh environment connectors. OCC's L-JACK connector is designed for environmentally challenging situations and offers easy installation with proven optical performance. Available in a broad range of configuration possibilities, the L-JACK is ideal for installations in extreme mobile environments, industrial applications, and any install that requires excessive fiber optic protection.

### Features & Benefits

Conventional fiber optic connectors were never intended for, or able to withstand, the rough handling of deployable and harsh applications. With the OCC L-JACK fiber optic connector, users can expect:

- **Unsurpassed ruggedized connector design.** OCC's L-JACK is manufactured with optimum metal materials that can withstand wide temperature ranges and provide extreme impact resistance, unlike the competition's polymer versions. The L-JACK's robust design is ideal for almost any harsh environment application where survivability is a factor. Multiple plating options complement the resilient nature of this connector to reinforce its mechanical performance.
- **Superior optical performance.** Compliant with IEC 61540-20, Telecordia GR-326, and TIA-604-10-A standards, the L-JACK connector accommodates standard LC and is available in multimode, single-mode and single-mode APC polish. The threaded coupling ensures proper fiber alignment and reinforces positive mating of the LC connector to the receptacle.
- **IP-68 environmental sealing.** OCC's L-JACK prevents dirt and moisture from deterring optical connections and protects the duplex LC connector from harsh environments where mud and water are present.
- **Specialized strain relief for intense tensile loading.** When terminated with OCC's Distribution or Breakout style cables, the L-JACK backshell enables up to 400 pounds of pull strength, allowing the fiber cable to withstand intense tensile loading through difficult hauls.
- **Variety of configurations to fit any application need.** Once terminated, the L-JACK plug with backshell is then used to interconnect with a variety of L-JACK receptacles, including flange-mount, jam-nut and D38999 jam-nut form receptacles.

While there are many similar types of connectors on the market, only the OCC L-JACK can bring proven durability and performance to deployable and harsh environment communications. Ideal for quick equipment connections, the L-JACK fiber optic connector is a logical choice for the most reliable communication networks.

 (6.6c) L-JACK™ Connectors – Features and Benefits



L-JACK receptacles are designed to accommodate standard LC/UPC and LC/APC duplex jumpers that have been manufactured in accordance with IEC-61540-20, Telecordia GR-326 and TIA-604-10-A connector standards.



All L-JACK receptacles and plugs provide an IP-68 compliant seal and pass IEC-60529 standards for water submersion and dust testing.



Specialized strain relief supports 400 lbs. of tension strength and provides superior cable performance compared to commercial options when utilized with OCC Distribution or Breakout style cables.



L-JACK in-line receptacles provide the ability to “daisy-chain” duplex assemblies.



L-JACK offers a variety of plug and receptacle options including flange-mount, and jam-nut options.



L-JACK can be ordered as a component or as factory terminated cable assemblies provisioned with L-JACK plugs and receptacles or other OCC connector options. Contact OCC for additional ordering information. Call 1-800-622-7711 and ask for a Sales Representative. We're ready to assist you.

## (6.6c) L-JACK™ Connectors – Performance Specifications



### Performance Specifications

PARAMETER	SPECIFICATION	PERFORMANCE
Insertion loss (IL) (UPC)	TIA-455-171	0.25dB - typical, 0.50dB - max.
Return loss (RL) (UPC)	TIA-455-107	50dB minimum
Operational temperature	TIA-455-5	-40°C to +85°C
Storage temperature	TIA-455-5	-40°C to +85°C
Temperature humidity cycling	TIA-455-5	-40°C to +71°C at 95%RH, 240 hrs.
Dust test	IEC 60529 IP68	8 hrs. dust exposure with 20 mbar
Water submersion	IEC 60529 IP68	48 hrs immersion /1 meter water
Cable retention <sup>1</sup>	TIA-455-6	400 lbs. for 10 minutes
Mating durability	TIA-455-21	500 cycles
Impact	TIA-455-2	8 drops, 2.4 meters
Vibration	TIA-455-11	10-55Hz, 2 hrs./axis, 3 axis
Mechanical shock	TIA-455-14	Condition C, 5 shocks/axis
Crush	TIA-455-26	450 lbs.
Corrosion resistance	TIA-364-83	500 hrs. (all plating options)

**NOTE:**

<sup>1</sup> Application of OCC D-002CSLS5KM during test



L-JACK internal jam-nut receptacle



L-JACK in-line receptacle

## (6.6c) L-JACK™ Connectors – Ordering Information

### L-JACK Plug, In-Line Receptacle Options

PART NUMBER	PRODUCT DESCRIPTION
RLRB021LP01A	Plug, dust cap, short body, (2) LCs, MM, beige
RLRB021LP02B	Plug, dust cap, short body, (2) LCs, SM, blue
RLRB121LP02E	Plug, dust cap, short body, (2) LCs, SM/APC, green
RLRM121LC01A	In-line receptacle, dust cap, short body, (2) LCs, MM, beige
RLRM121LC02B	In-line receptacle, dust cap, short body, (2) LCs, SM, blue
RLRM121LC02E	In-line receptacle, dust cap, short body, (2) LCs, SM/APC, green

### L-JACK Receptacle Options

PART NUMBER	PRODUCT DESCRIPTION
RLRD121LC01A	Receptacle, flange-mount, dust cap, MM, beige
RLRD121LC01B	Receptacle, flange-mount, dust cap, SM, blue
RLRD121LC01E	Receptacle, flange-mount, dust cap, SM, green
RLRK121LC01A	Receptacle, jam-nut, external, dust cap, MM, beige
RLRK121LC01B	Receptacle, jam-nut, external, dust cap, SM, blue
RLRK121LC01E	Receptacle, jam-nut, external, dust cap, SM, green
RLRJ121LC01A	Receptacle, jam-nut, fits D38999/26 size 19, dust cap, MM, beige
RLRJ121LC01B	Receptacle, jam-nut, fits D38999/26 size 19, dust cap, SM, blue
RLRJ121LC01E	Receptacle, jam-nut, fits D38999/26 size 19, dust cap, SM, green

**NOTE:**

Black Anodized is standard. Other plating options such as Nickel Teflon are available. Consult your local OCC representative for more information.

### Product Options for a Complete L-JACK Solution



Standard LC Patchcord



NEMA 4X Enclosures

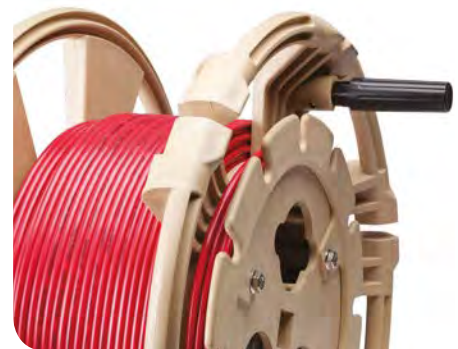

Deployable Reels





## Applications

- Mobile Emergency Telecommunications Stations
- Mobile Tactical Shelters
- U.S. Army, Navy, and Marine Corps Military Tactical Deployments
- Deployable Trailers for Federal Emergency Management Agency
- Homeland Security Applications
- Mining
- Oil & Gas

## Overview

OCC's COTS-83526 connector is based on the MIL-PRF-83526 performance specification, the successful backbone for military tactical fiber optics. It features a field-convertible hermaphroditic plug design, with integrated strain-relief and tactical cable retention system. COTS 83526 is available in two shell sizes with 2 to 12 channel options. This family of tactical fiber optic connectors also features specifications for a wide variety of receptacles, including internal jam nut, external jam nut, flange-mount, and strain-relief configurations.

## Features & Benefits

- **Superior performance with protection from the elements.** At the heart of this robust family of tactical hermaphroditic fiber optic connectors is the environmentally sealed terminus system, which maintains superior optical performance while resisting dust, moisture, or even liquid submersion, meeting IP-68 requirements.
- **Easy, quick connections.** The field-convertible plug allows the plug to be converted to an in-line receptacle or back to a plug within seconds. This enables plug-to-plug assemblies to be connected end-to-end without regard for which end starts out as male or female. The internal "push-pull" system allows operators to terminate and assemble COTS-83526 plug and receptacles with ease. Unlike competitive products that require O-rings and snap clips, the COTS-83526 design essentially decreases the time and effort required for assembly.
- **Smart construction for ease of use.** The environmentally sealed terminus system allows proper alignment of the 2.5mm ceramic ferrules. This terminus is corrosive-resistant, genderless (can be either pin or socket), and easily inserts at 90° angles to the terminus retainer. In addition, the insert cap having captivated ceramic alignment sleeves prevents them from becoming misplaced during routine maintenance.

**(6.6d) COTS-83526 Connectors – Features and Benefits**

4 CH COTS-83526 plug mated with competitors  
4 CH TFOCA® II plug.



Interoperable, intermateable, and backward compatible with most MIL-PRF-83526 4-channel interface specifications.



Field convertible hermaphroditic plug design allows connector to be provisioned for either female or male connectivity.



2.5mm split sleeve retained  
in 12 CH insert cap

Captivated ceramic split sleeves prevent them from becoming misplaced during routine maintenance.



Field convertible hermaphroditic dust cap design can be quickly converted to allow mating with other dust caps in a plug-to-plug or plug-to-receptacle configuration. This keeps dust caps clean and readily available.



Enhanced Kevlar® retention system supports harsh environment deployment without degradation of the optical signal.



Internal "push-pull" system allows operators to terminate COTS-83526 plugs and receptacles easily.



TC1640CA termini

Sealed termini system provides environmental resistance and meets IP-68 requirements.



Dry film thread lubrication system extends life of mating threads by self-lubricating through repeated cycles.



The COTS-83526 family of connectors comes in 2 shell sizes and features a diverse set of receptacle configurations.



COTS-83526 removal tool allows for easy installation and removal of terminus into the connector, should it ever be needed.

Kevlar is a registered trademark of DuPont.

## (6.6d) COTS-83526 Connectors – Standard Configurations (options and modifications available)



**CCTA10B31Cx** | COTS-83526 4 CH hermaphroditic plug and dust cap



**CCTA10F31Cx** | COTS-83526 12 CH hermaphroditic plug and dust cap



**CCTB21B31C** | COTS-83526 4 CH internal jam nut receptacle with female dust cap, EMI



**CCTB21F31C** | COTS-83526 12 CH internal jam nut receptacle and female dust cap, EMI



**CCTD21B31C** | COTS-83526 4 CH flange-mount receptacle and female dust cap, EMI



**CCTD21F31C** | COTS-83526 12 CH flange-mount receptacle and female dust cap, EMI



**CCTC21B31C** | COTS-83526 4 CH external jam nut receptacle and female dust cap, EMI



**CCTC21F31C** | COTS-83526 12 CH external jam nut receptacle and female dust cap, EMI



**CCTE21B31Cx** | COTS-83526 4 CH internal jam nut strain-relief receptacle and female dust cap, EMI



**CCTE21F31Cx** | COTS-83526 12 CH internal jam nut strain-relief receptacle and female dust cap, EMI



**CCTG21B31Cx** | COTS-83526 4 CH flange-mount strain-relief receptacle and female dust cap, EMI



**CCTG21F31Cx** | COTS-83526 12 CH flange-mount strain-relief receptacle and female dust cap, EMI



**CCTF21B31Cx** | COTS-83526 4 CH external jam nut strain-relief receptacle and female dust cap, EMI



**CCTF21F31Cx** | COTS-83526 12 CH external jam nut strain-relief receptacle and female dust cap, EMI



**CBCC12B18E3** | EZ-MATE 4 CH back-to-back jam nut receptacle



## (6.6d) COTS-83526 Connectors – Performance Specifications

## Performance Specifications

PARAMETER	SPECIFICATION	PERFORMANCE
Insertion loss (multimode)	TIA-455-171	0.50dB – typical, 0.75dB – max.
Insertion loss (single-mode)	TIA-455-171	0.40dB – typical, 0.75dB – max.
Back Reflection (single-mode, UPC polish)	TIA-455-107	-50dB – typical, -40dB – max.
Operating temperature	TIA-455-5	-54°C to +71°C
Storage temperature	TIA-455-5	-57°C to +85°C
Mating durability	TIA-455-21	2000 cycles
Impact	TIA-455-2	Method B, omit wall pipe
Twist	TIA-455-36	±90° rotation, one cycle/5 sec., 1000 cycles
Cable sealing flex	TIA-455-1	Procedure I
Cable retention	TIA-455-6	400 lbs. min.
Crush resistance	TIA-455-26	450 lbs.
Temperature life	TIA-455-4	250 hrs., 85° ± 2°C
Thermal shock	TIA-455-71	Condition B-0 except 10 cycles, @ 85°C and -62°C
Physical shock	TIA-455-14	Condition C, 5 shocks/axis
Vibration	TIA-455-11	Condition III & VI, Condition C for 1.5 hrs.
Humidity	TIA-455-5	Method B
Salt spray <sup>1</sup>	TIA-455-16	Condition I
Fluid immersion	TIA-455-12	24 hrs. per fluid
Water submersion	TIA-455-98	Method A, Procedure 1, 1m for 24 hrs.; bulkhead mounted in watertight cube
Flammability	EIA-364-8	Burning and after-flow extinguishing, ≤ 3 sec.
Mud test <sup>2</sup>	M83526, paragraph 4.8	5 min. immersion, 10 cycles
Electromagnetic effects <sup>1,3</sup>	IEEE-299	20kHz, 150kHz, 14MHz, 400MHz, 600MHz, 1GHz, 2GHz, 8GHz, 10GHz, vert. and horz., <-60dB

## NOTES

<sup>1</sup> Applies to ZINi plating only

<sup>2</sup> Sand/topsoil substituted for Potter's Clay

<sup>3</sup> 12 CH receptacle requires application of SRR configurations



## (6.6d) COTS-83526 Connectors – Ordering Information



**COTS-83526 Connector: CCT**    **A**    **1**    **0**    **B**    **B**    **3**    **C**    **B**

<p><b>CONFIGURATION TYPE</b></p> <p><b>A</b> Hermaphroditic plug  <b>B</b> Receptacle, internal jam nut  <b>C</b> Receptacle, external jam nut  <b>D</b> Receptacle, flange-mount  <b>E</b> Receptacle, internal jam nut, with strain relief  <b>F</b> Receptacle, external jam nut, with strain relief  <b>G</b> Receptacle, flange-mount with strain relief  <b>H</b> Accessory only</p>	<p><b>DUST CAP</b></p> <p><b>0</b> None provided  <b>1</b> Hermaphroditic (plug only)  <b>2</b> Female (receptacle only)  <b>3</b> Male (plug only)</p>	<p><b>EMI SHIELDING</b></p> <p><b>0</b> Plug or accessory only  <b>1</b> Yes (receptacle only)  <b>2</b> No (receptacle only)</p>	<p><b>CHANNEL COUNT</b></p> <p><b>B</b> 2–4 channel  <b>F</b> 6–12 channels</p>	<p><b>CABLE O.D.<sup>1</sup></b>                  Blank – N/A  <b>A</b> 0.190" – 0.239"  <b>B</b> 0.240" – 0.279"  <b>C</b> 0.280" – 0.315"  <b>D</b> 0.316" – 0.346"  <b>E</b> 0.347" – 0.379"  <b>F</b> 0.380" – 0.423"  <b>G</b> 0.424" – 0.465"  <b>H</b> 0.466" – 0.515"<sup>2</sup>  <b>J</b> 0.516" – 0.549"<sup>2</sup>  <b>K</b> 0.550" – 0.589"<sup>2</sup></p>	<p><b>SLEEVE TYPE</b></p> <p><b>C</b> Captive split sleeve  <b>M</b> Solid sleeve</p> <p>Other options available, contact OCC for information.</p>	<p><b>KEY POSITION</b></p> <p><b>1</b> Key 1, default</p> <p>Other keying options available, contact OCC for information.</p>	<p><b>PLATING AND MATERIAL OPTIONS</b></p> <p><b>1</b> Black anodized  <b>3</b> Zinc nickel plated  <b>4</b> 303 stainless steel  <b>5</b> 316 stainless steel  <b>6</b> Naval brass  <b>9</b> Brass, half hard, 360</p> <p>Other plating options &amp; materials available. Contact OCC for information.</p>
--	---	---	---	---	--	---	---

**NOTES**

<sup>1</sup> Other cable sizes are available. Contact OCC for information.  
<sup>2</sup> Only available for shell size F.

Call 1-800-622-7711 and ask for a Sales Representative. We're ready to assist you.

## Termini for COTS-83526

PART NUMBER	CONFIGURATION	PRODUCT DESCRIPTION
TC1640DA	Termini	2.5mm, environmental-resisting, fiber optic termini, 126µm I.D.
TC1739AA	Termini	Dummy termini
PC83522/16-20-S	Crimp sleeve	Crimp sleeve, used with 3.0mm jacket
PA35395-99-017	Crimp sleeve	Crimp sleeve, used with 2.0mm jacket



## (6.6d) COTS-83526 Connectors – Ordering Information

### Terminus and Crimp Sleeve Options

- 1) Select the number of dummy termini necessary to fill a connector. For example, when planning for an 8 CH application, select four dummy termini to complete a 12 CH size connector.
- 2) Crimp sleeves are recommended for use on receptacles without strain-relief. Crimp sleeves are generally used with simplex cable for receptacle pigtails. In addition, receptacles without strain relief can accommodate up to 3.0mm simplex cable.

### EMI/Non-EMI Options

EMI-conductive O-rings and/or gaskets are typically provisioned with all COTS 83526-style receptacles, but add additional cost to each connector. Non-EMI options are available by simply ordering a receptacle with a "2" in the sixth-digit position (e.g., CCTG22B31CD) of the part number.

### Plating and Material Options

Most COTS-83526 component configurations are supplied with zinc nickel plating with olive drab coloring. For the additional plating options, the eighth-digit position of the part number (e.g., CCTG22F\_1CD) is selected for the plating/material of choice.

- |   |   |
|---|---|
| "1" Black anodized, Mil-A-8625 TYPE 2 CLASS 2             | "5" 316 stainless-steel, passivation per QQ-P-35/ASTMA967 |
| "3" Zinc nickel plating, SAE AMS 2417G                    | "6" Naval brass, C 46400 H02 half hard ASTMB 21/B21M      |
| "4" 303 stainless-steel, passivation per QQ-P-35/ASTMA967 | "9" Brass, half hard, 360                                 |





## Applications:

- Connects TFOCA and TFOCA-II® Plug Assemblies and Receptacles
- Field Testing
- Troubleshooting
- Channel Integrity Testing



TF2 4 and 12 channel loop back plugs

## Overview

OCC's TFOCA adapters and loop back connectors are the ideal solution for fiber optic connections requiring one series of connector to be attached to another. Our T1 to T2 enclosed adapters easily transition from one connector to another with complete protection for the optical fibers without cutting, rolling or storing additional cable.

Instead of requiring a custom cable assembly with connector A and B on opposite ends, OCC's adapters allow for a multitude of connections with standardized cables. Our full range of connector and adapter accessories complement TFOCA-II®, COTS M83526 and MIL-C-83526 (TFOCA) connectors.

- **Loop Back Test Plugs:** Our Loop Back Plugs are compatible with TFOCA 2CH (50/125µm), TFOCA-II 4CH and 12CH, multimode (62.5/125µm) and single-mode (9/125µm) applications. These Loop Back Plugs ensure consistent insertion loss per channel to yield accurate attenuation measurements.
- **ST Breakout Test Plugs:** OCC offers a 4CH ST to Breakout Plug adapter for field testing of TFOCA-II plugs and COTS M83526 assemblies, without the use of receptacles. The ST to Breakout Plug adapters are available in multimode (62.5/125µm) and single-mode (9/125µm) options.
- **TFOCA to TFOCA-II Adapters:** OCC's TFOCA to TFOCA-II (TF1–TF2) adapters are an ideal solution to convert TFOCA to TFOCA-II connections, or vice versa. Options for pairing S1/P1 with TFOCA male/female or pairing S2/P2 to TFOCA male/female, respectively, are available and utilize 62.5/125µm to 50/125µm fiber coupling capability to ensure the lowest attenuation possible. TF1–TF2 adapters easily transition from one connector to another and are available in both straight and 45° versions.

## Features and Benefits

- Allows use of standardized deployment cables with different equipment configurations, from legacy to today's latest technologies
- Totally enclosed and protected fibers, no cables to cut or crush
- Lanyard dust covers on both ends (as required) — protects end faces in storage
- Any combination of pin-outs from A to B. Fiber counts based on requirements
- Internal fiber loop-backs available to allow test circuits
- Compact size saves space for storage and shipment costs
- No cables to coil up and store
- Can easily be enclosed within most equipment transit cases

TFOCA II is a registered trademark of Amphenol Fiber Systems International.

## (6.6e) COTS-83526 Adapters and Loopbacks

### Ordering Information

OCC offers a variety of configurations for Loop-Back connectors and TFOCA adapters. Contact OCC for ordering information on all the different options available. Call 1-800-622-7711 and ask for a Sales Representative. We're ready to assist you.



4 Channel TFOCA to discrete MIL-ST



TF1 to TF2 Adapter, Straight (C83526/99-16 Series)



TF1 to TF2 45 Degree Adapter (C83526/99-15 Series)



4 Channel TFOCA to EZ-MATE adapter.

## (6.6f) OCC Pierside Connectors



### Applications

- Ship-to-Shore Communications Umbilical Connect
- Mobile Emergency Telecommunications Stations
- Mobile Tactical Shelters
- U.S. Army, Navy, and Marine Corps Military Tactical Deployments
- Broadcast
- Oil and Gas Industries

### Overview

OCC's Pierside family of fiber optic connectors is designed to meet the stringent Pierside performance specifications (NAVSEA 737971 performance and 7379172) and is an ideal connector system for much more than ship-to-shore communications. The Pierside connector provides a genderless mating system perfect for applications requiring high performance in single-mode, multimode or composite configurations in extreme environments. In addition, this connector is an excellent choice for other applications including broadcast, mining, land tactical, control systems, and more.



CCPC22F11C  
12 CH external jam nut receptacle

### Features & Benefits

- **Easy and managable installations.** The Pierside connector provides a true hermaphroditic design, allowing this connector to mate plug-to-plug or plug-to-receptacle. This allows for flexibility and quick fiber system deployments when multiple units are daisy-chained together. As one of the only manufacturers providing a true hermaphroditic dust cap as a standard, OCC's Pierside is capable of mating without regard for male or female gender of the interfacing connector.
- **Standards compliant.** Available in single-mode, multimode or a combination of both, Pierside is compliant with the Commercial Item Description (CID) standard issued by the Naval Sea Command.
- **Comprehensive options for a variety of uses.** OCC's Pierside affords the most comprehensive complement of options available, including hermaphroditic or standard dust caps, strain-relief receptacles, 90° plugs and more. The interchangeable Detachable Socket Insert (DSI) and termini enable users to replace components as needed. Pierside is interoperable with other connectors complying to the same standard and features an hermaphroditic dust cap as a standard provision.



 (6.6f) OCC Pierside Connectors – Features and Benefits



Interoperable with other competitive connectors allowing end users more flexibility when sourcing components.



Interchangeable Detachable Socket Insert (DSI) and terminations enables end users to purchase replacement components to be used with OCC or other manufacturer's products.



OCC offers replacement dust caps kits in male, female, or hermaphroditic options.



Enhanced Kevlar® retention system supports tactical or mobile deployment without degradation of the optical signal.



Field-convertible hermaphroditic design easily allows Pierside connectors to be mated regardless of gender and offers effortless plug-to-plug assembly.

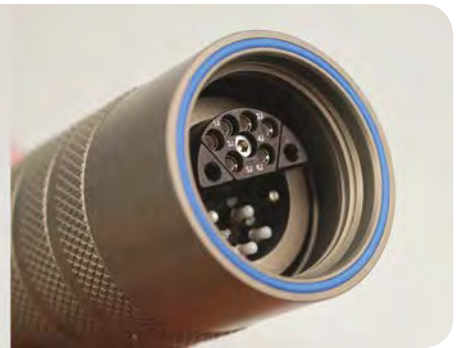

A complete complement of connector options, including replacement dust caps, strain-relief receptacles, and 90° plugs are available.



Full array of replacement components designed to meet the requirements of NAVSEA 7379171 and 7379172.

Kevlar is a registered trademark of DuPont.

## (6.6f) OCC Pierside Connectors – Performance Specifications



### Performance Specifications

PARAMETER	SPECIFICATION	PERFORMANCE
Insertion loss (multimode)	TIA-455-171	0.30dB – typical, 0.75dB – max.
Insertion loss (single-mode)	TIA-455-171	0.40dB – typical, 0.75dB – max.
Back reflection (single-mode UPC polish)	TIA-455-60	-50dB – typical, -40dB – max.
Operating temperature	TIA-455-5	-54°C to +85°C
Storage temperature	TIA-455-5	-65°C to +85°C
Temperature cycling	TIA-455-3	-54°C to +85°C
Mating durability	TIA-455-21	1000 cycles min.
Impact	TIA-455-2	Method B
Twist	TIA-455-36	±90° rotation, 1 cycle/5 sec., 1000 cycles
Cable sealing flex	MIL-STD-1344, method 2017	100 cycles
Cable retention	TIA-455-6	400 lbs. min.
Crush resistance	TIA-455-26	450 lbs.
Physical shock	TIA-455-14	Condition C
Vibration	MIL-STD-1344	Method 2005.1
Temperature humidity	TIA-455-5	Method B
Fluid immersion	TIA-455-12	24 hrs. per fluid
Water pressure		25 PSI, 24 hrs.
Ozone exposure	ATSM-D-1149	100-150 PPM for 2 hrs.
Flammability	MIL-STD-1344	Method 1012
Corrosion resistance	TIA-455-16	500 hours salt spray
Thermal shock	TIA-455-71	Condition B-0 except 10 cycles, @ 85°C and -62°C



CCPA10C11CB  
6 channel hermaphroditic plug



CCPC22C11C  
6 channel external jam nut receptacle

 (6.6f) OCC Pierside Connectors – Ordering Information

Pierside Connector: CCP A 1 0 C 1 1 C B

**CONFIGURATION TYPE**

- A Hermaphroditic plug
- C Receptacle, external jam nut
- F Receptacle, external jam nut, with strain relief
- H Accessory only
- M 90 degree plug

**DUST CAP**

- 0 None provided
- 1 Hermaphroditic (plug only)
- 2 Female (receptacle only)
- 3 Male (plug only)

**EMI SHIELDING**

- 0 Plug or accessory only
- 1 Yes (receptacle only)
- 2 No (receptacle only)

**CHANNEL COUNT**

- C 6 channel
- F 12 channel

**CABLE O.D.**

- A 0.190" – 0.239"
- B 0.240" – 0.279"
- C 0.280" – 0.315"
- D 0.316" – 0.346"
- E 0.347" – 0.379"
- F 0.380" – 0.423"
- G 0.424" – 0.465"
- H 0.466" – 0.515"
- J 0.516" – 0.549"
- K 0.550" – 0.589"

**SLEEVE TYPE**

- C Captive split sleeve
- Other options available, contact OCC for information.

**KEY POSITION**

- 0 Accessory
- 1 Key 1

**M CONFIGURATION**

- A Key 1, tower position 12:00
- B Key 1, tower position 3:00
- C Key 1, tower position 6:00
- D Key 1, tower position 9:00

Other keying options available, contact OCC for information.

**PLATING AND MATERIAL OPTIONS**

- 1 Aluminum hard anodized with Teflon®

Other plating options & materials available.  
Contact OCC for information.

Teflon is a registered trademark of DuPont.

## Pierside Accessories and Termini

PART NUMBER	CONFIGURATION	PRODUCT DESCRIPTION
TC1440CA	Termini	COTS 29504/14 pin 2.0mm ceramic ferrule, 126µm I.D.
TC1549DA	Termini	COTS 29504/15 socket without captive sleeve
TC0339AA	Dummy termini	Dummy termini (fits either pin or socket)
TC1546EA	Alignment Sleeve	Replacement captivator guide bushing for DSI
PA35395-99-017	Crimp sleeve	Crimp sleeve, brass, 0.114" O.D.

## Assembly Ordering

OCC can also provide complete turn-key systems that are easy to install and guaranteed to perform. Our state-of-the-art facility can integrate any OCC Pierside connectors into any customized cable assembly specific to your application requirements. OCC can provide a complete system solution that is easily installed and gets your system up and running fast.



## (6.6g) F-LINK™ Interconnect Solution



### Applications

- Network (audio, data, or DMX) Professional Equipment
- Oil and Gas Installations
- Deployable Broadcast Systems
- Remote Monitoring Sites
- Robotic Arms and Devices
- Industrial Monitoring
- Mining Solutions

### Overview

OCC's F-LINK™ is a versatile and unique connectivity component family. Born out of the proven performance of mil-spec cylindrical components, the F-LINK interconnect system is a cost-effective solution for commercial, industrial, and military applications. F-LINK is a comprehensive family of connector components designed to solve a multitude of fiber optic applications, as well as enable the emerging trends and technological advances toward hybrid interconnection that combines fiber optic and electrical power within one connector.

### Features & Benefits

- **Designed for hybrid interconnections.** F-LINK can be provisioned for fiber optic only applications or hybrid fiber optic and electrical power connections in one connector. Female gender plugs or receptacles insulate from electrical shock while interfacial seals protect pin contacts for arcing. Any combination of fiber optic or electrical channel counts can be provisioned into plugs or receptacles.
- **Versatile configurations.** The interchangeable pin/socket insert caps allow F-LINK to be provisioned into either male or female plug or receptacle components, eliminating the need to stock multiple components. The retractable backshell system is common to both fiber optic and composite/hybrid cable systems, and eases terminations by allowing the extension and retraction of the inner cable retention system.
- **Outstanding environmental protection.** F-LINK has the proven performance of mil-spec cylindrical-style components designed for extended operation in harsh environments. Protective sealing features, along with advanced materials, enable F-LINK components to operate across a wide temperature and humidity range in high-vibration and/or corrosive environments. Four sealing surfaces, including the insert cap, insert body, plug and receptacle body and rear cable seal, provide exceptional IP-68 compliance when mated together.

F-LINK offers a wide variety of connector configurations, backshells and accessories, and is available in three shell sizes that accommodate up to 33 channels. Any combination of fiber optic or electrical channel counts can be configured into plugs or receptacles.



## (6.6g) F-LINK™ Interconnect Solution – Features and Benefits



F-LINK insert caps provide maximum provisioning flexibility. Termini cavities can be machined for pin or socket requirements.



In-line receptacle male insert cap, 4F + 2E



In-line receptacle female insert cap, 4F + 2E

F-LINK allows interchangeability of pin or socket insert caps, which can be provisioned into either plug or receptacle components.



Four sealing surfaces, including insert cap, insert body, plug and receptacle body with rear cable seal provide exceptional IP-68 compliance.



The F-LINK backshell system provides easy terminations and allows the extension and retraction of the inner cable retention system.



F-LINK can be configured for fiber optic or fiber optic and electrical contacts. Electrical contacts are based on the same proven technology used in D38999 connectors.



Cable retention system - fiber optic cable



Cable retention system - hybrid (f+e) cable

Interchangeable cable retention system supports either fiber optic cable or hybrid (fiber + electrical) cable.



F-LINK can be configured in a multitude of plug and receptacle configurations.

# HARSH ENVIRONMENT CONNECTORS



6.9

## (6.6g) F-LINK™ Interconnect Solution – Connector Configurations



SS16, plug, male w/ backshell, F/O cable



SS16, panel-mount receptacle, male



SS16, in-line receptacle, female



SS16, internal jam nut receptacle, female



SS16, panel-mount plug, female



SS16, backshell for composite cable



SS22, plug, male w/ backshell, F/O cable



SS22, internal jam nut receptacle, female



SS22, external jam nut receptacle, male



SS28, plug, female w/ backshell, F/O cable



SS28, plug, female w/ backshell, F/O cable, dust cap



SS28, panel-mount receptacle, female



## (6.6g) F-LINK™ Interconnect Solution – Performance Specifications

## Performance Specifications

PARAMETER	SPECIFICATION	PERFORMANCE
Insertion loss (multimode)	TIA-455-171	0.50dB – typical, 0.75dB – max.
Insertion loss (single-mode)	TIA-455-171	0.40dB – typical, 0.75dB – max.
Back reflection (single-mode UPC polish)	TIA-455-107	-50dB – typical, -40dB – max.
Operating temperature	TIA-455-5	-40°C to +85°C
Storage temperature	TIA-455-5	-40°C to +85°C
Mating durability	TIA-455-21	500 cycles
Impact	TIA-455-2	Method B, omit wall pipe
Twist	TIA-455-36	±90° rotation, 1 cycle/5 sec., 1000 cycles
Cable sealing flex	TIA-455-1	Procedure I
Cable retention <sup>1</sup>	TIA-455-6	400 lbs. min.
Crush resistance	TIA-455-26	450 lbs.
Temperature life	TIA-455-4	250 hrs., 85 ± 2°C
Thermal shock	TIA-455-71	Condition B-0 except 10 cycles, @ 85°C and -62°C
Physical shock	TIA-455-14	Condition C, 5 shocks/axis
Vibration	TIA-455-11	Condition III & VI, Condition C for 1.5 hrs.
Humidity	TIA-455-5	Type II
Water submersion	IP-68, IEC-60529	1m depth, 48 hours, bulkhead mounted in watertight cube
Corrosion Resistance	TIA-455-16	Condition I (applies to all plating options)

**NOTES**

<sup>1</sup> Uses military tactical cable for test purposes





## (6.6g) F-LINK™ Interconnect Solution – Ordering Information



### F-LINK Components:

H D A N NN NN B M 3 0 B

#### SHELL SIZE

- D Shell size 16 – up to 6 channels
- F Shell size 22 – up to 17 channels
- J Shell size 28 – up to 33 channels

#### CONFIGURATION TYPE<sup>1</sup>

- A Plug, male
- B Plug, female
- D Receptacle, in-line, male
- D Receptacle, in-line, female
- E Receptacle, panel-mount, male
- F Receptacle, panel-mount, female
- J Accessory only (such as backshell or dust cap)
- Q Plug, panel-mount, male
- R Plug, panel-mount, female
- S Receptacle, internal jam nut, male, without D-flat
- T Receptacle, internal jam nut, female, without D-flat
- U Receptacle, external jam nut, male
- V Receptacle, external jam nut, female

#### ELECTRICAL ARRANGEMENT<sup>2</sup>

- N Not used 1
- 6# AWG without ground
- 2 16# AWG with ground<sup>3</sup>

Other options available. Please contact OCC for ordering information.

#### ELECTRICAL CHANNEL COUNT<sup>4</sup>

- NN Not used
- 00–33 # of Electrical channels

#### FIBER CHANNEL COUNT<sup>5</sup>

- NN Not used
- 02–33 # of Fiber optic channels

#### BACKSHELL CABLE O.D.

- B 0.240" – 0.279"
- D 0.316" – 0.346"
- G 0.424" – 0.465"
- K 0.550" – 0.589"

#### ACCESSORIES

- 0 None
- 1 Plug dust cover
- 2 Receptacle dust cover
- 3 Receptacle, external jam nut, dust cover

#### BACKSHELL

- 0 None
- 3 Straight backshell, universal

#### KEY POSITION

- M Master Key (Key 1, default)
- U Universal Key

Other options available. Please contact OCC for ordering information.

#### PLATING OPTIONS<sup>6</sup>

- A Electroless nickel plated, MIL-C-26074, 3mil (±0.5mil)
- B Black anodized, MIL-A-8625 TYPE 2 CLASS 2
- D 303 stainless steel, passivation per QQ-P-35/ASTMA967
- E 316 stainless steel, passivation per QQ-P-35/ASTMA967
- G Naval brass, C46400 H02 Half Hard ASTMB 21/B21M
- H Plastic dust cap with lanyard (only)

<sup>1</sup> All plug and receptacle part numbers above are provisioned blank. This refers to an untapped cavity that can be modified (drilled or molded) to accommodate fiber optic pin, fiber optic socket, electrical pin or electrical socket.

<sup>2</sup> If no electrical contacts are necessary, select "N" for the first digit. Select "1" if no center ground pin/socket is necessary. Select "2" if ground detection (Make-Before-Contact) is required.

<sup>3</sup> Selection of option "2" will place the ground pin/socket in the center of the pin or socket insert body. This will void the use of the Insert Cap Removal tool.

<sup>4</sup> The maximum number of electrical and/or fiber optic contacts ranges from "00" to "33" (6 channels for Shell Size 16, 17 channels for Shell Size 22, and 33 for Shell Size 28). F-LINK can be used as an all electrical connector.

<sup>5</sup> Any combination of 33 fiber optic or electrical contacts/termini can be configured but the total of both the fiber optic and electrical contacts must equal the maximum number specified for the Shell Size.

<sup>6</sup> All F-LINK configurations are supplied with black anodized by default unless otherwise specified by selecting another plating or material option.

**ADDITIONAL NOTES:**

- Select the appropriate shell size to accommodate the fiber optic and/or electrical channel count.
- Most fiber optic applications require male plugs with backshells to support connectivity with female receptacles.
- Backshells are typically used with hybrid in-line receptacles and plugs.
- Most hybrid applications require the source of electricity to be protected from hazardous shock along the path of Interconnect. F-LINK supports this requirement through interchangeable pin/socket insert caps as well as in-line receptacles with backshells and panel-mounted plugs.
- Identify the number of termini required to support the fiber count.
- Apply (1) crimp sleeve to each terminus when using receptacle configurations without backshells. Receptacles are typically provisioned with simplex 2.0mm fiber optic cable and simplex connectors (e.g., SC, LC, ST, FC) to form pigtails.



## (6.6g) F-LINK™ Interconnect Solution – Insert Arrangement Provisioning Guidelines

### F-Link Fiber Optic Termini and Electrical Contacts

PART NUMBER	CONFIGURATION	PRODUCT DESCRIPTION
TP2042DD01	Termini, fiber optic	Termini, fiber optic, genderless, pin, 1.25 ceramic ferrule, 126µm
UV164016AA	Contact, electrical	Contact, pin, electrical, 16# AWG
UV165016AA	Contact, electrical	Contact, pin, electrical, 16# AWG, long (ground)
UV164116AA	Contact, electrical	Contact, socket, electrical, 16# AWG
PA35395-99-01	Crimp sleeve	Crimp sleeve, brass, 0.114" O.D.

### Hole Pattern and Channel Designation

The F-LINK™ family of connectors features an advanced means of provisioning fiber optic and hybrid (fiber optic and electrical) insert arrangements. All F-LINK™ pin and socket insert caps are manufactured as injection molded or blank and drilled, according to the desired hole pattern and termini/contact arrangement. Hole patterns can be custom drilled for fast prototype assemblies. Hole patterns and termini/contact assignment are designated by the “NNNNN” scheme within the core part number of any plug or receptacle configuration (HGDNNNNNB130G). Identification of hole patterns and channel designation for each family member is identified in the following table.



Male plug, shell size 16  
(1–6 CH)



Male plug, shell size 22  
(1–17 CH)



Male plug, shell size 28  
(1–33 CH)



Female plug,  
shell size 16 (1–6 CH)



Female plug,  
shell size 22 (1–17 CH)



Female plug, shell size 28  
(1–33 CH)



Male receptacle, shell  
size 16 (1–6 CH)



Male receptacle, shell  
size 22 (1–17 CH)



Male receptacle, shell  
size 28 (1–33 CH)



Female receptacle, shell  
size 16 (1–6 CH)



Female receptacle, shell  
size 22 (1–17 CH)



Female receptacle, shell  
size 28 (1–33 CH)



## (6.7a) F-LINK™ Cable Assemblies



### Applications

- Network (audio, data, or DMX) Professional Equipment
- Oil and Gas Installations
- Deployable Broadcast Systems
- Remote Monitoring Sites
- Robotic Arms and Devices
- Industrial Monitoring
- Mining Solutions

### Overview

OCC's F-LINK™ is a versatile and unique connectivity component family. Born out of the proven performance of mil-spec cylindrical components, the F-LINK interconnect system is a cost-effective solution for commercial, industrial, and military applications. F-LINK is a comprehensive family of connector components designed to solve a multitude of fiber optic applications, as well as enable the emerging trends and technological advances toward hybrid interconnection that combines fiber optic and electrical power within one connector.

### Features & Benefits

- **Designed for hybrid interconnections.** F-LINK can be provisioned for fiber optic only applications or hybrid fiber optic and electrical power connections in one connector. Female gender plugs or receptacles insulate from electrical shock while interfacial seals protect pin contacts for arcing. Any combination of fiber optic or electrical channel counts can be provisioned into plugs or receptacles.
- **Versatile configurations.** The interchangeable pin/socket insert caps allow F-LINK to be provisioned into either male or female plug or receptacle components, eliminating the need to stock multiple components. The retractable backshell system is common to both fiber optic and composite/hybrid cable systems, and eases terminations by allowing the extension and retraction of the inner cable retention system.
- **Outstanding environmental protection.** F-LINK has the proven performance of mil-spec cylindrical-style components designed for extended operation in harsh environments. Protective sealing features, along with advanced materials, enable F-LINK components to operate across a wide temperature and humidity range in high-vibration and/or corrosive environments. Four sealing surfaces, including the insert cap, insert body, plug and receptacle body and rear cable seal, provide exceptional IP-68 compliance when mated together.

F-LINK offers a wide variety of connector configurations, backshells and accessories, and is available in three shell sizes that accommodate up to 33 channels. Any combination of fiber optic or electrical channel counts can be configured into plugs or receptacles.

## (6.7a) F-LINK™ Cable Assemblies – Features and Benefits



F-LINK insert caps provide maximum provisioning flexibility. Termini cavities can be machined for pin or socket requirements.



In-line receptacle male insert cap, 4F + 2E



In-line receptacle female insert cap, 4F + 2E

F-LINK allows interchangeability of pin or socket insert caps, which can be provisioned into either plug or receptacle components.



Four sealing surfaces, including insert cap, insert body, plug and receptacle body with rear cable seal provide exceptional IP-68 compliance.



The F-LINK backshell system provides easy terminations and allows the extension and retraction of the inner cable retention system.



F-LINK can be configured for fiber optic or fiber optic and electrical contacts. Electrical contacts are based on the same proven technology used in D38999 connectors.

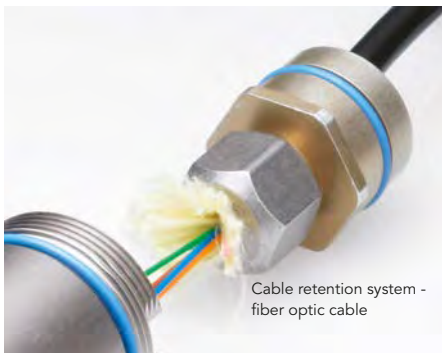

Cable retention system - fiber optic cable



Cable retention system - hybrid (f+e) cable

Interchangeable cable retention system supports either fiber optic cable or hybrid (fiber + electrical) cable.



F-LINK can be configured in a multitude of plug and receptacle configurations.

## (6.7a) F-LINK™ Cable Assemblies – Performance Specifications



### Performance Specifications

PARAMETER	SPECIFICATION	PERFORMANCE
Insertion loss (multimode)	TIA-455-171	0.50dB – typical, 0.75dB – max.
Insertion loss (single-mode)	TIA-455-171	0.40dB – typical, 0.75dB – max.
Back reflection (single-mode UPC polish)	TIA-455-107	-50dB – typical, -40dB – max.
Operating temperature	TIA-455-5	-40°C to +85°C
Storage temperature	TIA-455-5	-40°C to +85°C
Mating durability	TIA-455-21	500 cycles
Impact	TIA-455-2	Method B, omit wall pipe
Twist	TIA-455-36	±90° rotation, 1 cycle/5 sec., 1000 cycles
Cable sealing flex	TIA-455-1	Procedure I
Cable retention <sup>1</sup>	TIA-455-6	400 lbs. min.
Crush resistance	TIA-455-26	450 lbs.
Temperature life	TIA-455-4	250 hrs., 85 ± 2°C
Thermal shock	TIA-455-71	Condition B-0 except 10 cycles, @ 85°C and -62°C
Physical shock	TIA-455-14	Condition C, 5 shocks/axis
Vibration	TIA-455-11	Condition III & VI, Condition C for 1.5 hrs.
Humidity	TIA-455-5	Type II
Water submersion	IP-68, IEC-60529	1m depth, 48 hours, bulkhead mounted in watertight cube
Corrosion Resistance	TIA-455-16	500 hrs. (all plating options)

#### NOTES

<sup>1</sup> Uses military tactical cable for test purposes





## (6.7a) F-LINK™ Cable Assemblies – Ordering Guidelines

### Assembly Ordering – F-LINK

OCC offers a diverse complement of harsh environment connectors that meet almost any application need. The F-LINK product line is designed to be both (a) a general purpose, harsh environment fiber optic interconnect solution as well as (b) a flexible hybrid (fiber optic + electrical) interconnect solution that can meet many hybrid applications. F-LINK systems are typically designed with two panel mounted RECEPTACLE assemblies, connected together with a PLUG-PLUG cable assembly. Other F-LINK cable assembly configurations may include options such as: IN-LINE RECEPTACLE; PANEL MOUNTED PLUG; STRAIN RELIEF RECEPTACLE (SRR). Our state-of-the-art facility can provision any combination of F-LINK connector with either all fiber optic or hybrid cable. These customized cable assemblies are specific to each application and must be engineered to meet all requirements.

### FIBER OPTIC ONLY: What to know when ordering F-LINK fiber optic only assemblies:

**PROVISIONING RECEPTACLES** — The receptacle is the panel/enclosure interface between the active devices (transceivers, SFPs, routers, switches, etc.) and a portal to the interconnecting PLUG-PLUG assembly connecting two systems together. Information necessary to provision the receptacle assemblies includes:

- How many fibers are necessary to interconnect to the active systems? (1 Fiber = 1 Channel)
- What type of simplex/duplex connectors are on the end of the pigtailed (LC, SC, MTP, ST)?
- What type of fiber (50/125µm, 62.5/125µm, 9/125µm or combination)?
- Length of pigtailed?
- Will the pigtailed need to support more than 25 lbs. of cable pull out force? If so, may consider a Strain Relief Receptacle (SRR).
- How is the receptacle installed to the enclosure or panel (inside to out, outside to in)?
- What style of receptacle is preferred: Jam-Nut-Internal; Jam-Nut-External; Panel Mount?
- Receptacles are typically provisioned with female (socket) insert caps. For high mating durability, provision receptacles as male (pin) insert caps.
- A dust cap may be necessary to keep dust from penetrating the connectors when not mated.
- Is there any requirement for conductive grounding of shells to provide EMI protection?
- Typical plating option for F-LINK is Black Anodize, although other options include brass, stainless steel, and Nickel Teflon, for harsher environments.

**PROVISIONING THE PLUG INTERCONNECT** — The PLUG interconnect is typically provisioned with multi-fiber cable and establishes the communication path between two enclosures, shelters or racks. It is typically provisioned with a fixed length of fiber cable and most commonly with two PLUGs (ex: PLUG to PLUG). Alternate provisioning for specific applications can include: PLUG provisioned as either male or female; PLUG to an IN-LINE receptacle; PLUG to pigtailed; or IN-LINE receptacle to pigtailed. Information necessary to provision the PLUG assemblies includes:

- How many fibers are required (from receptacle model)? (1 Fiber=1 Channel)
- What type of fiber is required (from receptacle model)?
- How long does the PLUG interconnect need to be?
- What type of environment will the cable be subjected to (indoor/outdoor, chemicals, extreme temperature)
- PLUG-PLUG assemblies are typically provisioned with male (pin) insert caps. For high mating durability, provision PLUGs as female (socket) insert caps.
- Other PLUG interconnect options may include PLUG to IN-LINE receptacle, PLUG to pigtailed.
- A dust cap may be necessary to keep dust from penetrating the PLUG when not mated.
- The plating option typically tracks the plating option of the receptacle.
- To maintain the cable select one of the many MARS reels and accessories.

### FIBER OPTIC AND COPPER-HYBRID: What to know when ordering F-LINK Hybrid Fiber Optic + Electrical assemblies:

**PROVISIONING HYBRID RECEPTACLES** — Hybrid receptacles include a combination of fiber optic and electrical connectivity and, as such, require specific considerations. Provisioning the fiber optic portion of the receptacle is identical to the guidelines identified above. However, the electrical portion of the hybrid receptacle is more involved. As an example, to help prevent electrical shock from contacting power conductors, the RECEPTACLE on the source end of the power is typically a SOCKET CONTACT (female) which is inside the insulated insert. The RECEPTACLE on the load end of the system is typically PIN CONTACT (male) so it can receive a cable PLUG connector which has potentially live SOCKET (female) contacts that are also below the surface of the insert.

## (6.7a) F-LINK™ Cable Assemblies – Ordering Guidelines

### Information needed to Provision a Hybrid Receptacle can include:

- What type of power transmission is required (DC; DC+ GRD; AC 1PHASE+2 WIRE; AC 1PHASE+3WIRE; AC 3PHASE+4WIRE)?
- What is the voltage requirement on the load end?
- What is the full load current on the load end?
- Is grounding required?
- Is there a need to prevent electrical shock (in other words there is no fail safe power cutoff)?
- What are the lengths of the copper pigtailed? What, if any, terminals are required on copper pigtailed?
- What is the length of fiber pigtailed? What fiber connectors are required on pigtailed (SC, LC, MTP, ST)?
- A dust cap may be necessary to keep dust from penetrating the connectors when not mated.
- Typical plating option for F-LINK is Black Anodize, although other options include brass, stainless steel, and Nickel Teflon for harsher environments.
- Are there any specific ratings for the type of copper conductors (solid; stranded; MIL-Spec; Commercial)?
- Are there any specific industry rating requirements for the interconnect system?

**PROVISIONING THE HYBRID PLUG Interconnect** — Hybrid PLUG interconnects include a combination of fiber optic and electrical connectivity and, as such, require specific considerations similar to the hybrid receptacles above. Provisioning the fiber optic portion of the PLUG interconnect is identical to the guidelines identified above. However, the electrical portion of the composite PLUG interconnect is more involved. For example, to prevent electrical shock from touching power conductors, the PLUG end connecting to the power source receptacle is a MALE so as to mate with a FEMALE RECEPTACLE that may be powered but would have socket contacts below the insert surface. The opposite end of the cable interconnect is provisioned as PLUG, FEMALE, once again with socket contacts below the insert surface, to prevent electrical shock. Another favorable option for the load end of the cable is that the load end can be provisioned as an IN-LINE RECEPTACLE, FEMALE (with recessed sockets) to mate with a PANEL MOUNT PLUG, MALE. There are two benefits of this configuration:

- A clear distinction between PLUG and IN-LINE receptacle cable ends, when stored on a deployable reel.
- Allows for cable segments to be “daisy chained” together to form longer cable interconnects.

Again, the electrical requirements for the hybrid PLUG interconnect are similar to the electrical requirements of the hybrid receptacle:

- What type of power transmission is required (DC; DC+ GRD; AC 1PHASE+2 WIRE; AC 1PHASE+3WIRE; AC 3PHASE+4WIRE)?
- What is the voltage requirement on the load end?
- What is the full load current on the load end?
- Is grounding required?
- Is there a need to prevent electrical shock (there is no fail safe power cutoff)?
- What is the length of the PLUG interconnect?
- A dust cap may be necessary to keep dust from penetrating the connectors when not mated.
- Are there any specific ratings for the type of copper conductors (solid; stranded; MIL-Spec; Commercial)?
- Are there any specific industry rating requirements for the interconnect system?
- To maintain the cable, select one of the many MARS reels and accessory options.

For all composite applications, maximum power transmission and voltage drop should be calculated across either cable span. Please contact the OCC factory Application Engineer for assistance with the application.

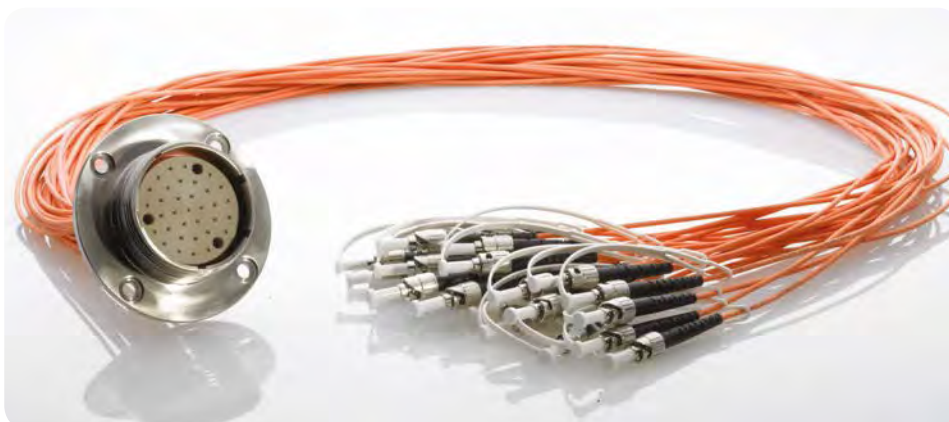

Please call 1-800-622-7711 and ask for a Sales Representative. We're ready to assist you.



 (6.7b) OCC Pierside Cable Assemblies

### Applications

- Ship-to-Shore Communications Umbilical Connect
- Mobile Emergency Telecommunications Stations
- Mobile Tactical Shelters
- U.S. Army, Navy, and Marine Corps Military Tactical Deployments
- Broadcast
- Oil and Gas Industries

### Overview

OCC's Pierside family of fiber optic connectors is designed to meet the stringent Pierside performance specifications (NAVSEA 737971 performance and 7379172) and is an ideal connector system for much more than ship-to-shore communications. The Pierside connector provides a genderless mating system perfect for applications requiring high performance in single-mode, multimode or composite configurations in extreme environments. In addition, this connector is an excellent choice for other applications, including broadcast, mining, land tactical, control systems, and more.



CCPC22F11C  
12 CH external jam nut receptacle

### Features & Benefits

- **Easy and managable installations.** The Pierside connector provides a true hermaphroditic design, allowing this connector to mate plug-to-plug or plug-to-receptacle. This allows for flexibility and quick fiber system deployments when multiple units are daisy-chained together. As one of the only manufacturers providing a true hermaphroditic dust cap as a standard, Pierside is capable of mating without regard for male or female gender of the interfacing connector.
- **Standards compliant.** Available in single-mode, multimode or a combination of both, Pierside is compliant with the Commercial Item Description (CID) standard issued by the Naval Sea Command.
- **Comprehensive options for a variety of uses.** OCC's Pierside affords the most comprehensive complement of options available, including hermaphroditic or standard dust caps, strain-relief receptacles, 90° plugs and more. The interchangeable Detachable Socket Insert (DSI) and termini enable users to replace components as needed. Pierside is interoperable with other connectors complying to the same standard and features a hermaphroditic dust cap as a standard provision.



## (6.7b) OCC Pierside Cable Assemblies – Features and Benefits



Interoperable with other competitive connectors allowing end users more flexibility when sourcing components.



Interchangeable Detachable Socket Insert (DSI) and terminations enables end users to purchase replacement components to be used with OCC or other manufacturer's products.



OCC offers replacement dust caps kits in male, female, or hermaphroditic options.



Enhanced Kevlar® retention system supports tactical or mobile deployment without degradation of the optical signal.



Field-convertible hermaphroditic design easily allows Pierside connectors to be mated regardless of gender and offers effortless plug-to-plug assembly.

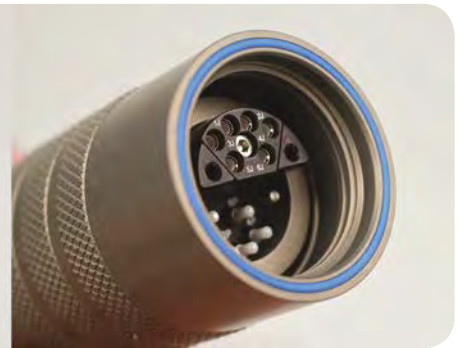

A complete complement of connector options, including replacement dust caps, strain-relief receptacles, and 90° plugs are available.



Full array of replacement components designed to meet the scope of NAVSEA 7379171 and 7379172.

Kevlar is a registered trademark of DuPont.

 (6.7b) OCC Pierside Cable Assemblies – Performance Specifications

## Performance Specifications

PARAMETER	SPECIFICATION	PERFORMANCE
Insertion loss (multimode)	TIA-455-171	0.30dB – typical, 0.75dB – max.
Insertion loss (single-mode)	TIA-455-171	0.40dB – typical, 0.75dB – max.
Back reflection (single-mode UPC polish)	TIA-455-60	-50dB – typical, -40dB – max.
Operating temperature	TIA-455-5	-54°C to +85°C
Storage temperature	TIA-455-5	-65°C to +85°C
Temperature cycling	TIA-455-3	-54°C to +85°C
Mating durability	TIA-455-21	1000 cycles min.
Impact	TIA-455-2	Method B
Twist	TIA-455-36	±90° rotation, 1 cycle/5 sec., 1000 cycles
Cable sealing flex	MIL-STD-1344, method 2017	100 cycles
Cable retention	TIA-455-6	400 lbs. min.
Crush resistance	TIA-455-26	450 lbs.
Physical shock	TIA-455-14	Condition C
Vibration	MIL-STD-1344	Method 2005.1
Temperature humidity	TIA-455-5	Method B
Fluid immersion	TIA-455-12	24 hrs. per fluid
Water pressure		25 PSI, 24 hrs.
Ozone exposure	ATSM-D-1149	100–150 PPM for 2 hrs.
Flammability	MIL-STD-1344	Method 1012
Corrosion resistance	TIA-455-16	Condition I, 500 hrs. salt spray
Thermal shock	TIA-455-71	Condition B-0 except 10 cycles, @ 85°C and -62°C



CCPA10C11CB  
6 channel hermaphroditic plug



CCPC22C11C  
6 channel external jam nut receptacle

## (6.7b) OCC Pierside Cable Assemblies – Ordering Information



### Assembly Ordering — Pierside

OCC offers a diverse complement of harsh environment connectors that meet almost any application need. The PIERSIDE product line is designed to be a deployable style, harsh environment, hermaphroditic, fiber optic interconnect solution.

PIERSIDE systems are typically comprised of two panel mounted RECEPTACLE assemblies connected together with a PLUG-PLUG cable assembly. Since the PIERSIDE PLUG can instantly be converted in the field, without tools, from a MALE PLUG to a FEMALE PLUG, most application requirements can be served with a standard PLUG to PLUG fiber optic assembly. This is due to the hermaphroditic design which allows PLUG to PLUG or PLUG to RECEPTACLE mating. Our state-of-the-art facility can provision any combination of PIERSIDE connectors with either all Multimode (MM), or all Single-mode (SM), fiber optic or a composite fiber optic combination. These customized cable assemblies are specific to each application and can be easily engineered to meet all requirements.

**PROVISIONING RECEPTACLES** — The receptacle is the panel/enclosure interface between the active devices (transceivers, SFPs, routers, switches, etc.) and the “external” PLUG-PLUG assembly connecting two enclosures, shelters or racks together. The receptacle connector may be cabled to the active devices with simple pigtail single fiber cables, or with an overall cable construction for added protection and then fanned out to active devices, or as a full Strain Relief Receptacle (SRR), having a full heavy duty backshell/strain relief to preclude damage from cable pulling forces if they are anticipated.

#### Information necessary to provision the RECEPTACLE assemblies include:

- How many fibers are necessary to interconnect between the active systems? (1Channel=1Fiber)
- What type of simplex/duplex connectors are on the end of the receptacle pigtails (e.g., LC, SC, MTP, ST)?
- What type of fiber (50/125µm, 62.5/125µm, 9/125µm or a composite of fiber types)?
- Length of pigtails?
- Will the pigtails need to support more than 25 lbs. of cable pull out force? Possible SRR needed?
- All PIERSIDE receptacles are mounted from inside to outside.
- What style of receptacle is preferred (Jam-Nut-External or Jam-Nut-External with Integrated Strain Relief)?
- Typical plating option for PEIRSIDE is hard anodize, although other material/finish options, including brass and stainless steel, are available as custom solutions.

**PROVISIONING THE PLUG INTERCONNECT** — The PLUG interconnect is typically provisioned with multi-fiber cable and establishes the communication path between two enclosures, shelters or racks. It is typically provisioned with a fixed length of fiber cable and provisioned with a plug at each end (ex: PLUG to PLUG). The PLUG interconnect can also be provisioned as a PLUG to a pigtail/fanout assembly. A 90° PLUG option is also available. Information necessary to provision the PLUG Interconnect assemblies includes:

- How many fibers are required (generally will be the same as from receptacle model above)? PIERSIDE features two styles of Insert Arrangement: 6 CH and 12 CH.
- Any unused cavities will normally be provisioned with dummy terminus to seal the cavities.
- What type of fiber is required (from receptacle model)?
- How long does the PLUG-PLUG interconnect need to be?
- What type of environment will the cable be subjected to (Indoor-Outdoor, Chemicals, Extreme Temperature)?  
OCC engineering can assist in matching a cable construction to the application environment.
- Plating: Typically same as from the Receptacle model above.
- To maintain and deploy/retrieve the cable, select one of the many MARS reels and accessories.

For more complete connector selection and configuration, please see Choosing the Right Connector on pg. 35–36.

Please call 1-800-622-7711 and ask for a Sales Representative. We're ready to assist you.

 (6.7c) COTS-83526 Cable Assemblies

### Applications

- Mobile Emergency Telecommunications Stations
- Mobile Tactical Shelters
- U.S. Army, Navy, and Marine Corps Military Tactical Deployments
- Deployable Trailers for Federal Emergency Management Agency
- Homeland Security Applications
- Mining
- Oil & Gas

### Overview

OCC's COTS-83526 connector is based on the MIL-PRF-83526 performance specification, the successful backbone for military tactical fiber optics. It features a field-convertible hermaphroditic plug design, with integrated strain-relief and tactical cable retention system. COTS 83526 is available in two shell sizes with 2 to 12 channel options. This family of tactical fiber optic connectors also features specifications for a wide variety of receptacles, including internal jam nut, external jam nut, flange-mount, and strain-relief configurations.

### Features & Benefits

- **Superior performance with protection from the elements.** At the heart of this robust family of tactical hermaphroditic fiber optic connectors is the environmentally sealed terminus system, which maintains superior optical performance while resisting dust, moisture, or even liquid submersion, meeting IP-68 requirements.
- **Easy, quick connections.** The field-convertible plug allows the plug to be converted to an in-line receptacle or back to a plug within seconds. This enables plug-to-plug assemblies to be connected end-to-end without regard for which end starts out as male or female. The internal "push-pull" system allows operators to terminate and assemble COTS-83526 plug and receptacles with ease. Unlike competitive products that require O-rings and snap clips, the COTS-83526 design essentially decreases the time and effort required for assembly.
- **Smart construction for ease of use.** The environmentally sealed terminus system allows proper alignment of the 2.5mm ceramic ferrules. This termini is corrosive-resistant, genderless (can be either pin or socket), and easily inserts at 90° angles to the termini retainer. In addition, the insert cap having ceramic alignment sleeves prevents them from becoming misplaced during routine maintenance.



## (6.7c) COTS-83526 Cable Assemblies – Features and Benefits



4 CH COTS-83526 plug mated with competitors  
4 CH TFOCA® II plug.



Interoperable, intermateable, and backward compatible with most MIL-PRF-83526/16 & /17 interface specifications.



Field convertible hermaphroditic plug design allows connector to be provisioned for either female or male connectivity.



Captivated ceramic split sleeves prevent them from becoming misplaced during routine maintenance.



Field convertible hermaphroditic dust cap design can be quickly converted to allow mating with other dust caps in a plug-to-plug or plug-to-receptacle configuration. This keeps dust caps clean and readily available.



Enhanced Kevlar® retention system supports harsh environment deployment without degradation of the optical signal.



Internal "push-pull" system allows operators to terminate COTS-83526 plugs and receptacles easily.



TC1640CA termini

Sealed termini system provides environmental resistance and meets IP-68 requirements.



Dry film thread lubrication system extends life of mating threads by self-lubricating through repeated cycles.



The COTS-83526 family of connectors comes in 2 shell sizes and features a diverse set of receptacle configurations.



COTS-83526 removal tool allows for easy installation and removal of terminus into the connector, should it ever be needed.

Kevlar is a registered trademark of DuPont.



## (6.7c) COTS-83526 Cable Assemblies – Performance Specifications

## Performance Specifications

PARAMETER	SPECIFICATION	PERFORMANCE
Insertion loss (multimode)	TIA-455-171	0.50dB – typical, 0.75dB – max.
Insertion loss (single-mode)	TIA-455-171	0.40dB – typical, 0.75dB – max.
Back Reflection (single-mode, UPC polish)	TIA-455-107	-50dB – typical, -40dB – max.
Operating temperature	TIA-455-5	-54°C to +71°C
Storage temperature	TIA-455-5	-57°C to +85°C
Mating durability	TIA-455-21	2000 cycles
Impact	TIA-455-2	Method B, omit wall pipe
Twist	TIA-455-36	±90° rotation, one cycle/5 sec., 1000 cycles
Cable sealing flex	TIA-455-1	Procedure I
Cable retention	TIA-455-6	400 lbs. min.
Crush resistance	TIA-455-26	450 lbs.
Temperature life	TIA-455-4	250 hrs., 85° ± 2°C
Thermal shock	TIA-455-71	Condition B-0 except 10 cycles, @ 85°C and -62°C
Physical shock	TIA-455-14	Condition C, 5 shocks/axis
Vibration	TIA-455-11	Condition III & VI, Condition C for 1.5 hrs.
Humidity	TIA-455-5	Method B
Salt spray <sup>1</sup>	TIA-455-16	Condition I
Fluid immersion	TIA-455-12	24 hrs. per fluid
Water submersion	TIA-455-98	Method A, Procedure 1, 1m for 24 hrs.; bulkhead mounted in watertight cube
Flammability	EIA-364-8	Burning and after-flow extinguishing, ≤ 3 sec.
Mud test <sup>2</sup>	M83526, paragraph 4.8	5 min. immersion, 10 cycles
Electromagnetic effects <sup>1,3</sup>	IEEE-299	20kHz, 150kHz, 14MHz, 400MHz, 600MHz, 1GHz, 2GHz, 8GHz, 10GHz, vert. and horz., <-60dB

## NOTES

<sup>1</sup> Applies to ZINi plating only

<sup>2</sup> Sand/topsoil substituted for Potter's Clay

<sup>3</sup> 12 CH receptacle requires application of SRR configurations



## (6.7c) COTS-83526 Cable Assemblies – Ordering Information

### Assembly Ordering — COTS 83526

OCC offers a diverse complement of harsh environment connectors that meet almost any application need. The COTS 83526 product line is designed to be a deployable style, harsh environment, hermaphroditic, fiber optic interconnect solution.

COTS 83526 systems are typically comprised of two panel mounted RECEPTACLE assemblies, connected together with a PLUG-PLUG cable assembly. Since the COTS 83526 PLUG can instantly be converted in the field, without tools, from a MALE PLUG to a FEMALE PLUG, most application requirements can be served with a standard PLUG to PLUG fiber optic assembly. This is due to the hermaphroditic design which allows PLUG to PLUG or PLUG to RECEPTACLE mating. Our state-of-the-art facility can provision any combination of COTS 83526 connectors with either all Multimode (MM), or all Single mode (SM), fiber optic or a composite fiber optic combination. These customized cable assemblies are specific to each application and can be easily engineered to meet all requirements.

**PROVISIONING RECEPTACLES** — The receptacle is the panel/enclosure interface between the active devices (transceivers, SFPs, routers, switches, etc.) and the “external” PLUG-PLUG assembly connecting two enclosures, shelters or racks together. The receptacle connector may be cabled to the active devices with simple pigtail single fiber cables, or with an overall cable construction for added protection and then fanned out to active devices, or as a full Strain Relief Receptacle (SRR), having a full heavy duty backshell/strain relief to preclude damage from cable pulling forces if they are anticipated.

#### Information necessary to provision the RECEPTACLE assemblies include:

- How many fibers are necessary to interconnect between the active systems? (1 Channel = 1 Fiber)
- What type of simplex/duplex connectors are on the end of the receptacle pigtails (e.g. LC, SC, MTP, ST)?
- What type fiber (50/125µm, 62.5/125µm, 9/125µm or a composite of fiber types)?
- Length of pigtails?
- Will the pigtails need to support more than 25 lbs. of cable pull out force? If so, consider using a Strain Relief Receptacle to sustain cable pull out forces in excess of 100 lbs.
- How is the receptacle installed to the enclosure or panel (inside to out, outside to in, flange mount)?
- What style of receptacle is preferred (Jam-Nut-Internal Mounted, Jam-Nut, External Mounted, Flange Mount, Jam-Nut, Internal with Integrated Strain Relief, Jam-Nut-External with Integrated Strain Relief, or Flange Mount with Integrated Strain Relief)?
- Is there any conductive requirement for EMI grounding protection?
- Typical plating option for COTS 83526 is Zinc Nickel, although other material/finish options, including brass and stainless steel, are available as custom solutions.

**PROVISIONING THE PLUG INTERCONNECT** — The PLUG interconnect is typically provisioned with multi-fiber cable and establishes the communication path between two enclosures, shelters or racks. It is typically provisioned with a fixed length of fiber cable and provisioned with a plug at each end (ex: PLUG to PLUG). The PLUG interconnect can also be provisioned as a PLUG to a pigtail/fanout assembly. Information necessary to provision the PLUG interconnect assemblies include:

- How many fibers are required (generally will be the same as from receptacle model above)? COTS 83526 features two styles of Insert Arrangement: 4CH and 12CH.
- Any unused cavities will normally be provisioned with dummy terminus to seal the cavities.
- What type of fiber is required (from receptacle model)?
- How long does the PLUG-PLUG interconnect need to be?
- What type of environment will the cable be subjected to (Indoor-Outdoor, Chemicals, Extreme Temperature)? OCC engineering can assist in matching a cable construction to the application environment.
- Plating—Typically same as from the Receptacle model above.
- To maintain and deploy/retrieve the cable, select one of the many MARS reels and accessories.

For more complete connector selection and configuration, please see Choosing the Right Connector on pg. 35–36. Together we can find the right options for your requirements.

Please call 1-800-622-7711 and ask for a Sales Representative. We're ready to assist you.

## (6.7d) EZ-MATE Cable Assemblies



### Applications

- Ship-to-Shore Communications Umbilical Connect
- Mobile Emergency Telecommunications Stations
- Mobile Tactical Shelters
- U.S. Army, Navy, and Marine Corps Military Tactical Deployments
- Mobile or Remote Broadcast
- Oil and Gas Industries
- Mining

### Overview

The OCC EZ-MATE family of hermaphroditic-style fiber optic connectors provides the most comprehensive solution for harsh, deployable mobilized communications systems. The EZ-MATE Interconnection offers the same proven technology used in advanced military communication systems coupled with a simplified interface capable of “blind mating.” With a variety of options, the EZ-MATE provides ruggedized connectivity in the most challenging environments.

### Features & Benefits

- **Easy, quick connections.** The field-convertible hermaphroditic plug design allows for it to be converted to an in-line receptacle or back to plug within seconds. This enables plug-to-plug assemblies to be connected end-to-end without regard for male or female ends. The integrated “push-pull” system allows operators to terminate EZ-MATE plug and receptacles with ease.
- **Simple to use. Hard to break.** In addition to the EZ-MATE’s user-friendly interface, the connector will resist extremely harsh mechanical and environmental conditions, including high vibration, fluid immersion, mechanical stress and thermal shock, and continues to operate under extreme tension loading when used with OCC tactical cable. Its ability to “blind-mate” is ideal for applications that require thousands of mating cycles. The enhanced Kevlar® retention system supports high cable tensile loading without loss of optical signal.
- **A variety of options to fit any application.** Available for 2- to 24-channels, EZ-MATE allows maximum flexibility to accommodate specific applications. Each of the two shell sizes features a diverse set of receptacle configures to solve almost any application.



Kevlar is a registered trademark of DuPont.

## (6.7d) EZ-MATE Cable Assemblies – Features and Benefits



Field convertible hermaphroditic plug design allows connectors to be provisioned for either male or female connectivity.



Enhanced Kevlar retention system supports harsh environment deployment without degradation of the optical signal.



Field convertible hermaphroditic dust cap design can be quickly converted to allow mating with other dust caps in a plug-to-plug or plug-to-receptacle configuration. This keeps dust caps clean and readily available.



Captivated ceramic split sleeves prevent them from becoming misplaced during routine maintenance.

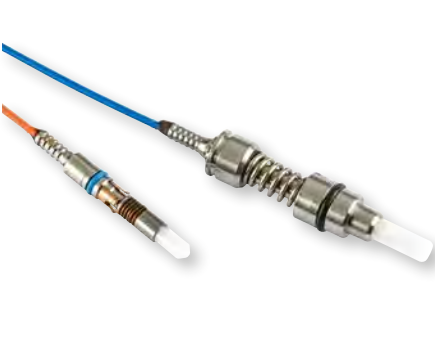

Sealed termini system provides environmental protection and meets IP-68 requirements.



EZ-MATE back-to-back receptacles available for bulkhead plug-to-plug connections.

 (6.7d) EZ-MATE Cable Assemblies – Performance Specifications

PARAMETER	SPECIFICATION	PERFORMANCE
Insertion loss (multimode)	TIA-455-171	0.50dB – typical, 0.75dB – max.
Insertion loss (single-mode)	TIA-455-171	0.40dB – typical, 0.75dB – max.
Back reflection (single-mode UPC polish)	TIA-455-107	-50dB – typical, -40dB – max.
Operating temperature	TIA-455-5	-54°C to +71°C
Storage temperature	TIA-455-5	-57°C to +85°C
Mating durability	TIA-455-21	1000 cycles
Impact	TIA-455-2	Method B, omit wall pipe
Twist	TIA-455-36	±90° rotation, 1 cycle/5 sec., 1000 cycles
Cable sealing flex	TIA-455-1	Procedure I
Cable retention <sup>1</sup>	TIA-455-6	400 lbs. min.
Crush resistance	TIA-455-26	450 lbs.
Temperature life	TIA-455-4	250 hrs., 85 ± 2°C
Thermal shock	TIA-455-71	Condition B-0 except 10 cycles, @ 85°C and -62°C
Physical shock	TIA-455-14	Condition C, 5 shocks/axis
Vibration	TIA-455-11	Condition III & VI, Condition C for 1.5 hrs.
Humidity	TIA-455-5	Method B
Salt spray (Corrosion resistance)	TIA-455-16	Condition I
Fluid immersion	TIA-455-12	24 hrs. per fluid
Water submersion	TIA-455-98	Method A, Procedure 1, 1m for 24 hrs.; bulkhead mounted in watertight cube
Flammability	EIA-364-8	Burning and after-flow extinguishing. ≤ 3 sec.
Mud test	M83526, paragraph 4.8	5 min. immersion, 10 cycles
Electromagnetic effects	IEEE-299	20kHz, 150kHz, 14MHz, 400MHz, 600MHz, 1GHz, 2GHz, 8GHz, 10GHz, vert. and horiz., <-60dB

**NOTE:**<sup>1</sup> When terminated with OCC tactical cable.

4 channel EZ-MATE plug



4 channel EZ-MATE jam nut receptacle

## (6.7d) EZ-MATE Cable Assemblies – Ordering Information

### Assembly Ordering — EZ-MATE

OCC offers a diverse complement of harsh environment connectors that meet almost any application need. The EZ-MATE product line is designed to be a deployable style, harsh environment, hermaphroditic, fiber optic interconnect solution.

EZ-MATE systems are typically comprised of two panel mounted RECEPTACLE assemblies, connected together with a PLUG-PLUG cable assembly. Since the EZ-MATE PLUG can instantly be converted in the field, without tools, from a MALE PLUG to a FEMALE PLUG, most application requirements can be served with a standard PLUG to PLUG fiber optic assembly. This is due to the hermaphroditic design, which allows PLUG to PLUG or PLUG to RECEPTACLE mating. Our state-of-the-art facility can provision any combination of EZ-MATE connectors with either all Multimode (MM) or all Single mode (SM), fiber optic or a composite fiber optic combination. These customized cable assemblies are specific to each application and can be easily engineered to meet all requirements.

**PROVISIONING RECEPTACLES** — The receptacle is the panel/enclosure interface between the active devices (transceivers, SFPs, routers, switches, etc.) and the “external” PLUG-PLUG assembly connecting two enclosures, shelters or racks together. The receptacle connector may be cabled to the active devices with simple pigtail single fiber cables, or with an overall cable construction for added protection and then fanned out to active devices, or as a full Strain Relief Receptacle (SRR), having a full heavy duty backshell/strain relief to preclude damage from cable pulling forces if they are anticipated.

#### Information necessary to provision the RECEPTACLE assemblies include:

- How many fibers are necessary to interconnect between the active systems? (1 Channel=1 Fiber)
- What type of simplex/duplex connectors are on the end of the receptacle pigtails (e.g. LC, SC, MTP, ST)?
- What type of fiber (50/125µm, 62.5/125µm, 9/125µm or a composite of fiber types)?
- Length of pigtails?
- Will the pigtails need to support  $\leq 25$  lbs. of cable pull out force? If so, consider using a Strain Relief Receptacle to sustain cable pull out force in excess of 100 lbs.
- How is the receptacle installed to the enclosure or panel (inside to out, outside to in)?
- What style of receptacle is preferred (Jam-Nut-Internal Mounted, Jam-Nut, External Mounted, Flange Mount, Jam-Nut, Internal with Integrated Strain Relief, Jam-Nut-External with Integrated Strain Relief, or Flange Mount with Integrated Strain Relief)?
- Is there any conductive requirement for EMI grounding protection?
- Typical plating option for EZ-MATE is Black Anodize, although other material/finish options, including brass, stainless steel, and Zinc-Nickel are available as custom solutions.

**PROVISIONING THE PLUG INTERCONNECT** — The PLUG interconnect is typically provisioned with multi-fiber cable and establishes the communication path between two enclosures, shelters or racks. It is typically provisioned with a fixed length of fiber cable and provisioned with a plug at each end (ex: PLUG to PLUG). The PLUG interconnect can also be provisioned as a PLUG to a pigtail/fanout assembly. Information necessary to provision the PLUG Interconnect assemblies include:

- How many fibers are required (generally will be the same as from receptacle model above)? EZ-MATE features four styles of Insert Arrangement: 4CH, 6CH, 12CH and 24CH.
- Any unused cavities will normally be provisioned with dummy terminus to seal the cavities.
- What type of fiber is required (from receptacle model)?
- How long does the PLUG-PLUG interconnect need to be?
- What type of environment will the cable be subjected to (Indoor-Outdoor, Chemicals, Extreme Temperature)?  
OCC engineering can assist in matching a cable construction to the application environment.
- Plating: Typically same as from the Receptacle model above.
- To maintain and deploy/retrieve the cable, select one of the many MARS reels and accessories.

For more complete connector selection and configuration, please see Choosing the Right Connector on pg. 35–36. Together we can find the right options for your requirements.

Call 1-800-622-7711 and ask for a Sales Representative. We're ready to assist you.



 (6.7e) MHC® II Cable Assemblies

## Applications

- Voice/Data/Video in Harsh Environments
- Deployed Broadcast Systems
- Remote Monitoring Sites
- Robotic Arms and Robot Devices
- Industrial Monitoring

## Overview

OCC's Mini Hermaphroditic Connector, or MHC® II, is an amazingly rugged, yet remarkably small connector suitable for industrial and harsh environments. Designed for quick and easy connections, the genderless mating of the MHC II connector provides a multitude of options for 2, 4, 6 and 8 channels fiber optic only or fiber optic/electro hybrid configurations. Where repeatable performance is critical, the MHC II provides reliable optical performance and trusted environmental and mechanical capabilities.

## Features & Benefits

When requirements call for high-speed, high-bandwidth communications, trust OCC's MHC II to deliver:

- **Small size and big ruggedness.** The MHC II's compact footprint and ability to house up to 8 channels per connector, allows for higher channel counts in the same space requirements. In addition, the MHC II is manufactured with an all-metal construction that can withstand wide temperature ranges and provide extreme impact resistance. Various plating options and an IP-68 rating also reinforce the rugged nature of the MHC II's environmental and mechanical performance.
- **Easy and manageable installations.** The genderless mating or hermaphroditic design of the MHC II allows plugs and receptacles to be mated easily without regard to the gender. This design also allows two plugs to be mated together for end-to-end connections. In addition, features such as integrated pulling eyes that assist in difficult cable pulls make the MHC II an ideal choice for quick and easy installations.
- **Truly exceptional performance and reliability.** Incorporating ceramic ferrule technology, the MHC II is extremely durable and maintains high standards of insertion loss performance. MHC II maintains its incredible dependability despite repeated matings during its lifetime and is easily field maintainable if needed.
- **Multitude of configurations to meet any application need.** Available in a variety of options, the MHC II can accommodate 2, 4, 6, and 8 fiber optic channel configurations. The 6 and 8-channel versions are able to accommodate both fiber and copper elements. MHC II plugs can be provisioned with a locking coupling nut that secures the plug to the receptacle or another plug and is ideal for fixed or permanent installs. For applications that require a quicker connect and disconnect, the MHC II can be ordered with a spring actuated coupling nut that allows for fast connections in a quarter turn. To complement the plug options, MHC II receptacles are available in jam nut or flange-mount formats.



Whether installing an industrial network on the factory floor or deploying a broadcast system in a NASCAR racetrack, OCC's MHC II is the natural choice. Its compact and rugged design, as well as its superior optical performance, provides a reliable solution to any network application.



## (6.7e) MHC® II Cable Assemblies – Features and Benefits



All-metal construction enables MHC II to survive harsh environments.



Plug strength exceeds 400 lb tensile load when utilizing OCC's Distribution or Breakout style cables.w



Bayonet coupling with red locking nut allows quick, easy and reliable connections in just two steps. Ideal for fixed or permanent installations.



Spring actuated coupling nut allows quick connects in a quarter turn. Ideal for applications that require quick deployments and retrievals.



Pulling eye dustcap enables pre-terminated assemblies to be pulled easily through conduit spaces.



Hermaphroditic connectivity enables plugs to be mated with receptacles or other plug-to-plug segments in a daisy-chain series.



The MHC II can be disassembled for quick and easy access to clean the fiber optic termini.



MHC II receptacles can accommodate 900  $\mu$ m buffer fiber, 2.0mm furcated fiber or standard distribution or breakout simplex connector pigtailed.



Both the 4 and 8 channel shell size occupy a small receptacle mounting area. The 8 channel shell size can also accommodate composite (fiber + electrical) configurations.



## (6.7e) MHC® II Cable Assemblies – Performance Specifications

## Performance Specifications

PARAMETER	SPECIFICATION	PERFORMANCE
Insertion Loss (multimode)	TIA-455-171	0.50dB – typical, 0.75dB – max.
Insertion Loss (single-mode)	TIA-455-171	0.50dB – typical, 0.75dB – max.
Back reflection (single-mode UPC polish)	TIA-455-107	-50dB – typical, -40dB – max.
Back reflection (single-mode APC polish) <sup>1</sup>	TIA-455-107	-65dB – typical, -60dB – max.
Operating temperature	TIA-455-5	-54°C to + 71°C
Storage temperature	TIA-455-5	-57°C to + 85°C
Mating durability	TIA-455-21	1000 cycles
Impact	TIA-455-2	Method B
Twist	TIA-455-36	±90° rotation, one cycle/5 sec., 1000 cycles
Cable sealing flex	TIA-455-1	Procedure I
Cable retention (Mil. Req.)	TIA-455-6	400 lbs. min.
Crush resistance	TIA-455-26	450 lbs.
Temperature life	TIA-455-4	250 hrs., 85±2°C
Thermal shock	TIA-455-71	Condition B-0 except 10 cycles, @ 85°C and -62°C
Physical shock	TIA-455-11	Condition C, 5 shocks/axis
Vibration	TIA-455-1	Condition III & VI, Condition C for 1.5 hrs.
Humidity	TIA-455-5	Type II
Dust test	IEC 60529 IP68	8 hrs. dust exposure with 20 mbar
Water submersion	IEC 60529 IP68	48 hrs. in immersion tank/1 meter water
Corrosion resistance	TIA-455-16	500 hrs.

## NOTES:

<sup>1</sup> Single-mode APC polish is only available in the 4CH option



## (6.7e) MHC® II Cable Assemblies – What to Know When Ordering

### Assembly Ordering — MHC II

OCC offers a diverse complement of harsh environment connectors that meet almost any application need. The MHC II product line is designed to be a small form factor, deployable style, harsh environment fiber optic interconnect solution for 2–4 fibers, as well as either an all fiber (up to 8 fibers) or a hybrid (fiber and copper connections) in the shell size. MHC II systems are typically designed with two PANEL MOUNTED RECEPTACLE assemblies, connected together with a PLUG-PLUG cable assembly. Since the MHC II PLUG can instantly convert from a MALE PLUG to an FEMALE PLUG, most applications are solved with PLUG to PLUG fiber optic assemblies. Our state-of-the-art facility can provision any combination of MHC II connectors with either all fiber optic or hybrid fiber & copper cable. These customized cable assemblies are specific to each application and must be engineered to meet all requirements.

For more complete connector selection and configuration, please see Choosing the Right Connector on page 27. Together we can find the right options for your requirements.

### FIBER OPTIC ONLY: What to know when ordering MHC II fiber optic only assemblies:

**PROVISIONING RECEPTACLES** — The receptacle is the panel/enclosure interface between the active devices (transceivers, SFPs, routers, switches, etc.) and a portal to the interconnecting PLUG-PLUG assembly connecting two systems together. Information necessary to provision the receptacle assemblies include:

- How many fibers are necessary to interconnect to the active systems? (1 Fiber = 1 Channel).
- Cable construction is detailed in next section; important especially for MHC II receptacle connectors.
- What type of simplex/duplex/multifiber connectors are on the end of the pigtails (LC, SC, MTP, ST)?
- What type of fiber (50/125µm, 62.5/125µm, 9/125µm or a composite of fiber types)?
- Length of pigtails?
- How is the receptacle installed to the enclosure or panel (inside to out, outside to in)?
- What style of receptacle is preferred (Jam-Nut-Internal; Jam-Nut-External)?
- Dust caps are standard with the MHC II connectors to keep dust and moisture from penetrating the connectors when not mated.
- Is there any requirement for conductive grounding of shells to provide EMI protection?
- Typical plating option for MHC II is Black Anodize, although other options are available, such as brass and stainless steel for harsher environments.

**CABLE SELECTION FOR RECEPTACLES** — Since the MHC II is a small form factor connector, the type of fiber cable construction applied to the receptacle is an important feature. The primary element in selection process is aimed at assuring the durability of the fiber for the application. Provisioning guidelines for the various styles of fiber optic are identified below:

- **≈2.5 lbs. pull strength** — For fiber optic pigtails that will see minimal pull force (<2.5 lbs.) select 900µm fiber. For 900µm pigtails, select either Jam-Nut-Internal, Jam-Nut-External or Flange Mount.
- **≈20 lbs. pull strength** — For fiber optic pigtails that may see moderate pull force (<20 lbs.) select Jam-Nut-Internal, Jam-Nut-External or Flange Mount and either CCMK00B (4CH) or CCMK00D (8CH) loose tube furcation kits for 4CH or 8CH receptacles, respectively.
- **≈200 lbs. pull strength** — For fiber optic pigtails that require high pull force (200 lbs.) select either Jam-Nut-External with Integrated Strain Relief or Flange Mount with Integrated Strain Relief and select a 2, 4, 6 or 8 breakout or distribution (B, BX, D, DX) style fiber cable. If D or DX distribution cable is selected, furcation tubing will be necessary to build out the simplex connector pigtails.

**PROVISIONING THE PLUG INTERCONNECT** — The PLUG interconnect is typically provisioned with multi-fiber cable and establishes the communication path between two enclosures, shelters or racks. It is typically provisioned with a fixed length of fiber cable and with two PLUGs (ex: PLUG to PLUG). The PLUG assembly can be provisioned as a PLUG to PLUG assembly or PLUG to PIGTAIL assembly. Information necessary to provision the PLUG-PLUG assemblies includes:

- How many channels are required (from receptacle model)?
- MHC II features two shell sizes: 4CH and 8CH.
- What type of fiber is required (from receptacle model)?
- How long does the PLUG-PLUG interconnect need to be?
- What type of environment will the cable be subjected to (indoor/outdoor, chemicals, extreme temperature, other)?
- Dust Caps are standard on Plug connectors.
- The plating option typically tracks the plating option of the receptacle.
- To maintain the cable select one of the many MARS reels and accessories.

## (6.7e) MHC® II Cable Assemblies – What to Know When Ordering

**LOCKING OR SPRING ACTUATED COUPLING NUT** — The MHC II PLUG features two styles of couplings: (1) A locking coupling nut or (2) a spring actuated coupling nut for quick connect/disconnect. Select the best solution for the application.

- **Fixed or Semi-Permanent Installations** — The MHC II plug with locking couple nut is typically used in permanent or semi-permanent installations. For these applications the locking nut is rotated to lock down the coupling nut with receptacle or another plug. The MHC II plug can support up to 400 lbs. of pull force and sustain optical continuity under load, when locked into position.
- **Deployable Installations** — The MHC II Plug with spring actuated coupling nut is typically used in applications where systems are continually deployed on a regular basis. The spring actuated coupling nut allows quick, confident mating with a MHC II receptacle or another plug. Though the plug can sustain up to 400 lbs. of pull force (when used with OCC fiber), there is a possibility that optical disconnect can occur if more than 15 lbs. of pull force is applied to the cable.

## FIBER OPTIC AND COPPER HYBRID: What to know when ordering MHC II Hybrid Fiber Optic + Electrical assemblies:

**PROVISIONING HYBRID RECEPTACLES** – Hybrid receptacles include a combination of fiber optic and electrical connectivity and, as such, require specific considerations. Provisioning the fiber optic portion of the receptacle is identical to the guidelines identified above. However, the electrical portion of the hybrid receptacle is more involved due to the fact that these are hermaphroditic assemblies. To help prevent electrical shock from the contacting of power conductors, the RECEPTACLE on the source end of the power is typically a SOCKET CONTACT which is inside the insulated insert. The user must understand that when provisioning electrical supply to the socket contacts of the source receptacle, the hermaphroditic PIN OUT of the interconnect system ends up supplying power to the pin contacts of the destination (or sink) receptacle. These results in two different configurations of the receptacles in the hybrid fiber optic interconnect solution.

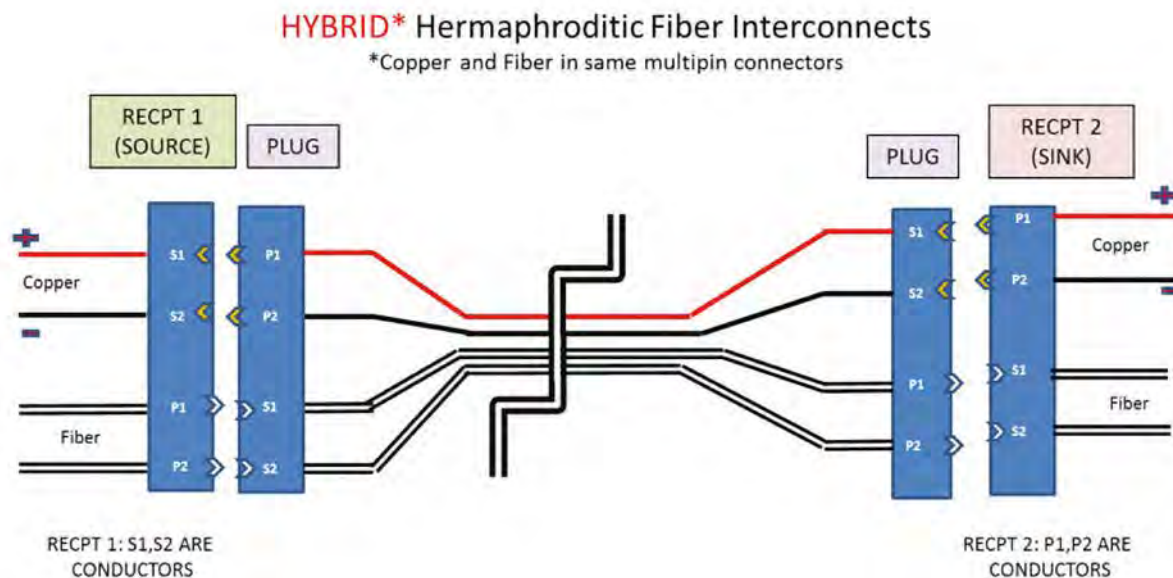

Information needed to Provision a Hybrid Receptacle can include:

- What type of power transmission is required (DC; DC+ GRD; AC 1PHASE+2 WIRE; AC 1PHASE+3WIRE; AC 3PHASE+4WIRE)?
- What is the voltage requirement on the load end?
- What is the full load current on the load end?
- Is grounding required?
- Is there a need to prevent electrical shock (in other words there is no fail safe power cutoff)?
- What are the lengths of the copper pigtailed? What, if any, terminals required on copper pigtailed?
- What is the length of fiber pigtailed? What fiber connectors are required on pigtailed (SC, LC, MTP, ST)?
- A dust cap may be necessary to keep dust from penetrating the connectors when not mated.
- Typical plating option for MHC II is Black Anodize, although other options include brass and stainless steel for harsher environments.
- Are there any specific ratings for the type of copper conductors (solid; stranded; MIL-Spec; Commercial)?
- Are there any specific industry rating requirements for the interconnect system?



## (6.7e) MHC® II Cable Assemblies – What to Know When Ordering

Information needed to Provision a Hybrid Receptacle can include:

- What type of power transmission is required (DC; DC+ GRD; AC 1PHASE+2 WIRE; AC 1PHASE+3WIRE; AC 3PHASE+4WIRE)?
- What is the voltage requirement on the load end?
- What is the full load current on the load end?
- Is grounding required?
- Is there a need to prevent electrical shock (in other words there is no fail safe power cutoff)?
- What are the lengths of the copper pigtails? What, if any, terminals required on copper pigtails?
- What is the length of fiber pigtails? What fiber connectors are required on pigtails (SC, LC, MTP, ST)?
- A dust cap may be necessary to keep dust from penetrating the connectors when not mated.
- Typical plating option for MHC II is Black Anodize, although other options include brass and stainless steel for harsher environments.
- Are there any specific ratings for the type of copper conductors (solid; stranded; MIL-Spec; Commercial)?
- Are there any specific industry rating requirements for the interconnect system?

**PROVISIONING THE HYBRID PLUG Interconnect** — Hybrid PLUG interconnects include a combination of fiber optic and electrical connectivity and, as such, require specific considerations similar to the hybrid receptacles above. Provisioning the fiber optic portion of the PLUG interconnect is identical to the guidelines identified above. However, the electrical portion of the composite PLUG interconnect is more involved. For example, to prevent electrical shock from touching power conductors, the PLUG end connecting to the power source receptacle is a MALE so as to mate with a FEMALE RECEPTACLE that may be powered, but would have socket contacts below the insert surface. The opposite end of the cable interconnect is provisioned as PLUG, FEMALE, once again with socket contacts below the insert surface, to prevent electrical shock.

Again, the electrical requirements for the hybrid PLUG interconnect are similar to the electrical requirements of the hybrid receptacle:

- What type of power transmission is required (DC; DC+ GRD; AC 1PHASE+2 WIRE; AC 1PHASE+3WIRE; AC 3PHASE+4WIRE)?
- What is the voltage requirement on the load end?
- What is the full load current on the load end?
- Is grounding required?
- Is there a need to prevent electrical shock (there is no fail safe power cutoff)?
- What is the length of the PLUG interconnect?
- A dust cap may be necessary to keep dust from penetrating the connectors when not mated.
- Are there any specific ratings for the type of copper conductors (solid; stranded; MIL-Spec; Commercial)?
- Are there any specific industry rating requirements for the interconnect system?
- To maintain the cable, select one of the many MARS reels and accessory options.

For all composite applications maximum power transmission and voltage drop should be calculated across the either cable span. Please contact the OCC factory Application Engineer for assistance with the application. Please call 1-800-622-7711 and ask for a Sales Representative. We're ready to assist you.

## Product Options for a Complete MHC II Solution



Plug-to-Plug Cable Assembly  
on OCC MARS Reel



Harsh Environment Enclosures



MARS Reels Accessories

## (6.7f) MHC® III Cable Assemblies



### Applications

- Network (Audio, Data, or DMX) Professional Equipment
- Digital HD Video Transmissions Using Fiber Optic Media
- Future-Proof Installations Designed to Eliminate Bandwidth Limitations
- Noise and EMI Protection on Audio or Video (LED Wall) Applications
- Deployable Broadcast Systems
- Remote Monitoring Sites
- Robotic Arms and Devices
- Industrial Monitoring
- Distributed Antenna Systems (DAS)
- RF Over Fiber Optic
- Cell Tower – Packet Radio

### Overview

OCC's new patent-pending MHC® III is the next generation in compact, high-density, fiber optic connectors. Utilizing environmentally-protected MT ferrule technology, the MHC III can deliver up to 24 fibers in a 30% smaller footprint than traditional cylindrical connectors. Coupled with OCC's proven hermaphroditic platform, MHC III can effectively reduce installation times and ensure superior optical performance. With its variety of options and ruggedized features, OCC's MHC III delivers high-speed communications critical for today's ever-increasing bandwidth requirements.

### Features & Benefits

When considering a reliable solution for high-channel count communications, OCC's MHC III can provide:

- **Compact, high-density MT technology for more connections in a smaller space.** The MHC III takes advantage of MT ferrule technology and delivers higher channel counts in a smaller footprint. Its unique connector design effectively decreases the amount of space needed to connect 12 and 24 channels.
- **Installations that are simplified – reducing time, effort and costs.** By utilizing proven MT technology, termination of up to 24 fibers with one connection drastically reduces installation times and the costs associated with those terminations. OCC's hermaphroditic design easily allows MHC III connectors to be mated regardless of connector gender and offers point-to-point connections seamlessly. In addition, features such as an integrated pulling eye that assists with difficult cable pulls make the MHC III an ideal choice to ensure easy installations.
- **Ruggedized construction that provides reliable optical performance and trusted environmental and mechanical capabilities.** The MHC III's all-metal construction ensures that connections can withstand wide temperature ranges and provide extreme impact resistance. An IP-68 rating reinforces the robust nature of the MHC III and keeps data transmissions well protected against dirt, dust and water. Additionally, when paired with OCC's MT optimized cables, the MHC III provides a reliable solution for any harsh environment application.
- **A variety of options to meet any application.** The multitude of choices available with the MHC III provides greater flexibility when configuring communication systems. Available in multimode, single-mode and APC single-mode, the MHC III can be provisioned in various hermaphroditic plug and receptacle options. For applications that will encounter high vibration or for more fixed and permanent installations, the MHC III plug configured with the locking coupling nut is ideal. However, if your application requires quick and easy connects and disconnects, the MHC III plug can be provisioned with the spring actuated coupling nut. Standard MHC III plugs and receptacles are a black anodized aluminum, however, they are also available in alternative plating and base materials to match the application, including Nickel-Teflon, Marine Brass and Stainless Steel.



## (6.7f) MHC® III Cable Assemblies – Features and Benefits



Robust metal shell construction and strain relief enables MHC III to survive harsh environments.



Bayonet coupling with red locking nut allows quick and easy connections in just two steps. Ideal for fixed or permanent installations.



Spring actuated coupling nut allows quick connects in a quarter turn. Ideal for applications that require quick connects and disconnects.



Hermaphroditic connectivity enables plugs to be mated with receptacles or plug-to-plug segments in a daisy-chain series.



MHC III receptacles can accommodate 2.0mm furcated fiber or standard distribution or breakout simplex cable pigtails.



The MHC III can be cleaned using MT ferrule OneClick cleaning tools in conjunction with an OCC provided adapter.



Plug strength exceeds 300 lb tensile load when utilizing OCC's MT Optimized Distribution or Breakout style cables.



Pulling eye dustcap enables pre-terminated assemblies to be pulled easily through conduit spaces.



Internal gaskets and O-rings help protect the MHC III in harsh environments and liquid submersions. IP-68 rated.



## (6.7f) MHC® III Cable Assemblies – Performance Specifications

## Performance Specifications

PARAMETER	SPECIFICATION	PERFORMANCE
Insertion loss (UPC) Multimode	TIA-455-171	0.35dB – typical, 0.50dB – max.
Return loss (UPC) Multimode	TIA-455-107	Min. -30dB
Insertion loss (APC) Single-mode	TIA-455-171	0.35dB – typical, 0.50dB – max.
Return loss (APC) Single-mode	TIA-455-107	Min. -60dB
Operational temperature	TIA-455-5	-40°C to +85°C
Storage temperature	TIA-455-5	-40°C to +85°C
Temperature humidity cycling	TIA-455-5	-40°C to +71°C at 95% RH, 240 hrs.
Dust test	IEC 60529 IP68	8 hrs. dust exposure with 20 mbar
Water submersion	IEC 60529 IP68	48hrs. immersion/1 meter water
Cable retention <sup>1</sup>	TIA-455-6	300 lbs. for 10 minutes
Mating durability	TIA-455-21	500 cycles
Impact	TIA-455-2	8 drops, 2.4 meters
Vibration	TIA-455-11	10-55Hz, 2 hrs./axis, 3 axis
Mechanical shock	TIA-455-14	Condition C, 5 shocks/axis
Crush	TIA-455-26	450 lbs.
Corrosion resistance	TIA-455-16	500 hrs.

**NOTES:**

<sup>1</sup> Tested with OCC's ruggedized HC-Series and Distribution "EZ-Strip" cable. OCC MT Optimized cables coupled with MHC III connectors allow for cable retrieval and deployment, bending and rotational twisting that is not achievable with standard ribbonized fiber cables.



## (6.7f) MHC® III Cable Assemblies – Ordering Information

### Assembly Ordering — MHC III

OCC offers a diverse complement of harsh environment connectors that meet almost any application need. The MHC III product line is designed to be a high density, small form factor, deployable style, harsh environment fiber optic interconnect solution. Since the MHC III is designed with US Conec brand MT ferrules, it is ideal for applications that require 250µm buffer fiber members or MTP pigtails. MHC III systems are typically designed with two panel mounted receptacle assemblies, connected together with a PLUG-PLUG cable assembly. Since the MHC III PLUG can instantly convert from a MALE PLUG to a FEMALE IN-LINE PLUG, most applications are solved with PLUG to PLUG fiber optic assemblies. Our state-of-the-art facility can provision any combination of MHC III connectors with 12-, 24-, or 48-Channel requirements. These customized cable assemblies are specific to each application and must be engineered to meet all requirements.

**PROVISIONING RECEPTACLES** — The receptacle is the panel/enclosure interface between the active devices (transceivers, SFPs, routers, switches, etc.) and a portal to the interconnecting PLUG-PLUG assembly connecting the two systems together. MHC III is available currently in 12-, 24-, or 48-Channel configurations. Information necessary to provision the receptacle assemblies includes:

- How many fibers are necessary to interconnect to the active systems? (1 Fiber=1 Channel)
- What type of simplex/duplex/multifiber connectors are on the end of the pigtails (LC, SC, MTP (M), MTP (F), ST)?
- What type fiber (50/125µm, 62.5/125µm, 9/125µm or combination of fiber types)?
- Length of pigtails?
- How is the receptacle mounted to the enclosure or panel (inside to out, outside to in, flange mount)?
- Typical plating option for MHC III is hard anodize, although other options, including brass and stainless steel, are available as custom solutions.

**PROVISIONING FIBER OPTIC PIGTAILS** — Since the MHC III is a small form factor connector, the type and style of fiber cable pigtails are limited. Provisioning gridlines for the various styles of MHC III receptacle and pigtail accommodation are listed below:

- **Pre-Terminated Pigtails:** MHC III receptacles are available to accommodate pre-terminated MTP assemblies without the MTP housing. Three styles of receptacle include: JAM-NUT RECEPTACLE- INTERNAL MOUNT; JAM-NUT RECEPTACLE-EXTERNAL MOUNT; or FLANGE MOUNT RECEPTACLE. MTP assemblies with various style of connector pigtail (ST, SC, LC, FC, MTP) can be pre-terminated, pre-tested and plugged into the rear of these style receptacles. OCC recommends that application of these plug-and-play receptacles be limited to OM1 (62.5/125µm) and OM2, OM3 and OM4 (50/125µm).
- **Strain Relief Receptacle (SRR):** MHC III provides two styles of RECEPTACLE with INTEGRATED STRAIN RELIEF. These include JAM-NUT RECEPTACLE-EXTERNAL MOUNT w/SR AND FLANGE MOUNT RECEPTACLE w/SR. These styles of SRR utilize OCC HC fiber cable to form pigtails and include ST, SC, LC, FC & MT connector options. All types of fiber optic are available, including OM1 (62.5/125µm) and OM2, OM3 and OM4 (50/125µm) as well as Single-Mode (9/125µm).

**PROVISIONING THE PLUG INTERCONNECT** — The PLUG interconnect is typically provisioned with multifiber jacketed cable and establishes the communication path between two enclosures, shelters or racks. It is typically provisioned with a fixed length of fiber cable and provisioned with two PLUGs (ex: PLUG to PLUG). The PLUG interconnect can be provisioned as a PLUG to PLUG or PLUG to pigtail assembly. Information necessary to provision the PLUG-PLUG assemblies include:

- How many fibers are required (from receptacle model)? (1 Fiber=1 Channel)
- MHC III is available in 12-, 24- and 48-CH configurations.
- What type of fiber is required (from receptacle model)?
- How long does the PLUG-PLUG interconnect need to be?
- What type of environment will the cable be subjected to (indoor/outdoor, chemicals, extreme temperature)?
- The plating option typically tracks the plating option of the receptacle.
- To maintain the cable select one of the many MARS reels and accessories.

**LOCKING OR SPRING ACTUATED COUPLING NUT** — The MHC III plug features two styles of couplings. These are (1) a locking couple nut to retain the optical connection during cable pull out or (2) a spring actuated coupling nut for quick connect/disconnect. Select the best solution for the application as illustrated below:

- **Deployable Installations** — The MHC III plug with spring actuated coupling nut is typically used in applications where systems are continually deployed on a regular basis. The spring actuated coupling nut allows quick, confident mating with a MHC III receptacle or another plug. Though the plug with its integral strain relief can sustain up to 400 lbs. of pull force on the cable, optical disconnect occurs at 9 lbs. and must be considered when engineering the application.
- **Fixed or Semi-Permanent Installations** — The MHC III plug with locking couple nut is typically used in permanent or semi-permanent installations. For these applications the locking nut is rotated to lock down the coupling nut when mated with a receptacle or another plug. The MHC III plug can support up to 400 lbs. of pull force and sustain optical continuity under load when locked into position.

For support for more applications please contact the OCC factory Application Engineer for assistance to help with the application. Call 1-800-622-7711 and ask for a Sales Representative. We're ready to assist you.

## (6.7g) Expanded Beam Cable Assemblies



### Applications

- Military Communications
- Deployable Broadcast
- Oil & Gas
- Mining
- Industrial Applications

### Overview

OCC's new Expanded Beam Cable Assemblies provide proven reliability and optical performance for military and harsh environment applications. Available in 2- and 4-channel variations, the OCC Expanded Beam Assemblies utilize a unique termination process that simplifies ferrule alignment and makes field repairs and terminations much quicker. Its hermaphroditic design allows this connector to be easily mated without regard for male or female gender of the interfacing connector. And as a natural complement to OCC's existing family of ruggedized connectors and cable assemblies, the Expanded Beam product line offers just another versatile option for fiber optic communications in adverse environments.

### Features & Benefits

- **Ideal for reliable optical performance in challenging environments.** OCC's Expanded Beam connectors meet the physical and functional requirements of MIL-DTL-83526/20/21 and have been tested and proven to be intermateable with other connectors that conform to MIL-DTL-83526/20/21. They are capable of withstanding extreme environmental conditions in mated or unmated states. By utilizing lenses to expand and then collect the light beam, these connectors are less sensitive to dust particles, vibration and temperature changes. This increased durability and better reliability in adverse climates enables OCC's Expanded Beam assemblies to allow more mating cycles, decrease signal deterioration and extend the overall product life cycle.
- **Easy maintenance and field repair.** Using standard fiber optic termination tools, the OCC Expanded Beam connector family is factory terminated using industry standard epoxy and polishing techniques. This enables the polished ferrules to be easily removed from the Expanded Beam insert for connector re-use or repair. In the unlikely event that the insert should become damaged in service, it can be replaced quickly and simply without the need to re-terminate the fibers.
- **Hermaphroditic design enables uncomplicated connections.** The genderless mating or hermaphroditic design of the Expanded Beam connector allows plugs and receptacles to be mated easily without regard to the gender. This design also allows two plugs to be mated together for end-to-end connections. These features make the Expanded Beam product line an ideal choice for military tactical communications, mining, deployable broadcast and other applications where quick connections are essential.
- **Versatile options for a full solution.** OCC's Expanded Beam offerings are a natural complement to the existing family of ruggedized and harsh environment components and assemblies OCC has to offer. Available in single-mode or multimode, 2- or 4-channels, the Expanded Beam cable assembly can be provisioned to suit a wide range of environments and applications. Coupled with OCC's proven mil-tac and harsh environment fiber optic cable, as well as the diverse set of MARS Reels and accessories, the Expanded Beam product family provides a high-performing solution designed to take on the most demanding applications.

## (6.7g) Expanded Beam Cable Assemblies – Performance Specifications



### Performance Specifications

PARAMETER	SPECIFICATION	PERFORMANCE
Insertion loss (multimode)	TIA-455-171	0.70dB – Typical, 1.00dB – Maximum
Insertion loss (single-mode)	TIA-455-171	1.00dB – Typical, 1.50dB – Maximum
Return loss	TIA-455-171	>32dB (typical 40dB) single-mode ; >20dB multimode
Operating temperature	TIA-455-5	-55°C to +85°C
Storage temperature	TIA-455-5	-55°C to +85°C
Mating durability	TIA-455-21	3,000 cycles
Cable retention (Mil. Req.)	TIA-455-6	300 lbs. min. (Cable dependant)
Crush resistance	TIA-455-26	1,500 lbs.
Vibration	TIA-455-1	10-500Hz, 3 directions, 0.75mm amp @ 10g acceleration
Water submersion	IEC 60529 IP68	15 meters



### What to Know When Ordering?

**How many channels will I need?**

The OCC Expanded Beam can accommodate 2 and 4 channel counts.

**Do you require a plug-to-plug assembly or a plug or bulkhead to discrete connector assembly?**

OCC has the capabilities to provision each type of assembly. If you are requiring an Expanded Beam plug-to-plug assembly, simply contact us with the channel counts and information about the installation environment. If you require a plug or bulkhead to discrete connector assembly, we will need to know what type of connector (LC, SC, ST, etc.) you require. If you have questions about how to order these types of assemblies, give us a call and we can walk you through the process to find the best solution for your need.

**What type of cable is required?**

Various cable types are available to meet any application and OCC can provision any assembly to the specific length that meets your need. Contact OCC Sales for help determining the best cable for your application.

**Do you need easy field deployment?**

Do you need easy field deployment? OCC has a variety of options to help with deploying your Expanded Beam cable assemblies. Contact OCC Sales to learn about our MARS reels, Integrated Cleaning Kits for Expanded Beam Connectors and all the deployable accessories for the MARS Reel. Together we can find the right options for your requirements.

Please call 1-800-622-7711 and ask for a Sales Representative. We're ready to assist you.



 (6.7h) IRIS™ Cable Assemblies

### Overview

OCC's patented IRIS™ is a revolutionary fiber optic interconnect system for traffic-control enclosures and cabinets that disengages upon impact, protecting the installed fiber plant from destruction. IRIS allows for a fully restored fiber optic connection to be made, without field repair or re-termination of the fiber optic cable. Most importantly, IRIS protects the installed fiber plant from damage when the control enclosure is impacted, so it should be considered as a key component of any wide area disaster recovery plan.

IRIS is especially suited for Intelligent Transportation Systems that encompass a broad range of wireless (ITS), fiber optic communications-based information, control, and electronic technologies. When integrated into the transportation system infrastructure, these technologies help monitor and manage traffic flow; reduce congestion; provide alternate routes to travelers; enhance productivity; and save time, money and lives.

Destruction of a traffic-control cabinet results in lost synchronization, productivity and time, as well as the loss of thousands of dollars to repair multiple fiber optic cables at any given intersection. Protecting the installed fiber plant with IRIS greatly reduces the impact from both financial and out-of-service conditions.

### Features & Benefits:

- **Protects fiber connectivity, while minimizing collateral damage and downtime.** Designed to sense mechanical axial and shear loads from within the control enclosure, IRIS's patented technology releases and separates, protecting the installed fiber plant. When the sensing ring is pulled by a horizontal force within a 360° horizon, the mechanical latch surrounding the engaged fiber optic connector is tripped. The multi-channel fiber optic connector disengages and retracts under positive pressure, ejecting the plug to break away from the receptacle in milliseconds, thereby avoiding collateral damage.
- **Withstands day-to-day environmental stresses.** The IRIS system operates flawlessly within harsh environments and will survive temporary submersion due to flooding. The sealing features also prevent accumulation of dust and debris, which reduces the need for repeated, costly field maintenance.
- **Designed for multiple, efficient connections.** The IRIS system can accommodate up to 12 fiber optic channels. For ITS applications, the plug side of IRIS features 6 ft. pigtailed with choice of ST, SC or LC simplex connectors. IRIS allows installation of pretested fiber optic assemblies within minutes. Typical installation allows the receptacle pigtail to be spliced into the fiber plant, and the plug/receptacle connectors are all pre-terminated and test verified for easy installation.



## (6.7h) IRIS™ Cable Assemblies – Features and Benefits



IRIS protects the outside plant investment by disengaging upon mechanical impact and is easily restored by rearming the IRIS connector installed within a new enclosure.



IRIS can operate within harsh environments and can survive temporary submersible conditions. Sealing features prevent dust and debris accumulation to extend the life cycle.



Mechanical triggering system enables fiber connector to disengage rapidly without damaging the fiber optic contacts.



IRIS' sensing ring tethered to the cabinet enables IRIS to be triggered upon impact from all four quadrants or 360°.



IRIS' arming ring (shown here in red for demonstration purposes only) allows field service personnel to safely rearm or service the system without accidentally triggering the connector.



Turn-key pretested fiber optic assemblies enable efficient installations within minutes. The receptacle pigtail is spliced into the fiber plant. The plug connectors are all pre-terminated.



The IRIS system can accommodate up to 12 single-mode or multimode fiber optic channels. For ITS applications, the plug side of IRIS features 6 ft. pigtails with choice of ST, SC, or LC simplex connectors. The receptacle side is purchased with choice of fiber count and length of blunt end.



Hand operated tool available for simple and quick rearming of the IRIS connector.



## (6.7h) IRIS™ Cable Assemblies – Performance Specifications

## Performance Specifications

PARAMETER	SPECIFICATION	PERFORMANCE
Insertion loss (single-mode)	TIA 455-171	0.35dB – Typical, 0.50dB – max.
Operating temperature	TIA-455-5	-46°C to 85°C
Storage temperature	TIA-455-5	-62°C to 85°C
Cable retention <sup>1</sup>	TIA-455-6	200 lbs. for 10 min.
Cable sealing	TIA-455-1	Procedure I
Twist	TIA-455-36	100 cycles, ±90° twist
Mating durability	TIA-455-21	500 cycles
Impact <sup>2</sup>	TIA-455-2	Method B, 8 drops
Vibration	TIA-455-11	Condition C, 1.5 hrs./axis
Mechanical shock	TIA-455-14	Condition C, 5 shocks/axis
Thermal shock	TIA-455-71	Schedule C, -62°C 85°C, 5 cycles
Temperature humidity cycling	TIA-455-4	65°C at 95% RH
Life aging	TIA-455-11	85°C, 250 hrs.
Water pressure	TIA-455-98	Method A, Procedure A, 1M–24 hrs.
Sand and dust	TIA-455-35	16 hrs.
Salt spray	TIA-455-16	Condition C, 250 hrs.

## Cost Analysis – No IRIS

SCENARIO	COMPONENT FAILURE	RESULT OF FAILURE	ESTIMATED RESTORE TIME	ESTIMATED RESTORE COST
Vehicle hits cabinet, dislodging it from its pedestal	Drop cable is pulled back from splice point or patch cables do not break away	Destroyed drop cable and possible damage to splice case and main fiber trunk; broken patch cables must be replaced or electronics destroyed	4 to 14 hours (if electronics, patch cable or drop cable is in stock)	\$600.00 to \$10,000.00 (depending on extent of damage)
Flood fills cabinet above fiber connection	Connector is backfilled with muddy water	System incapable of transmission	8 hours (after flood water subsides)	\$2,750.00 (includes connector interface replacement)
Dust storm penetrates cabinet	Connector becomes contaminated with dust	System incapable of transmission	4 hours	\$450.00

**ESTIMATED DAMAGE MODEL \$3,800.00 MINIMUM**

## Cost Analysis – With IRIS

SCENARIO	COMPONENT FAILURE	RESULT OF FAILURE	ESTIMATED RESTORE TIME	ESTIMATED RESTORE COST
Vehicle hits cabinet, dislodging it from its pedestal	None – IRIS connector trips. Backbone, drop cable and electronics stay intact	Temporary loss of signal	5 minutes (after cabinet is reset)	\$35.00
Flood fills cabinet above fiber connection	None	No loss of signal	0 hours	\$0.00
Dust storm penetrates cabinet	None	No loss of signal	0 hours	\$0.00

**ESTIMATED DAMAGE MODEL \$35.00 MINIMUM**

## (6.7h) IRIS™ Cable Assemblies – Ordering Information

### Assembly Ordering – IRIS

The OCC IRIS solution is a turn-key pre-tested fiber optic assembly system. It is designed to be ordered as a receptacle pigtail assembly and a plug/receptacle connector assembly. By ordering the IRIS system this way, you can be assured that you are receiving guaranteed performance and a simplified installation process. Our state-of-the-art facility can integrate the OCC IRIS connector into a customized cable assembly specific to your application requirements. Couple that with one of OCC's innovative deployment options and OCC can provide a complete system solution is easily installed and gets your system up and running fast.

### What to know when ordering an IRIS cable assembly:

#### How many channels will I need?

IRIS plug connectors can accommodate up to 12 channels.

#### What type of assemblies do I need?

Typically you will need both a plug and a receptacle assembly. The IRIS receptacle assembly can be provisioned with the IRIS receptacle on one end and blunt ends on the other to enable splicing into the fiber optic outside plant. The plug assembly can be provisioned with the IRIS plug on one end and discrete connectors (LC, SC, or ST) on the other end. The discrete ends can then be plugged in to any monitoring or active equipment required. If you have questions about how to order these types of assemblies, give us a call and we can walk you through the process to find the best solution for your need.

#### What type of cable do you prefer and what length?

Various cable types are available to meet any application, and OCC can provision any assembly to the specific length that meets your need including armored and rodent resistant cables. Additionally, OCC offers a wide variety of fiber types including 9/125µm, 62.5/125µm, OM3, OM4 and more. Contact OCC Sales for help determining the best cable for your application.

Call 1-800-622-7711 and ask for a Sales Representative. We're ready to assist you.



### IRIS Accessories

PART NUMBER	PRODUCT DESCRIPTION
T12000-99-001	IRIS arming tool
IR-CP709-2	IRIS conduit kit for traffic cabinet installations includes 9 ft. of braided steel trip wire, trip wire crimp barrels, anchor clamps and 2" conduit collar cap
IR-CP709-3	IRIS conduit kit for traffic cabinet installations includes 9 ft. of braided steel trip wire, trip wire crimp barrels, anchor clamps and 3" conduit collar cap
IR-CP709-4	IRIS conduit kit for traffic cabinet installations includes 9 ft. of braided steel trip wire, trip wire crimp barrels, anchor clamps and 4" conduit collar cap

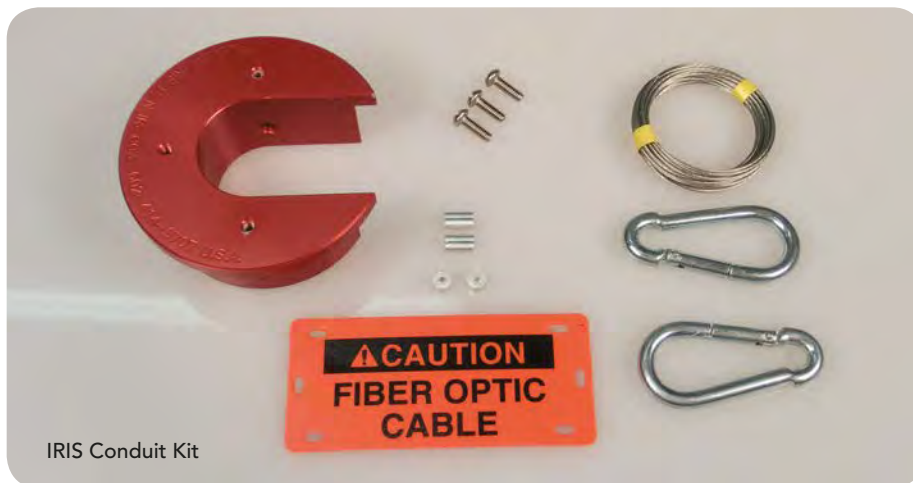

IRIS Conduit Kit

## (6.7i) L-JACK™ Cable Assemblies



### Applications

- CATV, LAN, WAN, and PONS
- Telecommunications
- Remote Radio Heads (RRH)
- Data Center and Processing Networks
- Fiber-to-the-X (FTTC, FTTH, FTTD)
- Deployable Mobile Systems

### Overview

OCC introduces L-JACK™, a robust fiber optic duplex LC connector that couples the small form factor of traditional LCs with the known ruggedness of OCC harsh environment connectors. OCC's L-JACK connector is designed for environmentally challenging situations and offers easy installation with proven optical performance. Available in a broad range of configuration possibilities, the L-JACK is ideal for installations in extreme mobile environments, industrial applications, and any install that requires excessive fiber optic protection.

### Features & Benefits

Conventional fiber optic connectors were never intended for, or able to withstand, the rough handling of deployable and harsh applications. With the OCC L-JACK fiber optic connector, users can expect:

- **Unsurpassed ruggedized connector design.** OCC's L-JACK is manufactured with optimum metal materials that can withstand wide temperature ranges and provide extreme impact resistance, unlike the competition's polymer versions. The L-JACK's robust design is ideal for almost any harsh environment application where survivability is a factor. Multiple plating options complement the resilient nature of this connector to reinforce its mechanical performance.
- **Superior optical performance.** Compliant with IEC 61540-20, Telecordia GR-326, and TIA-604-10-A standards, the L-JACK connector accommodates standard LC and is available in multimode, single-mode and single-mode APC polish. The threaded coupling ensures proper fiber alignment and reinforces positive mating of the LC connector to the receptacle.
- **IP-68 environmental sealing.** OCC's L-JACK prevents dirt and moisture from deterring optical connections and protects the duplex LC connector from harsh environments where mud and water are present.
- **Specialized strain relief for intense tensile loading.** When terminated with OCC's Distribution or Breakout style cables, the L-JACK backshell enables up to 400 lbs. of pull strength, allowing the fiber cable to withstand intense tensile loading through difficult hauls.
- **Variety of configurations to fit any application need.** Once terminated, the L-JACK plug with backshell is then used to interconnect with a variety of L-JACK receptacles, including flange-mount, jam-nut and D38999 jam-nut form receptacles.

While there are many similar types of connectors on the market, only the OCC L-JACK can bring proven durability and performance to deployable and harsh environment communications. Ideal for quick equipment connections, the L-JACK fiber optic connector is a logical choice for the most reliable communication networks.



## (6.7i) L-JACK™ Cable Assemblies – Features and Benefits



L-JACK receptacles are designed to accommodate standard LC/UPC and LC/APC duplex jumpers that have been manufactured in accordance with IEC-61540-20, Telecordia GR-326 and TIA-604-10-A connector standards.



All L-JACK receptacles and plugs provide an IP-68 compliant seal and pass IEC-60529 standards for water submersion and dust testing.



Specialized strain relief supports 400 lbs. of tension strength and provides superior cable performance compared to commercial options when utilized with OCC Distribution or Breakout style cables.



L-JACK in-line receptacles provide the ability to “daisy-chain” duplex assemblies.



L-JACK offers a variety of plug and receptacle options including flange-mount and jam-nut options.



L-JACK can be ordered as a component or as factory terminated cable assemblies provisioned with L-JACK plugs and receptacles or other OCC connector options. Contact OCC for additional ordering information. Call 1-800-622-7711 and ask for a Sales Representative. We're ready to assist you.



## (6.7i) L-JACK™ Cable Assemblies – Performance Specifications

## Performance Specifications

PARAMETER	SPECIFICATION	PERFORMANCE
Insertion loss (IL) (UPC)	TIA-455-171	0.25dB - typical, 0.50dB - max.
Return loss (RL) (UPC)	TIA-455-107	50dB minimum
Operational temperature	TIA-455-5	-40°C to +85°C
Storage temperature	TIA-455-5	-40°C to +85°C
Temperature humidity cycling	TIA-455-5	-40°C to +71°C at 95%RH, 240 hrs.
Dust test	IEC 60529 IP68	8 hrs. dust exposure with 20 mbar
Water submersion	IEC 60529 IP68	48 hrs. immersion/1 meter water
Cable retention <sup>1</sup>	TIA-455-6	400 lbs. for 10 minutes
Mating durability	TIA-455-21	500 cycles
Impact	TIA-455-2	8 drops, 2.4 meters
Vibration	TIA-455-11	10-55Hz, 2 hrs./axis, 3 axis
Mechanical shock	TIA-455-14	Condition C, 5 shocks/axis
Crush	TIA-455-26	450 lbs.
Corrosion resistance	TIA-364-83	500 hrs.

**NOTE:**

<sup>1</sup> Application of OCC D-002CSLS5KM during test



L-JACK internal jam-nut receptacle



L-JACK in-line receptacle



## (6.7i) L-JACK™ Cable Assemblies – Ordering Information

### ASSEMBLY ORDERING — L-JACK

OCC offers a diverse complement of harsh environment connectors that meet almost any application need. The L-JACK product line is a duplex, deployable style, harsh environment, fiber optic interconnect solution.

L-JACK duplex systems are typically comprised of two panel mounted RECEPTACLE assemblies, connected together by different combinations of assemblies: a PLUG-PLUG cable assembly; PLUG to IN-LINE RECEPTACLE; PLUG to DUPLEX PIGTAIL assembly; or IN-LINE RECEPTACLE to DUPLEX PIGTAIL assembly. Our state-of-the-art facility can provision any combination of L-JACK assemblies with either duplex Multimode (MM) or duplex Single-mode (SM), or one of each fiber cable. These customized cable assemblies are specific to each application and can be easily engineered to meet all requirements.

**PROVISIONING RECEPTACLES** – The receptacle is the panel/enclosure interface between the active devices (transceivers, SFPs, routers, switches, etc.) and the “external” PLUG-PLUG, PLUG to IN-LINE RECEPTACLE or PLUG to PIGTAIL assembly connecting two enclosures, shelters or racks together. The receptacle connector may be cabled to the active devices with simple duplex (zip cord) pigtail fiber cables, or with an overall breakout cable construction for added protection (and then fanned out to active devices) by using the versatile PLUG/RECEPTACLE backshell, creating a Strain Relief Receptacle (SRR), to preclude damage from cable pulling forces, if they are anticipated.

#### Information necessary to provision the RECEPTACLE assemblies includes:

- L-JACK systems are only available in duplex configurations (1 Channel=1 Fiber).
- What type of simplex/duplex connectors are on the end of the receptacle pigtails (e.g. LC, SC, ST, other)?
- What type fiber (50/125µm, 62.5/125µm, 9/125µm or a composite of fiber types)?
- Length of pigtails?
- Will the pigtails need to support ≤20 lbs. of cable pull out force? If cable pull out force needs to be higher, consider using a backshell with the Receptacle to sustain cable pull out force in excess of 100 lbs.
- Is this Receptacle cable going to be exposed to environmental conditions? What type of environment will the cable be subjected to (indoor/outdoor, chemicals, extreme temperature)? OCC engineering can assist in matching a cable construction to the application environment.
- How is the receptacle installed to the enclosure or panel (inside to out, outside to in)?
- What style of receptacle is preferred; Jam-Nut External Mounted (RLRK series); Jam-Nut, External Mounted (RLRJ series) to fit D38999/24, Shell Size 19; Flange Mount (RLRD series)? Note that the backshell can be used with any Jam-Nut Receptacle and Flange Mount Receptacle as long as it's mounted from the inside to out.
- Is there any conductive requirement for EMI grounding protection?
- Typical plating option for EZ-MATE is Black Anodize, although other material/finish options, including brass, stainless steel, and Zinc-Nickel, are available as custom solutions.
- Will the receptacle remain connected with PLUG or will it require a dust cap when PLUG is disengaged?

#### PROVISIONING RECEPTACLES PIGTAILS – Two styles of L-JACK pigtails are available:

- **For pigtail applications not in excess of 20 lbs. pull out force**, standard LC to either: LC; SC; ST; or FC duplex pigtail can be applied. Order LC duplex jumpers with suggested color coded connectors as either 50/125µm (black), 62.5/125µm (beige), 9/125µm (blue) or 9/125µm APC (green) and the length necessary to meet the application.
- **For pigtail application in excess of 100 lbs. pull out force**, specify L-JACK Receptacle backshell with either OCC A simplex or duplex, B, BE or BX series breakout cable terminated with LC, SC, ST or FC pigtails. Order LC duplex jumpers with color-coded connectors in either 50/125µm (black), 62.5/125µm (beige), 9/125µm (blue) or 9/125µm APC (green) and to length necessary to meet the application.



### (6.7i) L-JACK™ Cable Assemblies – Ordering Information

**PROVISIONING THE PLUG INTERCONNECT** – The “PLUG” interconnect is typically provisioned with duplex Distribution or Breakout series cable and establishes the communication path between two enclosures, shelters or racks. It is typically provisioned with a fixed length of fiber cable and provisioned with a plug at either end (ex: PLUG-to-PLUG), or can be other combinations such as: PLUG to IN-LINE RECEPTACLE; PLUG to duplex PIGTAIL; or IN-LINE RECEPTACLE to duplex PIGTAIL. Information necessary to provision the PLUG Interconnect assemblies include:

- Assume duplex cable only.
- What type of fiber is required (from receptacle model)?
- How long does the “PLUG” interconnect need to be?
- What type of environment will the cable be subjected to (indoor-outdoor, chemicals, extreme temperature)?  
OCC engineering can assist in matching a cable construction to the application environment.
- Plating: Typically same as from the Receptacle model above.
- Will the PLUG remain connected with RECEPTACLE or will it need dust cap when it is disengaged?
- To maintain and deploy/retrieve the cable, select one of the many MARS reels and accessories.

For more complete connector selection and configuration, please see Choosing the Right Connector on pg. 35–36.

Call 1-800-622-7711 and ask for a Sales Representative. We're ready to assist you.

## (6.7j) Single Terminus (ST) Assemblies



### Applications

- Navy Shipboard Systems
- Army and Marine Corps TAC COM
- Pierside/Ship-to-Shore Communications
- Disaster Recovery Emergency Communications
- Commercial and Military Antennas and Radars
- Mobile Tactical Shelters
- Mobile or Remote Broadcast Harsh Environments
- Oil and Gas Industries

### Overview

OCC's ruggedized ST connector and ST adapter products represent one of the best single-fiber connection systems available to industries where the ability to withstand extreme temperature change, shock, vibration, or corrosion is required. We offer both commercial-off-the-shelf (COTS) ST's for harsh environment applications and the fully qualified, Military ST (MIL) that meets or exceeds 100% of the military specification MIL-DTL-83522E.

### Features & Benefits

- Nickel-plated brass or stainless steel options are available
- Available to support single-mode and multimode fibers
- Accommodate fiber cables with outer jackets from 2.0mm to 3.0mm outer diameters
- The locking version features washers that prevent inadvertent optical disconnect due to stress on the cable, and are more resistant to cable pull force or repeated shock and/or vibration
- Up to 50 lbs. of pull strength protection is readily achievable using standard termination techniques
- A convenient screw-on boot feature eliminates the need for a cumbersome boot tool
- The MIL ST features a higher spring force that passes Navy High Shock (explosive) requirements
- A slightly lower spring force allows OCC's COTS ST connectors to provide the same optical performance as the MIL ST in standard shock and vibration while also allowing successful coupling with composite adapters and devices
- OCC's ST's feature a closed entry design which provides both easier mating when new and retains its mating profile for easier mating over repeated in field mating cycles
- Ability to inter-mate with ST connectors in the field



## (6.7j) Single Terminus (ST) Assemblies – Performance Specifications

## Performance Specifications

PARAMETER	SPECIFICATION	PERFORMANCE
Insertion loss (multimode)	MIL-STD-1678-2 Measurement 2101	0.35dB typical, 0.75dB max.
Insertion loss (single-mode)	MIL-STD-1678-2 Measurement 2101	0.40dB typical, 0.75dB max.
Return loss (single-mode)	MIL-STD-1678-2 Measurement 2105	-50dB typical, -40dB max.
Weight	Nonterminated	< 20 GR.
Operational temperature	TIA-455-5	-46°C to +85°C
Storage temperature	TIA-455-5	-62°C to +85°C
Tensile loading <sup>1</sup>	TIA-455-6	10 min, 2.1 lbs. (230N)
Flex life	TIA-455-1	2000 cycles each at 23°C ± 5°C
Twist	TIA-455-36	1000 cycles, ±90° twist from axis
Mating durability	TIA-455-21	500 cycles
Impact	TIA-455-2	Method B, 8 drops
Vibration	TIA-455-11	Measurement 3201 of MIL-STD-1678-3
Mechanical shock	MIL-S-901	Grade A Class 1, 3 blows, per axis
Thermal shock	TIA-455-71	Test Schedule 2, -62°C to +85°C
Temperature humidity cycling	TIA-455-5	Method B
Temperature cycling	MIL-DTL-98522 Section 4.8.2	92 hours
Life aging	TIA-455-5	240 hrs., 110°C ± 5°C
Sand and dust	MIL-STD-202	Method 110, no rotation of DUT
Salt spray	TIA-455-16	MIL-STD-1678-3, measurement 3402, 96 hrs.
Flammability	ECA EIA-364-81	Exposed to a .75" (19mm) flame @ 10 sec.
Fungus resistance	TIA-455-56	Measurement 3401 of MIL-STD-1678-3

## (6.7j) Single Terminus (ST) Assemblies – Ordering Information



### Nickel-Plated Brass Products

PART NUMBER	PRODUCT DESCRIPTION
M83522/16-DNX-B	MIL-ST, screw-on boot, nonlocking, multimode, nickel-plated brass
M83522/16-DNY-B	MIL-ST, screw-on boot, nonlocking, single-mode, nickel-plated brass
M83522/16-ANX-B	MIL-ST, screw-on boot, locking, multimode, nickel-plated brass
M83522/16-ANY-B	MIL-ST, screw-on boot, locking, single-mode, nickel-plated brass
M83522/16-EN	MIL-ST, dust cap
M83522/17-NY-B	MIL-ST adapter, multi- or single-mode, nickel-plated brass
SVST6011AL	COTS-ST, screw-on boot, nonlocking, multimode, nickel-plated brass
SVST6021AL	COTS-ST, screw-on boot, nonlocking, single-mode, nickel-plated brass
SVST5011AL	COTS-ST, screw-on boot, locking, multimode, nickel-plated brass
SVST5021AL	COTS-ST, screw-on boot, locking, single-mode, nickel-plated brass
SVSTB21A0	COTS-ST adapter, ceramic split sleeve, nickel-plated brass

### Stainless-Steel Products

PART NUMBER	PRODUCT DESCRIPTION
M83522/16-DNX-S	MIL-ST, screw-on boot, nonlocking, multimode, stainless steel
M83522/16-DNY-S	MIL-ST, screw-on boot, nonlocking, single-mode, stainless steel
M83522/17-NY-S	MIL-ST adapter, multi- or single-mode, stainless steel
SVST6012AL	COTS-ST, screw-on boot, multimode, stainless steel
SVST6022AL	COTS-ST, screw-on boot, single-mode, stainless steel
SVST5012AL	COTS-ST, screw-on boot, locking, multimode, stainless steel
SVST5022AL	COTS-ST, screw-on boot, locking, single-mode, stainless steel
SVSTB22A0	COTS-ST adapter, ceramic split sleeve, stainless steel

### Accessories

PART NUMBER	PRODUCT DESCRIPTION
SVSTP21A0	Metal ST dust cover with lanyard, nickel-plated brass
SVSTP22A0	Metal ST dust cover with lanyard, stainless steel
SVSTQ21A0	Metal ST adapter dust cover with lanyard, nickel-plated brass
SVSTQ22A0	Metal ST adapter dust cover with lanyard, stainless steel
SVSTK000AV-KIT	Accommodates 2.5mm to 3.0 cable O.D.
PM83522/16-22	Accommodates 1.8mm to 2.5mm cable O.D.
PC83522/16-22	Accommodates 2.5mm cable O.D.
PC83522/16-20-S	Accommodates 3.0mm cable O.D.



## (6.7j) Single Terminus (ST) Assemblies – Ordering Information

### Assembly Ordering — Single Terminus

OCC offers a diverse complement of harsh environment connectors that meet almost any application need. OCC's harsh environment MILITARY and COTS ST's (Ref: MIL-DTL-83522) are designed to perform with single fiber jacketed cable, or multi-fiber cable such as the OCC-B or OCC-BX Breakout series cable and qualified shipboard Breakout cable. They can afford customers significant value for ST-ST breakout assemblies.

**PROVISIONING ST to ST BREAKOUT ASSEMBLIES** — The OCC MIL or COTS ST connectors are designed to sustain up to 50 lbs. of cable pull out force without damage to the cable or connect, when used with OCC B or BX series or with Shipboard Simplex (MIL-PRF-85045/16) or Breakout cable (MIL-PRF-85045/8, /15, /17, /18). Guidelines for provisioning simple ST to ST cable assemblies includes:

- Mating Adapters: The type of ST adapter or device to which the ST connector will mate should be known if possible. The material the adapter is made from is the key.
  - MIL ST under the M83522 specification is designed with a high force spring to preclude optical disconnect during extreme shock events. A Metal Adapter is generally required for this application to preclude damage to the adapter.
  - COTS ST, which does not require a very high spring force, can be successfully mated to a composite (plastic) or metal adapter.
- Is this a single fiber point to point termination or a multifiber cable termination?
  - If single-fiber termination, what is the O.D. of the single fiber jacket?
  - If multifiber cable termination, what is the O.D. of the single fiber subunit (a.k.a.: OFCC).
  - Do the cables to be terminated have aramid strength members under these jackets?
- OCC ST Adapters (both MIL and COTS) are readily available in metal versions for mating to virtually any ST connector.
- What type of fiber (50/125µm, 62.5/125µm, 9/125µm, or other unique fiber needs)?
- Length of the overall cable assembly (including breakout length of pigtails)?
- Material selection: Military standard (MIL-DTL-83522) and COTS ST are supplied in Nickel Plated Brass (N.P.B) which resists most harsh environments and is a Navy Qualified product. For more severe corrosive environments, order Stainless Steel versions of either MIL or COTS ST's. OCC's Stainless Steel STs are also a Navy-Qualified product.
- NON-LOCKING vs. LOCKING BOOT — Military standard (MIL-DTL-83522) and COTS ST are typically supplied with a "non-locking" boot to allow the user to engage and dis-engage the ST bayonet normally. Though convenient, this spring loaded Bayonet ST is subject to optical disconnect if the cable is pulled on from the rear of the ST connector. If optical disconnect is not tolerated within the application, select Locking Boot style STs. Locking Boot's function is to prevent optical disconnects due to cable pulling. Locking Boot STs are installed by un-screwing the threaded boot a few turns, engaging the bayonet with the ST Adapter and then screwing the boot back into place. Un-installing the Locking Boot ST requires reversing that procedure.
- DUST CAPS – If the ST to ST assembly is demated/mated often, consider provisioning an ST Dust Cap with each terminated ST, to protect from dust and damage when unmated. Dust Caps with lanyard attachments are also available for OCC ST Adapters.
- OCC Engineering can assist with any compatibility questions with specific or unique cable or fiber combinations. Please contact your OCC representative with any compatibility or application questions.

For more complete connector selection and configuration, please see Choosing the Right Connector on pg. 35–36.

Call 1-800-622-7711 and ask for a Sales Representative. We're ready to assist you.





## Made-to-Order Standard Trunk Cables

Smaller diameter, higher density MPO (MTP® compatible) Nano trunk multicore cable assemblies streamline installation and reduce total cost for facilities that require high density backbone cabling.

Application examples consist of the following:

- Data Centers
- Passive Optical LAN applications
- High Density Industrial
- Broadcast/AV
- Extreme Performance Requirement Applications
- Security/Monitoring



OCC offers a wide variety of MPO-MTP multi-fiber cable assemblies including:

- Arrays for cassettes
- Panels
- MPO/MTP fanouts
- Spanning MDA, HDA and EDA zones

There are many benefits to pre-terminated trunk cable assemblies:

- Smaller size
- Higher density
- Reduces installation time
- Reduces labor costs
- Indoor and outdoor applications
- Temperature and water-resistant
- Tested to customer performance requirements prior to leaving factory

OCC manufactures a wide variety of cable constructions as required by even the most demanding application. In addition to standard enterprise type connectors, OCC manufactures many harsh environment connectors that can be terminated on our cable at the factory.

Contact the OCC team of cable experts to help customize your pre-terminated cable assembly and leverage the advantages of lower total cost and faster installation.

MTP is a registered trademark of US Conec, Ltd.

## Information required to customize your pre-terminated fiber assembly:

Cable construction	See Section 3.0 Product Information
Fiber type	See Laser Ultra-Fox Fiber Performance Table, pg. 331
Fiber count	See available fiber counts based upon cable construction
Cable length	Most pre-terminated cable assemblies can be built to your length requirements and various reel put ups
Connector type on each end	See Enterprise Connectors, Section 6.2, pg. 235–236
Pulling Kits	Are pulling kits required on one or both ends of the cable assembly?



(6.7k) Made-to-Order Multifiber Trunk Cable Assemblies

### Ordering Information

Due to the custom nature of this product, contact OCC Sales for ordering information. Please call 1-800-622-7711 and ask for a Sales Representative. We're ready to assist you.

## (6.8a) Cleaners and Tools

### Fiber Optic Cleaners

To complement our connectors, OCC offers dry-cloth cleaners specifically designed to clean single-fiber connectors. Each cleaner is easy to use and very effective at eliminating contaminants that can deter optical performance.

- Cleaning system rotates 180° for a complete sweep
- Easy pushing motion employs connector and commences cleaner
- Disposable with 525+ cleanings per unit



PART NUMBER	DESCRIPTION
FC-SCK-LC-125	Fiber Optic Cleaner, LC-MU
FC-SCK-SC-250	Fiber Optic Cleaner, SC-FC-ST



### Fiber Strippers and Cleavers

To create a full solution, OCC offers fiber strippers and cleavers to assist in field fiber polishes and terminations. These tools, necessary for any fiber optic project installation, are backed by OCC's 15-year product warranty and are a value-added component to the OCC fiber product line.



PART NUMBER	DESCRIPTION
FOCT	Precision fiber cleaver
FOST	Fiber stripper
FOHC-SLT	Fiber stripper, 2.2mm



 (6.8a) Cleaners and Tools

### Cleaning Kits

OCC has a variety of cleaning kits that correspond to popular connector styles, including MIL-DTL-83526, MIL-PRF-28876, MIL-DTL-38999, NAVSEA Pierside, MIL-C-83526 (TFOCA), F-LINK™ and TFOCA-II®. Cleaning Kits and Restoration Kits are available for 4, 6, 8, 12, 18 and 24-channel-style connectors.



PART NUMBER	CLEANING KITS
K2000-KAC00x	4/12 CH M83526
K2000-KBC00x	Expanded beam
K2000-KEC00x	4/12 CH EZ-MATE
K2000-KFC00x	F-LINK Connectors
K2000-KHC00x	Hermaphroditic/SMPTE
K2000-KJC00x	6/24 CH EZ-MATE
K2000-KNC00x	M28876
K2000-KPC00x	NAVSEA Pierside
K2000-KQC00x	2.5mm ferrule
K2000-KSC00x	1.6–2.0mm ferrule
K2000-KTC00x	2 CH TFOCA
K2000-KUC00x	1.25mm ferrule
K2000-KWC00x	MHC® II 4/8CH

In part numbers above for 100 meter reels, x = "1", all other reels use "2"

\*TFOCA-II® is a registered trademark of Amphenol Fiber Systems International.

## (6.9a) Laser Ultra-Fox™ Fiber Performance

Fiber Code <sup>7</sup>	Industry Standard Designation	Core/Cladding Diameter (µm)	Numeric Aperture	Wavelength (nm)	Gigabit Ethernet Distance (m)	10-Gigabit Ethernet Distance (m)	Max. Cabled Attenuation (dB/km)	Min. Laser EMB Bandwidth* (MHz-km)	Min. OFL LED Bandwidth** (MHz-km)
WLS	OM1 ISO/IEC 11801	62.5/125	0.275	850/1310	300/600	33/300 <sup>^</sup>	3.5/1.5	220/500	200/500
WLX	OM1+ ISO/IEC 11801	62.5/125	0.275	850/1310	500/1000	33/300 <sup>^</sup>	3.5/1.5	385/500	200/500
ALS	Laser Grade OM2 Bend Insensitive ISO/IEC 11908	50/125	0.20	850/1310	600/600	82/300 <sup>^</sup>	3.5/1.5	510/500	500/500
ALX	Extended Length Laser Grade OM2+ Bend Insensitive ISO/IEC 11801	50/125	0.20	850/1310	750/600	150/300 <sup>^2</sup>	3.0/1.0 <sup>3</sup>	950/500	700/500
ALT	Laser Optimized OM3 Bend Insensitive ISO/IEC 11801	50/125	0.20	850/1310	1000/600	300/300 <sup>^2</sup>	3.0/1.0 <sup>3</sup>	2000/500	1500/500
ALE	Laser Optimized OM4 Bend Insensitive ISO/IEC 11801	50/125	0.20	850/1310	1040/600	550 <sup>1</sup> /300 <sup>^2</sup>	3.0/1.0 <sup>3</sup>	4700/500	3500/500
SLX	Low Water Peak Single-Mode ITU-T G.652.D	9 <sup>6</sup> /125	—	1310/1550	5 km <sup>4</sup>	10 km <sup>5</sup>	0.5/0.5	—	—
SLA	Bend Insensitive Low Water Peak Single-Mode ITU-T G.657.A1 and ITU-T G.652.D	9 <sup>6</sup> /125	—	1310/1550	5 km <sup>4</sup>	10 km <sup>5</sup>	0.5/0.5	—	—
SLB	Bend Insensitive Low Water Peak Single-Mode ITU-T G.657.A2 and ITU-T G.652.D	9 <sup>6</sup> /125	—	1310/1550	5 km <sup>4</sup>	10 km <sup>5</sup>	0.5/0.5	—	—
SLC	Bend Insensitive Low Water Peak Single-Mode ITU-T G.657.B3 and ITU-T G.652.D	9 <sup>6</sup> /125	—	1310/1550	5 km <sup>4</sup>	10 km <sup>5</sup>	0.5/0.5	—	—

\* Minimum Laser Effective Modal Bandwidth (EMB)

\*\* For backward compatibility to LED based systems, overfilled launch (OFL)

<sup>^</sup> 1310 nm CWDM lasers (10GBASE-LX4)

<sup>1</sup> Reach assuming 3.0 dB maximum cabled attenuation at 850 nm and 1.3 dB total connection and splice loss

<sup>2</sup> Supports 220 meter 10GBASE-LRM distance, or 300 meter 10GBASE-LRM distance with 300 meter capable equipment

<sup>3</sup> 3.5/1.5 dB/km maximum attenuation applies for DX-Series cables greater than 36 fibers, and for all DX-Series cables with armor (corrugated steel tape or interlocked armor) or any other secondary outer jacketing

<sup>4</sup> 10 km for 1310 nm 1000BASE-LX10, and 5 km for 1310 nm 1000BASE-LX

<sup>5</sup> 10 km for 1310 nm 10GBASE-LR, and 40 km for 1550 nm 10GBASE-ER

<sup>6</sup> Typical Mode Field Diameter at 1310 nm

<sup>7</sup> Fiber Codes are available for composite cables containing a wide variety of mixed fiber types within the same cable. Call OCC Customer Service for the Fiber Code for your composite cable configuration.

 (6.9b) Ultra-Fox™ Plus Fiber Performance

Fiber Code <sup>5</sup>	Industry Standard Designation	Core/Cladding Diameter (μm)	Numeric Aperture	Wavelength (nm)	Gigabit Ethernet Distance (m)	10-Gigabit Ethernet Distance (m)	Max. Cabled Attenuation (dB/km)	Min. Laser EMB Bandwidth* (MHz-km)	Min. OFL LED Bandwidth** (MHz-km)
WST	OM1 ISO/IEC 11801	62.5/125	0.275	850/1310	275/550	33/300 <sup>^</sup>	3.5/1.5	200/500	200/500
WLS	Laser Grade OM1 ISO/IEC 11801	62.5/125	0.275	850/1310	300/600	33/300 <sup>^</sup>	3.5/1.5	220/500	200/500
AST	OM2 ISO/IEC 11801	50/125	0.20	850/1310	550/550	82/300 <sup>^</sup>	3.5/1.5	500/500	500/500
ALS	Laser Grade OM2 ISO/IEC 11801	50/125	0.20	850/1310	600/600	82/300 <sup>^</sup>	3.5/1.5	510/500	500/500
ALT	Laser Optimized OM3 ISO/IEC 11801	50/125	0.20	850/1310	1000/600	300/300 <sup>^1</sup>	3.5/1.5	2000/500	1500/500
ALE	Laser Optimized OM4 ISO/IEC 11801	50/125	0.20	850/1310	1040/600	550/300 <sup>^</sup>	3.5/1.5	4700/500	3500/500
SLS	Low Water Peak Single-Mode ITU-T G.652.D <sup>6</sup>	9 <sup>2</sup> /125	—	1310/1550	5 km <sup>3</sup>	10 km <sup>4</sup>	0.5/0.5	—	—
SLA	Bend Insensitive Low Water Peak Single-Mode ITU-T G.657.A1 and ITU-T G.652.D	9 <sup>2</sup> /125	—	1310/1550	5 km <sup>3</sup>	10 km <sup>4</sup>	0.5/0.5	—	—

\* Minimum Laser Effective Modal Bandwidth (EMB)

\*\* For backward compatibility to LED-based systems, overfilled launch (OFL)

<sup>^</sup> 1310nm CWDM lasers (10GBASE-LX4)

<sup>1</sup> Supports 220-meter 10GBASE-LRM distance or 300-meter 10 GBASE-LRM distance with 300-meter-capable equipment

<sup>2</sup> Typical Mode Field Diameter at 1310nm = 9 microns

<sup>3</sup> 10km for 1310nm 1000BASE-LX10 and 5km for 1310nm 1000BASE-LX

<sup>4</sup> 10km for 1310 10GBASE-LR and 40km for 1550nm 10GBASE-ER

<sup>5</sup> Fiber Codes are available for composite cables containing a wide variety of mixed fiber types within the same cable. Call OCC Customer Service for the Fiber Code for your composite cable configuration.

<sup>6</sup> For certain specialty applications SLS fiber may be ITU-T G.652.A

## Other Fiber Types Available Upon Request

OCC continues to offer the widest variety of standard off-the-shelf and nonstandard fiber types to meet the customer's special system requirements. If your system design demands a fiber type not included on these two pages, call OCC to see if your needs can be met with one of the many fiber types available. The following fiber types are examples of some of the specialty fibers available from OCC.

Fiber Type	Description	Uses
CST/DBX	100/140 Core/Cladding	Large core fiber used in low data rate industrial applications
FST	200/230 Core/Cladding	Large core fiber used in low data rate industrial applications
Mil-PRF-49291	Single-Mode and Multimode	Military qualified fiber for specific contract QPL
Radiation Hardened	Single-Mode and Multimode	Commercial and Mil grades available
200kpsi Proof Strength	Single-Mode and Multimode	Many fiber types are available with a 200kpsi proof strength for demanding applications
Wide band multimode fiber	Wide band 50μm NextGen Fiber	CWDM ethernet 40–400 gigabit





# COPPER CABLE

It's true that OCC revolutionized fiber. However, we did not stop there. With the surge of high-bandwidth and non-stop emerging technologies, such as 4k HD video, huge data transfers, ever growing wireless and mobile applications, IoT, and the increased PoE to support those technologies, OCC also offers a complete line of Cat 5e, Cat 6, and Cat 6A copper cable. By offering a broad portfolio of solutions, you're empowered with the flexibility to design your network as you envision, and to solve your most challenging applications.

OCC's copper cable provides some of the industry's highest resistance to tension, and its versatile configurations deliver optimum performance under the most demanding conditions.

Our commitment to copper and our wide range of network solutions means you can depend on OCC as your single source supplier and technical support partner for all of your cabling infrastructure needs.

## 7.0 Copper Cables

<b>7.1</b>	<b>ENTERPRISE CATEGORY 6A</b>	
7.1a	UTP Copper Cable .....	334
7.1b	F/UTP Copper Cable .....	336
<b>7.2</b>	<b>ENTERPRISE CATEGORY 6</b>	
7.2a	High Performance UTP Copper Cable .....	338
7.2b	UTP Copper Cable .....	340
7.2c	Outside Plant Copper Cable .....	342
<b>7.3</b>	<b>ENTERPRISE CATEGORY 5E</b>	
7.3a	UTP Copper Cable .....	344
<b>7.4</b>	<b>COPPER CABLE FIBER PERFORMANCE</b>	
7.4a	Choosing the Right Cabling System .....	346

## (7.1a) Category 6A UTP Copper Cables

### Cat6A UTP Riser:

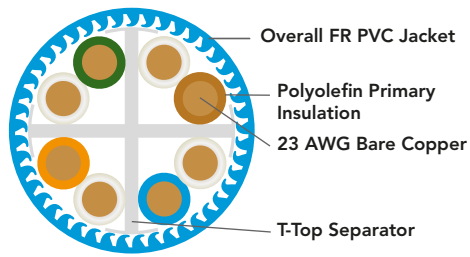

### Cat6A UTP Plenum:

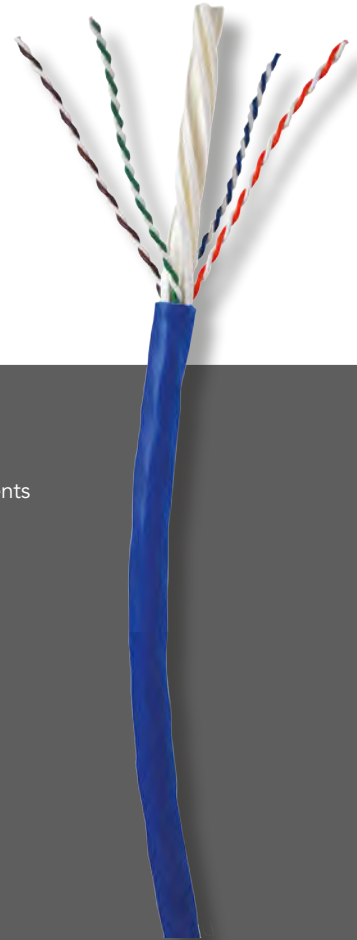
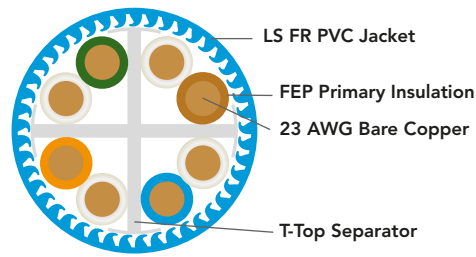

### Features & Benefits

- Tested from 1 to 660MHz and offers guaranteed headroom to TIA Category 6A cable requirements
- Guaranteed 10GBASE-T performance compliance
- Cable components are twisted into pairs with varying left-hand lays to minimize crosstalk
- PoE+ compliant
- Compatible with OCC Cat6A jacks and patch panels for optimal system performance
- Available in riser and plenum rated, UTP, and F/UTP

### Construction

- Conductor: 23 AWG (.55 mm) solid bare copper
- Color Code
  - Pair 1: Blue-White
  - Pair 2: Orange-White
  - Pair 3: Green-White
  - Pair 4: Brown-White
- Jacket:
  - Riser rated – flame-retardant PVC, UL listed type FT4 per UL 444
  - Plenum rated – low-smoke flame-retardant PVC, UL listed type FT6 per UL 444
- Cabling:
  - UTP – Four twisted pairs are cabled around a T-top filler with a left-hand lay
- Ripcord: Applied longitudinally on UTP Category 6A riser and plenum cables

### Applications

- 10GBASE-T Ethernet
- 1000BASE-T Gigabit Ethernet
- 100BASE-TX Fast Ethernet
- 155/622/1000 Mbps ATM
- Broadband Video
- Analog Voice/VOiP
- PoE+
- All other applications developed for operation over Category 6A cabling
- See Ethernet Application and Distance Over Copper Cabling Table, pg. 347.

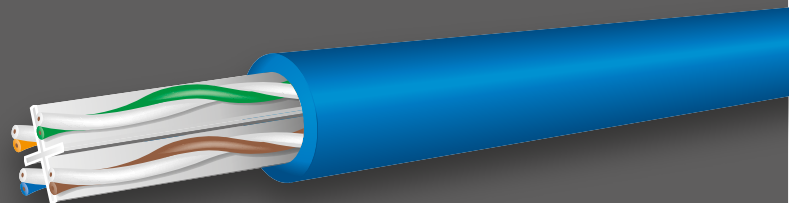

## (7.1a) Category 6A UTP Copper Cables

### Electrical Characteristics

CATEGORY 6A UTP ELECTRICAL CHARACTERISTICS*	
Characteristic impedance:	100 ± 15 Ω (1 to 500MHz)
Maximum conductor resistance:	9.3 Ω/100 meters @ 20°C
Maximum resistance unbalance:	3%
Maximum mutual capacitance:	5.6 nF/100 meters @ 1kHz
Maximum capacitance unbalance:	330 pF/100 meters

\*Discrete values are for information only. Equations for swept frequencies govern limits.

### Standards

- TIA-568-C.2 Category 6A
- IEEE 802.3an (Clause 55.7) 100-meter link segment requirements
- NEC/CEC Type CMR (UL 1666) Riser
- NEC/CEC Type CMP (NFPA262) Plenum

### Electrical Performance – Category 6A UTP Riser and Plenum

Frequency (MHz)	Insertion Loss Max (dB/100) meters	NEXT Loss Mn. (dB)	PSNEXT Loss Mn. (dB)	ACR Mn. (dB)	PSACR Mn. (dB)	ACR-F Mn. (dB)	PSACRF Mn. (dB)	Return Loss Mn. (dB)	Propagation Delay Max (ns)	Delay Skew Max (ns)	TCL Mn. (dB)	ELTCL Mn. (dB)	PSANEXT Loss Mn. (dB)	PSAACRF Loss Mn. (dB)
1	2.1	74.3	72.3	72.2	70.2	67.8	64.8	20	570	45	40	35	67	67
4	3.8	65.3	63.3	61.5	59.5	55.8	52.8	23	552	45	40	23	67	66.2
8	5.3	60.8	58.8	55.5	53.5	49.7	46.7	24.5	547	45	40	16.9	67	60.1
10	5.9	59.3	57.3	53.4	51.4	47.8	44.8	25	545	45	40	15	67	58.2
16	7.5	56.2	54.2	48.7	46.7	43.7	40.7	25	543	45	38	10.9	67	54.1
20	8.4	54.8	52.8	46.4	44.4	41.8	38.8	25	542	45	37	9	67	52.2
25	9.4	53.3	51.3	43.9	41.9	39.8	36.8	24.3	541	45	36	7	67	50.2
31.25	10.5	51.9	49.9	41.4	39.4	37.9	34.9	23.6	540	45	35.1	5.5	67	48.3
62.5	15.0	47.4	45.4	32.4	30.4	31.9	28.9	21.5	539	45	32	–	65.6	42.3
100	19.1	44.3	42.3	25.2	23.2	27.8	24.8	20.1	538	45	30	–	62.5	38.2
200	27.6	39.8	37.8	12.2	10.2	21.8	18.8	18	537	45	27	–	58	32.2
250	31.1	38.3	36.3	7.2	5.2	19.8	16.8	17.3	536	45	26	–	56.5	30.2
300	34.3	37.1	35.1	2.8	0.8	18.3	15.3	16.8	536	45	25.2	–	55.3	28.7
400	40.1	35.3	33.3	–	–	15.8	12.8	15.9	536	45	24	–	53.5	26.2
500	45.3	33.8	31.8	–	–	13.8	10.8	15.2	536	45	23	–	52	24.2

### Ordering Information

PART NO.	DESCRIPTION	UOM	O.D.	WEIGHT
OCC-U6A4R-xx	Category 6A UTP CMR cable	Reel	0.330"	42 lbs./1,000 ft.
OCC-U6A4PLM-xx	Category 6A UTP CMP cable	Reel	0.320"	53.3 lbs./1,000 ft.

Replace "xx" with color code: **05** = blue, **07** = white. Other colors available; contact OCC Inside Sales for available colors.

Please call 1-800-622-7711 and ask for a Sales Representative. We're ready to assist you.

## (7.1b) Category 6A F/UTP Copper Cables

### Cat6A F/UTP Riser:

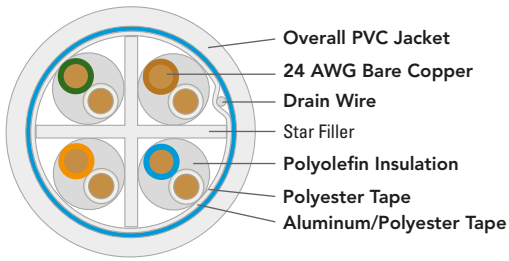

### Cat6A F/UTP Plenum:

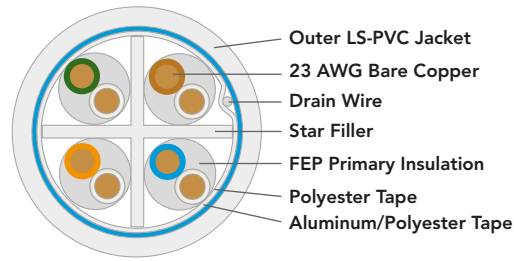

## Features & Benefits

- Tested from 1 to 600MHz and offers guaranteed headroom to TIA-568-C.2 Category 6A cable requirements
- Guaranteed 10GBASE-T performance compliance
- Components are twisted into pairs with varying left-hand lays to minimize cross-talk
- PoE+ compliant
- Compatible with OCC Cat6A jacks and patch panels for optimal system performance
- Available in riser and plenum rated

## Construction

- Conductor: 23 AWG (.0226") solid bare copper
- Color Code
  - Pair 1: Blue–White
  - Pair 2: Orange–White
  - Pair 3: Green–White
  - Pair 4: Brown–White
- Jacket:
  - Riser rated – flame-retardant PVC, UL listed type FT4 per UL 444
  - Plenum rated – low-smoke flame-retardant PVC, UL listed type FT6 per UL 444
- Cabling:
  - F/UTP – Four twisted pairs are cabled around a star filler and wrapped with an aluminum polyester tape

## Applications

- 10GBASE-T Ethernet
- 1000BASE-T Gigabit Ethernet
- 100BASE-TX Fast Ethernet
- 155/622/1000 Mbps ATM
- Broadband Video
- Analog Voice/VOiP
- PoE+
- All other applications developed for operation over Category 6A cabling
- See Ethernet Application and Distance Over Copper Cabling Table, pg. 347.

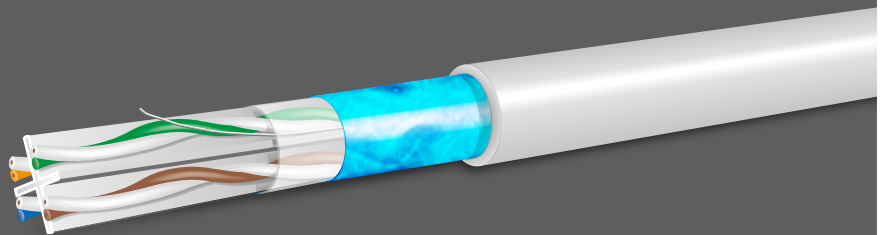

## (7.1b) Category 6A F/UTP Copper Cables

### Electrical Characteristics

CATEGORY 6A F/UTP ELECTRICAL CHARACTERISTICS*	
Maximum conductor resistance:	9.38 Ω/100 meters @ 20°C
Maximum resistance unbalance:	3%
Maximum mutual capacitance:	5.6 nF/100 meters @ 1kHz
Maximum capacitance unbalance:	330 pF/100 meters

\*Discrete values are for information only. Equations for swept frequencies govern limits.

### Standards

- TIA-568-C.2 Category 6A
- IEEE 802.3an (Clause 55.7) 100-meter link segment requirements
- NEC/CEC Type CMR (UL 1666) Riser
- NEC/CEC Type CMP (NFPA262) Plenum

### Electrical Performance – Category 6A F/UTP Riser and Plenum

Frequency (MHz)	Insertion Loss Max (dB/100) meters	NEXT Loss Mn. (dB)	PSNEXT Loss Mn. (dB)	ACR Mn. (dB)	PSACR Mn. (dB)	ACR-F Mn. (dB)	PSACRF Mn. (dB)	Return Loss Mn. (dB)	Propagation Delay Max (ns)	Delay Skew Max (ns)	TCL Mn. (dB)	ELCTL Mn. (dB)	PSANEXT Loss Mn. (dB)	PSAACRF Loss Mn. (dB)
1	2.1	74.3	72.3	72.2	70.2	67.8	64.8	20	570	45	40	35	67	67
4	3.8	65.3	63.3	61.5	59.5	55.8	52.8	23	552	45	40	23	67	66.2
8	5.3	60.8	58.8	55.5	53.5	49.7	46.7	24.5	547	45	40	16.9	67	60.1
10	5.9	59.3	57.3	53.4	51.4	47.8	44.8	25	545	45	40	15	67	58.2
16	7.5	56.2	54.2	48.7	46.7	43.7	40.7	25	543	45	38	10.9	67	54.1
20	8.4	54.8	52.8	46.4	44.4	41.8	38.8	25	542	45	37	9	67	52.2
25	9.4	53.3	51.3	43.9	41.9	39.8	36.8	24.3	541	45	36	7	67	50.2
31.25	10.5	51.9	49.9	41.4	39.4	37.9	34.9	23.6	540	45	35.1	5.5	67	48.3
62.5	15.0	47.4	45.4	32.4	30.4	31.9	28.9	21.5	539	45	32	–	65.6	42.3
100	19.1	44.3	42.3	25.2	23.2	27.8	24.8	20.1	538	45	30	–	62.5	38.2
200	27.6	39.8	37.8	12.2	10.2	21.8	18.8	18	537	45	27	–	58	32.2
250	31.1	38.3	36.3	7.2	5.2	19.8	16.8	17.3	536	45	26	–	56.5	30.2
300	34.3	37.1	35.1	2.8	0.8	18.3	15.3	16.8	536	45	25.2	–	55.3	28.7
400	40.1	35.3	33.3	–	–	15.8	12.8	15.9	536	45	24	–	53.5	26.2
500	45.3	33.8	31.8	–	–	13.8	10.8	15.2	536	45	23	–	52	24.2

### Ordering Information

PART NO.	DESCRIPTION	UOM	O.D.	WEIGHT
OCC-FTP6A4R-xx	Category 6A F/UTP CMR cable	Reel	0.29"	40 lbs./1,000 ft.
OCC-FTP6A4PLM-xx	Category 6A F/UTP CMP cable	Reel	0.29"	36 lbs./1,000 ft.

Replace "xx" with color code: **05** = blue, **07** = white. Other colors available; contact OCC Inside Sales for available colors.

Please call 1-800-622-7711 and ask for a Sales Representative. We're ready to assist you.

## (7.2a) Category 6 High Performance UTP Copper Cables

### Cat 6 High Performance UTP Riser:

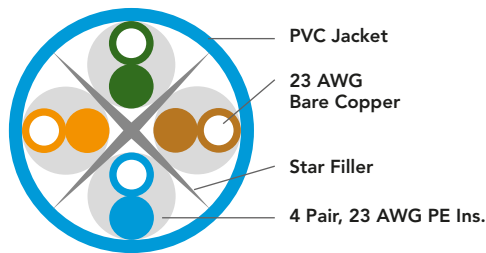

### Cat 6 High Performance UTP Plenum:

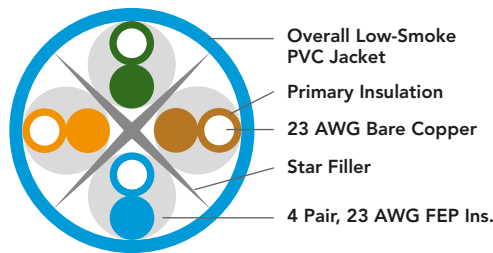

## Features & Benefits

- Performance is characterized to 660MHz and offers guaranteed headroom to Category 6 TIA-568-C.2 cable requirements
- 15.5dB ACR margin @ 250MHz — 10 times the TIA-568-C.2 requirement
- Fully compliant with Power over Ethernet PoE+ technology
- Components are twisted into pairs with varying left-hand lays to minimize cross-talk
- Reverse sequential numbering to eliminate guesswork of footage in box or reel
- Compatible with OCC Cat 6 jacks and patch panels for optimal system performance
- Available in riser and plenum rated, UTP

## Construction

- Conductor: 23 AWG (.0224") Solid Bare Copper
- Color Code
  - Pair 1: Blue-White
  - Pair 2: Orange-White
  - Pair 3: Green-White
  - Pair 4: Brown-White
- Jacket:
  - Riser rated – flame-retardant PVC, UL listed type FT4 per UL 444
  - Plenum rated – low-smoke flame-retardant PVC, UL listed type FT6 per UL 444
- Cabling: Four twisted pairs are cabled around a cross-talk reduction separator with a left-hand lay
- Ripcord: Applied longitudinally under jacket

## Applications

- 1000BASE-T Gigabit Ethernet
- 100BASE-TX Fast Ethernet
- 10BASE-T Ethernet
- 155/622/1000 Mbps ATM
- Broadband Video
- Analog Voice/VOiP
- PoE+
- All other applications developed for operation over Category 6 cabling

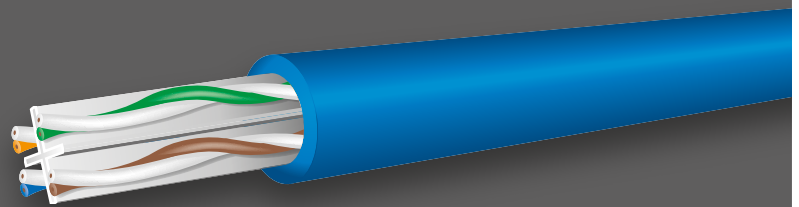

OCC reserves the right to change specifications without prior notification. To access the most current information about our Cat 6 high performance copper cable, contact OCC Inside Sales or visit [occfiber.com](http://occfiber.com).



## (7.2a) Category 6 High Performance UTP Copper Cables

### Electrical Characteristics

CATEGORY 6+ ELECTRICAL CHARACTERISTICS*	
Characteristic impedance:	100 ± 15 Ω (1.0 to 250MHz)
Maximum conductor resistance:	9.3 Ω/100 Meters @ 20°C
Maximum resistance unbalance:	3%
Maximum mutual capacitance:	5.6 nF/100 Meters @ 1kHz
Maximum capacitance unbalance:	330 pF/100 Meters
Maximum delay skew:	45 ns/100 Meters

\*Discrete values are for information only. Equations for swept frequencies govern limits.

### Standards

- ANSI/TIA-568-C.2
- ISO/IEC 11801, 2nd edition, Class E and Category 6
- ICEA S-102-700 (Cat 6)
- NEC/CEC Type CMR (UL 1666) Non-Plenum
- NEC/CEC Type CMP (NFPA262) Plenum

### Electrical Performance – Category 6 High Performance UTP Riser and Plenum

FREQUENCY (MHz)	INSERTION LOSS MAX (dB/100M)	NEXT LOSS MIN (dB)		ACR MIN (dB)		ACRF MIN (dB)		RETURN LOSS MIN (dB)	DELAY MAX (ns)
		WP	PS	WP	PS	WP	PS		
1	2.0	83.3	81.3	81.3	79.3	75.8	72.8	20.0	570
4	3.7	74.3	72.3	70.6	68.6	63.8	60.8	24.2	552
10	5.8	68.3	66.3	62.5	60.5	55.8	52.8	27.0	545
16	7.3	65.2	63.2	57.9	55.9	51.7	48.7	27.0	543
31.25	10.4	60.9	58.9	50.5	48.5	45.9	42.9	25.9	540
62.5	14.9	56.4	54.4	41.5	39.5	39.9	36.9	24.2	539
100	19.2	53.3	51.3	34.1	32.1	35.8	32.8	23.1	538
155	24.4	50.4	48.4	26.0	24.0	32.0	29.0	22.0	537
200	28.1	48.8	46.8	20.7	18.7	29.8	26.8	21.4	537
250	31.9	47.3	45.3	15.4	13.4	27.8	24.8	20.9	536
350*	38.6	45.1	43.1	6.5	4.5	24.9	21.9	20.1	536
400*	41.7	44.3	42.3	2.6	0.6	23.8	20.8	19.7	536
500*	47.5	42.8	40.8	—	—	21.8	18.8	19.2	536
555*	50.5	42.1	40.1	—	—	20.9	17.9	18.9	536
660*	55.9	41.0	39.0	—	—	19.4	16.4	18.5	536

\*Frequencies beyond the TIA and ISO requirements are for information only. All values are db/100 meters.

### Ordering Information

PART NO.	DESCRIPTION	UOM	O.D.	WEIGHT
OCC-U64HR-xx	Category 6 High Performance UTP CMR cable	Reel	0.24"	23 lbs.
OCC-U64HPLM-xx	Category 6 High Performance UTP CMP cable	Reel	0.22"	24 lbs.

Replace "xx" with color code: **05** = blue, **07** = white. Other colors available; contact OCC Inside Sales for available colors.

Please call 1-800-622-7711 and ask for a Sales Representative. We're ready to assist you.

## (7.2b) Category 6 UTP Copper Cables

### Cat 6 UTP Riser:

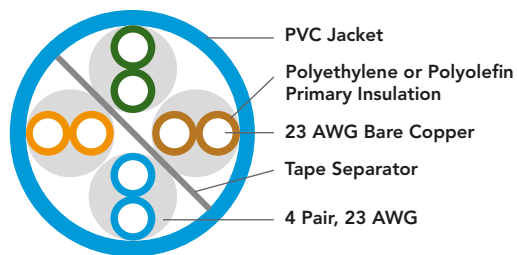

### Cat 6 UTP Plenum:

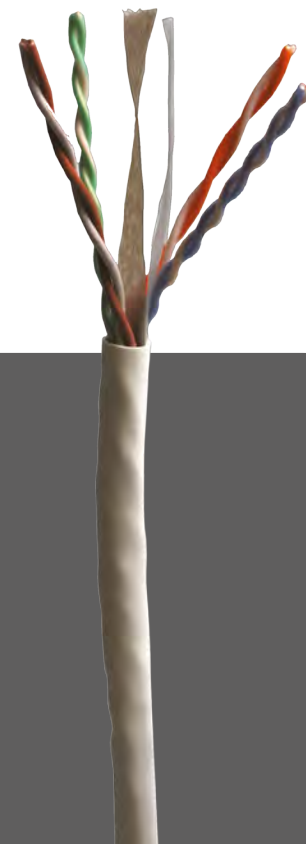
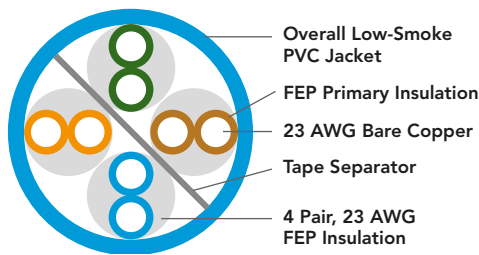

## Features & Benefits

- Performance characterized to 500MHz and compliant to Category 6 TIA-568-C.2 cable requirements
- Fully compliant with Power over Ethernet (PoE+) technology
- Components are twisted into pairs with varying left-hand lays to minimize cross-talk
- Reverse sequential numbering to eliminate guesswork of footage in box or reel
- Compatible with OCC Cat 6 jacks and patch panels for optimal system performance
- Available in riser and plenum rated, UTP

## Construction

- Conductor: 23 AWG (.0224") Solid Bare Copper
- Color Code
  - Pair 1: Blue-White
  - Pair 2: Orange-White
  - Pair 3: Green-White
  - Pair 4: Brown-White
- Jacket:
  - Riser rated – flame-retardant PVC, UL listed type FT4 per UL 444
  - Plenum rated – low-smoke flame-retardant PVC, UL listed type FT6 per UL 444
- Cabling: Four twisted pairs are cabled with a tape separator and a left-hand lay
- Ripcord: Applied longitudinally under jacket

## Applications

- 1000BASE-T Gigabit Ethernet
- 100BASE-TX Fast Ethernet
- 155/622/1000 Mbps ATM
- Broadband Video
- Analog Voice/VOiP
- PoE+
- All other applications developed for operation over Category 6 cabling
- See Ethernet Application and Distance Over Copper Cabling Table, pg. 347.

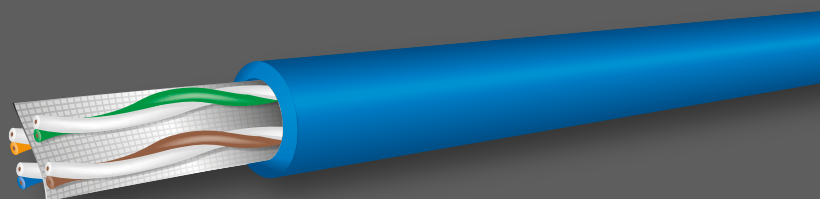

## (7.2b) Category 6 UTP Copper Cables

### Electrical Characteristics

CATEGORY 6 ELECTRICAL CHARACTERISTICS*	
Characteristic impedance:	100 ± 15 Ω (1.0 to 250MHz)
Maximum conductor resistance:	8.9 Ω/100 meters @ 20°C
Maximum resistance unbalanced:	5%
Maximum mutual capacitance:	5.6 nF/100 meters @ 1kHz
Maximum capacitance unbalanced:	330 pF/100 meters
Maximum delay skew:	45 ns/100 meters

\*Discrete values are for information only. Equations for swept frequencies govern limits.

### Standards

- ANSI/TIA-568-C.2
- ISO/IEC 11801, 2nd edition, Class E and Category 6
- ICEA S-102-700 (Cat 6)
- NEC/CEC Type CMR (UL 1666) Non-Plenum
- NEC/CEC Type CMP (NFPA262) Plenum

### Electrical Performance – Category 6 UTP Riser and Plenum

FREQUENCY (MHZ.)	INSERTION LOSS MAX (DB/100M)	NEXT LOSS MIN (DB/100M)		ACR MIN (DB/100M)		ELFEXT MIN (DB/100M)		RETURN LOSS MIN (DB/100M)	DELAY MAX (NS/100M)
		WP	PS	WP	PS	WP	PS		
0.772	—	76.0	74.0	—	—	70.0	67.0	—	—
1.0	2.0	74.3	72.3	72.3	70.3	67.8	64.8	20.0	570
4.0	3.8	65.3	63.3	61.5	59.5	55.7	52.8	23.0	552
8.0	5.3	60.8	58.8	55.4	53.4	49.7	46.7	24.5	547
10.0	6.0	59.3	57.3	53.3	51.3	47.8	44.8	25.0	545
16.0	7.6	56.2	54.2	48.7	46.7	43.7	40.7	25.0	543
20.0	8.5	54.8	52.8	46.3	44.3	41.7	38.8	25.0	542
25.0	9.5	53.3	51.3	43.8	41.8	39.8	36.8	24.3	541
31.25	10.7	51.9	49.9	41.2	39.2	37.9	34.8	23.6	540
62.5	15.4	47.4	45.4	32.0	29.9	31.8	28.9	21.5	539
100.0	19.8	44.3	42.3	24.6	22.5	27.8	24.8	20.1	538
155.0	25.2	41.4	39.4	16.3	14.3	24.0	21.0	18.8	537
200.0	29.0	39.8	37.8	10.8	8.8	21.8	18.8	18.0	537
250.0	32.8	38.3	36.3	5.5	3.5	19.8	16.8	17.3	536
300.0	36.4	37.1	35.1	—	—	18.3	15.3	16.8	536
350.0	39.8	36.1	34.1	—	—	16.9	13.9	16.3	536
400.0	43.0	35.3	33.3	—	—	15.8	12.8	15.9	536
500.0	48.9	33.8	31.8	—	—	13.8	10.8	15.2	536

### Ordering Information

PART NO.	DESCRIPTION	UOM	O.D.	WEIGHT
OCC-UE64R-XX	Category 6 UTP CMR cable	Box	0.22"	23 lbs.
OCC-UE64PLM-XX	Category 6 UTP CMP cable	Box	0.21"	24 lbs.

Replace "xx" with color code: **05** = blue, **07** = white. Other colors available; contact OCC Inside Sales for available colors.

Please call 1-800-622-7711 and ask for a Sales Representative. We're ready to assist you.

## (7.2c) Category 6 Outside Plant Copper Cables (OCC-U64OSP)

### Cat 6 Outside Plant Copper Cables

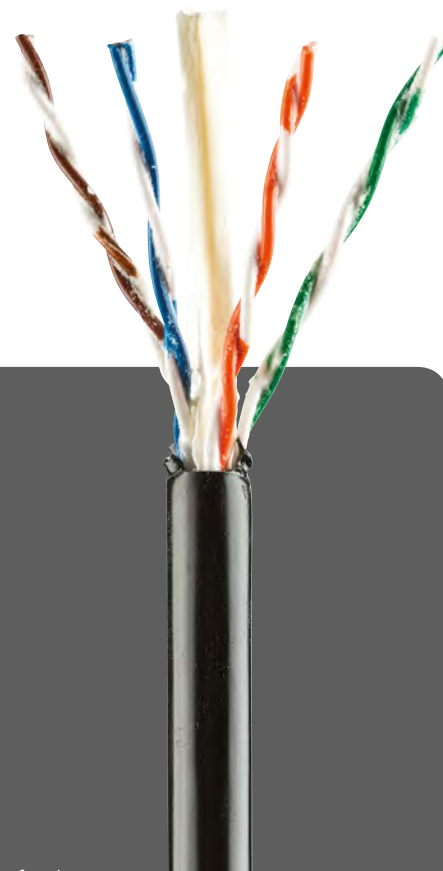
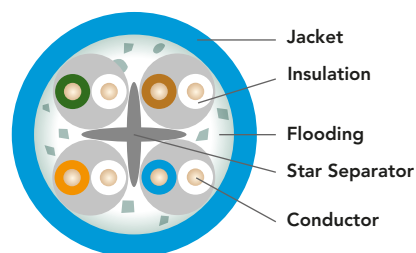

### Features & Benefits

- Rugged jacket for outside plant applications
- Water blocking gel-filled core
- UV resistant polyethylene jacket
- Cross web filler for enhanced performance

### Construction

- Conductor: 23 AWG (.0224") Solid Bare Copper
- Color Code
  - Pair 1: Blue-White
  - Pair 2: Orange-White
  - Pair 3: Green-White
  - Pair 4: Brown-White
- Jacket: UV Resistant Black Polyethylene
- Cabling: Four twisted pairs are cabled around a cross web filler and flooded with waterproof gel

### Applications

- 1000BASE-T Gigabit Ethernet
- 100BASE-TX Fast Ethernet
- 10BASE-T Ethernet
- 155/622 Mbps ATM
- Broadband Video
- Analog Voice/VOIP
- Wet locations
- See Ethernet Application and Distance Over Copper Cabling Table, pg. 347.

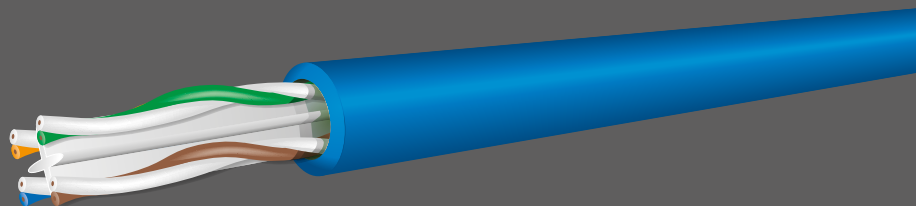

## Electrical Characteristics

CATEGORY 6 ELECTRICAL CHARACTERISTICS	
Characteristic impedance:	100 ± 15 Ω
Maximum conductor resistance:	9.38 Ω
Maximum resistance unbalanced:	5%
Nominal velocity of propagation:	68%
Maximum propagation delay skew:	45 ns/100 meters

## Standards

- ANSI/TIA-568-C.2
- ICEA S-102-700

## (7.2c) Category 6 Outside Plant Copper Cables (OCC-U64OSP)



### Electrical Performance – Category 6 OSP Cable

FREQUENCY (MHZ.)	RETURN LOSS (DB)	INSERTION LOSS (DB)	NEXT (DB)	PSNEXT (DB)	ACRF (DB)	PSACRF (DB)
1.0	20.0	2.0	74.3	72.3	67.8	64.8
4.0	23.0	3.8	65.3	63.3	55.7	52.7
8.0	24.5	5.3	60.8	58.8	49.7	46.7
10.0	25.0	6.0	59.3	57.3	47.8	44.8
16.0	25.0	7.6	56.3	54.3	43.7	40.7
20.0	25.0	8.5	54.8	52.8	41.7	38.7
25.0	24.3	9.5	53.3	51.3	39.8	36.8
31.25	23.6	10.7	51.9	49.9	37.9	34.9
62.5	21.5	15.4	47.4	45.4	31.8	28.8
100.0	20.1	19.8	44.3	42.3	27.8	24.8
125.0	19.4	22.4	42.9	40.9	25.8	22.8
155.52	18.8	25.2	41.4	39.4	23.9	20.9
175	18.4	26.9	40.7	38.7	22.9	19.9
200.0	18.0	29.0	39.8	37.8	21.7	18.7
250.0	17.3	32.8	38.3	36.3	19.8	16.8

### OCC Copper Systems — Guaranteed Channel Headroom

CATEGORY 6A	CAT 6A SHIELDED (Typical)	CAT 6A SHIELDED (Min. Margin)	CAT 6A UTP (Typical)	CAT 6A UTP (Min. Margin)
Insertion Loss	10%	3%	3%	3%
NEXT	9	4	6	4
PSNEXT	10	5	8	5
ACR	11	7	8	7
PSACR	12	8	10	8
ACR-F (ELFEXT)	8	5	5	4
PSACR-F (PSELFEXT)	8	6	6	5
RL	4	3	7	4
PSANEXT	15	10	1	1
PSAACR-F	15	10	2	2

CATEGORY 6	CAT 6 STANDARD (Typical)	CAT 6 STANDARD (Min. Margin)	CAT 6 HI-PERF (Typical)	CAT 6 HI-PERF (Min. Margin)
Insertion Loss	11%	5%	12%	8%
NEXT	6	4	8	6
PSNEXT	7	5	8	7
ACR	8	6	9	7
PSACR	8	7	9	8
ACR-F (ELFEXT)	10	8	14	10
PSACR-F (PSELFEXT)	12	9	14	12
RL	4	3	5	5

CATEGORY 5E	CAT 5E (Typical)	CAT 5E (Min. Margin)
Insertion Loss	13%	10%
NEXT	10	9
PSNEXT	11	10
ACR	12	11
PSACR	12	12
ACR-F (ELFEXT)	17	12
PSACR-F (PSELFEXT)	18	13
RL	9	6

**NOTES:**

1. The typical performance margins are based upon a 100 meter, 4-connector channel configuration.
2. The minimum margin guarantee will be incorporated into OCC's MDIS Extended Performance 25 Year Channel/Link Limited Warranty.

## (7.3a) Category 5e UTP Copper Cables

### Cat 5e UTP Riser

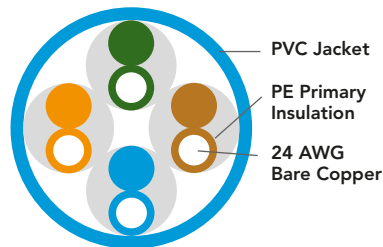

### Cat 5e UTP Plenum

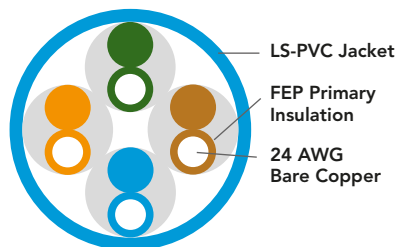

## Features & Benefits

- Tested from 1 to 350MHz and offers guaranteed headroom to Category 5e TIA 568-C.2 cable requirements
- Guaranteed Gigabit throughput
- Components are twisted into pairs with varying left-hand lays to minimize cross-talk
- Reverse sequential footage numbering to eliminate guesswork of footage in box or reel
- Compatible with OCC Cat 5e jacks and patch panels for optimal system performance
- Available in UTP riser and plenum rated

## Construction

- Conductor: 24 AWG (.020") solid bare copper
- Color Code
  - Pair 1: Blue–White/Blue
  - Pair 2: Orange–White/Orange
  - Pair 3: Green–White/Green
  - Pair 4: Brown–White/Brown
- Jacket:
  - Riser rated – flame-retardant PVC, UL listed type FT4 per UL 444
  - Plenum rated – low-smoke flame-retardant PVC, UL listed type FT6 per UL 444
- Ripcord: Applied longitudinally under jacket

## Applications

- 1000BASE-T Gigabit Ethernet
- 100BASE-TX Fast Ethernet
- 155/622/1000 Mbps ATM
- Broadband Video
- Analog Voice/VOIP
- PoE+
- All other applications developed for operation over Category 5e cabling
- See Ethernet Application and Distance Over Copper Cabling Table, pg. 347.

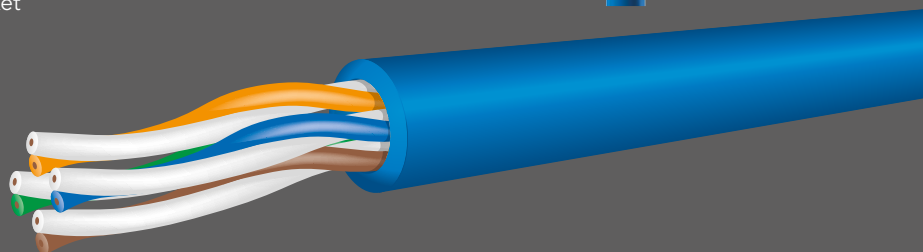



## (7.3a) Category 5e UTP Copper Cables

### Electrical Characteristics

CATEGORY 5E ELECTRICAL CHARACTERISTICS*	
Characteristic impedance:	100 ± 15 Ω (.772 to 100MHz)
Maximum conductor resistance:	9.38 Ω/100 Meters @ 20°C
Maximum resistance unbalance:	5%
Maximum mutual capacitance:	5.6 nF/100 Meters @ 1kHz
Maximum capacitance unbalance:	330 pF/100 Meters
Maximum delay skew:	45 ns/100 Meters

### Standards

- ANSI/TIA-568-C.2, Cat 5e
- ISO/IEC 11801, 2nd edition, Class E and Cat 5e component
- ICEA S-90-661 (Cat 5e)
- NEC/CEC Type CMR (UL 1666) Non-Plenum
- NEC/CEC Type CMP (NFPA262) Plenum

\*Discrete values are for information only. Equations for swept frequencies govern limits.

### Electrical Performance – Category 5e UTP Riser and Plenum

FREQUENCY (MHz)	INSERTION LOSS MAX (dB/100M)	NEXT LOSS MIN (dB)		ACR MIN (dB)		ELFEXT MIN (dB)		RETURN LOSS MIN (dB)	DELAY MAX (ns)
		WP	PS	WP	PS	WP	PS		
0.772	1.8	67.0	64.0	65.2	62.2	66.0	63.0	—	—
1.0	2.0	65.3	62.3	63.3	60.3	63.8	60.8	20.0	570
4.0	4.1	56.3	53.3	52.2	49.2	51.8	48.8	23.0	552
8.0	5.8	51.8	48.8	46.0	43.0	45.7	42.7	24.5	547
10.0	6.5	50.3	47.3	43.8	40.8	43.8	40.8	25.0	545
16.0	8.2	47.2	44.2	39.0	36.0	39.7	36.7	25.0	543
20.0	9.2	45.8	42.8	36.5	33.5	37.8	34.8	25.0	542
25.0	10.3	44.3	41.3	33.9	30.9	35.8	32.8	24.3	541
31.25	11.7	42.9	39.9	31.2	28.2	33.9	30.9	23.6	540
62.5	17.0	38.4	35.4	21.4	18.4	27.9	24.9	21.5	539
100.0	22.0	35.3	32.3	13.3	10.3	23.8	20.8	20.1	538
155.0	28.1	32.4	29.4	—	—	20.0	17.0	18.8	537
200.0	32.4	30.8	27.8	—	—	17.8	14.8	18.0	537
250.0	36.9	29.3	26.3	—	—	15.8	12.8	17.3	536
300.0	41.0	28.1	25.1	—	—	14.3	11.3	16.8	536
350.0	44.9	27.1	24.1	—	—	12.9	9.9	16.3	536

### Ordering Information

PART NO.	DESCRIPTION	UOM	O.D.	WEIGHT
OCC-U5E4R-xx	Category 5e UTP CMR cable	Box	0.179"	22 lbs.
OCC-U5E4PLM-xx	Category 5e UTP CMP cable	Box	0.180"	21 lbs.

Replace "xx" with color code: **05** = blue, **07** = white. Other colors available; contact OCC Inside Sales for available colors.

Please call 1-800-622-7711 and ask for a Sales Representative. We're ready to assist you.

## 7.4a Choosing the Right Cabling System

### What Is the Best Structured Cabling System for My Application?

#### CATEGORY 5E

- For general purpose use in office, residential, and commercial spaces
- Support for systems up to 1000 Mbps (1000BASE-T)
- Support for Power over Ethernet (PoE) and PoE+; PoE provides low voltage power, up to 15.4 Watts DC; PoE+ provides DC power up to 30 Watts
- Support for Voice over Internet Protocol (VOiP); VOiP provides voice communications using standard IEEE 802.3 Internet data packets
- Optical Cable Corporation products for Category 5e systems:
  - OCC Category 5e UTP copper cables
  - OCC patch panels, multiuser outlet modules, consolidation points, and cross-connects
  - OCC Telco (25-pair) unshielded panels and pre-terminated cable assemblies
  - OCC outlet jacks, keystone and bezel mounting configurations
  - OCC modular cords (quality products made in North America)
  - OCC patch cord test adapters

#### CATEGORY 6

- Ideal for office/commercial, colleges and universities, healthcare, and manufacturing/industrial installations
- Support for 10/100/1000/10,000 Mbps applications; UTP Cat 6 systems support 10GBASE-T to 55m
- Enhanced support for PoE and PoE+
- Support for VOiP and networked video and camera systems
- Available in unshielded (UTP) and screened (F/UTP)
- Unshielded systems best for general office, campus locations, and commercial spaces
  - Screened systems provide shielding against EMI/RF for manufacturing/industrial, banking, government, and healthcare
- Suitable for data center applications
- Optical Cable Corporation products for Category 6 systems:
  - OCC Category 6 UTP and F/UTP copper cables
  - OCC patch panels, multiuser outlet modules, consolidation points, and cross-connects, both UTP and screened
  - OCC quadbox UTP and screened patch panels and pre-terminated cable assemblies
  - OCC outlet jacks, keystone (UTP and STP) and bezel (UTP) mounting configurations
  - OCC modular cords, UTP and F/UTP (made in USA 100% performance tested)
  - OCC patch cord test adapters

#### CATEGORY 6A

- Recommended for 10 Gigabit applications, such as data centers and IEEE 802.11AC wireless access points
- Recommended for long term infrastructure investment security
- Support for 10/100/1000/10,000 Mbps applications; best choice for 10GBASE-T
- Best choice for PoE+ and four-pair power (50W); lowest temperature rise
- Enhanced support of networked video and camera systems
- Available in unshielded (UTP) and shielded (F/UTP)
  - Unshielded systems for general office/commercial, campus infrastructure, and manufacturing
  - Shielded systems for data centers, with enhanced 10GBASE-T and future protocol support
- Optical Cable Corporation products for Category 6A systems:
  - OCC Category 6A UTP, F/UTP copper cables
  - OCC patch panels, UTP and shielded
  - OCC Quadbox UTP and shielded patch panels and pre-terminated cable assemblies
  - OCC outlet jacks, keystone (UTP and STP) and bezel (UTP) mounting configurations
  - OCC Cat 6A patch cords (100% performance tested)
  - OCC patch cord test adapters

## 7.4a Choosing the Right Cabling System

### Ethernet Application and Distance Over OCC Fiber Optic Cabling

OCC consistently outperforms IEEE maximum supportable distances.

APPLICATION	IEEE STANDARD	NOMINAL WAVELENGTH (NM)	MULTIMODE								SINGLE-MODE	
			62.5/125µm 200MHz (OM1)		50/125UM 500MHz (OM2)		850nm LO 2000MHz 50/125µm (OM3)		850nm LO 4700MHz 50/125µm (OM4)		OS1/OS2	
			850	1300	850	1300	850	1300	850	1300	1310	1550
100BASE-FX	802.3u	Supportable Distance (meters)		2000		2000		2000		2000		
1000BASE-SX	802.3z		300 275		600 550		1000 800		1040			
1000BASE-LX	802.3z			600 550		600 550		600 550		600	5000	
10GBASE-SR	802.3ae		33		82		300		550 400			
10GBASE-LRM	802.3aq			300 220		300 220		300 220		300		
10GBASE-LR	802.3ae										10km	
10GBASE-ER	802.3ae											40km
40GBASE-SR4	802.3ba						100m		150m			
40GBASE-LR4	802.3ba										10km	
40GBASE-FR	802.3bg										2km	
100GBASE-SR10	802.3ba						100m		150m			
100GBASE-LR4	802.3ba										10km	
100GBASE-ER4	802.3ba										40km	

■ = OCC Supportable Distance

■ = IEEE 802.3

### Ethernet Application and Distance Over Copper Cabling

APPLICATION	IEEE STANDARD	CAT3 (16MHz)	CAT5e (100MHz)	CAT6 (250MHz)	CAT6A (500MHz)	CAT8 (2000MHz)
10BASE-T	802.3i	100m	100m	100m	100m	100m
100BASE-TX	802.3u		100m	100m	100m	100m
1000BASE-T	802.3ab		100m	100m	100m	100m
10GBASE-T	802.3an			55m*	100m	100m
40GBASE-T	802.3bq					30m

\*TSB-155-A "Guidelines for the Assessment and Mitigation of Installed Category 6 Cabling to Support 10GBASE-T"

10GBASE-T should operate over channel lengths of up to 37 meters of category 6 cabling, and should operate over channel lengths between 37 and 55 meters of category 6 cabling depending on the alien crosstalk environment. Channel lengths over 55 meters may require mitigation.

## OCC Copper Systems — Guaranteed Channel Headroom

### Category 6A

CATEGORY 6A	CAT 6A SHIELDED (TYPICAL)	CAT 6A SHIELDED (MIN. MARGIN)	CAT 6A UTP (TYPICAL)	CAT 6A UTP (MIN. MARGIN)
Insertion Loss	10%	3%	3%	3%
NEXT	9	4	6	4
PSNEXT	10	5	8	5
ACR	11	7	8	7
PSACR	12	8	10	8
ACR-F (ELFEXT)	8	5	5	4
PSACR-F (PSELFEXT)	8	6	6	5
RL	4	3	7	4
PSANEXT	15	10	1	1
PSAACR-F	15	10	2	2

### Category 6

CATEGORY 6	CAT 6 STANDARD (TYPICAL)	CAT 6 STANDARD (MIN. MARGIN)	CAT 6 HI-PERF (TYPICAL)	CAT 6 HI-PERF (MIN. MARGIN)
Insertion Loss	11%	5%	12%	8%
NEXT	6	4	8	6
PSNEXT	7	5	8	7
ACR	8	6	9	7
PSACR	8	7	9	8
ACR-F (ELFEXT)	10	8	14	10
PSACR-F (PSELFEXT)	12	9	14	12
RL	4	3	5	5

### Category 5e

CATEGORY 5E	CAT 5E (TYPICAL)	CAT 5E (MIN. MARGIN)
Insertion Loss	13%	10%
NEXT	10	9
PSNEXT	11	10
ACR	12	11
PSACR	12	12
ACR-F (ELFEXT)	17	12
PSACR-F (PSELFEXT)	18	13
RL	9	6

**NOTES:**

1. The typical performance margins are based upon a 100 meter 4-connector channel configuration.
2. The minimum margin guarantee will be incorporated into OCC's MDIS Extended Performance 25 Year Channel/Link Limited Warranty.



# COPPER CONNECTIVITY

OCC provides the most robust copper cabling and connectivity solutions to meet your most challenging high-bandwidth and high-speed data applications with unsurpassed quality, low crosstalk technology, and maximum reliability for the optimum performance of your network. From patch panels and outlet jacks to robust direct attach plugs, our engineering and product designs adhere to the highest copper connectivity standards, including those that exceed Category 5e, 6, and 6A specifications to meet the onslaught of emerging technologies head on whether ULTRA HD 4k Video transmission, IP and the fast growth of wireless and mobile applications, and ever-increasing PoE requirements.

Our broad range of both fiber and copper cabling, in conjunction with comprehensive connectivity solutions that include patch cords, racks, enclosures, cable management and accessories, empowers you with a one-stop source of end-to-end solutions to achieve your specific network vision.

## Contents

### 8.0 Copper Connectivity

#### 8.1 CATEGORY 6A

8.1.a	Outlet Jacks and Direct Attach Plugs .....	352
8.1.b	Patch Panels.....	356
8.1.c	Modular Patch Cords.....	357

#### 8.2 CATEGORY 6

8.2.a	Outlet Jacks.....	358
8.2.b	Patch Panels.....	360
8.2.c	Modular Patch Cords.....	361
8.2.d	110 Blocks.....	362

#### 8.3 CATEGORY 5E

8.3.a	Outlet Jacks.....	363
8.3.b	Patch Panels.....	365
8.3.c	Modular Patch Cords.....	367
8.3.d	110 Blocks.....	368

#### 8.4 VOICE PRODUCTS

8.4.a	Outlet Jacks.....	369
8.4.b	Patch Panels.....	370

#### 8.5 MULTIMEDIA PANELS

8.5.a	Multimedia Panels.....	371
-------	------------------------	-----

#### 8.6 HARSH ENVIRONMENT COPPER PRODUCTS

8.6.a	R-JACK – Industrial RJ-45 Solution.....	372
8.6.b	DIN Rail Enclosures – Copper.....	376

#### 8.7 PRE-TERMINATED COPPER SOLUTIONS

8.7.a	Category 5e Pre-Terminated Cable Assemblies.....	378
8.7.b	Quad Box Pre-Terminated Cable Assemblies.....	383

#### 8.8 WORK STATION

8.8.a	Multimedia Adapters and Connectors .....	384
8.8.b	Limited Access – Physical Layer Security Cat 6A System.....	387
8.8.c	Faceplates .....	388
8.8.d	Surface Mount Products.....	395

#### 8.9 RESIDENTIAL

8.9.a	MSDE Enclosures .....	397
8.9.b	HAX Enclosures.....	399
8.9.c	Voice and Data Modules.....	400
8.9.d	Economy Distribution Solutions.....	401



## (8.1a) Outlet Jacks and Direct Attach Plugs

### Category 6A – KMJ Outlet Jacks

OCC's Category 6A jack offers a high-performance 10 Gigabit connecting hardware component in a compact form factor. This RJ45 slim-line Category 6A jack is part of a comprehensive solution for high-performance 10G structured cabling systems. Using patented crosstalk reduction technology, OCC engineering has developed one of its highest performing component products yet. The slim-line design supports high-density applications, allowing for 48 ports in a 1U panel for UTP and shielded applications, and is ideal for data center and 802.11AC wireless access points.

- Meets IEC 60603-7 requirements
- Guaranteed ISO and TIA Category 6A compliant
- 110-style IDC contacts exceed TIA-568-C.2 requirements
- Slim-line profile allows 48 ports in a 1U panel
- TIA-568-C.2 Cat 6A and ISO 11801 Ed 2. Cat 6A component compliant
- High-performance contacts provide low crosstalk with improved mechanical robustness
- One-piece stuffer cap included
- UL 1863 listed communications circuit accessory
- Large, easy-to-read color-coded labels
- Supports all IEEE Power over Ethernet (PoE) standards
- Contact material: high-strength beryllium copper alloy
- Contact plating: 50 µin gold over nickel
- Insulation resistance: 500 MΩ minimum
  - Dielectric withstand: 1000 VAC RMS or 1414 VDC
  - DC current rating: 1.5 A per conductor at 20°C ambient de-rated to 0.75 A at 60°C ambient



### Applications

- 10GBASE-T Ethernet
- 2.5G/5GBASE-T Gigabit Ethernet
- 1000BASE-T Gigabit Ethernet
- 100BASE-TX Fast Ethernet
- 10BASE-T Ethernet
- Broadband Video
- 155/622 Mbps ATM
- Analog Voice/VOIP
- PoE, PoE+, and PoE++

### Category 6A KMJ Outlet Jacks

PART NUMBER	DESCRIPTION
K6Axx	Category 6A KMJ outlet jack, UTP, slim-line
K6A50xx	Category 6A KMJ outlet jack, UTP, 50 pack
Replace "xx" with color code.	

"XX" COLOR CODES*	
00 – Electrical Ivory	06 – Data Gray
01 – Office White	08 – Orange
02 – Black	09 – Yellow
03 – Red	10 – Purple
04 – Green	11 – Brown
05 – Blue	12 – Bright White

\*Colors may be subject to availability and minimum order quantities.

## 8.1a Outlet Jacks and Direct Attach Plugs

### Category 6A – Shielded Jack

OCC's Category 6A shielded modular jack with toolless design is simple to terminate and supports high performance 10 Gigabit networks. Termination is accomplished by simply inserting the conductors into the lacing cap, placing the cap into the connector housing, and closing the jack cover. All eight conductors are simultaneously terminated when the jack cover is squeezed closed. This process ensures consistent, reliable terminations.

The K6AS jack meets ANSI/TIA-568-C.2 Category 6A and ISO/IEC 11801:2002 AMENDMENT 2 Class EA specifications component performance, and fits into standard OCC faceplates and shielded multimedia panels. The K6AS is also sold as part of 24/48-port patch panel kits in both flat and angled panel configurations.

K6AS jacks and patch panels combined with OCC Cat6A F/UTP copper cabling and Cat6A shielded patch cords form an end-to-end Cat6A channel backed by OCC's 25-year MDIS system performance warranty.

- Meets ANSI/TIA-568-C.2 Category 6A specifications
- Meets ISO/IEC 11801:2002 AMENDMENT 2 Class EA specifications
- Supports IEEE 802.3an 10GBASE-T Ethernet
- Toolless design allows for simple, consistent, reliable terminations
- Shielded housing ensures superior ANEXT performance
- Accommodates 22-24 AWG conductors
- Modular Interface: 750 mating cycles
- 50µ-inch gold-plated contacts
- Zinc alloy housing
- Dielectric withstand: 1000 VAC RMS or 1414 VDC
- 500MΩ insulation resistance
- UL 1863



### Applications

- 10GBASE-T Ethernet
- 2.5G/5GBASE-T Gigabit Ethernet
- 1000BASE-T Gigabit Ethernet
- 100BASE-TX Fast Ethernet
- 10BASE-T Ethernet
- Broadband Video
- 155/622 Mbps ATM
- Analog Voice/VOiP
- PoE, PoE+, and PoE++

### Ordering Information

PART NUMBER	DESCRIPTION
K6AS	Cat6A Shielded Modular Jack

## (8.1a) Outlet Jacks and Direct Attach Plugs

### Category 6A – UMJ Outlet Jacks

OCC's UMJ Category 6A jack offers a high-performance connecting hardware component for guaranteed 10 Gig performance. Using patented crosstalk reduction technology, OCC engineering has developed its highest performing component product yet. OCC's unique UMJ connector style offers users a versatile design for specifying and segmenting different color bezels in the network.

- Meets IEC 60603-7 requirements
- Guaranteed ISO and TIA Category 6A compliance
- 110-style IDC contacts exceed TIA-568-C.2 requirements
- TIA-568-C.2 Cat 6A component compliant
- ISO 11801 Ed 2. Cat 6A component compliant
- High-performance contacts provide low crosstalk with improved mechanical robustness
- One piece stuffer cap included
- UL 1863 listed communications circuit accessory
- Large, easy-to-read color-coded labels
- Supports all IEEE Power over Ethernet (PoE) standards
- Contact material: high-strength beryllium copper alloy
- Contact plating: 50µin gold over nickel
- Insulation resistance: 500 MΩ minimum
  - Dielectric withstand: 1000 VAC RMS or 1414 VDC
  - DC current rating: 1.5 A per conductor at 20°C ambient de-rated to 0.75 A at 60°C ambient



### Applications

- 10GBASE-T Ethernet
- 2.5G/5GBASE-T Gigabit Ethernet
- 1000BASE-T Gigabit Ethernet
- 100BASE-TX Fast Ethernet
- 10BASE-T Ethernet
- Broadband Video
- 155/622 Mbps ATM
- Analog Voice/VOIP
- PoE, PoE+, and PoE++

### Category 6A UMJ Outlet Jacks

PART NUMBER	DESCRIPTION
U6Axx	Category 6A UMJ outlet jack, UTP, slim-line
U6A50xx	Category 6A UMJ outlet jack, UTP, 50 pack
Replace "xx" with color code.	

"XX" COLOR CODES*	
00 – Electrical Ivory	06 – Data Gray
01 – Office White	08 – Orange
02 – Black	09 – Yellow
03 – Red	10 – Purple
04 – Green	11 – Brown
05 – Blue	12 – Bright White

\*Colors may be subject to availability and minimum order quantities.



## 8.1a) Outlet Jacks and Direct Attach Plugs

### Category 6A – Field Terminable Plug

The dramatic growth of wireless access points and other IP-enabled devices, such as surveillance cameras and building automation devices, has created a demand for a field installable modular plug that is easy to terminate and meets Cat6A performance requirements.

OCC's Category 6A field terminable plug is designed to support 10 Gigabit networks and can be easily terminated using parallel jaw pliers.

Termination is accomplished by simply inserting the conductors into the wire manager, squeezing the wire manager with parallel jaw pliers to terminate the conductors, and inserting the wire manager into the plug housing. All eight conductors are simultaneously terminated when the wire manager is squeezed. This process ensures consistent, reliable terminations.

The Field Term Plug meets TIA-568-C.2 Category 6A component performance and may be used in Cat5e/6 and 6A Direct Attach link or channels.

Field Term Plug installations used as part of an end-to-end OCC copper cabling solution are backed by OCC's 25-year MDIS Direct Attach System Performance Warranty.

#### Specifications:

- ANSI/TIA-568-C.2 Category 6A
- IEC 60603-7-41
- Supports IEEE 802.3an 10GBASE-T
- Supports all IEEE Power over Ethernet (PoE) standards
- Accommodates 22-24 AWG conductors
- Modular Interface: 750 mating cycles
- Dielectric withstand: 1000 VAC RMS or 1414 VDC
- Current rating (50°C): 1A
- 500MΩ insulation resistance
- Temperature range: -40°C to 70°C
- UL 1863

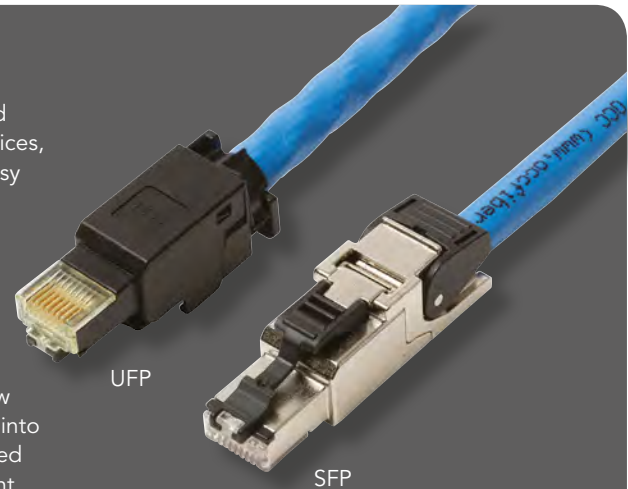

#### Applications

- 10GBASE-T Direct Attach Cable Assemblies
- 2.5G/5GBASE-T Gigabit Ethernet
- Wireless Access Points
- IP Security Cameras
- IP Access Control
- IP Audio
- Building Automation Devices
- Transition Cables
- PoE, PoE+, and PoE++

#### Ordering Information:

PART NUMBER	DESCRIPTION
OCCUFP6A	Cat 6A unshielded field terminable plug
OCCSFP6A	Cat 6A shielded field terminable plug
OCCSFP8	Cat 8 shielded field terminable plug
FPJP	Parallel jaw pliers

## (8.1a) Outlet Jacks and Direct Attach Plugs

### Field Plug Test Adapter

The dramatic growth of high-bandwidth wireless access points and other IP-enabled devices, such as surveillance cameras and building automation equipment, has resulted in an increasing number of direct attach links using field terminable plugs. The use of direct attach cable assemblies for switch to server interconnects in the data center is also expanding. This growth has created a need to change the way typical horizontal links and channels are configured for these applications. Devices, such as wireless access points mounted in non-traditional locations in the ceiling or high up on the wall, are not attached to the network using a standard faceplate, jack and patch cord configuration. The traditional method is being replaced with direct attachment where the horizontal cable is terminated with a field installable plug and then inserted directly into the equipment. Commonly used test methods for traditional links and channels may mask the true performance of a field terminated plug.

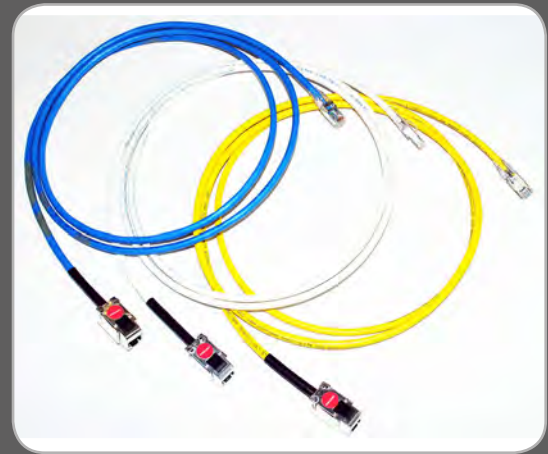

Through our participation in the telecommunications industry standards development, OCC continues to be the sole provider of test fixtures required for laboratory and field testing. Continuing in this tradition, OCC offers proven procedures and provides verified field plug test adapters to facilitate testing and to ensure accurate performance data.

In addition to a high-performance Cat6A Field Terminable Plug, OCC introduces Cat5e, Cat6, and Cat6A Field Plug Test Adapters to provide installers in the field the capability to accurately measure the true performance of direct attach links.

### Features & Benefits

- Individually center-tuned for the appropriate standard's category to ensure maximum accuracy
- Can be utilized with any field terminable plug
- Required for OCC Direct Attach MDIS 25-year System Extended Performance Warranty

### Direct Attach Applications

- Wireless Access Points
- IP Security Cameras
- IP Access Control
- IP Audio
- Building Automation Devices
- Data Center Direct Attach Cable Assemblies
- Transition Cables

### Ordering Information:

PART NUMBER	DESCRIPTION
FPTAC6AKS	Category 6A field plug test adapter, white
FPTAC6KS	Category 6 field plug test adapter, blue
FPTAC5EKS	Category 5e field plug test adapter, yellow

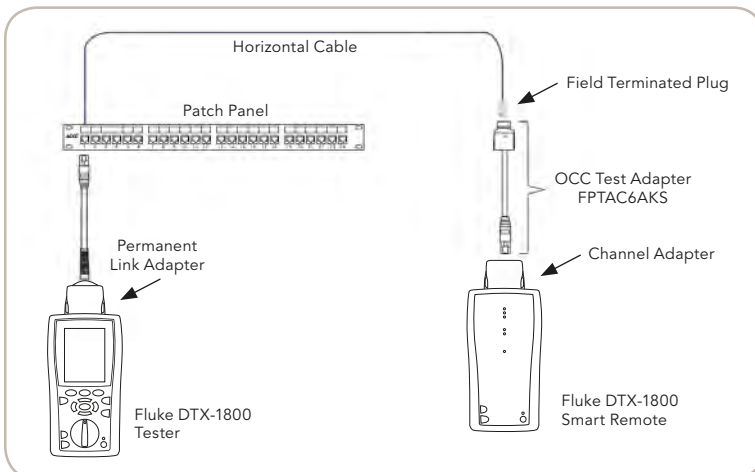

Modified Permanent Link with OCC Field Plug Test Adapter

 (8.1b) Patch Panels

## Category 6A Patch Panels

OCC's Category 6A Patch Panels offer a high-density solution for 10GBASE-T Ethernet applications. Our unshielded and shielded Cat 6A Patch Panels present a product solution that exceeds TIA Category 6A standards and achieves superior performance compliance. The Category 6A patch panel is ideal for end users who are looking for superior network performance to keep their infrastructure lasting well into the future.

- Guaranteed ISO and TIA Category 6A compliant
- Backward compatible to Category 3, 5e, and 6
- Offers mounting flexibility and removable cable strain-relief bar
- All-steel construction ensures panel rigidity and reliable terminations
- Can be easily mounted to any 19" rack or cabinet
- Patch panels are available in both flat and angled configurations
- Write-on label fields for port identification
- Supports all IEEE Power over Ethernet (PoE) standards
- Shielded panel kits include bonding jumper
- Patch panel kits include discrete modular jacks
  - K6A02 (UTP)
  - K6AS (STP)

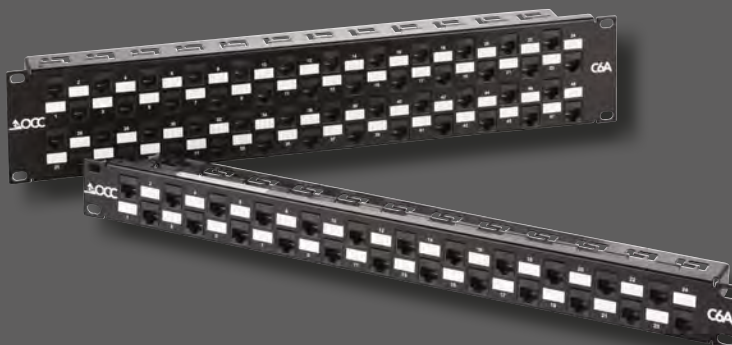

### Applications

- 10GBASE-T Ethernet
- 2.5G/5GBASE-T Gigabit Ethernet
- 1000BASE-T Gigabit Ethernet
- 100BASE-TX Fast Ethernet
- 10BASE-T Ethernet
- Broadband Video
- 155/622 Mbps ATM
- Analog Voice/VOIP
- PoE, PoE+, and PoE++



## Category 6A Patch Panels

PART NUMBER	DESCRIPTION
DCC2488/1106A	Patch panel, 24-port, Category 6A, UTP, 1RU, including K6A02 connectors
DCC4888/1106A	Patch panel, 48-port, Category 6A, UTP, 2RU, including K6A02 connectors
ACC2488/1106A	Patch panel, 24-port, Category 6A, UTP, 1RU, angled, including K6A02 connectors
ACC4888/1106A	Patch panel, 48-port, Category 6A, UTP, 2RU, angled, including K6A02 connectors
DCC2488/1106A-S	Patch panel, 24-port, Category 6A, shielded, 1RU, including K6AS connectors
DCC4888/1106A-S	Patch panel, 48-port, Category 6A, shielded, 2RU, including K6AS connectors
ACC2488/1106A-S	Patch panel, 24-port, Category 6A, shielded, 1RU, angled, including K6AS connectors
ACC4888/1106A-S	Patch panel, 48-port, Category 6A, shielded, 2RU, angled, including K6AS connectors





## Category 6A Patch Cords

To complete the link, OCC created Category 6A modular cords with guaranteed Cat 6A compliance that offer superior PSANEXT performance suitable for mitigation of alien crosstalk. These modular cords also improve the external noise immunity of structured communications cabling systems and EMI suppression through shielded cable and plug design. Overall, OCC's Cat 6A patch cords assist in creating a complete 10 Gigabit throughput system that is reliable for years to come.

- Guaranteed ISO and TIA Category 6A compliant
- 100% component performance tested
- Backward compatible with Category 3, 5e and 6
- Superior PSANEXT performance
- Superior PSAACR-F performance
- Superior EMI suppression
- Improves the external noise immunity of structured cabling systems
- LSZH or PVC cable construction
- Utilizes OCC's patented modular plug design
- Supports all IEEE Power over Ethernet (PoE) standards
- Insulation resistance: 500 MΩ minimum
  - Dielectric withstand: 1000 VAC RMS or 1414 VDC
  - DC current rating: 1.5 A per conductor at 20°C ambient de-rated to 0.75 A at 60°C ambient
- Center-tuned modular plugs
- Slim-line strain-relief boot
- Snagless design



## Category 6A Patch Cords

PART NUMBER	DESCRIPTION
PC6AU-B-xyyy	Category 6A patch cord with boot, PVC, UTP, UL listed
PC6AS-B-xyyy	Category 6A patch cord with boot, PVC, shielded, UL listed
Replace "xx" with length in feet; replace "yy" with color code – <b>05</b> = blue (standard) Ex: PC6AU-B-0305 = Category 6A patch cord with boot, 3 feet, blue (standard)	

Additional colors available. Contact OCC for ordering information.

INTERNATIONAL PART NUMBER	DESCRIPTION
IPC6AxxxByy	Category 6A patch cord with boot, UTP, PVC
IPC6AxxxByyLZH	Category 6A patch cord with boot, UTP, LSZH
ISPC6AxxxByy	Category 6A patch cord with boot, shielded, PVC
ISPC6AxxxByyLZH	Category 6A patch cord with boot, shielded, LSZH
Replace "xxx" with length in meters; replace "yy" with color code – <b>05</b> = blue (standard) Ex: IPC6A030B05 = Category 6A patch cord with boot, 3 meters, blue (standard)	

Additional colors available. Contact OCC for ordering information.

Please call 1-800-622-7711 and ask for a Sales Representative. We're ready to assist you.

## (8.2a) Outlet Jacks

### Category 6 KMJ Jacks and Couplers

OCC's KMJ jacks offer printed circuit board technology that provide best-in-class Category 6 component performance. With standard 110-style terminations, OCC's Category 6 KMJ jacks are ETL verified to TIA-568-C.2 Category 6 specifications.

- Meets IEC 60603-7 requirements
- ETL verified to TIA-568-C.2 Cat 6
- Category 6 component compliant
- 110-style IDC contacts exceed TIA-568-C.2 requirements
- Mounting flexibility
- Large, easy-to-read color-coded labels
- Universal T568A/B wiring for easy installation
- Long-term application confidence
- Backward compatible; Cat 3, 5, & 5e compliant
- Fits all OCC Keystone faceplates and surface mount boxes
- Slim-line design allows up to 48 ports in 1RU
- Insulation resistance: 500 MΩ minimum
  - Dielectric withstand: 1000 VAC RMS or 1414 VDC
  - DC current rating: 1.5 A per conductor at 20°C ambient de-rated to 0.75 A at 60°C ambient
- Supports all IEEE Power over Ethernet (PoE) standards
- One-piece stuffer cap included

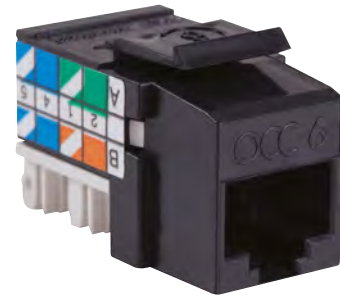

KMJ Cat 6 Jack



KMJ Cat 6 Coupler

### KMJ Category 6 Jacks and Couplers

PART NUMBER	DESCRIPTION
KMJA6xx	KMJ Category 6 jack, universal 568A/B wiring
KMJA650xx	KMJ Category 6 jack, universal 568A/B wiring, 50 pack
KMJA602S	KMJ Category 6 shielded jack, slim-line, universal 568A/B wiring
KMJ6EFT02	KMJ Category 6 in-line coupler, black

Replace "xx" with color code.

"XX" COLOR CODES*	
00 – Electrical Ivory	06 – Data Gray
01 – Office White	08 – Orange
02 – Black	09 – Yellow
03 – Red	10 – Purple
04 – Green	11 – Brown
05 – Blue	12 – Bright White

\*Colors may be subject to availability and minimum order quantities.

### Applications

- 2.5G/5GBASE-T Gigabit Ethernet
- 1000BASE-T Gigabit Ethernet
- 100BASE-TX Fast Ethernet
- 10BASE-T Ethernet
- 155/622 Mbps ATM
- Broadband Video
- Analog Voice/VOiP
- PoE, PoE+, and PoE++
- All other applications developed for operation over Category 6 cabling

## (8.2a) Outlet Jacks

### Category 6 UMJ Jacks

OCC's UMJ Category 6 jacks are world class performers with patented printed circuit board technology to provide true Category 6 component performance on all pair combinations. With a standard 110-style punch-down termination, our Category 6 UMJ style jacks are manufactured to comply with TIA component performance requirements and are ETL verified to TIA-568-C.2 Cat 6 standards.

- Meets IEC 60603-7 requirements
- 110-style IDC contacts exceed TIA-568-C.2 requirements
- ETL verified to TIA-568-C.2 Category 6
- Backward compatible; Cat 3, 5, and 5e compliant
- Full 6-position, modular plug compatible with bezel
- Universal T568A/B wiring for easy installation
- Available with 20 labeling and color options
- Secure mounting locks jack into faceplate
- Fits all OCC UMJ faceplates and surface mount boxes
- Insulation resistance: 500 MΩ minimum
  - Dielectric withstand: 1000 VAC RMS or 1414 VDC
  - DC current rating: 1.5 A per conductor at 20°C ambient de-rated to 0.75 A at 60°C ambient
- Supports all IEEE Power over Ethernet (PoE) standards
- One-piece stuffer cap included



### Applications

- 2.5G/5GBASE-T Gigabit Ethernet
- 1000BASE-T Gigabit Ethernet
- 100BASE-TX Fast Ethernet
- 10BASE-T Ethernet
- 155/622 Mbps ATM
- Broadband Video
- Analog Voice/VOiP
- PoE, PoE+, and PoE++
- All other applications developed for operation over Category 6 cabling

### Category 6 UMJ Jacks

PART NUMBER	DESCRIPTION
UMJA6	UMJ Category 6 Jack, universal 568A/B wiring, no bezel
UMJA6xx	UMJ Category 6 Jack, universal 568A/B wiring, colored bezel
UMJA650xx	UMJ Category 6 Jack, universal 568A/B wiring, 50 pack

Replace "xx" with color code.

"XX" COLOR CODES*	
00 – Electrical Ivory	06 – Data Gray
01 – Office White	08 – Orange
02 – Black	09 – Yellow
03 – Red	10 – Purple
04 – Green	11 – Brown
05 – Blue	12 – Bright White

\*Colors may be subject to availability and minimum order quantities.

 (8.2b) Patch Panels

### Category 6 Patch Panels

When Category 6 was introduced to the market, OCC brought a product offering that was designed to exceed industry expectations and surpass the governing standards. We created Category 6 connectivity components that offered patented technology and guaranteed bandwidth performance. OCC's Category 6 patch panels were no exception.

- Category 6 component compliant
- 610 punch-down block
- ETL verified to TIA-568-C.2 Category 6
- Power-safe modular jack contacts
- OCC patented PCB technology
- Backward compatible; Cat 3 & 5e
- Mounting flexibility
- Removable cable strain-relief bar
- Patch panels are available in both flat and angled configurations
- All-steel panel ensures panel rigidity and reliable terminations
- Universal T568A/B wiring for easy installation
- 6-port component modules
- Write-on label fields
- Rigid box-section panel construction
- Supports all IEEE Power over Ethernet (PoE) standards
- Insulation resistance: 500 M $\Omega$  minimum
  - Dielectric withstand: 1000 VAC RMS or 1414 VDC
  - DC current rating: 1.5 A per conductor at 20°C ambient de-rated to 0.75 A at 60°C ambient

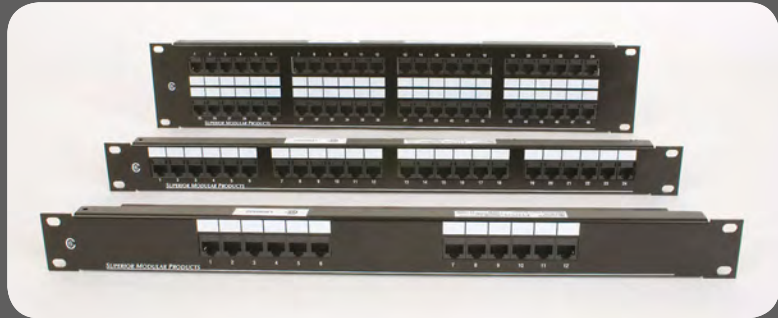

### Applications

- 2.5G/5GBASE-T Gigabit Ethernet
- 1000BASE-T Gigabit Ethernet
- 100BASE-TX Fast Ethernet
- 10BASE-T Ethernet
- 155/622 Mbps ATM
- Broadband Video
- Analog Voice/VOiP
- PoE, PoE+, and PoE++
- All other applications developed for operation over Category 6 cabling

### Category 6 Patch Panels

PART NUMBER	DESCRIPTION
PP12SIX	Wall-mount patch panel, 568A/B wired, 12-port, 89D bracket
PP1288/110A6	Wall-mount, hinged patch panel, 568A/B wired, 12-port
PP2488/110A6	Wall-mount patch, hinged panel, 568A/B wired, 24-port
DCC1288/110SIX	Rack-mount patch panel, 568A/B wired, 12-port, 1RU
DCC2488/110SIX	Rack-mount patch panel, 568A/B wired, 24-port, 1RU
DCC4888/110SIX	Rack-mount patch panel, 568A/B wired, 48-port, 2RU
DCC2488/110SIX-S	Rack-mount patch panel, 24-port, KMJ shielded jacks, 1RU
DCC4888/110SIX-S	Rack-mount patch panel, 48-port, KMJ shielded jacks, 2RU
ACC2488/110SIX	Rack-mount patch panel, angled, 568A/B wired, 24-port, 1RU
ACC4888/110SIX	Rack-mount patch panel, angled, 568A/B wired, 48-port, 2RU



PP2488/110A6 and PP1288/110A6

### Category 6 Patch Cords

OCC's Category 6 patch cords are the perfect complement to any OCC Category 6 copper solution. Our Category 6 patch cords are 100% component performance tested. OCC's test methods have formed the basis for standard patch cord component testing as specified in the TIA-568-C.2 standard.

- 100% component performance tested
- Exceeds TIA-568-C.2 Cat 6 specifications
- Custom lengths and colors available
- Shielded version available
- Supports all IEEE Power over Ethernet (PoE) standards
- Insulation resistance: 500 MΩ minimum
  - Dielectric withstand: 1000 VAC RMS or 1414 VDC
  - DC current rating: 1.5 A per conductor at 20°C ambient de-rated to 0.75 A at 60°C ambient
- Centered modular plugs
- Slim-line strain-relief boot
- Snagless design



### Applications

- 2.5G/5GBASE-T Gigabit Ethernet
- 1000BASE-T Gigabit Ethernet
- 100BASE-TX Fast Ethernet
- 10BASE-T Ethernet
- Broadband Video
- 155/622 Mbps ATM
- Analog Voice/VOiP
- PoE, PoE+, and PoE++
- All applications developed for operation over Category 6 or class E cabling

### Category 6 Patch Cords

PART NUMBER	DESCRIPTION
PCSIXxyy	Category 6 UTP patch cord without boot
PCSIXxxByy	Category 6 UTP patch cord with boot
PCSIXSxxByy	Category 6 shielded patch cord with boot

Replace "xx" with length in feet; replace "yy" with color code – **06** = gray, **01** = yellow  
 Ex: PCSIX03B01 = Category 6 patch cord, 3 feet, with boot, yellow

Additional colors available. Contact OCC for ordering information.

INTERNATIONAL PART NUMBER	DESCRIPTION
IPCSIXxxxByy	Category 6 patch cord with boot, UTP, PVC, class E
IPCSIXxxxByyLZH	Category 6 patch cord with boot, UTP, LSZH, class E
ISPCSIxxxxByy	Category 6 patch cord with boot, shielded, PVC, class E
ISPCSIxxxxByyLZH	Category 6 patch cord with boot, shielded, LSZH, class E

Replace "xxx" with length in meters; replace "yy" with color code – **06** = gray, **01** = yellow  
 Ex: IPCSIX030B06 = Category 6 patch cord, 3 meters, with boot, gray

Additional colors available. Contact OCC for ordering information.

Please call 1-800-622-7711 and ask for a Sales Representative. We're ready to assist you.

 (8.2d) 110 Blocks

## Category 6 110 Wiring Products

Whether installing a Category 5e or Category 6 system, OCC offers a complete solution with 110 block connectivity. OCC's 110 product line offers easy network cabling consolidation and quick transitions with maximum performance. From wall-mount to rack-mount 110 blocks and cable organizers, OCC's selection of products offers customers a solid backbone for an exceptional structured wiring solution.

- Exceeds industry standards for Category 6 specifications
- 110 blocks may be field terminated with 22-26 AWG solid wire
- Color-coded pairs for easy identification
- Designation labels included
- Order with legs when back-case routing
- Order without legs when depth is limited or when frame mounting
- 110 block may be kitted for easy installation



## Category 6 110 Wiring Products

PART NUMBER	DESCRIPTION
C64-10	Category 6 110 C-4 connector blocks, 10-pack
DCC48/110SIX*	Category 6 wall-mount 110 block, 48-pair, without legs
DCC48/110SIXL*	Category 6 wall-mount 110 block, 48-pair, with legs
DCC96/110SIX*	Category 6 wall-mount 110 block, 96-pair, without legs
DCC96/110SIXL*	Category 6 wall-mount 110 block, 96-pair, with legs
DCC288/110SIX*	Category 6 wall-mount 110 block, 288-pair, without legs
DCC288/110SIXL*	Category 6 wall-mount 110 block, 288-pair, with legs
DCC288/110SIXTWB	Category 6 wall-mount 110 tower, 288-pair, mounting frame
DCC288/110SIXTEXP	Category 6 wall-mount 110 tower, 288-pair, extension mounting frame
DCC96/110SIXRK	Category 6 rack-mount 110 block, kitted 96-pair
DCC192/110SIXRK	Category 6 rack-mount 110 block, kitted 192-pair
DCC288/110SIXRK	Category 6 rack-mount 110 block, kitted 288-pair

\*Place a "K" at the end of the part number for a complete kit.  
Ex: DCC48/110SIXLK = Category 6 wall-mount 110 block with legs and connectors

## Applications

- 2.5G/5GBASE-T Gigabit Ethernet
- 1000BASE-T Gigabit Ethernet
- 100BASE-TX Fast Ethernet
- 10BASE-T Ethernet
- Broadband Video
- 155/622 Mbps ATM
- Analog Voice/VOiP
- PoE, PoE+, and PoE++

## Category 6 110 Block Cable Organizers

PART NUMBER	DESCRIPTION
COH110	Wall-mount horizontal cable organizer without legs
COH110L	Wall-mount horizontal cable organizer with legs
COH110R	Rack-mount horizontal cable organizer, 19" width



### Category 5e KMJ Jacks and Couplers

The OCC Category 5e Keystone Modular Jack is a great alternative for high-density applications. Featuring a low profile, snap-in design and support for universal T568A/B wiring, the KMJ Cat5e jacks by OCC offer exceptional performance that exceeds industry standards. OCC's patented PC board technology provides component compliance to Cat5e specifications. Economy version Keystone jacks are also available that utilize a leadframe design and meet Cat5e link performance.

- Meets IEC 60603-7 requirements
- 110-style IDC contacts meet TIA-568-C.2 requirements
- Backward compatible; Cat 3, and Cat 5 compliant
- Universal T568A/B wiring for easy installation
- Available in 12 color options
- Fits all OCC Keystone faceplates and surface mount boxes
- Supports all IEEE Power over Ethernet (PoE) standards
- Insulation resistance: 500 MΩ minimum
  - Dielectric withstand: 1000 VAC RMS or 1414 VDC
  - DC current rating: 1.5 A per conductor at 20°C ambient de-rated to 0.75 A at 60°C ambient
- One-piece stuffer cap included



KMJ Cat 5e Jack



KMJ Cat 5e Coupler

### KMJ Jacks and Couplers

PART NUMBER	DESCRIPTION
KMJA5Exx	KMJ Category 5e jack, universal 568A/B wiring
KMJA5E50xx	KMJ Category 5e jack, universal 568A/B wiring, 50 pack
KMJ5EFT02	KMJ Category 5e in-line coupler, black
KMJVL8A/Bxx	KMJ Category 5e leadframe jack, universal 568A/B wiring
KMJVL8A/B50xx	KMJ Category 5e leadframe jack, universal 568A/B wiring, 50 pack
KMJVL8A/B02S	KMJ Category 5e leadframe shielded jack, universal 568A/B wiring

Replace "xx" with color code.

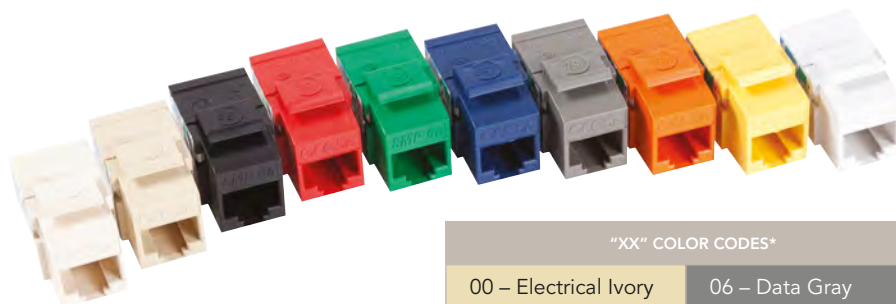

"XX" COLOR CODES*	
00 – Electrical Ivory	06 – Data Gray
01 – Office White	08 – Orange
02 – Black	09 – Yellow
03 – Red	10 – Purple
04 – Green	11 – Brown
05 – Blue	12 – Bright White

\*Colors may be subject to availability and minimum order quantities.

### Applications

- 2.5G/5GBASE-T Gigabit Ethernet
- 1000BASE-T Gigabit Ethernet
- 100BASE-TX Fast Ethernet
- 10BASE-T Ethernet
- Broadband Video
- 155/622 Mbps ATM
- Analog Voice/VOiP
- PoE, PoE+, and PoE++

 (8.3a) Outlet Jacks

## Category 5e UMJ Jacks

OCC's Category 5e Bezel Jacks utilize our patented PC board technology to exceed the TIA-568-C.2 Cat 5e requirements with headroom to spare. For a more cost-effective solution, OCC also offers a Leadframe Bezel Jack that utilizes our patented Leadframe technology. 110-style punch downs accommodate 22 AWG solid through 26 AWG solid and 24 AWG stranded conductors, and each OCC jack offers universal T568A/B wiring and performance enhancements to exceed industry standards.

- Meets IEC 60603-7 requirements
- 110-style IDC contacts meet TIA-568-C.2 requirements
- Backward compatible; Cat 3, and Cat 5 compliant
- Full 6-position, modular plug compatible with bezel
- Universal T568A/B wiring for easy installation
- Available with 20 labeling and color options
- Secure mounting locks jack into faceplate
- Fits all OCC UMJ faceplates and surface mount boxes
- Supports all IEEE Power over Ethernet (PoE) standards
- Insulation resistance: 500 M $\Omega$  minimum
  - Dielectric withstand: 1000 VAC RMS or 1414 VDC
  - DC current rating: 1.5 A per conductor at 20°C ambient de-rated to 0.75 A at 60°C ambient
- One-piece stuffer cap included



## UMJ Jacks

PART NUMBER	DESCRIPTION
UMJA5E	UMJ Category 5e jack, universal 568A/B wiring, no bezel
UMJA5Exx	UMJ Category 5e jack, universal 568A/B wiring, colored bezel
UMJA5E50xx	UMJ Category 5e jack, universal 568A/B wiring, 50-pack
UMJVL8A/B	UMJ Category 5e leadframe jack, universal 568A/B wiring, no bezel
UMJVL8A/Bxx	UMJ Category 5e leadframe jack, universal 568A/B wiring, colored bezel
UMJVL8A/B50xx	UMJ Category 5e leadframe jack, universal 568A/B wiring, 50-pack

Replace "xx" with color code.

"XX" COLOR CODES*	
00 – Electrical Ivory	06 – Data Gray
01 – Office White	08 – Orange
02 – Black	09 – Yellow
03 – Red	10 – Purple
04 – Green	11 – Brown
05 – Blue	12 – Bright White

\*Colors may be subject to availability and minimum order quantities.

## Applications

- 2.5G/5GBASE-T Gigabit Ethernet
- 1000BASE-T Gigabit Ethernet
- 100BASE-TX Fast Ethernet
- 10BASE-T Ethernet
- Broadband Video
- 155/622 Mbps ATM
- Analog Voice/VOiP
- PoE, PoE+, and PoE++

### Category 5e 110-Style Patch Panels

OCC's Category 5e patch panels incorporate our best design and application performance specifications ever. The Category 5e product line provides unmatched performance in on-premises connectivity. Designed for the most demanding network applications, OCC Category 5e patch panels offer customers the highest level of headroom to any Category 5e link or channel specification.

- Comfortably exceeds TIA-568-C.2 Cat 5e requirements
- ISO/IEC60603-7 compliant
- Patented PC board technology
- Constructed of cold rolled steel for durability
- Rigid design provides solid frame for high-impact punch-down tools
- Universal TIA 568A/B wiring configuration
- IDC's rated for 200 wire insertions
- Write-on label fields
- Cable strain-relief bar provided
- Patch panels are available in both flat and angled configurations
- Supports all IEEE Power over Ethernet (PoE) standards
- Insulation resistance: 500 MΩ minimum
  - Dielectric withstand: 1000 VAC RMS or 1414 VDC
  - DC current rating: 1.5 A per conductor at 20°C ambient de-rated to 0.75 A at 60°C ambient

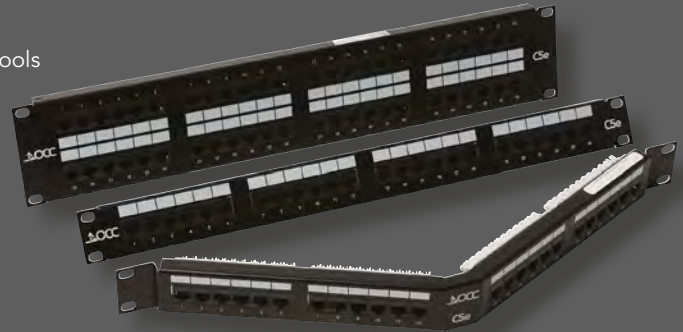

### Category 5e Patch Panels

PART NUMBER	DESCRIPTION
PP12A5E-R	Wall-mount patch panel, 568A/B wired, 12-port, with 89D bracket
PP1288/110A5E-R	Wall-mount, hinged patch panel, 568A/B wired, 12-port
PP2488/110A5E-R	Wall-mount, hinged patch panel, 568A/B wired, 24-port
DCC1288/110A5E-R	Rack-mount patch panel, 568A/B wired, 12-port, 1RU
DCC2488/110A5E-R	Rack-mount patch panel, 568A/B wired, 24-port, 1RU
DCC4888/110A5E-R	Rack-mount patch panel, 568A/B wired, 48-port, 2RU
ACC2488/110A5E-R	Rack-mount patch panel, angled, 568A/B wired, 24-port, 1RU
ACC4888/110A5E-R	Rack-mount patch panel, angled, 568A/B wired, 48-port, 2RU

### Applications

- 2.5G/5GBASE-T Gigabit Ethernet
- 1000BASE-T Gigabit Ethernet
- 100BASE-TX Fast Ethernet
- 10BASE-T Ethernet
- Broadband video
- 155/622 Mbps ATM
- Analog Voice/VOiP
- PoE, PoE+, and PoE++



PP2488/110A5E-R and PP1288/110A5E-R

 (8.3b) Patch Panels

### Category 5e – Shielded 110-Style

OCC's shielded Category 5e patch panels provide superior performance with an extra level of security. A removable cover protects against external noise and offers easy access for termination.

- Comfortably exceeds TIA-568-C.2 Category 5e standards
- ISO/IEC 60603-7 compliant
- Fully shielded RJ45 jacks
- Patented PC board technology
- Rigid design provides solid frame for high-impact punch-down tools
- 110-style punch down for easy terminations
- IDC's rated for 200 wire insertions
- Write-on label fields
- Removable cable strain-relief bar attaches directly to panel
- Removable cover for protection from EMI and RFI emissions
- Supports all IEEE Power over Ethernet (PoE) standards
- Insulation resistance: 500 M $\Omega$  minimum
  - Dielectric withstand: 1000 VAC RMS or 1414 VDC
  - DC current rating: 1.5 A per conductor at 20°C ambient de-rated to 0.75 A at 60°C ambient

### Applications

- 2.5G/5GBASE-T Gigabit Ethernet
- 1000BASE-T Gigabit Ethernet
- 100BASE-TX Fast Ethernet
- 10BASE-T Ethernet
- Broadband video
- 155/622 Mbps ATM
- Analog Voice/VOIP
- PoE, PoE+, and PoE++



## Category 5e Shielded Patch Panels

PART NUMBER	DESCRIPTION
DCC2488/110SAB	Rack-mount patch panel, shielded, 110-style, 568A/B wired, 8-port modules, 24-port, 1RU

### Category 5e Patch Cords

OCC's Category 5e patch cords are manufactured to strict standards and 100% tested to ensure compliance with TIA-568-C.2 component performance requirements. After all, OCC's test methods for patch cord component testing have helped form the basis for the Category 5e standards. This commitment to guaranteed performance is what makes our Category 5e patch cords an excellent addition to any OCC Category 5e structured cabling system.

- 100% component performance tested
- Exceeds TIA-568-C.2 Category 5e requirements
- Custom lengths and colors available
- Compliant with Power over Ethernet (PoE+) requirements
- Insulation resistance: 500 MΩ minimum
  - Dielectric withstand: 1000 VAC RMS or 1414 VDC
  - DC current rating: 1.5 A per conductor at 20°C ambient de-rated to 0.75 A at 60°C ambient

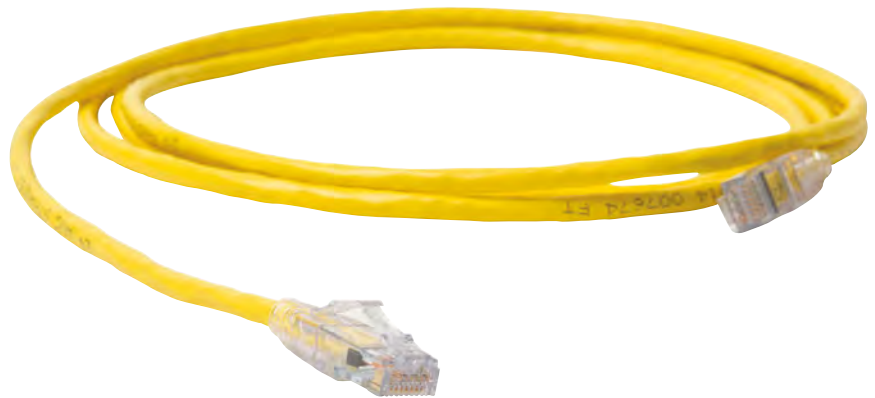
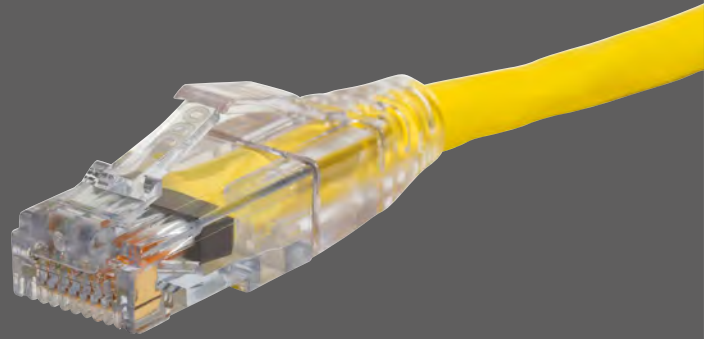

#### Applications

- 2.5G/5GBASE-T Gigabit Ethernet
- 1000BASE-T Gigabit Ethernet
- 100BASE-TX Fast Ethernet
- 10BASE-T Ethernet
- Broadband Video
- 155/622 Mbps ATM
- Analog Voice/VOiP
- Supports all IEEE Power over Ethernet (PoE) standards
- All applications developed for operation over Category 5e or class D cabling

### Category 5e Patch Cords

PART NUMBER	DESCRIPTION
PC5EBxxyy	Category 5e patch cord without boot, UTP
PC5EBxxByy	Category 5e patch cord with boot, UTP
Replace "xx " with length in feet; replace "yy" with color code – <b>06</b> = gray, <b>01</b> = yellow Ex: PC5EB03B01 = Category 5e patch cord, 3 feet, with boot, yellow	

Additional colors available. Contact OCC for ordering information.

INTERNATIONAL PART NUMBER	DESCRIPTION
IPC5ExxxByy	Category 5e patch cord with boot, UTP, PVC, class D
IPC5ExxxByyLZH	Category 5e patch cord with boot, UTP, LSZH, class D
ISPC5ExxxByy	Category 5e patch cord with boot, shielded, PVC, class D
ISPC5ExxxByyLZH	Category 5e patch cord with boot, shielded, LSZH, class D
Replace "xxx " with length in meters; replace "yy" with color code – <b>06</b> = gray, <b>01</b> = yellow Ex: IPC5E030B06 = Category 5e patch cord, 3 meters, with boot, gray	

Additional colors available. Contact OCC for ordering information.

Please call 1-800-622-7711 and ask for a Sales Representative. We're ready to assist you.



 (8.3d) 110 Blocks

## Category 5e 110 Blocks

Whether installing a Category 5e or Category 6 system, OCC offers a complete solution with 110 block connectivity. OCC's 110 product line offers easy network cabling consolidation and quick transitions with maximum performance. From wall-mount to rack-mount 110 blocks and cable organizers, OCC's selection of products offers customers a solid backbone for an exceptional structured wiring solution.

- Exceeds industry standards for Category 5e specifications
- 110 blocks may be field terminated with 22-26 AWG solid wire
- Color-coded pairs for easy identification
- Designation labels included
- Order with legs when back-case routing
- Order without legs when depth is limited or when frame mounting
- 110 block may be kitted for easy installation



## Category 5e 110 Wiring Products

PART NUMBER	DESCRIPTION
C410	Category 5e 110 C-4 connector blocks, 10-pack
C510	Category 5e 110 C-5 connector blocks, 10-pack
DCC50/110EFS*	Category 5e wall-mount 110 block, 50-pair, without legs
DCC50/110EFSL*	Category 5e wall-mount 110 block, 50-pair, with legs
DCC100/110EFS*	Category 5e wall-mount 110 block, 100-pair, without legs
DCC100/110EFSL*	Category 5e wall-mount 110 block, 100-pair, with legs
DCC300/110EFS*	Category 5e wall-mount 110 block, 300-pair, without legs
DCC300/110EFSL*	Category 5e wall-mount 110 block, 300-pair, with legs
DCC300/110EFSTWB	Category 5e wall-mount 110 tower, 300-pair, mounting frame
DCC300/110EFSTEXP	Category 5e wall-mount 110 tower, 300-pair, extension mounting frame
DCC100/110EFSRK	Category 5e rack-mount 110 block, kitted 100-pair
DCC200/110EFSRK	Category 5e rack-mount 110 block, kitted 200-pair
DCC300/110EFSRK	Category 5e rack-mount 110 block, kitted 300-pair

\*Place a "K" at the end of the part number for a complete kit.

Ex: DCC50/110EFSLK = Category 5e wall-mount 110 block with legs and connectors

## Applications

- 2.5G/5GBASE-T Gigabit Ethernet
- 1000BASE-T Gigabit Ethernet
- 100BASE-TX Fast Ethernet
- 10BASE-T Ethernet
- Broadband Video
- 155/622 Mbps ATM
- Analog Voice/VOiP
- PoE, PoE+, and PoE++

## Cable Organizers

PART NUMBER	DESCRIPTION
COH110	Wall-mount horizontal cable organizer without legs
COH110L	Wall-mount horizontal cable organizer with legs
COH110R	Rack-mount horizontal cable organizer, 19" width



## (8.4a) Outlet Jacks

### Category 3 KMJ Voice Grade Jacks

For voice-grade applications, OCC offers a Keystone Modular Jack that exceeds performance specifications of any Category 3 requirement. OCC's KMJ Category 3 Jacks offer easy installations with 110-style terminations on back for 26, 24, and 22 AWG solid conductors and deliver unsurpassed performance, keeping with OCC's guarantee for consistent performance.

- Meets IEC 60603-7 requirements
- 110-style IDC contacts
- Available in 12 color options
- Fits all OCC Keystone faceplates and surface mount boxes
- Supports all IEEE Power over Ethernet (PoE) standards
- Insulation resistance: 500 MΩ minimum
  - Dielectric withstand: 1000 VAC RMS or 1414 VDC
  - DC current rating: 1.5 A per conductor at 20°C ambient de-rated to 0.75 A at 60°C ambient
- One-piece stuffer cap included



### KMJ Category 3 Jacks

PART NUMBER	DESCRIPTION
KMJL8A/Bxx	KMJ jack 568A/B, 8x8 leadframe, 110-style
KMJL06Uxx	KMJ jack USOC, 6x6 leadframe, 110-style
Replace "xx" with color code below.	

### Category 3 UMJ Voice-Grade Jacks

OCC's Category 3 Jacks offer customers OCC's patented Leadframe technology for a cost-effective solution for voice-grade systems. 110-style IDC connectors support 26, 24, and 22 AWG solid conductors and make OCC's Category 3 Jacks easy to install with unmatched performance. Add the locking color/icon bezel to provide distinctive jack identification.

- Meets IEC 60603-7 requirements
- 110-style IDC contacts
- Available with 20 labeling and color options
- Secure mounting locks jack into faceplate
- Fits all OCC UMJ faceplates and surface mount boxes
- Supports all IEEE Power over Ethernet (PoE) standards
- Insulation resistance: 500 MΩ minimum
  - Dielectric withstand: 1000 VAC RMS or 1414 VDC
  - DC current rating: 1.5 A per conductor at 20°C ambient de-rated to 0.75 A at 60°C ambient
- One-piece stuffer cap included



### UMJ Category 3 Jacks

PART NUMBER	DESCRIPTION
UMJL06U	USOC 6x6 leadframe, 110-style, no bezel
UMJL06Uxx	USOC 6x6 leadframe, 110-style, colored bezel
UMJL08Uxx	USOC 8x8 leadframe, 110-style, colored bezel
UMJL08A/B	568A/B, 8x8 leadframe, 110-style, no bezel
UMJL08A/Bxx	568A/B, 8x8 leadframe, 110-style, colored bezel
Replace "xx" with color code.	

"XX" COLOR CODES*	
00 – Electrical Ivory	06 – Data Gray
01 – Office White	08 – Orange
02 – Black	09 – Yellow
03 – Red	10 – Purple
04 – Green	11 – Brown
05 – Blue	12 – Bright White

\*Colors may be subject to availability and minimum order quantities.

(8.4b) Patch Panels

Voice-Grade Telco

The same cross-connect solutions available for Ethernet applications are also available for PBX equipment. For these applications, OCC offers Voice-Grade Telco Patch Panels, which break out to 24-RJ45 jacks. Customers can easily patch their phone system into the permanent link by simply using patch cords and open-ended cable assemblies punched down to a 110 block, 66 block, or 110 patch panel.

- Patented PC board technology
- 25-pair male Telco connectors allow for quick connects and easy installations
- Write-on label fields
- IKON compatible – 12 colors
- Supports all IEEE Power over Ethernet (PoE) standards
- Insulation resistance: 500 MΩ minimum
  - Dielectric withstand: 1000 VAC RMS or 1414 VDC
  - DC current rating: 1.5 A per conductor at 20°C ambient de-rated to 0.75 A at 60°C ambient



Voice-Grade Telco Patch Panels

PART NUMBER	DESCRIPTION
DCC2482/2502	Rack-mount patch panel, telco interface panel, 8-pos., 2-wire, USOC, 24-port
DCC4882/2502	Rack-mount patch panel, telco interface panel, 8-pos., 2-wire, USOC, 48-port
DCC2482/VG224	Rack-mount patch panel, telco interface panel, 8-pos., 2-wire, USOC, 24-port, numbered 0–23 consistent with Cisco VG224 analog module

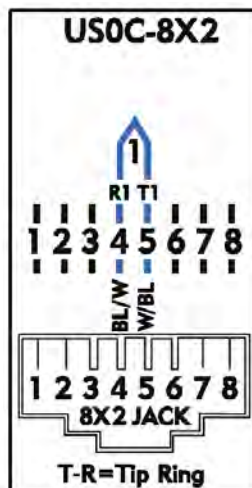

## Snap-in Multimedia Panels

The ability to be flexible and adaptable to each customer's unique needs has been OCC's specialty for years. With OCC's Snap-In Multimedia patch panels, any combination of UMJ or KMJ style jacks and adapters can be chosen to configure a custom patch panel. All multimedia patch panels are mountable in any 19" rack.

- Panel designs to accept either UMJ or KMJ jacks and adapters
- Constructed of extruded aircraft-grade aluminum for durability
- Write-on label fields
- Compliant with Power over Ethernet (PoE+) requirements



## Snap-In Multimedia Patch Panels

PART NUMBER	RU	DESCRIPTION
AK24	1	Rack-mount field configurable panel, KMJ, 24-port
AK48H	2	Rack-mount field configurable panel, KMJ, 48-port
AK481U	1	Rack-mount field configurable panel, KMJ, 48-port, high density
ACC24K	1	Rack-mount field configurable panel, angled KMJ, 24-port
ACC48K	2	Rack-mount field configurable panel, angled KMJ, 48-port
ACC48K1U	1	Rack-mount field configurable panel, angled KMJ, 48-port
AKXG241U	1	Rack-mount field configurable panel, KMJ, 24-port, for 6A UTP systems
AK48U6A	2	Rack-mount field configurable panel, KMJ, 48-port, for 6A UTP systems
ACCXG6A24-UTP	1	Rack-mount field configurable panel, angled KMJ, 24-port, for 6A UTP systems
AK24STP	1	Rack-mount field configurable panel, shielded, KMJ, 24-port
AK48STP	2	Rack-mount field configurable panel, shielded, KMJ, 48-port
ACC24KS1U	1	Rack-mount field configurable panel, shielded, angled, KMJ, 24-port
ACC48KS	2	Rack-mount field configurable panel, shielded, angled, KMJ, 48-port
ACC48KS1U	1	Rack-mount field configurable panel, shielded, angled, KMJ, 48-port
A24	2	Rack-mount field configurable panel, UMJ, 24-port
A48H	2	Rack-mount field configurable panel, UMJ, 48-port, high-density



## (8.6a) R-Jack® Industrial RJ-45 Solution

### Overview

The R-JACK® Ethernet Connector provides an efficient, comprehensive and affordable solution for Ethernet connectivity in harsh and environmentally challenging applications. Unlike low quality plastic RJ-45 receptacles, R-JACK is designed to ensure guaranteed performance and durability even in the harshest conditions. In addition, R-JACK provides a variety of options, including pre-kitted solutions that are designed to integrate seamlessly with industrial and hardened environment applications.



### Features & Benefits

- **Compact design that delivers optimum protection.** R-JACK jam nut (ECRK) and flange mount (ECDR) type receptacles provide higher panel density than current MIL-DTL-38999 style products. For customers wanting to upgrade to R-JACK, a MIL-DTL-38999/24 shell size 19 style jam nut receptacle (ECRJ) is available to fit existing panel cutouts. A common cable strain relief for plugs and receptacles accommodates both small and large cable diameters, complete with compressive fittings for shielded cable. R-JACK receptacles offer a 100% transversely sealed (IP-68) configuration option, preventing dust, water or moisture penetration, with or without dust cap or plug engagement.
- **Designed for integration.** R-JACK is designed to work with jam nut, flange-mount, in-line receptacle and plug options. OCC also offers completed R-JACK harness assemblies for drop-in-place applications. Pre-kitted solutions, including gaskets, O-rings, mounting brackets, and hardware, make it easier for customers to procure, install and integrate these components.
- **Comprehensive shielding performance.** R-JACK plugs, receptacles, and backshells are designed to establish grounding between shielded cord sets, as well as between cord set and chassis ground. When immunity to electromagnetic interference is critical, the R-JACK's EMC/EMI shielding capabilities also provide exceptional protection.

### Applications

- 10/100/1000BASE-T Ethernet
- POE, POE+, and POE++
- DATA, VOiP, and IPTV in Harsh Environments
- Radar Systems
- Industrial Process Control
- Mobile Equipment Transit Cases
- Data Acquisition and Control
- Shelters
- Battlefield Communication Systems





## (8.6a) R-Jack® Industrial RJ-45 Solution – Features and Benefits



Available with 360° EMC/EMI shielding without the use of additional hardware, which makes them the smallest EMC/EMI compliant RJ-45 connection on the market.

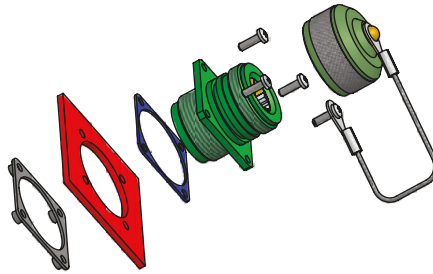

OCC offers fully kitted R-JACK solutions that can include receptacle, dust cover, back plate, hardware and gasket as a single part number.



R-JACK tested assemblies are available from OCC and ready for installation.



IP-68 compliant seal with or without the dust cover engaged or when mated. Unique internal seal eliminates the need for potting or other special compounds.



The compression nut provides cable sealing and strain relief. It is designed to work with cable braid to form a 360° ground plane.



Numerous options, including mounting hardware, conductive O-rings, and gasket materials, are available.

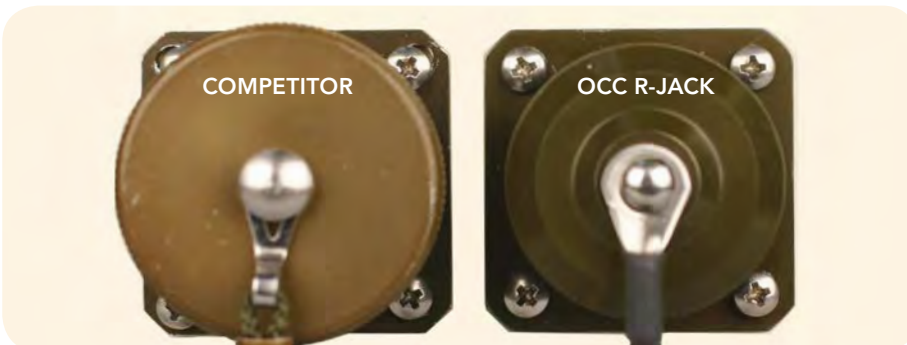

R-JACK achieves higher panel density due to its smaller form factor dust cap. R-JACK conforms to MIL-DTL-83723 and MIL-DTL-38999 mechanical panel cutout specifications.



R-JACK plugs intermate with OCC jam nut, flange-mount or in-line receptacles to provide a complete mating solution.

**(8.6a) R-Jack® Industrial RJ-45 Solution – Performance Specifications**

## Performance Specifications

PARAMETER	SPECIFICATION	PERFORMANCE
Insertion loss	IEEE 802.3, LX	1000BASE-T, NXT, FXT
Temperature cycling	TIA-364-32, 25 cycles	-45°C to +100°C
Temperature shock	TIA-364-32C, 5 cycles	-40°C to +100°C
Humidity resistance	TIA-364-31B, 21 days	43°C, 98% humidity
Water submersion	IP-68, IEC-60529	1M depth, 48 hrs.
Dust test	IP-68, IEC-60529	20mBARS air pressure, 8 hrs.
Mechanical shock	TIA-364-27	100G, 6ms, half sine, 6 directions
Vibration	TIA-364-28	Test Condition IV, 4 hrs. per axis, 12 hrs./total
Matting durability	TIA-364-09	500 mate/demate cycles
Flammability	Per UL94	Compliant to V0, V1, 10 sec. each
Salt spray	TIA-364-26	500 hrs.
Shell-to-shell conductivity Available with all plating/material options except Anodize	TIA-364-83	1A @ 1.5VDC, 100 hrs.
Electromagnetic shielding effectiveness	IEEE-STD-299	20kHz, 150kHz, 14MHz, 400MHz, 600MHz, 1GHz, 2GHz, 8GHz, 10GHz, vert. and horz., <-60dB
Hi-pot high-voltage test	EN61010-1	600VAC-60Hz, 900uA, Ramp=10 sec., (8 channels)
Transmission performance	TIA-568-C.2	Category 6 channel



ECRJ jam nut receptacle (fits D38999/24 jam nut cutout) aluminum black anodized



ECRA plug; 303 stainless steel



Receptacle paddle board; aluminum zinc nickel. Consult OCC for desired options



ECRP in-line receptacle; aluminum black anodized



ECRP in-line receptacle, aluminum zinc nickel



ECRK jam nut receptacle; aluminum electroless nickel



## (8.6a) R-Jack® Industrial RJ-45 Solution – Ordering Information



### R-JACK Connector:

ECR A 0 1 0 2 U A 0

#### CONFIGURATION TYPE

- A Plug (compatible with D, F, G, J, K, H and P style receptacles)
- D Receptacle, flange mnt, front/rear mnt., no mnt. hardware
- F Receptacle, flange mnt, w/pem nuts and hardware
- G Receptacle, flange mnt, front/rear mnt., w/mnt. screws/l. nuts
- H Receptacle, flange mnt, mnt. bracket and screws
- J Receptacle, jam nut, FITS D38999/24 cutout, M83723/60
- K Receptacle, jam nut, small profile, rear mnt.
- P Receptacle, in-line
- U Accessories (backshell, dust caps)

#### DUST CAP

- 0 None
- 1 Female, metal, collar and lanyard jam nut (ECRJ) receptacle only
- 2 Female, metal, collar and lanyard for jam nut (ECRK) receptacle
- 3 Female, metal, eyelet and lanyard for flange mnt (ECRD, F, G & H) receptacle
- 4 Male, metal, crimp sleeve and lanyard for plug (ECRA)
- 5 Female, metal, crimp and lanyard for in-line receptacle (ECRP)

#### EMC SHIELDING

- 1 EMC Shielding (includes metal shroud, conduction gasket, O-ring)
- 2 No EMC shielding (default for dust cap, backshell or plug)

*All plug options are EMI/EMC compliant except aluminum black anodized*

#### INSERT SEALING

- 0 Sealed transversely (Applies to receptacles with or without dust caps)
- 1 Not sealed transversely

*All Plugs are specified with "1" as the sealing option.*

#### STRAIN-RELIEF (CABLE O.D.)<sup>4</sup>

- 0 Not applicable
- A Straight backshell, 0.190–0.270" O.D.
- B Straight backshell, 0.271–0.330" O.D.
- E Strain-relief clamp 0.190–0.286" O.D.

#### KEYING

- U Key 1 (default)
- V Key 2
- W Key 3
- Y Key 4

#### PLATING AND MATERIAL OPTIONS<sup>3</sup>

- 1 Aluminum, black anodize
- 2 Aluminum, electroless nickel<sup>1</sup>
- 3 Aluminum, zinc nickel<sup>2</sup>
- 4 303 stainless steel, passivate<sup>1,2</sup>
- 5 316 stainless steel, passivate<sup>1,2</sup>
- 6 Naval Brass<sup>1,2</sup>
- 8 Aluminum, nickel teflon<sup>1</sup>
- 9 Free machining brass<sup>1</sup>

#### NOTES:

- 1 Use this type of plating/material for EMI/EMC applications.
- 2 Finish options 4, 5, 6, and 9 are special order only.
- 3 All plating/material options for aluminum anodized are conductive.
- 4 Straight backshells can accommodate braided and unbraided style cables.

## (8.6b) DIN-RAIL Enclosures – Copper

### Overview

OCC's line of DIN Rail fiber optic and copper enclosures offers rugged and versatile solutions ideal for secure terminations within industrial settings. Using OCC's 600-series adapter plates, the DTC product family is based on a proven design that offers versatility and ease of installation. The enclosures can accommodate one or two OCC adapter plates, and include a splice block for fusion splicing up to 12 fibers. Velcro cable ties for managing proper cable bend radius are also included. The DIN Rail enclosure features a fixed outer housing and a sliding inner housing with a hinged door that provides access to the terminated cable. A capture screw secures the inner housing and can be removed in order to detach the inner housing completely from the enclosure. Upgrades or modifications to the existing network structure can be made as easily as changing an adapter plate.



In addition, the DIN Rail enclosures are manufactured with a robust all-metal construction that protects the cable terminations in even the most adverse environmental conditions. Its compact size allows for minimum space requirements when installed in control cabinets. And most importantly, this uncomplicated family of enclosures for industrial communications fits nicely with the entire line of fiber optic connectivity components and cable from OCC.

### Features & Benefits

- Accommodates both copper (shielded and unshielded) and fiber connectivity
- Compact size for limited space requirements
- Quick snap-on installation onto any standard 35mm DIN rail
- Sliding inner housing with hinged door and capture screw simplifies installations
- All-metal construction ensures durable and reliable terminations
- Interior cable management for proper bend radius requirements
- Options for cable entry and exit grommets or glands
  - Grommet hole size 1" diameter
  - Cable gland can accommodate 0.250–0.485" cable OD
- Grounding screws included for equipment protection
- Can be kitted, pre-loaded or factory pre-terminated

### Applications

- Industrial Automation
- Transportation
- Oil & Gas
- Power Generation and Transmission
- Mining



## (8.6b) DIN-RAIL Enclosures – Copper



### DIN Rail Enclosures

PART NUMBER	DESCRIPTION
DTC1AP	DIN Rail Enclosure, accommodates 1 adapter plate, cable entry grommet, black, empty
DTC2AP	DIN Rail Enclosure, accommodates 2 adapter plates, cable entry grommet, black, empty
DTC1APG	DIN Rail Enclosure, accommodates 1 adapter plate, liquid tight cable gland, black, empty
DTC2APG	DIN Rail Enclosure, accommodates 2 adapter plates, liquid tight cable gland, black, empty

### Copper Adapter Plates

PART NUMBER	DESCRIPTION	PART NUMBER	DESCRIPTION
605AKX	5-port unloaded adapter plate for KMJ jacks	604AX	4-port unloaded adapter plate for UMJ jacks
K6Axx	Category 6A KMJ jack	U6Axx	Category 6A UMJ jack
K6AS	Category 6A shielded KMJ jack	UMJA6xx	Category 6 UMJ jack
KMJA6xx	Category 6 KMJ jack	UMJA5Exx	Category 5e UMJ jack
KMJA602S	Category 6 shielded KMJ jack	BE08Sxx	Shuttered bezel for UMJ jacks
KMJA5Exx	Category 5e KMJ jack		
KMJA5E02S	Category 5e shielded KMJ jack		

Replace "xx" with color code: 00=Electrical ivory, 01=Office white, 02=Black, 03=Red, 04=Green, 05=Blue, 06=Data Gray, 08=Orange, 09=Yellow, 10=Purple, 11=Brown, 12=Bright white.

See pg. 230–233 for Fiber Optic Adapter Plates.

## (8.7a) Category 5e Pre-Terminated Cable Assemblies

### Gigabit Ethernet Telco

High-speed data connections are essential for keeping pace with today's business climate. OCC took this into consideration when developing patch panels that offered 1000BASE-T Gigabit Ethernet performance. The performance not only exceeds industry standards, but OCC's Gigabit Ethernet Patch Panels are also 100% component tested in the factory, guaranteeing the customer worry-free installations.



- Exceeds TIA-568-C.2 specifications
- ISO/IEC 60603-7 compliant
- Patented PC board technology
- All-steel construction for durability
- Each female Telco connector is split out to 6 RJ45 ports in TIA T568A or T568B configuration supporting 1000BASE-T applications
- Fast and easy installations
- Write-on label fields
- Fully adjustable cable management support bar and bend radius requirements
- UTP patch panels are IKON compatible – 12 colors
- Use with OCC Telco Category 5e cable assemblies
- Supports all IEEE Power over Ethernet (PoE) standards
- Insulation resistance: 500 MΩ minimum
  - Dielectric withstand: 1000 VAC RMS or 1414 VDC
  - DC current rating: 1.5 A per conductor at 20°C ambient de-rated to 0.75 A at 60°C ambient



### Applications

- 1000BASE-T Gigabit Ethernet
- 100BASE-TX Fast Ethernet
- 10BASE-T Ethernet
- Broadband video
- 155/622 Mbps ATM
- Analog Voice/VOiP
- PoE, PoE+, and PoE++

## Category 5e Gigabit Ethernet Patch Panels

PART NUMBER	DESCRIPTION
PP2488/25V01	Wall-mount patch panel, gigabit telco, 568B wired, 24-port
DCC24A/GBASET21	Rack-mount patch panel, gigabit telco, 568A wired, 24-port with cover
DCC24B/GBASET21	Rack-mount patch panel, gigabit telco, 568B wired, 24-port with cover
DCC48A/GBASET21	Rack-mount patch panel, gigabit telco, 568A wired, 48-port with cover
DCC48B/GBASET21	Rack-mount patch panel, gigabit telco, 568B wired, 48-port with cover
DCC2488/25S-01	Rack-mount patch panel, shielded gigabit telco, 568B wired, 24-port with cover
ACC2488/25V01	Rack-mount patch panel, angled, gigabit telco, 568B wired, 24-port, 1RU
ACC4888/25V01	Rack-mount patch panel, angled, gigabit telco, 568B wired, 48-port, 2RU

## (8.7a) Category 5e Pre-Terminated Cable Assemblies

### Category 5e Cable Assemblies

Because the industry demands systems with faster installation times and less network interruption, OCC developed a modular solution to meet those specific communications cabling needs. Using 25-pair Category 5e Telco cable assemblies, coupled with our Category 5e Telco patch panels, OCC created a solution that is as easy as Plug-and-Play. OCC's pre-terminated 25-pair cabling solution continues to provide flexibility and high performance.

Each 25-pair assembly is designed to support new interface technology of leading switch manufacturers. Constructed to exceed EIA/TIA Category 5e specifications, OCC's Telco assemblies offer guaranteed Gigabit Ethernet throughput. From rack-mount to zone distribution, OCC's PowerSum-Rated 5e assemblies offer a wide variety of options to meet 10/100 and Gigabit Ethernet solutions.

- Exceeds TIA Category 5e specifications
- Utilizes UL certified Cat 5e 25-pair cable
- Cable assemblies are 100% performance tested
- All Telco-to-Telco assemblies are male-to-male
- All Hydra cable assemblies are manufactured with precise leg measurements to span 19" racks or a stand-alone switch
- Works with high-density 48-port blades
- 50-pin Telco connectors available in 110° or 180° cable exit angles
- Available with right, left, or straight connectors – plenum rated or non-plenum cable

TELCO WIRING (MALE) TABLE			
R=RING	POS	POS	T=TIP
BLUE WHITE	1R	T26	WHITE BLUE
ORANGE WHITE	2R	T27	WHITE ORANGE
GREEN WHITE	3R	T28	WHITE GREEN
BROWN WHITE	4R	T29	WHITE BROWN
SLATE WHITE	5R	T30	WHITE SLATE
BLUE RED	6R	T31	RED BLUE
ORANGE RED	7R	T32	RED ORANGE
GREEN RED	8R	T33	RED GREEN
BROWN RED	9R	T34	RED BROWN
SLATE RED	10R	T35	RED SLATE
BLUE BLACK	11R	T36	BLACK BLUE
ORANGE BLACK	12R	T37	BLACK ORANGE
GREEN BLACK	13R	T38	BLACK GREEN
BROWN BLACK	14R	T39	BLACK BROWN
SLATE BLACK	15R	T40	BLACK SLATE
BLUE YELLOW	16R	T41	YELLOW BLUE
ORANGE YELLOW	17R	T42	YELLOW ORANGE
GREEN YELLOW	18R	T43	YELLOW GREEN
BROWN YELLOW	19R	T44	YELLOW BROWN
SLATE YELLOW	20R	T45	YELLOW SLATE
BLUE VIOLET	21R	T46	VIOLET BLUE
ORANGE VIOLET	22R	T47	VIOLET ORANGE
GREEN VIOLET	23R	T48	VIOLET GREEN
BROWN VIOLET	24R	T49	VIOLET BROWN
SLATE VIOLET	25R	T50	VIOLET SLATE



### Applications

- 1000BASE-T Gigabit Ethernet
- 100BASE-TX Fast Ethernet
- 10BASE-T Ethernet
- Broadband Video
- 155 Mbps ATM
- Analog Voice/VoIP
- PoE, PoE+, and PoE++

## Telco-to-Telco Cable Assemblies

### 25-Pair Telco-to-Telco Cable Assemblies

PART NUMBER						DESCRIPTION
25	/		-	-	-	25-pair Telco-to-Telco cable assembly

CONNECTOR TYPE	END TYPE	END TYPE	CABLE TYPE & CATEGORY	LENGTH IN FEET
PA UTP	TR Telco Right	TR Telco Right	5E Cat 5e CMR	
	TL Telco Left	TL Telco Left	EP Cat 5e CMP	
	TS Telco Straight	TS Telco Straight		
		X Blunt End – No Connector		

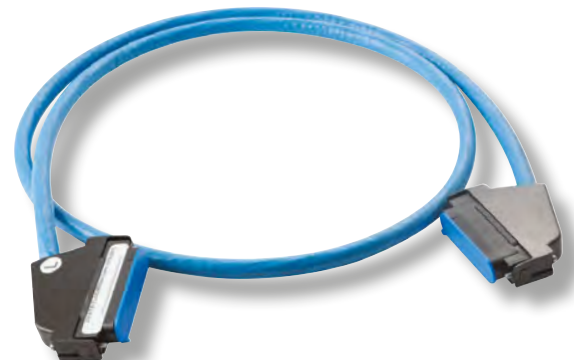

**Example:** 25PA/TR-TR-5E-100 =  
25-pair cable assembly with Telco Right to Telco Right, Cat 5e riser, 100 feet

## (8.7a) Category 5e Pre-Terminated Cable Assemblies

### Hydra Cable Assemblies

#### 25-Pair Telco-to-Gigabit Hydra Cable Assemblies (6 Legs)

PART NUMBER						DESCRIPTION
25PA/			6		-	25-pair telco-to-hydra cable assembly
END TYPE	END TYPE	CABLE TYPE & CATEGORY		LENGTH IN FEET		
<b>TR</b> Telco Right	<b>HR</b> Hydra Right	<b>5E</b> Cat 5e Riser				
<b>TL</b> Telco Left	<b>HL</b> Hydra Left	<b>EP</b> Cat 5e Plenum				
<b>TS</b> Telco Straight	<b>HSxx*</b> Hydra Straight					
<b>X</b> Blunt End – No Connector	*Replace "xx" with length of legs (12 or 24)					

\*Must use B-wired Telco panel with 6-Leg Gigabit Hydra Assemblies

**Example:** 25PA/TRHS1265E-025 = 25-Pair Cable Assembly with Telco Right to Gigabit Hydra Straight, 6 Legs at 12", Cat 5e Riser, 25 Feet

#### 25-Pair Telco to 10/100 Hydra Cable Assemblies (12 Legs)

PART NUMBER						DESCRIPTION
25PA/				-	-	25-pair telco-to-hydra cable assembly
END TYPE	END TYPE	CABLE TYPE & CATEGORY		LENGTH IN FEET		
<b>TR</b> Telco Right	<b>HR</b> Hydra Right	<b>5E</b> Cat 5e Riser				
<b>TL</b> Telco Left	<b>HL</b> Hydra Left	<b>EP</b> Cat 5e Plenum				
<b>TS</b> Telco Straight	<b>HSxx*</b> Hydra Straight					
<b>X</b> Blunt End – No Connector	*Replace "xx" with length of legs (12 or 24)					

**Example:** 25PA/TRHS24-5E-050 = 25-pair cable assembly with Telco Right to 10/100 Hydra Straight, 12 legs at 24", Cat 5e riser, 50 feet



## (8.7a) Category 5e Pre-Terminated Cable Assemblies

### Zone Distribution Solutions

OCC's zone distribution solutions optimize any horizontal cabling infrastructure. Through innovative designs, OCC continues to provide zone cross-connect solutions that meet every need. The convenience and reliability of OCC technology guarantees performance for high-speed applications.

OCC's Interconnect Module offers ease and compact design to give customers an alternative to multiple outlets in an office environment. The 6-port module allows for termination between 25-pair cables to modular RJ45 ports at the workstation, minimizing the need for multiple horizontal cable runs.

- Universal 568A/B wiring
- Compact design allows for easy installation
- Ideal in multiple situations, e.g., under floor, power pole, and multi-port workstations
- May be factory assembled or field terminated



### Applications

- 1000BASE-T Gigabit Ethernet
- 100BASE-TX Fast Ethernet
- 10BASE-T Ethernet
- Broadband Video
- 155/622 Mbps ATM
- Analog Voice/VOIP
- PoE, PoE+, and PoE++

### Zone Interconnect Modules (Field Terminable)

PART NUMBER	DESCRIPTION
ZDIMA5E	Zone interconnect module, Category 5e, 568A/B wired, 6-port (pictured above)
ZDIMSIX6A/B	Zone interconnect module, Category 6, 568A/B wired, 6-port (not pictured, mounts to an 89D bracket)

### 25-Pair Zone Distribution Cable Assemblies

PART NUMBER	DESCRIPTION
25ZD/	25-pair zone distribution cable assembly

CABLE TYPE & CATEGORY	WIRING TYPE	END TYPE	LENGTH IN FEET
<b>5E</b> Cat 5e Riser	<b>6A</b> 568A wired	<b>TR</b> Telco Right	
<b>EP</b> Cat 5e Plenum	<b>6B</b> 568B wired	<b>TL</b> Telco Left	
		<b>TS</b> Telco Straight	
		<b>X</b> Blunt End – No Connector	
		<b>HR</b> Hydra Right	
		<b>HL</b> Hydra Left	
		<b>HSxx*</b> Hydra Straight	
		*Replace "xx" with length of legs (12 or 24)	



**Example:** 25ZD/5E6BTS-100 = 25-pair cable assembly, Zone Distribution module to Telco Straight, Cat 5e riser, 568B wired, 100 feet



## (8.7a) Category 5e Pre-Terminated Cable Assemblies

### Zone Distribution Jack Packs

Created for completely modular connections, the OCC Jack Pack is ideal for any zone distribution application and can easily be mounted anywhere. With Category 5e performance that exceeds all standards requirements, the Jack Pack offers a multitude of application solutions. Whether mounting to a cable tray for a quick connection point or using as a distribution site within an equipment room, the OCC Jack Pack offers guaranteed performance in a compact package.

- Available for 10/100 or Gigabit Ethernet applications
- TIA-568-C.2 Cat5e
- Patented PC board technology
- Compact design
- Mounts anywhere
- Also available in shielded



### Zone Distribution Jack Packs

PART NUMBER	DESCRIPTION
ZDIM8625A	Zone distribution jack pack, gigabit RJ45 to female telco, 568A wired, 6-port
ZDIM8625B	Zone distribution jack pack, gigabit RJ45 to female telco, 568B wired, 6-port
ZDIM8625BS	Zone distribution jack pack, gigabit shielded RJ45 to female telco, 568B wired, 6-port

## (8.7b) Quad Box Pre-Terminated Cable Assemblies

OCC's Quad Box cabling solution is a 4-channel pre-terminated system that allows rapid deployment of high performance plug-and-play cabling infrastructure in data centers and other environments requiring minimal installation time.

Quad Box cable assemblies are available in Cat6A shielded and Cat6 and Cat5e unshielded configurations. The unique housing construction utilizes the OCC KMJ series jacks. The quad housing includes a protective cover with integrated pulling eye and label field. All OCC Quad Box cable assemblies are factory terminated and tested with guaranteed reliability and performance compliance. The Cat6A Quad Box solution also meets alien crosstalk performance requirements, providing out-of-the-box support for 10Gigabit Ethernet and other high-bandwidth applications



### Applications

- Mission Critical and Enterprise Data Centers
- Storage Area Networks
- Zone Distribution
- Colocation facilities
- Campus environments
- Any application requiring quick termination and little downtime

### Features and Benefits

- The 2X2 construction along with a tapered Pulling Eye Cover reduces overall size of housing, making it easier to pull through pathways
- 4-port module matches port increments in active gear
- Allows for rapid deployment, reducing implementation time and downtime
- Assembly options allow for multiple network configurations, including Data Center Permanent Link, Zone Distribution, and Cross Connect
- Labeling options consistent with 606 Administration standard
- Panel mounting options for both rear and front access
- Cabling is installed in minutes instead of hours
- Channel compliance is assured without the need for extensive testing and verification
- The 4X port counts integrate with many 10GBASE-T servers and switches

### Construction Considerations

- Construction options include: Cat5e, Cat6 (UTP), and Cat 6A (F/UTP); each cable option is available in both CMR and CMP

### Assembly Options Include

- Quad Box-to-Quad Box for creating a permanent link between network devices
- Quad Box-to-Blunt for discreet IDC termination to another panel

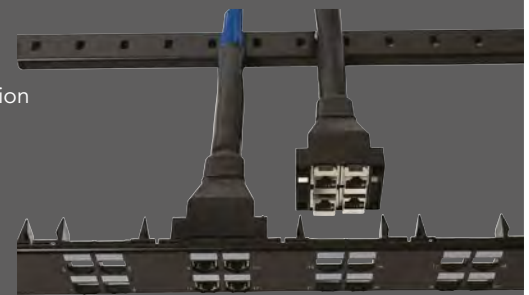

## Ordering Information

PART NUMBER	DESCRIPTION
AQB24	Quad box patch panel, 24-port, accommodates 6-quad box snap-in pre-terminated cable assemblies

## Quad Box Pre-Terminated Cable Assemblies

QB/ [ ] - [ ] - [ ] [ ] [ ] - [ ]

END 1 CONNECTOR	END 2 CONNECTOR	CABLE TYPE	SLEEVE COLOR	CABLE RATING	LENGTH (IN FEET)
USE – UTP Cat 5e	USE – UTP Cat 5e	U – UTP	B – Black	R – Riser	
S5E – STP Cat 5e	S5E – STP Cat 5e	S – Shielded	BL – Blue	P – Plenum	
U6 – UTP Cat 6	U6 – UTP Cat 6		R – Red	L – LSZH	
S6 – STP Cat 6	S6 – STP Cat 6				
S6A – STP Cat 6A	S6A – STP Cat 6A				
	X – Open				

**Example:** QB/U6-U6-UBP-40 = Cat6 Quadbox to Quadbox Cable Assembly, UTP CMP cable with black mesh sleeve, 40 feet length

## (8.8a) Multimedia Adapters and Connectors

### KMJ Adapters

OCC's Keystone adapters offer a full array of data, video, and audio ports for fiber, copper, coaxial and speaker cables. Featuring snap-in accessibility and a wide range of multimedia options, the OCC KMJ adapter line gives customers a flexible solution to meet any connectivity demand.

- Fits all OCC Keystone faceplates and surface-mount boxes



AKHDMI12



AKBLK12



AKBP212



AKRCA110B12



AKF12



AKRCA110Y12



AKDLCM00



AKSCM01



AKRCAP12



AKSTM12

### KMJ Adapters

PART NUMBER	DESCRIPTION
AKSCMxx	KMJ snap-in SC multimode adapter
AKSTMxx	KMJ snap-in ST multimode adapter
AKDLCMxx	KMJ snap-in dual LC multimode adapter
AKBNCxx	KMJ snap-in BNC coupler
AKFxx	KMJ snap-in F coupler
AKSVHSxx	KMJ snap-in Super VHS adapter
AKRCAPxx	KMJ snap-in gold-plated RCA bulkhead adapter
AKRCA110yxx	KMJ snap-in RCA to 110 adapter
AKBP2xx	KMJ snap-in gold-plated binding posts
AKBC2xx	KMJ snap-in gold-plated banana adapters
AKBLKxx	KMJ snap-in blank adapters (20 pack)
AKHDMI12	KMJ snap-in HDMI adapter
KMJ5EFT02	KMJ snap-in Cat 5e feed-through coupler
KMJ6EFT02	KMJ snap-in Cat 6 feed-through coupler

Replace "xx" with color choice: **00** = electrical ivory, **01** = office white, or **12** = bright white. Replace "y" with color inset choice: **R** = red, **Y** = yellow, **B** = black, or **W** = white.

### KMJ Keyed LC Adapters

PART NUMBER	DESCRIPTION
LAXAKDLCKWTxx	Limited Access keystone adapter, DLC, keyed, SM/MM, white
LAXAKDLCKORxx	Limited Access keystone adapter, DLC, keyed, SM/MM, orange
LAXAKDLCKPLxx	Limited Access keystone adapter, DLC, keyed, SM/MM, purple
LAXAKDLCKSLxx	Limited Access keystone adapter, DLC, keyed, SM/MM, slate
LAXAKDLCKBNxx	Limited Access keystone adapter, DLC, keyed, SM/MM, brown
LAXAKDLCKAQxx	Limited Access keystone adapter, DLC, keyed, SM/MM, aqua
LAXAKDLCKRSxx	Limited Access keystone adapter, DLC, keyed, SM/MM, rose
LAXAKDLCKGNxx	Limited Access keystone adapter, DLC, keyed, SM/MM, green
LAXAKDLCKRDxx	Limited Access keystone adapter, DLC, keyed, SM/MM, red
LAXAKDLCKYLxx	Limited Access keystone adapter, DLC, keyed, SM/MM, yellow
LAXAKDLCKPKxx	Limited Access keystone adapter, DLC, keyed, SM/MM, pink

Replace "xx" with color choice: **00** = electrical ivory, **01** = office white, or **12** = bright white.

## (8.8a) Multimedia Adapters and Connectors

### UMJ Adapters

For multimedia options, OCC created a complete line of data, video, and audio ports for fiber, copper, coaxial and speaker cables. Combined with the multicolor, low-profile recessed bezels, OCC's UMJ-style adapters offer a flexible alternative for port identification, no matter what the application.

- Available with 12 color options
- Secure mounting locks adapters into faceplate
- Fits all OCC UMJ faceplates and surface-mount boxes

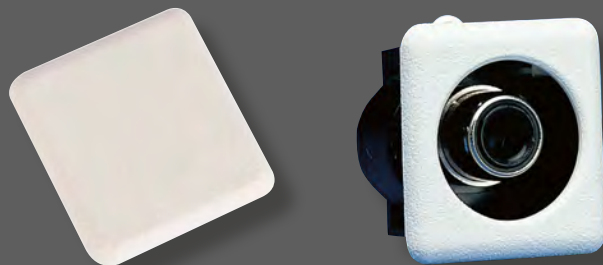

APBLK01

AARCA01



AASTM01

AABNC01

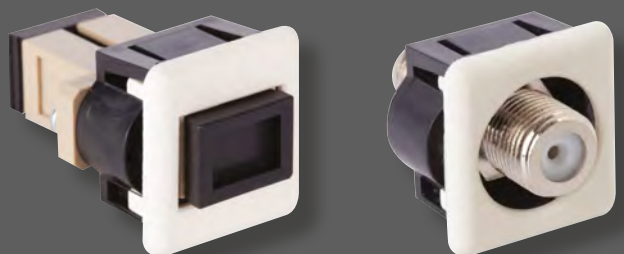

AASCM01

AAF01



AADLCM01

### UMJ Adapters

PART NUMBER	DESCRIPTION
AASCMxx	UMJ snap-in SC multimode adapter
AASCSxx	UMJ snap-in SC single-mode adapter
AASTMxx	UMJ snap-in ST multimode adapter
AASTSxx	UMJ snap-in ST single-mode adapter
AADLCMxx	UMJ snap-in dual LC multimode adapter
AAFxx	UMJ snap-in F coupler
AABNCxx	UMJ snap-in BNC coupler
AARCAxx	UMJ snap-in RCA adapter with solder tab
APBLKxx	UMJ snap-in blank bezel (20 pack)

Replace "xx" with color code.

#### "XX" COLOR CODES\*

00 – Electrical Ivory	04 – Green	09 – Yellow
01 – Office White	05 – Blue	10 – Purple
02 – Black	06 – Data Gray	11 – Brown
03 – Red	08 – Orange	12 – Bright White

\*Colors may be subject to availability and minimum order quantities.

### UMJ Keyed LC Adapters

PART NUMBER	DESCRIPTION
LAXAAKDLCGNxx	Limited Access adapter, DLC, keyed, SM/MM, green
LAXAAKDLCRDxx	Limited Access adapter, DLC, keyed, SM/MM, red
LAXAAKDLCYLxx	Limited Access adapter, DLC, keyed, SM/MM, yellow
LAXAAKDLCPKxx	Limited Access adapter, DLC, keyed, SM/MM, pink
LAXAAKDLCWTxx	Limited Access adapter, DLC, keyed, SM/MM, white
LAXAAKDLCORxx	Limited Access adapter, DLC, keyed, SM/MM, orange
LAXAAKDLCPLxx	Limited Access adapter, DLC, keyed, SM/MM, purple
LAXAAKDLCSLxx	Limited Access adapter, DLC, keyed, SM/MM, slate
LAXAAKDLCBNxx	Limited Access adapter, DLC, keyed, SM/MM, brown
LAXAAKDLCQAxx	Limited Access adapter, DLC, keyed, SM/MM, aqua
LAXAAKDLCRSxx	Limited Access adapter, DLC, keyed, SM/MM, rose

Replace "xx" with color choice: **00** = electrical ivory, **01** = office white, or **12** = bright white.



## (8.8a) Multimedia Adapters and Connectors

### UMJ Bezels

Whether ordering kitted or as separate items for field installations, OCC's unique bezel system offers an easy and affordable alternative for desktop port identification. Bezels may be ordered blank or labeled and with a multitude of color options. The flexibility and variety of combinations for workstation labeling are endless.

- 12 different color and four labeling options
- Standard package of bezels contains 20 per bag
- Can be easily customized or kitted with jacks/adapters for special orders
- Available for six or eight position plugs
- Locks the jack or adapter into the faceplate
- Shuttered bezels available for dust protection



UMJ COLOR CODES*	
00	Electrical Ivory
01	Office White
02	Black
03	Red
04	Green
05	Blue
06	Data Gray
08	Orange
09	Yellow
10	Purple
11	Brown
12	Bright White

\*Colors may be subject to availability and minimum order quantities.

### UMJ Bezels

B E	Optional	Optional	Optional
	<b>POSITION</b>	<b>OPTIONS</b>	<b>COLOR</b>
	06 = 6 Position	S = Shuttered	See color chart.
	08 = 8 Position	Blank = None	
			<b>TEXT</b>
			V = Voice
			D = Data
			Blank = None

**Example:** BE0805D = 8-Position Blue Bezel with Data icon -No shutter

### Limited Access

OCC's patented Limited Access System provides the capability to implement enhanced physical network security and segmentation through the use of specially designed outlet jacks and patch cords. Initially designed for the military, the Limited Access system features uniquely keyed, color-coded jack bezels and patch cord boots that provide two layers of physically restrictive network security.

#### 2-Layer Physical Security

- **Layer 1: Limited Access**  
Limited Access jacks only accept patch cords with Limited Access modular plugs. Standard RJ45 plugs cannot be inserted into Limited Access jacks.
- **Layer 2: Physical Network Segmentation**  
Limited Access provides the capability to limit physical access to specific network ports through the use of color-coded jack bezels and patch cord boots. Example: Only users with a Limited Access patch cord with a red boot can connect to red Limited Access outlet jacks.

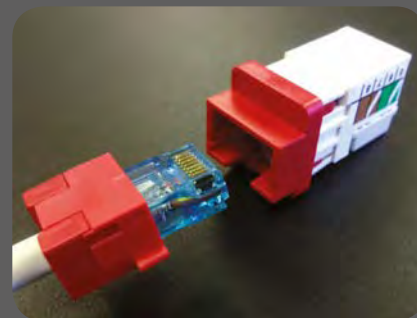



## (8.8b) Limited Access – Physical Layer Security Cat 6A System

### Limited Access (continued)

The Limited Access System is ideal for:

- Military installations
- Hospitals
- Schools
- Airport terminals
- Classified corporate networks
- Any public access area



The Limited Access system enables network administrators to easily segregate users to specific networks by simply using a Limited Access conversion patch cord color-coded and keyed specifically to the appropriate outlet jacks. Whether you control access to your network for security clearance, confidentiality within your office space or simply to prohibit public access, the Limited Access product line will provide physical control of user connectivity for the network administrator.

### Features and Benefits:

- Layer 1 limited physical access may be deployed independently or in conjunction with Layer 2 network segmentation
- Available in 10 different colored keyed bezel and boot combinations
- Conversion patch cords available to connect standard Ethernet hardware to the Limited Access network
- Exceeds TIA-568-C.2 Category 6A performance
- Supports 10 Gigabit Ethernet Performance
- Supports all IEEE Power over Ethernet (PoE) standards
- UL listed communications circuit accessory

### Applications:

- 2.5G/5GBASE-T Gigabit Ethernet
- 10GBASE-T Ethernet
- 1000BASE-T Gigabit Ethernet
- 100BASE-TX Fast Ethernet
- 10BASE-T Ethernet
- Broadband Video
- 155/622 Mbps ATM
- Analog Voice/VOiP
- PoE, PoE+, and PoE++

COLOR CODES*
02 – Black
03 – Red
04 – Green
05 – Blue
06 – Data Gray
08 – Orange
09 – Yellow

\*Colors may be subject to availability and minimum order quantities.

PART NUMBER	DESCRIPTION
LA6Axx	Limited Access Cat6A RJ45 jack with keyed bezel
Replace "xx" with color code.	

### Limited Access Patch Cords

PART NUMBER						
LAPC6A	-				-	
	<b>CABLE TYPE</b>	<b>PLUG ONE</b>	<b>PLUG TWO</b>	<b>PLUG TWO BOOT</b>	<b>LENGTH IN FEET</b>	<b>DENOTES BOOT COLOR</b>
	<b>U</b> Unshielded	<b>MK</b> Keyed Boot	<b>M</b> Keyed Plug	<b>K</b> Keyed Boot	<b>XX</b>	<b>YY</b> - See color code chart above.
			<b>A</b> 568A Wired	<b>B</b> Non-keyed Boot		
			<b>B</b> 568B Wired	<b>N</b> No Boot		

#### Example:

LAPC6A-UMKBB-0703 = Limited Access patch cord, unshielded, keyed boot, 568B wired, 7 feet, red.

## (8.8c) Faceplates

### KMJ Faceplates

OCC's Keystone faceplates are available in multiple port configurations and accommodate all OCC KMJ jacks and inserts for maximum versatility in the work area.



### KMJ Commercial Faceplates

- Keystone commercial-grade faceplates accept any KMJ-style jack or adapter
- ID windows include write-on labels and plastic protective covers
- Slotted mounting holes simplify installation
- Available in most popular colors



PART NUMBER	DESCRIPTION
FPSK01xx	Single-gang commercial faceplate, KMJ, 1-port
FPSK02xx	Single-gang commercial faceplate, KMJ, 2-port
FPSK03xx	Single-gang commercial faceplate, KMJ, 3-port
FPSK04xx	Single-gang commercial faceplate, KMJ, 4-port
FPSK06xx	Single-gang commercial faceplate, KMJ, 6-port
DPSK06xx	Double-gang commercial faceplate, KMJ, 6-port
DPSK12xx	Double-gang commercial faceplate, KMJ, 12-port

Replace "xx" with color choice: **00** = electrical ivory, **01** = office white, or **12** = bright white.

### KMJ Commercial Angled Faceplates

- Angled faceplate reduces strain on existing station cables

PART NUMBER	DESCRIPTION
FPSK04Axx	Single-gang commercial faceplate, angled KMJ, 4-port
DPSK08Axx	Double-gang commercial faceplate, angled KMJ, 8-port

Replace "xx" with color choice: **00** = electrical ivory, **01** = office white, or **12** = bright white.



## (8.8c) Faceplates

### KMJ Residential Faceplates

- Smooth surface faceplates accept any KMJ jack or adapter
- Available in oversized for coverage of imperfect drywall cuts
- Three color options

PART NUMBER	DESCRIPTION
FPKS01xx	Single-gang smooth faceplate, KMJ, 1-port
FPKS02xx	Single-gang smooth faceplate, KMJ, 2-port
FPKS03xx	Single-gang smooth faceplate, KMJ, 3-port
FPKS04xx	Single-gang smooth faceplate, KMJ, 4-port
FPKS06xx	Single-gang smooth faceplate, KMJ, 6-port
FPK01xx	Single-gang smooth faceplate, oversized, KMJ, 1-port
FPK02xx	Single-gang smooth faceplate, oversized, KMJ, 2-port
FPK03xx	Single-gang smooth faceplate, oversized, KMJ, 3-port
FPK04xx	Single-gang smooth faceplate, oversized, KMJ, 4-port
FPK06xx	Single-gang smooth faceplate, oversized, KMJ, 6-port
DPK06xx	Double-gang smooth faceplate, KMJ, 6-port
DPK12xx	Double-gang smooth faceplate, KMJ, 12-port

Replace "xx" with color choice: **00** = electrical ivory, **01** = office white, or **12** = bright white.



### KMJ Stainless Steel Faceplates

- Stainless steel construction
- Accommodates any KMJ jack or adapter
- Corrosion resistant



PART NUMBER	DESCRIPTION
FPSK01SS	Single-gang stainless steel faceplate, KMJ, 1-port
FPSK02SS	Single-gang stainless steel faceplate, KMJ, 2-port
FPSK03SS	Single-gang stainless steel faceplate, KMJ, 3-port
FPSK04SS	Single-gang stainless steel faceplate, KMJ, 4-port
FPSK06SS	Single-gang stainless steel faceplate, KMJ, 6-port
DPSK04SS	Double-gang stainless steel faceplate, KMJ, 4-port
DPSK06SS	Double-gang stainless steel faceplate, KMJ, 6-port
DPSK12SS	Double-gang stainless steel faceplate, KMJ, 12-port



## (8.8c) Faceplates

### KMJ Receptacle Housing Inserts

- Fits inside any standard electrical faceplate
- Accommodates two or four KMJ ports
- Fits 2.80"x1.38" opening

PART NUMBER	DESCRIPTION
A106Kxx	KMJ Receptacle Insert, 2-port
A106K4xx	KMJ Receptacle Insert, 4-port
Replace "xx" with color choice: <b>00</b> = electrical ivory, <b>01</b> = office white, or <b>12</b> = bright white.	



### KMJ Office Furniture Faceplate

- Fits most popular office furniture, including Herman Miller and Steelcase
- Attractive and functional

PART NUMBER	DESCRIPTION
FAPK402	KMJ Furniture faceplate, 4 port, black
FAPK302	KMJ Furniture faceplate, 3 port, black



## (8.8c) Faceplates

### UMJ Faceplates

OCC's UMJ solution isn't complete without our UMJ faceplates. Available in a multitude of configurations and designed to meet any application, the UMJ faceplates for UMJ-style jacks and adapters offer a convenient and aesthetically appealing solution for any desktop purpose.



### UMJ Commercial Faceplates

- Commercial-grade faceplates accept any UMJ Bezel jack or adapter
- ID windows include write-on labels and plastic protective covers
- Slotted mounting holes simplify installation
- Available in most popular colors



PART NUMBER	DESCRIPTION
FPSR01xx	Single-gang commercial faceplate, recessed UMJ, 1-port
FPSR02xx	Single-gang commercial faceplate, recessed UMJ, 2-port
FPSR03xx	Single-gang commercial faceplate, recessed UMJ, 3-port
FPSR04xx	Single-gang commercial faceplate, recessed UMJ, 4-port
FPSR06xx	Single-gang commercial faceplate, recessed UMJ, 6-port
DP01xx	Double-gang commercial faceplate, UMJ, 1-port
DP02xx	Double-gang commercial faceplate, UMJ, 2-port
DP03xx	Double-gang commercial faceplate, UMJ, 3-port
DP04xx	Double-gang commercial faceplate, UMJ, 4-port
DP06xx	Double-gang commercial faceplate, UMJ, 6-port

Replace "xx" with color choice: **00** = electrical ivory, **01** = office white, or **12** = bright white.

### UMJ Commercial Angled Faceplates

- Angled faceplates reduce strain on existing station cables
- ID windows include write-on labels and plastic protective cover

PART NUMBER	DESCRIPTION
FP04Axx	Single-gang commercial faceplate, angled UMJ, 4-port
DP08Axx	Double-gang commercial faceplate, angled UMJ, 8-port

Replace "xx" with color choice\*: **00** = electrical ivory, **01** = office white, or **12** = bright white.



\*Colors may be subject to availability and minimum order quantities.

## (8.8c) Faceplates

### UMJ Residential Faceplates

- Smooth surface faceplates accept any UMJ Bezel jack or adapter
- Bezel openings are recessed for neater appearance
- Available in most popular colors

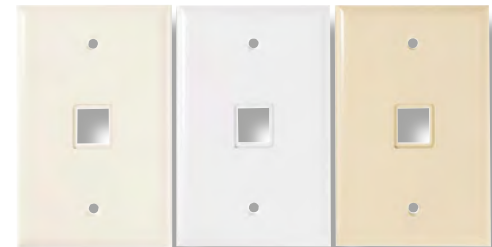

PART NUMBER	DESCRIPTION
FPR01xx	Single-gang smooth faceplate, UMJ, 1-port
FPR02xx	Single-gang smooth faceplate, UMJ, 2-port
FPR03xx	Single-gang smooth faceplate, UMJ, 3-port
FPR04xx	Single-gang smooth faceplate, UMJ, 4-port
FPR06xx	Single-gang smooth faceplate, UMJ, 6-port

Replace "xx" with color choice: **00** = electrical ivory, **01** = office white, or **12** = bright white.

### UMJ Stainless steel Faceplates

- Stainless steel faceplates accept any UMJ Bezel jack or adapter
- Corrosion resistant
- May be ordered with tamper-proof screws

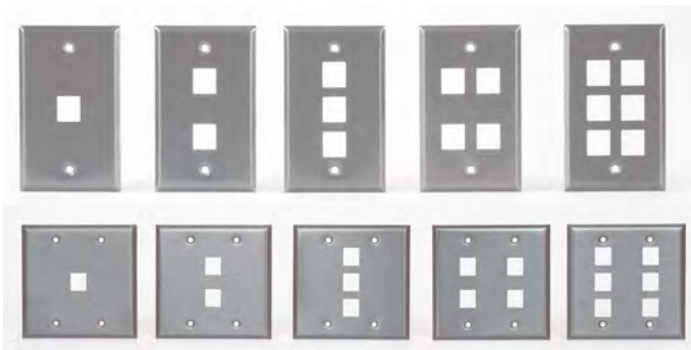

PART NUMBER	DESCRIPTION
FP01SS	Single-gang stainless steel faceplate, UMJ, 1-port
FP02SS	Single-gang stainless steel faceplate, UMJ, 2-port
FP03SS	Single-gang stainless steel faceplate, UMJ, 3-port
FP04SS	Single-gang stainless steel faceplate, UMJ, 4-port
FP06SS	Single-gang stainless steel faceplate, UMJ, 6-port
DP01SS	Double-gang stainless steel faceplate, UMJ, 1-port
DP02SS	Double-gang stainless steel faceplate, UMJ, 2-port
DP03SS	Double-gang stainless steel faceplate, UMJ, 3-port
DP04SS	Double-gang stainless steel faceplate, UMJ, 4-port
DP06SS	Double-gang stainless steel faceplate, UMJ, 6-port

### UMJ Office Furniture Faceplates

- Fits most popular office furniture, including Herman Miller and Steelcase
- Available in black
- Attractive and functional



PART NUMBER	DESCRIPTION	CUTOUT DIMENSIONS	OFFICE FURNITURE COMPATIBLE				
			HERMAN MILLER	STEELCASE	HAWORTH	HON	OTHER
FAP302	Furniture faceplate, 3-port	2.65"W x 1.35"H		X	X	X	
FAP302-HM	Furniture faceplate, 3-port	2.98"W x 1.88"H	X				
FAP402	Furniture faceplate, 4-port	5.25"W x 1.37"H				X	X



## (8.8c) Faceplates

### UMJ Front Access Faceplates

- Custom configurable to accommodate UMJ- and KMJ-style jacks and adapters
- Accommodates three individual modules for ultimate flexibility
- Additional cable storage depth
- Slim design



PART NUMBER	DESCRIPTION
FP-FAOR-xx	Front Access™ faceplate, single-gang ring
FAOC-1A-xx	Front Access™ UMJ faceplate, 1-port insert
FAOC-2A-xx	Front Access™ UMJ faceplate, 2-port insert
FAOC-B-xx	Front Access™ faceplate, blank insert

Replace "xx" with color choice\*: **00** = electrical ivory, or **01** = office white.

\*Colors may be subject to availability and minimum order quantities.

### UMJ Receptacle Housing Insert

- Fits inside any standard electrical faceplate
- Accommodates two UMJ ports

PART NUMBER	DESCRIPTION
A106xx	UMJ receptacle insert, 2-port

Replace "xx" with color choice: **00** = electrical ivory, or **01** = office white.





## (8.8c) Faceplates

### Wallplates & Connectors

For standard voice-grade applications, OCC has developed a durable and practical solution that meets any residential or commercial protocol. Featuring OCC's superior performance jacks, the OCC wallplate is guaranteed to be a deal for any single-jack application.

- Available in stainless steel or fire-retardant plastic
- Easily mounts on any wall
- Mounting screws provided

### OCC Standard Commercial/Residential Wallplate

PART NUMBER	DESCRIPTION
WP07	Plastic wallplate, 6 position, USOC jack, 1-port, white
WPSS	Stainless steel wallplate, 6 position, USOC jack, 1-port
WP-5E-SS	Stainless steel wallplate, Category 5e jack, 1-port
WP-A6-SS	Stainless steel wallplate, Category 6 jack, 1-port
WP-56-SS	Stainless steel wallplate, unloaded, 1-port

### OCC Wallplates with Connectors

For applications requiring both voice-grade and coaxial access, OCC created a line of smooth standard-size flush mount plates with jacks and/or F-connectors in a single-gang format. All of these wallplates install easily into standard electrical boxes and offer 110-style terminations for easy installation.

- One-piece construction
- Easily mounts to any standard electrical box
- 110-style punch-down termination
- Mounting hardware included

PART NUMBER	DESCRIPTION
WP1V12	Plastic wallplate with (1) 6 position, 4 conductor modular jack, bright white
WP2V12	Plastic wallplate with (2) 6 position, 4 conductor modular jacks, bright white
WP1F12	Plastic wallplate with (1) twist-on F-connector, bright white
WP2F12	Plastic wallplate with (2) twist-on F-connectors, bright white
WP1V1F12	Plastic wallplate with (1) 6 position, 4 conductor modular jack and (1) twist-on F-connector, bright white



## (8.8d) Surface Mount Products

### Surface-Mount Boxes

Whether installing single- or double-gang faceplates, OCC's surface-mount boxes provide the depth for proper cable orientation into jacks or adapters with easy knockouts for quick terminations. Ideal for raceway applications, OCC's surface-mount boxes offer a flexible approach for workstation applications.

- Available in single-gang and double-gang
- Mounting screws, double-sided tape, and cable ties included
- Perfect for raceway or cable tray applications
- Will accommodate any OCC UMJ or KMJ faceplate



### Surface-Mount Boxes

PART NUMBER	DESCRIPTION
SMSGxx	Surface-mount box, single-gang
SMDGxx*	Surface-mount box, double-gang

Replace "xx" with color choice: **00** = electrical ivory, **01** = office white, or **12** = bright white.  
 \*SMDG available in 00-electrical ivory and 12-bright white

### Surface-Mount Enclosures

OCC's surface-mount enclosures are available in multiple port configurations and provide a versatile, low-profile solution for the desktop or equipment locations, such as access points or IP cameras.

- Available for UMJ- or KMJ-style jacks and adapters
- Knockouts on three sides and in the base for easy cable entry
- Port designation option
- SME enclosures feature designation windows
- Mounting screws, double-sided tape and cable ties (SME only) included



### UMJ Surface-mount Enclosures

PART NUMBER	DESCRIPTION
SME2xx	Surface-mount enclosure, UMJ, 2-port
SME4xx	Surface-mount enclosure, UMJ, 4-port
SME8xx	Surface-mount enclosure, UMJ, slimline, 8-port
SME10xx	Surface-mount enclosure, UMJ, slimline, 10-port



### KMJ Surface-mount Enclosures

PART NUMBER	DESCRIPTION
SMEK1xx	Surface-mount enclosure, KMJ, 1-port
SMEK2xx	Surface-mount enclosure, KMJ, 2-port
SMEK4xx	Surface-mount enclosure, KMJ, 4-port
SMEK6xx	Surface-mount enclosure, KMJ, 6-port

Replace "xx" with color choice:  
**00** = electrical ivory  
**01** = office white  
**12** = bright white

## (8.8d) Surface Mount Products

### Multimedia Boxes

For conditions that require a variety of media applications, consider OCC's full product line of multimedia boxes. The multimedia box is a one-stop solution for all your workstation applications. It offers complete flexibility in design and can be kitted for multiple hardware options.

- Optional plates available
- Complete kits ready for installation
- Ideal for small zone distribution applications
- Fiber storage meets TIA/EIA specifications
- Available only for UMJ-style jacks and adapters



### OCC Multimedia Boxes

PART NUMBER	DESCRIPTION
MMA77xx	Multimedia box, UMJ, blank
MMA77xxA1	Multimedia box, UMJ, optional plate, 1-port
MMA77xxA2	Multimedia box, UMJ, optional plate, 2-port
MMA77xxA4	Multimedia box, UMJ, optional plate, 4-port
MMA77xxA6	Multimedia box, UMJ, optional plate, 6-port
MMA77xxDSC1	Multimedia box, UMJ, optional plate, (1) SM/MM dual SC port loaded
MMA77xxDSC2	Multimedia box, UMJ, optional plate, (2) SM/MM dual SC ports loaded
MMA77xxDSC3	Multimedia box, UMJ, optional plate, (3) SM/MM dual SC ports loaded
MMA77xxP2W4	Multimedia box, UMJ, kitted, 4-port & 3 blank sides
MMA77xxP2W6	Multimedia box, UMJ, kitted, 6-port & 3 blank sides
MMA77xxP2W	Multimedia box, UMJ, kitted, 3 blank sides

Replace "xx" with color choice: **00** = electrical ivory or **01** = office white.

## (8.9a) MSDE Enclosures

### MSDE Enclosures

The MSDE (Multiple Service Distribution Enclosure) solution is designed primarily for MDU installations. These compact enclosures are only 10" high and can be flush-mounted between standard 16" stud walls. Voice, Data and Video Distribution modules enable analog voice (POTS), Broadband Internet, Ethernet/IP data and RF video to be distributed to multiple outlet locations or devices within a residence.

- Standard 16" stud-wall installation (can also be turned to fit 12" center-wall studs)
- Module bracket to accommodate future needs
- Rugged steel construction, including flanged, latching door
- White powder-coat finish covers
- Knockouts on top, bottom and side for easy cable entrance
- Flexible tie-down locations for cable management
- In-wall flush-mount design
- Preset wall thickness tabs for easy installation
- Can be ordered empty or preconfigured
- Includes J-box cutout
- (4) 1.38" cable entry holes in top
- (3) 1.38" cable entry knockouts in each side



### Specifications for System:

- ANSI/TIA-570-C Residential Telecommunications Infrastructure Standard compliant
- UL 1863 Communication Circuit Accessory
- 16AWG steel construction

### Dimensions:

- 14.38"W x 10.62"H x 3.12"D

PART NUMBER	DESCRIPTION
MSDET000D00V0	MSDE 10" enclosure with 3-position bracket, hinged cover, and J-box cutout
MSDET000D00V0-AC	MSDE 10" enclosure with 3-position bracket, hinged cover, and J-box kit
MSDE-BOX1	MSDE 10" enclosure with 3-position bracket, no cover, and J-box cutout
MSDE-BOX2	MSDE 10" enclosure with no bracket, no cover and J-box cutout
MSDE-DOOR	MSDE 10" standard hinged cover

### MSDE Preconfigured Enclosures – Ordering Guide

PART NUMBER									
MSDE	T		D		V		-		
		<b>VOICE MODULE (VM)</b>			<b>DATA</b>			<b>VIDEO</b>	<b>OPTIONS</b>
		406 4x6 VM			A5 5-Port 568A, Cat 5e Data Board			4 1x4, 1 ghz, Bidir. Splitter	LCK Locking Cover
		408 4x8 VM			A6 6-Port 568A, Cat 5e Data Board			6 1x6, 1 ghz, Bidir. Splitter	JCK 2-Jack Interface Cover
		410 x10 VM			A7 7-Port 568A, Cat 5e Data Board			8 1x8, 1 ghz, Bidir. Splitter	SCK Solid Cover
		606 6x6 VM			A8 8-Port 568A, Cat 5e Data Board				AC Knockout w/ J-Box
		608 6x8 VM			B5 5-Port 568B, Cat 5e Data Board				LAC LCK & AC Option
		610 6x10 VM			B6 6-Port 568B, Cat 5e Data Board				JAC JCK & AC Option
					B7 7-Port 568B, Cat 5e Data Board				SAC SCK & AC Option
					B8 8-Port 568B, Cat 5e Data Board				
					6B5 5-Port 568A/B, Cat 6 Data Board				
					6B6 6-Port 568A/B, Cat 6 Data Board				
					6B7 7-Port 568A/B, Cat 6 Data Board				
					6B8 8-Port 568A/B, Cat 6 Data Board				

**Example:** MSDET406DA6V4-SCK = MSDE Enclosure, 4x6 voice, 6-port data, 4-port 1GHz splitter with solid cover door



## (8.9a) MSDE Enclosures

## MSDE Cover Options

No matter what the specification, MSDE enclosures offer door options to meet any need. Whether selecting a simple locking door or a solid cover, all MSDE cover options are built with durable steel construction and white powder-coat finishes, ready to be shipped to the job site.

### Locking Door Option

For extra security, this special latching door offers a stainless steel locking option complete with key set.

PART NUMBER	DESCRIPTION
MSDET000D00V0-LCK	MSDE 10" enclosure with 3-position bracket, locking cover, and J-box cutout
MSDE-DOOR-LCK	MSDE locking steel cover



### Tamper-Resistant Solid Cover Option

An optimal security environment can be achieved with this solid cover, which uses four tamper-resistant screws.

PART NUMBER	DESCRIPTION
MSDET000D00V0-SCK	MSDE 10" enclosure with 3-position bracket, tamper-resistant solid cover, and J-box cutout
MSDE-DOOR-SCK	MSDE tamper-resistant solid cover





## (8.9b) HAX Enclosures

### HAX 20/30 Series Enclosures

The HAX 20 and 30 series enclosures provide an even greater capacity for cables, distribution modules and network electronics, such as router/switches and optical network terminals. These enclosures are well suited for larger single and multi-family dwellings. They may also be utilized as passive or active zone enclosures for enterprise network applications.

### Features and Benefits

- Screw-on or hinged white powder coat cover options
- Recessed mounting for standard 16" on-center studs
- Mounting tabs for easy installation
- Versatile mounting bracket accommodates up to (3) voice or data modules
- Large openings with protective grommet for top side cable entry
- HAX-BKT-WM, Triple Module Mounting Bracket
  - Accommodates up to (3) voice and/or data modules
  - Fits MSDE and HAX enclosures

### HAX 20/30 Specifications

- ANSI/TIA-570-C Residential Telecommunications Infrastructure Standard compliant
- 18AWG Steel construction
- UL 1863 Communication Circuit Accessory

### HAX 20/30 Dimensions

- HAX20: 20"H x 14.38"W x 3.1"D
- HAX30: 31.25"H x 14.38"W x 4.2"D

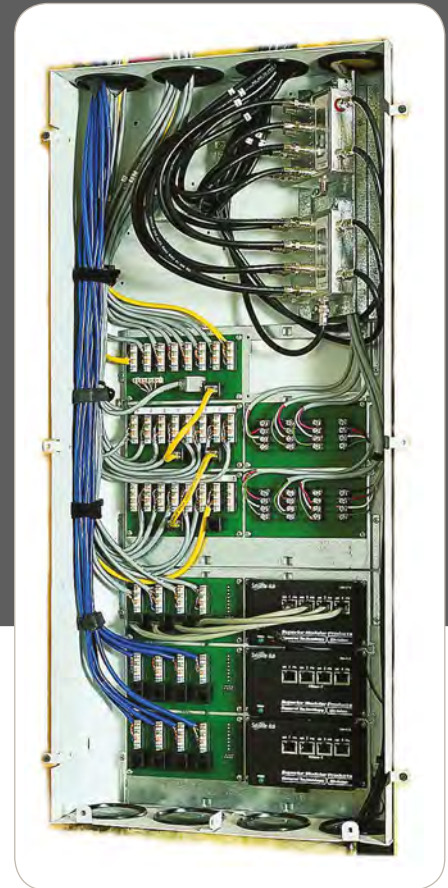

HAX-301

PART NUMBER	DESCRIPTION
HAX-201	20" enclosure with (1) 3-position bracket and solid cover
HAX-201H	20" enclosure with (1) 3-position bracket and hinged cover
HAX-201BOX	20" enclosure with (1) 3-position bracket, no cover
HAX-20COVER	20" solid screw-on cover
HAX-20HCOVER	20" hinged cover with bezel
HAX-301	31" enclosure with (1) 3-position bracket and solid cover
HAX-301H	31" enclosure with (1) 3-position bracket and hinged cover
HAX-BOX	31" enclosure with (1) 3-position bracket, no cover
HAX-COVER	31" solid screw-on cover
HAX-HCOVER	31" hinged cover with bezel

 (8.9c) Voice and Data Modules

## MSDE Voice Modules

To provide project-specific solutions, the OCC Residential product line offers voice modules that are specifically designed for multi-dwelling environments featuring a non-expansion footprint. MSDE Voice Modules were created explicitly for the 10" Series Enclosures and offer the highest levels of performance.

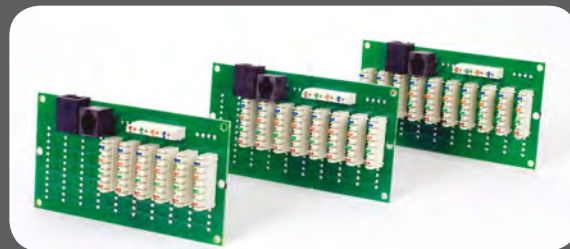

PART NUMBER	DESCRIPTION
MOD-T406	MSDE Voice Module, 4x6, includes RJ31X and network test jacks
MOD-T408	MSDE Voice Module, 4x8, includes RJ31X and network test jacks
MOD-T410	MSDE Voice Module, 4x10, includes RJ31X and network test jacks
MOD-T606	MSDE Voice Module, 6x6, includes RJ31X and network test jacks
MOD-T608	MSDE Voice Module, 6x8, includes RJ31X and network test jacks
MOD-T610	MSDE Voice Module, 6x10, includes RJ31X and network test jacks

## Data Modules

OCC's Residential Data Modules allow for the termination of high-speed data service to multiple locations. These Category 5e and Category 6 (568A or 568B wired) modules provide exceptional performance using OCC's patented circuit board technology for true Category 5e or 6 compliance. In addition to high-speed Internet distribution, the Data Modules can also be used in conjunction with a PBX system using the cross-connect module.



- 110-style connector termination style for easy installations
- Color-coded blue for module recognition
- Easily fits into any MSDE 3-position bracket
- Pushpin mounting

PART NUMBER	DESCRIPTION
MOD-DB4	Data Module, Cat 5e, 568A/B, 4-port
MOD-DB5	Data Module, Cat 5e, 568A/B, 5-port
MOD-DB6	Data Module, Cat 5e, 568A/B, 6-port
MOD-DB7	Data Module, Cat 5e, 568A/B, 7-port
MOD-DB8	Data Module, Cat 5e, 568B, 8-port
MOD6-DB4	Data Module, Cat 6, 568A/B, 4-port
MOD6-DB5	Data Module, Cat 6, 568A/B, 5-port
MOD6-DB6	Data Module, Cat 6, 568A/B, 6-port
MOD6-DB7	Data Module, Cat 6, 568A/B, 7-port
MOD6-DB8	Data Module, Cat 6, 568A/B, 8-port

## Applications

- 100BASE-T Gigabit Ethernet
- 100BASE-TX Fast Ethernet
- 10BASE-T Ethernet
- Broadband Video
- 155/622 Mbps ATM
- Analog Voice/VOIP
- PoE, PoE+, and PoE++

## (8.9d) Economy Distribution Solutions

### Video

OCC's Video Modules provide the capability to easily distribute RF video, such as cable TV, to multiple locations. These modules are bidirectional and compatible with digital TV systems. Combining bidirectional capabilities perfect for cable modem/set-top box use, these modules deliver superior digital performance in a completely modular design.

- Bidirectional
- Digital
- May be mounted in multiple configurations

### Passive Splitters – CATV

PART NUMBER	DESCRIPTION
MOD-V4	Passive CATV Splitter, bidirectional, digital, 1GHz, 4-way
MOD-V6	Passive CATV Splitter, bidirectional, digital, 1GHz, 6-way
MOD-V8	Passive CATV Splitter, bidirectional, digital, 1GHz, 8-way



### Passive Splitters – CATV Technical Specifications

Frequency (MHz)	INSERTION LOSS (DB)				ISOLATION (DB)				RETURN LOSS (DB)			
	5-50	50-750	750-860	860-1000	5-50	50-750	750-860	860-1000	5-50	50-750	750-860	860-1000
MOD-V4	6.9	7.2	7.7	8.4	28	32	28	24	25	26	20	25
MOD-V6	9.0	9.5	9.8	10.0	28	32	28	24	25	26	20	25
MOD-V8	10.2	10.8	11.2	13.0	28	32	26	26	22	25	22	20

### Economy Distribution Solutions

For applications requiring a more economical means of distributing household services, OCC developed the WP Series. These wall plates save time and money in any multi-dwelling, hotel or small residence project while continuing to deliver unsurpassed performance. Whether installing voice or voice and/or video, the WP Series wallplates offer a cost-effective and versatile solution for easy distribution of services.

- Cost-effective solution
- Flush-mount
- Fits standard dual- and quad-gang junction boxes and mud rings
- Saves valuable installation time
- Oversized double-gang or quad-gang wallplates

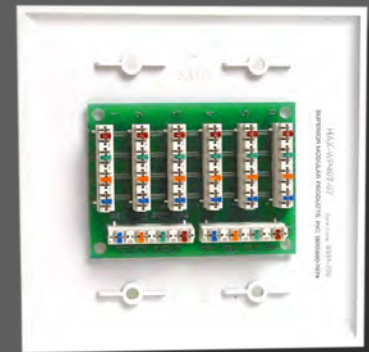

PART NUMBER	DESCRIPTION
HAX-WP407	4x7 Voice Module (only)
HAX-WP407-xx	4x7 Voice Module with dual-gang plate
HAX-WP407V4-xx	4x7 Voice Module, 1x4 Video Splitter with quad-gang plate
HAX-WP407V6-xx	4x7 Voice Module, 1x6 Video Splitter with quad-gang plate
HAX-WP407V8-xx	4x7 Voice Module, 1x8 Video Splitter with quad-gang plate

Replace "xx" with color choice: **00** = electrical ivory, **01** = office white, **07** = white, or **12** = bright white.





# CABINETS, RACKS, AND ENCLOSURES

The beauty of OCC's data center cabinets and racks go well beyond the aesthetics. Each of our data storage products is designed with ease of installation, airflow features, space savings, and efficient change out as priorities.

To provide the most versatile solutions for your data center or equipment room, OCC cabinets, racks and enclosures are available in multiple sizes and free standing or wall-mount configurations.

Enabling maximum customization, we offer numerous cable management, shelving, and accessory options to meet your specific design needs and preferences. In conjunction with our advanced end-to-end fiber and copper solutions, OCC provides maximum flexibility in the design of your data center for immediate scalability, and quick moves, adds, and changes to take your network from 10 to 40 to 100 G and beyond.



 Contents

## 9.0 Cabinets, Racks, and Enclosures

### 9.1 FREESTANDING RACKS & CABINETS

9.1a	Rack Max .....	405
9.1b	Open Frame Racks .....	406
9.1c	19" Freestanding Cabinets .....	407

### 9.2 WALL-MOUNT RACKS, CABINETS, AND BRACKETS

9.2a	Wall-Mount Swing Racks .....	408
9.2b	Wall-Mount Enclosures.....	409
9.2c	Terax Enclosures.....	410
9.2d	19" Sideways Mount Enclosures .....	411

### 9.3 SHELVING

9.3a	Shelving .....	412
------	----------------	-----

### 9.4 CABLE MANAGEMENT SOLUTIONS

9.4a	Cable Management Solutions.....	413
9.4b	Premium High-Capacity Cable Management.....	414
9.4c	Standard Finger Duct Cable Managers .....	415
9.4d	Ring-Style Cable Managers.....	416

### 9.5 ACCESSORIES

9.5a	Accessories.....	418
------	------------------	-----



## (9.1a) Rack Max

### Freestanding Racks & Cabinets

In keeping with our dedication to provide convenient solutions for structured cabling needs, OCC offers the Rack Max, an integrated open-frame rack and cable management system in one. The Rack Max Cable Management Rack is able to accommodate 19" or 23" mounting widths in an 84" high open-frame rack configuration. Its wide stance provides above average strength and a high-capacity 6.5" deep aluminum vertical channel allows for safe management of large bundles of copper or fiber cabling. Overall, the Rack Max solution offers maximum rack space with greater mounting flexibility and the added bonus of an integrated vertical cable path for increased cable management and greater aesthetic appeal.

- Built-in protected vertical cable pathway
- Vertical channels tapped on front and back with 4" x 4" side holes for easy cable entry
- Top bars with parallel and perpendicular attachment points for cable tray or ladder rack
- Built-in bend radius protection
- May accommodate 19" or 23" mounting widths
- (18) hook & loop fasteners
- EIA standard 5/8", 5/8", 1/2" hole mounting patterns with #12-24 tapped holes
- Sturdy aluminum construction
- Durable black powder-coat finish



### Rack Max Cable Management Rack

PART NUMBER	DESCRIPTION	DIMENSIONS	LOAD RATING	RU'S	SHIPPING WEIGHT
CMR45	Rack Max 45RU cable management rack, 19" or 23" mounting	84"H x 6.5"D	1,000 lbs.	45	43 lbs.

 (9.1b) Open-Frame Racks

### Open-Frame Racks

When it comes to standard EIA-compliant aluminum open-frame relay racks, OCC offers top-of-the-line relay racks that feature a variety of heights to meet any cabling infrastructure needs. Ideal for equipment rooms and telecommunications closets, our open-frame rack is an excellent foundation to build any network system.

- 3" deep vertical channels tapped on front and back for #12–24 pilot point combo head screws
- Side web holes for linking racks
- Two top and two bottom crossbars
- 7/8" holes for floor bolting
- Sturdy aluminum construction
- Available in durable black powder-coat finish or silver coating



PART NUMBER	DESCRIPTION	DIMENSIONS	LOAD RATING	RU'S	SHIPPING WEIGHT
OF4502	84" open-frame rack, silver	84"H x 19"W x 3"D	900 lbs.	45	32 lbs.
OF4503	84" open-frame rack, black	84"H x 19"W x 3"D	900 lbs.	45	32 lbs.
OF3603	68.25" open-frame rack, black	68.25"H x 19"W x 3"D	900 lbs.	36	29 lbs.
OF2402	48" open-frame rack, silver	48"H x 19"W x 3"D	900 lbs.	24	24 lbs.
OF2403	48" open-frame rack, black	48"H x 19"W x 3"D	900 lbs.	24	24 lbs.

### Freestanding Cabinets

With OCC's complete line of freestanding cabinets, customers can provide seamless, upscale integration for any size network installation. This cabinet line offers a broad variety of solutions to fit any system application and the finest quality workmanship with the flexibility to meet any infrastructure demand.

- Removable sides and doors
- Four adjustable mounting rails
- Vented top with three 3" diameter cable-entry points
- Universal EIA alternating 5/8", 5/8", 1/2" hole pattern
- All-aluminum frame construction
- Black powder-coat finish
- IN-SERIES installation kit for multi-bay applications available
- Filter kits, bottom panels, and more accessories also available



## (9.1c) 19" Freestanding Racks & Cabinets

### 19" Freestanding Cabinets

All 19" freestanding cabinets feature:

- Four mounting rails
- Vented top with three 3" diameter cable-entry points
- Quick-release locking, vented sides
- Smoked Plexiglas® locking front door
- Solid steel, locking, vented rear door
- Leveling feet standard; locking casters optional
- Includes #12–24 pilot-point combo-head screws



Plexiglas is a registered trademark of Arkema Inc.

NOTE: 23" cabinets are also available; contact OCC for ordering information. Call 1-800-622-7711 and ask for a Sales Representative. We're ready to assist you.

PART NUMBER	DESCRIPTION	DIMENSIONS	LOAD RATING	RU'S	SHIPPING WEIGHT
CC1203	19" freestanding cabinet, black	24"H x 25"W x 24"D	240 lbs.	12	90 lbs.
CC1803	19" freestanding cabinet, black	36"H x 25"W x 24"D	360 lbs.	18	115 lbs.
CC2403	19" freestanding cabinet, black	48"H x 25"W x 24"D	480 lbs.	24	130 lbs.
CC2404	19" freestanding cabinet, black	48"H x 25"W x 32"D	480 lbs.	24	130 lbs.
CC3003	19" freestanding cabinet, black	60"H x 25"W x 24"D	600 lbs.	30	150 lbs.
CC3803	19" freestanding cabinet, black	72"H x 25"W x 24"D	760 lbs.	38	165 lbs.
CC3804	19" freestanding cabinet, black	72"H x 25"W x 32"D	760 lbs.	38	195 lbs.
CC3807	19" freestanding server cabinet, black	72"H x 25"W x 36"D	760 lbs.	38	230 lbs.
CC4503	19" freestanding cabinet, black	84"H x 25"W x 24"D	900 lbs.	45	215 lbs.
CC4504	19" freestanding cabinet, black	84"H x 25"W x 32"D	900 lbs.	45	220 lbs.
CC4507	19" freestanding server cabinet, black	84"H x 25"W x 36"D	900 lbs.	45	240 lbs.
9171-HD	Heavy-duty casters (set of 4) may be purchased separately				



## (9.2a) Wall-Mount Swing Racks

## Wall-Mount Swing Racks

For applications requiring wall-mountable access to network connectivity components, OCC offers the wall-mount swing racks for easy access and versatile equipment options. Like all of our products, quality is built into the design. The 19" Swing Rack will accommodate any of OCC's horizontal cable management accessories.

- Swings open in either direction
- 19" mounting rails
- Includes hook & loop or tie-wrap tie-down points
- Black powder-coat finish
- 14-gauge steel construction



PART NUMBER	DESCRIPTION	DIMENSIONS	LOAD CAPACITY	RU'S	SHIPPING WEIGHT
SR412	19" wall-mount swing rack, black	46.3"H x 20.6"W x 12"D	120 lbs.	25	29 lbs.
SR418	19" wall-mount swing rack, black	46.3"H x 20.6"W x 18"D	120 lbs.	25	39 lbs.
SR425	19" wall-mount swing rack, black	46.3"H x 20.6"W x 25"D	120 lbs.	25	58 lbs.
SR312	19" wall-mount swing rack, black	37.6"H x 20.6"W x 12"D	100 lbs.	20	28 lbs.
SR318	19" wall-mount swing rack, black	37.6"H x 20.6"W x 18"D	100 lbs.	20	38 lbs.
SR325	19" wall-mount swing rack, black	37.6"H x 20.6"W x 25"D	100 lbs.	20	57 lbs.
SR212	19" wall-mount swing rack, black	23.5"H x 20.6"W x 12"D	80 lbs.	12	25 lbs.
SR218	19" wall-mount swing rack, black	23.5"H x 20.6"W x 18"D	80 lbs.	12	35 lbs.
SR225	19" wall-mount swing rack, black	23.5"H x 20.6"W x 25"D	80 lbs.	12	54 lbs.

## (9.2b) Wall-Mount Racks, Cabinets & Brackets



### Wall-Mount Cabinet Enclosures

When networks need added security for wall-mounted applications, Optical Cable Corporation offers wall-mount cabinet enclosures. The OCC Wall-mount Enclosures feature a locking smoked Plexiglas® or steel front door, two adjustable shelf mounting rails and a locking rear swing frame with heavy-duty quick-release hinges for easy wall-mounting and fast access to the rear of installed equipment.

- Removable doors
- Two adjustable shelf-mounting rails
- Disassembles for easy mounting
- Solid steel or locking smoked Plexiglas® doors available
- Vented sides and top
- Ample cable entry and exit
- Accepts fan tray kits



Plexiglas is a registered trademark of Arkema Inc.

PART NUMBER	DESCRIPTION	DIMENSIONS	LOAD CAPACITY	RU'S	SHIPPING WEIGHT
WC818	Wall-mount cabinet, black	15"H x 21"W x 16"D	125 lbs.	8	37 lbs.
WC828	Wall-mount cabinet, black	15"H x 21"W x 20"D	125 lbs.	8	40 lbs.
WC1218	Wall-mount cabinet, black	24"H x 21"W x 16"D	125 lbs.	12	50 lbs.
WC1228	Wall-mount cabinet, black	24"H x 21"W x 20"D	125 lbs.	12	58 lbs.
WC1238	Wall-mount cabinet, black	24"H x 21"W x 24"D	125 lbs.	12	60 lbs.
WC1818	Wall-mount cabinet, black	36"H x 21"W x 16"D	125 lbs.	18	60 lbs.
WC1828	Wall-mount cabinet, black	36"H x 21"W x 20"D	125 lbs.	18	65 lbs.
WC1838	Wall-mount cabinet, black	36"H x 21"W x 24"D	125 lbs.	18	65 lbs.
WC2428	Wall-mount cabinet, black	45"H x 21"W x 20"D	175 lbs.	24	80 lbs.
WC2438	Wall-mount cabinet, black	45"H x 21"W x 24"D	175 lbs.	24	90 lbs.

Replace last digit "8" with "9" for solid steel door.

 (9.2c) Wall-Mount Racks, Cabinets & Brackets

### TERAX™ Enclosures

TERAX enclosures are designed explicitly for applications requiring large zone distribution capabilities and easy installation. These cabinets offer a modular solution for housing telecommunications and networking equipment in locations requiring a safe and secure environment.

- Cabinets hold up to 4RU of passive products and up to 3 RU of active equipment
- Design accepts all OCC copper rack-mount patch panels
- Patch panel brackets rotate 90°, allowing for easy installs
- Ideal cable management allows adequate space for routing and managing patch cords
- Enclosures have 16-gauge CRS welded construction
- Durable powder-coat finish protects equipment in isolated locations
- Load capacity: 100 lbs.



PART NUMBER	DESCRIPTION	DIMENSIONS	LOAD CAPACITY
TERAX2	Telecom equipment remote access enclosure, select model, mounts two patch panels, cylinder lock included	40"H x 27.12"W x 6.8"D	100 lbs.
TERAX2S	Telecom equipment remote access enclosure, standard model, mounts two patch panels, lock tab for padlock	40"H x 27.12"W x 6.88"D	100 lbs.
TERAX-FK	TERAX fan kit, 105 cfm, 115 VAC		

### Compact Sideways-Mount Enclosures

The OCC Sideways-Mount Enclosure is the perfect solution for tight spaces. With their compact design, these wall-mountable cabinets offer an economical means for protecting network components. Their all-steel construction provides excellent protection from Align lines high-traffic areas, common in retro-fit network closets. In addition to its rugged construction, oversized cable-entry points and a vented top and bottom make the sideways-mount enclosure an excellent solution where space is limited.

- Vented top and bottom that allow airflow for network equipment
- Mounts with four keyhole screw slots in standard 16" stud spacing
- Includes #12–24 pilot-point combo-head screws for fast installations
- All-steel construction with black powder-coat finish



CSM-2



## (9.2d) 19" Sideways-Mount Racks

### 19" Sideways-Mount Enclosures

For 19" mounting widths, OCC's Sideways-Mount Enclosures offer:

- Removable cover for unobstructed access
- Standard 19" mounting
- Oversized cable entry for in-wall home-run access
- Built-in cable tie-downs for plastic tie-wraps or hook & loop fasteners

PART NUMBER	DESCRIPTION	DIMENSIONS	LOAD CAPACITY	RU'S	SHIPPING WEIGHT
CSM-2	19" sideways-mount enclosure	20"H x 19"W x 3.75"D	75 lbs.	2	17 lbs.
CSM-4	19" sideways-mount enclosure	20"H x 19"W x 7.25"D	75 lbs.	4	17 lbs.



CSM-4

### 23" Sideways-Mount Enclosures

PART NUMBER	DESCRIPTION	DIMENSIONS	LOAD CAPACITY	RU'S	SHIPPING WEIGHT
CSM-7	23" sideways-mount enclosure	22.5"H x 24"W x 13.5"D	75 lbs.	7	45 lbs.
<b>Add-on Options</b>					
CSM-7MR	Additional mounting rails, pair				
FAN2	Dual fan cooling module				



CSM-7

### Wall-Mount Brackets

OCC's Wall-Mount Brackets are best suited for mounting patch panels and mixed media panels in telecom closets or any cross-connect areas where space is a premium. These brackets are designed to offer quick network connect points for 19" mounting applications, and may be stacked easily for rack-mount 110 tower applications. Either way, the OCC wall-mount brackets offer durability and flexible customization to meet any cabling infrastructure need.

- Features a quick-release design for speedy access to the back of installed equipment
- Includes #12-24 pilot-point combo-head screws for quick installations
- All-steel construction with black powder-coat finish

PART NUMBER	DESCRIPTION	DIMENSION	SHIPPING WEIGHT
WF101	1RU wall-mount bracket	1.75"H x 20"W x 4"D	2 lbs.
WF201	2RU wall-mount bracket	3.50"H x 20"W x 4"D	3 lbs.
WF403	4RU wall-mount bracket	7.00"H x 20"W x 12"D	8 lbs.
WF603	6RU wall-mount bracket	10.50"H x 20"W x 12"D	12 lbs.



WF201

 (9.3a) Shelving

### 19" Shelves for Cabinets or Racks

OCC's product line offers a full selection of shelving options for any open-frame relay rack or freestanding cabinet requiring 19" mounting applications. Each shelf may be ordered independently or kitted with any OCC enclosure to create a custom configured cabinet or rack.

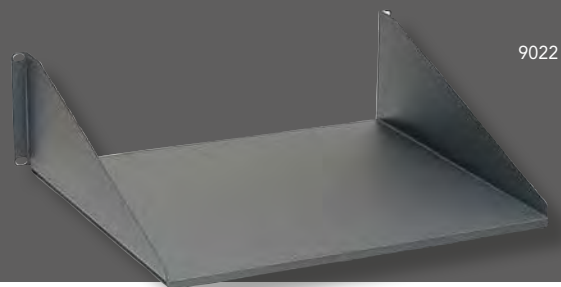

**NOTE:** Shelving for 23" cabinets or racks are also available; contact OCC for ordering information. Call 1-800-622-7711 and ask for a Sales Representative. We're ready to assist you.

### 19" Cantilever Shelves

PART NUMBER	DESCRIPTION	DEPTH	LOAD CAPACITY	SHIPPING WEIGHT
9021	1RU cantilever shelf	6.8"D	44 lbs.	2 lbs.
9021V	1RU vented cantilever shelf	6.8"D	44 lbs.	2 lbs.
9022	2RU cantilever shelf	10.5"D	55 lbs.	5 lbs.
9022V	2RU vented cantilever shelf	10.5"D	50 lbs.	6 lbs.
RRS1914A	2RU deep cantilever shelf	14.5"D	66 lbs.	6 lbs.
RRS1914AV	2RU deep vented cantilever shelf	14.5"D	66 lbs.	6 lbs.
9125	2RU double-sided cantilever shelf	25.0"D	90 lbs.	10 lbs.
9125V	2RU double-sided vented cantilever shelf	25.0"D	85 lbs.	10 lbs.
9023	3 RU cantilever shelf	15.5"D	66 lbs.	6 lbs.
9023V	3 RU vented cantilever shelf	15.5"D	60 lbs.	6 lbs.
9132	Center-mount or top-mount shelf	20.0"D	200 lbs.	10 lbs.

### 19" Four-Point Cabinet Shelves

PART NUMBER	DESCRIPTION	DEPTH	LOAD CAPACITY	SHIPPING WEIGHT
9024	Four-point vented cabinet shelf	16.0"D	220 lbs.	7 lbs.
9025	Four-point vented cabinet shelf	18.0"D	220 lbs.	7 lbs.
9026	Four-point vented cabinet shelf	24.0"D	220 lbs.	8 lbs.
9027	Four-point vented cabinet shelf	30.0"D	220 lbs.	12 lbs.



### 19" Sliding Shelves

PART NUMBER	DESCRIPTION	DEPTH	LOAD CAPACITY	SHIPPING WEIGHT
9030	1RU vented sliding shelf for 36" deep cabinets	30.0"D	110 lbs.	10 lbs.
9130	2RU sliding keyboard shelf	16.0"D	90 lbs.	12 lbs.
9029	1RU vented sliding shelf	24.0"D	110 lbs.	19 lbs.

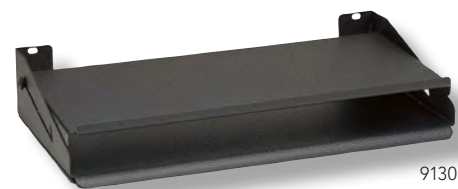



## Cable Management Solutions

OCC offers a comprehensive line of horizontal and vertical cable managers for both open frame racks and cabinets. Managers are available in ring and finger duct style. Finger duct managers are also available as a premium, high density offering in addition to our standard product set.

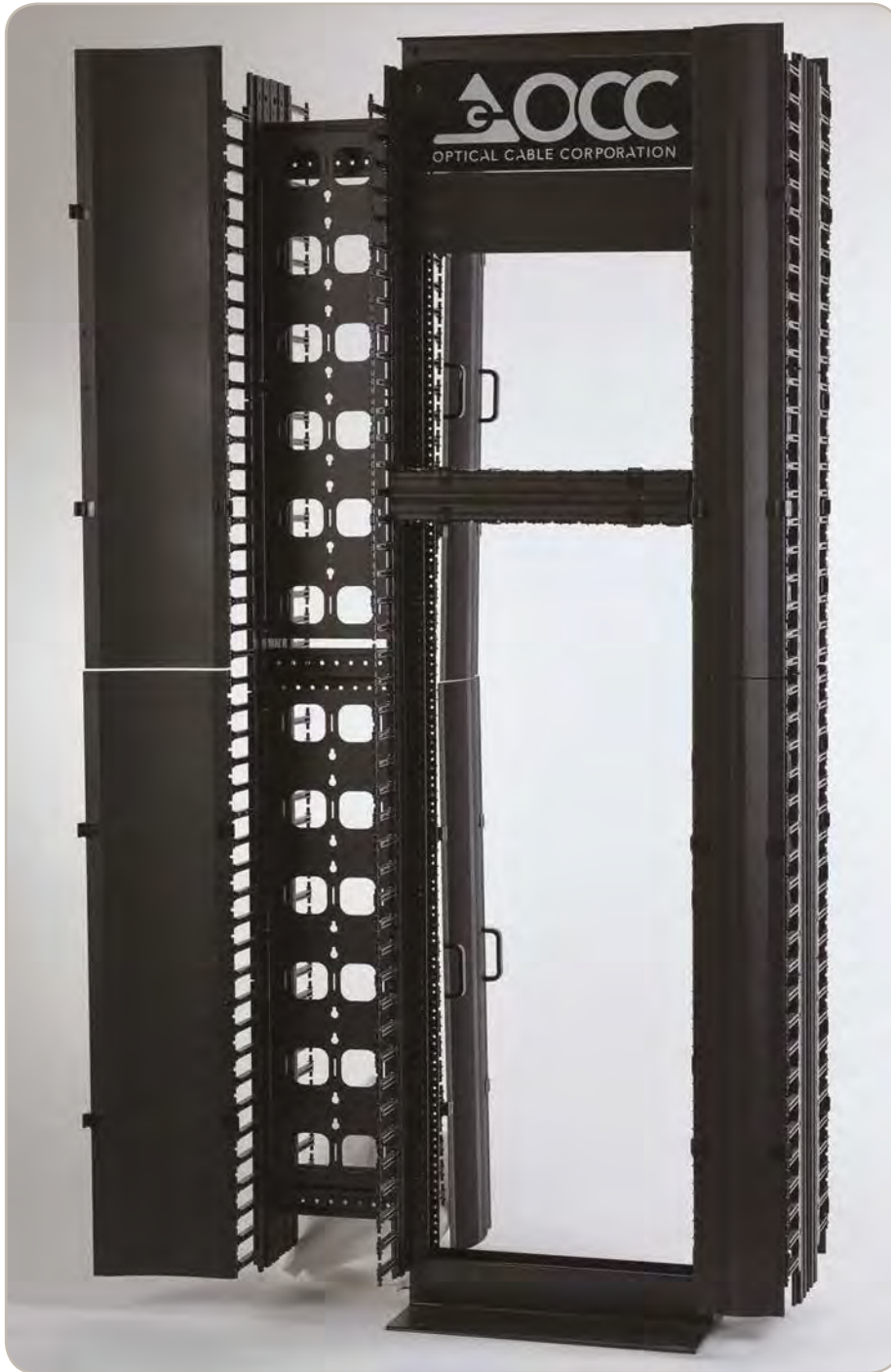

- Open Frame and Cabinet Managers
- Horizontal and Vertical Managers
- Finger Duct and Ring Style
- Finger Duct Style available in standard and premium high-capacity offering

## (9.4b) Premium High-Capacity Cable Management

### Premium High-Capacity Cable Management

OCC's premium vertical and horizontal cable management products provide increased functionality and enhanced aesthetics. These high-quality cable management products are designed for modern, high-performance network cabling. OCC's products feature effective cable management options with built-in flexibility to address any structured cabling platform and offer multiple options for width, height, and depth and all the configurations you need for rack-mounted cable management requirements.

- Aesthetically pleasing design
- Simple, modular and easy to install
- Built-in flexibility
- 6" and 10" vertical widths
- Closely spaced fingers for high-density cabling on and in between vertical racks
- Optional back covers with pass-through openings and vertical slots for attaching cable straps
- Single- and double-sided horizontal cable managers with snap-on removable hinged doors that open past 180° and remain open in the up position for convenient cable access
- Meets or exceeds all applicable TIA/EIA cable management standards



VCM645RUHD (left) , VCM1045RUHD (right)

## Cable Management Solutions

PART NUMBER	DESCRIPTION
VCM6RETBAR	Retaining bar, 6" wide
VCM10RETBAR	Retaining bar, 10" wide
VCM6GATE	Gate only, 6" wide
VCM10GATE	Gate only 10" wide
VCM102RUGATE	Gate and fingers, 2U, 10" wide
VCM62RUGATE	Gate and fingers, 2U, 6" wide
VCM1045RUBACK	Vertical cable manager back cover, 10" wide, 84" tall
VCM645RUBACK	Vertical cable manager back cover, 6" wide, 84" tall
CM504	Horizontal manager, double-sided, 2U with hinged cover
CM503	Horizontal manager single-sided, 2U with hinged cover
VCM1045RUHD	Vertical cable manager, single-sided, high-density, 10" wide, 84" with cover
VCM645RUHD	Vertical cable manager, single-sided, high-density, 6" wide, 84" with cover
VCM1045RUHDK	Vertical cable manager, double-sided kit, high-density, 10" wide, 84" with cover
VCM645RUHDK	Vertical cable manager, double-sided kit, high-density, 6" wide, 84" with cover
VCMSPOOL	Adjustable cable spool, single
VCMSPOOLKIT84	Adjustable cable spool kit for 84" tall vertical managers



## (9.4b) Premium High-Capacity Cable Management

Optional Back Cover—VCM1045RUBACK shown



## (9.4c) Standard Finger-Duct Cable Managers

### Standard Finger-Duct Cable Managers

- Vertical managers available in 36" and 72" heights
- Vertical and horizontal managers available in single-sided and double-sided configurations
- Snap-on covers



PART NUMBER	DESCRIPTION
CM401	19" horizontal cable manager, finger style, 1RU single-sided
CM402	19" horizontal cable manager, finger style, 1RU double-sided
CM403	19" horizontal cable manager, finger style, 2RU single-sided
CM404	19" horizontal cable manager, finger style, 2RU double-sided
VCMFD-36SS	Vertical fiber cable organizer, finger duct, 36", single-sided, side-mount
VCMFD-36DS	Vertical fiber cable organizer, finger duct, 36", double-sided, side-mount
VCMFD-72SS	Vertical fiber cable organizer, finger duct, 72", single-sided, side-mount
VCMFD-72DS	Vertical fiber cable organizer, finger duct, 72", double-sided, side-mount
VCMFD-36SB	Vertical fiber cable organizer, finger duct, 36", single-sided, bridge-mount
VCMFD-36DB	Vertical fiber cable organizer, finger duct, 36", double-sided, bridge-mount
VCMFD-72SB	Vertical fiber cable organizer, finger duct, 72", single-sided, bridge-mount
VCMFD-72DB	Vertical fiber cable organizer, finger duct, 72", double-sided, bridge-mount
CM207	"Vortex" 84" vertical cable organizer for open frame racks and CMR45 rack max



## (9.4d) Ring-Style Cable Managers

## Ring-Style Cable Managers

OCC's ring-style cable managers provide the capability to create vertical and horizontal pathways. The flexible ring design enables cables to be easily added or removed.

### Vertical Ring Managers

PART NUMBER	DESCRIPTION
VB13	Double-sided cable management Velcro® belt, 13", 3pk
AR24	Vertical cable management, 2" x 4" cable ring, pair
AR44	Vertical cable management, 4" x 4" cable ring, pair
VCM3	Vertical cable organizer, 3" x 7' double-sided
VCM6	Vertical cable organizer, 6" x 7' double-sided

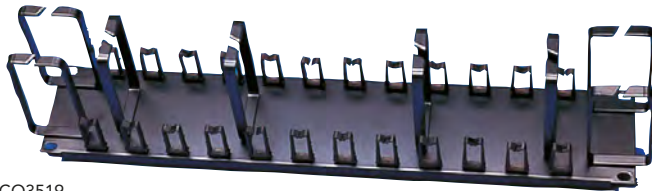

CO3519



CO17519

### Horizontal Ring Managers

PART NUMBER	DESCRIPTION
CMB19	19" cable management bar for Cat5e panel
CM102	19" cable management panel, 1RU, Velcro® belts
CM104	Front/rear side towel bar, 1RU
CM105	Cable management tab, Velcro® belts
CO17519	19" front-side cable organizer, intra-bay, 1.75", 1RU
CO17519L	19" front-side cable organizer, inter-bay, 1.75", 1RU
CO3519	19" front-side cable organizer, intra-bay, 3.5", 2RU
CO3519L	19" front-side cable organizer, inter-bay, 3.5", 2RU
COMB3519	19" cable organizer, single-sided with cover, 3.5", 2RU
COMBD3519	19" cable organizer, double-sided with cover, 3.5", 2RU
SB1719	19" cable support bar kit for EIA mounting



## Accessories

To complete any structured cabling foundation, OCC provides a complete collection of rack and cabinet accessories. For every application, OCC has created a product to meet that demand. From power panels to environmental control fans to casters and leveling feet, the OCC product line offers solutions that guarantee durability and are backed by our 15-year out-of-the-box warranty.

### Environmental Control

PART NUMBER	DESCRIPTION
FAN2	2-fan module, 216cfm, 115VAC, 12' cord (fits wall cabinets and 19" freestanding cabinets)
FAN3	3-fan module, 325cfm, 115VAC, 12' cord (fits 23" freestanding cabinets – factory-installed only)
FAN310	3-fan housing with fan grilles, 1RU rack-mount, 115VAC, 12' cord, 19" mounting brackets
FAN320	3-fan housing with fan grilles, 1RU rack-mount, 115VAC, 12' cord, 23" mounting brackets
FAN4	4-fan module, 432cfm, 115VAC, 12' cord (fits 19" freestanding cabinets only)



FAN2



FAN4

### Power Panels

PART NUMBER	DESCRIPTION
PS115	19" rack-mount power panel with surge suppression, 115VAC 15A, 12 outlets, 15' cord
PS120	19" rack-mount power panel with surge suppression, 115VAC 20A, 12 outlets, 15' cord
PS215	19" rack-mount power panel, 115VAC 15A, 10 outlets, 15' cord
PS220	19" rack-mount power panel, 115VAC 20A, 10 outlets, 15' cord
PS315	48" power strip, 115VAC 15A, 8 outlets, 15' cord
PS320	48" power strip, 115VAC 20A, 8 outlets, 15' cord



PS115 (front)



PS115 (back)



## (9.5a) Accessories

## Casters

PART NUMBER	DESCRIPTION
9171-HD	Heavy-duty locking swivel casters for freestanding cabinet, set of four



## Grounding Bars

PART NUMBER	DESCRIPTION
GRD19	19" horizontal copper rack-mount grounding bar, 1/8" x 1"
GRD30	Vertical-mount copper grounding bar for 60"/30RU cabinet, 1/8" x 1"
GRD38	Vertical-mount copper grounding bar for 72"/38RU cabinet, 1/8" x 1"
GRD45	Vertical-mount copper grounding bar for 84"/45RU cabinet, 1/8" x 1"



## 23" to 19" Reducers

PART NUMBER	DESCRIPTION
RED1	23" to 19" reducer bracket, pair, 1RU
RED2	23" to 19" reducer bracket, pair, 2RU
RED3	23" to 19" reducer bracket, pair, 3RU

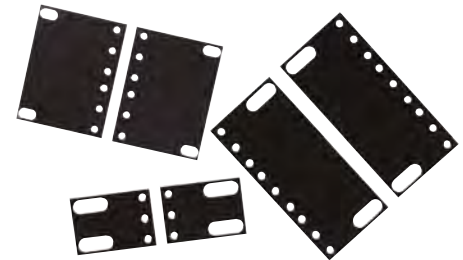

## 19" Blank Filler Panels

PART NUMBER	DESCRIPTION
9041	1RU blank filler panel, black wrinkle powder-coat finish
9042	2RU blank filler panel, black wrinkle powder-coat finish
9043	3 RU blank filler panel, black wrinkle powder-coat finish
9044	4RU blank filler panel, black wrinkle powder-coat finish



## Additional Rack or Cabinet Accessory Options

PART NUMBER	DESCRIPTION
9072	Splice kit for linking freestanding cabinets in series
9074	M6 mounting screws with washer and cage nut, set of four each
9075	M6 mounting screws with washer and cage nut, set of 100 each
9076	#12-24 cage nut, bag of 100
9173	#12-24 pilot-point combination-head rack screws, bag of 50, silver finish
9174	#12-24 pilot-point combination-head rack screws, bag of 50, black finish
9176	#12-24 pilot-point combination-head rack screws, bag of 100, silver finish
9177	#12-24 pilot-point combination-head rack screws, bag of 100, black finish
CM106	Cable tray/ladder rack top anchor for 3" deep relay rack, with cable waterfall, black
CM107	Cable tray/ladder rack top anchor for freestanding cabinets (factory installation only)



## UNCONTROLLED/HARSH ENVIRONMENT – DEPLOYABLE SYSTEMS

OCC's deployable systems are true game-changers when an installation must be done quickly and without compromise. With many systems fabricated for rapid installation by a single installer/technician, we offer exceptional choices for deployment of mobile emergency telecommunication stations, mobile tactical shelters, broadcast and more.

Reel systems are available in standard colors, as well as desert tan, to meet the needs of near-stealth installations in a variety of terrains. We can also provision reel systems with cleaning kits and field tools.

OCC's team of technical advisors is adept at helping you with the proper lengths and right accessories to meet your challenges with the efficiency and reliability that your project demands.

- Military
- Broadcast
- Mining
- Industrial
- Oil & Gas
- Other Applications

## Contents

### 10.0 Harsh Environment Deployable Systems

#### 10.1 MODULAR ADVANCED REEL SYSTEMS (MARS™)

10.1a	MARS – Features and Benefits.....	421
10.1b	MARS – Performance Specifications.....	422
10.1c	MARS – Ordering Information.....	423
10.1d	MARS – RiO Reel.....	424

#### 10.2 MARS™ ACCESSORIES

10.2a	Storage Case.....	426
10.2b	Integrated Axle Reel.....	427
10.2c	T-Frame.....	428
10.2d	Tripod.....	429
10.2e	Collapsible Tripod.....	430
10.2f	Reel Acquisition Cradle.....	431
10.2g	Transit Case with Acquisition Cradle.....	432
10.2h	Backpack.....	433
10.2i	Cartridge System.....	434
10.2j	Advanced Lightweight Reel Stand (ALRS).....	435

## (10.1a) MARS – Features and Benefits



### Applications

- Mobile Emergency Telecommunications Stations
- Mobile Tactical Shelters
- U.S. Army, Navy, and Marine Corps Military Tactical Deployments
- Broadcast
- Emergency Restoration and Deployable Communications

### Overview

OCC's Modular Advanced Reel System (MARS™), the industry's first lightweight cable deployment reel system, is designed specifically for the demanding needs of harsh-environment fiber optic installations. Unlike traditional metal-style reels, MARS is a lightweight, modular system constructed of an impact modified polymer that is easily transported. It is ideal for applications where cable needs to be deployed and reeled in quickly and stored efficiently. MARS also offers a variety of deployment options, including optional frames, backpacks, shipping cases, and cable acquisition platforms. This enables customers to meet the demands of diverse applications and uses with one modular reel and accessories platform. The OCC MARS reel can be used with simple deployable axles, or with integrated A-frames, cable acquisition cradles, transit case systems, tripods, bumper mounts, various backpacks, backpacks with fiber optic slip rings, or cartridge systems. The MARS reel, itself, incorporates options for fiber optic cleaning kits: flip-out handle, 30-ft. built-in divider, connector cradle design, and stackable features. All of these attributes (with a lower weight than common reel systems) make MARS the most advanced fiber optic reeling system available in today's market.

### Features and Benefits

- Fabricated with an impact absorbing polymer material that provides durability and strength, while remaining lightweight
- Material also eliminates rust resulting from field operations
- Integrated cable payout and storage area enable operator to deploy small lengths of fiber cable without having to unspool the entire payload — payout area does not impact cable volume
- Interlocking stacking system enables reels to be stacked and interlocked during transit
- Integrated connector storage allows multi-channel cylindrical connectors to be stored and locked in place for transit, and accommodates 0.50" to 2.1" diameter connectors
- Molded hand openings allow for easy hand transportation and deployment
- Built-in fiber optic connector cleaning kit option allows operator to maintain connectors during deployable situations
- Lightweight retractable crank-and-handle system allows operator to easily reel in deployment or take-up situations and store handle during transit
- AFO-style reels can be provisioned with either 1" diameter round hole or 1" square axle hole

To view the features of the MARS Reels in action, visit OCC's YouTube channel at <https://www.youtube.com/user/occsolutions>



 (10.1b) MARS – Performance Specifications

## Reel Performance Specifications

PARAMETER	SPECIFICATION	PERFORMANCE
Operating temperature	A336463A (U.S. Army CECOM)	-30°C to +71°C
Storage temperature	A336463A (U.S. Army CECOM)	-57°C to +85°C
Temperature-humidity cycling	A336463A (U.S. Army CECOM)	+25°C to +65°C, RH 90-98%
Cold Drop Test	A336463A (U.S. Army CECOM)	3.5 feet drop at -30°C
Flammability	UL-94 HB	Pass (HB Rating)
Vibration	A336463	3 axis, 10-33-10HZ, Horizontal 0.020 (in), Vertical 0.030 (in)

OCC's MARS AFO reels are qualified to U.S. Army CECOM specification A336463 and meet or exceed all of the requirements therein.

## Reel Mechanical Specifications

PART NUMBER	FLANGE DIAMETER	HUB DIAMETER	WIDTH	WEIGHT	CAPACITY 5.5MM OD CABLE	CAPACITY 7.2MM OD CABLE
***-0100-X-Y-Z	17"	10"	5"	7 lbs.	100m	75m
***-0300-X-Y-Z	17"	8"	7.75"	8.5 lbs.	300m	200m
***-0500-X-Y-Z	17"	8"	10.75"	9.5 lbs.	500m	325m
***-0750-X-Y-Z	17"	8"	14.75"	11 lbs.	750m	500m
***-1000-X-Y-Z	17"	8"	18.75"	12.5 lbs.	1000m	675m
***-1250-X-Y-Z	17"	8"	22.75"	14 lbs.	1250m	850m

**X=Color, Y=Cleaning kit type, Z=Axle type**

See Reel Part Numbering on next page for additional details.

## Cleaning Kits

OCC's MARS meets the challenge of today's harsh environment by offering an integrated solution to clean and maintain multi-channel cylindrical fiber optic connectors in the field. MARS can be provisioned with a variety of cleaning kits that correspond to popular connector styles, including MIL-DTL-83526, MIL-PRF-28876, MIL-DTL-38999, NAVSEA Pierside, MIL-C-83526 (TFOCA), F-LINK™ and TFOCA-II®. Cleaning Kits and Restoration Kits are available for 4, 6, 8, 12, 18 and 24-channel-style connectors.



CLEANING KITS	
K2000-KAC00x	4/12 CH M83526
K2000-KBC00x	Expanded beam
K2000-KEC00x	4/12 CH EZ-MATE
K2000-KFC00x	F-LINK Connectors
K2000-KHC00x	Hermaphroditic/SMPTE
K2000-KJC00x	6/24 CH EZ-MATE
K2000-KNC00x	M28876
K2000-KPC00x	NAVSEA Pierside
K2000-KQC00x	2.5mm ferrule
K2000-KSC00x	1.6–2.0mm ferrule
K2000-KTC00x	2 CH TFOCA*
K2000-KUC00x	1.25mm ferrule
K2000-KWC00x	MHC® II 4/8CH
K2000-KYC00x	IRIS Connector

In part numbers above for 100 meter reels, x = "1", all other reels use "2"

\*TFOCA-II® is a registered trademark of Amphenol Fiber Systems International.



(10.1c) MARS – Ordering Information



## Reel Part Numbering

**AFO -0100 -T -M -1**

### CONFIGURATION TYPE

- ACR** Reel type commercial
- AFO** Reel type military (desert tan/green/black)

### AXLE TYPE

- 1** 1" Round Axle Hole
- 2** 1" Square Axle Hole

### REEL SIZE/CAPACITY (@ 5.5MM DIAMETER CABLE)

- 0100** 100 meters
- 0300** 300 meters
- 0500** 500 meters
- 0750** 750 meters
- 1000** 1000 meters
- 1250** 1250 meters

### REEL COLOR

- T** Desert Tan
  - G** Green
  - B** Black
- Custom colors available.*

### INTEGRATED REEL CLEANING KIT\*

- A** 4/12 CH M83526
- B** Expanded beam
- E** 4/12 CH EZ-MATE
- F** F-LINK Style Connectors
- H** Hermaphroditic/SMPTE ferrule connectors
- J** 6/24 CH EZ-MATE
- N** M28876 ferrule connectors
- P** NAVSEA Pierside ferrule connectors
- Q** 2.5mm ferrule connectors
- S** 1.6–2.0mm ferrule connectors, M28876
- T** 2 CH TFOCA
- U** 1.25mm ferrule connectors
- W** MHC®II 4/8 CH
- X** None
- Y** IRIS Connector



## (10.1d) MARS – RiO™ Reel

## Integrated Remote Connections with MARS Deployable Functionality

Optical Cable Corporation introduces RiO™, an inherent solution combining a multichannel fiber optic cable assembly with an interconnect patch panel to form a unified deployable solution. By incorporating the patch panel directly into the reel housing, the RiO solution can provide significant cost savings by reducing the amount of hardware needed to connect to multiple devices. With a wide variety of cable assembly options and built-in connector panel configurations, the RiO system offers the flexibility to fit each application's specific requirement. In addition, the RiO offers the same great functionality as all OCC MARS reels, including storage efficiency, rapid deployment and easy operation. Its unique approach to deployable communications allows customers to simply Drop, Plug and Play™.

## Features & Benefits

Ideal for deployable and remote broadcast applications, emergency communication shelters, and military communications systems with limited access to interconnect panels. OCC's RiO offers:

- **An integrated fiber optic patch panel solution.** By uniting the fiber optic cable assembly with a deployable patch panel, the RiO solution can connect multiple pieces of equipment simultaneously, and can provide a quick solution that is as simple as Drop the reel in place, Plug in the connectors, and hit Play. Drop, Plug and Play.
- **Significant cost savings.** Utilizing the RiO reel allows for a single "trunk" line to distribute service to various devices. This reduces the number of additional hardware components required to connect multiple devices. In addition, shorter, lower-costing jumpers from the RiO to standard equipment provides extra cost savings.
- **Custom design and flexibility.** The RiO solution is pre-configured to meet the exact specifications of its intended application determined by the intended user. With a multitude of fiber optic cable, connector types and recessed panel options, the configuration choices are endless. OCC's technical sales team is available to help specify the exact design needed to fit each unique application.
- **Easy operability and rapid deployment.** As a member of the patented MARS family of reels and accessories, the RiO benefits from the same great features. Similar to MARS, the RiO has a lightweight rugged construction, a retractable handle for quick and easy deployment, and the ability to stack easily for storage and transit. Additionally, the RiO offers a distinct cable retention system that tethers cable to the reel, preventing accidental cable pullout.

For applications that demand efficiency and flexibility, the RiO system is an excellent choice.



RiO Reel on Collapsible Tripod

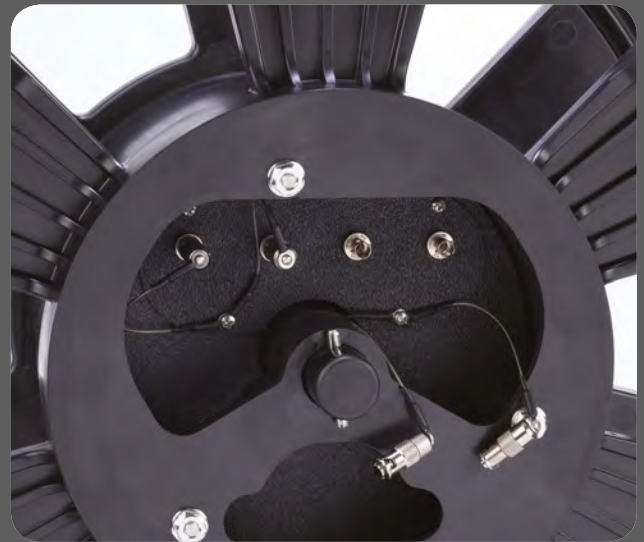

## (10.1d) MARS – RiO™ Reel



### Mechanical and Environmental Performance

PARAMETER	SPECIFICATION	PERFORMANCE
Operating temperature	MIL-STD-810C, method 501, 502	-0°C to +80°C
Storage temperature	MIL-STD-810C, method 501, 502	-45°C to +85°C
Temperature-humidity cycling	DOD-STD-1678, method 4030	+43°C, 98% humidity
Drop test	MIL-R-3241E, 3.5ft. drop, 6 sides, 2 in. firwood on concrete	1000M reel with cable, no degradation to operation
Vibration	EIA-364-28	3 axis, 10 to 33Hz, Hor. 0.020A (in.), Ver., 0.030A (in.)

### What to Know When Ordering

#### What type of cable do you require and what length?

Various cable types are available to meet any application, and OCC can provision any assembly to the specific length that meets your need. Contact OCC Sales for help determining the best cable for your application. The length of the assembly and cable O.D. determines the size of RiO reel needed.

#### What type of connections do you require?

RiO reels can be configured with a variety of connector configurations, including SMPTE 311 hybrid cable assemblies. RiO can accommodate up to 24 channels and can be configured with any OCC cylindrical or hermaphroditic plug or receptacle, as well as discrete connectors (LC, ST, SC). For detailed ordering information, contact OCC Sales.

#### What is your application?

How do you intend to install and use RiO? The RiO reel system is compatible with all MARS accessories to meet any application requirement. Tell us what the intended use is, and we can recommend options and accessories that will optimize your deployable communications solution.

Please call 1-800-622-7711 and ask for a Sales Representative. We're ready to assist you.



### Product Options for a Complete RiO Solution



Fiber Optic Patchcords - ST, SC, LC, MT/MPO



MARS Accessories



Connector Cleaning Kits



(10.2a) Storage Case

Storage Case

Features and Benefits

- Turn-key storage cases are designed to accommodate the MARS family of reels
- Interlocking waffle pattern enables secure stackability of cases during transit
- Secure latching system holds tight even in rough conditions
- Industrial foam lining maintains tight fit around reels during transit
- Pressure relief valve allows for pressure equalization in high altitude conditions



PART NUMBER	STORAGE CASE
ARS-2100-Y	Storage case for dual 100M reels
ARS-0100-Y	Storage case for 100M reel
ARS-0300-Y	Storage case for 300M reel
ARS-0500-Y	Storage case for 500M reel
ARS-0750-Y	Storage case for 750M reel
ARS-1000-Y	Storage case for 1000M reel

Replace "Y" with color code: B = black, G = green, T = desert tan

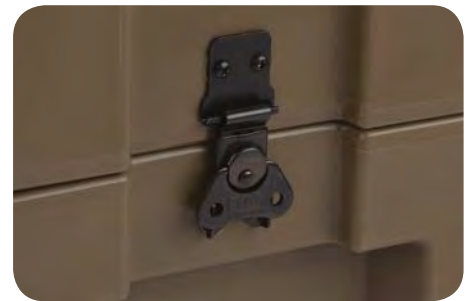

Detail of secure latching system



## (10.2b) Integrated Axle Reel



### Integrated Axle Reel (A-Frame)

#### Features and Benefits

- Easily deployed and stored base for 750M and 1000M reels
- U bearing allows convenient swapping of reels
- Pin latches secure reel during deployment
- The reel axle is field installable and can be interchanged with backpack axle
- Integrated crank handle allows for easy acquisition of cable



AAR-750-B

PART NUMBER	INTEGRATED AXLE REEL
AAR-0750-X-X-B	Base with axle for 750M reel
AAR-1000-X-X-B	Base with axle for 1000M reel

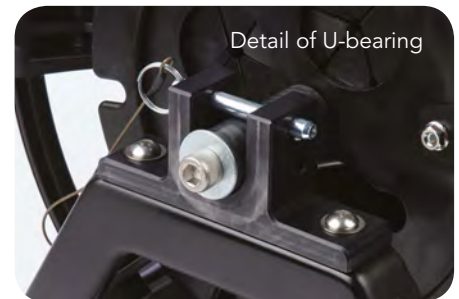

Detail of U-bearing

 (10.2c) T-Frame

## T-Frame

### Features and Benefits

- Design allows for disassembly into five components for easy shipping and storage
- Pin latches are tethered to base and lock into place
- Integrated brake adjusts the drag applied to the reel. Prevents overspin
- Integrated crank handle allows easy acquisition of cable
- The axle on the AAR base can also be used for reel storage or deployment
- Curved upper handle bar allows for easy management and deployment



ARA-1000-X-X-T

PART NUMBER	T-FRAME
ABF-0750-X-X-Y	T-frame with brake for 750M
ABF-1000-X-X-Y	T-frame with brake for 1000M
ARA-0750-X-X-Y	T-frame, without brake for 750M
ARA-1000-X-X-Y	T-frame, without brake for 1000M

Replace "Y" with color code: B = black, G = green, T = desert tan

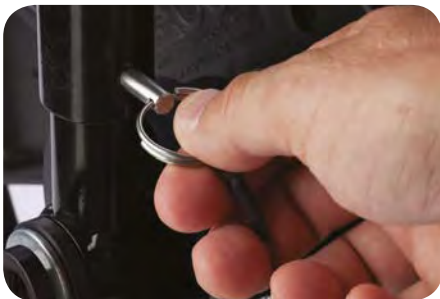

Detail of pin latch



Detail of disassembled T-frame



## (10.2d) Tripod

### Tripod

#### Features and Benefits

- Design allows for disassembly into four components for easy shipping and storage
- Pin latches are tethered to base and lock into place
- Integrated brake adjusts the drag applied to the reel, which prevents overspin
- Axles are easily interchanged and available in 100, 300 and 500M sizes
- The axle latch can easily be positioned to retain or remove the reel
- Curved handle bar allows for easy management and deployment



PART NUMBER	TRIPOD
ART-0100-X-X-Y	Tripod for 100M reel without brake
ART-0300-X-X-Y	Tripod for 300M reel without brake
ART-0500-X-X-Y	Tripod for 500M reel without brake
ATB-0100-X-X-Y	Tripod for 100M reel with brake
ATB-0300-X-X-Y	Tripod for 300M reel with brake
ATB-0500-X-X-Y	Tripod for 500M reel with brake

Replace "Y" with color code: B = black, G = green, T = desert tan



Detail of disassembled Tripod

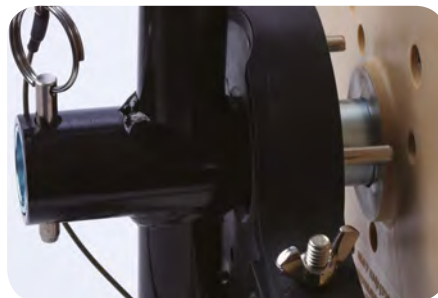

Wing nut used to apply braking function



Detail of axle latch

## (10.2e) Collapsible Tripod

### Collapsible Tripod

#### Features and Benefits

- Design allows for quick folding for easy transport, shipping and storage
- Pin latches are tethered to base and lock into place
- Integrated brake adjusts the drag applied to the reel, which prevents overspin
- Axles are easily interchanged and available in 100, 300 and 500M sizes
- The axle latch can easily be positioned to retain or remove the reel



PART NUMBER	COLLAPSIBLE TRIPOD
AFB-0100-X-X-Y	Collapsible tripod for 100M reel
AFB-0300-X-X-Y	Collapsible tripod for 300M reel
AFB-0500-X-X-Y	Collapsible tripod for 500M reel

Replace "Y" with color code: B = black, G = green, T = desert tan



*Folded collapsible tripod*



*Collapsible tripod with RiO Reel*



*Rear view of collapsible tripod*

## (10.2f) Reel Acquisition Cradle



### Reel Acquisition Cradle

#### Features and Benefits

- Cradle allows reels to spin for deployment and retrieval without additional frame
- Retractable handle on reel fully accessible for reeling
- Straps secure reel in place during transit to prevent damage or shifting
- Full access to both tether end of cable and main end
- Reel locks securely to cradle with simple turn of quick connect coupling
- Can be mounted independently to a surface or mounted into transit cases



ARN-0030

PART NUMBER	CRADLE ACQUISITION SYSTEM
ARN-0300-X-X-Y	Reel acquisition cradle for 300M reel
ARN-0500-X-X-Y	Reel acquisition cradle for 500M reel
ARN-0750-X-X-Y	Reel acquisition cradle for 750M reel
ARN-1000-X-X-Y	Reel acquisition cradle for 1000M reel

Replace "Y" with color code: B = black, G = green, T = desert tan

### Bumper Mount

#### Features and Benefits

- Swing away axle holds reels in place during deployment or retrieval on a vehicle or platform where it can be folded away when in motion
- Can be used to hold multiple combinations of the smaller reels
- Axle latch quickly locks or releases reels on the axle mount
- Can be mounted to various surfaces, bolted, or welded in place



ABM-0100

PART NUMBER	
ABM-0100	Bumper mounted axle for 100M reel
ABM-0300	Bumper mounted axle for 300M reel
ABM-0500	Bumper mounted axle for 500M reel

**10.2g Transit Case with Acquisition Cradle**

## Transit Case with Acquisition Cradle

### Features and Benefits

- Turn-key transit case with deployable cradle secures reels, while built-in cradle enables fast deployment without additional set up
- Interlocking waffle pattern enables secure stackability of cases during transit
- Secure latching system holds tight even in rough conditions
- Industrial foam lining maintains a tight fit around reels during transit
- Pressure relief valve allows for pressure equalization in high altitude conditions
- Case and cradle designed to work seamlessly with deployable handle on reels
- Reel lock secures reel during transit
- Modular reel lock on cradle allows reels to be installed or removed from cradle
- Integrated carry straps on base allow for two person deployment
- Mouse holes allow cable to be deployed with case lid on base
- Shipping strap provides additional support to reel in cradle during transit
- Utility pouch area provides storage for cleaning kits



ACC-0500-B



PART NUMBER	TRANSIT CASE
ACC-0300-X-X-Y	Transit case with cradle for 300M reel
ACC-0500-X-X-Y	Transit case with cradle for 500M reel
ACC-0750-X-X-Y	Transit case with cradle for 750M reel
ACC-1000-X-X-Y	Transit case with cradle for 1000M reel

Replace "Y" with color code: B = black, G = green, T = desert tan



Integrated carry straps



Secure latching system



Detail of reel lock



Detail of handle in use on cradle

## (10.2h) Backpacks

### Backpack

#### Features and Benefits

- Lightweight frame allows mobile cable deployment by one person
- Ideal for quick deployment in less than ideal terrain
- Accommodates standard MARS reels without modification
- A second reel can be installed for longer deployments
- Straps are adjustable for comfortable fit
- Cable can be deployed/retrieved with backpack on ground
- Optional versions are available with slip rings



PART NUMBER	BACKPACK
ARB-0300-X-X-Y	Backpack for 300M reel
ARB-0500-X-X-Y	Backpack for 500M reel

Replace "Y" with color code: B = black, G = green, T = desert tan



Detail of front of backpack



Desert tan backpack



Slip ring option



Integrated handle



 (10.2i) Cartridge System

## Cartridge System

### Features and Benefits

- Self enclosed metal case eliminates the need for shipping containers
- Gravity latch lid automatically holds the open lid in upright position
- Flip lid/tote handle and wheeled luggage capability allows for easy transport
- Reel roller elements and release knob allow reels to be interchanged or removed
- Stackability/inter-lock feature allows easy storage and transport of multiple cartridge systems. The wheels and floor mounts protrude into the lid to form an inter-locking system. A lock pin is used to inter-lock two or more cartridges together; they are designed to sustain 600 lbs. of cargo.
- Built-in tool box stores critical tools and fixtures during transport



PART NUMBER	DESCRIPTION	HEIGHT	WIDTH	DEPTH	WEIGHT
ACD-0500-X-X-Y	Modular, deployable cartridge system for 500M reel	20.74"	19.75"	14.5"	23 lbs.
ACD-0750-X-X-Y	Modular, deployable cartridge system for 750M reel	20.74"	19.75"	18.5"	28 lbs.
ACD-1000-X-X-Y	Modular, deployable cartridge system for 1000M reel	20.74"	19.75"	22.5"	33 lbs.

Replace "Y" with color code: B = black, G = green, T = desert tan



Detail of back interlocking wheels



Detail of pin latch



Detail of tool box



## (10.2j) Advanced Lightweight Reel Stand (ALRS)

### OCC Adds Another Innovative Product to Our Line of Tough, Deployable Reel Accessories.

OCC's new ALRS series of Lightweight Reel Stands represent a significant advancement in cable deployment and retrieval technology. The ALRS is a highly portable, folding A-frame stand used for paying out and retrieving cable (both copper and fiber optic) in a harsh environment. Designed for quick and easy deployment and operation, the ALRS requires no tools for set up. Additionally, when configured for transport, all pieces are maintained within the unit.

- **Engineered for the military, ready for you.** The OCC ALRS reel stand came from a direct collaboration with the U.S. Military. Their input helped us develop a highly portable folding A-frame stand that is designed for quick and easy deployment and operation – built to withstand the rigors of daily use. U.S. Army nomenclature is RL-309/U.
- **More functionality, less weight.** OCC's ALRS with its lightweight aluminum construction weighs a third of RL-31 stands (a common military stand) but offers more functionality. This simple to operate stand requires no tools for assembly, can operate from either direction without tipping, and is available with solid or split axles for independent rotation.
- **Smart, rugged construction.** All the pieces of the ALRS attach to the unit, making assembly a snap. Designed for rugged environments in all temperature ranges, the ALRS is ozone, fungus, and corrosion resistant.



### Features & Benefits

- Provides more functionality than the existing RL-31 reel stands at one third of the weight
- Constructed of lightweight aluminum and stainless steel hardware, the stand is ozone, fungus and corrosion resistant
- Conforms to Army Performance Specification A3354296
- Designed for rugged environments from rain forests to rugged mountains, from hot and humid to freezing cold, from deserts to coastal conditions
- Available with either 1" square or 1" round axle. Compatible with most common military cable reels (DR-5, DR-7, DR-8, RFO-100 through RFO-1000, and CECOM A336463 compliant reels such as the OCC MARS reels, AFO-100 through AFO-1000)
- Available with solid axles or split axles that allow independent rotation
- Bi-directional operation without tipping over
- No tools required for assembly or disassembly
- Optional storage pouch for ground stakes and/or toe clamps (also optional)
- Fully supported in the DOD logistics system with National Stock Numbers (NSN) for both complete ALRS assemblies and spare/replacement parts



## (10.2j) Advanced Lightweight Reel Stand (ALRS)

### Performance Specifications

PARAMETER	SPECIFICATION	PERFORMANCE
Protective Finish	A3354296 (CECOM)	CARC or powder-coat
Color Options	A3354296 (CECOM)	Desert tan, olive drab and black
Weight	A3354296 (CECOM)	Approx. 22 lbs.
Configuration Options	A3354296 (CECOM)	Ground mobile fixed (A-frame), rolling (wheel barrow), and litter carry (flat extended)
Rain	A3354296 (CECOM)	10cm/hr min.
Moisture Resistance	A3354296 (CECOM)	79°F and 95°F with RH between 79% and 95%
Salt Fog	MIL-STD-810G	Method 509.5 Salt Fog
High Temperature	A3354296 (CECOM)	Operational: 126°F; Storage: 168°F
Low Temperature	A3354296 (CECOM)	Operational: -26°F; Storage: -31°F
Vibration and Bounce	MIL-STD-810G	Method 514.6, Paragraph 4
Maximum Cable Reel Weight		140 lbs. / 63 kg
Dimensions	39" w (including cranks) x 27" h x 32" d (legs expanded)	



### Ordering Information

#### Reel Stand Family — ALRS

**-1 A PG 1 S 1 C**

##### AXLE TYPE

- 1 Single axle, square
- 2 Split axle, square
- 3 Split and single axles, square
- 4 Single axle, round

##### MATERIAL

- A Aluminum

##### COATING

- PG Olive drab powder-coating
- PT Desert tan powder-coating
- PB Black powder coating
- MG Military carc green coating
- MT Military carc tan coating
- MB Military carc black coating

##### BASE CLAMP

- N None
- C Toe clamps (4 each)
- S Stakes (6 each)
- E Toe clamps (4) & stakes (6)

##### POUCH\*

- 0 None
- 1 One
- 2 Two

##### CRANK

- S Single
- D Dual

##### BRAKE

- 0 None
- 1 One
- 2 Two

\*Any specific fabric pattern options must be specified at time of quote/purchase

#### Army standard unit NSN:

NSN 8130-01-630-1702 (Part no. ALRS2AMG2D1C, CARC Green)

NSN 8130-01-630-1792 (Part no. ALRS2AMT2D1C, CARC Tan)



#### **ROANOKE, VA**

Corporate Headquarters and Fiber Optic Cable  
Manufacturing Facility  
ISO 9001:2008 registered  
MIL-STD-790F certified

#### **ASHEVILLE, NC**

Enterprise Connectivity Manufacturing Facility  
ISO 9001:2008 registered

#### **DALLAS, TX**

Military & Harsh Environment Connectivity  
Manufacturing Facility  
ISO 9001:2008 registered  
MIL-STD-790F certified

#### **JOIN OUR SOCIAL NETWORK**

For the most up-to-date information on all of OCC's  
products, news and information, visit our website.  
Registered users get added benefits, access to additional  
information, white papers and more.

[occfiber.com](http://occfiber.com)



Like us on Facebook:  
[facebook.com/OCCSolutions](https://facebook.com/OCCSolutions)



Follow us on Twitter:  
[twitter.com/occsolutions](https://twitter.com/occsolutions)



Join the conversation on Linked-In:  
[linkedin.com/groups/optical-cable-corporation](https://linkedin.com/groups/optical-cable-corporation)





**CORPORATE HEADQUARTERS**

5290 Concourse Drive | Roanoke, VA 24019 | USA

Phone: +1-540-265-0690 | 800-622-7711

Fax: +1-540-265-0724