

# **Vaculine**<sup>®</sup>

CENTRAL VACUUM VALVES, FITTINGS & ACCESSORIES

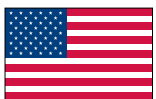

**PRICE LIST**

**UVAC-0622R3**

**JUNE 1, 2022**

**SUPERSEDES UVAC-0222 (FEB 1, 2022)**

Our website pricing is the current list price and may vary from our printed price list.  
Please visit our website for up-to-date information. [www.vaculine.com](http://www.vaculine.com)



CENTRAL VACUUM VALVES, FITTINGS & ACCESSORIES

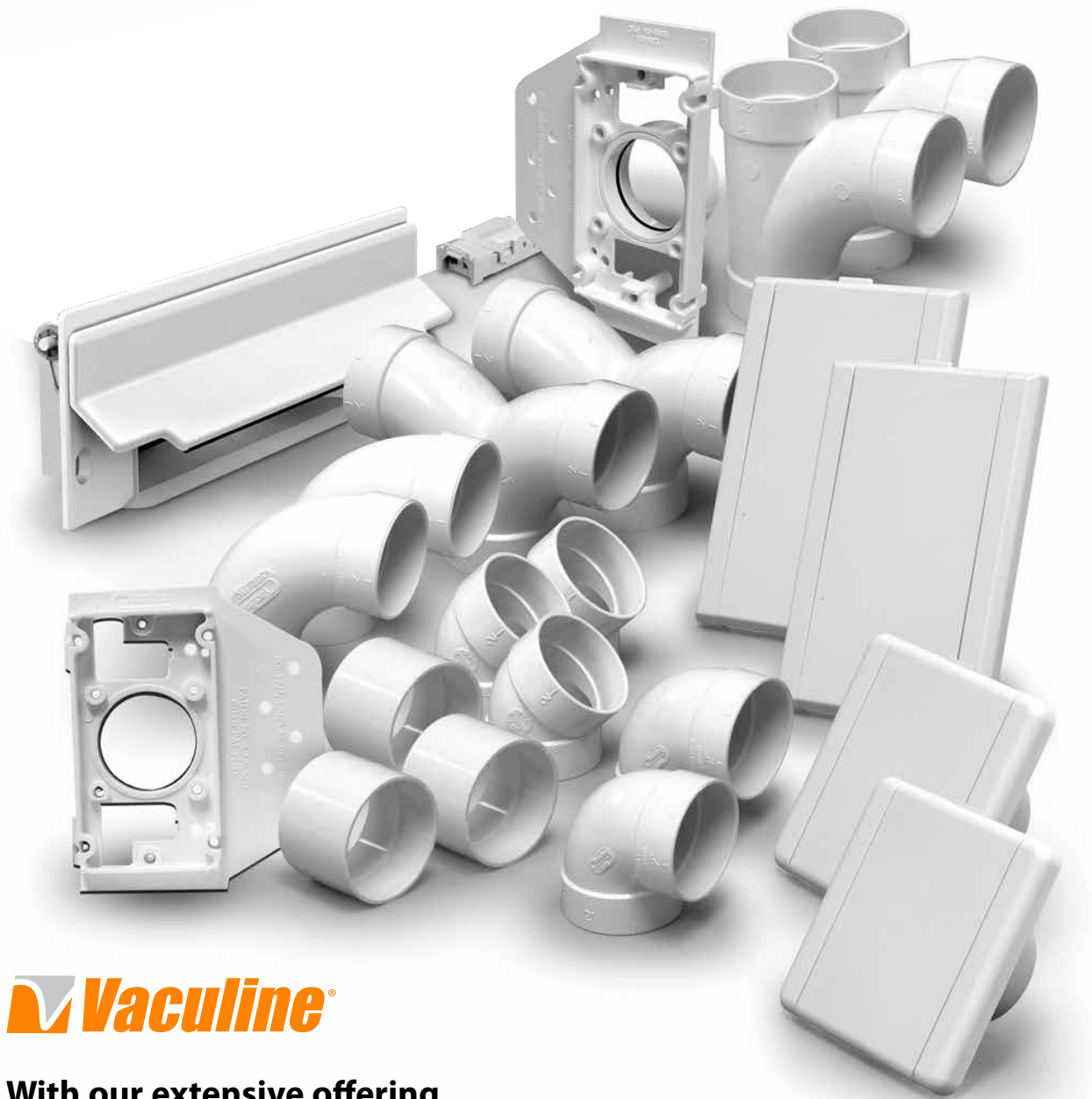

**With our extensive offering of central vacuum products, Vaculine® has established itself as a product innovator in the central vacuum industry.**

As Vaculine® continues to evolve and adapt to the changing needs of our customers, our foundation remains unchanged and reflects our fundamental commitment to customer service, high quality and innovation.

	PAGE		PAGE
<b>1.0 VALVES</b>		<b>GUARDS &amp; PLATES</b>	
1.1 SWEEP INLETS	4	4.1 PLASTER GUARDS	19
1.2 INLET VALVES	5	4.2 ROUGH-IN COVER PLATES	19
1.3 ES SQUARE VALVES	9		
1.4 UTILITY VALVES	10	<b>PIPE</b>	20
<b>2.0 FITTINGS</b>			
2.0 RHF - RETRACTABLE HOSE FITTINGS	11	<b>WARRANTY</b>	22
2.1 BASIC SEVEN FITTINGS	12		
2.2 SPECIALTY FITTINGS	12	<b>INDEX</b>	23
2.3 WYES & TEES	14		
2.4 FLANGED FITTINGS	14		
2.5 PIPE ACCESSORIES	15		
2.6 REDUCERS & ADAPTERS	16		
2.7 EXHAUST VENTS	17		
<b>3.0 MOUNTING PLATES</b>			
3.1 MOUNTING PLATES	18		

## STANDARDS, QUALITY & CODES

### STANDARDS

Vaculine® fittings are manufactured in compliance with ASTM F2158, Standard Specification for Residential Central Vacuum Tube and Fittings.

The scope of this standard includes material and performance requirements for tube and fittings used in central vacuum systems. It also offers a recommended installation practice that provides step by step instructions, including a “how to” plan to install a central vacuum system and a list of tools to complete the installation.

Compliance with the standard is confirmed when either the tube or fitting is marked with ASTM F2158 and the mark of a recognized Third Party Testing Organization. The Manufacturer is then declaring that the product was manufactured, inspected, tested and listed in accordance with the Standard Relevant Building Codes.

### QUALITY

Canplas Industries Ltd, is an ISO 9001: 2000 Company. Certification was originally received December 18, 2000 and currently registered with QMI®, a division of CSA Group.

### CODE

The use of any product in the construction/building environment is governed by Construction Codes administered by Local Jurisdiction's Having Authority (JHA). The Construction Code that includes reference to Central Vacuum Cleaning Systems is the Uniform Mechanical Code (UMC), published by the International Association of Plumbing and Mechanical Officials (IAPMO R&T) which is available at: [www.iapmo.org](http://www.iapmo.org) under the Product Listing Directory.

Vaculine® fittings are approved and listed to the IAPMO requirements and can be found under the Canplas Industries Ltd listings. A copy of the central vacuum fitting listing certificate can be viewed and downloaded from the IAPMO R&T website.

Standards and Codes are living documents that change from year to year and can affect the design and use of Central Vacuum Fittings.

Sweep Inlets



## CanSweep®

SWEEP INLET VALVE

### THE EASY OPEN-N-CLOSE VALVE

- Modern design with textured appearance
- Large outlet design for maximum airflow
- Zero loss of suction

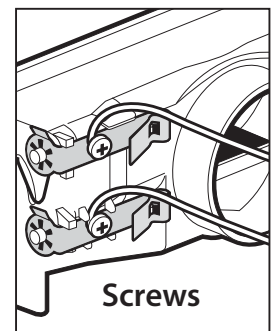
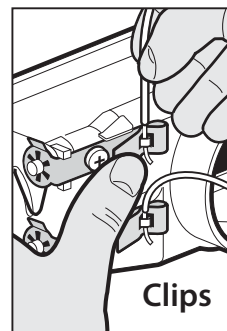

OR

New Easy & Reliable  
Wiring Connections

#### CANSWEEP®

- FITS EASILY IN THE  
KICK SPACE OF A CABINET,  
OR WITHIN A 2" X 4" STUD WALL

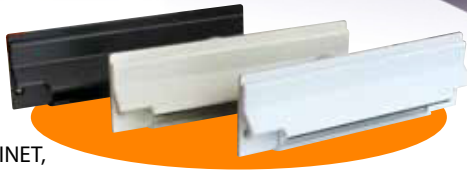

#### CANSWEEP® TRIM PLATES



PART #	COLOR	UNIT WT (LBS)	CTN QTY	SKID QTY	PRICE EACH
845625W	White	0.516	20	720	64.93
845625A	Almond	0.516	20	720	68.18
845625BLK	Black	0.516	20	720	68.18

PART #	COLOR	UNIT WT (LBS)	CTN QTY	SKID QTY	PRICE EACH
845621W	White	0.073	25	6400	14.08
845621A	Almond	0.073	25	6400	15.64
845621BLK	Black	0.073	25	6400	15.64

4

#### FLEXIBLE HOSE



PART #	COLOR	LENGTH	UNIT WT (LBS)	CTN QTY	SKID QTY	PRICE EACH
845700-2	Black	4FT	0.891	10	-	98.46
845700-3	Black	5FT	1.113	10	-	103.82



# NEXT GENERATION

# E-BOX

FOR *ElectraValve*®

Making it possible to stock  
just one SKU  
by using your own supply of wire!

"Tab"  
to hold the  
E-box for  
future valve  
installation

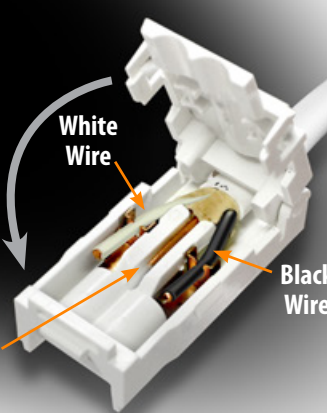
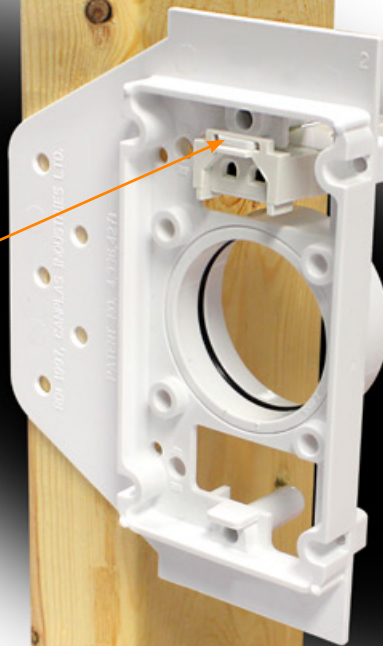

## E-box

- Simply insert wires into the E-box as instructed and snap close to secure
  - The E-box connects to the rear of the new *ElectraValve*®
- (Compatible with 12 or 14 gauge wire)



Inlet Valves

## ELECTRAVALVE®

### ElectraValve®

775850 Series  
Sold separately from  
Rough-In Kit

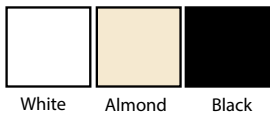

## ROUGH-IN KIT

### Install Kit

Compatible with 12 or  
14 gauge wire

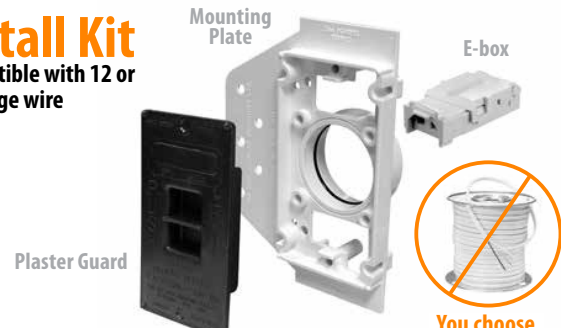

You choose  
the wire as  
required  
Not Included

PART #	COLOR	UNIT WT (LBS)	CTN QTY	SKID QTY	PRICE EACH
775850W	White	0.231	32	2304	31.13
775850A	Almond	0.207	32	2304	32.69
775850BLK	Black	0.216	32	2304	37.83

PART #	COLOR	UNIT WT (LBS)	CTN QTY	SKID QTY	PRICE EACH
775851	Black	0.205	25	1800	50.25



### E-BOX FOR ELECTRAVALVE®

PART #	COLOR	UNIT WT (LBS)	CTN QTY	SKID QTY	PRICE EACH
775851-EBX	Black	0.044	200	35000	44.90



www.vaculine.com

# SuperValve®



## YOU DECIDE YOUR INSTALLATION

Inlet Valves



### LEFT/RIGHT



### UP/DOWN

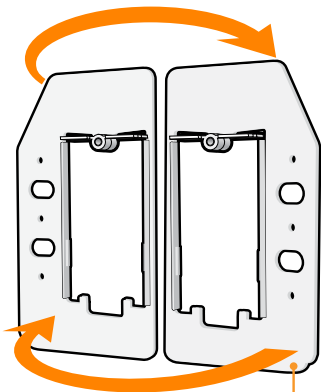

### Reversible Flange

Unlike a traditional valve, the flange of this new valve is completely separate from the body, therefore it can either be placed on the left or right of the stud depending on your installation requirements.

### NEW!

Larger lower flange for stronger installations.

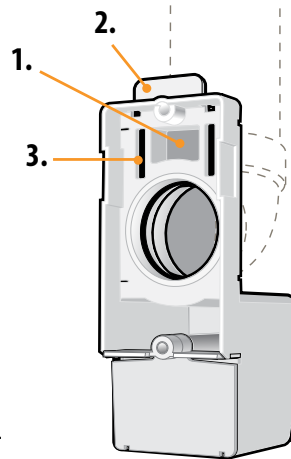

### Newly designed features

1. Recessed mini box accommodates valve plug when back plate is installed upside down.
2. Tab adds extra strength and stability to the retro-fit installation.
3. Low volt wire slots allow you to position the wire on either side of the pipe.

## SuperValve® - Full Door

LARGER ELECTRICAL ACCESS FOR EASY WIRING



PART #	COLOR	UNIT WT (LBS)	CTN QTY	SKID QTY	PRICE EACH
792090W	White	0.586	10	640	76.33
792090A	Almond	0.604	10	640	77.84

## SuperValve® - Square Door

LARGER ELECTRICAL ACCESS FOR EASY WIRING



PART #	COLOR	UNIT WT (LBS)	CTN QTY	SKID QTY	PRICE EACH
791790W	White	0.569	10	640	76.33
791790A	Almond	0.569	10	640	77.84

## SuperValve® - Side-Opening

LARGER ELECTRICAL ACCESS FOR EASY WIRING



PART #	COLOR	UNIT WT (LBS)	CTN QTY	SKID QTY	PRICE EACH
792095W	White	0.619	10	640	76.33
792095A	Almond	0.659	10	640	77.84

Inlet Valves

## Retro-Fit cover plate

**included:** Simply remove the Retro-Fit cover from the flange and discard the flange. Complete the electrical connections and snap on the cover plate. Slide box assembly through the drywall opening and secure the mounting box to the stud. Complete the assembly of the valve.

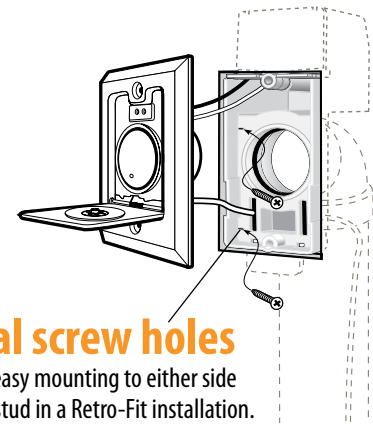
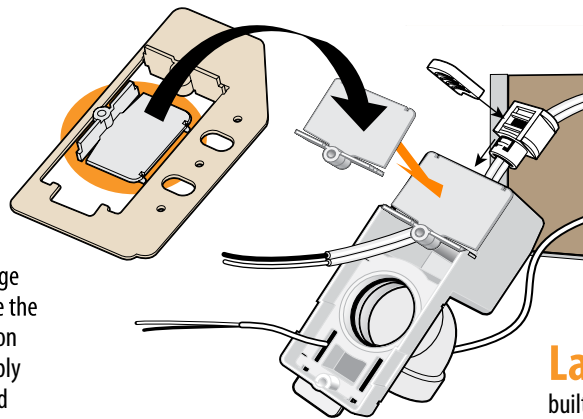

## Lateral screw holes

built in for easy mounting to either side of the wall stud in a Retro-Fit installation.

# AS EASY AS OPENING A BOOK

Inlet Valves



REVEALS A NEW  
LOOK TO THE  
TRADITIONAL  
VERTICAL-  
OPENING  
VALVES

## SIDE-OPENING VALVES



8

VacuValve®  
Side-Opening

SuperValve®  
Side-Opening

PART #	COLOR	UNIT WT (LBS)	CTN QTY	SKID QTY	PRICE EACH
<b>VacuValve® Side-Opening</b>					
775591W	White	0.251	24	1536	18.61
775591A	Almond	0.251	24	1536	19.80
<b>SuperValve® Side-Opening</b>					
792095W	White	0.619	10	640	76.33
792095A	Almond	0.659	10	640	77.84

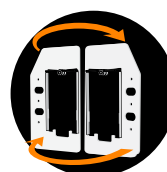

### Reversible Flange

Unlike a traditional valve, the flange of this new valve is completely separate from the body, therefore it can either be placed on the left or right of the valve depending on your installation requirements.



## INLET VALVES

### VACUVALVE

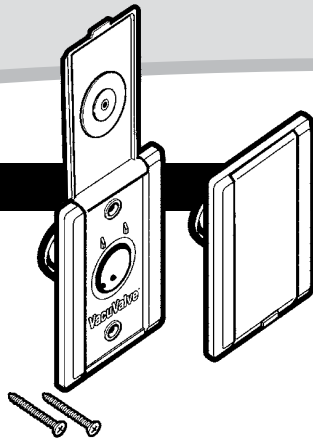

PART #	COLOR	UNIT WT (LBS)	CTN QTY	SKID QTY	PRICE EACH
775590W	White	0.231	32	2304	18.48
775590A	Almond	0.192	32	2304	19.54
775590BLK	Black	0.192	32	2304	19.54

### TRIM PLATE

THE TRIM PLATE MOUNTS BEHIND THE VALVE TO COVER UNSIGHTLY GAPS IN THE DRYWALL AND TO ENHANCE THE DECOR OF THE VALVE.

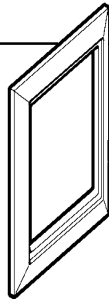

PART #	COLOR	UNIT WT (LBS)	CTN QTY	SKID QTY	PRICE EACH
775589W	White	0.066	150	10800	8.45
775589A	Almond	0.049	150	10800	8.40
775589BLK	Black	0.049	150	10800	8.45

### SQUARE DOOR VALVE

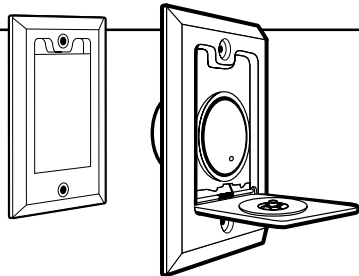

PART #	COLOR	UNIT WT (LBS)	CTN QTY	SKID QTY	PRICE EACH
791700W	White	0.201	24	1536	22.97
791700A	Almond	0.201	24	1536	24.10

### ROUND DOOR VALVE

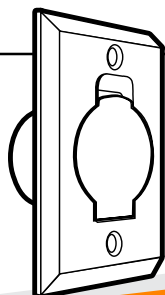

PART #	COLOR	UNIT WT (LBS)	CTN QTY	SKID QTY	PRICE EACH
791500WNL	White	0.183	24	1536	19.59
791500ANL	Almond	0.183	24	1536	20.71

### FULL DOOR VALVE

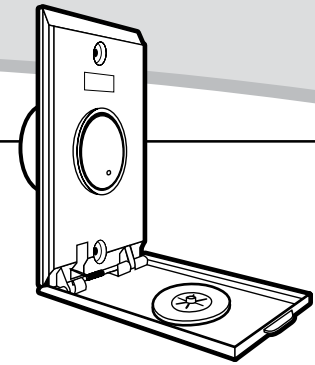

PART #	COLOR	UNIT WT (LBS)	CTN QTY	SKID QTY	PRICE EACH
792000W	White	0.271	24	1536	22.97
792000A	Almond	0.271	24	1536	24.10

### FULL DOOR VALVE TRIM PLATE

FOR USE WITH 792000 VALVES

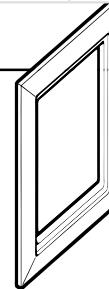

PART #	COLOR	UNIT WT (LBS)	CTN QTY	SKID QTY	PRICE EACH
791600W	White	0.055	80	-	4.75
791600A	Almond	0.053	80	-	5.32

## ES SQUARE VALVES

### ES PLASTIC VALVE

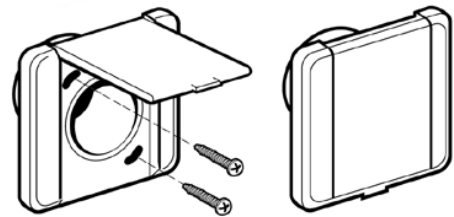

PART #	COLOR	UNIT WT (LBS)	CTN QTY	SKID QTY	PRICE EACH
775592W	White	0.148	48	3456	19.40
775592A	Almond	0.148	48	3456	20.20
775592BLK	Black	0.148	48	3456	20.20

### ES TRIM PLATE



PART #	COLOR	UNIT WT (LBS)	CTN QTY	SKID QTY	PRICE EACH
775588W	White	0.035	165	11880	4.75

Inlet Valves

### UTILITY VALVES

#### UTILITY VALVE

- SPIGOT x VALVE

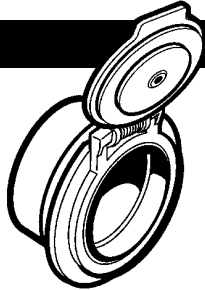

PART #	COLOR	UNIT WT (LBS)	CTN QTY	SKID QTY	PRICE EACH
775583W	White	0.090	100	7200	15.41

#### UTILITY VALVE WITH GROMMET AND RETAINING RING

- SPIGOT x VALVE

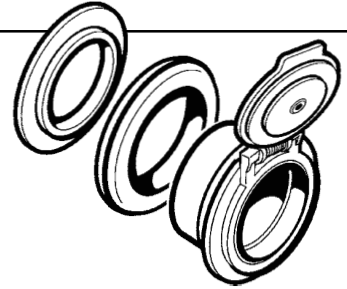

PART #	COLOR	UNIT WT (LBS)	CTN QTY	SKID QTY	PRICE EACH
775584W	White	0.141	100	4800	23.16
775584BLK	Black	0.099	100	4800	28.71

#### UTILITY VALVE WITH PIN JACKS

- SPIGOT x VALVE

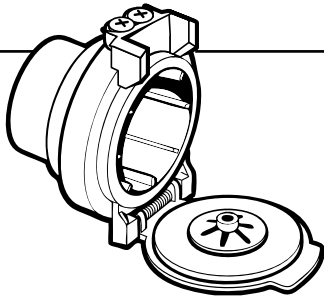

PART #	COLOR	UNIT WT (LBS)	CTN QTY	SKID QTY	PRICE EACH
775586W	White	0.130	100	7200	22.03
775586BLK	Black	0.108	100	7200	21.47

#### UTILITY VALVE GROMMET



PART #	COLOR	UNIT WT (LBS)	CTN QTY	SKID QTY	PRICE EACH
775584-1	Black	0.037	500	-	9.68

Utility Valves

Mount to exposed pipe or Vacuum unit. Perfect for workshops, garages and more where traditional wall valves and mounting plates are not needed.

Stop tabs secure hose cuff in place preventing hose from rotating and losing electrical connection.





**NEW!** RETRACTABLE  
*Hose Fittings*

\* True 90°  
Elbow  
Clear

30% thicker walls  
for increased  
strength

True 90°  
Elbow

Smooth interior walls  
with no obstructions

High quality resin  
resists pipe  
deformation  
due to heat

45°

RHF  
Stopper

22.5°

Fittings

Description	PART #	COLOR	UNIT WT (LBS)	CTN QTY	SKID QTY	PRICE EACH
RHF 90° LONG ELBOW Clear	765601CL	Clear	0.539	20	640	194.48
RHF 90° LONG ELBOW	765601W	White	0.540	20	640	65.31
RHF 45° ELBOW	765602W	White	0.304	20	1440	52.24
RHF 22.5° ELBOW	765603W	White	0.150	20	2500	39.31
RHF STOPPER	765604W	White	0.077	36	1620	4.60

\* Clear 90° Long elbow fitting is for promotional / marketing purposes only. Not recommended for installations.



### 2.1 BASIC SEVEN FITTINGS

#### 90° SWEEP ELBOW

- SOCKET x SOCKET

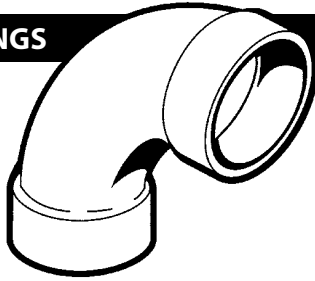

PART #	COLOR	UNIT WT (LBS)	CTN QTY	SKID QTY	PRICE EACH
765510W	PVC - White	0.176	75	2400	4.14
785510	ABS - Black	0.152	75	2400	11.03

#### 90° SWEEP ELBOW SPIGOT

- SOCKET x SPIGOT

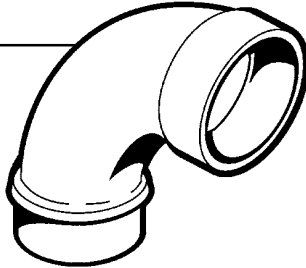

PART #	COLOR	UNIT WT (LBS)	CTN QTY	SKID QTY	PRICE EACH
765511W	PVC - White	0.159	50	2400	4.14
785511	ABS - Black	0.154	50	2400	15.62

#### 90° SWEEP TEE

- SOCKET x SOCKET x SOCKET

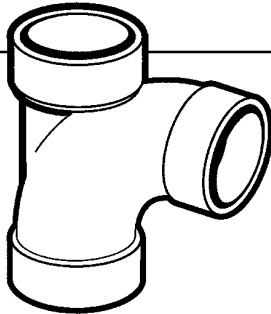

PART #	COLOR	UNIT WT (LBS)	CTN QTY	SKID QTY	PRICE EACH
765501W	White	0.198	55	1760	4.98

#### 90° SHORT ELBOW

- SOCKET x SOCKET

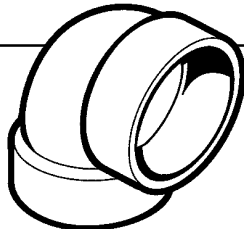

PART #	COLOR	UNIT WT (LBS)	CTN QTY	SKID QTY	PRICE EACH
765506W	PVC - White	0.106	90	4320	3.67
785506	ABS - Black	0.079	90	4320	6.18

#### 45° ELBOW

- SOCKET x SOCKET

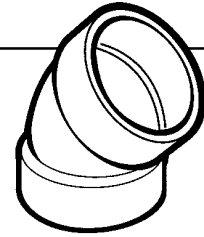

PART #	COLOR	UNIT WT (LBS)	CTN QTY	SKID QTY	PRICE EACH
765517W	PVC - White	0.086	80	5760	3.52
785517	ABS - Black	0.060	80	5760	5.50

#### 45° ELBOW SPIGOT

- SOCKET x SPIGOT

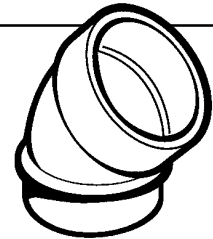

PART #	COLOR	UNIT WT (LBS)	CTN QTY	SKID QTY	PRICE EACH
765518W	PVC - White	0.079	80	5760	3.37
785518	ABS - Black	0.049	80	5760	5.50

#### STOP COUPLING

- SOCKET x SOCKET

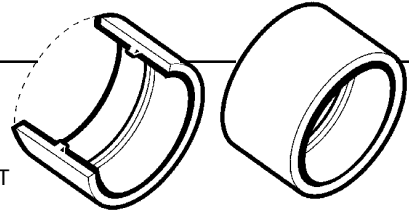

PART #	COLOR	UNIT WT (LBS)	CTN QTY	SKID QTY	PRICE EACH
765529W	White	0.049	175	8400	1.68

### 2.2 SPECIALTY FITTINGS

#### 90° EXTRA SHORT ELBOW

For 2" x 3" or 2" x 4" Walls

- SOCKET x SOCKET

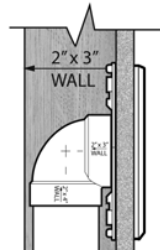
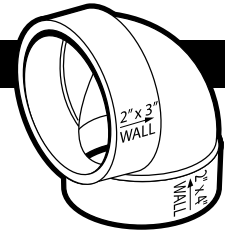

Installers have one more choice, making their work easier: can be used for either 2" x 3" wall or 2" x 4" wall.

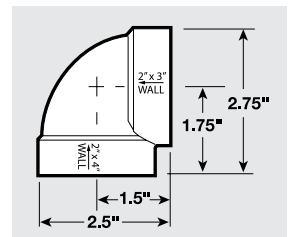

PART #	COLOR	UNIT WT (LBS)	CTN QTY	SKID QTY	PRICE EACH
765503W	White	0.106	125	6000	4.02



## SPECIALTY FITTINGS

### 90° SHORT ELBOW WITH SHORT SOCKET

- SOCKET x SOCKET

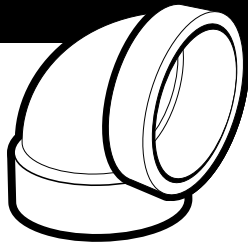

PART #	COLOR	UNIT WT (LBS)	CTN QTY	SKID QTY	PRICE EACH
765504W	White	0.090	100	4800	6.22

### 90° SHORT ELBOW SPIGOT

- SOCKET x SPIGOT

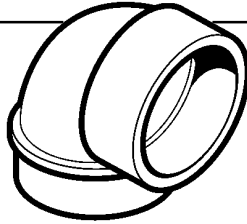

PART #	COLOR	UNIT WT (LBS)	CTN QTY	SKID QTY	PRICE EACH
765507W	White	0.097	90	4320	5.81

### 90° MEDIUM SWEEP ELBOW

- SOCKET x SOCKET

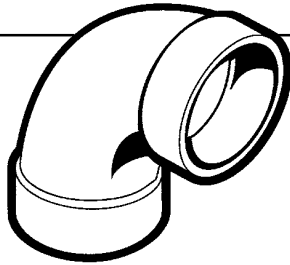

PART #	COLOR	UNIT WT (LBS)	CTN QTY	SKID QTY	PRICE EACH
765508W	PVC - White	0.128	80	3840	6.37
785508	ABS - Black	0.086	80	3840	9.80

### 90° MEDIUM SWEEP ELBOW SPIGOT

- SOCKET x SPIGOT

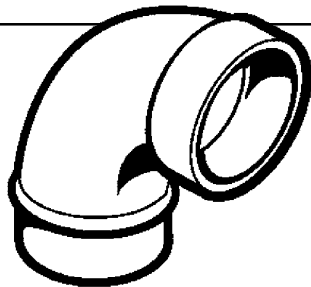

PART #	COLOR	UNIT WT (LBS)	CTN QTY	SKID QTY	PRICE EACH
765509W	White	0.117	50	3600	6.20

### 30° ELBOW

- SOCKET x SOCKET

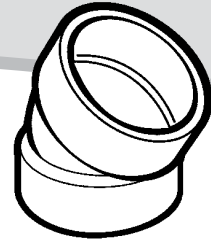

PART #	COLOR	UNIT WT (LBS)	CTN QTY	SKID QTY	PRICE EACH
765519W	White	0.071	75	5400	5.06

### 30° ELBOW SPIGOT

- SOCKET x SPIGOT

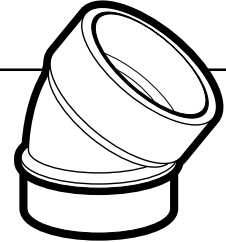

PART #	COLOR	UNIT WT (LBS)	CTN QTY	SKID QTY	PRICE EACH
762032	White	0.071	125	-	6.20

### 38° ELBOW

- SOCKET x SOCKET

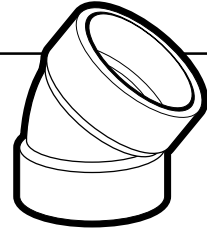

PART #	COLOR	UNIT WT (LBS)	CTN QTY	SKID QTY	PRICE EACH
762038	White	0.082	125	-	9.33

### SPIGOT COUPLING

- SPIGOT x SPIGOT

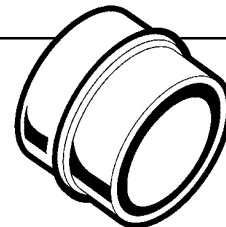

PART #	COLOR	UNIT WT (LBS)	CTN QTY	SKID QTY	PRICE EACH
765527W	PVC - White	0.049	125	9000	2.84
785527	ABS - Black	0.035	125	9000	8.82

### SLIP COUPLING

- SOCKET x SOCKET

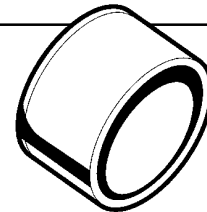

PART #	COLOR	UNIT WT (LBS)	CTN QTY	SKID QTY	PRICE EACH
765528W	White	0.049	175	8400	3.99

### 3-WAY 90° ELBOW

- SOCKET x SOCKET  
x SOCKET

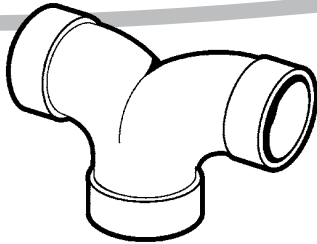

PART #	COLOR	UNIT WT (LBS)	CTN QTY	SKID QTY	PRICE EACH
765515W	White	0.223	50	1600	9.45

### WYES & TEES

#### DOUBLE WYE

- SOCKET x SOCKET  
x SOCKET

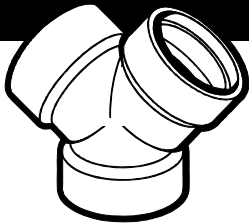

PART #	COLOR	UNIT WT (LBS)	CTN QTY	SKID QTY	PRICE EACH
762145	White	0.128	65	3120	8.67

#### 45° WYE

- SOCKET x SOCKET x SOCKET

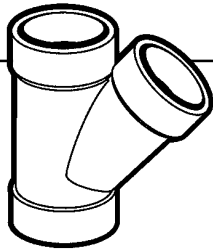

PART #	COLOR	UNIT WT (LBS)	CTN QTY	SKID QTY	PRICE EACH
765525W	White	0.187	60	1920	7.26

#### SHORT TEE

- SOCKET x SOCKET x SOCKET

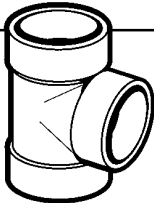

PART #	COLOR	UNIT WT (LBS)	CTN QTY	SKID QTY	PRICE EACH
765502W	White	0.148	90	2880	7.92

#### SHORT TEE WITH SHORT SOCKET

- SOCKET x SOCKET x SOCKET

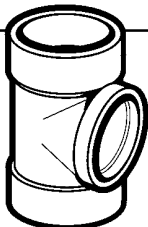

PART #	COLOR	UNIT WT (LBS)	CTN QTY	SKID QTY	PRICE EACH
765502SW	White	0.143	90	2880	8.60

### FLANGED FITTINGS

#### FLANGED SOCKET WITH GASKET

- FLANGE x SOCKET

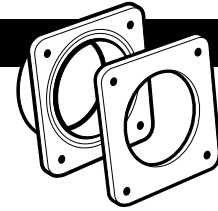

PART #	COLOR	UNIT WT (LBS)	CTN QTY	SKID QTY	PRICE EACH
765550W	White	0.060	150	10800	21.63

#### FLANGED SPIGOT WITH GASKET

- FLANGE x SPIGOT

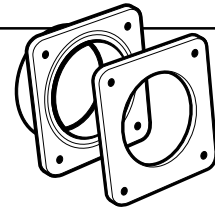

PART #	COLOR	UNIT WT (LBS)	CTN QTY	SKID QTY	PRICE EACH
765555W	White	0.060	150	10800	8.03

#### FLANGED SLIP COUPLING

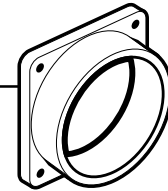

PART #	COLOR	UNIT WT (LBS)	CTN QTY	SKID QTY	PRICE EACH
762040	White	0.040	50	9000	5.76

#### CURVED FLANGED COUPLING

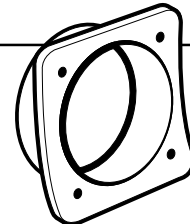

PART #	COLOR	UNIT WT (LBS)	CTN QTY	SKID QTY	PRICE EACH
762023	White	0.044	50	-	5.58

#### SQUARE GASKET

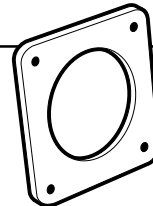

PART #	COLOR	UNIT WT (LBS)	CTN QTY	SKID QTY	PRICE EACH
762100	White	0.007	2000	-	3.38

## FLANGED 90° LONG ELBOW WITH GASKET

- SOCKET x FLANGE

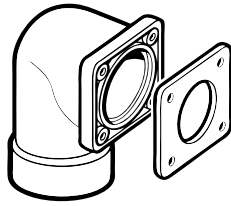

PART #	COLOR	UNIT WT (LBS)	CTN QTY	SKID QTY	PRICE EACH
765553W	White	0.157	75	3600	12.98

## FLANGED 90° SHORT ELBOW WITH GASKET

- SOCKET x FLANGE

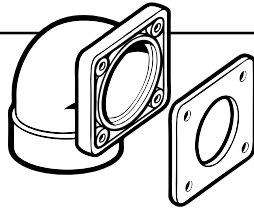

PART #	COLOR	UNIT WT (LBS)	CTN QTY	SKID QTY	PRICE EACH
765556W	White	0.130	130	4160	11.46

## CANISTER INTAKE WITH GASKET

- FLANGE x SPIGOT

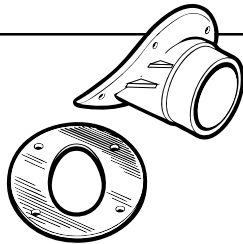

PART #	COLOR	UNIT WT (LBS)	CTN QTY	SKID QTY	PRICE EACH
765597W	PVC - White	0.141	100	3200	14.52
785597	ABS - Black	0.110	100	3200	28.47

## PIPE ACCESSORIES

### WIRE CLIP

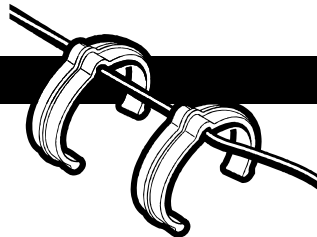

PART #	COLOR	UNIT WT (LBS)	CTN QTY	SKID QTY	PRICE EACH
765544W	White	0.011	500	36000	1.12

### PIPE STRAP

WITH BUILT-IN  
WIRE HOLDER

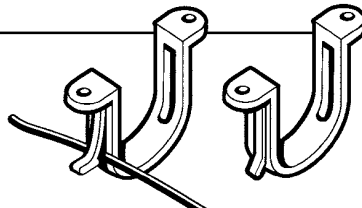

PART #	COLOR	UNIT WT (LBS)	CTN QTY	SKID QTY	PRICE EACH
765545W	White	0.029	300	21600	1.39

### PIPE STRAP

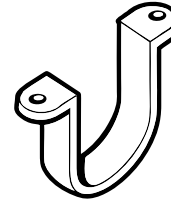

PART #	COLOR	UNIT WT (LBS)	CTN QTY	SKID QTY	PRICE EACH
762017	White	0.029	600	28800	1.60

### HUB STRAP

USED TO ANCHOR  
SOCKET CONNECTIONS

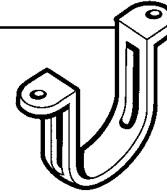

PART #	COLOR	UNIT WT (LBS)	CTN QTY	SKID QTY	PRICE EACH
765548W	White	0.044	250	18000	4.81

### SLIP CAP

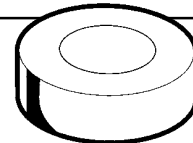

PART #	COLOR	UNIT WT (LBS)	CTN QTY	SKID QTY	PRICE EACH
765547W	PVC - White	0.040	250	18000	3.38
785547	ABS - Black	0.029	250	-	5.67

### PIPE COLLAR

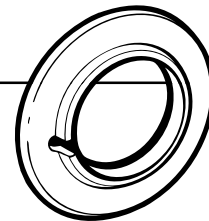

PART #	COLOR	UNIT WT (LBS)	CTN QTY	SKID QTY	PRICE EACH
762031	White	0.031	100	-	4.88

### PIPE FIRE BARRIER

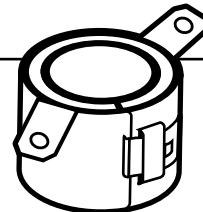

PART #	COLOR	UNIT WT (LBS)	CTN QTY	SKID QTY	PRICE EACH
761455	Red / Black	0.320	10	-	351.34

### REDUCERS & ADAPTERS

#### 40mm ADAPTER

- 2" X 1.63"

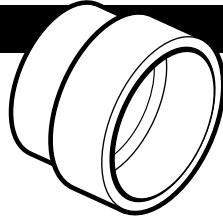

PART #	COLOR	UNIT WT (LBS)	CTN QTY	SKID QTY	PRICE EACH
765530W	White	0.060	90	12960	6.42

CONNECTS 2" VACUUM PIPE TO 40MM EUROPEAN PIPE

#### INLET VALVE EXTENSION

- 2" x 1.66"

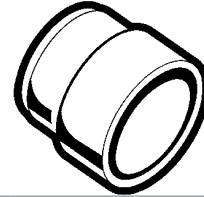

PART #	COLOR	UNIT WT (LBS)	CTN QTY	SKID QTY	PRICE EACH
765541W	White	0.040	100	14400	4.35

CONNECTS SPIGOT OF VALVE TO MOUNTING PLATE WHERE WALL FINISHING MATERIALS ARE THICKER

#### 50MM ADAPTER

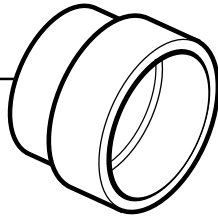

PART #	COLOR	UNIT WT (LBS)	CTN QTY	SKID QTY	PRICE EACH
765535W	White	0.055	125	9000	2.43

CONNECTS 2" VACUUM PIPE TO 50MM EUROPEAN PIPE

#### VALVE REDUCER BUSHING

- 2" X 1 5/8"

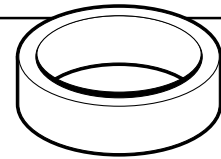

PART #	COLOR	UNIT WT (LBS)	CTN QTY	SKID QTY	PRICE EACH
762026	White	0.031	100	-	5.13

#### 1-1/4" DWV ADAPTER

- 2" X 1.66"

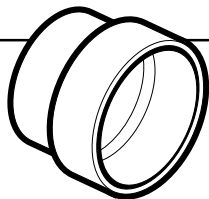

PART #	COLOR	UNIT WT (LBS)	CTN QTY	SKID QTY	PRICE EACH
765531W	White	0.053	90	12960	3.26

CONNECTS 2" VACUUM PIPE TO 1-1/4" DWV PIPE

#### 1-1/2" FLEX HOSE ADAPTER

- 2" X 1.825"

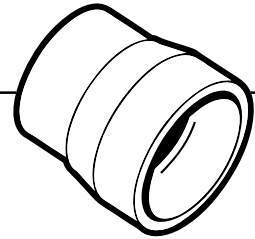

PART #	COLOR	UNIT WT (LBS)	CTN QTY	SKID QTY	PRICE EACH
765532W	White	0.079	135	9720	8.40

CONNECTS 2" VACUUM PIPE TO 1-1/2" FLEXIBLE PLASTIC HOSE

#### REDUCER BUSHING

- 2" x 1.66"

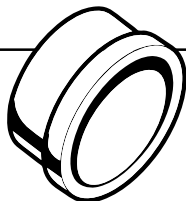

PART #	COLOR	UNIT WT (LBS)	CTN QTY	SKID QTY	PRICE EACH
765537W	White	0.049	100	14400	2.49

1-1/2" SPIGOT x 2" SOCKET ADAPTER THAT GOES INSIDE A 1-1/2" DWV SOCKET AND CONNECTS TO 2" VACUUM PIPE



### PIPE ADAPTER

- 2" X 1 3/4"

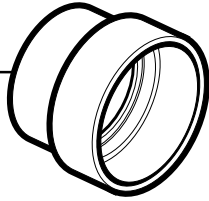

PART #	COLOR	UNIT WT (LBS)	CTN QTY	SKID QTY	PRICE EACH
762016	White	0.064	30	-	6.36

### PIPE ADAPTER

- 2" X 1 13/16"

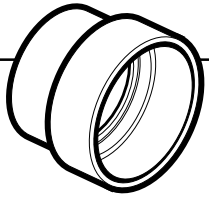

PART #	COLOR	UNIT WT (LBS)	CTN QTY	SKID QTY	PRICE EACH
762015	White	0.057	30	-	6.00

### DISCHARGE ADAPTER

- 2" X 1 7/8"

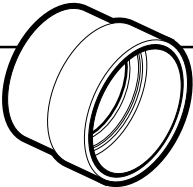

PART #	COLOR	UNIT WT (LBS)	CTN QTY	SKID QTY	PRICE EACH
762027	White	0.057	30	-	5.79

### BAG ADAPTER

- SPIGOT x ADAPTER

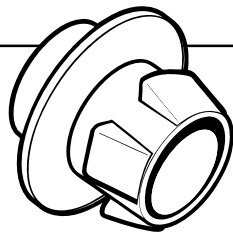

PART #	COLOR	UNIT WT (LBS)	CTN QTY	SKID QTY	PRICE EACH
765542W	White	0.123	75	3600	7.99

## EXHAUST VENTS

### EXHAUST VENT

- SOCKET x VENT

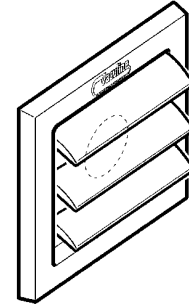

PART #	COLOR	UNIT WT (LBS)	CTN QTY	SKID QTY	PRICE EACH
765540W	White	0.216	25	1800	18.99

### EXHAUST VENT

- SOCKET x VENT

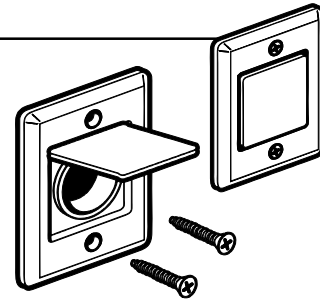

PART #	COLOR	UNIT WT (LBS)	CTN QTY	SKID QTY	PRICE EACH
793030W	White	0.143	40	2560	10.70

Mufflers & Exhaust

## MOUNTING PLATES

### "VACULINE-STYLE" PLASTIC MOUNTING PLATE

- WITH 3/4" SPIGOT

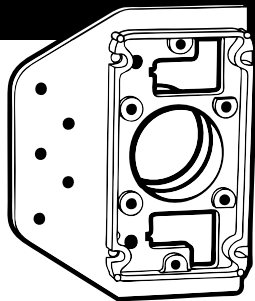

PART #	COLOR	UNIT WT (LBS)	CTN QTY	SKID QTY	PRICE EACH
765568W	White	0.119	75	3600	8.07

FOR USE WITH 2"x 4" INSTALLATION

### "HAYDEN-STYLE" PLASTIC MOUNTING PLATE

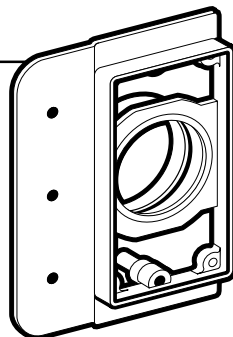

PART #	COLOR	UNIT WT (LBS)	CTN QTY	SKID QTY	PRICE EACH
791041W	White	0.108	75	3600	4.91

FOR USE WITH 2"x 4" INSTALLATION - WITH 3/4" SPIGOT

PART #	COLOR	UNIT WT (LBS)	CTN QTY	SKID QTY	PRICE EACH
791044W	White	0.099	75	3600	6.26

FOR USE WITH 2"x 3" INSTALLATION - WITH 1/4" SPIGOT

### FULL METAL MOUNTING PLATE

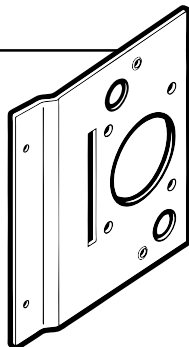

PART #	COLOR	UNIT WT (LBS)	CTN QTY	SKID QTY	PRICE EACH
765560N	White	0.143	150	-	5.49

### METAL MOUNTING PLATE

- WITH 3/4" SPIGOT FLANGE

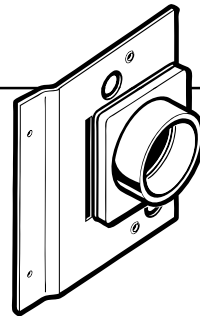

PART #	COLOR	UNIT WT (LBS)	CTN QTY	SKID QTY	PRICE EACH
765565W	White	0.201	64	4608	22.89

### ES MOUNTING PLATE WITH PLASTER GUARD

- FOR CONCRETE WALLS

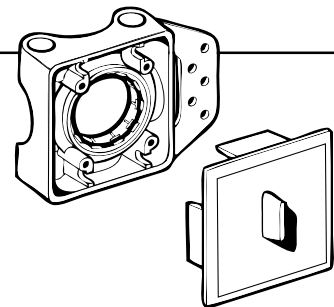

PART #	COLOR	UNIT WT (LBS)	CTN QTY	SKID QTY	PRICE EACH
1/4" SPIGOT					
765569W	White	0.134	60	4320	19.43
3/4" SPIGOT					
765569LW	White	0.148	60	4320	19.57

1/4" SHORT SPIGOT FOR USE WITH SHORT SOCKET ELBOW ( 765504W) AND SHORT SOCKET TEE (765502S). FOR 2" X 3" INSTALLATIONS.

### ES MOUNTING PLATE

- FOR STUD WALLS

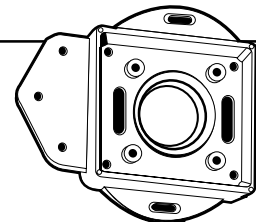

PART #	COLOR	UNIT WT (LBS)	CTN QTY	SKID QTY	PRICE EACH
3/4" SPIGOT					
765564LW	White	0.088	60	4320	6.22

## PLASTER GUARDS

### PLASTER GUARD

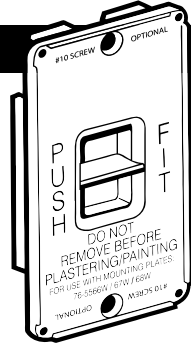

PART #	COLOR	UNIT WT (LBS)	CTN QTY	SKID QTY	PRICE EACH
765543BLK	White	0.040	100	7200	5.26

FITS MOST MOUNTING PLATES

## ROUGH-IN PLATES

### "VACULINE-STYLE" ROUGH-IN COVER PLATE

- WITH SCREWS

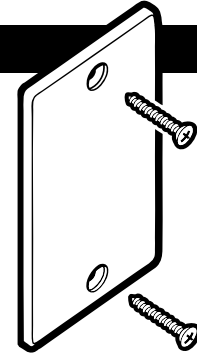

PART #	COLOR	UNIT WT (LBS)	CTN QTY	SKID QTY	PRICE EACH
765585W	White	0.079	120	17280	7.19
765585A	Almond	0.062	120	17280	5.75

### PLASTER GUARD

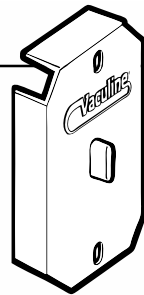

PART #	COLOR	UNIT WT (LBS)	CTN QTY	SKID QTY	PRICE EACH
765546W	White	0.035	75	5400	5.50

FITS MOST METAL MOUNTING PLATES 765560N

### PLASTER GUARD

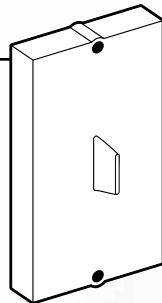

PART #	COLOUR	UNIT WT (LBS)	CTN QTY	SKID QTY	PRICE EACH
792012W	White	0.046	40	5400	3.83

PLASTER GUARD FOR SQUARE EDGE MOUNTING PLATE





**PREMIUM  
PIPE CUTTER  
& BLADES**

PART #	COLOR	UNIT WT (LBS)	CTN QTY	SKID QTY	PRICE EACH
794500	Cutter	0.728	1	-	556.89
794501	Blades 5 per pack	0.018	1	-	185.32

## PIPE

### 2" Central Vac Pipe



PART #	COLOR	UNIT WT (LBS)	CTN QTY	SKID QTY	PRICE EACH
<b>10 ft. Length - 10 Pieces (1 Bundle)</b>					
82950010	White	23.215	1	-	229.87
<b>4 ft. - 11 in. Length - 10 Pieces (1 Bundle)</b>					
829500411	White	12.214	1	-	114.55
<b>4 ft. - 11 in. Length - 20 Pieces (2 Bundles)</b>					
829500411BX	White	24.427	1	-	214.30
<b>8 Ft. Length - 10 Pieces (1 Bundle)</b>					
8295008	White	19.004	1	-	212.84



**Installation**



**Notes:**

---

---

---

---

---

---

---

---

---

---

---

---

---

---

---

---

---

---

---

---

---

---

---



## CENTRAL VACUUM VALVES, FITTINGS & ACCESSORIES

### CAUTION

Vaculine® does not recommend the use of thermoplastic piping systems for transport or storage of compressed air or other compressed gasses or the testing of such systems with compressed air or other ground locations.

Use of our plastic piping products in exposed compressed gas systems voids our warranty on the products used.

For further information, please contact your Vaculine® representative.

### WARRANTY

Seller's products are carefully inspected for manufacturing defects. However, it is not always possible to detect hidden defects. Said products are warranted only to the extent that the seller will replace, without charge, products proven to have manufacturing defects, within six (6) months of the date of delivery thereof and provided seller has been given an opportunity to inspect the product alleged to be defective and the installation of use thereof.

**NO WARRANTY** is included against any expense for removal, reinstallation or other consequential damages arising from any defect.

The warranties set out above are the only warranties made by the seller and are expressly in lieu of any other warranties, expressed or implied including the warranties of merchantability and fitness for a particular purpose.

Vaculine®, VacuSweep®, ES® Valve, ElectraValve®, CanSweep® and VacuValve® are registered trademarks of Canplas Industries Ltd.

## IAPMO RESEARCH & TESTING, INC.

5001 E. Philadelphia Street, Ontario, CA 91761-2816  
(909) 472-4100 • Fax (909) 472-4244 • www.iapmo.org

### LISTED PRODUCTS

**PRODUCT:** Central Vacuum Fittings

**APPLICANT:** CANPLAS INDUSTRIES  
31 PATTERSON ROAD  
BARRIE, ON L4M 4V3 CANADA FILE NO. M-4487



**IDENTIFICATION:** Tube shall be marked at least every 5 ft. in letters not less than 3/16 high in a contrasting color with the manufacturers name, ASTM F2158, nominal tube size and material identification. Fittings shall bear the manufacturer's name, ASTM F2158, nominal tube size and material identification. Markings shall be legible after installation. All listed products shall bear the Uniform Mechanical Code (UMC®).

**CHARACTERISTICS:** Residential central vacuum tube and fittings manufactured in compliance with ASTM F2158-01. To be installed in accordance with the manufacturer's installation instructions and the requirements of the latest edition of the Uniform Mechanical Code.

MODELS:	PART NO.	DESCRIPTION
	765501W	90° Tee S x S x S 2"
	765502W	Short Tee S x S x S 2"
	765506W	90° Short Elb S x S 2"
	765508W	90° Medium Sweep Elb S x S 2"
	765509W	90° Medium Sweep Elb Spg x S 2"
	765510W	90° Sweep Elb S x S 2"
	765511W	90° Sweep Elb Spg x S 2"
	765515W	3-Way 90° Elb S x S x S 2"
	765517W	45° Elb S x S 2"
	765518W	45° Elb Spg x S 2"
	765519W	30° Elb S x S 2"
	765525W	45° Wye S x S x S 2"
	765529W	Coupling S x S 2"
	765547W	Cap S 2"
	765527W	Spigot Coupling S x S 2"

Warranty

## INDEX

PART#	PG#
761455	15
762015	17
762016	17
762017	15
762023	14
762026	16
762027	17
762031	15
762032	13
762038	13
762040	14
762100	14
762145	14
765501W	12
765502SW	14
765502W	14
765503W	12
765504W	13
765506W	12
765507W	13
765508W	13
765509W	13
765510W	12
765511W	12
765515W	14
765517W	12
765518W	12
765519W	13
765525W	14
765527W	13
765528W	13
765529W	12
765530W	16
765531W	16
765532W	16
765535W	16
765537W	16
765540W	17
765541W	16
765542W	17
765543BLK	19
765544W	15
765545W	15
765546W	19
765547	15
765547W	15
765548W	15
765550W	14
765553W	15
765555W	14
765556W	15
765560N	18
765564LW	18
765565W	18
765568W	18

PART#	PG#
765569LW	18
765569W	18
765585A	19
765585W	19
765597	15
765597W	15
775583W	10
765601CL	11
765601W	11
765602W	11
765603W	11
765604W	11
775584-1	10
775584BLK	10
775584W	10
775586BLK	10
775586W	10
775588W	9
775589A	9
775589BLK	9
775589W	9
775590A	9
775590BLK	9
775590W	9
775591A	8
775591W	8
775592A	9
775592BLK	9
775592W	9
775850A	5
775850W	5
775850BLK	5
775851	5
775851-EBX	5
785506	12
785508	13
785510	12
785511	12
785517	12
785518	12
785527	13
785547	15
785597	15
791041W	18
791044W	18
791500ANL	9
791500WNL	9
791600A	9
791600W	9
791700A	9
791700W	9
791790A	7

PART#	PG#
791790W	7
792000A	9
792000W	9
792012W	19
792090A	7
792090W	7
792095A	7
792095W	7
793030W	17
794500	20
794501	20
82950010	20
829500411	20
829500411BX	20
8295008	20
845625A	4
845625BLK	4
845625W	4
845621A	4
845621BLK	4
845621W	4
845700-2	4
845700-3	4

  
**Central Vacuum**  
 Specification sheets  
 online at:



[vaculine.com](http://vaculine.com)



CENTRAL VACUUM VALVES, FITTINGS & ACCESSORIES



CONSISTENT QUALITY & SUPPLY  
FOR OVER 50 YEARS



**Toll Free Number:  
1-800-501-5018**

Visit us on the Web:  
[www.vaculine.com](http://www.vaculine.com)

**Canplas Industries Ltd.**  
**Head Office**  
500 Veterans Drive, P.O. Box 1800  
Barrie, Ontario  
Canada L4M 4V3  
Tel: 705-726-3002  
Toll Free: 1-800-501-5018  
Fax: 705-726-2186

Email: [vaculine@canplas.com](mailto:vaculine@canplas.com)