

## INSTALLATION INSTRUCTIONS FOR THE EAX-300 DOOR PROP / DOOR CHIME (EAX-300 / 300W / 300SK)

# EAX®

Dwg #: 105830



Table of Contents	Page
Parts breakdown view & part numbers.....	2
Hardware list, Device preparation.....	3
Switch selector positions, Door mounting procedure.....	4
Wall mounting procedure, Multi-door & SK procedure.....	4-5
Device installation (finish).....	5
Key Stop installation, Optional accessories.....	6
Special notes & definitions, Magnet handing & re-handing, operations.....	6-7
Change door prop timing.....	7-8
Operations continued, Troubleshooting.....	8

The Detex EAX-300 is designed for applications that require a door prop alarm device on secured doors. The alarm, with approximately 100dB, will sound when someone attempts to keep the door open beyond the selected time. The EAX-300, with its smaller size makes it the choice for quick and easy installations on emergency exit and restricted doors.

Should you have any Question/Problem with your Detex device please call Detex Technical Support from the job site at 1-800-729-3839 and choose option 2 on our menu. Please do not return the product to the distributor.

For **WARRANTY** information,  
scan code below or  
go to [www.detex.com/warranty](http://www.detex.com/warranty)





For device installation videos,  
scan code below or  
go to [www.detex.com/videos](http://www.detex.com/videos)

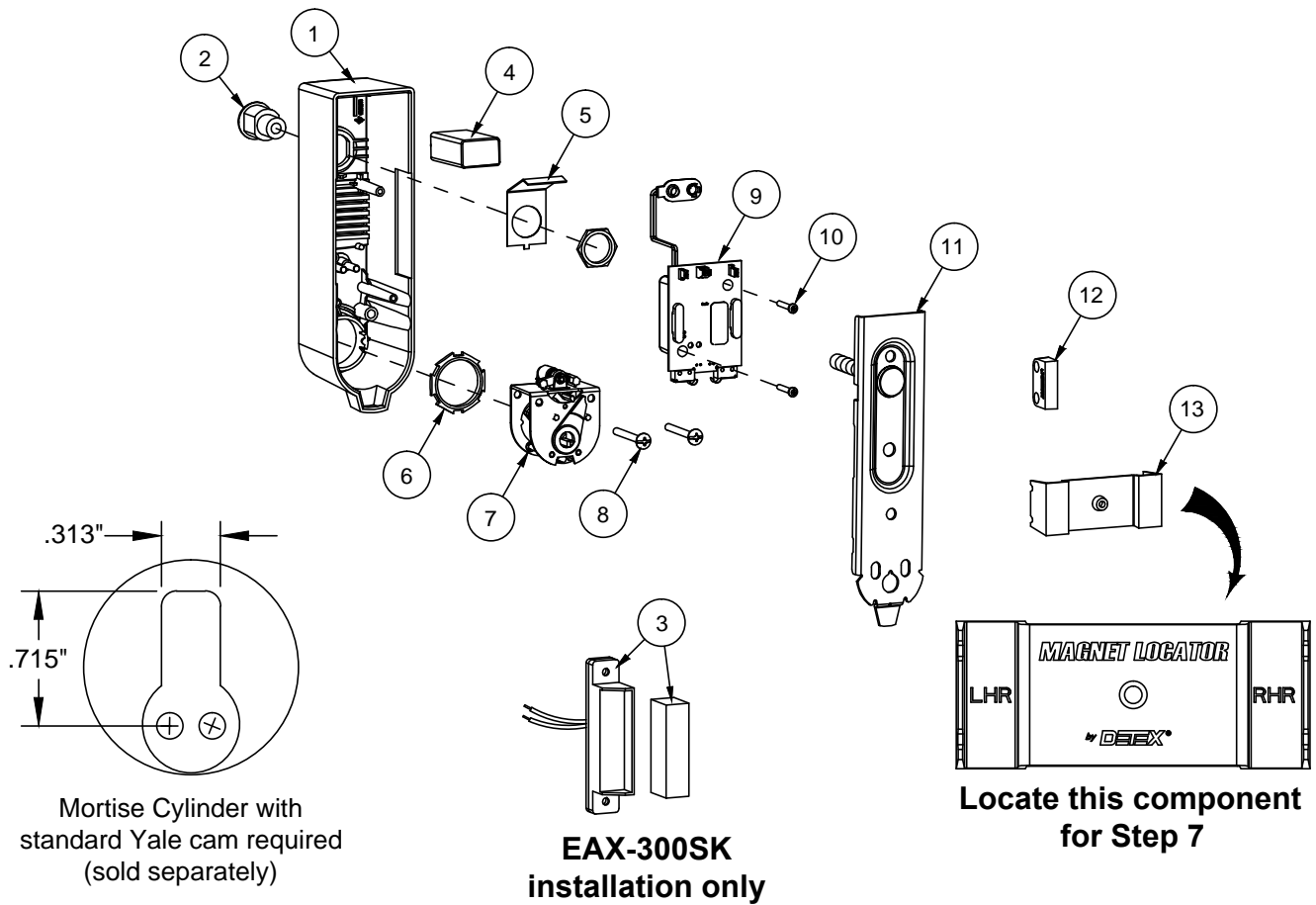

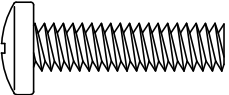
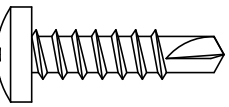

PARTS BREAKDOWN		
Item	Order Part #	Description
1	105428-1	Cover, gray
	105428-2	Cover, black
2	PP-5572	Cover Lock, Nut & 2 Keys
3	MS-1039S	Mag Switch (surface mount) (see STEP 8)
4	PP-5567	9 Volt Battery
5	102606	Battery Retainer
6	100783	Cylinder Nut
7	102655	Cam Assembly Kit
8	102627-15	8-32 Truss Head Screw
9	105828-1	S & R Circuit Board Kit, Standard
	105837-1	S & R Circuit Board Kit, Weatherized
10	PP-5374-46	#4 x 3/4" Screw, PPH
11	102715	Backplate
12	102665	Magnet Kit
13	102607	Magnet Locator
14	102633	Hardware Kit (includes keystone parts)(not shown)

Your particular part or configuration may not be shown:  
Contact Detex technical support at 800-729-3839 (option 2)

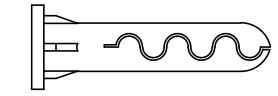
HARDWARE LIST		
SYMBOL	P/N & DESCRIPTION	DRILL SIZE
	P/N: PP-5183-29 #6 x 1-1/4" PPH, TYPE AB THREAD FORMING (SMS)	#35 (7/64")
	P/N: 100980 1/4-20 x 1" PPH MACHINE SCREW	#7 (.201")
	P/N: 103276-63 #14 x 1" PPH TYPE AB, SELF-DRILLING THREAD FORMING	7/32" or 3/16" (OPTIONAL)
	P/N: PP-5360-108 6-32 x 1/2" PPH TYPE C THREAD FORMING (ROLLING)	#32 (.116")
	P/N: 102642-3 1/4" x 1-3/16" ANCHOR	1/4"

### STEP 1: REMOVE COVER FROM BACK-PLATE

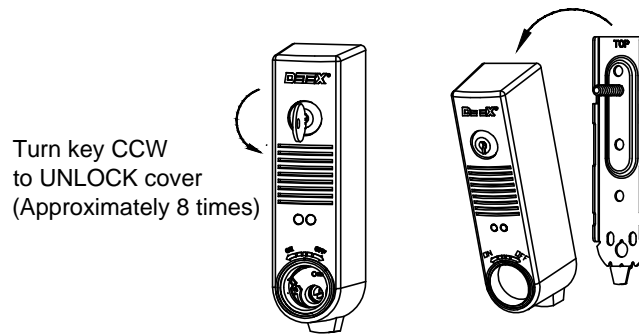

### STEPS 2-6: PREP DEVICE

(If Key Stop is required, see **OPTIONAL KEY STOP** page 6)

2: Remove cam assembly from cover

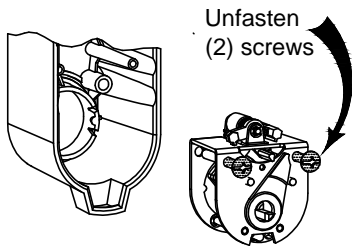

3: Install mortise cylinder (sold separately) with cylinder nut provided

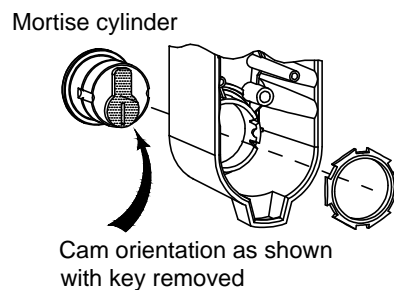

If 7-pin cylinder is used - **OBSERVE**

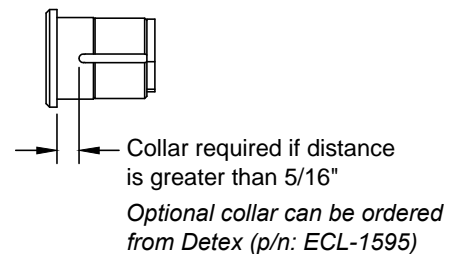

4: Re-install cam assembly

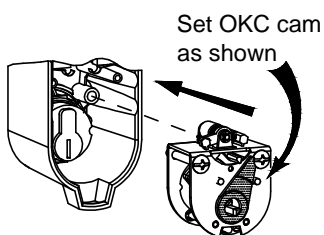

5: Set slide selector switch functions (See Table A on page 4)

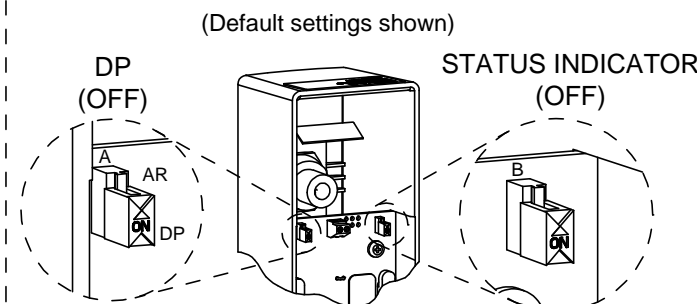

6: Connect 9-volt battery and install as shown

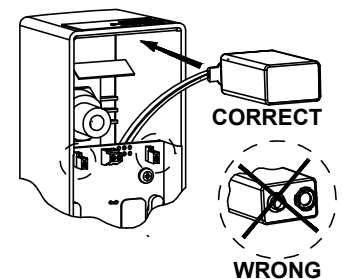
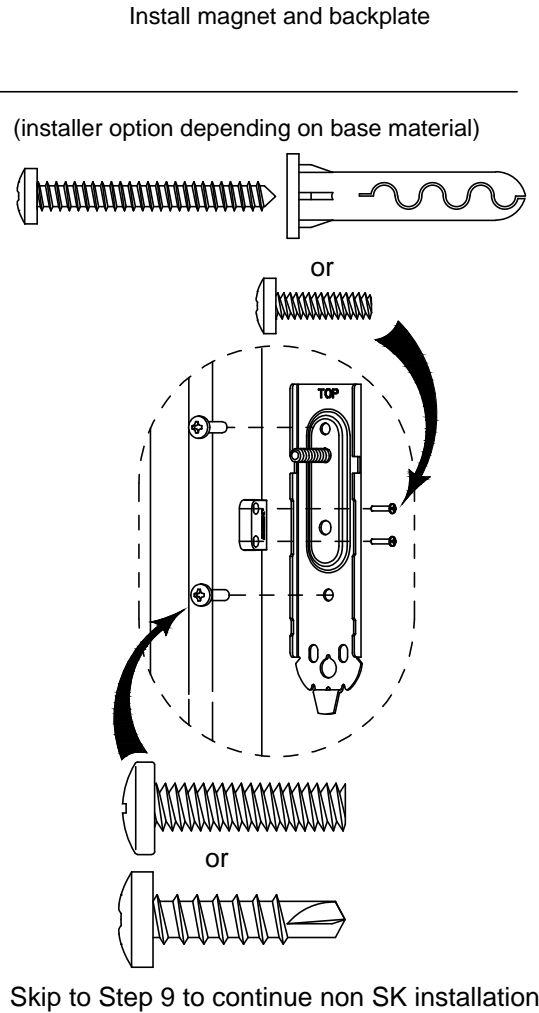
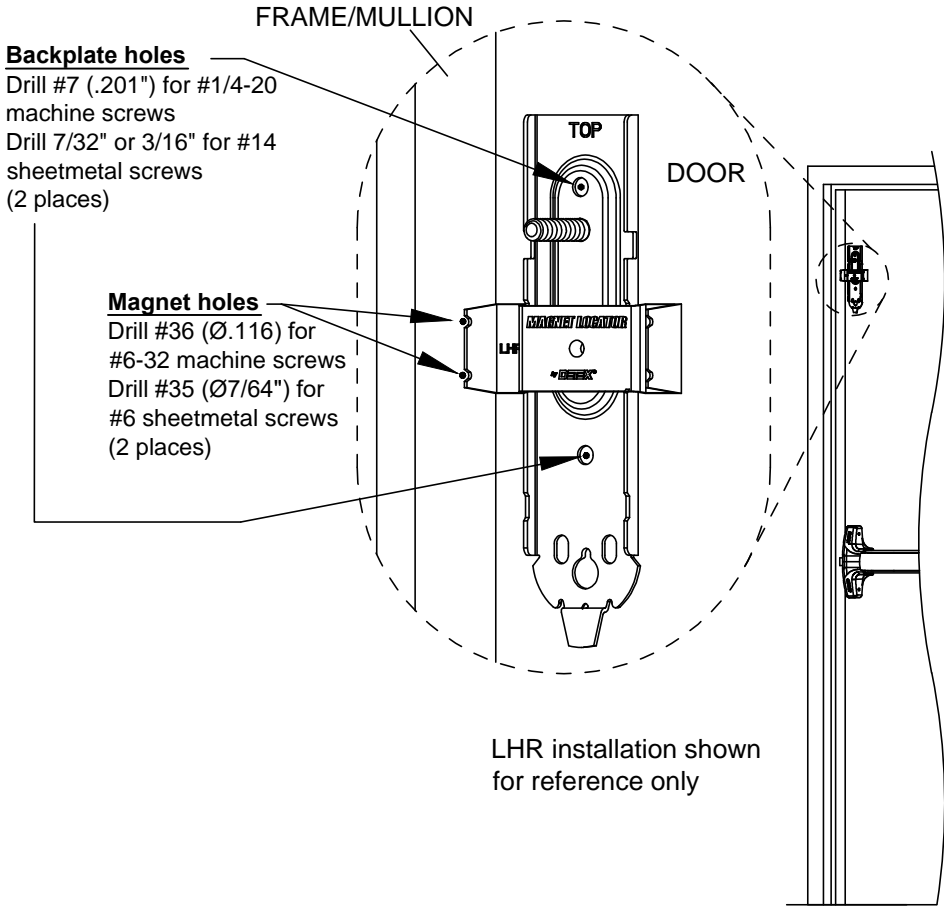

Table A: Selector Switch Functions ( *Default settings; **Will shorten battery life)		
STATUS INDICATOR (SWITCH B)	OFF*	No indication that device is armed or disarmed.
	ON	ARMED - red LED blinks approximately every 6 seconds.** DISARMED - green LED blinks approximately every 6 seconds.**
DP (SWITCH A)	OFF*	Door prop mode
	ON	Door chime mode

**STEP 7: For Door Mounting - Door Prep & Backplate / Magnet Mounting**  
(for Wall mounting (SK) go to step 7B)

Place Backplate and Magnet locator on door as shown below.  
Mark Backplate and Magnet holes on door and frame/mullion.  
Remove Backplate and Magnet locator **before** drilling holes.



**STEP 7B: For Wall Mounting (SK) - Backplate Mounting**

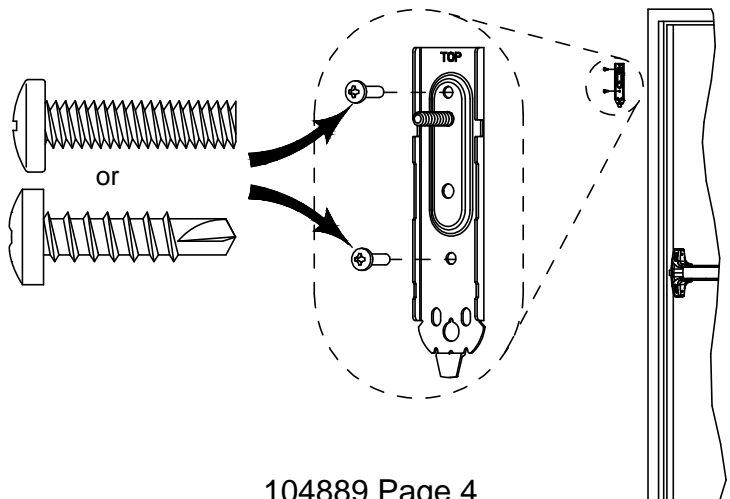

## STEP 8: NOT FOR USE ON EAX-300W

### Multi-door & SK function wiring connection (if required).

8a: Remove board

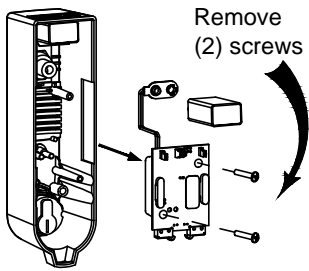

8b: Drill hole

Recommended hole size:  
Drill 7/8 dia, (1) place

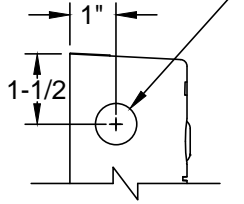

8c: Reassembly

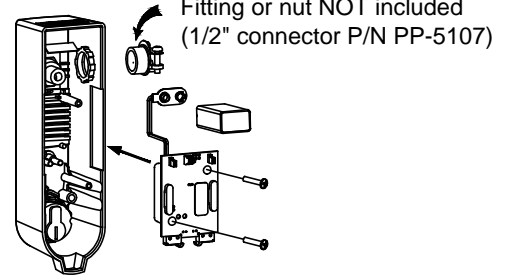

8d: SK Wire connections

Screw wires to (P1) terminal block  
(18ga Max wire dia) (not available on weatherized)

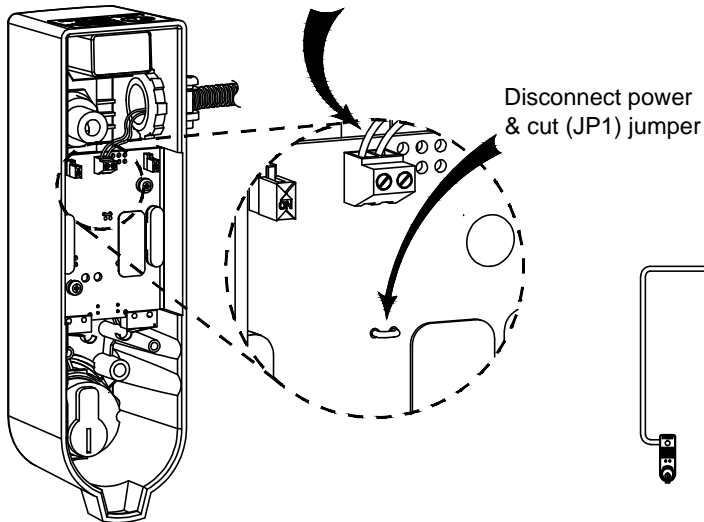
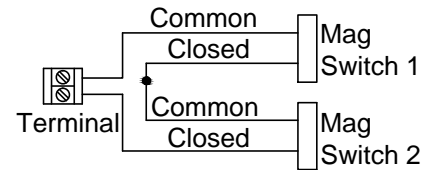

Diagram shown typical for two door magnetic switches:  
MS-1039S & MS-1059S wire in series.

MS-2049 (Red wire not used)

Weatherized not available for SK installations



Closed contact when  
door is closed

See instruction 103137 for magnetic  
switch mounting procedure

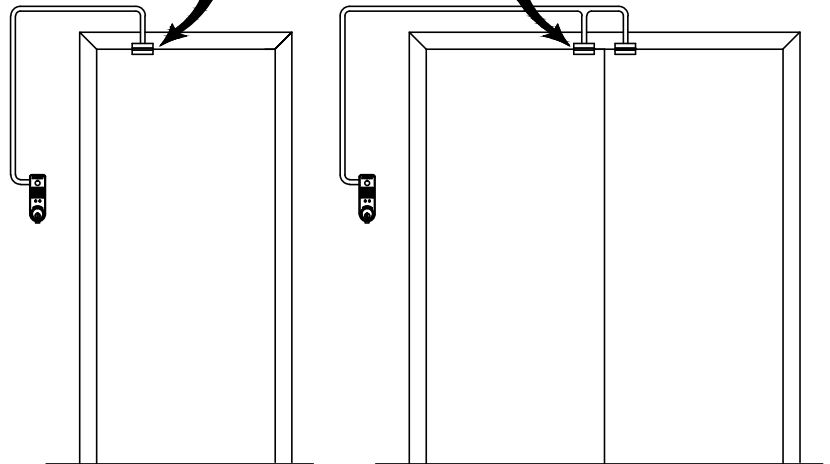

NOTES:

1. If wire runs longer than 10 feet, must use twisted pair.
2. 1/16" slotted jeweler screwdriver required.

## STEP 9: INSTALL DEVICE

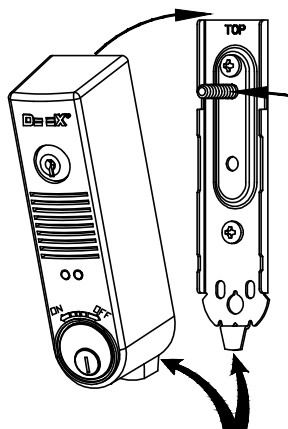

Hook at bottom, then tilt  
cover over backplate

Applying a small amount  
of lube to threads will aid  
when removing the cover  
in the future.

Turn key CW  
to lock cover

CAUTION:

Do not over tighten

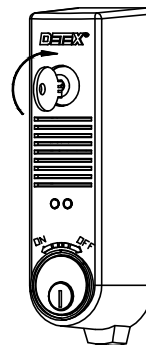

# OPTIONAL KEY STOP INSTALLATION

(Not required for normal operation)

(If required, key stop included in hardware kit)

Install key stop

Rotate key to this position before reinstalling cam assembly

P/N: 101976-1  
#4 x 3/8" PFH

**KS shown**  
p/n 105770-1

KS used with standard Yale style cam

**KS2 shown**  
p/n 105770-2

KS2 used with Adams Rite small style cam

**Front View**  
**(KEY STOP POSITIONS)**

"ON" position  
(Key can be removed)

Key and cams shown in 90° stop "ON" position

"OFF" position  
(Key cannot be removed)

Key and cams shown in "OFF" position

## Optional Accessories

Cylinder Nut Tool  
P/N: 103779

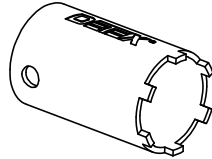

Inswing Door Kit  
P/N: 102644

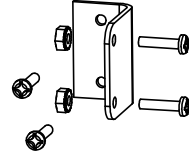

### SPECIAL NOTES and DEFINITIONS:

1. The door needs to be closed to test the unit.
2. When operating the ON/OFF switch, there is a slight delay.
3. The key is inserted and removed only in the vertical position (home position).
4. Key function: counter clockwise (CCW) = Armed; clockwise (CW) = Disarmed.
5. The door prop function is selectable by setting SWITCH A to the OFF position.  
For door chime function, set SWITCH A to the ON position.

**MAGNET HANDING / RE-HANDING PROCEDURE:** Magnet handing is where the device determines if the left, right or an external reed switch will be used to indicate if the door is opened or closed. When the battery is initially installed, the device simultaneously flashes the LEDs and chirps the siren a total of five times indicating the memory is cleared.

This indicates that the device is in the magnet handing process but not yet selected:

Step 1: Turn the key CW to the 'OFF' position.

Step 2: If re-handing is necessary, remove the unit from the door and momentarily short the REHANDING (or *Test*) jumper contacts. The device simultaneously flashes the LEDs and chirps the siren a total of five times.

Step 3: With the door open, install the device on the door.

Step 4: Turn the key CCW to the 'ON' position. The red LED blinks twice.

Step 5: Close the door or bring the external magnet into position with the external door switch.

The siren chirps and the LED flashes on the selected side of the device (red LED flashes for the left side or external; green LED flashes for right side).

The device will now operate normally, and the selected reed switch side is stored in memory so changing the battery does not require re-handing.

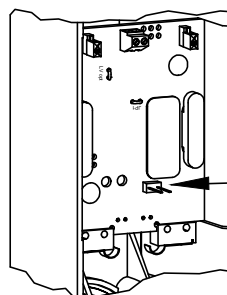

REHANDING  
(or *Test*) jumper  
contacts.

Key orientation  
*without* Key Stop  
installed



"ON" position



"OFF" position

Key orientation  
*with* Key Stop  
installed



"ON" position



"OFF" position

**DOOR PROP OPERATIONS:** The door prop function is selected by setting SWITCH A to the 'OFF' position. To arm the system, close the door and turn the key CCW to the 'ON' position. The red LED will flash twice indicating that the device is now armed. If the door is opened, the device will begin a timing countdown according to the selected amount of time (15 seconds default). If the *Status Indicator* (switch B) is 'ON', the red LED will blink every second during the countdown. If the door is not closed before the door prop time runs out, the alarm sounds and the red LED flashes. Closing the door will silence the alarm and rearm the unit. To change the door prop timing, see the section **Changing Door Prop Timing**.

**DOOR CHIME OPERATIONS:** The door chime function is selected by setting SWITCH A to the 'ON' position. To arm the system, close the door and turn the key CCW to the 'ON' position. The red LED will flash twice indicating that the device is now armed. If the door is opened, the device sounds a series of siren chirps lasting five seconds. No other action is taken until the door is closed and the unit rearms.

**DISARMING:** To turn off the alarm or disarm the system, turn the key CW to the 2 o'clock position.

**TROUBLESHOOTING:** If the unit does not arm, the magnet may need to be re-aligned or shimmed closer to the EAX-300. If the unit fails to operate correctly, restart the device by removing the battery for approximately five seconds.

**LOW BATTERY ALERT:** Simultaneous siren chirps and red LED flashes occur at 45 second intervals when battery reaches approximately 7 volts. Cut the *LV Opt* jumper if low battery alert is not desired.

**STATUS INDICATOR:** With the Status indicator (SWITCH B) 'ON': red LED flashes every six seconds when armed; green LED flashes every six seconds when disarmed.

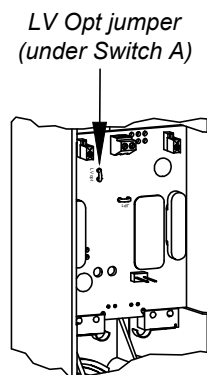

**CHANGING DOOR PROP TIMING:** Note: \*Device must be magnet handed. \*LED indications will flash a total of 3 times before the timing is changed.

Step 1: Turn the key CW to the 'OFF' position, remove the unit from the door and disconnect the battery.

Step 2: Turn the key CCW to the 'ON' position.

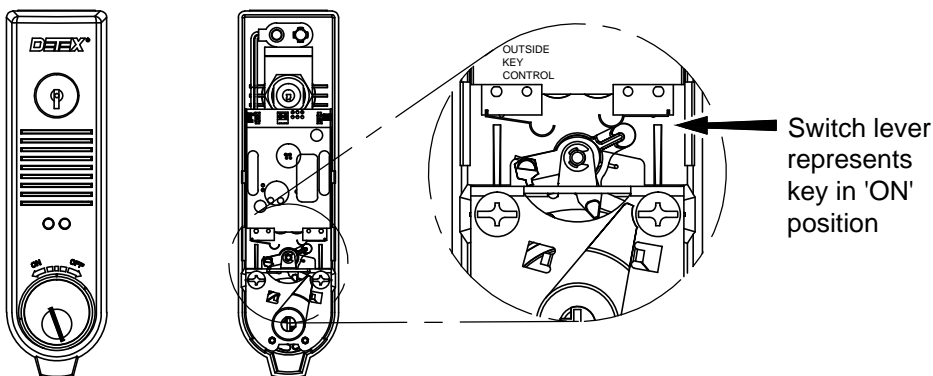

Step 3: While holding the OKC lever in the closed position (by rotating lever to the left stop), reconnect the battery. The device will chirp the siren once and the LEDs will flash the currently selected door prop time (See Table B). Release the OKC switch lever and turn the key to the 'OFF' position.

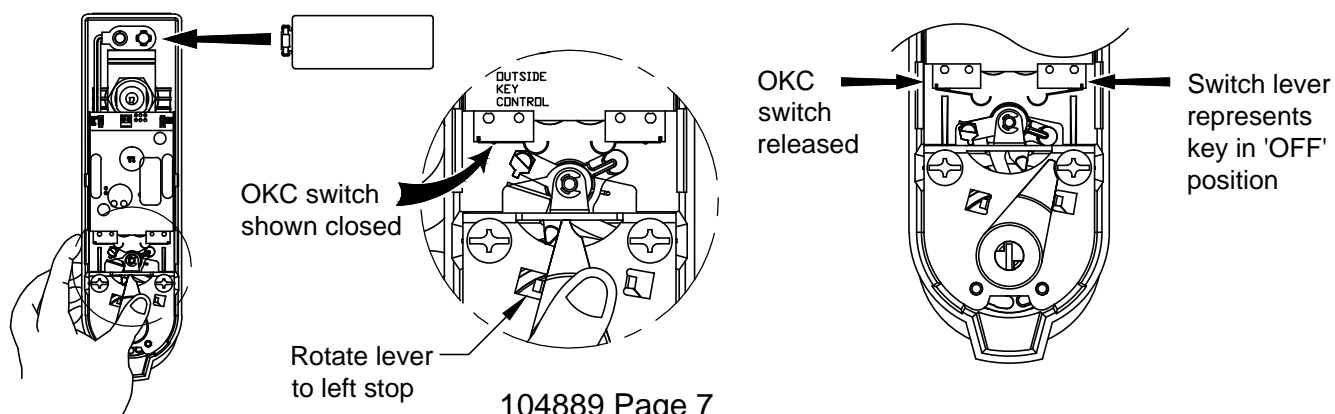

**Step 4:** Close then release the OKC switch lever to cycle to the next highest door prop time. Table B lists the available door prop times and their corresponding LED indications. For example, to indicate the default 15 second door prop time, the red LED would flash once, followed by 5 green LED flashes. To indicate 2 minutes, the red and green LEDs would flash simultaneously two times. Once the desired timing is selected, wait approximately 15 seconds for the unit to flash the selection three times. The timing has successfully been changed upon hearing the siren chirp four times. This new timing selection is retained in memory even with battery removal.

Table B	
Door Prop Timer	LED indication
1 second	1 GREEN flash
15 seconds (Default)	1 RED flash - 5 GREEN flashes
30 seconds	3 RED flashes
45 seconds	4 RED flashes - 5 GREEN flashes
1 minute	1 RED & GREEN simultaneous flash
2 minutes	2 RED & GREEN simultaneous flashes
4 minutes	4 RED & GREEN simultaneous flashes

**Step 5:** Reinstall the device on the door.

### TROUBLESHOOTING

PROBLEM	PROBABLE CAUSE	ACTION
Device is not powering up.	1) Battery not properly installed.	1) Remove battery and firmly reinstall.
Device not arming.	1) Magnet not aligned correctly. 2) Battery is dead. 3) Cylinder had wrong cam installed. 4) Cylinder microswitch lever broken. 5) Cylinder installed incorrectly.	1) Use magnet locator to install magnet. See magnet handing. 2) Replace battery. 3) Requires standard Yale cam. 4) Microswitch needs to be replaced. Remove PCB and return to Detex Repair. 5) Check cylinder installation. Make sure key is turned counter-clockwise all the way to ON.
Chirp every 45 seconds	Low battery	Install new battery.
External magnet not working.	Device is not set for external magnet.	Cut JP1 jumper. With battery connected, short "Test mode" pins, listen for 5 chirps. See RE-HANDING section.
No connector for external magnet.	Weatherized device.	Weatherized device can not be used with external contact.

### DOOR PROP

PROBLEM	PROBABLE CAUSE	ACTION
After arming and door is opened, the device chirps 4 times then shuts off.	The device is setup as Door Chime.	Reset device, slide Switch A to the <b>OFF</b> position.

### DOOR CHIME

PROBLEM	PROBABLE CAUSE	ACTION
After arming and door is opened, the device blinks red.	The device is setup as Door Prop	Reset device, slide Switch A to the <b>ON</b> position.