



# Sonic Star eFinity Series

*Acoustically Transparent Ambient Light  
Rejecting EDGE FREE® Fixed Frame Screen*

**For Standard Throw Projectors**

## **USER'S GUIDE E Type - V1**

---

**Product Description:** The **Sonic Star eFinity Series** is a fixed frame projection screen that uses EPV Screens' EDGE FREE® technology. The EDGE FREE® design resembles a giant size flat panel TV display. The **eFinity** includes a bezel trim to further enhance the frame appearance and absorb projector overshoot.

The ISF Certified **Sonic Star** is an ambient light rejecting front projection screen material that is perforated for acoustic transparency **and is compatible only with Standard Throw Projectors**. It is precisely formulated for environments with minimal control over room lighting to enhance picture brightness, offer accurate color fidelity, improve contrast and allow sound to pass through.

### **Maintenance and Care**

In order for the **Sonic Star** material to maintain its projection qualities and provide optimum performance please refer to the list below for proper maintenance and cleaning.

***The following precautions should always be followed to avoid damaging the material, which is not covered under warranty.***

- Use a dry microfiber cloth or a soft bristle brush to remove dust from the screen's surface.
- When cleaning, use a damp microfiber cloth with warm water to remove any marks.
- Never rub or apply pressure when cleaning the surface.
- Never attempt to use any chemicals such as acetone, benzene, alcohol, organic solvents or abrasive cleaners to clean the screen surface.
- To avoid damaging the screen, avoid touching it directly with your fingers, pens/pencils or any other sharp or abrasive objects.
- DO NOT touch the projection surface with your hands to avoid leaving oily fingerprints, which are not removable.

## Exploded View of eFinity Frame

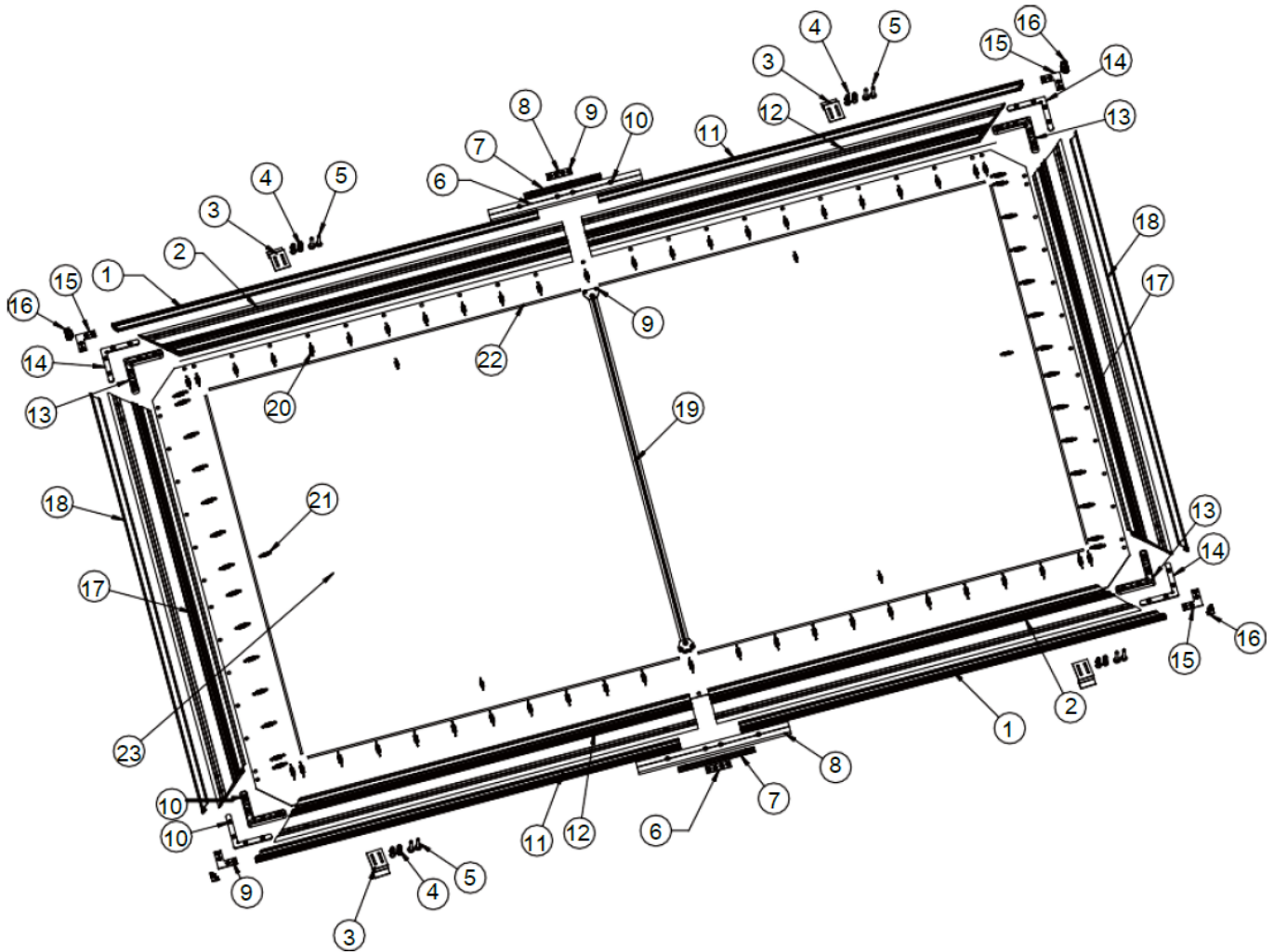

Make sure all parts are included before commencing frame assembly.

### Hardware and Parts List

① Edge Trim A	⑦ Long Center Joints b	⑬ Elbow Joints a	⑲ Support bar
② Frame A	⑧ Short Center Joints	⑭ Elbow Joints b	⑳ Spring a
③ Wall Bracket	⑨ M4x4 Screws	⑮ Elbow Joints C	㉑ Spring b
④ Anchor	⑩ M5x6 Screws	⑯ Corner Cover	㉒ Fiberglass rod
⑤ Wood Screws	⑪ Edge Trim B	⑰ Frame C	㉓ Screen material
⑥ Long Center Joints a	⑫ Frame B	⑱ Edge Trim C	

## SCREEN INSTALLATION

### 1. Frame Assembly

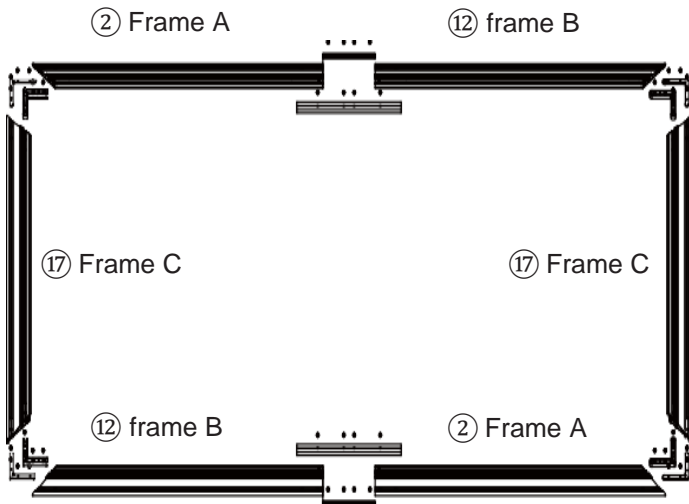

Step 1: Insert the long center joints (a) into each half horizontal frame (A/B) and secure with the screws. These will be the top/bottom frames.

Step 2: Insert the elbow joints into frame (C) and insert the other end of the elbow joints to the top/bottom frames and secure with the screws.

1. ⑩ M5x6 Screws   ⑥ Long Center Joints a

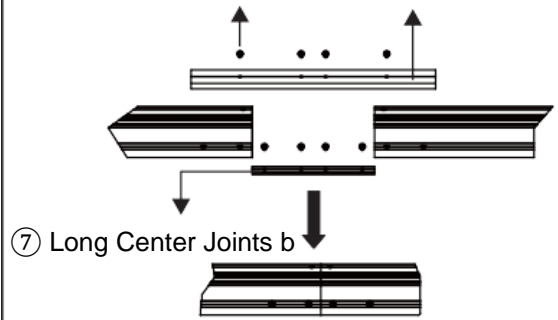

Center Connection

2. ⑭ Elbow Joints b

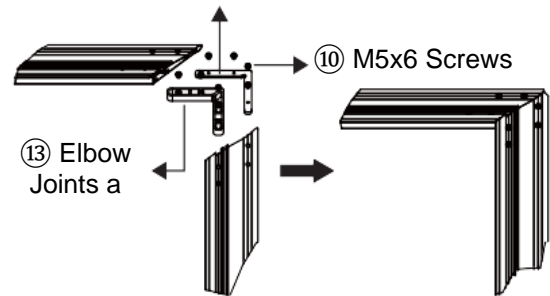

Corner connection

### 2. Center Support Bar Installation

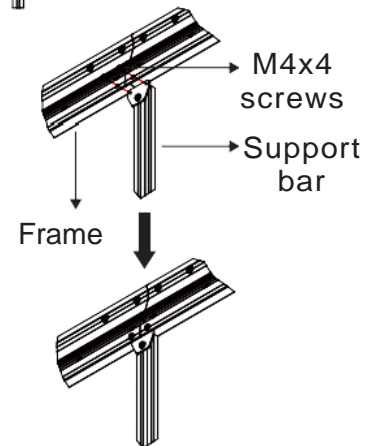
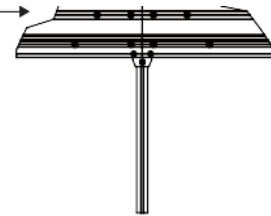
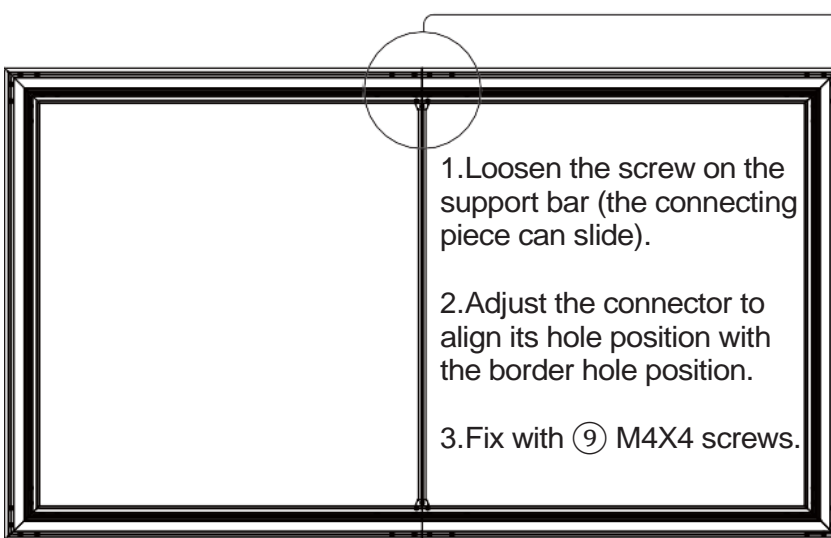

**Note:** the support bar is mounted in the upper and lower border splicing direction as shown on the right

### 3. Black Backing Cloth Installation

Black backing dimensions		
Screen size	Height	Width
110"	52.9"/1345 mm	94.8"/2410 mm
125"	60.3"/1532 mm	107.9"/2742 mm
135"	65.2"/1656 mm	116.7"/2964 mm
150"	72.5"/1843 mm	129.7"/3296 mm

1. Lay the frame front face up on a flat surface.

**Note: Velcro installed on edge of frame.**

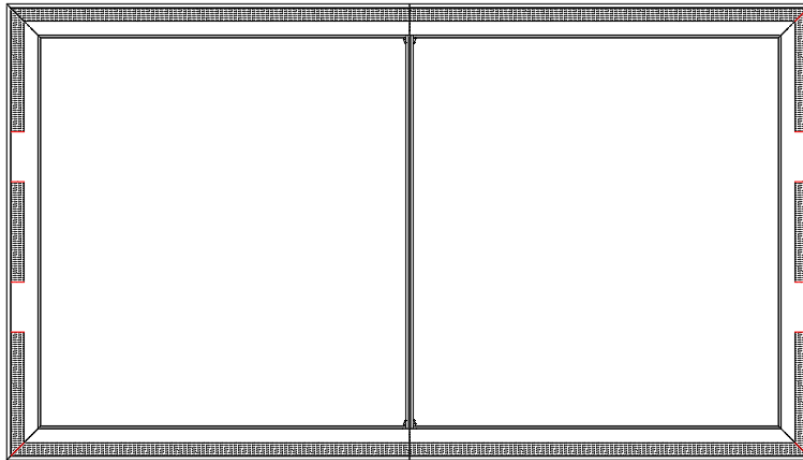

2. Begin attaching the black backing on the four corners to the velcro on the frame and press firmly to make it more compact. Lift and remove to smooth out and avoid wrinkles.

**Note: Assure the four edges of the black backing cloth do not go beyond the space of the velcro.**

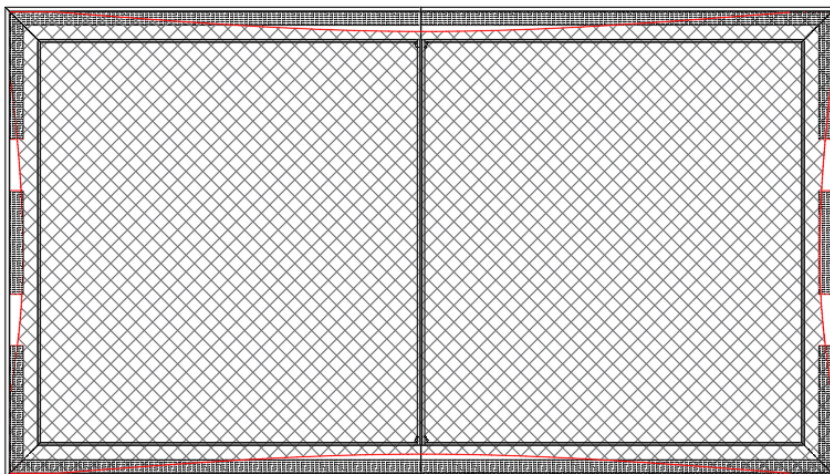

3. Re-attach black backing cloth from center to corner and pull the black backing cloth to fit the velcro to make it more compact again. Then finish to attaching the black backing to the velcro.

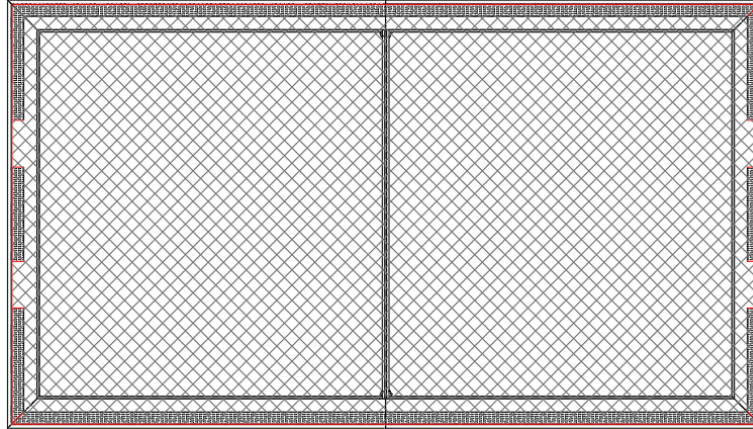

#### 4. Screen Material Installation

**ATTENTION:** Put the gloves on when handling the screen material to avoid touching it with your bare hands.

##### Unrolling the screen material

##### Two people recommended

1. Put on the supplied pair of white gloves.  
***This is to avoid leaving oily handprints on the screen surface which are not removable.***
2. Remove the screen material from the tube and place a small suitable weighted object at the end of the material.
3. Lay the material face down, two people carefully lift the rolled end and slowly rotate the material clockwise.

(Figure 1)

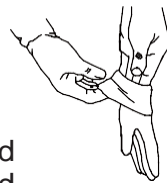

Back side of screen material

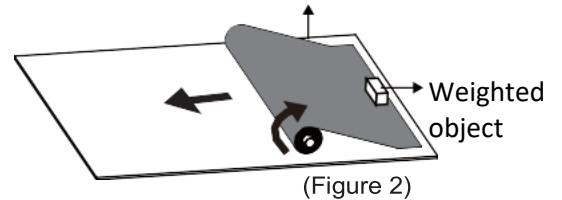

(Figure 2)

Front side of screen      Back side of screen

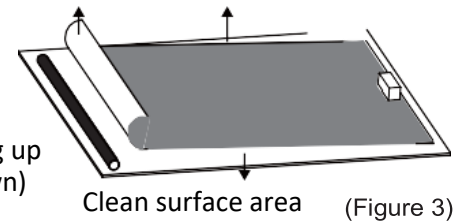

Note: Backside facing up  
(frontside facing down)

(Figure 3)

4. Insert the corresponding fiberglass rods through the sleeves on the edges of the material as shown below.

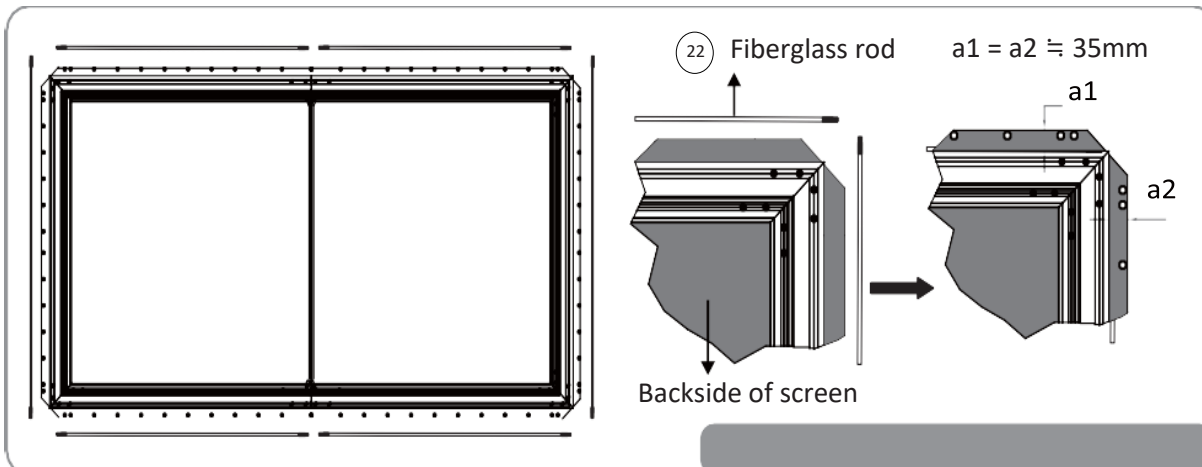

1. Carefully and gently place the assembled frame on top of the screen material.  
**DO NOT** allow the angle edge of the frame to come in direct contact with the material to avoid puncturing it.

2. Adjust the distance between the edge of the frame and the material ( $a1 = a2$ ) to 1.4"/35 mm

3. Begin by simultaneously attaching three springs in the center of the side frames (C→D) and repeat for top/bottom frames (A→B).

4. Then, simultaneously attach the springs from the center to all corners. (Leaving only the four corners.)

5. Finally, attach the springs at the four corners (E→F→G→H).

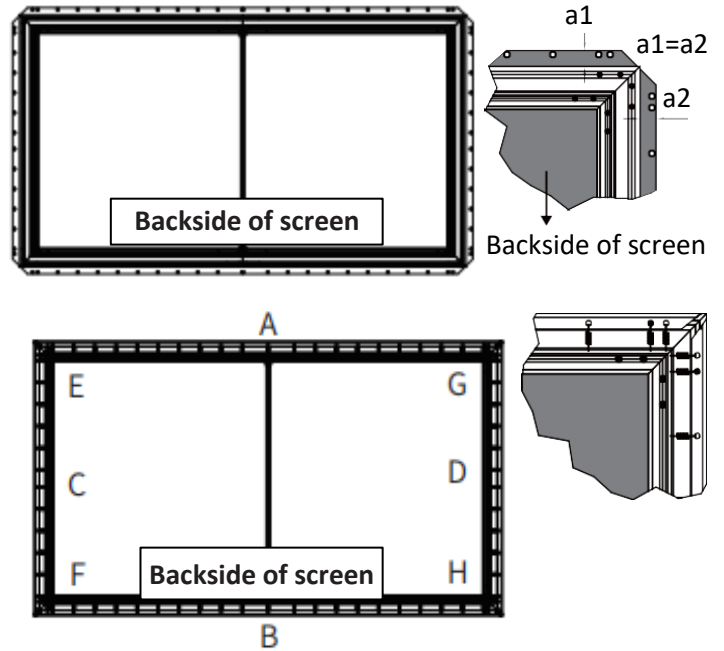

### Spring Attachment Method

First hook one end of the spring in the frame slot, then hold the screen around the frame to pull, and finally use the spring hook to pull the spring hook in the screen hole.

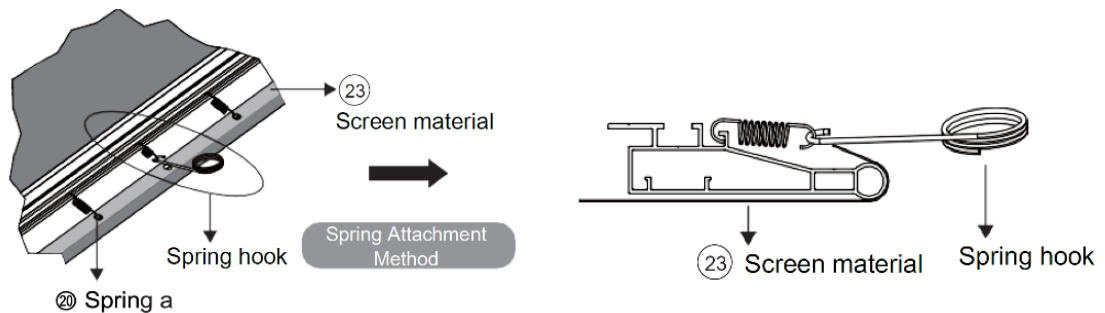

### 5. Bezel Trim Frame Assembly/Installation

1. Connect **Edge Trims A&B** to form the top/bottom trims with the **(8) Short Center Joints**, and then insert them on the top/bottom frames.
2. Connect the **side edge trims C** with the top/bottom edge trim with **(15) Elbow Joints C**.
3. Adjust the trim so that the top and bottom trim pieces are touching and show no gaps on the corners. Then fasten them with the **(9) M4 x 4 screws**.

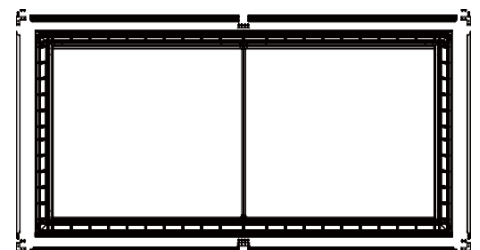
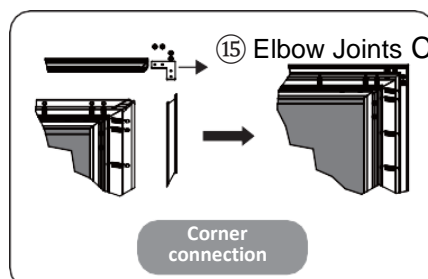
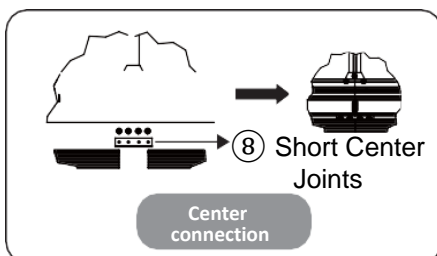

4. Attach a **2** **spring b** in the middle of each edge trim (1-6) to the frame as shown in the illustration.
5. Install the **16** **corner covers** on the four corners of the edge trim.

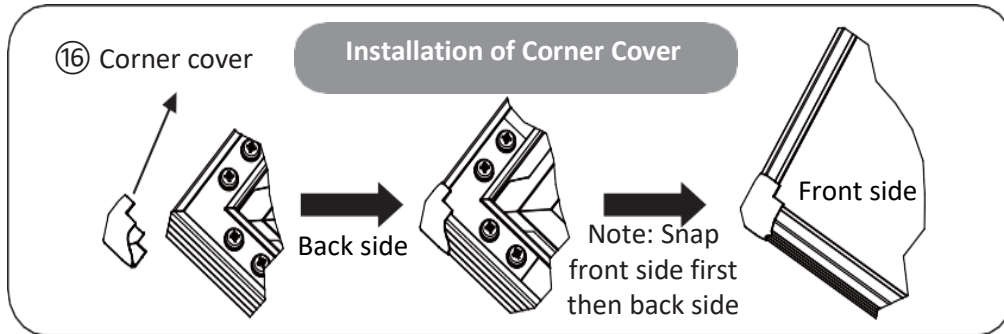
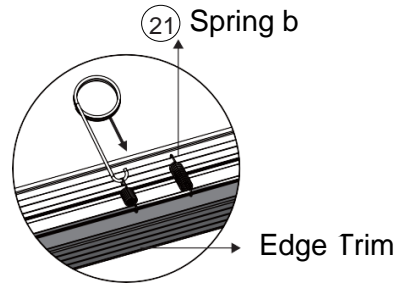
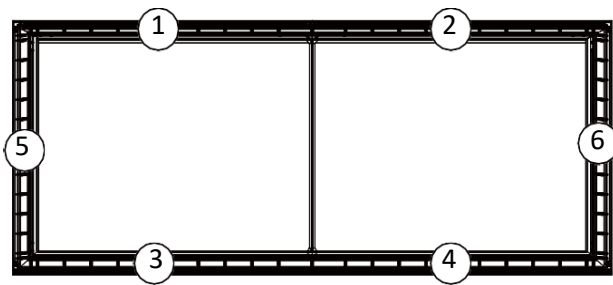

## 6. Product Dimensions

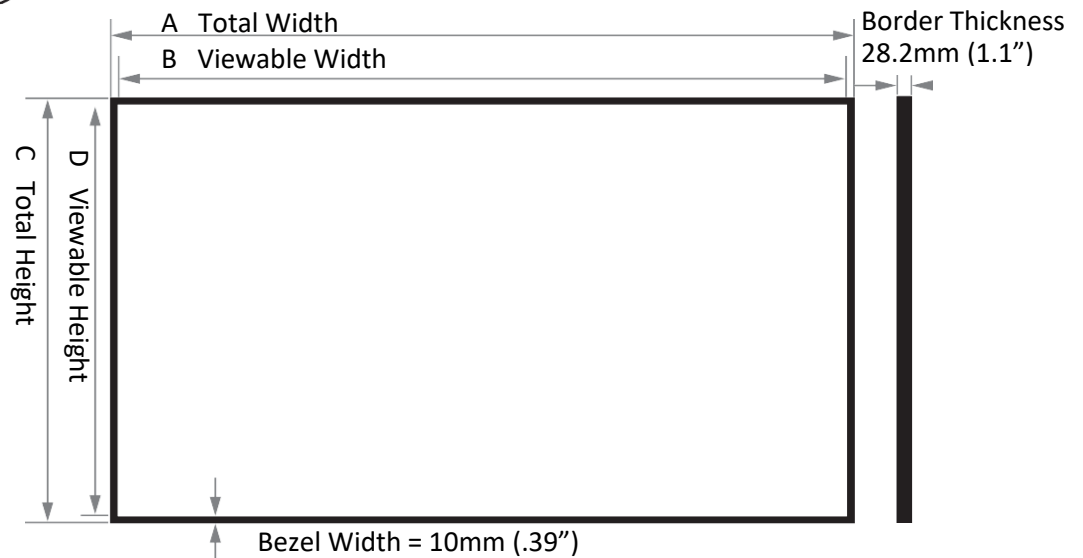

**Note: The listed measurements are for general reference only.**

Screen size	A	B	C	D
<b>110"</b>	96.7" / 2456 mm	95.9" / 2436 mm	54.7" / 1391 mm	53.9" / 1371 mm
<b>125"</b>	109.7" / 2788 mm	108.9" / 2768 mm	62.1" / 1578 mm	61.3" / 1558 mm
<b>135"</b>	118.5" / 3010 mm	117.7" / 2990 mm	67" / 1702 mm	66.2" / 1682 mm
<b>150"</b>	131.5" / 3342 mm	130.7" / 3322 mm	74.3" / 1889 mm	73.5" / 1869 mm

\*Tolerance may be  $\pm 1$ "

## 7. Wall installation

Drill a hole on the wall according to the distance on the chart below distance for your screen. Place the bracket on the holes and secure them using a Phillips screwdriver. If not installing into a structural wood stud, use a wall anchor, then screw in the M5x50 screws. Make sure the brackets are leveled.

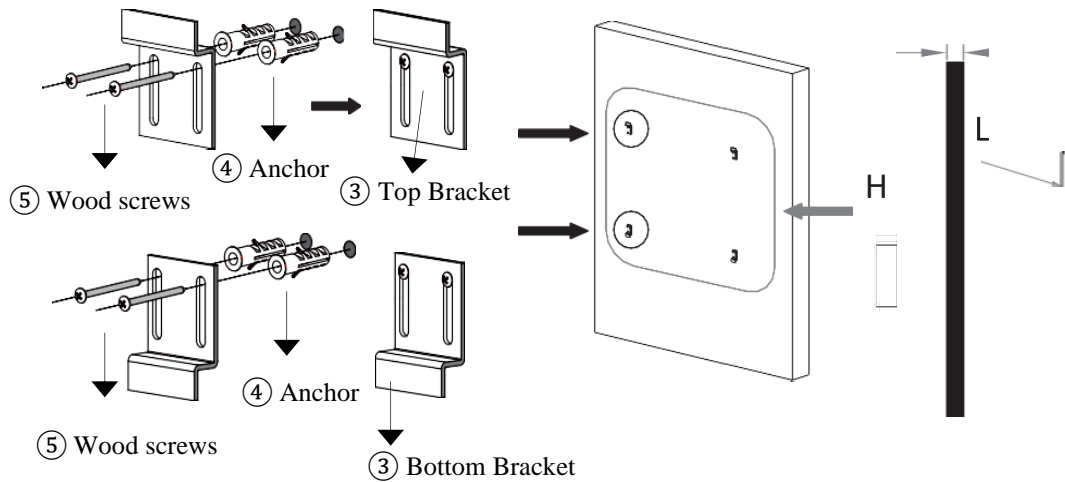

### Hanging the screen:

1. Two people hold the screen and align it first with the bottom bracket. The bracket lip must be inserted in the frame's channel per example below.
2. Then pull up the screen on the top bracket and adjust the screen left to right as needed.

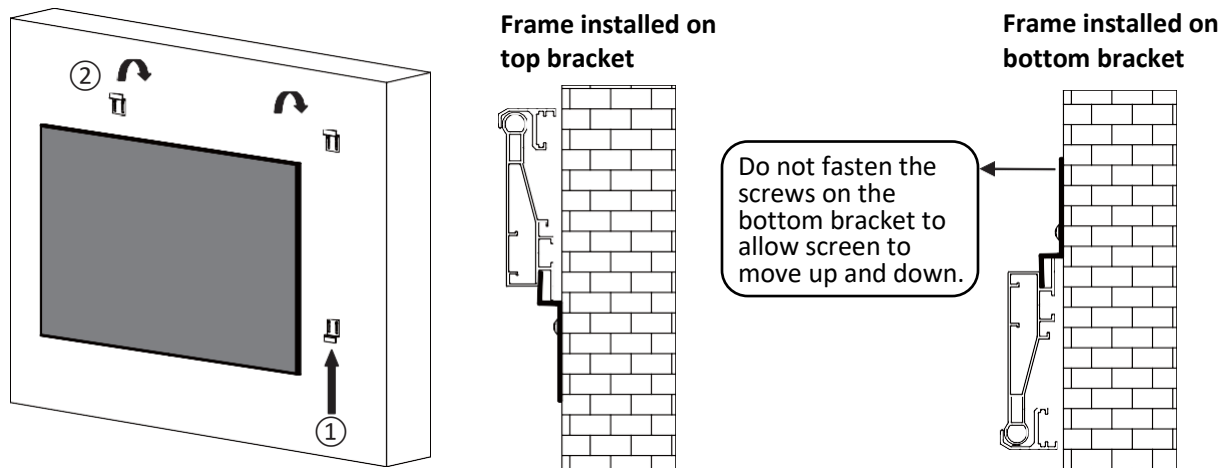

Screen size	110"	125"	135"	150"
L = Left/Right hole distance	59" / 1500 mm	78.7" / 2000 mm	78.7" / 2000 mm	98.4" / 2500 mm
H = Top/Bottom hole distance	47.5" / 1209 mm	54.9" / 1395 mm	59.8" / 1519 mm	67.1" / 1706 mm

**For an EPV Screens contact and technical support in your area, please visit [www.epvscreens.com](http://www.epvscreens.com)**