

SANUS™

S Y S T E M S

WMS3 & WMS5

(6901-300150 <05>)

- EN** Thank you for choosing the Sanus Systems WMS wall mount. The Sanus Systems WMS wall mount is designed to support speakers weighing up to 3.62 kg (8 lbs.).



CAUTION

This product is designed for use in wood stud and concrete block applications only! The wall or ceiling must be capable of supporting up to five times the weight of the speaker and mount combined. If you have any doubts about the ability of the surface to support the monitor, contact Sanus Systems Customer Service, or a qualified contractor.

- ES** Gracias por elegir el soporte para pared WMS de Sanus Systems. El soporte para pared WMS de Sanus Systems está diseñado para sostener parlantes con un peso de hasta 3,62 kg (8 lb).



ADVERTENCIA

Este producto está diseñado para que se use únicamente en aplicaciones con pernos de madera y bloques de concreto. La pared o el cielo raso deben ser capaces de soportar hasta cinco veces el peso del altavoz y del montaje juntos. Si tiene dudas sobre la capacidad de la superficie para soportar el monitor, póngase en contacto con el Servicio de Atención al Cliente de Sanus Systems o con un contratista calificado.

- FR** Nous vous remercions d'avoir choisi un montant mural WMS de Sanus Systems. Le montant mural WMS de Sanus Systems a été conçu pour supporter des haut-parleurs pesant jusqu'à 3,62 kg (8lb).



ATTENTION

Ce produit est conçu pour être installé seulement sur des montants en bois ou des blocs de béton! Le mur ou le plafond doit pouvoir supporter cinq fois le poids total du haut-parleur et du support combiné. Si vous avez des doutes quant à la capacité de la surface à supporter le moniteur, contactez le service à la clientèle de Sanus Systems ou un entrepreneur qualifié.

Sanus Systems 2221 Hwy 36 West, Saint Paul, MN 55113 USA • sanus.com

Americas: 800-359-5520 • 651-484-7988 • info@sanus.com

Europe, Middle East, and Africa: + 31 40 2324700 • europe.sanus@milestone.com

©2010 Milestone AV Technologies, a Duchossois Group Company. All rights reserved. Sanus is a division of Milestone.

All other brand names or marks are used for identification purposes and are trademarks of their respective owners.



WARNING

This product contains small items that could be a choking hazard if swallowed. Keep these items away from young children!



CAUTION

Do not use this product for any purpose not explicitly specified by Sanus Systems. Improper installation or use may cause personal injury and/or property damage. If you do not understand these instructions, or if you have doubts about the safety of the installation, contact Sanus Systems Customer Service. Sanus Systems is not liable for injury or damage caused by incorrect installation or use.



Hardware and procedures for multiple mounting configurations are included. When you see this symbol, choose the correct configuration to suit your needs. Not all hardware included will be used.



ADVERTENCIA

Este producto contiene piezas pequeñas que, si se tragan, podrían causar asfixia. Mantenga el producto fuera del alcance de los niños pequeños.



ADVERTENCIA

No utilice este producto para fines no especificados explícitamente por Sanus Systems. La instalación o el uso incorrectos podrían ocasionar daños materiales o lesiones graves. Si no entiende estas instrucciones o si tiene alguna duda con respecto a la seguridad de la instalación, comuníquese con el servicio de atención al cliente de Sanus Systems. Sanus Systems no será responsable por daños ni lesiones debidos a la instalación o al uso incorrectos.



Se suministran la tornillería y los procedimientos para múltiples configuraciones de instalación. Cuando vea este símbolo, elija la configuración correcta de acuerdo a sus necesidades. No se utiliza toda la tornillería incluida en la instalación.



ADVERTISSEMENT

Ce produit contient des petits objets qui peuvent représenter un danger d'étouffement si avalé. Garder ces petits objets hors de la portée des jeunes enfants!



ATTENTION

Ne pas utiliser ce produit à des fins autres que celles expressément spécifiées par Sanus Systems. Une installation ou une utilisation incorrecte peut entraîner des blessures personnelles ou des dommages à votre propriété. Si vous ne pouvez comprendre ces instructions ou si vous avez des doutes concernant la sécurité de l'installation, communiquez avec le Service à la clientèle de Sanus Systems. Sanus Systems n'est pas responsable des blessures et des dommages causés par une mauvaise installation ou utilisation du produit.



La visserie et les procédures de montage pour plusieurs configurations sont comprises. Lorsque vous voyez ce symbole, choisissez la configuration qui convient le mieux à vos besoins. La visserie incluse ne sera pas toute utilisée.

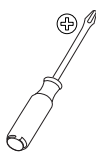
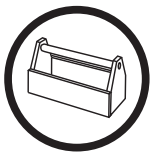

1/8 in.



1/4 in.

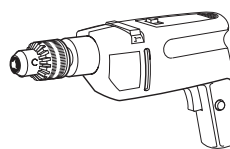

EN Supplied Parts and Hardware

Before starting assembly, verify all parts are included and undamaged. If any parts are missing or damaged, do not return the item to your dealer; contact Sanus Systems Customer Service. Never use damaged parts!

ES Piezas y tornillería suministradas

Antes de comenzar con el armado, verifique que no haya piezas faltantes ni dañadas. En caso de que las haya, no devuelva el producto a su distribuidor; comuníquese con el servicio de atención al cliente de Sanus Systems. Nunca use piezas dañadas.

FR Pièces et visserie fournies

Avant de commencer l'assemblage, vérifiez que toutes les pièces sont incluses et intactes. Si des pièces sont manquantes ou endommagées, ne retournez pas ces pièces au magasin. Veuillez communiquer avec le Service à la clientèle de Sanus Systems N'utilisez jamais de pièces endommagées!

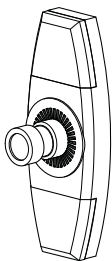

WMS3 [01] x 4
WMS5 [01] x 10

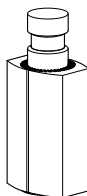

WMS3 [02] x 2
WMS5 [02] x 5

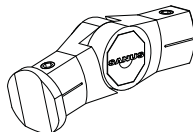

WMS3 [03] x 2
WMS5 [03] x 5

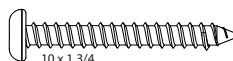

10 x 1 3/4

WMS3 [04] x 4
WMS5 [04] x 10



1/4-20 x 7/8

WMS3 [05] x 2
WMS5 [05] x 5



M5 x 25mm

WMS3 [06] x 2
WMS5 [06] x 5

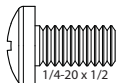

1/4-20 x 1/2

WMS3 [07] x 4
WMS5 [07] x 10



8-32 x 5/8

WMS3 [08] x 2
WMS5 [08] x 5



M4 x 8mm

WMS3 [09] x 2
WMS5 [09] x 5



M5 x 1/8

WMS3 [10] x 2
WMS5 [10] x 5



WMS3 [11] x 2
WMS5 [11] x 5

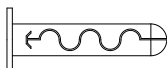

WMS3 [12] x 4
WMS5 [12] x 10

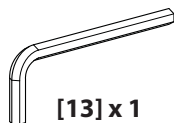

[13] x 1



1

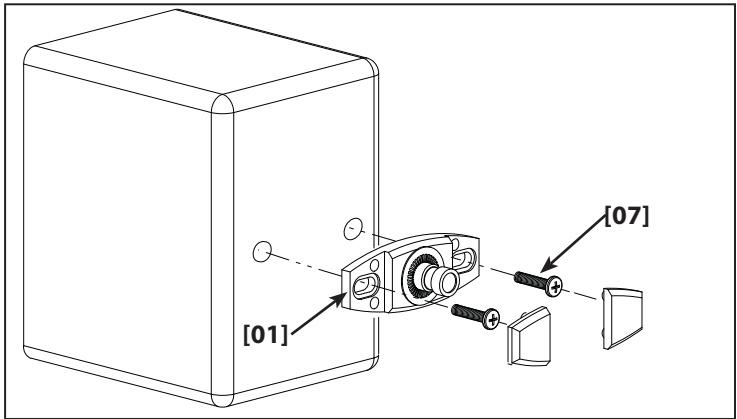
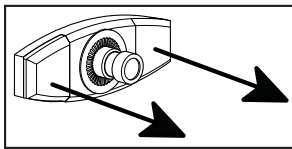

EN 1: Mount the Speaker Plate

ES 1: Montar la placa para parlante

FR 1: Montage de la plaque du haut-parleur

1.1

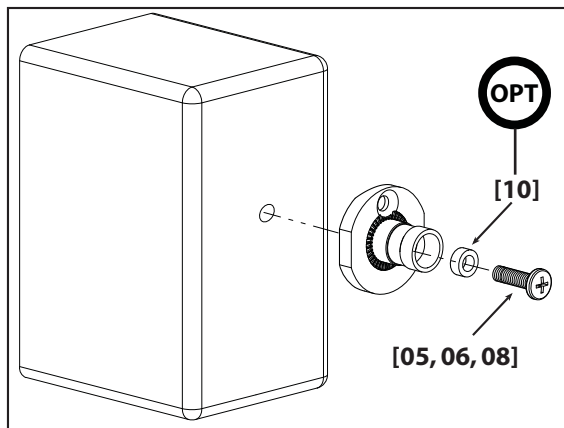
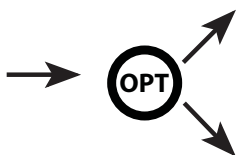
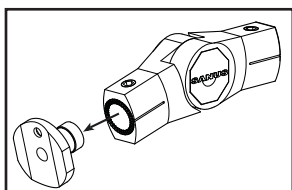

EN 1.1: Mounting to the Satellite Speaker Adapter

NOTE

Bose speakers may require screw [09].

ES 1.1 Montaje en adaptador de parlante satélite

NOTE

Los parlantes Bose podrían requerir un tornillo [09].

FR 1.1 Montage à l'adaptateur du haut-parleur satellite

NOTE

Les haut-parleurs Bose peuvent exiger une vis [09].

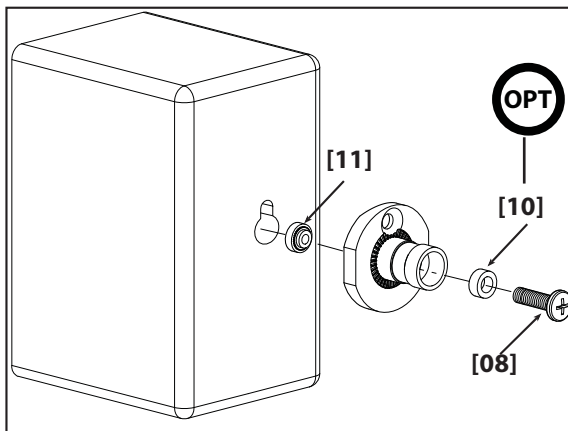

NOTE

Bose speakers may require screw [09].

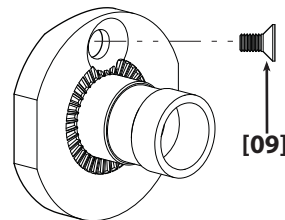

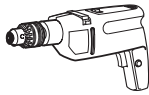

2

EN 2: Mounting to Wood Stud Walls and Ceiling Joists

ES 2: Montaje en paredes con pernos de madera y vigas de cielos rasos

FR 2: Installation sur des murs en montants de bois ou sur des poutrelles de plafond

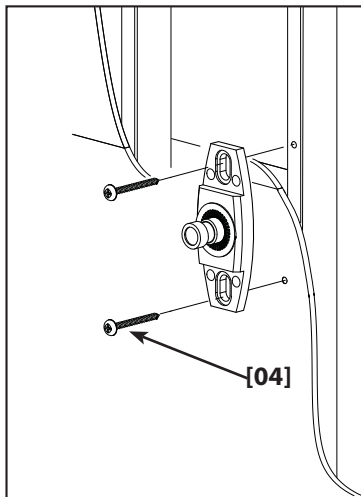
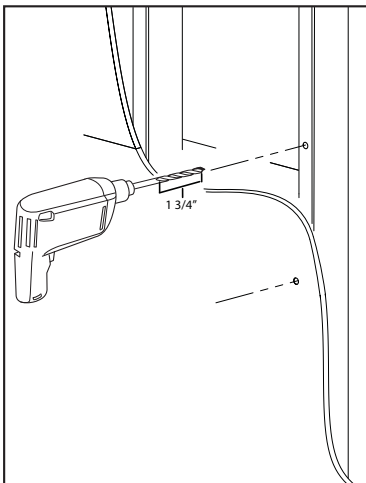
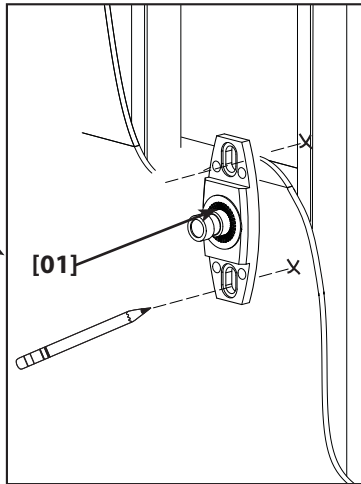
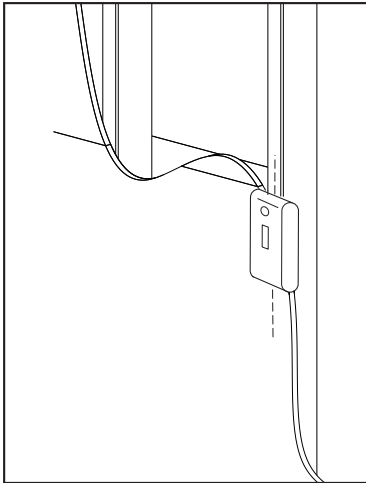
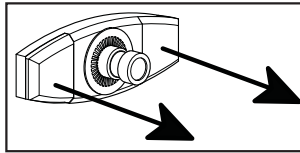

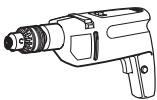

2.1

EN 2.1: Mounting to Poured Concrete or Concrete Block Walls or Ceilings

ES 2.1: Montaje en paredes o techos rasos de concreto vaciado o bloques de concreto

FR 2.1: Installation sur des murs ou des plafonds en béton coulé ou en blocs de béton

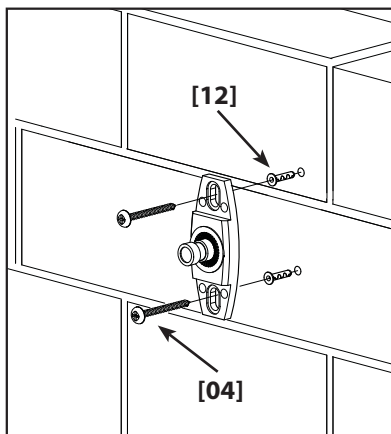
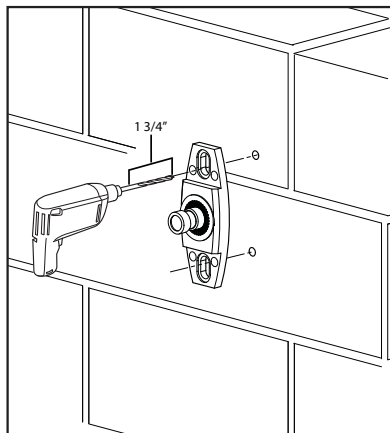
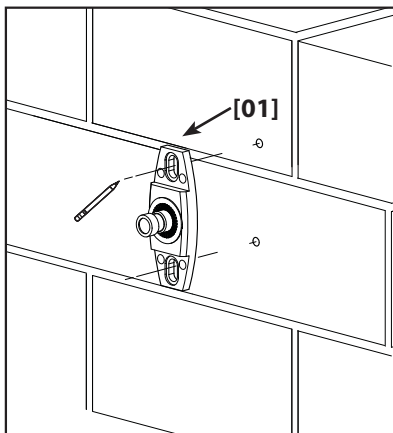
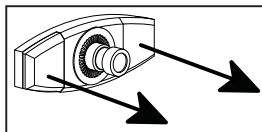

3

EN 3: Install Arm



CAUTION

Do not overtighten. Continuing to tighten the Allen set screw once it is snug will not make the connection stronger.

ES 3: Instalar el brazo



ADVERTENCIA

No ajuste demasiado. Continuar ajustando el tornillo Allen una vez que está bien asegurado NO hará que la conexión sea más fuerte.

FR 3: Installer les bras



ATTENTION

Ne pas trop serrer. Continuer à serrer les vis Allen une fois qu'elles sont bien en place ne rendra pas votre installation plus solide.

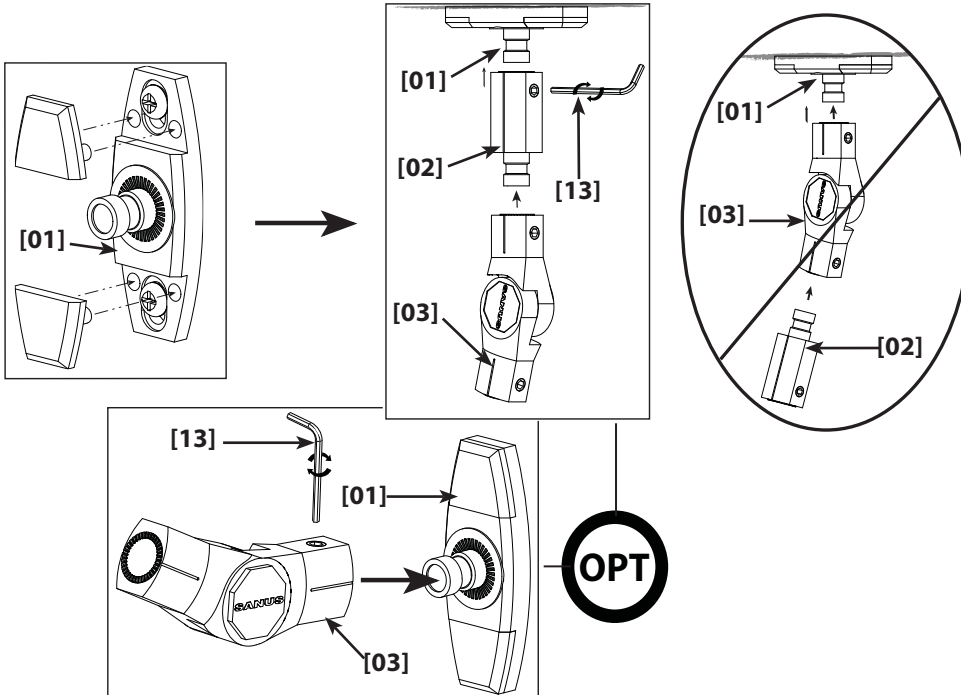

4

EN 4: Attach the Speakers



CAUTION

Do not overtighten. Continuing to tighten the Allen set screw once it is snug will not make the connection stronger.

ES 4: Sujete los parlantes



ADVERTENCIA

No ajuste demasiado. Continuar ajustando el tornillo Allen una vez que está bien asegurado NO hará que la conexión sea más fuerte.

FR 4: Fixation des haut-parleurs



ATTENTION

Ne pas trop serrer. Continuer à serrer les vis Allen une fois qu'elles sont bien en place ne rendra pas votre installation plus solide.

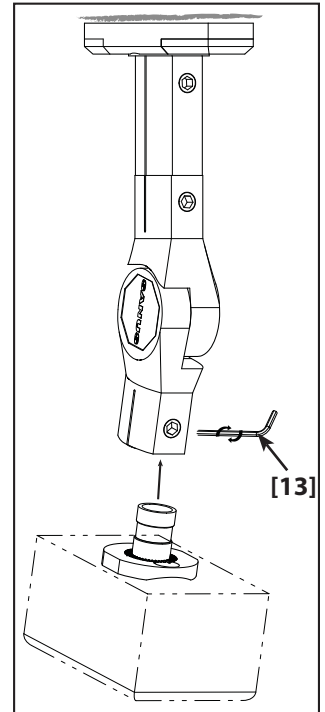
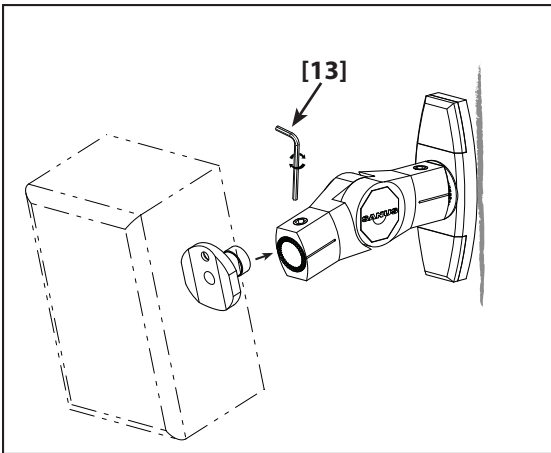

- EN** Milestone AV Technologies and its affiliated corporations and subsidiaries (collectively, "Milestone"), intend to make this manual accurate and complete. However, Milestone makes no claim that the information contained herein covers all details, conditions, or variations. Nor does it provide for every possible contingency in connection with the installation or use of this product. The information contained in this document is subject to change without notice or obligation of any kind. Milestone makes no representation of warranty, expressed or implied, regarding the information contained herein. Milestone assumes no responsibility for accuracy, completeness or sufficiency of the information contained in this document.
- ES** Milestone AV Technologies y sus empresas asociadas y filiales (colectivamente "Milestone") tienen la intención de que este manual sea preciso y completo. Sin embargo, Milestone no sostiene que la información que contiene cubra todos los detalles, condiciones y variaciones. Ni que contemple toda posible contingencia en conexión con la instalación y uso de este producto. La información contenida en este documento es susceptible de ser modificada sin aviso ni obligación de ningún tipo. Milestone no hace ninguna manifestación de garantía, explícita o implícita, respecto a la información contenida en él. Milestone no asume ninguna responsabilidad por la exactitud, integridad o suficiencia de la información contenida en este documento.
- FR** Milestone AV Technologies et ses sociétés affiliées et ses filiales (collectivement dénommées « Milestone »), se sont efforcées de rendre ce manuel précis et complet. Cependant, Milestone ne garantit pas que les informations qu'il contient couvrent tous les détails et toutes les conditions ou variations. Il ne pare pas non plus à toute éventualité relative à l'installation ou à l'utilisation de ce produit. Les informations contenues dans ce document peuvent faire l'objet de modifications sans avertissement ou obligation préalable quelconque. Milestone ne donne aucune garantie explicite ou implicite quant aux informations contenues dans le manuel. Milestone n'assume aucune responsabilité quant à l'exactitude, l'exhaustivité ou la suffisance des informations contenues dans ce document.